

This text is meant purely as a documentation tool and has no legal effect. The Union's institutions do not assume any liability for its contents. The authentic versions of the relevant acts, including their preambles, are those published in the Official Journal of the European Union and available in EUR-Lex. Those official texts are directly accessible through the links embedded in this document

► **B**► **C1** COMMISSION REGULATION (EC) No 440/2008
of 30 May 2008

laying down test methods pursuant to Regulation (EC) No 1907/2006 of the European Parliament and of the Council on the Registration, Evaluation, Authorisation and Restriction of Chemicals (REACH)

(Text with EEA relevance) ◀

(OJ L 142, 31.5.2008, p. 1)

Amended by:

		Official Journal		
		No	page	date
► <u>M1</u>	Commission Regulation (EC) No 761/2009 of 23 July 2009	L 220	1	24.8.2009
► <u>M2</u>	Commission Regulation (EU) No 1152/2010 of 8 December 2010	L 324	13	9.12.2010
► <u>M3</u>	Commission Regulation (EU) No 640/2012 of 6 July 2012	L 193	1	20.7.2012
► <u>M4</u>	Commission Regulation (EU) No 260/2014 of 24 January 2014	L 81	1	19.3.2014
► <u>M5</u>	Commission Regulation (EU) No 900/2014 of 15 July 2014	L 247	1	21.8.2014
► <u>M6</u>	Commission Regulation (EU) 2016/266 of 7 December 2015	L 54	1	1.3.2016
► <u>M7</u>	Commission Regulation (EU) 2017/735 of 14 February 2017	L 112	1	28.4.2017
► <u>M8</u>	Commission Regulation (EU) 2019/1390 of 31 July 2019	L 247	1	26.9.2019

Corrected by:

► **C1** Corrigendum, OJ L 143, 3.6.2008, p. 55 (440/2008)

▼B

▼C1

**COMMISSION REGULATION (EC) No 440/2008
of 30 May 2008**

**laying down test methods pursuant to Regulation (EC)
No 1907/2006 of the European Parliament and of the Council on
the Registration, Evaluation, Authorisation and Restriction of
Chemicals (REACH)**

(Text with EEA relevance)

▼B

Article 1

The test methods to be applied for the purposes of Regulation 1907/2006/EC are set out in the Annex to this Regulation.

Article 2

The Commission shall review, where appropriate, the test methods contained in this Regulation with a view to replacing, reducing or refining testing on vertebrate animals.

Article 3

All references to Annex V to Directive 67/548/EEC shall be construed as references to this Regulation.

Article 4

This Regulation shall enter into force on the day following its publication in the *Official Journal of the European Union*.

It shall apply from 1 June 2008.

▼B

ANNEX

▼M6

Note:

Before using any of the following test methods to test a multi-constituent substance (MCS), a substance of unknown or variable composition, complex reaction product or biological material (UVCB), or a mixture and where its applicability for the testing of MCS, UVCB, or mixtures is not indicated in the respective test method, it should be considered whether the method is adequate for the intended regulatory purpose.

If the test method is used for the testing of a MCS, UVCB or mixture, sufficient information on its composition should be made available, as far as possible, e.g. by the chemical identity of its constituents, their quantitative occurrence, and relevant properties of the constituents.

▼B

**PART A: METHODS FOR THE DETERMINATION OF
PHYSICO-CHEMICAL PROPERTIES**

TABLE OF CONTENTS

- A.1. MELTING/FREEZING TEMPERATURE
- A.2. BOILING TEMPERATURE
- A.3. RELATIVE DENSITY
- A.4. VAPOUR PRESSURE
- A.5. SURFACE TENSION
- A.6. WATER SOLUBILITY
- A.8. PARTITION COEFFICIENT
- A.9. FLASH-POINT
- A.10. FLAMMABILITY (SOLIDS)
- A.11. FLAMMABILITY (GASES)
- A.12. FLAMMABILITY (CONTACT WITH WATER)
- A.13. PYROPHORIC PROPERTIES OF SOLIDS AND LIQUIDS
- A.14. EXPLOSIVE PROPERTIES
- A.15. AUTO-IGNITION TEMPERATURE (LIQUIDS AND GASES)
- A.16. RELATIVE SELF-IGNITION TEMPERATURE FOR SOLIDS
- A.17. OXIDISING PROPERTIES (SOLIDS)
- A.18. NUMBER — AVERAGE MOLECULAR WEIGHT AND MOLECULAR WEIGHT DISTRIBUTION OF POLYMERS
- A.19. LOW MOLECULAR WEIGHT CONTENT OF POLYMERS
- A.20. SOLUTION/EXTRACTION BEHAVIOUR OF POLYMERS IN WATER
- A.21. OXIDISING PROPERTIES (LIQUIDS)
- A.22. LENGTH WEIGHTED GEOMETRIC MEAN DIAMETER OF FIBRES
- A.23. PARTITION COEFFICIENT (1-OCTANOL/WATER): SLOW-STIRRING METHOD
- A.24. PARTITION COEFFICIENT (N-OCTANOL/WATER), HIGH PERFORMANCELIQUID CHROMATOGRAPHY (HPLC) METHOD
- A.25. DISSOCIATION CONSTANTS IN WATER (TITRATION METHOD — SPECTROPHOTOMETRIC METHOD — CONDUCTOMETRIC METHOD)

▼B**A.1. MELTING/FREEZING TEMPERATURE****1. METHOD**

The majority of the methods described are based on the OECD Test Guideline (1). The fundamental principles are given in references (2) and (3).

1.1. INTRODUCTION

The methods and devices described are to be applied for the determination of the melting temperature of substances, without any restriction with respect to their degree of purity.

The selection of the method is dependent on the nature of the substance to be tested. In consequence the limiting factor will be according to, whether or not the substance can be pulverised easily, with difficulty, or not at all.

For some substances, the determination of the freezing or solidification temperature is more appropriate and the standards for these determinations have also been included in this method.

Where, due to the particular properties of the substance, none of the above parameters can be conveniently measured, a pour point may be appropriate.

1.2. DEFINITIONS AND UNITS

The melting temperature is defined as the temperature at which the phase transition from solid to liquid state occurs at atmospheric pressure and this temperature ideally corresponds to the freezing temperature.

As the phase transition of many substances takes place over a temperature range, it is often described as the melting range.

Conversion of units (K to °C)

$$t = T - 273,15$$

t: Celsius temperature, degree Celsius (°C)

T: thermodynamic temperature, kelvin (K)

1.3. REFERENCE SUBSTANCES

Reference substances do not need to be employed in all cases when investigating a new substance. They should primarily serve to check the performance of the method from time to time and to allow comparison with results from other methods.

Some calibration substances are listed in the references (4).

▼ B

1.4. PRINCIPLE OF THE TEST METHOD

The temperature (temperature range) of the phase transition from the solid to the liquid state or from the liquid to the solid state is determined. In practice while heating/cooling a sample of the test substance at atmospheric pressure the temperatures of the initial melting/freezing and the final stage of melting/freezing are determined. Five types of methods are described, namely capillary method, hot stage methods, freezing temperature determinations, methods of thermal analysis, and determination of the pour point (as developed for petroleum oils).

In certain cases, it may be convenient to measure the freezing temperature in place of the melting temperature.

1.4.1. **Capillary method**1.4.1.1. *Melting temperature devices with liquid bath*

A small amount of the finely ground substance is placed in a capillary tube and packed tightly. The tube is heated, together with a thermometer, and the temperature rise is adjusted to less than about 1 K/min during the actual melting. The initial and final melting temperatures are determined.

1.4.1.2. *Melting temperature devices with metal block*

As described under 1.4.1.1, except that the capillary tube and the thermometer are situated in a heated metal block, and can be observed through holes in the block.

1.4.1.3. *Photocell detection*

The sample in the capillary tube is heated automatically in a metal cylinder. A beam of light is directed through the substance, by way of a hole in the cylinder, to a precisely calibrated photocell. The optical properties of most substances change from opaque to transparent when they are melting. The intensity of light reaching the photocell increases and sends a stop signal to the digital indicator reading out the temperature of a platinum resistance thermometer located in the heating chamber. This method is not suitable for some highly coloured substances.

1.4.2. **Hot stages**1.4.2.1. *Kofler hot bar*

The Kofler hot bar uses two pieces of metal of different thermal conductivity, heated electrically, with the bar designed so that the temperature gradient is almost linear along its length. The temperature of the hot bar can range from 283 to 573 K with a special temperature-reading device including a runner with a pointer and tab designed for the specific bar. In order to determine a melting temperature, the substance is laid, in a thin layer, directly on the surface of the hot bar. In a few seconds a sharp dividing line between the fluid and solid phase develops. The temperature at the dividing line is read by adjusting the pointer to rest at the line.

▼ B1.4.2.2. *Melt microscope*

Several microscope hot stages are in use for the determination of melting temperatures with very small quantities of material. In most of the hot stages the temperature is measured with a sensitive thermocouple but sometimes mercury thermometers are used. A typical microscope hot stage melting temperature apparatus has a heating chamber which contains a metal plate upon which the sample is placed on a slide. The centre of the metal plate contains a hole permitting the entrance of light from the illuminating mirror of the microscope. When in use, the chamber is closed by a glass plate to exclude air from the sample area.

The heating of the sample is regulated by a rheostat. For very precise measurements on optically anisotropic substances, polarised light may be used.

1.4.2.3. *Meniscus method*

This method is specifically used for polyamides.

The temperature at which the displacement of a meniscus of silicone oil, enclosed between a hot stage and a cover-glass supported by the polyamide test specimen, is determined visually.

1.4.3. **Method to determine the freezing temperature**

The sample is placed in a special test tube and placed in an apparatus for the determination of the freezing temperature. The sample is stirred gently and continuously during cooling and the temperature is measured at suitable intervals. As soon as the temperature remains constant for a few readings this temperature (corrected for thermometer error) is recorded as the freezing temperature.

Supercooling must be avoided by maintaining equilibrium between the solid and the liquid phases.

1.4.4. **Thermal analysis**1.4.4.1 *Differential thermal analysis (DTA)*

This technique records the difference in temperatures between the substance and a reference material as a function of temperature, while the substance and reference material are subjected to the same controlled temperature programme. When the sample undergoes a transition involving a change of enthalpy, that change is indicated by an endothermic (melting) or exothermic (freezing) departure from the base line of the temperature record.

▼ B1.4.4.2 *Differential scanning calorimetry (DSC)*

This technique records the difference in energy inputs into a substance and a reference material, as a function of temperature, while the substance and reference material are subjected to the same controlled temperature programme. This energy is the energy necessary to establish zero temperature difference between the substance and the reference material. When the sample undergoes a transition involving a change of enthalpy, that change is indicated by an endothermic (melting) or exothermic (freezing) departure from the base line of the heat flow record.

1.4.5. **Pour point**

This method was developed for use with petroleum oils and is suitable for use with oily substances with low melting temperatures.

After preliminary heating, the sample is cooled at a specific rate and examined at intervals of 3 K for flow characteristics. The lowest temperature at which movement of the substance is observed is recorded as the pour point.

1.5. QUALITY CRITERIA

The applicability and accuracy of the different methods used for the determination of the melting temperature/melting range are listed in the following table:

TABLE: APPLICABILITY OF THE METHODS

A. **Capillary methods**

Method of measurement	Substances which can be pulverised	Substances which are not readily pulverised	Temperature range	Estimated accuracy ⁽¹⁾	Existing standards
Melting temperature devices with liquid bath	yes	only to a few	273 to 573 K	± 0,3 K	JIS K 0064
Melting temperature with metal block	yes	only to a few	293 to > 573 K	± 0,5 K	ISO 1218 (E)
Photocell detection	yes	several with appliance devices	253 to 573 K	± 0,5 K	

⁽¹⁾ Dependent on type of instrument and on degree of purity of the substance.

▼ **B****B. Hot stages and freezing methods**

Method of measurement	Substances which can be pulverised	Substances which are not readily pulverised	Temperature range	Estimated accuracy ⁽¹⁾	Existing standards
Kofler hot bar	yes	no	283 to > 573 K	± 1K	ANSI/ASTM D 3451-76
Melt microscope	yes	only to a few	273 to > 573 K	± 0,5 K	DIN 53736
Meniscus method	no	specifically for polyamides	293 to > 573 K	± 0,5 K	ISO 1218 (E)
Freezing temperature	yes	yes	223 to 573 K	± 0,5 K	e.g. BS 4695

⁽¹⁾ Dependent on type of instrument and on degree of purity of the substance

C. Thermal analysis

Method of measurement	Substances which can be pulverised	Substances which are not readily pulverised	Temperature range	Estimated accuracy ⁽¹⁾	Existing standards
Differential thermal analysis	yes	yes	173 to 1 273 K	up to 600 K ± 0,5 K up to 1 273 K ± 2,0 K	ASTM E 537-76
Differential scanning calorimetry	yes	yes	173 to 1 273 K	up to 600 K ± 0,5 K up to 1 273 K ± 2,0 K	ASTM E 537-76

⁽¹⁾ Dependent on type of instrument and on degree of purity of the substance

D. Pour point

Method of measurement	Substances which can be pulverised	Substances which are not readily pulverised	Temperature range	Estimated accuracy ⁽¹⁾	Existing standards
Pour point	for petroleum oils and oily substances	for petroleum oils and oily substances	223 to 323 K	± 0,3 K	ASTM D 97-66

⁽¹⁾ Dependent on type of instrument and on degree of purity of the substance

1.6. DESCRIPTION OF THE METHODS

The procedures of nearly all the test methods have been described in international and national standards (see Appendix 1).

1.6.1. **Methods with capillary tube**

When subjected to a slow temperature rise, finely pulverised substances usually show the stages of melting shown in figure 1.

▼ B

Figure 1

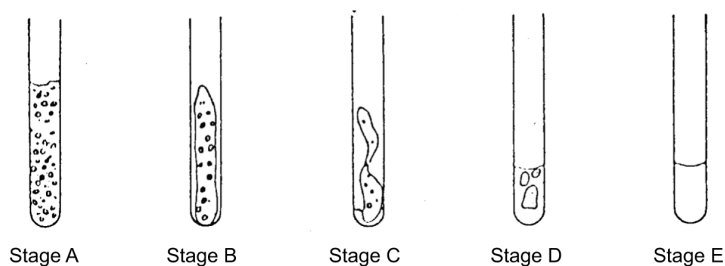

- Stage A (beginning of melting): fine droplets adhere uniformly to the inside wall of the capillary tube
- Stage B a clearance appears between the sample and the inside wall due to shrinkage of the melt
- Stage C the shrunken sample begins to collapse downwards and liquefies
- Stage D a complete meniscus is formed at the surface but an appreciable amount of the sample remains solid
- Stage E (final stage melting): there are no solid particles

During the determination of the melting temperature, the temperatures are recorded at the beginning of the melting and at the final stage.

1.6.1.1. Melting temperature devices with liquid bath apparatus

Figure 2 shows a type of standardised melting temperature apparatus made of glass (JIS K 0064); all specifications are in millimeters.

Figure 2

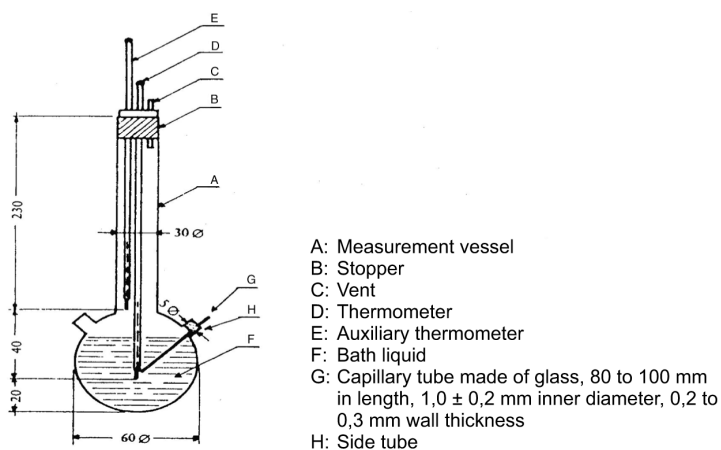

▼ B*Bath liquid:*

A suitable liquid should be chosen. The choice of the liquid depends upon the melting temperature to be determined, e.g. liquid paraffin for melting temperatures no higher than 473 K, silicone oil for melting temperatures no higher than 573 K.

For melting temperatures above 523 K, a mixture consisting of three parts sulphuric acid and two parts potassium sulphate (in mass ratio) can be used. Suitable precautions should be taken if a mixture such as this is used.

Thermometer:

Only those thermometers should be used which fulfil the requirements of the following or equivalent standards:

ASTM E 1-71, DIN 12770, JIS K 8001.

Procedure:

The dry substance is finely pulverised in a mortar and is put into the capillary tube, fused at one end, so that the filling level is approximately 3 mm after being tightly packed. To obtain a uniform packed sample, the capillary tube should be dropped from a height of approximately 700 mm through a glass tube vertically onto a watch glass.

The filled capillary tube is placed in the bath so that the middle part of the mercury bulb of the thermometer touches the capillary tube at the part where the sample is located. Usually the capillary tube is introduced into the apparatus about 10 K below the melting temperature.

The bath liquid is heated so that the temperature rise is approximately 3 K/min. The liquid should be stirred. At about 10 K below the expected melting temperature the rate of temperature rise is adjusted to a maximum of 1 K/min.

Calculation:

The calculation of the melting temperature is as follows:

$$T = T_D + 0,00016 (T_D - T_E) n$$

where:

T = corrected melting temperature in K

T_D = temperature reading of thermometer D in K

T_E = temperature reading of thermometer E in K

n = number of graduations of mercury thread on thermometer D at emergent stem.

1.6.1.2. *Melting temperature devices with metal block**Apparatus:*

This consists of:

- a cylindrical metal block, the upper part of which is hollow and forms a chamber (see figure 3),
- a metal plug, with two or more holes, allowing tubes to be mounted into the metal block,

▼B

- a heating system, for the metal block, provided for example by an electrical resistance enclosed in the block,
- a rheostat for regulation of power input, if electric heating is used,
- four windows of heat-resistant glass on the lateral walls of the chamber, diametrically disposed at right-angles to each other. In front of one of these windows is mounted an eye-piece for observing the capillary tube. The other three windows are used for illuminating the inside of the enclosure by means of lamps,
- a capillary tube of heat-resistant glass closed at one end (see 1.6.1.1).

Thermometer:

See standards mentioned in 1.6.1.1. Thermoelectrical measuring devices with comparable accuracy are also applicable.

Figure 3

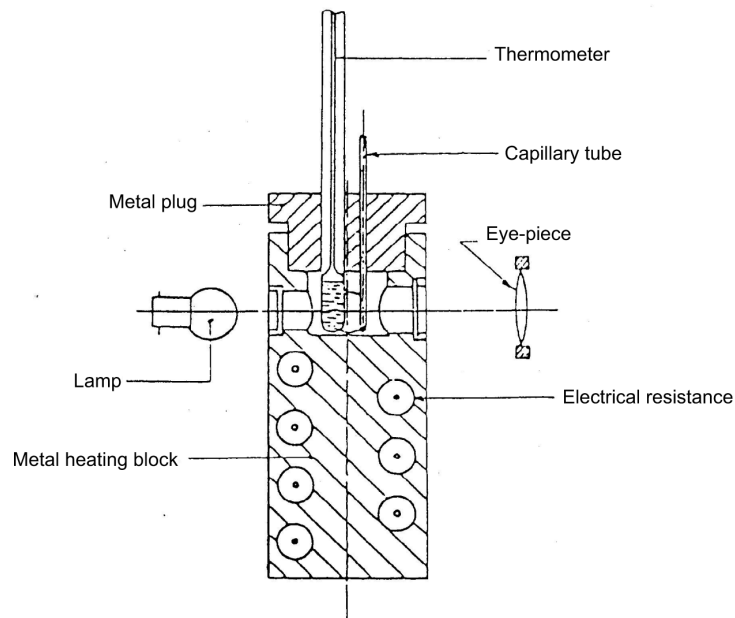
1.6.1.3. *Photocell detection**Apparatus and procedure:*

The apparatus consists of a metal chamber with automated heating system. Three capillary are filled accordingly to 1.6.1.1 and placed in the oven.

▼ B

Several linear increases of temperature are available for calibrating the apparatus and the suitable temperature rise is electrically adjusted at a pre-selected constant and linear rate. recorders show the actual oven temperature and the temperature of the substance in the capillary tubes.

1.6.2. Hot stages1.6.2.1. *Kofler hot bar*

See Appendix.

1.6.2.2. *Melt microscope*

See Appendix.

1.6.2.3. *Meniscus method (polyamides)*

See Appendix.

The heating rate through the melting temperature should be less than 1 K/min.

1.6.3. Methods for the determination of the freezing temperature

See Appendix.

1.6.4. Thermal analysis1.6.4.1. *Differential thermal analysis*

See Appendix.

1.6.4.2. *Differential scanning calorimetry*

See Appendix.

1.6.5. Determination of the pour point

See Appendix.

2. DATA

A thermometer correction is necessary in some cases.

3. REPORTING

The test report shall, if possible, include the following information:

— method used,

— precise specification of the substance (identity and impurities) and preliminary purification step, if any,

— an estimate of the accuracy.

The mean of at least two measurements which are in the range of the estimated accuracy (see tables) is reported as the melting temperature.

▼B

If the difference between the temperature at the beginning and at the final stage of melting is within the limits of the accuracy of the method, the temperature at the final stage of melting is taken as the melting temperature; otherwise the two temperatures are reported.

If the substance decomposes or sublimates before the melting temperature is reached, the temperature at which the effect is observed shall be reported.

All information and remarks relevant for the interpretation of results have to be reported, especially with regard to impurities and physical state of the substance.

4. REFERENCES

- (1) OECD, Paris, 1981, Test Guideline 102, Decision of the Council C(81) 30 final.
- (2) IUPAC, B. Le Neindre, B. Vodar, eds. Experimental thermodynamics, Butterworths, London 1975, vol. II, p. 803-834.
- (3) R. Weissberger ed.: Technique of organic Chemistry, Physical Methods of Organic Chemistry, 3rd ed., Interscience Publ., New York, 1959, vol. I, Part I, Chapter VII.
- (4) IUPAC, Physicochemical measurements: Catalogue of reference materials from national laboratories, Pure and applied chemistry, 1976, vol. 48, p. 505-515.

▼ B*Appendix*

For additional technical details, the following standards may be consulted for example.

1. **Capillary methods**

1.1. Melting temperature devices with liquid bath

ASTM E 324-69 Standard test method for relative initial and final melting points and the melting range of organic chemicals

BS 4634 Method for the determination of melting point and/or melting range

DIN 53181 Bestimmung des Schmelzintervalles von Harzen nach Kapillarverfahren

JIS K 00-64 Testing methods for melting point of chemical products

1.2. Melting temperature devices with metal block

DIN 53736 Visuelle Bestimmung der Schmelztemperatur von teilkristallinen Kunststoffen

ISO 1218 (E) Plastics — polyamides — determination of ‘melting point’

2. **Hot stages**

2.1. Kofler hot bar

ANSI/ASTM D 3451-76 Standard recommended practices for testing polymeric powder coatings

2.2. Melt microscope

DIN 53736 Visuelle Bestimmung der Schmelztemperatur von teilkristallinen Kunststoffen

2.3. Meniscus method (polyamides)

ISO 1218 (E) Plastics — polyamides — determination of ‘melting point’

▼B

ANSI/ASTM D 2133-66 Standard specification for acetal resin injection moulding and extrusion materials

NF T 51-050 Résines de polyamides. Détermination du 'point de fusion' méthode du ménisque

3. **Methods for the determination of the freezing temperature**

BS 4633 Method for the determination of crystallising point

BS 4695 Method for Determination of Melting Point of petroleum wax (Cooling Curve)

DIN 51421 Bestimmung des Gefrierpunktes von Flugkraftstoffen, Ottokraftstoffen und Motorenbenzolen

ISO 2207 Cires de pétrole: détermination de la température de figéage

DIN 53175 Bestimmung des Erstarrungspunktes von Fettsäuren

NF T 60-114 Point de fusion des paraffines

NF T 20-051 Méthode de détermination du point de cristallisation (point de congélation)

ISO 1392 Method for the determination of the freezing point

4. **Thermal analysis**

4.1. Differential thermal analysis

ASTM E 537-76 Standard method for assessing the thermal stability of chemicals by methods of differential thermal analysis

ASTM E 473-85 Standard definitions of terms relating to thermal analysis

▼B

	ASTM E 472-86	Standard practice for reporting thermoanalytical data
	DIN 51005	Thermische Analyse, Begriffe
4.2.	Differential scanning calorimetry	
	ASTM E 537-76	Standard method for assessing the thermal stability of chemicals by methods of differential thermal analysis
	ASTM E 473-85	Standard definitions of terms relating to thermal analysis
	ASTM E 472-86	Standard practice for reporting thermoanalytical data
	DIN 51005	Thermische Analyse, Begriffe
5.	Determination of the pour point	
	NBN 52014	Echantillonnage et analyse des produits du pétrole: Point de trouble et point d'écoulement limite — Monsterneming en ontleding van aardolieproducten: Troebelingspunt en vloeipunt
	ASTM D 97-66	Standard test method for pour point of petroleum oils
	ISO 3016	Petroleum oils — Determination of pour point

▼ B**A.2. BOILING TEMPERATURE****1. METHOD**

The majority of the methods described are based on the OECD Test Guideline (1). The fundamental principles are given in references (2) and (3).

1.1. INTRODUCTION

The methods and devices described here can be applied to liquid and low melting substances, provided that these do not undergo chemical reaction below the boiling temperature (for example: auto-oxidation, rearrangement, degradation, etc.). The methods can be applied to pure and to impure liquid substances.

Emphasis is put on the methods using photocell detection and thermal analysis, because these methods allow the determination of melting as well as boiling temperatures. Moreover, measurements can be performed automatically.

The 'dynamic method' has the advantage that it can also be applied to the determination of the vapour pressure and it is not necessary to correct the boiling temperature to the normal pressure (101,325 kPa) because the normal pressure can be adjusted during the measurement by a manostat.

Remarks:

The influence of impurities on the determination of the boiling temperature depends greatly upon the nature of the impurity. When there are volatile impurities in the sample, which could affect the results, the substance may be purified.

1.2. DEFINITIONS AND UNITS

The normal boiling temperature is defined as the temperature at which the vapour pressure of a liquid is 101,325 kPa.

If the boiling temperature is not measured at normal atmospheric pressure, the temperature dependence of the vapour pressure can be described by the Clausius-Clapeyron equation:

$$\log p = \frac{\Delta H_v}{2,3RT} + \text{const.}$$

where:

p = the vapour pressure of the substance in pascals

ΔH_v = its heat of vaporisation in J mol⁻¹

R = the universal molar gas constant = 8,314 J mol⁻¹ K⁻¹

T = thermodynamic temperature in K

The boiling temperature is stated with regard to the ambient pressure during the measurement.

▼ B*Conversions*

Pressure (units: kPa)

100 kPa = 1 bar = 0,1 MPa

(‘bar’ is still permissible but not recommended)

133 Pa = 1 mm Hg = 1 Torr

(the units ‘mm Hg’ and ‘Torr’ are not permitted)

1 atm = standard atmosphere = 101 325 Pa

(the unit ‘atm’ is not permitted)

Temperature (units: K)

$t = T - 273,15$

t: Celsius temperature, degree Celsius (°C)

T: thermodynamic temperature, kelvin (K)

1.3. REFERENCE SUBSTANCES

Reference substances do not need to be employed in all cases when investigating a new substance. They should primarily serve to check the performance of the method from time to time and to allow comparison with results from other methods.

Some calibration substances can be found in the methods listed in the Appendix.

1.4. PRINCIPLE OF THE TEST METHOD

Five methods for the determination of the boiling temperature (boiling range) are based on the measurement of the boiling temperature, two others are based on thermal analysis.

1.4.1. **Determination by use of the ebulliometer**

Ebullimeters were originally developed for the determination of the molecular weight by boiling temperature elevation, but they are also suited for exact boiling temperature measurements. A very simple apparatus is described in ASTM D 1120-72 (see Appendix). The liquid is heated in this apparatus under equilibrium conditions at atmospheric pressure until it is boiling.

1.4.2. **Dynamic method**

This method involves the measurement of the vapour recondensation temperature by means of an appropriate thermometer in the reflux while boiling. The pressure can be varied in this method.

1.4.3. **Distillation method for boiling temperature**

This method involves distillation of the liquid and measurement of the vapour recondensation temperature and determination of the amount of distillate.

▼B**1.4.4. Method according to Siwoloboff**

A sample is heated in a sample tube, which is immersed in a liquid in a heat-bath. A fused capillary, containing an air bubble in the lower part, is dipped in the sample tube.

1.4.5. Photocell detection

Following the principle according to Siwoloboff, automatic photo-electrical measurement is made using rising bubbles.

1.4.6. Differential thermal analysis

This technique records the difference in temperatures between the substance and a reference material as a function of temperature, while the substance and reference material are subjected to the same controlled temperature programme. When the sample undergoes a transition involving a change of enthalpy, that change is indicated by an endothermic departure (boiling) from the base line of the temperature record.

1.4.7. Differential scanning calorimetry

This technique records the difference in energy inputs into a substance and a reference material as a function of temperature, while the substance and reference material are subjected to the same controlled temperature programme. This energy is the energy necessary to establish zero temperature difference between the substance and the reference material. When the sample undergoes a transition involving a change of enthalpy, that change is indicated by an endothermic departure (boiling) from the base line of the heat flow record.

1.5. QUALITY CRITERIA

The applicability and accuracy of the different methods used for the determination of the boiling temperature/boiling range are listed in table 1.

Table 1:

Comparison of the methods

Method of measurement	Estimated accuracy	Existing standard
Ebulliometer	± 1,4 K (up to 373 K) ⁽¹⁾ ⁽²⁾ ± 2,5 K (up to 600 K) ⁽¹⁾ ⁽²⁾	ASTM D 1120-72 ⁽¹⁾
Dynamic method	± 0,5 K (up to 600 K) ⁽²⁾	
Distillation process (boiling range)	± 0,5 K (up to 600 K)	ISO/R 918, DIN 53171, BS 4591/71
According to Siwoloboff	± 2 K (up to 600 K) ⁽²⁾	
Photocell detection	± 0,3 K (up to 373 K) ⁽²⁾	
Differential thermal calorimetry	± 0,5 K (up to 600 K) ± 2,0 K (up to 1 273 K)	ASTM E 537-76
Differential scanning calorimetry	± 0,5 K (up to 600 K) ± 2,0 K (up to 1 273 K)	ASTM E 537-76

⁽¹⁾ This accuracy is only valid for the simple device as for example described in ASTM D 1120-72; it can be improved with more sophisticated ebulliometer devices.

⁽²⁾ Only valid for pure substances. The use in other circumstances should be justified.

▼ B

1.6. DESCRIPTION OF THE METHODS

The procedures of some test methods have been described in international and national standards (see Appendix).

1.6.1. **Ebulliometer**

See Appendix.

1.6.2. **Dynamic method**

See test method A.4 for the determination of the vapour pressure.

The boiling temperature observed with an applied pressure of 101,325 kPa is recorded.

1.6.3. **Distillation process (boiling range)**

See Appendix.

1.6.4. **Method according to Sivoloboff**

The sample is heated in a melting temperature apparatus in a sample tube, with a diameter of approximately 5 mm (figure 1).

Figure 1 shows a type of standardised melting and boiling temperature apparatus (JIS K 0064) (made of glass, all specifications in millimetres).

Figure 1

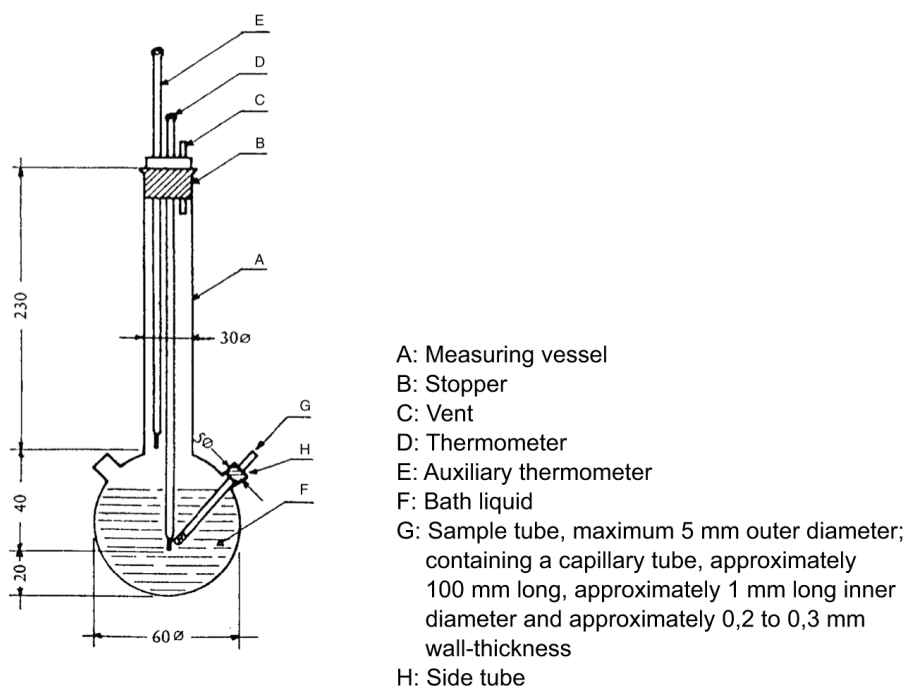

A capillary tube (boiling capillary) which is fused about 1 cm above the lower end is placed in the sample tube. The level to which the test substance is added is such that the fused section of the capillary is below the surface of the liquid. The sample tube containing the boiling capillary is fastened either to the thermometer with a rubber band or is fixed with a support from the side (see figure 2).

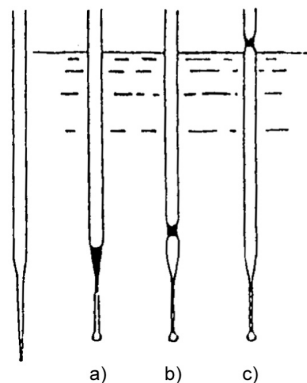
▼ B*Figure 2***Principle according to Siwoloboff***Figure 3***Modified principle**

The bath liquid is chosen according to boiling temperature. At temperatures up to 573 K, silicone oil can be used. Liquid paraffin may only be used up to 473 K. The heating of the bath liquid should be adjusted to a temperature rise of 3 K/min at first. The bath liquid must be stirred. At about 10 K below the expected boiling temperature, the heating is reduced so that the rate of temperature rise is less than 1 K/min. Upon approach of the boiling temperature, bubbles begin to emerge rapidly from the boiling capillary.

The boiling temperature is that temperature when, on momentary cooling, the string of bubbles stops and fluid suddenly starts rising in the capillary. The corresponding thermometer reading is the boiling temperature of the substance.

In the modified principle (figure 3) the boiling temperature is determined in a melting temperature capillary. It is stretched to a fine point about 2 cm in length (a) and a small amount of the sample is sucked up. The open end of the fine capillary is closed by melting, so that a small air bubble is located at the end. While heating in the melting temperature apparatus (b), the air bubble expands. The boiling temperature corresponds to the temperature at which the substance plug reaches the level of the surface of the bath liquid (c).

1.6.5. Photocell detection

The sample is heated in a capillary tube inside a heated metal block.

A light beam is directed, via suitable holes in the block, through the substance onto a precisely calibrated photocell.

During the increase of the sample temperature, single air bubbles emerge from the boiling capillary. When the boiling temperature is reached the number of bubbles increases greatly. This causes a change in the intensity of light, recorded by a photocell, and gives a stop signal to the indicator reading out the temperature of a platinum resistance thermometer located in the block.

This method is especially useful because it allows determinations below room temperature down to 253,15 K (– 20 °C) without any changes in the apparatus. The instrument merely has to be placed in a cooling bath.

▼ B1.6.6. **Thermal analysis**1.6.6.1. *Differential thermal analysis*

See Appendix.

1.6.6.2. *Differential scanning calorimetry*

See Appendix.

2. **DATA**

At small deviations from the normal pressure (max. ± 5 kPa) the boiling temperatures are normalised to T_n by means of the following number-value equation by Sidney Young:

$$T_n = T + (f_T \times \Delta p)$$

where:

$$\Delta p = (101,325 - p) \text{ [note sign]}$$

P = pressure measurement in kPa

f_T = rate of change of boiling temperature with pressure in K/kPa

T = measured boiling temperature in K

T_n = boiling temperature corrected to normal pressure in K

The temperature-correction factors, f_T , and equations for their approximation are included in the international and national standards mentioned above for many substances.

For example, the DIN 53171 method mentions the following rough corrections for solvents included in paints:

Table 2:

Temperature — corrections factors f_T

Temperature T (K)	Correction factor f_T (K/kPa)
323,15	0,26
348,15	0,28
373,15	0,31
398,15	0,33
423,15	0,35
448,15	0,37
473,15	0,39
498,15	0,41
523,15	0,4
548,15	0,45
573,15	0,47

▼B**3. REPORTING**

The test report shall, if possible, include the following information:

- method used,
- precise specification of the substance (identity and impurities) and preliminary purification step, if any,
- an estimate of the accuracy.

The mean of at least two measurements which are in the range of the estimated accuracy (see table 1) is reported as the boiling temperature.

The measured boiling temperatures and their mean shall be stated and the pressure(s) at which the measurements were made shall be reported in kPa. The pressure should preferably be close to normal atmospheric pressure.

All information and remarks relevant for the interpretation of results have to be reported, especially with regard to impurities and physical state of the substance.

4. REFERENCES

- (1) OECD, Paris, 1981, Test Guideline 103, Decision of the Council C (81) 30 final.
- (2) IUPAC, B. Le Neindre, B. Vodar, editions. Experimental thermodynamics, Butterworths, London, 1975, vol. II.
- (3) R. Weissberger edition: Technique of organic chemistry, Physical methods of organic chemistry, Third Edition, Interscience Publications, New York, 1959, vol. I, Part I, Chapter VIII.

▼ B*Appendix*

For additional technical details, the following standards may be consulted for example.

1. **Ebulliometer**
 - 1.1. Melting temperature devices with liquid bath

ASTM D 1120-72	Standard test method for boiling point of engine anti-freezes
----------------	---

2. **Distillation process (boiling range)**

ISO/R 918	Test Method for Distillation (Distillation Yield and Distillation Range)
BS 4349/68	Method for determination of distillation of petroleum products
BS 4591/71	Method for the determination of distillation characteristics
DIN 53171	Losungsmittel für Anstrichstoffe, Bestimmung des Siedeverlaufes
NF T 20-608	Distillation: détermination du rendement et de l'intervalle de distillation

3. **Differential thermal analysis and differential scanning calorimetry**

ASTM E 537-76	Standard method for assessing the thermal stability of chemicals by methods of differential thermal analysis
ASTM E 473-85	Standard definitions of terms relating to thermal analysis
ASTM E 472-86	Standard practice for reporting thermoanalytical data
DIN 51005	Thermische Analyse, Begriffe

▼B**A.3. RELATIVE DENSITY****1. METHOD**

The methods described are based on the OECD Test Guideline (1). The fundamental principles are given in reference (2).

1.1. INTRODUCTION

The methods for determining relative density described are applicable to solid and to liquid substances, without any restriction in respect to their degree of purity. The various methods to be used are listed in table 1.

1.2. DEFINITIONS AND UNITS

The relative density D_4^{20} of solids or liquids is the ratio between the mass of a volume of substance to be examined, determined at 20 °C, and the mass of the same volume of water, determined at 4 °C. The relative density has no dimension.

The density, ρ , of a substance is the quotient of the mass, m , and its volume, v .

The density, ρ , is given, in SI units, in kg/m^3 .

1.3. REFERENCE SUBSTANCES (1) (3)

Reference substances do not need to be employed in all cases when investigating a new substance. They should primarily serve to check the performance of the method from time to time and to allow comparison with results from other methods.

1.4. PRINCIPLE OF THE METHODS

Four classes of methods are used.

1.4.1. Buoyancy methods**1.4.1.1. Hydrometer (for liquid substances)**

Sufficiently accurate and quick determinations of density may be obtained by the floating hydrometers, which allow the density of a liquid to be deduced from the depth of immersion by reading a graduated scale.

1.4.1.2. Hydrostatic balance (for liquid and solid substances)

The difference between the weight of a test sample measured in air and in a suitable liquid (e.g. water) can be employed to determine its density.

For solids, the measured density is only representative of the particular sample employed. For the determination of density of liquids, a body of known volume, v , is weighed first in air and then in the liquid.

1.4.1.3. Immersed body method (for liquid substances) (4)

In this method, the density of a liquid is determined from the difference between the results of weighing the liquid before and after immersing a body of known volume in the test liquid.

▼B**1.4.2. Pycnometer methods**

For solids or liquids, pycnometers of various shapes and with known volumes may be employed. The density is calculated from the difference in weight between the full and empty pycnometer and its known volume.

1.4.3. Air comparison pycnometer (for solids)

The density of a solid in any form can be measured at room temperature with the gas comparison pycnometer. The volume of a substance is measured in air or in an inert gas in a cylinder of variable calibrated volume. For the calculation of density one mass measurement is taken after concluding the volume measurement.

1.4.4. Oscillating densitometer (5) (6) (7)

The density of a liquid can be measured by an oscillating densitometer. A mechanical oscillator constructed in the form of a U-tube is vibrated at the resonance frequency of the oscillator which depends on its mass. Introducing a sample changes the resonance frequency of the oscillator. The apparatus has to be calibrated by two liquid substances of known densities. These substances should preferably be chosen such that their densities span the range to be measured.

1.5. QUALITY CRITERIA

The applicability of the different methods used for the determination of the relative density is listed in the table.

1.6. DESCRIPTION OF THE METHODS

The standards given as examples, which are to be consulted for additional technical details, are attached in the Appendix.

The tests have to be run at 20 °C, and at least two measurements performed.

2. DATA

See standards.

3. REPORTING

The test report shall, if possible, include the following information:

— method used,

— precise specification of the substance (identity and impurities) and preliminary purification step, if any.

The relative density, D_4^{20} , shall be reported as defined in 1.2, along with the physical state of the measured substance.

All information and remarks relevant for the interpretation of results have to be reported, especially with regard to impurities and physical state of the substance.



Table:

Applicability of methods

Method of measurement	Density		Maximum possible dynamic viscosity	Existing Standards
	solid	liquid		
1.4.1.1. Hydrometer		yes	5 Pa s	ISO 387, ISO 649-2, NF T 20-050
1.4.1.2. Hydrostatic balance				
(a) solids	yes			ISO 1183 (A)
(b) liquids		yes	5 Pa s	ISO 901 and 758
1.4.1.3. Immersed body method		yes	20 Pa s	DIN 53217
1.4.2. Pycnometer				ISO 3507
(a) solids	yes			ISO 1183(B), NF T 20-053
(b) liquids		yes	500 Pa s	ISO 758
1.4.3. Air comparison pycnometer	yes			DIN 55990 Teil 3, DIN 53243
1.4.4. Oscillating densitimer		yes	5 Pa s	

4. REFERENCES

- (1) OECD, Paris, 1981, Test Guideline 109, Decision of the Council C(81) 30 final.
- (2) R. Weissberger ed., Technique of Organic Chemistry, Physical Methods of Organic Chemistry, 3rd ed., Chapter IV, Interscience Publ., New York, 1959, vol. I, Part 1.
- (3) IUPAC, Recommended reference materials for realization of physico-chemical properties, Pure and applied chemistry, 1976, vol. 48, p. 508.
- (4) Wagenbreth, H., Die Tauchkugel zur Bestimmung der Dichte von Flüssigkeiten, Technisches Messen tm, 1979, vol. II, p. 427-430.
- (5) Leopold, H., Die digitale Messung von Flüssigkeiten, Elektronik, 1970, vol. 19, p. 297-302.
- (6) Baumgarten, D., Füllmengenkontrolle bei vorgepackten Erzeugnissen -Verfahren zur Dichtebestimmung bei flüssigen Produkten und ihre praktische Anwendung, Die Pharmazeutische Industrie, 1975, vol. 37, p. 717-726.
- (7) Riemann, J., Der Einsatz der digitalen Dichtemessung im Brauereilaboratorium, Brauwissenschaft, 1976, vol. 9, p. 253-255.

▼ B*Appendix*

For additional technical details, the following standards may be consulted for example.

1. **Buoyancy methods**

1.1. Hydrometer

DIN 12790, ISO 387	Hydrometer; general instructions
DIN 12791	Part I: Density hydrometers; construction, adjustment and use Part II: Density hydrometers; standardised sizes, designation Part III: Use and test
ISO 649-2	Laboratory glassware: Density hydrometers for general purpose
NF T 20-050	Chemical products for industrial use — Determination of density of liquids — Areometric method
DIN 12793	Laboratory glassware: range find hydrometers

1.2. Hydrostatic balance

For solid substances

ISO 1183	Method A: Methods for determining the density and relative density of plastics excluding cellular plastics
NF T 20-049	Chemical products for industrial use — Determination of the density of solids other than powders and cellular products — Hydrostatic balance method
ASTM-D-792	Specific gravity and density of plastics by displacement
DIN 53479	Testing of plastics and elastomers; determination of density

For liquid substances

ISO 901	ISO 758
---------	---------

▼ B

	DIN 51757	Testing of mineral oils and related materials; determination of density
	ASTM D 941-55, ASTM D 1296-67 and ASTM D 1481-62	
	ASTM D 1298	Density, specific gravity or API gravity of crude petroleum and liquid petroleum products by hydrometer method
	BS 4714	Density, specific gravity or API gravity of crude petroleum and liquid petroleum products by hydrometer method
1.3.	Immersed body method	
	DIN 53217	Testing of paints, varnishes and similar coating materials; determination of density; immersed body method
2.	Pycnometer methods	
2.1.	For liquid substances	
	ISO 3507	Pycnometers
	ISO 758	Liquid chemical products; determination of density at 20 °C
	DIN 12797	Gay-Lussac pycnometer (for non-volatile liquids which are not too viscous)
	DIN 12798	Lipkin pycnometer (for liquids with a kinematic viscosity of less than $100 \cdot 10^{-6} \text{ m}^2 \text{ s}^{-1}$ at 15 °C)
	DIN 12800	Sprengel pycnometer (for liquids as DIN 12798)
	DIN 12801	Reischauer pycnometer (for liquids with a kinematic viscosity of less than $100 \cdot 10^{-6} \text{ m}^2 \text{ s}^{-1}$ at 20 °C, applicable in particular also to hydrocarbons and aqueous solutions as well as to liquids with higher vapour pressure, approximately 1 bar at 90 °C)

▼ B

DIN 12806	Hubbard pycnometer (for viscous liquids of all types which do not have too high a vapour pressure, in particular also for paints, varnishes and bitumen)
DIN 12807	Bingham pycnometer (for liquids, as in DIN 12801)
DIN 12808	Jaulmes pycnometer (in particular for ethanol — water mixture)
DIN 12809	Pycnometer with ground-in thermometer and capillary side tube (for liquids which are not too viscous)
DIN 53217	Testing of paints, varnishes and similar products; determination of density by pycnometer
DIN 51757	Point 7: Testing of mineral oils and related materials; determination of density
ASTM D 297	Section 15: Rubber products — chemical analysis
ASTM D 2111	Method C: Halogenated organic compounds
BS 4699	Method for determination of specific gravity and density of petroleum products (graduated bicapillary pycnometer method)
BS 5903	Method for determination of relative density and density of petroleum products by the capillary — stoppered pycnometer method
NF T 20-053	Chemical products for industrial use — Determination of density of solids in powder and liquids — Pyknometric method

▼B

2.2. For solid substances

ISO 1183 Method B: Methods for determining the density and relative density of plastics excluding cellular plastics

NF T 20-053 Chemical products for industrial use — Determination of density of solids in powder and liquids — Pycnometric method

DIN 19683 Determination of the density of soils

3. **Air comparison pycnometer**

DIN 55990 Part 3: Prüfung von Anstrichstoffen und ähnlichen Beschichtungsstoffen; Pulverlack; Bestimmung der Dichte

DIN 53243 Anstrichstoffe; chlorhaltige Polymere; Prüfung

▼ M1**A.4. VAPOUR PRESSURE****1. METHOD**

This method is equivalent to OECD TG 104 (2004).

1.1. INTRODUCTION

This revised version of method A.4(1) includes one additional method; Effusion method: isothermal thermogravimetry, designed for substances with very low pressures (down to 10^{-10} Pa). In the light of needs for procedures, especially in relation to obtaining vapour pressure for substances with low vapour pressure, other procedures of this method are re-evaluated with respect to other applicability ranges.

At the thermodynamic equilibrium the vapour pressure of a pure substance is a function of temperature only. The fundamental principles are described elsewhere (2)(3).

No single measurement procedure is applicable to the entire range of vapour pressures from less than 10^{-10} to 10^5 Pa. Eight methods for measuring vapour pressure are included in this method which can be applied in different vapour pressure ranges. The various methods are compared as to application and measuring range in Table 1. The methods can only be applied for compounds that do not decompose under the conditions of the test. In cases where the experimental methods cannot be applied due to technical reasons, the vapour pressure can also be estimated, and a recommended estimation method is set out in the Appendix.

1.2. DEFINITIONS AND UNITS

The vapour pressure of a substance is defined as the saturation pressure above a solid or liquid substance.

The SI unit of pressure, which is the pascal (Pa), should be used. Other units which have been employed historically are given hereafter, together with their conversion factors:

$$\begin{aligned} 1 \text{ Torr} &= 1 \text{ mm Hg} &= 1,333 \times 10^2 \text{ Pa} \\ 1 \text{ atmosphere} &= 1,013 \times 10^5 \text{ Pa} \\ 1 \text{ bar} &= 10^5 \text{ Pa} \end{aligned}$$

The SI unit of temperature is the kelvin (K). The conversion of degrees Celsius to kelvin is according to the formula:

$$T = t + 273,15$$

where, T is the kelvin or thermodynamic temperature and t is the Celsius temperature.

▼ M1

Table 1

Measuring method	Substances		Estimated repeatability	Estimated reproducibility	Recommended range
	Solid	Liquid			
Dynamic method	Low melting	Yes	up to 25 % 1 to 5 %	up to 25 % 1 to 5 %	10 ³ Pa to 2 × 10 ³ Pa 2 × 10 ³ Pa to 10 ⁵ Pa
Static method	Yes	Yes	5 to 10 %	5 to 10 %	10 Pa to 10 ⁵ Pa 10 ⁻² Pa to 10 ⁵ Pa ⁽¹⁾
Isoteniscope method	Yes	Yes	5 to 10 %	5 to 10 %	10 ² Pa to 10 ⁵ Pa
Effusion method: vapour pressure balance	Yes	Yes	5 to 20 %	up to 50 %	10 ⁻³ to 1 Pa
Effusion method: Knudsen cell	Yes	Yes	10 to 30 %	—	10 ⁻¹⁰ to 1 Pa
Effusion method: isothermal thermo- gravimetry	Yes	Yes	5 to 30 %	up to 50 %	10 ⁻¹⁰ to 1 Pa
Gas saturation method	Yes	Yes	10 to 30 %	up to 50 %	10 ⁻¹⁰ to 10 ³ Pa
Spinning rotor method	Yes	Yes	10 to 20 %	—	10 ⁻⁴ to 0,5 Pa

⁽¹⁾ When using a capacitance manometer

1.3. PRINCIPLE OF THE TEST

In general, the vapour pressure is determined at various temperatures. In a limited temperature range, the logarithm of the vapour pressure of a pure substance is a linear function of the inverse of the thermodynamic temperature according to the simplified Clapeyron-Clausius equation:

$$\log p = \frac{\Delta H_v}{2,3RT} + \text{constant}$$

where:

p = the vapour pressure in pascals

ΔH_v = the heat of vaporisation in J mol⁻¹

R = the universal gas constant, 8,314 J mol⁻¹ K⁻¹

T = the temperature in K

▼ **M1**

1.4. REFERENCE SUBSTANCES

Reference substances do not need to be employed. They serve primarily to check the performance of a method from time to time as well as to allow comparison between results of different methods.

1.5. DESCRIPTION OF THE METHOD

1.5.1. **Dynamic method (Cottrell's method)**1.5.1.1. *Principle*

The vapour pressure is determined by measuring the boiling temperature of the substance at various specified pressures between roughly 10^3 and 10^5 Pa. This method is also recommended for the determination of the boiling temperature. For that purpose it is useful up to 600 K. The boiling temperatures of liquids are approximately $0,1$ °C higher at a depth of 3 to 4 cm than at the surface because of the hydrostatic pressure of the column of liquid. In Cottrell's method (4) the thermometer is placed in the vapour above the surface of the liquid and the boiling liquid is made to pump itself continuously over the bulb of the thermometer. A thin layer of liquid which is in equilibrium with vapour at atmospheric pressure covers the bulb. The thermometer thus reads the true boiling point, without errors due to superheating or hydrostatic pressure. The pump originally employed by Cottrell is shown in figure 1. Tube A contains the boiling liquid. A platinum wire B sealed into the bottom facilitates uniform boiling. The side tube C leads to a condenser, and the sheath D prevents the cold condensate from reaching the thermometer E. When the liquid in A is boiling, bubbles and liquid trapped by the funnel are poured via the two arms of the pump F over the bulb of the thermometer.

Figure 1

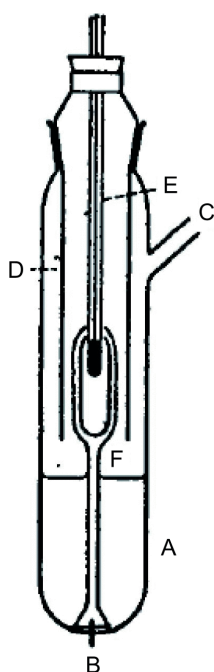
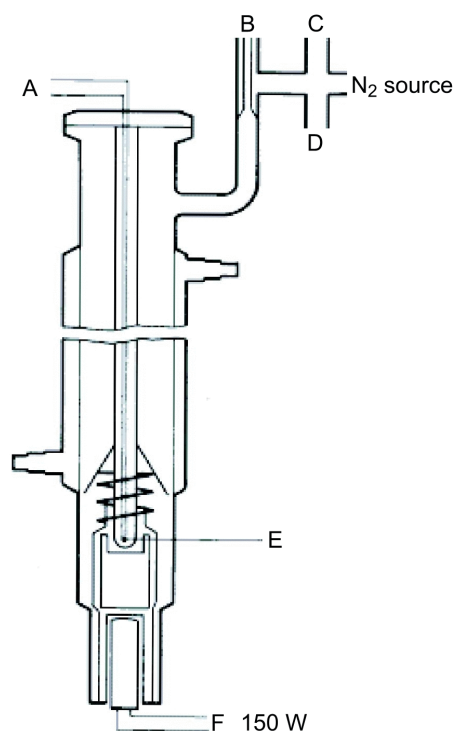

Figure 2



▼ **M1**

Cottrell pump (4)

A: Thermocouple

B: Vacuum buffer volume

C: Pressure gauge

D: Vacuum

E: Measuring point

F: Heating element c.a. 150 W

1.5.1.2. *Apparatus*

A very accurate apparatus, employing the Cottrell principle, is shown in figure 2. It consists of a tube with a boiling section in the lower part, a cooler in the middle part, and an outlet and flange in the upper part. The Cottrell pump is placed in the boiling section which is heated by means of an electrical cartridge. The temperature is measured by a jacketed thermocouple, or resistance thermometer inserting through the flange at the top. The outlet is connected to the pressure regulation system. The latter consists of a vacuum pump, a buffer volume, a manostat for admitting nitrogen for pressure regulation and manometer.

1.5.1.3. *Procedure*

The substance is placed in the boiling section. Problems may be encountered with non-powder solids but these can sometimes be solved by heating the cooling jacket. The apparatus is sealed at the flange and the substance degassed. Frothing substances cannot be measured using this method.

The lowest desired pressure is then set and the heating is switched on. At the same time, the temperature sensor is connected to a recorder.

Equilibrium is reached when a constant boiling temperature is recorded at constant pressure. Particular care must be taken to avoid bumping during boiling. In addition, complete condensation must occur on the cooler. When determining the vapour pressure of low melting solids, care should be taken to prevent the condenser from blocking.

After recording this equilibrium point, a higher pressure is set. The process is continued in this manner until 10^5 Pa has been reached (approximately 5 to 10 measuring points in all). As a check, equilibrium points must be repeated at decreasing pressures.

1.5.2. **Static method**

1.5.2.1. *Principle*

In the static method (5), the vapour pressure at thermodynamic equilibrium is determined at a specified temperature. This method is suitable for substances and multicomponent liquids and solids in the range from 10^{-1} to 10^5 Pa and, provided care is taken, also in the range 1 to 10 Pa.

▼ **M1**1.5.2.2. *Apparatus*

The equipment consists of a constant-temperature bath (precision of $\pm 0,2$ K), a container for the sample connected to a vacuum line, a manometer and a system to regulate the pressure. The sample chamber (figure 3a) is connected to the vacuum line via a valve and a differential manometer (U-tube containing a suitable manometer fluid) which serves as zero indicator. Mercury, silicones and phthalates are suitable for use in the differential manometer, depending on the pressure range and the chemical behaviour of the test substance. However, based on environmental concerns, the use of mercury should be avoided, if possible. The test substance must not dissolve noticeably in, or react with, the U-tube fluid. A pressure gauge can be used instead of a U-tube (figure 3b). For the manometer, mercury can be used in the range from normal pressure down to 10^2 Pa, while silicone fluids and phthalates are suitable for use below 10^2 Pa down to 10 Pa. There are other pressure gauges which can be used below 10^2 Pa and heatable membrane capacity manometers can even be used at below 10^{-1} Pa. The temperature is measured on the outside wall of the vessel containing the sample or in the vessel itself.

1.5.2.3. *Procedure*

Using the apparatus as described in figure 3a, fill the U-tube with the chosen liquid, which must be degassed at an elevated temperature before readings are taken. The test substance is placed in the apparatus and degassed at reduced temperature. In the case of a multiple-component sample, the temperature should be low enough to ensure that the composition of the material is not altered. Equilibrium can be established more quickly by stirring. The sample can be cooled with liquid nitrogen or dry ice, but care should be taken to avoid condensation of air or pump-fluid. With the valve over the sample vessel open, suction is applied for several minutes to remove the air. If necessary, the degassing operation is repeated several times.

Figure 3a

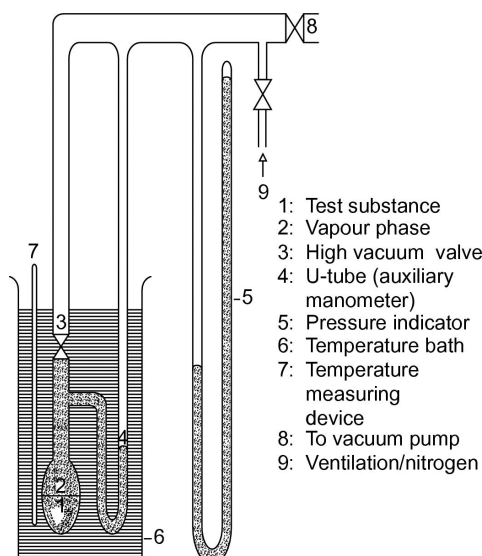
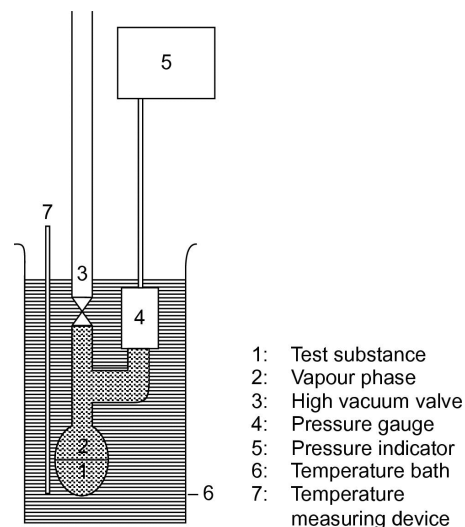

Figure 3b



▼ M1

When the sample is heated with the valve closed, the vapour pressure increases. This alters the equilibrium of the fluid in the U-tube. To compensate for this, nitrogen or air is admitted to the apparatus until the differential pressure indicator is at zero again. The pressure required for this can be read off the manometer or off an instrument of higher precision. This pressure corresponds to the vapour pressure of the substance at the temperature of the measurement. Using the apparatus described in figure 3b, the vapour pressure is read off directly.

The vapour pressure is determined at suitably small temperature intervals (approximately 5 to 10 measuring points in all) up to the desired temperature maximum.

Low-temperature readings must be repeated as a check. If the values obtained from the repeated readings do not coincide with the curve obtained for increasing temperature, this may be due to one of the following situations:

- (i) the sample still contains air (e.g. in the case of highly viscous materials) or low-boiling substances which is or are released during heating;

- (ii) the substance undergoes a chemical reaction in the temperature range investigated (e.g. decomposition, polymerisation).

1.5.3. Isoteniscope Method**1.5.3.1. Principle**

The isoteniscope (6) is based on the principle of the static method. The method involves placing a sample in a bulb maintained at constant temperature and connected to a manometer and a vacuum pump. Impurities more volatile than the substance are removed by degassing at reduced pressure. The vapour pressure of the sample at selected temperatures is balanced by a known pressure of inert gas. The isoteniscope was developed to measure the vapour pressure of certain liquid hydrocarbons but it is appropriate for the investigation of solids as well. The method is usually not suitable for multicomponent systems. Results are subject to only slight errors for samples containing non-volatile impurities. The recommended range is 10^2 to 10^5 Pa.

1.5.3.2. Apparatus

An example of a measuring device is shown in figure 4. A complete description can be found in ASTM D 2879-86 (6).

▼ **M1**1.5.3.3. *Procedure*

In the case of liquids, the substance itself serves as the fluid in the differential manometer. A quantity of the liquid, sufficient to fill the bulb and the short leg of the manometer, is put in the isoteniscope. The isoteniscope is attached to a vacuum system and evacuated, then filled by nitrogen. The evacuation and purge of the system is repeated twice to remove residual oxygen. The filled isoteniscope is placed in a horizontal position so that the sample spreads out into a thin layer in the sample bulb and manometer. The pressure of the system is reduced to 133 Pa and the sample is gently warmed until it just boils (removal of dissolved gases). The isoteniscope is then placed so that the sample returns to the bulb and fills the short leg of the manometer. The pressure is maintained at 133 Pa. The drawn-out tip of the sample bulb is heated with a small flame until the sample vapour released expands sufficiently to displace part of the sample from the upper part of the bulb and manometer arm into the manometer, creating a vapour-filled, nitrogen-free space. The isoteniscope is then placed in a constant temperature bath, and the pressure of the nitrogen is adjusted until it equals that of the sample. At the equilibrium, the pressure of the nitrogen equals the vapour pressure of the substance.

Figure 4

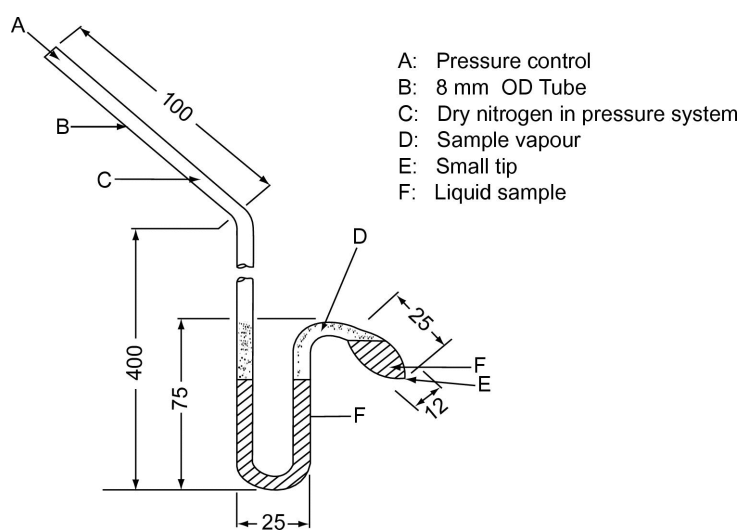

(Dimension in mm)

In the case of solids, and depending on the pressure and temperature ranges, manometer liquids such as silicon fluids or phthalates are used. The degassed manometer liquid is put in a bulge provided on the long arm of the isoteniscope. Then the solid to be investigated is placed in the sample bulb and is degassed at an elevated temperature. After that, the isoteniscope is inclined so that the manometer liquid can flow into the U-tube.

▼ **M1**1.5.4. **Effusion method: vapour pressure balance (7)**1.5.4.1. *Principle*

A sample of the test substance is heated in a small furnace and placed in an evacuated bell jar. The furnace is covered by a lid which carries small holes of known diameters. The vapour of the substance, escaping through one of the holes, is directed onto a balance pan of a highly sensitive balance which is also enclosed in the evacuated bell jar. In some designs the balance pan is surrounded by a refrigeration box, providing heat dissipation to the outside by thermal conduction, and is cooled by radiation so that the escaping vapour condenses on it. The momentum of the vapour jet acts as a force on the balance. The vapour pressure can be derived in two ways: directly from the force on the balance pan and also from the evaporation rate using the Hertz-Knudsen equation (2):

$$p = G \sqrt{\frac{2\pi RT \times 10^3}{M}}$$

where:

G = evaporation rate ($\text{kg s}^{-1} \text{m}^{-2}$)

M = molar mass (g mol^{-1})

T = temperature (K)

R = universal gas constant ($\text{J mol}^{-1} \text{K}^{-1}$)

P = vapour pressure (Pa)

The recommended range is 10^{-3} to 1 Pa.

1.5.4.2. *Apparatus*

The general principle of the apparatus is illustrated in figure 5.

Figure 5

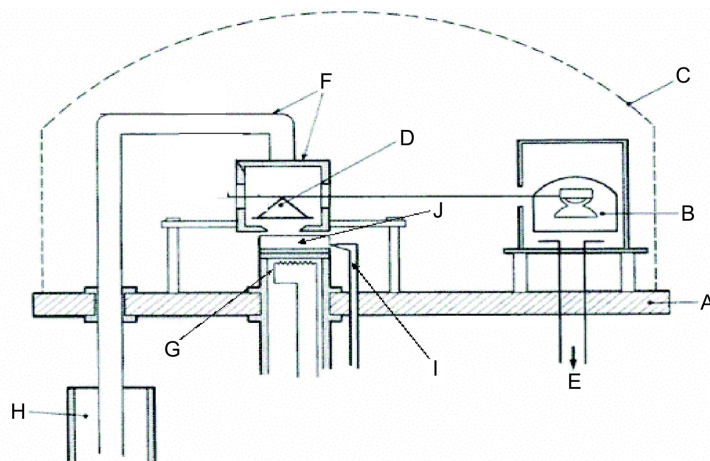

A:	Base plate	F:	Refrigeration box and cooling bar
B:	Moving coil instrument	G:	Evaporator furnace
C:	Bell jar	H:	Dewar flask with liquid nitrogen
D:	Balance with scale pan	I:	Measurement of temperature of sample
E:	Vacuum measuring device	J:	Test Substance

▼ **M1**1.5.5. **Effusion method: Knudsen cell**1.5.5.1. *Principle*

The method is based on the estimation of the mass of test substance flowing out per unit of time of a Knudsen cell (8) in the form of vapour, through a micro-orifice under ultra-vacuum conditions. The mass of effused vapour can be obtained either by determining the loss of mass of the cell or by condensing the vapour at low temperature and determining the amount of volatilised substance using chromatography. The vapour pressure is calculated by applying the Hertz-Knudsen relation (see section 1.5.4.1) with correction factors that depend on parameters of the apparatus (9). The recommended range is 10^{-10} to 1 Pa (10)(11)(12)(13)(14).

1.5.5.2. *Apparatus*

The general principle of the apparatus is illustrated in figure 6.

Figure 6

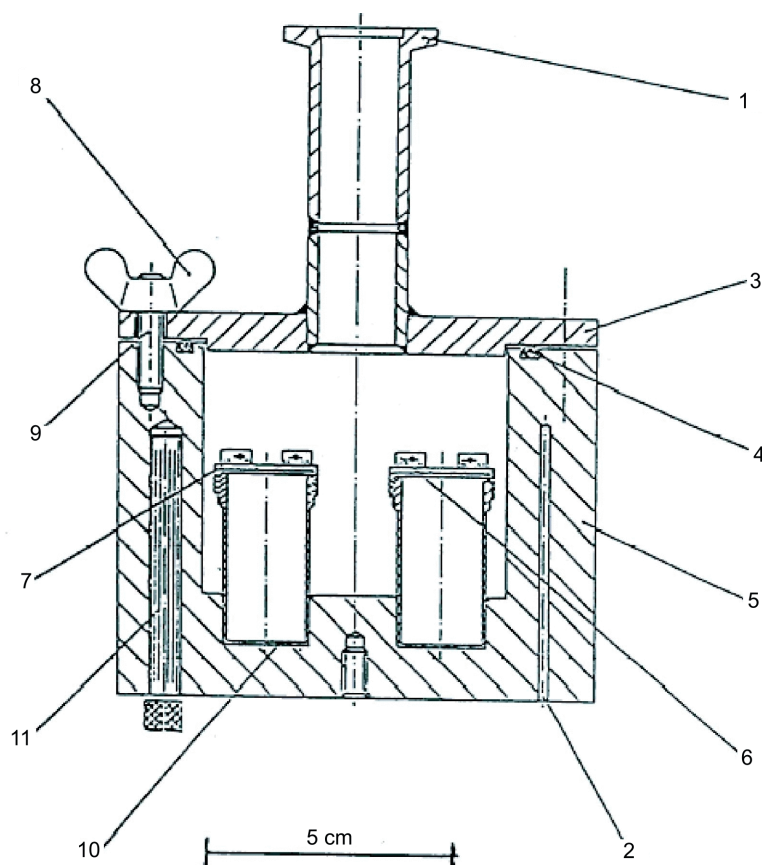

- | | |
|--|------------------------------------|
| 1: Connection to vacuum | 7: Threaded lid |
| 2: Wells from platinum resistance thermometer or temperature measurement and control | 8: Butterfly nuts |
| 3: Lid for vacuum tank | 9: Bolts |
| 4: O-ring | 10: Stainless steel effusion cells |
| 5: Aluminum vacuum tank | 11: Heater cartridge |
| 6: Device for installing and removing the effusion cells | |

▼ **M1**1.5.6. **Effusion method: isothermal thermogravimetry**1.5.6.1. *Principle*

The method is based on the determination of accelerated evaporation rates for the test substance at elevated temperatures and ambient pressure using thermogravimetry (10)(15)(16)(17)(18)(19)(20). The evaporation rates v_T result from exposing the selected compound to a slowly flowing inert gas atmosphere, and monitoring the weight loss at defined isothermal temperatures T in Kelvin over appropriate periods of time. The vapour pressures p_T are calculated from the v_T values by using the linear relationship between the logarithm of the vapour pressure and the logarithm of the evaporation rate. If necessary, an extrapolation to temperatures of 20 and 25 °C can be made by regression analysis of $\log p_T$ vs. $1/T$. This method is suitable for substances with vapour pressures as low as 10^{-10} Pa (10^{-12} mbar) and with purity as close as possible to 100 % to avoid the misinterpretation of measured weight losses.

1.5.6.2. *Apparatus*

The general principle of the experimental set-up is shown in figure 7.

Figure 7

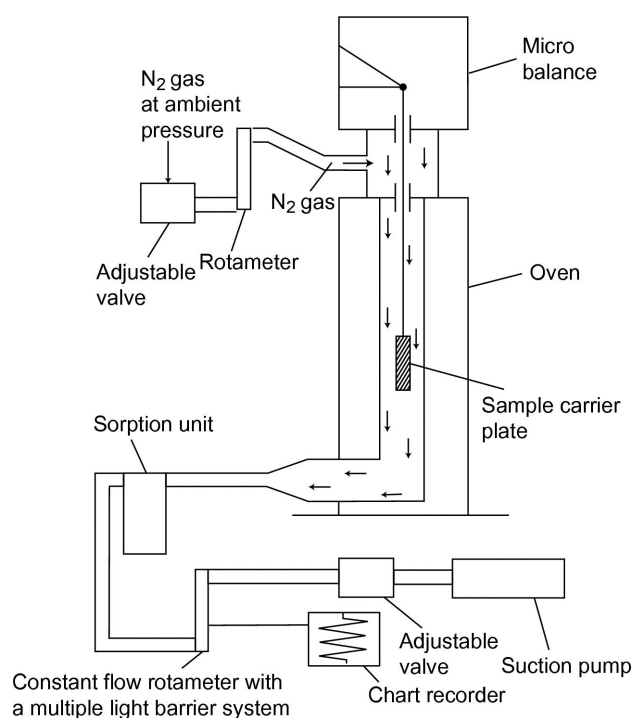

The sample carrier plate, hanging on a microbalance in a temperature controlled chamber, is swept by a stream of dry nitrogen gas which carries the vaporised molecules of the test substance away. After leaving the chamber, the gas stream is purified by a sorption unit.

1.5.6.3. *Procedure*

The test substance is applied to the surface of a roughened glass plate as a homogeneous layer. In the case of solids, the plate is wetted uniformly by a solution of the substance in a suitable solvent and dried in an inert atmosphere. For the measurement, the coated plate is hung into the thermogravimetric analyser and subsequently its weight loss is measured continuously as a function of time.

▼ M1

The evaporation rate v_T at a definite temperature is calculated from the weight loss Δm of the sample plate by

$$v_T = \frac{\Delta m}{F \cdot t} \text{ (gcm}^{-2}\text{h}^{-1}\text{)}$$

where F is the surface area of the coated test substances, normally the surface area of the sample plate, and t is the time for weight loss Δm .

The vapour pressure p_T is calculated on the basis of its function of evaporation rate v_T :

$$\text{Log } p_T = C + D \cdot \log v_T$$

where C and D are constants specific for the experimental arrangement used, depending on the diameter of the measurement chamber and on the gas flow rate. These constants must be determined once by measuring a set of compounds with known vapour pressure and regressing $\log p_T$ vs. $\log v_T$ (11)(21)(22).

The relationship between the vapour pressure p_T and the temperature T in Kelvin is given by

$$\text{Log } p_T = A + B \cdot 1/T$$

where A and B are constants obtained by regressing $\log p_T$ vs. $1/T$. With this equation, the vapour pressure can be calculated for any other temperature by extrapolation.

1.5.7. Gas saturation method (23)

1.5.7.1. Principle

Inert gas is passed, at room temperature and at a known flow rate, through or over a sample of the test substance, slowly enough to ensure saturation. Achieving saturation in the gas phase is of critical importance. The transported substance is trapped, generally using a sorbent, and its amount is determined. As an alternative to vapour trapping and subsequent analysis, in-train analytical techniques, like gas chromatography, may be used to determine quantitatively the amount of material transported. The vapour pressure is calculated on the assumption that the ideal gas law is obeyed and that the total pressure of a mixture of gases is equal to the sum of the pressures of the component gases. The partial pressure of the test substance, i.e. the vapour pressure, is calculated from the known total gas volume and from the weight of the material transported.

The gas saturation procedure is applicable to solid or liquid substances. It can be used for vapour pressures down to 10^{-10} Pa (10)(11)(12)(13)(14). The method is most reliable for vapour pressures below 10^3 Pa. Above 10^3 Pa, the vapour pressures are generally overestimated, probably due to aerosol formation. Since the vapour pressure measurements are made at room temperature, the need to extrapolate data from high temperatures is not necessary and high temperature extrapolation, which can often cause serious errors, is avoided.

1.5.7.2. Apparatus

The procedure requires the use of a constant-temperature box. The sketch in figure 8 shows a box containing three solid and three liquid sample holders, which allow for the triplicate analysis of either a solid or a liquid sample. The temperature is controlled to $\pm 0,5$ °C or better.

▼ M1

Figure 8

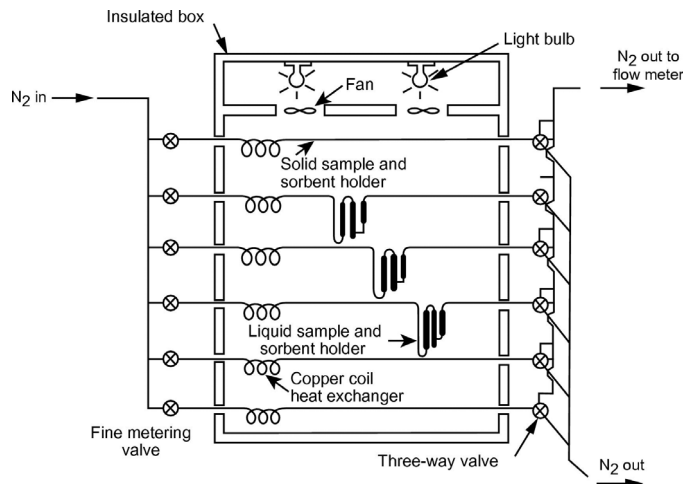

In general, nitrogen is used as an inert carrier gas but, occasionally, another gas may be required (24). The carrier gas must be dry. The gas stream is split into 6 streams, controlled by needle valves (approximately 0,79 mm orifice), and flows into the box via 3,8 mm i.d. copper tubing. After temperature equilibration, the gas flows through the sample and the sorbent trap and exists from the box.

Solid samples are loaded into 5 mm i.d. glass tubing between glass wool plugs (see Figure 9). Figure 10 shows a liquid sample holder and sorbent system. The most reproducible method for measuring the vapour pressure of liquids is to coat the liquid on glass beads or on an inert sorbent such as silica, and to pack the holder with these beads. As an alternative, the carrier gas may be made to pass a coarse frit and bubble through a column of the liquid test substance.

Figure 9

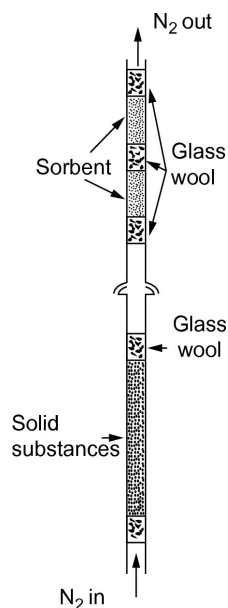
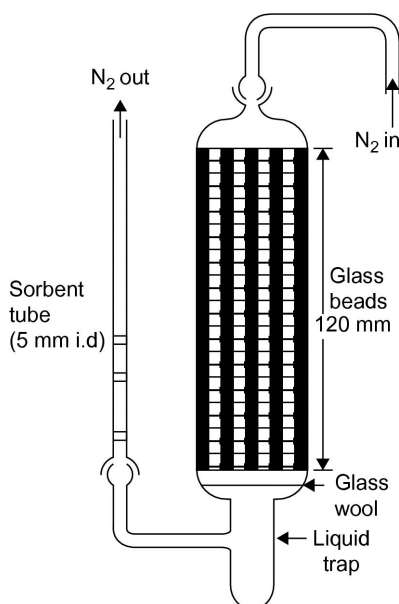

Figure 10



▼ M1

The sorbent system contains a front and a backup sorbent section. At very low vapour pressures, only small amounts are retained by the sorbent and the adsorption on the glass wool and the glass tubing between the sample and the sorbent may be a serious problem.

Traps cooled with solid CO₂ are another efficient way for collecting the vaporised material. They do not cause any back pressure on the saturator column and it is also easy to quantitatively remove the trapped material.

1.5.7.3. Procedure

The flow rate of the effluent carrier gas is measured at room temperature. The flow rate is checked frequently during the experiment to assure that there is an accurate value for the total volume of carrier gas. Continuous monitoring with a mass flow-meter is preferred. Saturation of the gas phase may require considerable contact time and hence quite low gas flow rates (25).

At the end of the experiment, both the front and backup sorbent sections are analysed separately. The compound on each section is desorbed by adding a solvent. The resulting solutions are analysed quantitatively to determine the weight desorbed from each section. The choice of the analytical method (also the choice of sorbent and desorbing solvent) is dictated by the nature of the test material. The desorption efficiency is determined by injecting a known amount of sample onto the sorbent, desorbing it and analysing the amount recovered. It is important to check the desorption efficiency at or near the concentration of the sample under the test conditions.

To assure that the carrier gas is saturated with the test substance, three different gas flow rates are used. If the calculated vapour pressure shows no dependence on flow rate, the gas is assumed to be saturated.

The vapour pressure is calculated through the equation:

$$p = \frac{W}{V} \times \frac{RT}{M}$$

where:

p = vapour pressure (Pa)

W = mass of evaporated test substance (g)

V = volume of saturated gas (m³)

R = universal gas constant 8,314 (J mol⁻¹ K⁻¹)

T = temperature (K)

M = molar mass of test substance (g mol⁻¹)

Measured volumes must be corrected for pressure and temperature differences between the flow meter and the saturator.

▼ **M1**1.5.8. **Spinning rotor**1.5.8.1. *Principle*

This method uses a spinning rotor viscosity gauge, in which the measuring element is a small steel ball which, suspended in a magnetic field, is made to spin by rotating fields (26)(27)(28). Pick-up coils allow its spinning rate to be measured. When the ball has reached a given rotational speed, usually about 400 revolutions per second, energising is stopped and deceleration, due to gas friction, takes place. The drop of rotational speed is measured as a function of time. The vapour pressure is deduced from the pressure-dependent slow-down of the steel ball. The recommended range is 10^{-4} to 0,5 Pa.

1.5.8.2. *Apparatus*

A schematic drawing of the experimental set-up is shown in figure 11. The measuring head is placed in a constant-temperature enclosure, regulated within 0,1 °C. The sample container is placed in a separate enclosure, also regulated within 0,1 °C. All other parts of the set-up are kept at a higher temperature to prevent condensation. The whole apparatus is connected to a high-vacuum system.

Figure 11

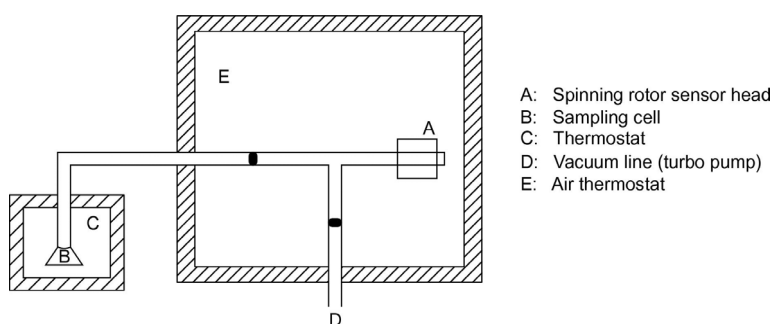
2. **DATA AND REPORTING**2.1. **DATA**

The vapour pressure from any of the preceding methods should be determined for at least two temperatures. Three or more are preferred in the range from 0 to 50 °C, in order to check the linearity of the vapour pressure curve. In case of Effusion method (Knudsen cell and isothermal thermogravimetry) and Gas saturation method, 120 to 150 °C is recommended for the measuring temperature range instead of 0 to 50 °C.

2.2. **TEST REPORT**

The test report must include the following information:

— method used,

▼ M1

- precise specification of the substance (identity and impurities) and preliminary purification step, if any,
- at least two vapour pressure and temperature values — and preferably three or more — required in the range from 0 to 50 °C (or 120 to 150 °C),
- at least one of the temperatures should be at or below 25 °C, if technically possible according to the chosen method,
- all original data,
- a log p versus 1/T curve,
- an estimate of the vapour pressure at 20 or 25 °C.

If a transition (change of state, decomposition) is observed, the following information should be noted:

- nature of the change,
- temperature at which the change occurs at atmospheric pressure,
- vapour pressure at 10 and 20 °C below the transition temperature and 10 and 20 °C above this temperature (unless the transition is from solid to gas).

All information and remarks relevant for the interpretation of results have to be reported, especially with regard to impurities and physical state of the substance.

3. LITERATURE

- (1) *Official Journal of the European Communities* L 383 A, 26-47 (1992).
- (2) Ambrose, D. (1975). *Experimental Thermodynamics*, Vol. II, Le Neindre, B., and Vodar, B., Eds., Butterworths, London.
- (3) Weissberger R., ed. (1959). *Technique of Organic Chemistry, Physical Methods of Organic Chemistry*, 3rd ed., Vol. I, Part I. Chapter IX, Interscience Publ., New York.
- (4) Glasstone, S. (1946). *Textbook of Physical Chemistry*, 2nd ed., Van Nostrand Company, New York.
- (5) NF T 20-048 AFNOR (September 1985). Chemical products for industrial use — Determination of vapour pressure of solids and liquids within a range from 10^{-1} to 10^5 Pa — Static method.
- (6) ASTM D 2879-86, Standard test method for vapour pressure — temperature relationship and initial decomposition temperature of liquids by isotenoscope.
- (7) NF T 20-047 AFNOR (September 1985). Chemical products for industrial use — Determination of vapour pressure of solids and liquids within range from 10^{-3} to 1 Pa — Vapour pressure balance method.

▼ **M1**

- (8) Knudsen, M. (1909). *Ann. Phys. Lpz.*, 29, 1979; (1911), 34, 593.
- (9) Ambrose, D., Lawrenson, I.J., Sprake, C.H.S. (1975). *J. Chem. Thermodynamics* 7, 1173.
- (10) Schmuckler, M.E., Barefoot, A.C., Kleier, D.A., Cobranchi, D.P. (2000), Vapor pressures of sulfonylurea herbicides; *Pest Management Science* 56, 521-532.
- (11) Tomlin, C.D.S. (ed.), *The Pesticide Manual*, Twelfth Edition (2000).
- (12) Friedrich, K., Stambach, K., Gas chromatographic determination of small vapour pressures determination of the vapour pressures of some triazine herbicides. *J. Chromatog.* 16 (1964), 22-28.
- (13) Grayson, B.T., Fosbraey, L.A., *Pesticide Science* 16 (1982), 269-278.
- (14) Rordorf, B.F., Prediction of vapor pressures, boiling points and enthalpies of fusion for twenty-nine halogenated dibenzo-p-dioxins, *Thermochimica Acta* 112 Issue 1 (1987), 117-122.
- (15) Gückel, W., Synnatschke, G., Rittig, R., A Method for Determining the Volatility of Active Ingredients Used in Plant Protection; *Pesticide Science* 4 (1973) 137-147.
- (16) Gückel, W., Synnatschke, G., Rittig, R., A Method for Determining the Volatility of Active Ingredients Used in Plant Protection II. Application to Formulated Products; *Pesticide Science* 5 (1974) 393-400.
- (17) Gückel, W., Kaestel, R., Lewerenz, J., Synnatschke, G., A Method for Determining the Volatility of Active Ingredients Used in Plant Protection. Part III: The Temperature Relationship between Vapour Pressure and Evaporation Rate; *Pesticide Science* 13 (1982) 161-168.
- (18) Gückel, W., Kaestel, R., Kroehl, T., Parg, A., Methods for Determining the Vapour Pressure of Active Ingredients Used in Crop Protection. Part IV: An Improved Thermogravimetric Determination Based on Evaporation Rate; *Pesticide Science* 45 (1995) 27-31.
- (19) Kroehl, T., Kaestel, R., Koenig, W., Ziegler, H., Koehle, H., Parg, A., Methods for Determining the Vapour Pressure of Active Ingredients Used in Crop Protection. Part V: Thermogravimetry Combined with Solid Phase MicroExtraction (SPME); *Pesticide Science*, 53 (1998) 300-310.
- (20) Tesconi, M., Yalkowsky, S.H., A Novel Thermogravimetric Method for Estimating the Saturated Vapor Pressure of Low-Volatility Compounds; *Journal of Pharmaceutical Science* 87(12) (1998) 1512-20.
- (21) Lide, D.R. (ed.), *CRC Handbook of Chemistry and Physics*, 81st ed. (2000), Vapour Pressure in the Range — 25 °C to 150 °C.
- (22) Meister, R.T. (ed.), *Farm Chemicals Handbook*, Vol. 88 (2002).
- (23) 40 CFR, 796. (1993). pp 148-153, Office of the Federal Register, Washington DC.

▼ M1

- (24) Rordorf B.F. (1985). *Thermochimica Acta* 85, 435.
- (25) Westcott et al. (1981). *Environ. Sci. Technol.* 15, 1375.
- (26) Messer G., Röhl, P., Grosse G., and Jitschin W. (1987). *J. Vac. Sci. Technol. (A)*, 5(4), 2440.
- (27) Comsa G., Fremerey J.K., and Lindenau, B. (1980). *J. Vac. Sci. Technol.* 17(2), 642.
- (28) Fremerey, J.K. (1985). *J. Vac. Sci. Technol. (A)*, 3(3), 1715.

▼ **M1***Appendix***Estimation method**

INTRODUCTION

Estimated values of the vapour pressure can be used:

- for deciding which of the experimental methods is appropriate,
- for providing an estimate or limit value in cases where the experimental method cannot be applied due to technical reasons.

ESTIMATION METHOD

The vapour pressure of liquids and solids can be estimated by use of the modified Watson correlation (a). The only experimental data required is the normal boiling point. The method is applicable over the pressure range from 10^5 Pa to 10^{-5} Pa.

Detailed information on the method is given in 'Handbook of Chemical Property Estimation Methods' (b). See also OECD Environmental Monograph No.67 (c).

CALCULATION PROCEDURE

The vapour pressure is calculated as follows:

$$\ln P_{vp} \approx \frac{\Delta H_{vb}}{\Delta Z_b R T_b} \left[1 - \frac{\left(3 - 2 \frac{T}{T_b}\right)^m}{\frac{T}{T_b}} - 2m \left(3 - 2 \frac{T}{T_b}\right)^{m-1} \ln \frac{T}{T_b} \right]$$

where:

T = temperature of interest

T_b = normal boiling point

P_{vp} = vapour pressure at temperature T

ΔH_{vb} = heat of vaporisation

ΔZ_b = compressibility factor (estimated at 0,97)

m = empirical factor depending on the physical state at the temperature of interest

Further,

$$\frac{\Delta H_{vb}}{T_b} = K_F (8,75 + R \ln T_b)$$

where, K_F is an empirical factor considering the polarity of the substance. For several compound types, K_F factors are listed in reference (b).

▼ M1

Quite often, data are available in which a boiling point at reduced pressure is given. In such a case, the vapour pressure is calculated as follows:

$$\ln P_{vp} \approx \ln P_1 + \frac{\Delta H_{vl}}{\Delta Z_b R T_1} \left[1 - \left(3 - 2 \frac{T}{T_1} \right)^m \frac{T_1}{T} - 2m \left(3 - 2 \frac{T}{T_1} \right)^{m-1} \ln \frac{T}{T_1} \right]$$

where, T_1 is the boiling point at the reduced pressure P_1 .

REPORT

When using the estimation method, the report shall include a comprehensive documentation of the calculation.

LITERATURE

- (a) Watson, K.M. (1943). Ind. Eng. Chem, 35, 398.
- (b) Lyman, W.J., Reehl, W.F., Rosenblatt, D.H. (1982). Handbook of Chemical Property Estimation Methods, McGraw-Hill.
- (c) OECD Environmental Monograph No.67. Application of Structure-Activity Relationships to the Estimation of Properties Important in Exposure Assessment (1993).

▼ B**A.5. SURFACE TENSION****1. METHOD**

The methods described are based on the OECD Test Guideline (1). The fundamental principles are given in reference (2).

1.1. INTRODUCTION

The described methods are to be applied to the measurement of the surface tension of aqueous solutions.

It is useful to have preliminary information on the water solubility, the structure, the hydrolysis properties and the critical concentration for micelles formation of the substance before performing these tests.

The following methods are applicable to most chemical substances, without any restriction in respect to their degree of purity.

The measurement of the surface tension by the ring tensiometer method is restricted to aqueous solutions with a dynamic viscosity of less than approximately 200 mPa s.

1.2. DEFINITIONS AND UNITS

The free surface enthalpy per unit of surface area is referred to as surface tension.

The surface tension is given as:

N/m (SI unit) or

mN/m (SI sub-unit)

1 N/m = 10³ dynes/cm

1 mN/m = 1 dyne/cm in the obsolete cgs system

1.3. REFERENCE SUBSTANCES

Reference substances do not need to be employed in all cases when investigating a new substance. They should primarily serve to check the performance of the method from time to time and to allow comparison with results from other methods.

Reference substances which cover a wide range of surface tensions are given in references 1 and 3.

1.4. PRINCIPLE OF THE METHODS

The methods are based on the measurement of the maximum force which is necessary to exert vertically, on a stirrup or a ring in contact with the surface of the liquid being examined placed in a measuring cup, in order to separate it from this surface, or on a plate, with an edge in contact with the surface, in order to draw up the film that has formed.

Substances which are soluble in water at least at a concentration of 1 mg/l are tested in aqueous solution at a single concentration.

1.5. QUALITY CRITERIA

These methods are capable of greater precision than is likely to be required for environmental assessment.

▼B

1.6. DESCRIPTION OF THE METHODS

A solution of the substance is prepared in distilled water. The concentration of this solution should be 90 % of the saturation solubility of the substance in water; when this concentration exceeds 1 g/l, a concentration of 1 g/l is used for testing. Substances with water solubility lower than 1 mg/l need not be tested.

1.6.1. **Plate method**

See ISO 304 and NF T 73-060 (Surface active agents — determination of surface tension by drawing up liquid films).

1.6.2. **Stirrup method**

See ISO 304 and NF T 73-060 (Surface active agents — determination of surface tension by drawing up liquid films).

1.6.3. **Ring method**

See ISO 304 and NF T 73-060 (Surface active agents — determination of surface tension by drawing up liquid films).

1.6.4. **OECD harmonised ring method**1.6.4.1. *Apparatus*

Commercially available tensiometers are adequate for this measurement. They consist of the following elements:

- mobile sample table,

- force measuring system,

- measuring body (ring),

- measurement vessel.

1.6.4.1.1. *Mobile sample table*

The mobile sample table is used as a support for the temperature-controlled measurement vessel holding the liquid to be tested. Together with the force measuring system, it is mounted on a stand.

1.6.4.1.2. *Force measuring system*

The force measuring system (see figure) is located above the sample table. The error of the force measurement shall not exceed $\pm 10^{-6}$ N, corresponding to an error limit of $\pm 0,1$ mg in a mass measurement. In most cases, the measuring scale of commercially available tensiometers is calibrated in mN/m so that the surface tension can be read directly in mN/m with an accuracy of 0,1 mN/m.

▼B

1.6.4.1.3. Measuring body (ring)

The ring is usually made of a platinum-iridium wire of about 0,4 mm thickness and a mean circumference of 60 mm. The wire ring is suspended horizontally from a metal pin and a wire mounting bracket to establish the connection to the force measuring system (see figure).

Figure

Measuring body

(All dimensions expressed in millimetres)

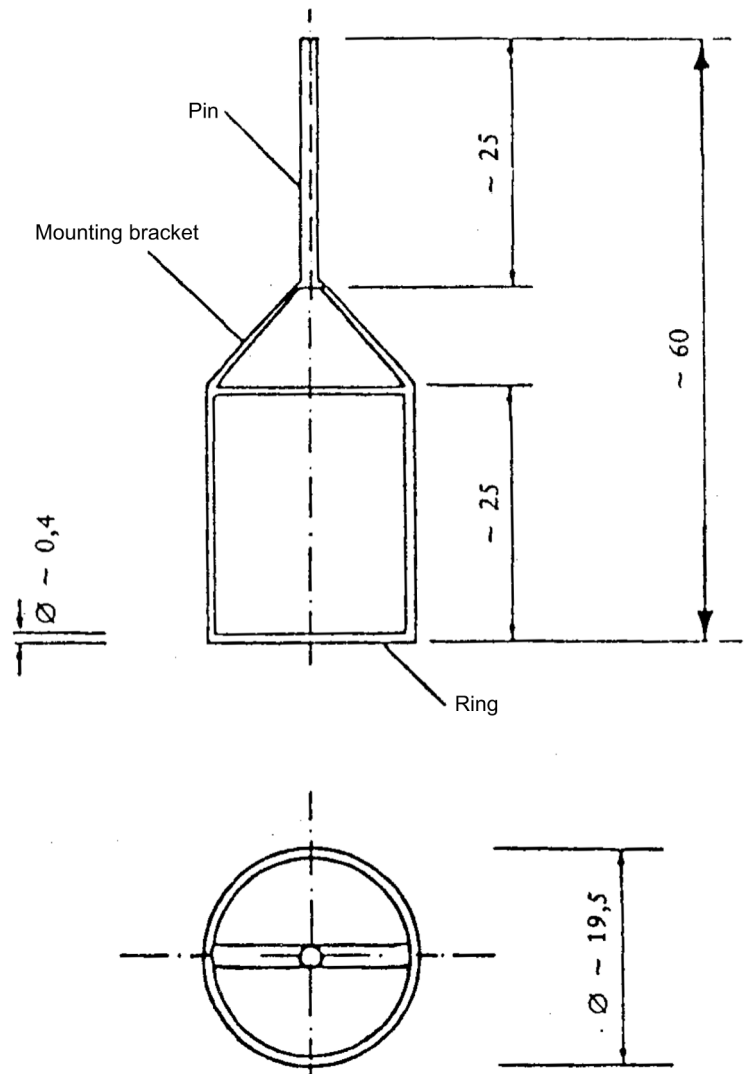

1.6.4.1.4. Measurement vessel

The measurement vessel holding the test solution to be measured shall be a temperature-controlled glass vessel. It shall be designed so that during the measurement the temperature of the test solution liquid and the gas phase above its surface remains constant and that the sample cannot evaporate. Cylindrical glass vessels having an inside diameter of not less than 45 mm are acceptable.

▼ B1.6.4.2. *Preparation of the apparatus*1.6.4.2.1. *Cleaning*

Glass vessels shall be cleaned carefully. If necessary they shall be washed with hot chromo-sulphuric acid and subsequently with syrupy phosphoric acid (83 to 98 % by weight of H_3PO_4), thoroughly rinsed in tap water and finally washed with double-distilled water until a neutral reaction is obtained and subsequently dried or rinsed with part of the sample liquid to be measured.

The ring shall first be rinsed thoroughly in water to remove any substances which are soluble in water, briefly immersed in chromo-sulphuric acid, washed in double-distilled water until a neutral reaction is obtained and finally heated briefly above a methanol flame.

Note:

Contamination by substances which are not dissolved or destroyed by chromo-sulphuric acid or phosphoric acid, such as silicones, shall be removed by means of a suitable organic solvent.

1.6.4.2.2. *Calibration of the apparatus*

The validation of the apparatus consists of verifying the zero point and adjusting it so that the indication of the instrument allows reliable determination in mN/m.

Mounting:

The apparatus shall be levelled, for instance by means of a spirit level on the tensiometer base, by adjusting the levelling screws in the base.

Zero point adjustment:

After mounting the ring on the apparatus and prior to immersion in the liquid, the tensiometer indication shall be adjusted to zero and the ring checked for parallelism to the liquid surface. For this purpose, the liquid surface can be used as a mirror.

Calibrations:

The actual test calibration can be accomplished by means of either of two procedures:

- (a) Using a mass: procedure using riders of known mass between 0,1 and 1,0 g placed on the ring. The calibration factor, Φ_a by which all the instrument readings must be multiplied, shall be determined according to equation (1).

$$\Phi_a = \frac{\sigma_r}{\sigma_a}$$

where:

$$\sigma_r = \frac{mg}{2b} \text{ (mN/m)}$$

m = mass of the rider (g)

g = gravity acceleration (981 cm s⁻² at sea level)

b = mean circumference of the ring (cm)

σ_a = reading of the tensiometer after placing the rider on the ring (mN/m).

▼ B

- (b) Using water: procedure using pure water whose surface tension at, for instance, 23 °C is equal to 72,3 mN/m. This procedure is accomplished faster than the weight calibration but there is always the danger that the surface tension of the water is falsified by traces of contamination by surfactants.

The calibration factor, Φ_b by which all the instrument readings shall be multiplied, shall be determined in accordance with the equation (2):

$$\Phi_b = \frac{\sigma_o}{\sigma_g}$$

where:

σ_o = value cited in the literature for the surface tension of water (mN/m)

σ_g = measured value of the surface tension of the water (mN/m) both at the same temperature.

1.6.4.3. *Preparation of samples*

Aqueous solutions shall be prepared of the substances to be tested, using the required concentrations in water, and shall not contain any non-dissolved substances.

The solution must be maintained at a constant temperature ($\pm 0,5$ °C). Since the surface tension of a solution in the measurement vessel alters over a period of time, several measurements shall be made at various times and a curve plotted showing surface tension as a function of time. When no further change occurs, a state of equilibrium has been reached.

Dust and gaseous contamination by other substances interfere with the measurement. The work shall therefore be carried out under a protective cover.

1.6.5. **Test conditions**

The measurement shall be made at approximately 20 °C and shall be controlled to within $\pm 0,5$ °C.

1.6.6. **Performance of test**

The solutions to be measured shall be transferred to the carefully cleaned measurement vessel, taking care to avoid foaming, and subsequently the measurement vessel shall be placed onto the table of the test apparatus. The table-top with measurement vessel shall be raised until the ring is immersed below the surface of the solution to be measured. Subsequently, the table-top shall be lowered gradually and evenly (at a rate of approximately 0,5 cm/min) to detach the ring from the surface until the maximum force has been reached. The liquid layer attached to the ring must not separate from the ring. After completing the measurements, the ring shall be immersed below the surface again and the measurements repeated until a constant surface tension value is reached. The time from transferring the solution to the measurement vessel shall be recorded for each determination. Readings shall be taken at the maximum force required to detach the ring from the liquid surface.

▼ B**2. DATA**

In order to calculate the surface tension, the value read in mN/m on the apparatus shall be first multiplied by the calibration factor Φ_a or Φ_b (depending on the calibration procedure used). This will yield a value which applies only approximately and therefore requires correction.

Harkins and Jordan (4) have empirically determined correction factors for surface-tension values measured by the ring method which are dependent on ring dimensions, the density of the liquid and its surface tension.

Since it is laborious to determine the correction factor for each individual measurement from the Harkins and Jordan tables, in order to calculate the surface tension for aqueous solutions the simplified procedure of reading the corrected surface-tension values directly from the table may be used. (Interpolation shall be used for readings ranging between the tabular values.)

*Table:***Correction of the measured surface tension**

Only for aqueous solutions, $\rho = 1 \text{ g/cm}^3$

r	= 9,55 mm (average ring radius)	
r	= 0,185 mm (ring wire radius)	
	Corrected Value (mN/m)	
Experimental Value (mN/m)	Weight calibration (see 1.6.4.2.2(a))	Water calibration (see 1.6.4.2.2(b))
20	16,9	18,1
22	18,7	20,1
24	20,6	22,1
26	22,4	24,1
28	24,3	26,1
30	26,2	28,1
32	28,1	30,1
34	29,9	32,1
36	31,8	34,1
38	33,7	36,1
40	35,6	38,2
42	37,6	40,3
44	39,5	42,3
46	41,4	44,4
48	43,4	46,5
50	45,3	48,6
52	47,3	50,7
54	49,3	52,8
56	51,2	54,9

▼ B

Experimental Value (mN/m)	Corrected Value (mN/m)	
	Weight calibration (see 1.6.4.2.2(a))	Water calibration (see 1.6.4.2.2(b))
58	53,2	57,0
60	55,2	59,1
62	57,2	61,3
64	59,2	63,4
66	61,2	65,5
68	63,2	67,7
70	65,2	69,9
72	67,2	72,0
74	69,2	—
76	71,2	—
78	73,2	—

This table has been compiled on the basis of the Harkins-Jordan correction. It is similar to that in the DIN Standard (DIN 53914) for water and aqueous solutions (density $\rho = 1 \text{ g/cm}^3$ and is for a commercially available ring having the dimensions $R = 9,55 \text{ mm}$ (mean ring radius) and $r = 0,185 \text{ mm}$ (ring wire radius). The table provides corrected values for surface-tension measurements taken after calibration with weights or calibration with water.

Alternatively, without the preceding calibration, the surface tension can be calculated according to the following formula:

$$\sigma = \frac{f \times F}{4\pi R}$$

where:

F = the force measured on the dynamometer at the breakpoint of the film

R = the radius of the ring

f = the correction factor (1)

3. REPORTING

3.1. TEST REPORT

The test report shall, if possible, include the following information:

— method used,

— type of water or solution used,

— precise specification of the substance (identity and impurities),

— measurement results: surface tension (reading) stating both the individual readings and their arithmetic mean as well as the corrected mean (taking into consideration the equipment factor and the correction table),

▼B

- concentration of the solution,
- test temperature,
- age of solution used; in particular the time between preparation and measurement of the solution,
- description of time dependence of surface tension after transferring the solution to the measurement vessel,
- all information and remarks relevant for the interpretation of results have to be reported, especially with regard to impurities and physical state of the substance.

3.2. INTERPRETATION OF RESULTS

Considering that distilled water has a surface tension of 72,75 mN/m at 20 °C, substances showing a surface tension lower than 60 mN/m under the conditions of this method should be regarded as being surface-active materials.

4. REFERENCES

- (1) OECD, Paris, 1981, Test Guideline 115, Decision of the Council C(81) 30 final.
- (2) R. Weissberger ed.: Technique of Organic Chemistry, Physical Methods of Organic Chemistry, 3rd ed., Interscience Publ., New York, 1959, vol. I, Part I, Chapter XIV.
- (3) Pure Appl. Chem., 1976, vol. 48, p. 511.
- (4) Harkins, W.D., Jordan, H.F., J. Amer. Chem. Soc., 1930, vol. 52, p. 1751.

▼M4**A.6. WATER SOLUBILITY****INTRODUCTION**

1. This Test Method is equivalent to OECD Test Guideline (TG) 105 (1995). This Test Method is a revised version of the original TG 105 which was adopted in 1981. There is no difference of substance between the current version and that from 1981. Mainly the format has been changed. The revision was based on the EU Test Method 'Water Solubility' ⁽¹⁾.

INITIAL CONSIDERATIONS

2. The water solubility of a substance can be considerably affected by the presence of impurities. This Test Method addresses the determination of the solubility in water of essentially pure substances which are stable in water and not volatile. Before determining water solubility, it is useful to have some preliminary information on the test substance, like structural formula, vapour pressure, dissociation constant and hydrolysis as a function of pH.
3. Two methods, the column elution method and the flask method which cover respectively solubilities below and above 10^{-2} g/l are described in this Test Method. A simple preliminary test is also described. It allows the determination of approximately the appropriate amount of sample to be used in the final test, as well as the time necessary to achieve saturation.

DEFINITIONS AND UNITS

4. The water solubility of a substance is the saturation mass concentration of the substance in water at a given temperature.
5. Water solubility is expressed in mass of solute per volume of solution. The SI unit is kg/m^3 but g/l may also be used.

REFERENCE CHEMICALS

6. Reference chemicals do not need to be employed when investigating a test substance.

DESCRIPTION OF THE METHODS**Test conditions**

7. The test is preferably run at $20 \pm 0,5$ °C. The chosen temperature should be kept constant in all relevant parts of the equipment.

Preliminary test

8. In a stepwise procedure, increasing volumes of water are added at room temperature to approximately 0,1 g of the sample (solid test substances must be pulverized) in a 10 ml glass-stoppered measuring cylinder. After each addition of an amount of water, the mixture is shaken for 10 minutes and is visually checked for any undissolved parts of the sample. If, after addition of 10 ml of water, the sample or parts of it remain undissolved, the experiment is continued in a 100 ml measuring cylinder. The approximate solubility is given in Table 1 below under that volume of water in which

▼ M4

complete dissolution of the sample occurs. When the solubility is low, a long time may be required to dissolve a test substance and at least 24 hours should be allowed. If, after 24 hours, the test substance is still not dissolved, more time (up to 96 hours) should be allowed or further dilution should be attempted to ascertain whether the column elution method or flask method should be used.

Table 1

ml of water for 0,1 g soluble	0,1	0,5	1	2	10	100	> 100
approximate solubility in g/l	> 1 000	1 000 to 200	200 to 100	100 to 50	50 to 10	10 to 1	< 1

Column elution method*Principle*

- This method is based on the elution of a test substance with water from a micro-column which is charged with an inert support material, previously coated with an excess of the test substance (2). The water solubility is given by the mass concentration of the eluate when this has reached a plateau as a function of time.

Apparatus

- The apparatus consists of a microcolumn (Figure 1), maintained at constant temperature. It is connected either to a recirculating pump (Figure 2) or to a levelling vessel (Figure 3). The microcolumn contains an inert support held in place by a small plug of glasswool which also serves to filter out particles. Possible materials which can be employed for the support are glass beads, diatomaceous earth, or other inert materials.
- The microcolumn shown in Figure 1 is suitable for the set-up with recirculating pump. It has a head space providing for five bed volumes (discarded at the start of the experiment) and the volume of five samples (withdrawn for analysis during the experiment). Alternatively, the size can be reduced if water can be added to the system during the experiment to replace the initial five bed volumes removed with impurities. The column is connected with tubing made of an inert material to the recirculating pump, capable of delivering approximately 25 ml/h. The recirculating pump can be, for example, a peristaltic or membrane pump. Care must be taken that no contamination and/or adsorption occur with the tube material.
- A schematic arrangement using a levelling vessel is shown in Figure 3. In this arrangement the microcolumn is fitted with a one way stopcock. The connection to the levelling vessel consists of a ground glass joint and tubing made of an inert material. The flow rate from the levelling vessel should be approximately 25 ml/h.

▼ M4

Figure 1

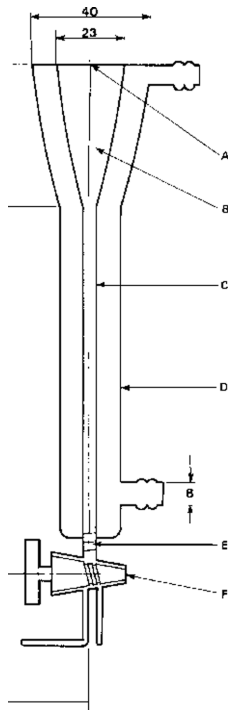

Dimensions in mm

- A. Connection for ground glass joint
- B. Headspace
- C. Interior 5
- D. Exterior 19
- E. Plug of glass wool
- F. Stopcock

Figure 2

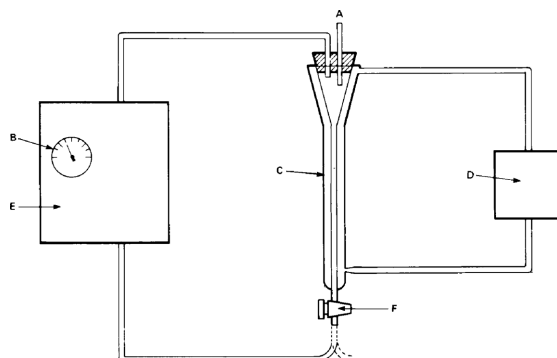

- A. Atmospheric equilibration
- B. Flowmeter
- C. Microcolumn
- D. Thermostatically controlled circulating pump
- E. Recirculating pump
- F. Two-way valve for sampling

▼ **M4**

Figure 3

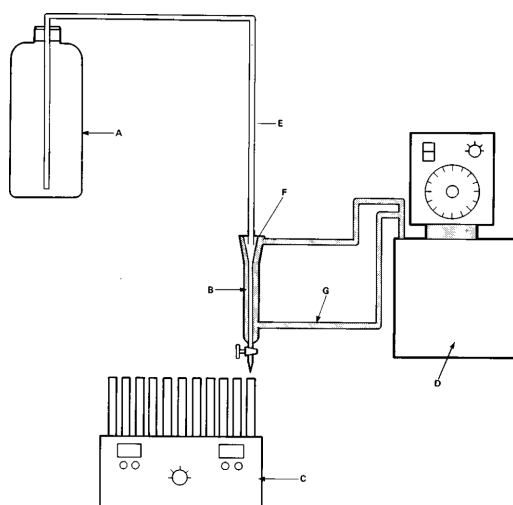

- A. Levelling vessel (e.g. 2,5 litres chemical flask)
- B. Column
- C. Fraction accumulator
- D. Thermostat
- E. Teflon tubing
- F. Ground glass joint
- G. Water line (between thermostat and column, inner diameter approximately 8 mm)
13. Approximately 600 mg of support material is transferred to a 50 ml round-bottom flask. A suitable amount of test substance is dissolved in a volatile solvent of analytical reagent quality and an appropriate amount of this solution is added to the support material. The solvent is completely evaporated, e.g. using a rotary evaporator, as otherwise water saturation of the support will not be achieved during the elution step because of partitioning on the surface. The loaded support material is soaked for two hours in approximately 5 ml of water and the suspension is poured into the micro-column. Alternatively, dry loaded support material may be poured into the water-filled microcolumn and two hours are allowed for equilibrating.
14. The loading of the support material may cause problems, leading to erroneous results, e.g. when the test substance is deposited as an oil. These problems should be examined and the details reported.

Procedure using a recirculating pump

15. The flow through the column is started. It is recommended that a flow rate of approximately 25 ml/h, corresponding to 10 bed volumes per hour for the column described, be used. At least the first five bed volumes are discarded to remove water soluble impurities. Following this, the pump is allowed to run until equilibrium is established, as defined by five successive samples whose concentrations do not differ by more than $\pm 30\%$ in a random fashion. These samples should be separated from each other by time intervals corresponding to the passage of at least ten bed volumes. Depending on the analytical method used, it may be preferable to establish a concentration/time curve to show that equilibrium is reached.

▼ M4*Procedure using a levelling vessel*

16. Successive eluate fractions should be collected and analysed by the chosen method. Fractions from the middle eluate range, where the concentrations are constant within $\pm 30\%$ in at least five consecutive fractions, are used to determine the solubility.
17. Double distilled water is the preferred eluent. Deionized water with a resistivity above 10 megohms/cm and total organic carbon content below 0,01 % can also be used.
18. Under both procedures, a second run is performed at half the flow rate of the first. If the results of the two runs are in agreement, the test is satisfactory. If the measured solubility is higher with the lower flow rate, then the halving of the flow rate must continue until two successive runs give the same solubility.
19. Under both procedures, the fractions should be checked for the presence of colloidal matter by examination of the Tyndall effect. The presence of particles invalidates the test and the test should be repeated after improvement of the filtering action of the column.
20. The pH of each sample should be measured, preferably by using special indicator strips.

Flask method*Principle*

21. The test substance (solids must be pulverized) is dissolved in water at a temperature somewhat above the test temperature. When saturation is achieved, the mixture is cooled and kept at the test temperature. Alternatively, and if it is assured by appropriate sampling that the saturation equilibrium is reached, the measurement can be performed directly at the test temperature. Subsequently, the mass concentration of the test substance in the aqueous solution, which must not contain any undissolved particles, is determined by a suitable analytical method (3).

Apparatus

22. The following materials are needed:
 - normal laboratory glassware and instrumentation;
 - a device for the agitation of solutions under controlled constant temperature;
 - if required for emulsions, a centrifuge (preferably thermostated); and
 - analytical equipment.

Procedure

23. The quantity of test substance necessary to saturate the desired volume of water is estimated from the preliminary test. About five times that quantity is weighed into each of three glass vessels fitted with glass stoppers (e.g. centrifuge tubes, flasks). A volume of water, chosen in function of the analytical method and solubility range, is added to each vessel. The vessels are tightly stoppered and then agitated at 30 °C. A shaking or stirring device capable of operating at constant temperature should be used, e.g. magnetic stirring in a thermostated water bath. After one day, one of the vessels is equilibrated for 24 hours at the test temperature with occasional shaking. The contents of the vessel are then centrifuged at the test temperature and the concentration of the test substance in the clear aqueous phase is determined by a suitable analytical method. The other two flasks are treated similarly after initial equilibration at 30 °C for two and three days

▼ M4

respectively. If the concentrations measured in at least the two last vessels do not differ by more than 15 %, the test is satisfactory. If the results from vessels 1, 2 and 3 show a tendency of increasing values, the whole test should be repeated using longer equilibration times.

24. The test can also be performed without pre-incubation at 30 °C. In order to estimate the rate of establishment of the saturation equilibrium, samples are taken until the stirring time no longer influences the concentrations measured.
25. The pH of each sample should be measured, preferably by using special indicator strips.

Analytical determinations

26. A substance-specific method is preferred since small amounts of soluble impurities can cause large errors in the measured solubility. Examples of such methods are: gas or liquid chromatography, titration, photometry, voltametry.

DATA AND REPORTING**Data***Column elution method*

27. For each run, the mean value and standard deviation from at least five consecutive samples taken from the saturation plateau should be calculated. The mean values obtained from two tests with different flows should not differ by more than 30 %.

Flask method

28. The individual results from each of the three flasks, which should not differ by more than 15 %, are averaged.

Test Report*Column elution method*

29. The test report must include the following information:
 - the results of the preliminary test
 - chemical identity and impurities (preliminary purification step, if any)
 - the concentrations, flow rates and pH for each sample
 - the means and standard deviations from at least five samples from the saturation plateau of each run
 - the average of at least two successive runs
 - the temperature of the water during the saturation process
 - the method of analysis
 - the nature of the support material
 - loading of the support material
 - solvent used
 - evidence of any chemical instability of the substance during the test
 - all information relevant for the interpretation of the results, in particular with regard to impurities and physical state of the test substance.

▼ M4*Flask method*

30. The test report must include the following information:
- the results of the preliminary test
 - chemical identity and impurities (preliminary purification step, if any)
 - the individual analytical determinations and the average where more than one value was determined for each flask
 - the pH of each sample
 - the average of the values for different flasks which were in agreement
 - the test temperature
 - the analytical method
 - evidence of any chemical instability of the substance during the test
 - all information relevant for the interpretation of the results, in particular with regard to impurities and physical state of the test substance.

LITERATURE:

- (1) Commission Directive 92/69/EEC of 31 July 1992 adapting to technical progress for the seventeenth time Council Directive 67/548/EEC on the approximation of laws, regulations and administrative provisions relating to the classification, packaging and labelling of dangerous substances (OJ L 383, 29.12.1992, p. 113).
- (2) NF T 20-045 (AFNOR) (September 1985). Chemical products for industrial use — Determination of water solubility of solids and liquids with low solubility — Column elution method.
- (3) NF T 20-046 (AFNOR) (September 1985). Chemical products for industrial use — Determination of water solubility of solids and liquids with high solubility — Flask method.

▼ B**A.8. PARTITION COEFFICIENT****1. METHOD**

The 'shake flask' method described is based on the OECD Test Guideline (1).

1.1. INTRODUCTION

It is useful to have preliminary information on structural formula, dissociation constant, water solubility, hydrolysis, n-octanol solubility and surface tension of the substance to perform this test.

Measurements should be made on ionisable substances only in their non-ionised form (free acid or free base) produced by the use of an appropriate buffer with a pH of at least one pH unit below (free acid) or above (free base) the pK.

This test method includes two separate procedures: the shake flask method and high performance liquid chromatography (HPLC). The former is applicable when the log P_{ow} value (see below for definitions) falls within the range - 2 to 4 and the latter within the range 0 to 6. Before carrying out either of the experimental procedures a preliminary estimate of the partition coefficient should first be obtained.

The shake-flask method applies only to essentially pure substances soluble in water and n-octanol. It is not applicable to surface active materials (for which a calculated value or an estimate based on the individual n-octanol and water solubilities should be provided).

The HPLC method is not applicable to strong acids and bases, metal complexes, surface-active materials or substances which react with the eluent. For these materials, a calculated value or an estimate based on individual n-octanol and water solubilities should be provided.

The HPLC method is less sensitive to the presence of impurities in the test compound than is the shake-flask method. Nevertheless, in some cases impurities can make the interpretation of the results difficult because peak assignment becomes uncertain. For mixtures which give an unresolved band, upper and lower limits of log P should be stated.

1.2. DEFINITION AND UNITS

The partition coefficient (P) is defined as the ratio of the equilibrium concentrations (c_i) of a dissolved substance in a two-phase system consisting of two largely immiscible solvents. In the case n-octanol and water:

$$P_{ow} = \frac{c_{n\text{-octanol}}}{c_{\text{water}}}$$

The partition coefficient (P) therefore is the quotient of two concentrations and is usually given in the form of its logarithm to base 10 (log P).

▼ B

1.3. REFERENCE SUBSTANCES

Shake-flask method

Reference substances do not need to be employed in all cases when investigating a new substance. They should primarily serve to check the performance of the method from time to time and to allow comparison with results from other methods.

HPLC method

In order to correlate the measured HPLC data of a compound with its P value, a calibration graph of log P versus chromatographic data using at least six reference points has to be established. It is for the user to select the appropriate reference substances. Whenever possible, at least one reference compound should have a P_{ow} above that of the test substance, and another a P_{ow} below that of the test substance. For log P values less than 4, the calibration can be based on data obtained by the shake-flask method. For log P values greater than 4, the calibration can be based on validated literature values if these are in agreement with calculated values. For better accuracy, it is preferable to choose reference compounds which are structurally related to the test substance.

Extensive lists of values of log P_{ow} for many groups of chemicals are available (2)(3). If data on the partition coefficients of structurally related compounds are not available, then a more general calibration, established with other reference compounds, may be used.

A list of recommended reference substances and their P_{ow} values is given in Appendix 2.

1.4. PRINCIPLE OF THE METHOD

1.4.1. **Shake-flask method**

In order to determine a partition coefficient, equilibrium between all interacting components of the system must be achieved, and the concentrations of the substances dissolved in the two phases must be determined. A study of the literature on this subject indicates that several different techniques can be used to solve this problem, i.e. the thorough mixing of the two phases followed by their separation in order to determine the equilibrium concentration for the substance being examined.

1.4.2. **HPLC method**

HPLC is performed on analytical columns packed with a commercially available solid phase containing long hydrocarbon chains (e.g. C₈, C₁₈) chemically bound onto silica. Chemicals injected onto such a column move along it at different rates because of the different degrees of partitioning between the mobile phase and the hydrocarbon stationary phase. Mixtures of chemicals are eluted in order of their hydrophobicity, with water-soluble chemicals eluted first and oil-soluble chemicals last, in proportion to their hydrocarbon-water partition coefficient. This enables the relationship between the retention time on such a (reverse phase) column and the n-octanol/water partition coefficient to be established. The partition coefficient is deduced from the *capacity factor* k, given by the expression:

▼ B

$$k = \frac{t_r - t_0}{t_0}$$

in which, t_r = retention time of the test substance, and t_0 = average time a solvent molecule needs to pass through the column (dead-time).

Quantitative analytical methods are not required and only the determination of elution times is necessary.

1.5. QUALITY CRITERIA**1.5.1. Repeatability***Shake-flask method*

In order to assure the accuracy of the partition coefficient, duplicate determinations are to be made under three different test conditions, whereby the quantity of substance specified as well as the ratio of the solvent volumes may be varied. The determined values of the partition coefficient expressed as their common logarithms should fall within a range of $\pm 0,3$ log units.

HPLC method

In order to increase the confidence in the measurement, duplicate determinations must be made. The values of log P derived from individual measurements should fall within a range of $\pm 0,1$ log units.

1.5.2. Sensitivity*Shake-flask method*

The measuring range of the method is determined by the limit of detection of the analytical procedure. This should permit the assessment of values of log P_{ow} in the range of - 2 to 4 (occasionally when conditions apply, this range may be extended to log P_{ow} up to 5) when the concentration of the solute in either phase is not more than 0,01 mol per litre.

HPLC method

The HPLC method enables partition coefficients to be estimated in the log P_{ow} range 0 to 6.

Normally, the partition coefficient of a compound can be estimated to within ± 1 log unit of the shake-flask value. Typical correlations can be found in the literature (4)(5)(6)(7)(8). Higher accuracy can usually be achieved when correlation plots are based on structurally-related reference compounds (9).

▼ B1.5.3. **Specificity***Shake-flask method*

The Nernst Partition Law applies only at constant temperature, pressure and pH for dilute solutions. It strictly applies to a pure substance dispersed between two pure solvents. If several different solutes occur in one or both phases at the same time, this may affect the results.

Dissociation or association of the dissolved molecules result in deviations from the Nernst Partition Law. Such deviations are indicated by the fact that the partition coefficient becomes dependent upon the concentration of the solution.

Because of the multiple equilibria involved, this test method should not be applied to ionisable compounds without applying a correction. The use of buffer solutions in place of water should be considered for such compounds; the pH of the buffer should be at least 1 pH unit from the pKa of the substance and bearing in mind the relevance of this pH for the environment.

1.6. DESCRIPTION OF THE METHOD

1.6.1. **Preliminary estimate of the partition coefficient**

The partition coefficient is estimated preferably by using a calculation method (see Appendix 1), or where appropriate, from the ratio of the solubilities of the test substance in the pure solvents (10).

1.6.2. **Shake-flask method**1.6.2.1. *Preparation*

n-Octanol: the determination of the partition coefficient should be carried out with high purity analytical grade reagent.

Water: water distilled or double distilled in glass or quartz apparatus should be employed. For ionisable compounds, buffer solutions in place of water should be used if justified.

Note:

Water taken directly from an ion exchanger should not be used.

1.6.2.1.1. **Pre-saturation of the solvents**

Before a partition coefficient is determined, the phases of the solvent system are mutually saturated by shaking at the temperature of the experiment. To do this, it is practical to shake two large stock bottles of high purity analytical grade n-octanol or water each with a sufficient quantity of the other solvent for 24 hours on a mechanical shaker and then to let them stand long enough to allow the phases to separate and to achieve a saturation state.

▼B

1.6.2.1.2. Preparation for the test

The entire volume of the two-phase system should nearly fill the test vessel. This will help prevent loss of material due to volatilisation. The volume ratio and quantities of substance to be used are fixed by the following:

- the preliminary assessment of the partition coefficient (see above),
- the minimum quantity of test substance required for the analytical procedure, and
- the limitation of a maximum concentration in either phase of 0,01 mol per litre.

Three tests are carried out. In the first, the calculated volume ratio of n-octanol to water is used; in the second, this ratio is divided by two; and in the third, this ratio is multiplied by two (e.g. 1:1, 1:2, 2:1).

1.6.2.1.3. Test substance

A stock solution is prepared in n-octanol pre-saturated with water. The concentration of this stock solution should be precisely determined before it is employed in the determination of the partition coefficient. This solution should be stored under conditions which ensure its stability.

1.6.2.2. Test conditions

The test temperature should be kept constant (± 1 °C) and lie in the range of 20 to 25 °C.

1.6.2.3. Measurement procedure

1.6.2.3.1. Establishment of the partition equilibrium

Duplicate test vessels containing the required, accurately measured amounts of the two solvents together with the necessary quantity of the stock solution should be prepared for each of the test conditions.

The n-octanol phases should be measured by volume. The test vessels should either be placed in a suitable shaker or shaken by hand. When using a centrifuge tube, a recommended method is to rotate the tube quickly through 180° about its transverse axis so that any trapped air rises through the two phases. Experience has shown that 50 such rotations are usually sufficient for the establishment of the partition equilibrium. To be certain, 100 rotations in five minutes are recommended.

1.6.2.3.2. Phase separation

When necessary, in order to separate the phases, centrifugation of the mixture should be carried out. This should be done in a laboratory centrifuge maintained at room temperature, or, if a non-temperature controlled centrifuge is used, the centrifuge tubes should be kept for equilibration at the test temperature for at least one hour before analysis.

▼ B1.6.2.4. *Analysis*

For the determination of the partition coefficient, it is necessary to determine the concentrations of the test substance in both phases. This may be done by taking an aliquot of each of the two phases from each tube for each test condition and analyzing them by the chosen procedure. The total quantity of substance present in both phases should be calculated and compared with the quantity of the substance originally introduced.

The aqueous phase should be sampled by a procedure that minimises the risk of including traces of n-octanol: a glass syringe with a removable needle can be used to sample the water phase. The syringe should initially be partially filled with air. Air should be gently expelled while inserting the needle through the n-octanol layer. An adequate volume of aqueous phase is withdrawn into the syringe. The syringe is quickly removed from the solution and the needle detached. The contents of the syringe may then be used as the aqueous sample. The concentration in the two separated phases should preferably be determined by a substance-specific method. Examples of analytical methods which may be appropriate are:

- photometric methods,
- gas chromatography,
- high-performance liquid chromatography.

1.6.3. **HPLC method**1.6.3.1. *Preparation**Apparatus*

A liquid chromatograph, fitted with a pulse-free pump and a suitable detection device, is required. The use of an injection valve with injection loops is recommended. The presence of polar groups in the stationary phase may seriously impair the performance of the HPLC column. Therefore, stationary phases should have the minimal percentage of polar groups (11). Commercial microparticulate reverse-phase packings or ready-packed columns can be used. A guard column may be positioned between the injection system and the analytical column.

Mobile phase

HPLC grade methanol and HPLC grade water are used to prepare the eluting solvent, which is degassed before use. Isocratic elution should be employed. Methanol/water ratios with a minimum water content of 25 % should be used. Typically a 3:1 (v/v) methanol-water mixture is satisfactory for eluting compounds of log P 6 within an hour, at a flow rate of 1 ml/min. For compounds of high log P it may be necessary to shorten the elution time (and those of the reference compounds) by decreasing the polarity of the mobile phase or the column length.

Substances with very low solubility in n-octanol tend to give abnormally low log P_{ow} values with the HPLC method; the peaks of such compounds sometimes accompany the solvent front. This is probably due to the fact that the partitioning process is too slow to reach the equilibrium in the time normally taken by an HPLC separation. Decreasing the flow rate and/or lowering the methanol/water ratio may then be effective to arrive at a reliable value.

▼ B

Test and reference compounds should be soluble in the mobile phase in sufficient concentrations to allow their detection. Only in exceptional cases may additives be used with the methanol-water mixture, since additives will change the properties of the column. For chromatograms with additives it is mandatory to use a separate column of the same type. If methanol-water is not appropriate, other organic solvent-water mixtures can be used, e.g. ethanol-water or acetonitrile-water.

The pH of the eluent is critical for ionisable compounds. It should be within the operating pH range of the column, which is usually between 2 and 8. Buffering is recommended. Care must be taken to avoid salt precipitation and column deterioration which occur with some organic phase/buffer mixtures. HPLC measurements with silica-based stationary phases above pH 8 are not advisable since the use of an alkaline, mobile phase may cause rapid deterioration in the performance of the column.

Solutes

The reference compounds should be the purest available. Compounds to be used for test or calibration purposes are dissolved in the mobile phase if possible.

Test conditions

The temperature during the measurements should not vary by more than ± 2 K.

1.6.3.2. **Measurement***Calculation of dead time t_0*

The dead time t_0 can be determined by using either a homologous series (e.g. n-alkyl methyl ketones) or unretained organic compounds (e.g. thiourea or formamide). For calculating the dead time t_0 by using a homologous series, a set of at least seven members of a homologous series is injected and the respective retention times are determined. The raw retention times $t_{r(n_c + 1)}$ are plotted as a function of $t_{r(n_c)}$ and the intercept a and slope b of the regression equation:

$$t_{r(n_c + 1)} = a + b t_{r(n_c)}$$

are determined (n_c = number of carbon atoms). The dead time t_0 is then given by:

$$t_0 = a/(1 - b)$$

▼ B*Calibration graph*

The next step is to construct a correlation plot of log k values versus log p for appropriate reference compounds. In practice, a set of between 5 and 10 standard reference compounds whose log p is around the expected range are injected simultaneously and the retention times are determined, preferably on a recording integrator linked to the detection system. The corresponding logarithms of the capacity factors, log k, are calculated and plotted as a function of the log p determined by the shake-flask method. The calibration is performed at regular intervals, at least once daily, so that possible changes in column performance can be allowed for.

Determination of the capacity factor of the test substance

The test substance is injected in as small a quantity of mobile phase as possible. The retention time is determined (in duplicate), permitting the calculation of the capacity factor k. From the correlation graph of the reference compounds, the partition coefficient of the test substance can be interpolated. For very low and very high partition coefficients, extrapolation is necessary. In those cases particular care has to be taken of the confidence limits of the regression line.

2. DATA*Shake-flask method*

The reliability of the determined values of P can be tested by comparison of the means of the duplicate determinations with the overall mean.

3. REPORTING

The test report shall, if possible, include the following information:

- precise specification of the substance (identity and impurities),

- when the methods are not applicable (e.g. surface active material), a calculated value or an estimate based on the individual n-octanol and water solubilities should be provided,

- all information and remarks relevant for the interpretation of results, especially with regard to impurities and physical state of the substance.

For shake-flask method:

- the result of the preliminary estimation, if any,

- temperature of the determination,

- data on the analytical procedures used in determining concentrations,

- time and speed of centrifugation, if used,

▼ B

- the measured concentrations in both phases for each determination (this means that a total of 12 concentrations will be reported),
- the weight of the test substance, the volume of each phase employed in each test vessel and the total calculated amount of test substance present in each phase after equilibration,
- the calculated values of the partition coefficient (P) and the mean should be reported for each set of test conditions as should the mean for all determinations. If there is a suggestion of concentration dependency of the partition coefficient, this should be noted in the report,
- the standard deviation of individual P values about their mean should be reported,
- the mean P from all determinations should also be expressed as its logarithm (base 10),
- the calculated theoretical P_{ow} when this value has been determined or when the measured value is $> 10^4$,
- pH of water used and of the aqueous phase during the experiment,
- if buffers are used, justification for the use of buffers in place of water, composition, concentration and pH of the buffers, pH of the aqueous phase before and after the experiment.

For HPLC method:

- the result of the preliminary estimation, if any,
- test and reference substances, and their purity,
- temperature range of the determinations,
- pH at which the determinations are made,
- details of the analytical and guard column, mobile phase and means of detection,
- retention data and literature log P values for reference compounds used in calibration,
- details of fitted regression line (log k versus log P),
- average retention data and interpolated log P value for the test compound,
- description of equipment and operating conditions,
- elution profiles,
- quantities of test and reference substances introduced in the column,
- dead-time and how it was measured.

▼B

4.

REFERENCES

- (1) OECD, Paris, 1981, Test Guideline 107, Decision of the Council C(81) 30 final.
- (2) C. Hansch and A.J. Leo, Substituent Constants for Correlation Analysis in Chemistry and Biology, John Wiley, New York, 1979.
- (3) Log P and Parameter Database, A tool for the quantitative prediction of bioactivity (C. Hansch, chairman, A.J. Leo, dir.) — Available from Pomona College Medical Chemistry Project 1982, Pomona College, Claremont, California 91711.
- (4) L. Renberg, G. Sundström and K. Sundh-Nygård, Chemosphere, 1980, vol. 80, p. 683.
- (5) H. Ellgehausen, C. D'Hondt and R. Fuerer, Pestic. Sci., 1981, vol. 12, p. 219.
- (6) B. McDuffie, Chemosphere, 1981, vol. 10, p. 73.
- (7) W.E. Hammers et al., J. Chromatogr., 1982, vol. 247, p. 1.
- (8) J.E. Haky and A.M. Young, J. Liq. Chromat., 1984, vol. 7, p. 675.
- (9) S. Fujisawa and E. Masuhara, J. Biomed. Mat. Res., 1981, vol. 15, p. 787.
- (10) O. Jubermann, Verteilen und Extrahieren, in Methoden der Organischen Chemie (Houben Weyl), Allgemeine Laboratoriumspraxis (edited by E. Muller), Georg Thieme Verlag, Stuttgart, 1958, Band I/1, p. 223-339.
- (11) R.F. Rekker and H.M. de Kort, Euro. J. Med. Chem., 1979, vol. 14, p. 479.
- (12) A. Leo, C. Hansch and D. Elkins, Partition coefficients and their uses. Chem. Rev., 1971, vol. 71, p. 525.
- (13) R.F. Rekker, The Hydrophobic Fragmental Constant, Elsevier, Amsterdam, 1977.
- (14) NF T 20-043 AFNOR (1985). Chemical products for industrial use — Determination of partition coefficient — Flask shaking method.
- (15) C.V. Eadsforth and P. Moser, Chemosphere, 1983, vol. 12, p. 1459.
- (16) A. Leo, C. Hansch and D. Elkins, Chem. Rev., 1971, vol. 71, p. 525.
- (17) C. Hansch, A. Leo, S.H. Unger, K.H. Kim, D. Nikaitani and E.J. Lien, J. Med. Chem., 1973, vol. 16, p. 1207.
- (18) W.B. Neely, D.R. Branson and G.E. Blau, Environ. Sci. Technol., 1974, vol. 8, p. 1113.
- (19) D.S. Brown and E.W. Flagg, J. Environ. Qual., 1981, vol. 10, p. 382.
- (20) J.K. Seydel and K.J. Schaper, Chemische Struktur und biologische Aktivität von Wirkstoffen, Verlag Chemie, Weinheim, New York, 1979.

▼B

- (21) R. Franke, *Theoretical Drug Design Methods*, Elsevier, Amsterdam, 1984.
- (22) Y.C. Martin, *Quantitative Drug Design*, Marcel Dekker, New York, Basel, 1978.
- (23) N.S. Nirrlees, S.J. Noulton, C.T. Murphy, P.J. Taylor; *J. Med. Chem.*, 1976, vol. 19, p. 615.

▼ B*Appendix 1***Calculation/estimation methods****INTRODUCTION**

A general introduction to calculation methods, data and examples are provided in the Handbook of Chemical Property Estimation Methods (a).

Calculated values of P_{ow} can be used:

- for deciding which of the experimental methods is appropriate (shake-flask range: $\log P_{ow}$: - 2 to 4, HPLC range: $\log P_{ow}$: 0 to 6),
- for selecting the appropriate test conditions (e.g. reference substances for HPLC procedures, volume ratio n-octanol/water for shake flask method),
- as a laboratory internal check on possible experimental errors,
- for providing a P_{ow} -estimate in cases where the experimental methods cannot be applied for technical reasons.

ESTIMATION METHOD*Preliminary estimate of the partition coefficient*

The value of the partition coefficient can be estimated by the use of the solubilities of the test substance in the pure solvents: For this:

$$P_{\text{estimate}} = \frac{\text{saturation } c_{n - \text{octanol}}}{\text{saturation } c_{\text{water}}}$$

CALCULATION METHODS*Principle of the calculation methods*

All calculation methods are based on the formal fragmentation of the molecule into suitable substructures for which reliable $\log P_{ow}$ -increments are known. The $\log P_{ow}$ of the whole molecule is then calculated as the sum of its corresponding fragment values plus the sum of correction terms for intramolecular interactions.

Lists of fragment constants and correction terms are available (b)(c)(d)(e). Some are regularly updated (b).

Quality criteria

In general, the reliability of the calculation method decreases with increasing complexity of the compound under study. In the case of simple molecules with low molecular weight and one or two functional groups, a deviation of 0,1 to 0,3 $\log P_{ow}$ units between the results of the different fragmentation methods and the measured value can be expected. In the case of more complex molecules the margin of error can be greater. This will depend on the reliability and availability of fragment constants, as well as on the ability to recognise intramolecular interactions (e.g. hydrogen bonds) and the correct use of the correction terms (less of a problem with the computer software CLOGP-3) (b). In the case of ionising compounds the correct consideration of the charge or degree of ionisation is important.

▼ B**Calculation procedures***Hansch π -method*

The original hydrophobic substituent constant, π , introduced by Fujira et al. (f) is defined as:

$$\pi_x = \log P_{ow}(\text{PhX}) - \log P_{ow}(\text{PhH})$$

where $P_{ow}(\text{PhX})$ is the partition coefficient of an aromatic derivative and $P_{ow}(\text{PhH})$ that of the parent compound

(e.g. $\pi_{\text{Cl}} = \log P_{ow}(\text{C}_6\text{H}_5\text{Cl}) - \log P_{ow}(\text{C}_6\text{H}_6) = 2,84 - 2,13 = 0,71$).

According to its definition the π -method is applicable predominantly for aromatic substitution. π -values for a large number of substituents have been tabulated (b)(c)(d). They are used for the calculation of $\log P_{ow}$ for aromatic molecules or substructures.

Rekker method

According to Rekker (g) the $\log P_{ow}$ value is calculated as follows:

$$\log P_{ow} = \sum_i a_i f_i + \sum_j (\text{interactive terms})$$

where f_i represents the different molecular fragment constants and a_i the frequency of their occurrence in the molecule under investigation. The correction terms can be expressed as an integral multiple of one single constant C_m (so-called magic constant). The fragment constants f_i and C_m were determined from a list of 1 054 experimental P_{ow} values (825 compounds) using multiple regression analysis (c)(h). The determination of the interaction terms is carried out according to set rules described in the literature (e)(h)(i).

Hansch-Leo method

According to Hansch and Leo (c), the $\log P_{ow}$ value is calculated from:

$$\log P_{ow} = \sum_i a_i f_i + \sum_j b_j F_j$$

where f_i represents the different molecular fragment constants, F_j the correction terms and a_i , b_j the corresponding frequencies of occurrence. Derived from experimental P_{ow} values, a list of atomic and group fragmental values and a list of correction terms F_j (so-called factors) were determined by trial and error. The correction terms have been ordered into several different classes (a)(c). It is relatively complicated and time consuming to take into account all the rules and correction terms. Software packages have been developed (b).

Combined method

The calculation of $\log P_{ow}$ of complex molecules can be considerably improved, if the molecule is dissected into larger substructures for which reliable $\log P_{ow}$ values are available, either from tables (b)(c) or from one's own measurements. Such fragments (e.g. heterocycles, anthraquinone, azobenzene) can then be combined with the Hansch π -values or with Rekker or Leo fragment constants.

Remarks

- (i) The calculation methods can only be applied to partly or fully ionised compounds when it is possible to take the necessary correction factors into account;

▼B

- (ii) if intramolecular hydrogen bonds can be assumed, the corresponding correction terms (approx. + 0,6 to + 1,0 log P_{ow} units) have to be added (a). Indications for the presence of such bonds can be obtained from stereo models or spectroscopic data of the molecule;
- (iii) If several tautomeric forms are possible, the most likely form should be used as the basis of the calculation;
- (iv) the revisions of lists of fragment constants should be followed carefully.

Report

When using calculation/estimation methods, the test report shall, if possible, include the following information:

- description of the substance (mixture, impurities, etc.),
- indication of any possible intramolecular hydrogen bonding, dissociation, charge and any other unusual effects (e.g. tautomerism),
- description of the calculation method,
- identification or supply of database,
- peculiarities in the choice of fragments,
- comprehensive documentation of the calculation.

LITERATURE

- (a) W.J. Lyman, W.F. Reehl and D.H. Rosenblatt (ed.), Handbook of Chemical Property Estimation Methods, McGraw-Hill, New York, 1983.
- (b) Pomona College, Medicinal Chemistry Project, Claremont, California 91711, USA, Log P Database and Med. Chem. Software (Program CLOGP-3).
- (c) C. Hansch, A.J. Leo, Substituent Constants for Correlation Analysis in Chemistry and Biology, John Wiley, New York, 1979.
- (d) A. Leo, C. Hansch, D. Elkins, Chem. Rev., 1971, vol. 71, p. 525.
- (e) R.F. Rekker, H.M. de Kort, Eur. J. Med. Chem. -Chill. Ther. 1979, vol. 14, p. 479.
- (f) T. Fujita, J. Iwasa and C. Hansch, J. Amer. Chem. Soc., 1964, vol. 86, p. 5175.
- (g) R.F. Rekker, The Hydrophobic Fragmental Constant, Pharmacology Library, Elsevier, New York, 1977, vol. 1.
- (h) C.V. Eadsforth, P. Moser, Chemosphere, 1983, vol. 12, p. 1459.
- (i) R.A. Scherrer, ACS, American Chemical Society, Washington D.C., 1984, Symposium Series 255, p. 225.

▼B

Appendix 2

Recommended Reference Substances for the HPLC Method

No	Reference Substance	log P _{ow}	pKa
1	2-Butanone	0,3	
2	4-Acetylpyridine	0,5	
3	Aniline	0,9	
4	Acetanilide	1,0	
5	Benzylalcohol	1,1	
6	p-Methoxyphenol	1,3	pKa = 10,26
7	Phenoxy acetic acid	1,4	pKa = 3,12
8	Phenol	1,5	pKa = 9,92
9	2,4-Dinitrophenol	1,5	pKa = 3,96
10	Benzonitrile	1,6	
11	Phenylacetoneitrile	1,6	
12	4-Methylbenzyl alcohol	1,6	
13	Acetophenone	1,7	
14	2-Nitrophenol	1,8	pKa = 7,17
15	3-Nitrobenzoic acid	1,8	pKa = 3,47
16	4-Chloraniline	1,8	pKa = 4,15
17	Nitrobenzene	1,9	
18	Cinnamic alcohol	1,9	
19	Benzoic acid	1,9	pKa = 4,19
20	p-Cresol	1,9	pKa = 10,17
21	Cinnamic acid	2,1	pKa = 3,89 cis 4,44 trans
22	Anisole	2,1	
23	Methylbenzoate	2,1	
24	Benzene	2,1	
25	3-Methylbenzoic acid	2,4	pKa = 4,27
26	4-Chlorophenol	2,4	pKa = 9,1
27	Trichloroethylene	2,4	
28	Atrazine	2,6	
29	Ethylbenzoate	2,6	
30	2,6-Dichlorobenzonitrile	2,6	
31	3-Chlorobenzoic acid	2,7	pKa = 3,82
32	Toluene	2,7	
33	1-Naphthol	2,7	pKa = 9,34
34	2,3-Dichloroaniline	2,8	
35	Chlorobenzene	2,8	
36	Allyl-phenylether	2,9	
37	Bromobenzene	3,0	

▼ B

No	Reference Substance	log P _{ow}	pKa
38	Ethylbenzene	3,2	
39	Benzophenone	3,2	
40	4-Phenylphenol	3,2	pKa = 9,54
41	Thymol	3,3	
42	1,4-Dichlorobenzene	3,4	
43	Diphenylamine	3,4	pKa = 0,79
44	Naphthalene	3,6	
45	Phenylbenzoate	3,6	
46	Isopropylbenzene	3,7	
47	2,4,6-Trichlorophenol	3,7	pKa = 6
48	Biphenyl	4,0	
49	Benzylbenzoate	4,0	
50	2,4-Dinitro-6 sec. butyophenol	4,1	
51	1,2,4-Trichlorobenzene	4,2	
52	Dodecanoic acid	4,2	
53	Diphenylether	4,2	
54	n-Butylbenzene	4,5	
55	Phenanthrene	4,5	
56	Fluoranthene	4,7	
57	Dibenzyl	4,8	
58	2,6-Diphenylpyridine	4,9	
59	Triphenylamine	5,7	
60	DDT	6,2	
Other reference substances of low log P _{ow}			
1	Nicotinic acid	- 0,07	

▼B**A.9. FLASH-POINT****1. METHOD****1.1. INTRODUCTION**

It is useful to have preliminary information on the flammability of the substance before performing this test. The test procedure is applicable to liquid substances whose vapours can be ignited by ignition sources. The test methods listed in this text are only reliable for flash-point ranges which are specified in the individual methods.

The possibility of chemical reactions between the substance and the sample holder should be considered when selecting the method to be used.

1.2. DEFINITIONS AND UNITS

The flash-point is the lowest temperature, corrected to a pressure of 101,325 kPa, at which a liquid evolves vapours, under the conditions defined in the test method, in such an amount that a flammable vapour/air mixture is produced in the test vessel.

Units: °C

$$t = T - 273,15$$

(t in °C and T in K)

1.3. REFERENCE SUBSTANCES

Reference substances do not need to be employed in all cases when investigating a new substance. They should primarily serve to check the performance of the method from time to time and to allow comparison with results from other methods.

1.4. PRINCIPLE OF THE METHOD

The substance is placed in a test vessel and heated or cooled to the test temperature according to the procedure described in the individual test method. Ignition trials are carried out in order to ascertain whether or not the sample flashed at the test temperature.

1.5. QUALITY CRITERIA**1.5.1. Repeatability**

The repeatability varies according to flash-point range and the test method used; maximum 2 °C.

1.5.2. Sensitivity

The sensitivity depends on the test method used.

1.5.3. Specificity

The specificity of some test methods is limited to certain flash-point ranges and subject to substance-related data (e.g. high viscosity).

▼ B

1.6. DESCRIPTION OF THE METHOD

1.6.1. **Preparations**

A sample of the test substance is placed in a test apparatus according to 1.6.3.1 and/or 1.6.3.2.

For safety, it is recommended that a method utilising a small sample size, circa 2 cm³, be used for energetic or toxic substances.

1.6.2. **Test conditions**

The apparatus should, as far as is consistent with safety, be placed in a draught-free position.

1.6.3. **Performance of the test**1.6.3.1. *Equilibrium method*

See ISO 1516, ISO 3680, ISO 1523, ISO 3679.

1.6.3.2. *Non-equilibrium method*

Abel apparatus:

See BS 2000 part 170, NF M07-011, NF T66-009.

Abel-Pensky apparatus:

See EN 57, DIN 51755 part 1 (for temperatures from 5 to 65 °C), DIN 51755 part 2 (for temperatures below 5 °C), NF M07-036.

Tag apparatus:

See ASTM D 56.

Pensky-Martens apparatus:

See ISO 2719, EN 11, DIN 51758, ASTM D 93, BS 2000-34, NF M07-019.

Remarks:

When the flash-point, determined by a non-equilibrium method in 1.6.3.2, is found to be 0 ± 2 °C, 21 ± 2 °C or 55 ± 2 °C, it should be confirmed by an equilibrium method using the same apparatus.

Only the methods which can give the temperature of the flash-point may be used for a notification.

To determine the flash-point of viscous liquids (paints, gums and similar) containing solvents, only apparatus and test methods suitable for determining the flash-point of viscous liquids may be used.

See ISO 3679, ISO 3680, ISO 1523, DIN 53213 part 1.

▼B2. **DATA**3. **REPORTING**

The test report shall, if possible, include the following information:

- the precise specification of the substance (identification and impurities),
- the method used should be stated as well as any possible deviations,
- the results and any additional remarks relevant for the interpretation of results.

4. **REFERENCES**

None.

▼B**A.10. FLAMMABILITY (SOLIDS)****1. METHOD****1.1. INTRODUCTION**

It is useful to have preliminary information on potentially explosive properties of the substance before performing this test.

This test should only be applied to powdery, granular or paste-like substances.

In order not to include all substances which can be ignited but only those which burn rapidly or those whose burning behaviour is in any way especially dangerous, only substances whose burning velocity exceeds a certain limiting value are considered to be highly flammable.

It can be especially dangerous if incandescence propagates through a metal powder because of the difficulties in extinguishing a fire. Metal powders should be considered highly flammable if they support spread of incandescence throughout the mass within a specified time.

1.2. DEFINITION AND UNITS

Burning time expressed in seconds.

1.3. REFERENCE SUBSTANCES

Not specified.

1.4. PRINCIPLE OF THE METHOD

The substance is formed into an unbroken strip or powder train about 250 mm long and a preliminary screening test performed to determine if, on ignition by a gas flame, propagation by burning with flame or smouldering occurs. If propagation over 200 mm of the train occurs within a specified time then a full test programme to determine the burning rate is carried out.

1.5. QUALITY CRITERIA

Not stated.

▼B

1.6. DESCRIPTION OF METHOD

1.6.1. **Preliminary screening test**

The substance is formed into an unbroken strip or powder train about 250 mm long by 20 mm wide by 10 mm high on a non-combustible, non-porous and low heat-conducting base plate. A hot flame from a gas burner (minimum diameter 5 mm) is applied to one end of the powder train until the powder ignites or for a maximum of two minutes (five minutes for powders of metals or metal-alloys). It should be noted whether combustion propagates along 200 mm of the train within the 4 minutes test period (or 40 minutes for metal powders). If the substance does not ignite and propagate combustion either by burning with flame or smouldering along 200 mm of the powder train within the four minutes (or 40 minutes) test period, then the substance should not be considered as highly flammable and no further testing is required. If the substance propagates burning of a 200 mm length of the powder train in less than four minutes, or less than 40 minutes for metal powders, the procedure described below (point 1.6.2. and following) should be carried out.

1.6.2. **Burning rate test**1.6.2.1. *Preparation*

Powdery or granular substances are loosely filled into a mould 250 mm long with a triangular cross-section of inner height 10 mm and width 20 mm. On both sides of the mould in a longitudinal direction two metal plates are mounted as lateral limitations which project 2 mm beyond the upper edge of the triangular cross section (figure). The mould is then dropped three times from a height of 2 cm onto a solid surface. If necessary the mould is then filled up again. The lateral limitations are then removed and the excess substance scraped off. A non-combustible, non-porous and low heat-conducting base plate is placed on top of the mould, the apparatus inverted and the mould removed.

Paste-like substances are spread on a non-combustible, non-porous and low heat-conducting base plate in the form of a rope 250 mm in length with a cross section of about 1 cm².

1.6.2.2. *Test conditions*

In the case a moisture-sensitive substance, the test should be carried out as quickly as possible after its removal from the container.

1.6.2.3. *Performance of the test*

Arrange the pile across the draught in a fume cupboard.

The air-speed should be sufficient to prevent fumes escaping into the laboratory and should not be varied during the test. A draught screen should be erected around the apparatus.

A hot flame from a gas burner (minimum diameter of 5 mm) is used to ignite the pile at one end. When the pile has burned a distance of 80 mm, the rate of burning over the next 100 mm is measured.

▼B

The test is performed six times, using a clean cool plate each time, unless a positive result is observed earlier.

2. DATA

The burning time from the preliminary screening test (1.6.1) and the shortest burning time in up to six tests (1.6.2.3) are relevant for evaluation.

3. REPORTING**3.1. TEST REPORT**

The test report shall, if possible, include the following information:

- the precise specification of the substance (identification and impurities),
- a description of the substance to be tested, its physical state including moisture content,
- results from the preliminary screening test and from the burning rate test if performed,
- all additional remarks relevant to the interpretation of results.

3.2. INTERPRETATION OF THE RESULT

Powdery, granular or paste-like substances are to be considered as highly flammable when the time of burning in any tests carried out according to the test procedure described in 1.6.2 is less than 45 seconds. Powders of metals or metal-alloys are considered to be highly flammable when they can be ignited and the flame or the zone of reaction spreads over the whole sample in 10 minutes or less.

4. REFERENCES

NF T 20-042 (September 85) Chemical products for industrial use. Determination of the flammability of solids.

▼B

Appendix

Figure

Mould and accessories for the preparation of the pile

(All dimensions in millimetres)

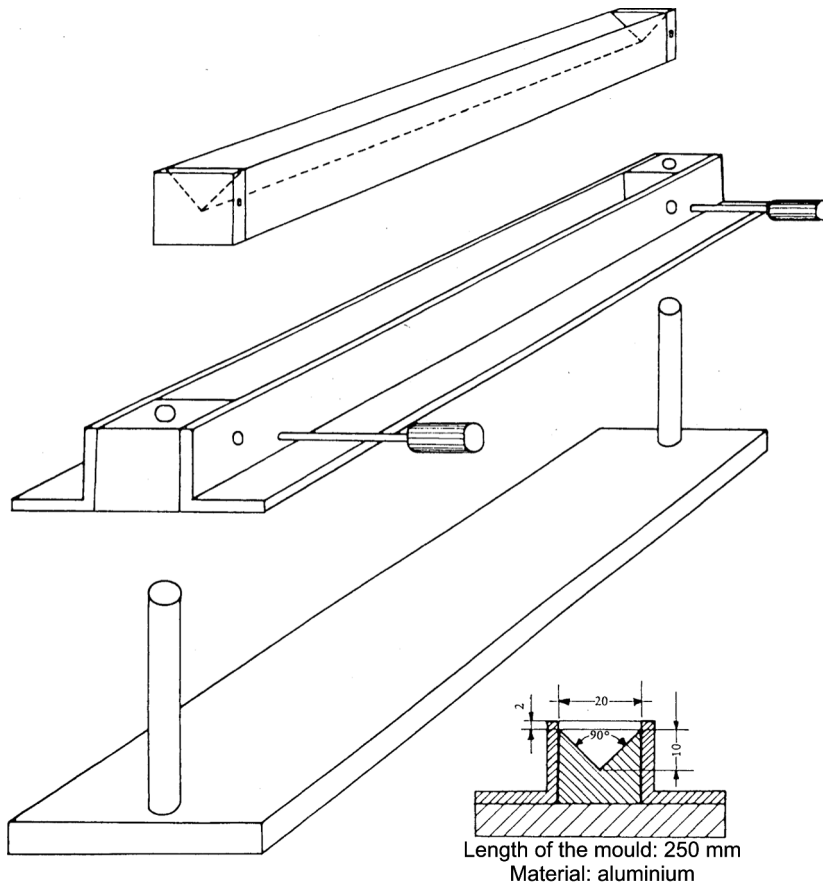

▼B**A.11. FLAMMABILITY (GASES)****1. METHOD****1.1. INTRODUCTION**

This method allows a determination of whether gases mixed with air at room temperature (circa 20 °C) and atmospheric pressure are flammable and, if so, over what range of concentrations. Mixtures of increasing concentrations of the test gas with air are exposed to an electrical spark and it is observed whether ignition occurs.

1.2. DEFINITION AND UNITS

The range of flammability is the range of concentration between the lower and the upper explosion limits. The lower and the upper explosion limits are those limits of concentration of the flammable gas in admixture with air at which propagation of a flame does not occur.

1.3. REFERENCE SUBSTANCES

Not specified.

1.4. PRINCIPLE OF THE METHOD

The concentration of gas in air is increased step by step and the mixture is exposed at each stage to an electrical spark.

1.5. QUALITY CRITERIA

Not stated.

1.6. DESCRIPTION OF THE METHOD**1.6.1. Apparatus**

The test vessel is an upright glass cylinder having a minimum inner diameter of 50 mm and a minimum height of 300 mm. The ignition electrodes are separated by a distance of 3 to 5 mm and are placed 60 mm above the bottom of the cylinder. The cylinder is fitted with a pressure-release opening. The apparatus has to be shielded to restrict any explosion damage.

A standing induction spark of 0,5 sec. duration, which is generated from a high voltage transformer with an output voltage of 10 to 15 kV (maximum of power input 300 W), is used as the ignition source. An example of a suitable apparatus is described in reference (2).

1.6.2. Test conditions

The test must be performed at room temperature (circa 20 °C).

▼ B**1.6.3. Performance of the test**

Using proportioning pumps, a known concentration of gas in air is introduced into the glass cylinder. A spark is passed through the mixture and it is observed whether or not a flame detaches itself from the ignition source and propagates independently. The gas concentration is varied in steps of 1 % vol. until ignition occurs as described above.

If the chemical structure of the gas indicates that it would be non-flammable and the composition of the stoichiometric mixture with air can be calculated, then only mixtures in the range from 10 % less than the stoichiometric composition to 10 % greater than this composition need be tested in 1 % steps.

2. DATA

The occurrence of flame propagation is the only relevant information data for the determination of this property.

3. REPORTING

The test report shall, if possible, include the following information:

- the precise specification of the substance (identification and impurities),
- a description, with dimensions, of the apparatus used,
- the temperature at which the test was performed,
- the tested concentrations and the results obtained,
- the result of the test: non-flammable gas or highly flammable gas,
- if it is concluded that the gas is non-flammable then the concentration range over which it was tested in 1 % steps should be stated,
- all information and remarks relevant to the interpretation of results have to be reported.

4. REFERENCES

- (1) NF T 20-041 (September 85) Chemical products for industrial use. Determination of the flammability of gases.
- (2) W. Berthold, D. Conrad, T. Grewer, H. Grosse-Wortmann 'Entwicklung einer Standard-Apparatur zur Messung von Explosionsgrenzen'. Chem.-Ing.- Tech. 1984, vol. 56, 2, 126-127., T. Redeker und H. Schacke, p. 126-127.

▼B**A.12. FLAMMABILITY (CONTACT WITH WATER)****1. METHOD****1.1. INTRODUCTION**

This test method can be used to determine whether the reaction of a substance with water or damp air leads to the development of dangerous amounts of gas or gases which may be highly flammable.

The test method can be applied to both solid and liquid substances. This method is not applicable to substances which spontaneously ignite when in contact with air.

1.2. DEFINITIONS AND UNITS

Highly flammable: substances which, in contact with water or damp air, evolve highly flammable gases in dangerous quantities at a minimum rate of 1 litre/kg per hour.

1.3. PRINCIPLE OF THE METHOD

The substance is tested according to the step by step sequence described below; if ignition occurs at any step, no further testing is necessary. If it is known that the substance does not react violently with water then proceed to step 4 (1.3.4).

1.3.1. Step 1

The test substance is placed in a trough containing distilled water at 20 °C and it is noted whether or not the evolved gas ignites.

1.3.2. Step 2

The test substance is placed on a filter paper floating on the surface of a dish containing distilled water at 20 °C and it is noted whether or not the evolved gas ignites. The filter paper is merely to keep the substance in one place to increase the chances of ignition.

1.3.3. Step 3

The test substance is made into a pile approximately 2 cm high and 3 cm diameter. A few drops of water are added to the pile and it is noted whether or not the evolved gas ignites.

1.3.4. Step 4

The test substance is mixed with distilled water at 20 °C and the rate of evolution of gas is measured over a period of seven hours, at one-hour intervals. If the rate of evolution is erratic, or is increasing, after seven hours, the measuring time should be extended to a maximum time of five days. The test may be stopped if the rate at any time exceeds 1 litre/kg per hour.

▼ B

1.4. REFERENCE SUBSTANCES

Not specified.

1.5. QUALITY CRITERIA

Not stated.

1.6. DESCRIPTION OF METHODS

1.6.1. **Step 1**1.6.1.1. *Test conditions*

The test is performed at room temperature (circa 20 °C).

1.6.1.2. *Performance of the test*

A small quantity (approximately 2 mm diameter) of the test substance should be placed in a trough containing distilled water. A note should be made of whether (i) any gas is evolved and (ii) if ignition of the gas occurs. If ignition of the gas occurs then no further testing of the substance is needed because the substance is regarded as hazardous.

1.6.2. **Step 2**1.6.2.1. *Apparatus*

A filter-paper is floated flat on the surface of distilled water in any suitable vessel, e.g. a 100 mm diameter evaporating dish.

1.6.2.2. *Test conditions*

The test is performed at room temperature (circa 20 °C).

1.6.2.3. *Performance of the test*

A small quantity of the test substance (approximately 2 mm diameter) is placed onto the centre of the filter-paper. A note should be made of whether (i) any gas is evolved and (ii) if ignition of the gas occurs. If ignition of the gas occurs then no further testing of the substance is needed because the substance is regarded as hazardous.

1.6.3. **Step 3**1.6.3.1. *Test conditions*

The test is performed at room temperature (circa 20 °C).

1.6.3.2. *Performance of the test*

The test substance is made into a pile approximately 2 cm high and 3 cm diameter with an indentation in the top. A few drops of water are added to the hollow and a note is made of whether (i) any gas is evolved and (ii) if ignition of the gas occurs. If ignition of the gas occurs then no further testing of the substance is needed because the substance is regarded as hazardous.

▼ B1.6.4. **Step 4**1.6.4.1. *Apparatus*

The apparatus is set up as shown in the figure.

1.6.4.2. *Test conditions*

Inspect the container of the test substance for any powder < 500 µm (particle size). If the powder constitutes more than 1 % w/w of the total, or if the sample is friable, then the whole of the substance should be ground to a powder before testing to allow for a reduction in particle size during storage and handling; otherwise the substance is to be tested as received. The test should be performed at room temperature (circa 20 °C) and atmospheric pressure.

1.6.4.3. *Performance of the test*

10 to 20 ml of water are put into the dropping funnel of the apparatus and 10 g of substance are put in the conical flask. The volume of gas evolved can be measured by any suitable means. The tap of the dropping funnel is opened to let the water into the conical flask and a stop watch is started. The gas evolution is measured each hour during a seven hour period. If, during this period, the gas evolution is erratic, or if, at the end of this period, the rate of gas evolution is increasing, then measurements should be continued for up to five days. If, at any time of measurement, the rate of gas evolution exceeds 1 litre/kg per hour, the test can be discontinued. This test should be performed in triplicate.

If the chemical identity of the gas is unknown, the gas should be analysed. When the gas contains highly flammable components and it is unknown whether the whole mixture is highly flammable, a mixture of the same composition has to be prepared and tested according to the method A.11.

2. **DATA**

The substance is considered hazardous if:

— spontaneous ignition takes place in any step of the test procedure,

or

— there is evolution of flammable gas at a rate greater than 1 litre/kg of the substance per hour.

3. **REPORTING**

The test report shall, if possible, include the following information:

— the precise specification of the substance (identification and impurities),

— details of any initial preparation of the test substance,

▼B

- the results of the tests (steps 1, 2, 3 and 4),
- the chemical identity of gas evolved,
- the rate of evolution of gas if step 4 (1.6.4) is performed,
- any additional remarks relevant to the interpretation of the results.

4. REFERENCES

- (1) Recommendations on the transport of dangerous goods, test and criteria, 1990, United Nations, New York.
- (2) NF T 20-040 (September 85) Chemical products for industrial use. Determination of the flammability of gases formed by the hydrolysis of solid and liquid products.

▼ B

Appendix

Figure

Apparatus

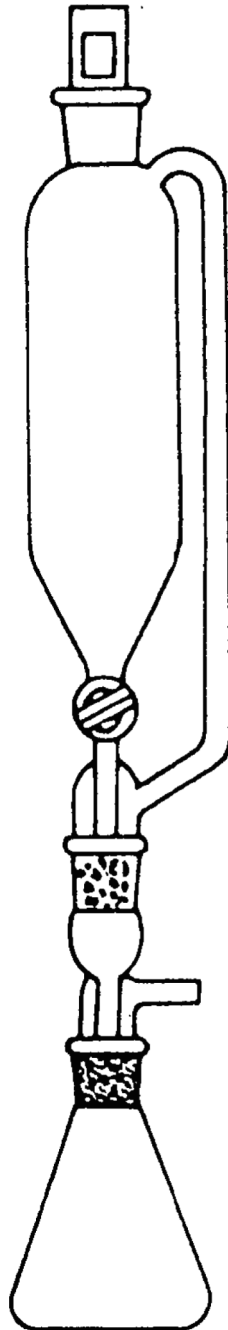

▼ B**A.13. PYROPHORIC PROPERTIES OF SOLIDS AND LIQUIDS****1. METHOD****1.1. INTRODUCTION**

The test procedure is applicable to solid or liquid substances, which, in small amounts, will ignite spontaneously a short time after coming into contact with air at room temperature (circa 20 °C).

Substances which need to be exposed to air for hours or days at room temperature or at elevated temperatures before ignition occurs are not covered by this test method.

1.2. DEFINITIONS AND UNITS

Substances are considered to have pyrophoric properties if they ignite or cause charring under the conditions described in 1.6.

The auto-flammability of liquids may also need to be tested using method A.15. Auto-ignition temperature (liquids and gases).

1.3. REFERENCE SUBSTANCES

Not specified.

1.4. PRINCIPLE OF THE METHOD

The substance, whether solid or liquid, is added to an inert carrier and brought into contact with air at ambient temperature for a period of five minutes. If liquid substances do not ignite then they are absorbed onto filter paper and exposed to air at ambient temperature (circa 20 °C) for five minutes. If a solid or liquid ignites, or a liquid ignites or chars a filter paper, then the substance is considered to be pyrophoric.

1.5. QUALITY CRITERIA

Repeatability: because of the importance in relation to safety, a single positive result is sufficient for the substance to be considered pyrophoric.

1.6. DESCRIPTION OF THE TEST METHOD**1.6.1. Apparatus**

A porcelain cup of circa 10 cm diameter is filled with diatomaceous earth to a height of about 5 mm at room temperature (circa 20 °C).

Note:

Diatomaceous earth or any other comparable inert substance which is generally obtainable shall be taken as representative of soil onto which the test substance might be spilled in the event of an accident.

Dry filter paper is required for testing liquids which do not ignite on contact with air when in contact with an inert carrier.

▼B**1.6.2. Performance of the test****(a) Powdery solids**

1 to 2 cm³ of the substance to be tested is poured from circa 1 m height onto a non-combustible surface and it is observed whether the substance ignites during dropping or within five minutes of settling.

The test is performed six times unless ignition occurs;

(b) liquids

Circa 5 cm³ of the liquid to be tested is poured into the prepared porcelain cup and it is observed whether the substance ignites within five minutes.

If no ignition occurs in the six tests, perform the following tests:

A 0,5 ml test sample is delivered from a syringe to an indented filter paper and it is observed whether ignition or charring of the filter paper occurs within five minutes of the liquid being added. The test is performed three times unless ignition or charring occurs.

2. DATA**2.1. TREATMENT OF RESULTS**

Testing can be discontinued as soon as a positive result occurs in any of the tests.

2.2. EVALUATION

If the substance ignites within five minutes when added to an inert carrier and exposed to air, or a liquid substance chars or ignites a filter paper within five minutes when added and exposed to air, it is considered to be pyrophoric.

3. REPORTING

The test report shall, if possible, include the following information:

- the precise specification of the substance (identification and impurities),
- the results of the tests,
- any additional remark relevant to the interpretation of the results.

4. REFERENCES

- (1) NF T 20-039 (September 85) Chemical products for industrial use. Determination of the spontaneous flammability of solids and liquids.
- (2) Recommendations on the Transport of Dangerous Goods, Test and criteria, 1990, United Nations, New York.

▼B**A.14. EXPLOSIVE PROPERTIES****1. METHOD****1.1. INTRODUCTION**

The method provides a scheme of testing to determine whether a solid or a pasty substance presents a danger of explosion when submitted to the effect of a flame (thermal sensitivity), or to shock or friction (sensitivity to mechanical stimuli), and whether a liquid substance presents a danger of explosion when submitted to the effect of a flame or shock.

The method comprises three parts:

- (a) a test of thermal sensitivity (1);
- (b) a test of mechanical sensitivity with respect to shock (1);
- (c) a test of mechanical sensitivity with respect to friction (1).

The method yields data to assess the likelihood of initiating an explosion by means of certain common stimuli. The method is not intended to ascertain whether a substance is capable of exploding under any conditions.

The method is appropriate for determining whether a substance will present a danger of explosion (thermal and mechanical sensitivity) under the particular conditions specified in the directive. It is based on a number of types of apparatus which are widely used internationally (1) and which usually give meaningful results. It is recognised that the method is not definitive. Alternative apparatus to that specified may be used provided that it is internationally recognised and the results can be adequately correlated with those from the specified apparatus.

The tests need not be performed when available thermodynamic information (e.g. heat of formation, heat of decomposition) and/or absence of certain reactive groups (2) in the structural formula establishes beyond reasonable doubt that the substance is incapable of rapid decomposition with evolution of gases or release of heat (i.e. the material does not present any risk of explosion). A test of mechanical sensitivity with respect to friction is not required for liquids.

1.2. DEFINITIONS AND UNITS

Explosive:

Substances which may explode under the effect of flame or which are sensitive to shock or friction in the specified apparatus (or are more mechanically sensitive than 1,3-dinitrobenzene in alternative apparatus).

1.3. REFERENCE SUBSTANCES

1,3-dinitrobenzene, technical crystalline product sieved to pass 0,5 mm, for the friction and shock methods.

Perhydro-1,3,5-trinitro-1,3,5-triazine (RDX, hexogen, cyclonite — CAS 121-82-4), recrystallised from aqueous cyclohexanone, wet-sieved through a 250 µm and retained on a 150 µm sieve and dried at 103 ± 2 °C (for four hours) for the second series of friction and shock tests.

▼ B

1.4. PRINCIPLE OF THE METHOD

Preliminary tests are necessary to establish safe conditions for the performance of the three tests of sensitivity.

1.4.1. **Safety-in-handling tests (3)**

For safety reasons, before performing the main tests, very small samples (circa 10 mg) of the substance are subjected to heating without confinement in a gas flame, to shock in any convenient form of apparatus and to friction by the use of a mallet against an anvil or any form of friction machine. The objective is to ascertain if the substance is so sensitive and explosive that the prescribed sensitivity tests, particularly that of thermal sensitivity, should be performed with special precautions so as to avoid injury to the operator.

1.4.2. **Thermal sensitivity**

The method involves heating the substance in a steel tube, closed by orifice plates with differing diameters of hole, to determine whether the substance is liable to explode under conditions of intense heat and defined confinement.

1.4.3. **Mechanical sensitivity (shock)**

The method involves subjecting the substance to the shock from a specified mass dropped from a specified height.

1.4.4. **Mechanical sensitivity (friction)**

The method involves subjecting solid or pasty substances to friction between standard surfaces under specified conditions of load and relative motion.

1.5. QUALITY CRITERIA

Not stated.

1.6. DESCRIPTION OF METHOD

1.6.1. **Thermal sensitivity (effect of a flame)**1.6.1.1. *Apparatus*

The apparatus consists of a non-reusable steel tube with its re-usable closing device (figure 1), installed in a heating and protective device. Each tube is deep-drawn from sheet steel (see Appendix) and has an internal diameter of 24 mm, a length of 75 mm and wall thickness of 0,5 mm. The tubes are flanged at the open end to enable them to be closed by the orifice plate assembly. This consists of a pressure-resistant orifice plate, with a central hole, secured firmly to a tube using a two-part screw joint (nut and threaded collar). The nut and threaded collar are made from chromium-manganese steel (see Appendix) which is spark-free up to 800 °C. The orifice plates are 6 mm thick, made from heat-resistant steel (see Appendix), and are available with a range of diameters of opening.

▼ B1.6.1.2. *Test conditions*

Normally the substance is tested as received although in certain cases, e.g. if pressed, cast or otherwise condensed, it may be necessary to test the substance after crushing.

For solids, the mass of material to be used in each test is determined using a two-stage dry run procedure. A tared tube is filled with 9 cm³ of substance and the substance tamped with 80 N force applied to the total cross-section of the tube. For reasons of safety or in cases where the physical form of the sample can be changed by compression other filling procedures may be used; e.g. if the substance is very friction sensitive then tamping is not appropriate. If the material is compressible then more is added and tamped until the tube is filled to 55 mm from the top. The total mass used to fill the tube to the 55 mm level is determined and two further increments, each tamped with 80 N force, are added. Material is then either added with tamping, or taken out, as required, to leave the tube filled to a level 15 mm from the top. A second dry run is performed, starting with a tamped quantity of a third of the total mass found in the first dry run. Two more of these increments are added with 80 N tamping and the level of the substance in the tube adjusted to 15 mm from the top by addition or subtraction of material as required. The amount of solid determined in the second dry run is used for each trial; filling being performed in three equal amounts, each compressed to 9 cm³ by whatever force is necessary. (This may be facilitated by the use of spacing rings).

Liquids and gels are loaded into the tube to a height of 60 mm taking particular care with gels to prevent the formation of voids. The threaded collar is slipped onto the tube from below, the appropriate orifice plate is inserted and the nut tightened after applying some molybdenum disulphide based lubricant. It is essential to check that none of the substance is trapped between the flange and the plate, or in the threads.

Heating is provided by propane taken from an industrial cylinder, fitted with a pressure regulator (60 to 70 mbar), through a meter and evenly distributed (as indicated by visual observation of the flames from the burners) by a manifold to four burners. The burners are located around the test chamber as shown in figure 1. The four burners have a combined consumption of about 3,2 litres of propane per minute. Alternative fuel gases and burners may be used but the heating rate must be as specified in figure 3. For all apparatus, the heating rate must be checked periodically using tubes filled with dibutyl phthalate as indicated in figure 3.

1.6.1.3. *Performance of the tests*

Each test is performed until either the tube is fragmented or the tube has been heated for five minutes. A test resulting in the fragmentation of the tube into three or more pieces, which in some cases may be connected to each other by narrow strips of metal as illustrated in figure 2, is evaluated as giving an explosion. A test resulting in fewer fragments or no fragmentation is regarded as not giving an explosion.

▼ B

A series of three tests with a 6,0 mm diameter orifice plate is first performed and, if no explosions are obtained, a second series of three tests is performed with a 2,0 mm diameter orifice plate. If an explosion occurs during either test series then no further tests are required.

1.6.1.4. Evaluation

The test result is considered positive if an explosion occurs in either of the above series of tests.

1.6.2. Mechanical sensitivity (shock)**1.6.2.1. Apparatus (figure 4)**

The essential parts of a typical fall hammer apparatus are a cast steel block with base, anvil, column, guides, drop weights, release device and a sample holder. The steel anvil 100 mm (diameter) × 70 mm (height) is screwed to the top of a steel block 230 mm (length) × 250 mm (width) × 200 mm (height) with a cast base 450 mm (length) × 450 mm (width) × 60 mm (height). A column, made from seamless drawn steel tube, is secured in a holder screwed on to the back of the steel block. Four screws anchor the apparatus to a solid concrete block 60 × 60 × 60 cm such that the guide rails are absolutely vertical and the drop weight falls freely. 5 and 10 kg weights, made from solid steel, are available for use. The striking head of each weight is of hardened steel, HRC 60 to 63, and has a minimum diameter of 25 mm.

The sample under test is enclosed in a shock device consisting of two coaxial solid steel cylinders, one above the other, in a hollow cylindrical steel guide ring. The solid steel cylinders should be of 10 (- 0,003, - 0,005) mm diameter and 10 mm height and have polished surfaces, rounded edges (radius of curvature 0,5 mm) and a hardness of HRC 58 to 65. The hollow cylinder must have an external diameter of 16 mm, a polished bore of 10 (+ 0,005, + 0,010) mm and a height of 13 mm. The shock device is assembled on an intermediate anvil (26 mm diameter and 26 mm height) made of steel and centred by a ring with perforations to allow escape of fumes.

1.6.2.2. Test conditions

The sample volume should be 40 mm³, or a volume to suit any alternative apparatus. Solid substances should be tested in the dry state and prepared as follows:

- (a) powdered substances are sieved (sieve size 0,5 mm); all that has passed through the sieve is used for testing;
- (b) pressed, cast or otherwise condensed substances are broken into small pieces and sieved; the sieve fraction from 0,5 to 1 mm diameter is used for testing and should be representative of the original substance.

Substances normally supplied as pastes should be tested in the dry state where possible or, in any case, following removal of the maximum possible amount of diluent. Liquid substances are tested with a 1 mm gap between the upper and lower steel cylinders.

▼ B1.6.2.3. *Performance of the tests*

A series of six tests are performed dropping the 10 kg mass from 0,40 m (40 J). If an explosion is obtained during the six tests at 40 J, a further series of six tests, dropping a 5 kg mass from 0,15 m (7,5 J), must be performed. In other apparatus, the sample is compared with the chosen reference substance using an established procedure (e.g. up-and-down technique etc.).

1.6.2.4. *Evaluation*

The test result is considered positive if an explosion (bursting into flame and/or a report is equivalent to explosion) occurs at least once in any of the tests with the specified shock apparatus or the sample is more sensitive than 1,3-dinitrobenzene or RDX in an alternative shock test.

1.6.3. **Mechanical sensitivity (friction)**1.6.3.1. *Apparatus (figure 5)*

The friction apparatus consists of a cast steel base plate on which is mounted the friction device. This consists of a fixed porcelain peg and moving porcelain plate. The porcelain plate is held in a carriage which runs in two guides. The carriage is connected to an electric motor via a connecting rod, an eccentric cam and suitable gearing such that the porcelain plate is moved, once only, back and forth beneath the porcelain peg for a distance of 10 mm. The porcelain peg may be loaded with, for example, 120 or 360 newtons.

The flat porcelain plates are made from white technical porcelain (roughness 9 to 32 μm) and have the dimensions 25 mm (length) \times 25 mm (width) \times 5 mm (height). The cylindrical porcelain peg is also made of white technical porcelain and is 15 mm long, has a diameter of 10 mm and roughened spherical end surfaces with a radius of curvature of 10 mm.

1.6.3.2. *Test conditions*

The sample volume should be 10 mm³ or a volume to suit any alternative apparatus.

Solid substances are tested in the dry state and prepared as follows:

- (a) powdered substances are sieved (sieve size 0,5 mm); all that has passed through the sieve is used for testing;
- (b) pressed, cast or otherwise condensed substances are broken into small pieces and sieved; the sieve fraction $<$ 0,5 mm diameter is used for testing.

Substances normally supplied as pastes should be tested in the dry state where possible. If the substance cannot be prepared in the dry state, the paste (following removal of the maximum possible amount of diluent) is tested as a 0,5 mm thick, 2 mm wide, 10 mm long film, prepared with a former.

▼ B1.6.3.3. *Performance of the tests*

The porcelain peg is brought onto the sample under test and the load applied. When carrying out the test, the sponge marks of the porcelain plate must lie transversely to the direction of the movement. Care must be taken that the peg rests on the sample, that sufficient test material lies under the peg and also that the plate moves correctly under the peg. For pasty substances, a 0,5 mm thick gauge with a 2×10 mm slot is used to apply the substance to the plate. The porcelain plate has to move 10 mm forwards and backwards under the porcelain peg in a time of 0,44 seconds. Each part of the surface of the plate and peg must only be used once; the two ends of each peg will serve for two trials and the two surfaces of a plate will each serve for three trials.

A series of six tests are performed with a 360 N loading. If a positive event is obtained during these six tests, a further series of six tests must be performed with a 120 N loading. In other apparatus, the sample is compared with the chosen reference substance using an established procedure (e.g. up-and-down technique, etc.).

1.6.3.4. *Evaluation*

The test result is considered positive if an explosion (crepitation and/or a report or bursting into flame are equivalent to explosion) occurs at least once in any of the tests with the specified friction apparatus or satisfies the equivalent criteria in an alternative friction test.

2. **DATA**

In principle, a substance is considered to present a danger of explosion in the sense of the directive if a positive result is obtained in the thermal, shock or friction sensitivity test.

3. **REPORTING**3.1. **TEST REPORT**

The test report shall, if possible, include the following information:

- identity, composition, purity, moisture content, etc. of the substance tested,
- the physical form of the sample and whether or not it has been crushed, broken and/or sieved,
- observations during the thermal sensitivity tests (e.g. sample mass, number of fragments, etc.),
- observations during the mechanical sensitivity tests (e.g. formation of considerable amounts of smoke or complete decomposition without a report, flames, sparks, report, crepitation, etc.),
- results of each type of test,
- if alternative apparatus has been used, scientific justification as well as evidence of correlation between results obtained with specified apparatus and those obtained with equivalent apparatus must be given,

▼B

- any useful comments such as reference to tests with similar products which might be relevant to a proper interpretation of the results,
- all additional remarks relevant for the interpretation of the results.

3.2. INTERPRETATION AND EVALUATION OF RESULTS

The test report should mention any results which are considered false, anomalous or unrepresentative. If any of the results should be discounted, an explanation and the results of any alternative or supplementary testing should be given. Unless an anomalous result can be explained, it must be accepted at face value and used to classify the substance accordingly.

4. REFERENCES

- (1) Recommendations on the Transport of Dangerous Goods: Tests and criteria, 1990, United Nations, New York.
- (2) Bretherick, L., Handbook of Reactive Chemical Hazards, 4th edition, Butterworths, London, ISBN 0-750-60103-5, 1990.
- (3) Koenen, H., Ide, K.H. and Swart, K.H., Explosivstoffe, 1961, vol. 3, 6-13 and 30-42.
- (4) NF T 20-038 (September 85) Chemical products for industrial use — Determination of explosion risk.

▼ **B**

Appendix

Example of material specification for thermal sensitivity test (see DIN 1623)

- (1) Tube: Material specification No 1.0336.505 g
- (2) Orifice plate: Material specification No 1.4873
- (3) Threaded collar and nut: Material specification No 1.3817

Figure 1

Thermal sensitivity test apparatus

(all dimensions in millimetres)

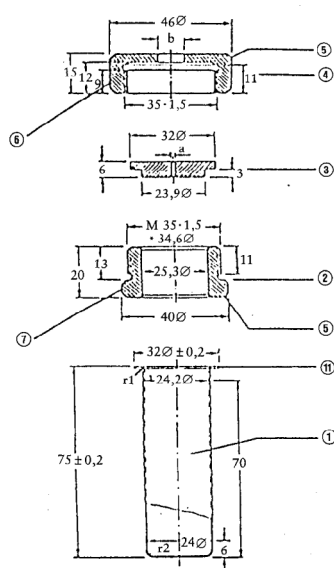

Fig. 1a Steel tube and accessories

- (1) tube
- (1a) outer flange
- (2) threaded collar; low-friction thread
- (3) orifice plate $a = 2,0$ or $6,0$ mm diameter
- (4) nut $b = 10$ mm diameter
- (5) chamfered surface
- (6) 2 flat for spanner size 41

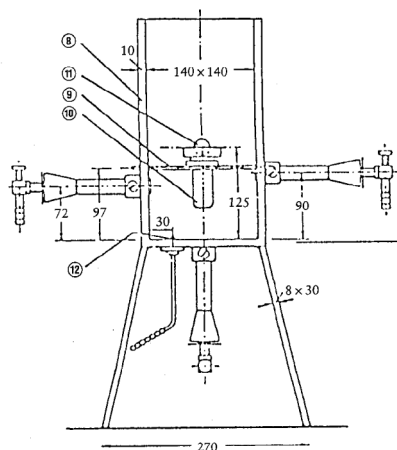

Fig. 1b Heating and protective device

- (7) 2 flat for spanner size 36
- (8) splinter-proof box
- (9) 2 supporting rods for tube
- (10) assembled tube
- (11) position for rear burner; the other burners are visible
- (12) pilot jet

▼B

Figure 2

Thermal sensitivity test

(example of fragmentation)

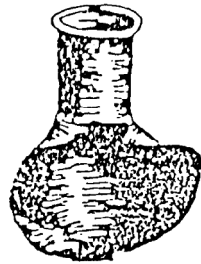

No explosion



No explosion



Explosion



Explosion



Explosion

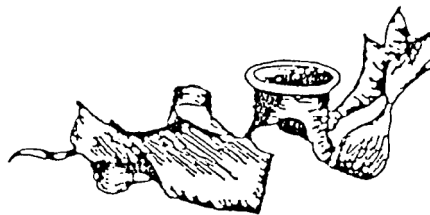

Explosion

▼B

Figure 3

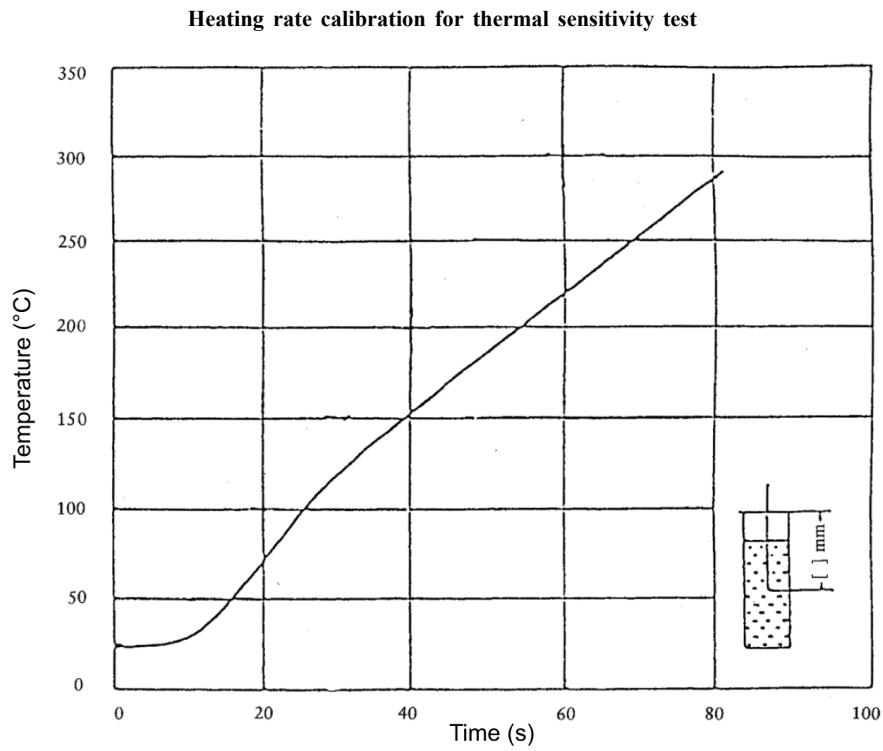

Temperature/time curve obtained on heating dibutyl phtalate (27 cm^3) in a closed (1,5 mm orifice plate) tube using a propane flow rate of 3,2 litre/minute. The temperature is measured with a 1 mm diameter stainless steel sheathed chromel/alumel thermocouple, placed centrally 43 mm below the rim of the tube. The heating rate between 135 °C and 285 °C should be between 185 and 215 K/minute.

▼B

Figure 4

Shock test apparatus

(all dimensions in millimetres)

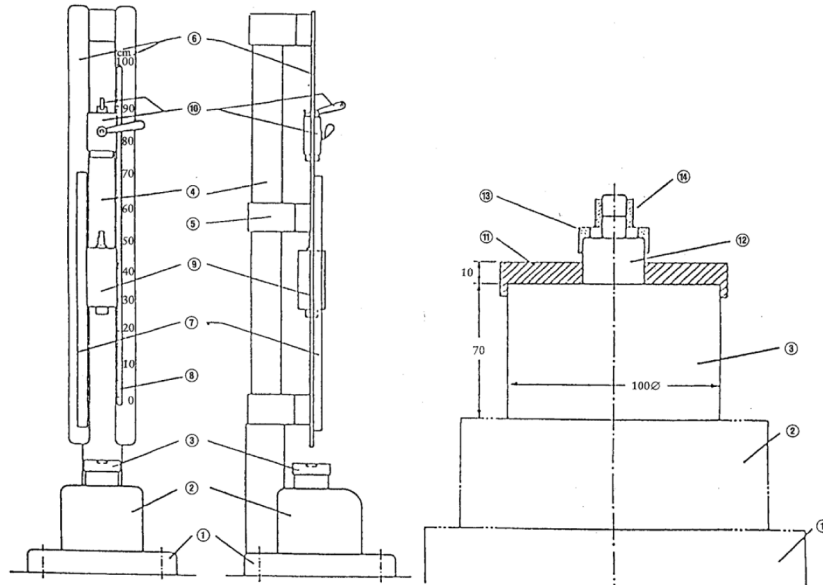

Fig. 4a Fall-hammer, front and side, general view

- (1) base, 450 x 450 x 60
- (2) steel block, 230 x 250 x 200
- (3) anvil, 100 diameter x 70
- (4) column
- (5) median cross-member
- (6) 2 guides
- (7) toothed rack

Fig. 4b Fall-hammer, lower part

- (8) graduated scale
- (9) fall-hammer (drop mass)
- (10) holding and releasing device
- (11) locating plate
- (12) intermediate anvil (interchangeable),
26 diameter x 26
- (13) locating ring with orifices
- (14) impact device

▼B

Figure 4

Continued

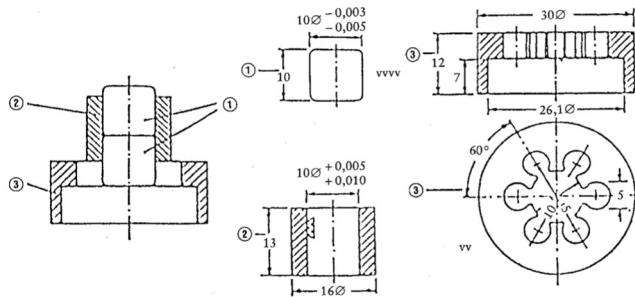

Fig. 4c Shock device for substances in powdered or paste-like form

Fig. 4d Shock device for liquid substances

- (1) steel cylinders
- (2) guide ring for steel cylinders
- (3) locating ring with orifices
 - (a) vertical section
 - (b) plan
- (4) rubber ring
- (5) liquid substance (40 mm^3)
- (6) space free from liquid

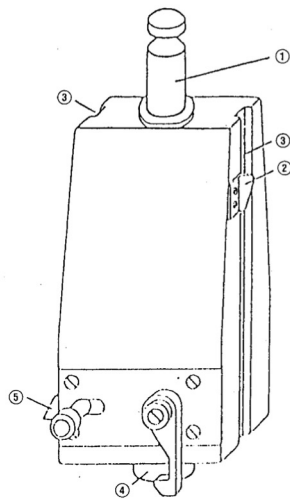
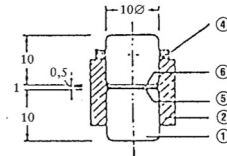

Fig. 4e Hammer (drop mass of 5 kg)

- (1) suspension spigot
- (2) height marker
- (3) positioning groove
- (4) cylindrical striking head
- (5) rebound catch

▼B

Figure 5

Friction sensitivity apparatus

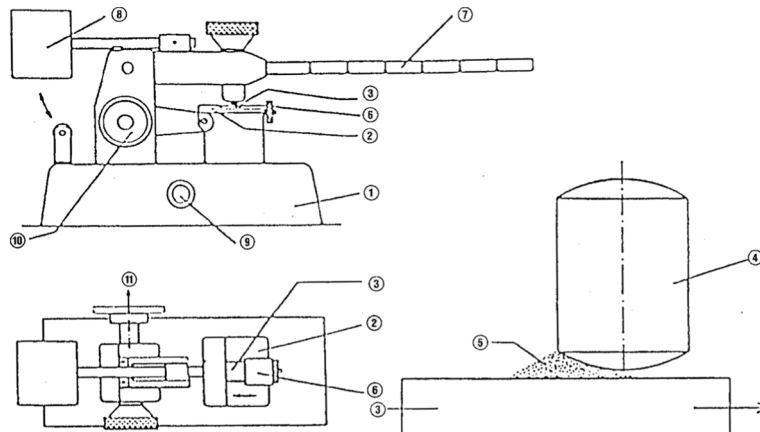

Fig. 5a Friction apparatus; elevation and plan view Fig. 5b Starting position of peg on sample

- | | |
|---|--|
| (1) steel base | (6) peg-holder |
| (2) movable carriage | (7) loading arm |
| (3) porcelain plate, 25 x 25 x 5 mm, held on carriage | (8) counterweight |
| (4) fixed porcelain peg, 10 diameter x 15 mm | (9) switch |
| (5) sample under test, approximately 10 mm ³ | (10) wheel for setting carriage at starting position |
| | (11) direction to electric drive motor |

▼BA.15. **AUTO-IGNITION TEMPERATURE (LIQUIDS AND GASES)**1. **METHOD**1.1. **INTRODUCTION**

Explosive substances and substances which ignite spontaneously in contact with air at ambient temperature should not be submitted to this test. The test procedure is applicable to gases, liquids and vapours which, in the presence of air, can be ignited by a hot surface.

The auto-ignition temperature can be considerably reduced by the presence of catalytic impurities, by the surface material or by a higher volume of the test vessel.

1.2. **DEFINITIONS AND UNITS**

The degree of auto-ignitability is expressed in terms of the auto-ignition temperature. The auto-ignition temperature is the lowest temperature at which the test substance will ignite when mixed with air under the conditions defined in the test method.

1.3. **REFERENCE SUBSTANCES**

Reference substances are cited in the standards (see 1.6.3). They should primarily serve to check the performance of the method from time to time and to allow comparison with results from other methods.

1.4. **PRINCIPLE OF THE METHOD**

The method determines the minimum temperature of the inner surface of an enclosure that will result in ignition of a gas, vapour or liquid injected into the enclosure.

1.5. **QUALITY CRITERIA**

The repeatability varies according to the range of auto-ignition temperatures and the test method used.

The sensitivity and specificity depend on the test method used.

1.6. **DESCRIPTION OF THE METHOD**1.6.1. **Apparatus**

The apparatus is described in the method referred to in 1.6.3.

1.6.2. **Test conditions**

A sample of the test substance is tested according to the method referred to in 1.6.3.

1.6.3. **Performance of the test**

See IEC 79-4, DIN 51794, ASTM-E 659-78, BS 4056, NF T 20-037.

▼B

2. **DATA**
Record the test-temperature, atmospheric pressure, quantity of sample used and time-lag until ignition occurs.
3. **REPORTING**
The test report shall, if possible, include the following information:
 - the precise specification of the substance (identification and impurities),
 - the quantity of sample used, atmospheric pressure,
 - the apparatus used,
 - the results of measurements (test temperatures, results concerning ignition, corresponding time-lags),
 - all additional remarks relevant to the interpretation of results.
4. **REFERENCES**
None.

▼ B**A.16. RELATIVE SELF-IGNITION TEMPERATURE FOR SOLIDS****1. METHOD****1.1. INTRODUCTION**

Explosive substances and substances which ignite spontaneously in contact with air at ambient temperature should not be submitted to this test.

The purpose of this test is to provide preliminary information on the auto-flammability of solid substances at elevated temperatures.

If the heat developed either by a reaction of the substance with oxygen or by exothermic decomposition is not lost rapidly enough to the surroundings, self-heating leading to self-ignition occurs. Self-ignition therefore occurs when the rate of heat-production exceeds the rate of heat loss.

The test procedure is useful as a preliminary screening test for solid substances. In view of the complex nature of the ignition and combustion of solids, the self-ignition temperature determined according to this test method should be used for comparison purposes only.

1.2. DEFINITIONS AND UNITS

The self-ignition temperature as obtained by this method is the minimum ambient temperature expressed in °C at which a certain volume of a substance will ignite under defined conditions.

1.3. REFERENCE SUBSTANCE

None.

1.4. PRINCIPLE OF THE METHOD

A certain volume of the substance under test is placed in an oven at room temperature; the temperature/time curve relating to conditions in the centre of the sample is recorded while the temperature of the oven is increased to 400 °C, or to the melting point if lower, at a rate of 0,5 °C/min. For the purpose of this test, the temperature of the oven at which the sample temperature reaches 400 °C by self-heating is called the self-ignition temperature.

1.5. QUALITY CRITERIA

None.

1.6. DESCRIPTION OF THE METHOD**1.6.1. Apparatus****1.6.1.1. Oven**

A temperature-programmed laboratory oven (volume about 2 litres) fitted with natural air circulation and explosion relief. In order to avoid a potential explosion risk, any decomposition gases must not be allowed to come into contact with the electric heating elements.

▼ B1.6.1.2. *Wire mesh cube*

A piece of stainless steel wire mesh with 0,045 mm openings should be cut according to the pattern in figure 1. The mesh should be folded and secured with wire into an open-topped cube.

1.6.1.3. *Thermocouples*

Suitable thermocouples.

1.6.1.4. *Recorder*

Any two-channel recorder calibrated from 0 to 600 °C or corresponding voltage.

1.6.2. **Test conditions**

Substances are tested as received.

1.6.3. **Performance of the test**

The cube is filled with the substance to be tested and is tapped gently, adding more of the substance until the cube is completely full. The cube is then suspended in the centre of the oven at room temperature. One thermocouple is placed at the centre of the cube and the other between the cube and the oven wall to record the oven temperature.

The temperatures of the oven and sample are continuously recorded while the temperature of the oven is increased to 400 °C, or to the melting point if lower, at a rate of 0,5 °C/min.

When the substance ignites the sample thermocouple will show a very sharp temperature rise above the oven temperature.

2. **DATA**

The temperature of the oven at which the sample temperature reaches 400 °C by self-heating is relevant for evaluation (see figure 2).

3. **REPORTING**

The test report shall, if possible, include the following information:

- a description of the substance to be tested,
- the results of measurement including the temperature/time curve,
- all additional remarks relevant for the interpretation of the results.

4. **REFERENCES**

NF T 20-036 (September 85) Chemical products for industrial use. Determination of the relative temperature of the spontaneous flammability of solids.

▼B

Figure 1

Pattern of 20 mm test cube

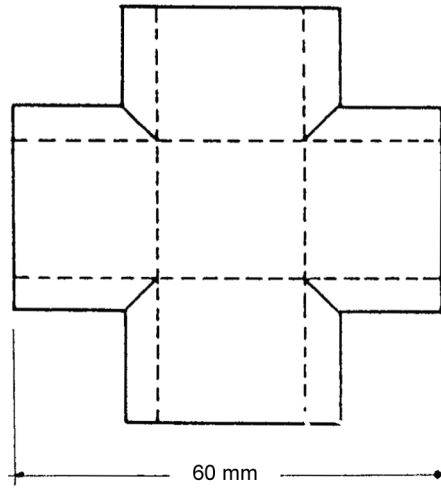
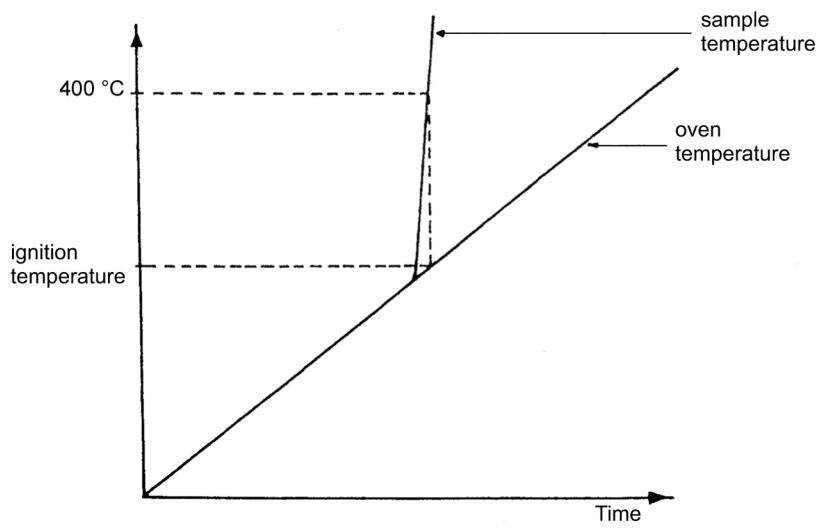

Figure 2

Typical temperature/time curve



▼B**A.17. OXIDISING PROPERTIES (SOLIDS)****1. METHOD****1.1. INTRODUCTION**

It is useful to have preliminary information on any potentially explosive properties of the substance before performing this test.

This test is not applicable to liquids, gases, explosive or highly flammable substances, or organic peroxides.

This test need not be performed when examination of the structural formula establishes beyond reasonable doubt that the substance is incapable of reacting exothermically with a combustible material.

In order to ascertain if the test should be performed with special precautions, a preliminary test should be performed.

1.2. DEFINITION AND UNITS

Burning time: reaction time, in seconds, taken for the reaction zone to travel along a pile, following the procedure described in 1.6.

Burning rate: expressed in millimetres per second.

Maximum burning rate: the highest value of the burning rates obtained with mixtures containing 10 to 90 % by weight of oxidiser.

1.3. REFERENCE SUBSTANCE

Barium nitrate (analytical grade) is used as reference substance for the test and the preliminary test.

The reference mixture is that mixture of barium nitrate with powdered cellulose, prepared according to 1.6, which has the maximum burning rate (usually a mixture with 60 % barium nitrate by weight).

1.4. PRINCIPLE OF THE METHOD

A preliminary test is carried out in the interests of safety. No further testing is required when the preliminary test clearly indicates that the test substance has oxidising properties. When this is not the case, the substance should then be subject to the full test.

In the full test, the substance to be tested and a defined combustible substance will be mixed in various ratios. Each mixture is then formed into a pile and the pile is ignited at one end. The maximum burning rate determined is compared with the maximum burning rate of the reference mixture.

1.5. QUALITY CRITERIA

If required, any method of grinding and mixing is valid provided that the difference in the maximum rate of burning in the six separate tests differs from the arithmetic mean value by no more than 10 %.

▼ B

1.6. DESCRIPTION OF THE METHOD

1.6.1. **Preparation**1.6.1.1. *Test substance*

Reduce the test sample to a particle size $< 0,125$ mm using the following procedure: sieve the test substance, grind the remaining fraction, repeat the procedure until the whole test portion has passed the sieve.

Any grinding and sieving method satisfying the quality criteria may be used.

Before preparing the mixture the substance is dried at 105 °C, until constant weight is obtained. If the decomposition temperature of the substance to be tested is below 105 °C, the substance has to be dried at a suitable lower temperature.

1.6.1.2. *Combustible substance*

Powdered cellulose is used as a combustible substance. The cellulose should be a type used for thin-layer chromatography or column chromatography. A type with fibre-lengths of more than 85 % between $0,020$ and $0,075$ mm has proved to be suitable. The cellulose powder is passed through a sieve with a mesh-size of $0,125$ mm. The same batch of cellulose is to be used throughout the test.

Before preparing the mixture, the powdered cellulose is dried at 105 °C until constant weight is obtained.

If wood-meal is used in the preliminary test, then prepare a soft-wood wood-meal by collecting the portion which passes through a sieve mesh of $1,6$ mm, mix thoroughly, then dry at 105 °C for four hours in a layer not more than 25 mm thick. Cool and store in an air-tight container filled as full as practicable until required, preferably within 24 hours of drying.

1.6.1.3. *Ignition source*

A hot flame from a gas burner (minimum diameter 5 mm) should be used as the ignition source. If another ignition source is used (e.g. when testing in an inert atmosphere), the description and the justification should be reported.

1.6.2. **Performance of the test**

Note:

Mixtures of oxidisers with cellulose or wood-meal must be treated as potentially explosive and handled with due care.

1.6.2.1. *Preliminary test*

The dried substance is thoroughly mixed with the dried cellulose or wood-meal in the proportions 2 of test substance to 1 of cellulose or wood-meal by weight and the mixture is formed into a small cone-shaped pile of dimensions $3,5$ cm (diameter of base) \times $2,5$ cm (height) by filling, without tamping, a cone-shaped former (e.g. a laboratory glass funnel with the stem plugged).

▼ B

The pile is placed on a cool, non-combustible, non-porous and low heat-conducting base plate. The test should be carried out in a fume cupboard as in 1.6.2.2.

The ignition source is put in contact with the cone. The vigour and duration of the resultant reaction are observed and recorded.

The substance is to be considered as oxidising if the reaction is vigorous.

In any case where the result is open to doubt, it is then necessary to complete the full train test described below.

1.6.2.2. Train test

Prepare oxidiser cellulose-mixtures containing 10 to 90 % weight of oxidiser in 10 % increments. For borderline cases, intermediate oxidiser cellulose mixtures should be used to obtain the maximum burning rate more precisely.

The pile is formed by means of a mould. The mould is made of metal, has a length of 250 mm and a triangular cross-section with an inner height of 10 mm and an inner width of 20 mm. On both sides of the mould, in the longitudinal direction, two metal plates are mounted as lateral limitations which project 2 mm beyond the upper edge of the triangular cross-section (figure). This arrangement is loosely filled with a slight excess of mixture. After dropping the mould once from a height of 2 cm onto a solid surface, the remaining excess substance is scraped off with an obliquely positioned sheet. The lateral limitations are removed and the remaining powder is smoothed, using a roller. A non-combustible, non-porous and low heat-conducting base plate is then placed on the top of the mould, the apparatus inverted and the mould removed.

Arrange the pile across the draught in a fume cupboard.

The air-speed should be sufficient to prevent fumes escaping into the laboratory and should not be varied during the test. A draught screen should be erected around the apparatus.

Due to hygroscopicity of cellulose and of some substances to be tested, the test should be carried out as quickly as possible.

Ignite one end of the pile by touching with the flame.

Measure the time of reaction over a distance of 200 mm after the reaction zone has propagated an initial distance of 30 mm.

The test is performed with the reference substance and at least once with each one of the range of mixtures of the test substance with cellulose.

If the maximum burning rate is found to be significantly greater than that from the reference mixture, the test can be stopped; otherwise the test should be repeated five times for each of the three mixtures giving the fastest burning rate.

▼B

If the result is suspected of being a false positive, then the test should be repeated using an inert substance with a similar particle size, such as kieselguhr, in place of cellulose. Alternatively, the test substance cellulose mixture, having the fastest burning rate, should be retested in an inert atmosphere (< 2 % v/v oxygen content).

2. DATA

For safety reasons the maximum burning rate — not the mean value — shall be considered to be the characteristic oxidising property of the substance under test.

The highest value of burning rate within a run of six tests of a given mixture is relevant for evaluation.

Plot a graph of the highest value of burning rate for each mixture versus the oxidiser concentration. From the graph take the maximum burning rate.

The six measured values of burning rate within a run obtained from the mixture with the maximum burning rate must not differ from the arithmetic mean value by more than 10 %; otherwise the methods of grinding and mixing must be improved.

Compare the maximum burning rate obtained with the maximum burning rate of the reference mixture (see 1.3).

If tests are conducted in an inert atmosphere, the maximum reaction rate is compared with that from the reference mixture in an inert atmosphere.

3. REPORT**3.1. TEST REPORT**

The test report shall, if possible, include the following information:

- the identity, composition, purity, moisture content etc. of the substance tested,
- any treatment of the test sample (e.g. grinding, drying),
- the ignition source used in the tests,
- the results of measurements,
- the mode of reaction (e.g. flash burning at the surface, burning through the whole mass, any information concerning the combustion products, etc.),
- all additional remarks relevant for the interpretation of results, including a description of the vigour (flaming, sparking, fuming, slow smouldering, etc.) and approximate duration produced in the preliminary safety/screening test for both test and reference substance,
- the results from tests with an inert substance, if any,
- the results from tests in an inert atmosphere, if any.

▼B

3.2. INTERPRETATION OF THE RESULT

A substance is to be considered as an oxidising substance when:

- (a) in the preliminary test, there is a vigorous reaction;
- (b) in the full test, the maximum burning rate of the mixtures tested is higher than or equal to the maximum burning rate of the reference mixture of cellulose and barium nitrate.

In order to avoid a false positive, the results obtained when testing the substance mixed with an inert material and/or when testing under an inert atmosphere should also be considered when interpreting the results.

4. REFERENCES

NF T 20-035 (September 85) Chemical products for industrial use. Determination of the oxidising properties of solids.

▼B*Appendix**Figure***Mould and accessories for the preparations of the pile**

(All dimensions in millimetres)

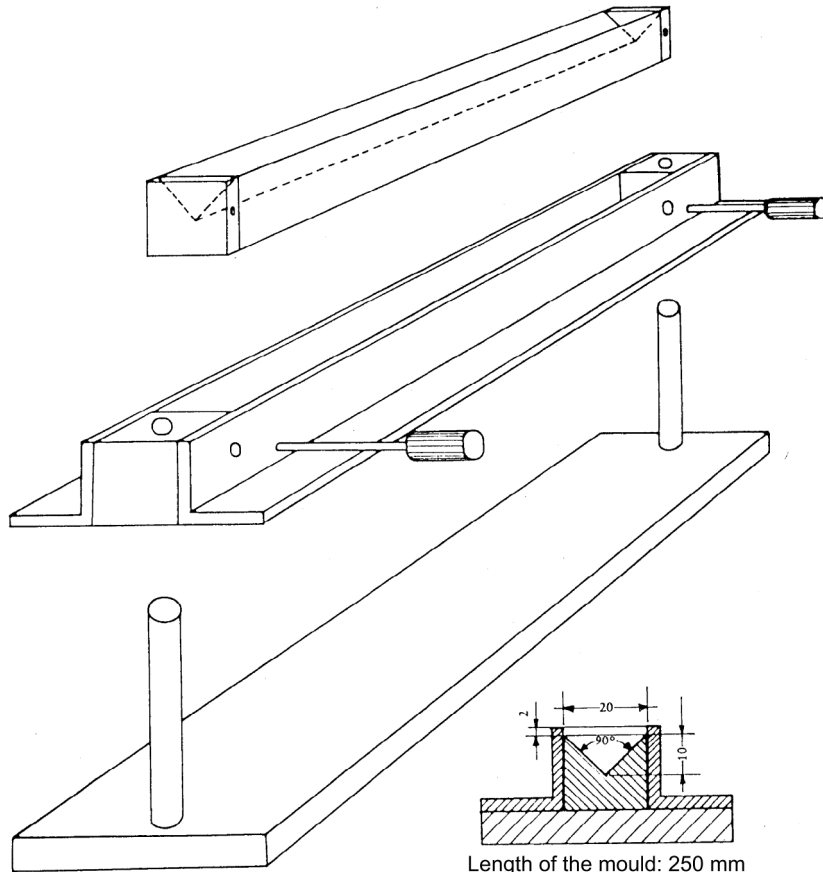
Length of the mould: 250 mm
Material: aluminium

▼ B**A.18. NUMBER-AVERAGE MOLECULAR WEIGHT AND MOLECULAR WEIGHT DISTRIBUTION OF POLYMERS****1. METHOD**

This Gel Permeation Chromatographic method is a replicate of the OECD TG 118 (1996). The fundamental principles and further technical information are given in reference (1).

1.1. INTRODUCTION

Since the properties of polymers are so varied, it is impossible to describe one single method setting out precisely the conditions for separation and evaluation which cover all eventualities and specificities occurring in the separation of polymers. In particular, complex polymer systems are often not amenable to gel permeation chromatography (GPC). When GPC is not practicable, the molecular weight may be determined by means of other methods (see Appendix). In such cases, full details and justification should be given for the method used.

The method described is based on DIN Standard 55672 (1). Detailed information about how to carry out the experiments and how to evaluate the data can be found in this DIN Standard. In case modifications of the experimental conditions are necessary, these changes must be justified. Other standards may be used, if fully referenced. The method described uses polystyrene samples of known polydispersity for calibration and it may have to be modified to be suitable for certain polymers, e.g. water soluble and long-chain branched polymers.

1.2. DEFINITIONS AND UNITS

The number-average molecular weight M_n and the weight average molecular weight M_w are determined using the following equations:

$$M_n = \frac{\sum_{i=1}^n H_i}{\sum_{i=1}^n H_i/M_i} \qquad M_w = \frac{\sum_{i=1}^n H_i \times M_i}{\sum_{i=1}^n H_i}$$

where,

H_i is the level of the detector signal from the baseline for the retention volume V_i ,

M_i is the molecular weight of the polymer fraction at the retention volume V_i , and

n is the number of data points.

The breadth of the molecular weight distribution, which is a measure of the dispersity of the system, is given by the ratio M_w/M_n .

▼ B

1.3. REFERENCE SUBSTANCES

Since GPC is a relative method, calibration must be undertaken. Narrowly distributed, linearly constructed polystyrene standards with known average molecular weights M_n and M_w and a known molecular weight distribution are normally used for this. The calibration curve can only be used in the determination of the molecular weight of the unknown sample if the conditions for the separation of the sample and the standards have been selected in an identical manner.

A determined relationship between the molecular weight and elution volume is only valid under the specific conditions of the particular experiment. The conditions include, above all, the temperature, the solvent (or solvent mixture), the chromatography conditions and the separation column or system of columns.

The molecular weights of the sample determined in this way are relative values and are described as 'polystyrene equivalent molecular weights'. This means that dependent on the structural and chemical differences between the sample and the standards, the molecular weights can deviate from the absolute values to a greater or a lesser degree. If other standards are used, e.g. polyethylene glycol, polyethylene oxide, polymethyl methacrylate, polyacrylic acid, the reason should be stated.

1.4. PRINCIPLE OF THE TEST METHOD

Both the molecular weight distribution of the sample and the average molecular weights (M_n , M_w) can be determined using GPC. GPC is a special type of liquid chromatography in which the sample is separated according to the hydrodynamic volumes of the individual constituents (2).

Separation is effected as the sample passes through a column which is filled with a porous material, typically an organic gel. Small molecules can penetrate the pores whereas large molecules are excluded. The path of the large molecules is thereby shorter and these are eluted first. The medium-sized molecules penetrate some of the pores and are eluted later. The smallest molecules, with a mean hydrodynamic radius smaller than the pores of the gel, can penetrate all of the pores. These are eluted last.

In an ideal situation, the separation is governed entirely by the size of the molecular species, but in practice it is difficult to avoid at least some absorption effects interfering. Uneven column packing and dead volumes can worsen the situation (2).

Detection is effected by, e.g. refractive index or UV-absorption, and yields a simple distribution curve. However, to attribute actual molecular weight values to the curve, it is necessary to calibrate the column by passing down polymers of known molecular weight and, ideally, of broadly similar structure e.g. various polystyrene standards. Typically a Gaussian curve results, sometimes distorted by a small tail to the low molecular weight side, the vertical axis indicating the quantity, by weight, of the various molecular weight species eluted, and the horizontal axis the log molecular weight.

▼ B

1.5. QUALITY CRITERIA

The repeatability (Relative Standard Deviation: RSD) of the elution volume should be better than 0,3 %. The required repeatability of the analysis has to be ensured by correction via an internal standard if a chromatogram is evaluated time-dependently and does not correspond to the above mentioned criterion (1). The polydispersities are dependent on the molecular weights of the standards. In the case of polystyrene standards typical values are:

$$M_p < 2\,000 \qquad M_w/M_n < 1,20$$

$$2\,000 \leq M_p \leq 10^6 \qquad M_w/M_n < 1,05$$

$$M_p > 10^6 \qquad M_w/M_n < 1,20$$

(M_p is the molecular weight of the standard at the peak maximum)

1.6. DESCRIPTION OF THE TEST METHOD

1.6.1. **Preparation of the standard polystyrene solutions**

The polystyrene standards are dissolved by careful mixing in the chosen eluent. The recommendations of the manufacturer must be taken into account in the preparation of the solutions.

The concentrations of the standards chosen are dependent on various factors, e.g. injection volume, viscosity of the solution and sensitivity of the analytical detector. The maximum injection volume must be adapted to the length of the column, in order to avoid overloading. Typical injection volumes for analytical separations using GPC with a column of 30 cm × 7,8 mm are normally between 40 and 100 µl. Higher volumes are possible, but they should not exceed 250 µl. The optimal ratio between the injection volume and the concentration must be determined prior to the actual calibration of the column.

1.6.2. **Preparation of the sample solution**

In principle, the same requirements apply to the preparation of the sample solutions. The sample is dissolved in a suitable solvent, e.g. tetrahydrofuran (THF), by shaking carefully. Under no circumstances should it be dissolved using an ultrasonic bath. When necessary, the sample solution is purified via a membrane filter with a pore size of between 0,2 and 2 µm.

The presence of undissolved particles must be recorded in the final report as these may be due to high molecular weight species. An appropriate method should be used to determine the percentage by weight of the undissolved particles. The solutions should be used within 24 hours.

1.6.3. **Apparatus**

- solvent reservoir,
- degasser (where appropriate),
- pump,

▼ B

- pulse dampener (where appropriate),
- injection system,
- chromatography columns,
- detector,
- flowmeter (where appropriate),
- data recorder-processor,
- waste vessel.

It must be ensured that the GPC system is inert with regard to the utilised solvents (e.g. by the use of steel capillaries for THF solvent).

1.6.4. **Injection and solvent delivery system**

A defined volume of the sample solution is loaded onto the column either using an auto-sampler or manually in a sharply defined zone. Withdrawing or depressing the plunger of the syringe too quickly, if done manually, can cause changes in the observed molecular weight distribution. The solvent-delivery system should, as far as possible, be pulsation-free ideally incorporating a pulse dampener. The flow rate is of the order of 1 ml/min.

1.6.5. **Column**

Depending on the sample, the polymer is characterised using either a simple column or several columns connected in sequence. A number of porous column materials with defined properties (e.g. pore size, exclusion limits) are commercially available. Selection of the separation gel or the length of the column is dependent on both the properties of the sample (hydrodynamic volumes, molecular weight distribution) and the specific conditions for separation such as solvent, temperature and flow rate (1)(2)(3).

1.6.6. **Theoretical plates**

The column or the combination of columns used for separation must be characterised by the number of theoretical plates. This involves, in the case of THF as elution solvent, loading a solution of ethyl benzene or other suitable non-polar solute onto a column of known length. The number of theoretical plates is given by the following equation:

$$N = 5,54 \left(\frac{V_e}{W_{1/2}} \right)^2 \quad \text{or} \quad N = 16 \left(\frac{V_e}{W} \right)^2$$

where,

N = the number of theoretical plates

V_e = the elution volume at the peak maximum

▼ B

W = the baseline peak width

$W_{1/2}$ = the peak width at half height

1.6.7. Separation efficiency

In addition to the number of theoretical plates, which is a quantity determining the bandwidth, a part is also played by the separation efficiency, this being determined by the steepness of the calibration curve. The separation efficiency of a column is obtained from the following relationship:

$$\frac{V_{e,M_x} - V_{e,(10M_x)}}{\text{cross sectional area of the column}} \geq 6,0 \left[\frac{\text{cm}^3}{\text{cm}^2} \right]$$

where,

V_{e, M_x} = the elution volume for polystyrene with the molecular weight M_x

$V_{e,(10.M_x)}$ = the elution volume for polystyrene with a ten times greater molecular weight

The resolution of the system is commonly defined as follows:

$$R_{1,2} = 2 \times \frac{V_{e1} - V_{e2}}{W_1 + W_2} \times \frac{1}{\log_{10}(M_2/M_1)}$$

where,

V_{e1}, V_{e2} = the elution volumes of the two polystyrene standards at the peak maximum

W_1, W_2 = the peak widths at the base-line

M_1, M_2 = the molecular weights at the peak maximum (should differ by a factor of 10)

The R-value for the column system should be greater than 1.7 (4).

1.6.8. Solvents

All solvents must be of high purity (for THF purity of 99,5 % is used). The solvent reservoir (if necessary in an inert gas atmosphere) must be sufficiently large for the calibration of the column and several sample analyses. The solvent must be degassed before it is transported to the column via the pump.

1.6.9. Temperature control

The temperature of the critical internal components (injection loop, columns, detector and tubing) should be constant and consistent with the choice of solvent.

▼ B1.6.10. **Detector**

The purpose of the detector is to record quantitatively the concentration of sample eluted from the column. In order to avoid unnecessary broadening of peaks the cuvette volume of the detector cell must be kept as small as possible. It should not be larger than 10 µl except for light scattering and viscosity detectors. Differential refractometry is usually used for detection. However, if required by the specific properties of the sample or the elution solvent, other types of detectors can be used, e.g. UV/VIS, IR, viscosity detectors, etc.

2. **DATA AND REPORTING**2.1. **DATA**

The DIN Standard (1) should be referred to for the detailed evaluation criteria as well as for the requirements relating to the collecting and processing of data.

For each sample, two independent experiments must be carried out. They have to be analysed individually.

M_n , M_w , M_w/M_n and M_p must be provided for every measurement. It is necessary to indicate explicitly that the measured values are relative values equivalent to the molecular weights of the standard used.

After determination of the retention volumes or the retention times (possibly corrected using an internal standard), $\log M_p$ values (M_p being the peak maxima of the calibration standard) are plotted against one of those quantities. At least two calibration points are necessary per molecular weight decade, and at least five measurement points are required for the total curve, which should cover the estimated molecular weight of the sample. The low molecular weight end-point of the calibration curve is defined by n-hexyl benzene or another suitable non-polar solute. The number average and the weight-average molecular weights are generally determined by means of electronic data processing, based on the formulas of section 1.2. In case manual digitisation is used, ASTM D 3536-91 can be consulted (3).

The distribution curve must be provided in the form of a table or as figure (differential frequency or sum percentages against $\log M$). In the graphic representation, one molecular weight decade should be normally about 4 cm in width and the peak maximum should be about 8 cm in height. In the case of integral distribution curves the difference in the ordinate between 0 and 100 % should be about 10 cm.

2.2. **TEST REPORT**

The test report must include the following information:

2.2.1. **Test substance:**

— available information about test substance (identity, additives, impurities),

▼ B

- description of the treatment of the sample, observations, problems.

2.2.2. Instrumentation:

- reservoir of eluent, inert gas, degassing of the eluent, composition of the eluent, impurities,
- pump, pulse dampener, injection system,
- separation columns (manufacturer, all information about the characteristics of the columns, such as pore size, kind of separation material, etc., number, length and order of the columns used),
- number of the theoretical plates of the column (or combination), separation efficiency (resolution of the system),
- information on symmetry of the peaks,
- column temperature, kind of temperature control,
- detector (measurement principle, type, cuvette volume),
- flowmeter if used (manufacturer, measurement principle),
- system to record and process data (hardware and software).

2.2.3. Calibration of the system:

- detailed description of the method used to construct the calibration curve,
- information about quality criteria for this method (e.g. correlation coefficient, error sum of squares, etc.),
- information about all extrapolations, assumptions and approximations made during the experimental procedure and the evaluation and processing of data,
- all measurements used for constructing the calibration curve have to be documented in a table which includes the following information for each calibration point:
 - name of the sample,
 - manufacturer of the sample,
 - characteristic values of the standards M_p , M_n , M_w , M_w/M_n , as provided by the manufacturer or derived by subsequent measurements, together with details about the method of determination,
 - injection volume and injection concentration,

▼ B

- M_p value used for calibration,
- elution volume or corrected retention time measured at the peak maxima,
- M_p calculated at the peak maximum,
- percentage error of the calculated M_p and the calibration value.

2.2.4. Evaluation:

- evaluation on a time basis: methods used to ensure the required reproducibility (method of correction, internal standard, etc.),
- information about whether the evaluation was effected on the basis of the elution volume or the retention time,
- information about the limits of the evaluation if a peak is not completely analysed,
- description of smoothing methods, if used,
- preparation and pre-treatment procedures of the sample,
- the presence of undissolved particles, if any,
- injection volume (μl) and injection concentration (mg/ml),
- observations indicating effects which lead to deviations from the ideal GPC profile,
- detailed description of all modifications in the testing procedures,
- details of the error ranges,
- any other information and observations relevant for the interpretation of the results.

3. REFERENCES

- (1) DIN 55672(1995) Gelpermeationschromatographie (GPC) mit Tetrahydrofuran (THF) als Elutionsmittel, Teil 1.
- (2) Yau, W.W., Kirkland, J.J., and Bly, D.D. eds., (1979) Modern Size Exclusion Liquid Chromatography, J. Wiley and Sons.
- (3) ASTM D 3536-91, (1991). Standard Test Method for Molecular Weight Averages and Molecular Weight Distribution by Liquid Exclusion Chromatography (Gel Permeation Chromatography-GPC) American Society for Testing and Materials, Philadelphia, Pennsylvania.
- (4) ASTM D 5296-92, (1992) Standard Test Method for Molecular Weight Averages and Molecular Weight Distribution of Polystyrene by High Performance Size-Exclusion Chromatography. American Society for Testing and Materials, Philadelphia, Pennsylvania.

▼ B*Appendix***Examples of other methods for determination of number average molecular weight (M_n) for polymers**

Gel permeation chromatography (GPC) is the preferred method for determination of M_n , especially when a set of standards are available, whose structure are comparable with the polymer structure. However, where there are practical difficulties in using GPC or there is already an expectation that the substance will fail a regulatory M_n criterion (and which needs confirming), alternative methods are available, such as:

1. Use of colligative properties**1.1. Ebullioscopy/Cryoscopy**

involves measurement of boiling point elevation (ebullioscopy) or freezing point depression (cryoscopy) of a solvent, when the polymer is added. The method relies on the fact that the effect of the dissolved polymer on the boiling/freezing point of the liquid is dependent on the molecular weight of the polymer (1) (2).

Applicability, $M_n < 20\,000$.

1.2. Lowering of vapour pressure

involves the measurement of the vapour pressure of a chosen reference liquid before and after the addition of known quantities of polymer (1) (2).

Applicability, $M_n < 20\,000$ (theoretically; in practice however of limited value).

1.3. Membrane osmometry

relies on the principle of osmosis, i.e. the natural tendency of solvent molecules to pass through a semi-permeable membrane from a dilute to a concentrated solution to achieve equilibrium. In the test, the dilute solution is at zero concentration, whereas the concentrated solution contains the polymer. The effect of drawing solvent through the membrane causes a pressure differential that is dependent on the concentration and the molecular weight of the polymer (1) (3) (4).

Applicability, M_n between 20 000 - 200 000.

1.4. Vapour phase osmometry

involves comparison of the rate of evaporation of a pure solvent aerosol to at least three aerosols containing the polymer at different concentrations (1)(2)(4).

Applicability, $M_n < 20\,000$.

▼ B**2. End-group analysis**

To use this method, knowledge of both the overall structure of the polymer and the nature of the chain terminating end groups is needed (which must be distinguishable from the main skeleton by, e.g. NMR or titration/derivatisation). The determination of the molecular concentration of the end groups present on the polymer can lead to a value for the molecular weight (7) (8) (9).

Applicability, M_n up to 50 000 (with decreasing reliability).

3. References

- (1) Billmeyer, F.W. Jr., (1984) Textbook of Polymer Science, 3rd Edn., John Wiley, New York.
- (2) Glover, C.A., (1975) Absolute Colligative Property Methods. Chapter 4. In: Polymer Molecular Weights, Part I P.E. Slade, Jr. ed., Marcel Dekker, New York.
- (3) ASTM D 3750-79, (1979) Standard Practice for Determination of Number-Average Molecular Weight of Polymers by Membrane Osmometry. American Society for Testing and Materials, Philadelphia, Pennsylvania.
- (4) Coll, H. (1989) Membrane Osmometry. In: Determination of Molecular Weight, A.R. Cooper ed., J. Wiley and Sons, pp. 25-52.
- (5) ASTM 3592-77, (1977) Standard Recommended Practice for Determination of Molecular Weight by Vapour Pressure, American Society for Testing and Materials, Philadelphia, Pennsylvania.
- (6) Morris, C.E.M., (1989) Vapour Pressure Osmometry. In: Determination of Molecular Weight, A.R. Cooper ed., John Wiley and Sons.
- (7) Schröder, E., Müller, G., and Arndt, K-F., (1989) Polymer Characterisation, Carl Hanser Verlag, Munich.
- (8) Garmon, R.G., (1975) End-Group Determinations, Chapter 3 In: Polymer Molecular Weights, Part I, P.E. Slade, Jr. ed., Marcel Dekker, New York.
- (9) Amiya, S., et al. (1990) Pure and Applied Chemistry, 62, 2139-2146.

▼ B**A.19. LOW MOLECULAR WEIGHT CONTENT OF POLYMERS****1. METHOD**

This Gel Permeation Chromatographic method is a replicate of the OECD TG 119 (1996). The fundamental principles and further technical information are given in the references.

1.1. INTRODUCTION

Since the properties of polymers are so varied, it is impossible to describe one single method setting out precisely the conditions for separation and evaluation which cover all eventualities and specificities occurring in the separation of polymers. In particular, complex polymer systems are often not amenable to gel permeation chromatography (GPC). When GPC is not practicable, the molecular weight may be determined by means of other methods (see Appendix). In such cases, full details and justification should be given for the method used.

The method described is based on DIN Standard 55672 (1). Detailed information about how to carry out the experiments and how to evaluate the data can be found in this DIN Standard. In case modifications of the experimental conditions are necessary, these changes must be justified. Other standards may be used, if fully referenced. The method described uses polystyrene samples of known polydispersity for calibration and it may have to be modified to be suitable for certain polymers, e.g. water soluble and long-chain branched polymers.

1.2. DEFINITIONS AND UNITS

Low molecular weight is arbitrarily defined as a molecular weight below 1 000 dalton.

The number-average molecular weight M_n and the weight average molecular weight M_w are determined using the following equations:

$$M_n = \frac{\sum_{i=1}^n H_i}{\sum_{i=1}^n H_i/M_i} \qquad M_w = \frac{\sum_{i=1}^n H_i \times M_i}{\sum_{i=1}^n H_i}$$

where,

H_i = the level of the detector signal from the baseline for the retention volume V_i ,

M_i = the molecular weight of the polymer fraction at the retention volume V_i , and n is the number of data points

The breadth of the molecular weight distribution, which is a measure of the dispersity of the system, is given by the ratio M_w/M_n .

▼ B

1.3. REFERENCE SUBSTANCES

Since GPC is a relative method, calibration must be undertaken. Narrowly distributed, linearly constructed polystyrene standards with known average molecular weights M_n and M_w and a known molecular weight distribution are normally used for this. The calibration curve can only be used in the determination of the molecular weight of the unknown sample if the conditions for the separation of the sample and the standards have been selected in an identical manner.

A determined relationship between the molecular weight and elution volume is only valid under the specific conditions of the particular experiment. The conditions include, above all, the temperature, the solvent (or solvent mixture), the chromatography conditions and the separation column or system of columns.

The molecular weights of the sample determined in this way are relative values and are described as 'polystyrene equivalent molecular weights'. This means that dependent on the structural and chemical differences between the sample and the standards, the molecular weights can deviate from the absolute values to a greater or a lesser degree. If other standards are used, e.g. polyethylene glycol, polyethylene oxide, polymethyl methacrylate, polyacrylic acid, the reason should be stated.

1.4. PRINCIPLE OF THE TEST METHOD

Both the molecular weight distribution of the sample and the average molecular weights (M_n , M_w) can be determined using GPC. GPC is a special type of liquid chromatography in which the sample is separated according to the hydrodynamic volumes of the individual constituents (2).

Separation is effected as the sample passes through a column which is filled with a porous material, typically an organic gel. Small molecules can penetrate the pores whereas large molecules are excluded. The path of the large molecules is thereby shorter and these are eluted first. The medium-sized molecules penetrate some of the pores and are eluted later. The smallest molecules, with a mean hydrodynamic radius smaller than the pores of the gel, can penetrate all of the pores. These are eluted last.

In an ideal situation, the separation is governed entirely by the size of the molecular species, but in practice it is difficult to avoid at least some absorption effects interfering. Uneven column packing and dead volumes can worsen the situation (2).

Detection is effected by e.g. refractive index or UV-absorption and yields a simple distribution curve. However, to attribute actual molecular weight values to the curve, it is necessary to calibrate the column by passing down polymers of known molecular weight and, ideally, of broadly similar structure, e.g. various polystyrene standards. Typically a Gaussian curve results, sometimes distorted by a small tail to the low molecular weight side, the vertical axis indicating the quantity, by weight, of the various molecular weight species eluted, and the horizontal axis the log molecular weight.

▼ B

The low molecular weight content is derived from this curve. The calculation can only be accurate if the low molecular weight species respond equivalently on a per mass basis to the polymer as a whole.

1.5. QUALITY CRITERIA

The repeatability (Relative Standard Deviation: RSD) of the elution volume should be better than 0,3 %. The required repeatability of the analysis has to be ensured by correction via an internal standard if a chromatogram is evaluated time-dependently and does not correspond to the above mentioned criterion (1). The polydispersities are dependent on the molecular weights of the standards. In the case of polystyrene standards typical values are:

$M_p < 2\,000$	$M_w/M_n < 1,20$
$2\,000 \leq M_p \leq 10^6$	$M_w/M_n < 1,05$
$M_p > 10^6$	$M_w/M_n < 1,20$

(M_p is the molecular weight of the standard at the peak maximum)

1.6. DESCRIPTION OF THE TEST METHOD

1.6.1. **Preparation of the standard polystyrene solutions**

The polystyrene standards are dissolved by careful mixing in the chosen eluent. The recommendations of the manufacturer must be taken into account in the preparation of the solutions.

The concentrations of the standards chosen are dependent on various factors, e.g. injection volume, viscosity of the solution and sensitivity of the analytical detector. The maximum injection volume must be adapted to the length of the column, in order to avoid overloading. Typical injection volumes for analytical separations using GPC with a column of 30 cm × 7,8 mm are normally between 40 and 100 µl. Higher volumes are possible, but they should not exceed 250 µl. The optimal ratio between the injection volume and the concentration must be determined prior to the actual calibration of the column.

1.6.2. **Preparation of the sample solution**

In principle, the same requirements apply to the preparation of the sample solutions. The sample is dissolved in a suitable solvent, e.g. tetrahydrofuran (THF), by shaking carefully. Under no circumstances should it be dissolved using an ultrasonic bath. When necessary, the sample solution is purified via a membrane filter with a pore size of between 0,2 and 2 µm.

The presence of undissolved particles must be recorded in the final report as these may be due to high molecular weight species. An appropriate method should be used to determine the percentage by weight of the undissolved particles. The solutions should be used within 24 hours.

▼ B**1.6.3. Correction for content of impurities and additives**

Correction of the content of species of $M < 1\,000$ for the contribution from non-polymer specific components present (e.g. impurities and/or additives) is usually necessary, unless the measured content is already $< 1\%$. This is achieved by direct analysis of the polymer solution or the GPC eluate.

In cases where the eluate, after passage through the column, is too dilute for a further analysis it must be concentrated. It may be necessary to evaporate the eluate to dryness and dissolve it again. Concentration of the eluate must be effected under conditions which ensure that no changes occur in the eluate. The treatment of the eluate after the GPC step is dependent on the analytical method used for the quantitative determination.

1.6.4. Apparatus

GPC apparatus comprises the following components:

- solvent reservoir,
- degasser (where appropriate),
- pump,
- pulse dampener (where appropriate),
- injection system,
- chromatography columns,
- detector,
- flowmeter (where appropriate),
- data recorder-processor,
- waste vessel.

It must be ensured that the GPC system is inert with regard to the utilised solvents (e.g. by the use of steel capillaries for THF solvent).

1.6.5. Injection and solvent delivery system

A defined volume of the sample solution is loaded onto the column either using an auto-sampler or manually in a sharply defined zone. Withdrawing or depressing the plunger of the syringe too quickly, if done manually, can cause changes in the observed molecular weight distribution. The solvent-delivery system should, as far as possible, be pulsation-free ideally incorporating a pulse dampener. The flow rate is of the order of 1 ml/min.

1.6.6. Column

Depending on the sample, the polymer is characterised using either a simple column or several columns connected in sequence. A number of porous column materials with defined properties (e.g. pore size, exclusion limits) are commercially available. Selection of the separation gel or the length of the column is dependent on both the properties of the sample (hydrodynamic volumes, molecular weight distribution) and the specific conditions for separation such as solvent, temperature and flow rate (1) (2) (3).

▼ B**1.6.7. Theoretical plates**

The column or the combination of columns used for separation must be characterised by the number of theoretical plates. This involves, in the case of THF as elution solvent, loading a solution of ethyl benzene or other suitable non-polar solute onto a column of known length. The number of theoretical plates is given by the following equation:

$$N = 5,54 \left(\frac{V_e}{W_{1/2}} \right)^2 \quad \text{or} \quad N = 16 \left(\frac{V_e}{W} \right)^2$$

where,

N = the number of theoretical plates

V_e = the elution volume at the peak maximum

W = the baseline peak width

$W_{1/2}$ = the peak width at half height

1.6.8. Separation efficiency

In addition to the number of theoretical plates, which is a quantity determining the bandwidth, a part is also played by the separation efficiency, this being determined by the steepness of the calibration curve. The separation efficiency of a column is obtained from the following relationship:

$$\frac{V_{e,M_x} - V_{e,(10M_x)}}{\text{cross sectional area of the column}} \geq 6,0 \left[\frac{\text{cm}^3}{\text{cm}^2} \right]$$

where,

V_{e, M_x} = the elution volume for polystyrene with the molecular weight M_x

$V_{e,(10M_x)}$ = the elution volume for polystyrene with a ten times greater molecular weight

The resolution of the system is commonly defined as follows:

$$R_{1,2} = 2 \times \frac{V_{e1} - V_{e2}}{W_1 + W_2} \times \frac{1}{\log_{10}(M_2/M_1)}$$

where,

V_{e1}, V_{e2} = the elution volumes of the two polystyrene standards at the peak maximum

W_1, W_2 = the peak widths at the base-line

M_1, M_2 = the molecular weights at the peak maximum (should differ by a factor of 10).

The R-value for the column system should be greater than 1,7 (4).

▼ B**1.6.9. Solvents**

All solvents must be of high purity (for THF purity of 99,5 % is used). The solvent reservoir (if necessary in an inert gas atmosphere) must be sufficiently large for the calibration of the column and several sample analyses. The solvent must be degassed before it is transported to the column via the pump.

1.6.10. Temperature control

The temperature of the critical internal components (injection loop, columns, detector and tubing) should be constant and consistent with the choice of solvent.

1.6.11. Detector

The purpose of the detector is to record quantitatively the concentration of sample eluted from the column. In order to avoid unnecessary broadening of peaks the cuvette volume of the detector cell must be kept as small as possible. It should not be larger than 10 µl except for light scattering and viscosity detectors. Differential refractometry is usually used for detection. However, if required by the specific properties of the sample or the elution solvent, other types of detectors can be used, e.g. UV/VIS, IR, viscosity detectors, etc.

2. DATA AND REPORTING**2.1. DATA**

The DIN Standard (1) should be referred to for the detailed evaluation criteria as well as for the requirements relating to the collecting and processing of data.

For each sample, two independent experiments must be carried out. They have to be analysed individually. In all cases it is essential to determine also data from blanks, treated under the same conditions as the sample.

It is necessary to indicate explicitly that the measured values are relative values equivalent to the molecular weights of the standard used.

After determination of the retention volumes or the retention times (possibly corrected using an internal standard), $\log M_p$ values (M_p being the peak maxima of the calibration standard) are plotted against one of those quantities. At least two calibration points are necessary per molecular weight decade, and at least five measurement points are required for the total curve, which should cover the estimated molecular weight of the sample. The low molecular weight end-point of the calibration curve is defined by n-hexyl benzene or another suitable non-polar solute. The portion of the curve corresponding to molecular weights below 1 000 is determined and corrected as necessary for impurities and additives. The elution curves are generally evaluated by means of electronic data processing. In case manual digitisation is used, ASTM D 3536-91 can be consulted (3).

▼ B

If any insoluble polymer is retained on the column, its molecular weight is likely to be higher than that of the soluble fraction, and if not considered would result in an overestimation of the low molecular weight content. Guidance for correcting the low molecular weight content for insoluble polymer is provided in the Appendix.

The distribution curve must be provided in the form of a table or as figure (differential frequency or sum percentages against log M). In the graphic representation, one molecular weight decade should be normally about 4 cm in width and the peak maximum should be about 8 cm in height. In the case of integral distribution curves the difference in the ordinate between 0 and 100 % should be about 10 cm.

2.2. TEST REPORT

The test report must include the following information:

2.2.1. Test substance:

- available information about test substance (identity, additives, impurities),
- description of the treatment of the sample, observations, problems.

2.2.2. Instrumentation:

- reservoir of eluent, inert gas, degassing of the eluent, composition of the eluent, impurities,
- pump, pulse dampener, injection system,
- separation columns (manufacturer, all information about the characteristics of the columns, such as pore size, kind of separation material, etc., number, length and order of the columns used),
- number of the theoretical plates of the column (or combination), separation efficiency (resolution of the system),
- information on symmetry of the peaks,
- column temperature, kind of temperature control,
- detector (measurement principle, type, cuvette volume),
- flowmeter if used (manufacturer, measurement principle),
- system to record and process data (hardware and software).

2.2.3. Calibration of the system:

- detailed description of the method used to construct the calibration curve,

▼ B

- information about quality criteria for this method (e.g. correlation coefficient, error sum of squares, etc.),
- information about all extrapolations, assumptions and approximations made during the experimental procedure and the evaluation and processing of data,
- all measurements used for constructing the calibration curve have to be documented in a table which includes the following information for each calibration point:
 - name of the sample,
 - manufacturer of the sample,
 - characteristic values of the standards M_p , M_n , M_w , M_w/M_n , as provided by the manufacturer or derived by subsequent measurements, together with details about the method of determination,
 - injection volume and injection concentration,
 - M_p value used for calibration,
 - elution volume or corrected retention time measured at the peak maxima,
 - M_p calculated at the peak maximum,
 - percentage error of the calculated M_p and the calibration value.

2.2.4. Information on the low molecular weight polymer content:

- description of the methods used in the analysis and the way in which the experiments were conducted,
- information about the percentage of the low molecular weight species content (w/w) related to the total sample,
- information about impurities, additives and other non-polymer species in percentage by weight related to the total sample.

2.2.5. Evaluation:

- evaluation on a time basis: all methods to ensure the required reproducibility (method of correction, internal standard etc.),
- information about whether the evaluation was effected on the basis of the elution volume or the retention time,
- information about the limits of the evaluation if a peak is not completely analysed,
- description of smoothing methods, if used,
- preparation and pre-treatment procedures of the sample,
- the presence of undissolved particles, if any,

▼ B

- injection volume (μl) and injection concentration (mg/ml),
- observations indicating effects which lead to deviations from the ideal GPC profile,
- detailed description of all modifications in the testing procedures,
- details of the error ranges,
- any other information and observations relevant for the interpretation of the results.

3. REFERENCES

- (1) DIN 55672 (1995) Gelpermeationschromatographie (GPC) mit Tetrahydrofuran (THF) als Elutionsmittel, Teil 1.
- (2) Yau, W.W., Kirkland, J.J., and Bly, D.D. eds. (1979) Modern Size Exclusion Liquid Chromatography, J. Wiley and Sons.
- (3) ASTM D 3536-91, (1991) Standard Test method for Molecular Weight Averages and Molecular Weight Distribution by Liquid Exclusion Chromatography (Gel Permeation Chromatography-GPC). American Society for Testing and Materials, Philadelphia, Pennsylvania.
- (4) ASTM D 5296-92, (1992) Standard Test method for Molecular Weight Averages and Molecular Weight Distribution of Polystyrene by High Performance Size-Exclusion Chromatography. American Society for Testing and Materials, Philadelphia, Pennsylvania.

▼ B*Appendix***Guidance for correcting low molecular content for the presence of insoluble polymer**

When insoluble polymer is present in a sample, it results in mass loss during the GPC analysis. The insoluble polymer is irreversibly retained on the column or sample filter while the soluble portion of the sample passes through the column. In the case where the refractive index increment (dn/dc) of the polymer can be estimated or measured, one can estimate the sample mass lost on the column. In that case, one makes a correction using an external calibration with standard materials of known concentration and dn/dc to calibrate the response of the refractometer. In the example hereafter a poly(methyl methacrylate) (pMMA) standard is used.

In the external calibration for analysis of acrylic polymers, a pMMA standard of known concentration in tetrahydrofuran, is analysed by GPC and the resulting data are used to find the refractometer constant according to the equation:

$$K = R/(C \times V \times dn/dc)$$

where:

K = the refractometer constant (in microvolt second/ml),

R = the response of the pMMA standard (in microvolt/second),

C = the concentration of the pMMA standard (in mg/ml),

V = the injection volume (in ml), and

dn/dc = the refractive index increment for pMMA in tetrahydrofuran (in ml/mg).

The following data are typical for a pMMA standard:

R = 2 937 891

C = 1,07 mg/ml

V = 0,1 ml

dn/dc = 9×10^{-5} ml/mg

The resulting K value, $3,05 \times 10^{11}$ is then used to calculate the theoretical detector response if 100 % of the polymer injected had eluted through the detector.

▼ B**A.20. SOLUTION/EXTRACTION BEHAVIOUR OF POLYMERS IN WATER****1. METHOD**

The method described is a replicate of the revised version of OECD TG 120 (1997). Further technical information is given in reference (1).

1.1. INTRODUCTION

For certain polymers, such as emulsion polymers, initial preparatory work may be necessary before the method set out hereafter can be used. The method is not applicable to liquid polymers and to polymers that react with water under the test conditions.

When the method is not practical or not possible, the solution/extraction behaviour may be investigated by means of other methods. In such cases, full details and justification should be given for the method used.

1.2. REFERENCE SUBSTANCES

None.

1.3. PRINCIPLE OF THE TEST METHOD

The solution/extraction behaviour of polymers in an aqueous medium is determined using the flask method (see A.6 Water Solubility, Flask method) with the modifications described below.

1.4. QUALITY CRITERIA

None.

1.5. DESCRIPTION OF THE TEST METHOD**1.5.1. Equipment**

The following equipment is required for the method:

- crushing device, e.g. grinder for the production of particles of known size,
- apparatus for shaking with possibility of temperature control,
- membrane filter system,
- appropriate analytical equipment,
- standardised sieves.

1.5.2. Sample preparation

A representative sample has first to be reduced to a particle size between 0,125 and 0,25 mm using appropriate sieves. Cooling may be required for the stability of the sample or for the grinding process. Materials of a rubbery nature can be crushed at liquid nitrogen temperature (1).

If the required particle size fraction is not attainable, action should be taken to reduce the particle size as much as possible, and the result reported. In the report, it is necessary to indicate the way in which the crushed sample was stored prior to the test

▼ B**1.5.3. Procedure**

Three samples of 10 g of the test substance are weighed into each of three vessels fitted with glass stoppers and 1 000 ml of water is added to each vessel. If handling an amount of 10 g polymer proves impracticable, the next highest amount which can be handled should be used and the volume of water adjusted accordingly.

The vessels are tightly stoppered and then agitated at 20 °C. A shaking or stirring device capable of operating at constant temperature should be used. After a period of 24 hours, the content of each vessel is centrifuged or filtered and the concentration of polymer in the clear aqueous phase is determined by a suitable analytical method. If suitable analytical methods for the aqueous phase are not available, the total solubility/extractivity can be estimated from the dry weight of the filter residue or centrifuged precipitate.

It is usually necessary to differentiate quantitatively between the impurities and additives on the one hand and the low molecular weight species on the other hand. In the case of gravimetric determination, it is also important to perform a blank run using no test substance in order to account for residues arising from the experimental procedure.

The solution/extraction behaviour of polymers in water at 37 °C at pH 2 and pH 9 may be determined in the same way as described for the conduct of the experiment at 20 °C. The pH values can be achieved by the addition of either suitable buffers or appropriate acids or bases such as hydrochloric acid, acetic acid, analytical grade sodium or potassium hydroxide or NH₃.

Depending on the method of analysis used, one or two tests should be performed. When sufficiently specific methods are available for direct analysis of the aqueous phase for the polymer component, one test as described above should suffice. However, when such methods are not available and determination of the solution/extraction behaviour of the polymer is limited to indirect analysis by determining only the total organic carbon content (TOC) of the aqueous extract, an additional test should be conducted. This additional test should also be done in triplicate, using ten times smaller polymer samples and the same amounts of water as those used in the first test.

1.5.4. Analysis**1.5.4.1. Test conducted with one sample size**

Methods may be available for direct analysis of polymer components in the aqueous phase. Alternatively, indirect analysis of dissolved/extracted polymer components, by determining the total content of soluble parts and correcting for non polymer-specific components, could also be considered.

Analysis of the aqueous phase for the total polymeric species is possible:

either by a sufficiently sensitive method, e.g.:

— TOC using persulphate or dichromate digestion to yield CO₂ followed by estimation by IR or chemical analysis,

▼ B

— Atomic Absorption Spectrometry (AAS) or its Inductively Coupled Plasma (ICP) emission equivalent for silicon or metal containing polymers,

— UV absorption or spectrofluorimetry for aryl polymers,

— LC-MS for low molecular weight samples,

or by vacuum evaporation to dryness of the aqueous extract and spectroscopic (IR, UV, etc.) or AAS/ICP analysis of the residue.

If analysis of the aqueous phase as such is not practicable, the aqueous extract should be extracted with a water-immiscible organic solvent e.g. a chlorinated hydrocarbon. The solvent is then evaporated and the residue analysed as above for the notified polymer content. Any components in this residue which are identified as being impurities or additives are to be subtracted for the purpose of determining the degree of solution/extraction of the polymer itself.

When relatively large quantities of such materials are present, it may be necessary to subject the residue to e.g. HPLC or GC analysis to differentiate the impurities from the monomer and monomer-derived species present so that the true content of the latter can be determined.

In some cases, simple evaporation of the organic solvent to dryness and weighing the dry residue may be sufficient.

1.5.4.2. *Test conducted with two different sample sizes*

All aqueous extracts are analysed for TOC.

A gravimetric determination is performed on the undissolved/not extracted part of the sample. If, after centrifugation or filtering of the content of each vessel, polymer residues remain attached to the wall of the vessel, the vessel should be rinsed with the filtrate until the vessel is cleared from all visible residues. Following which, the filtrate is again centrifuged or filtered. The residues remaining on the filter or in the centrifuge tube are dried at 40 °C under vacuum and weighed. Drying is continued until a constant weight is reached.

2. DATA

2.1. TEST CONDUCTED WITH ONE SAMPLE SIZE

The individual results for each of the three flasks and the average values should be given and expressed in units of mass per volume of the solution (typically mg/l) or mass per mass of polymer sample (typically mg/g). Additionally, the weight loss of the sample (calculated as the weight of the solute divided by the weight of the initial sample) should also be given. The relative standard deviations (RSD) should be calculated. Individual figures should be given for the total substance (polymer + essential additives, etc.) and for the polymer only (i.e. after subtracting the contribution from such additives).

▼ B**2.2. TEST CONDUCTED WITH TWO DIFFERENT SAMPLE SIZES**

The individual TOC values of the aqueous extracts of the two triplicate experiments and the average value for each experiment should be given expressed as units of mass per volume of solution (typically mgC/l), as well as in units of mass per weight of the initial sample (typically mgC/g).

If there is no difference between the results at the high and the low sample/water ratios, this may indicate that all extractable components were indeed extracted. In such a case, direct analysis would normally not be necessary.

The individual weights of the residues should be given and expressed in percentage of the initial weights of the samples. Averages should be calculated per experiment. The differences between 100 and the percentages found represent the percentages of soluble and extractable material in the original sample.

3. REPORTING**3.1. TEST REPORT**

The test report must include the following information:

3.1.1. Test substance:

— available information about test substance (identity, additives, impurities, content of low molecular weight species).

3.1.2. Experimental conditions:

— description of the procedures used and experimental conditions,
— description of the analytical and detection methods.

3.1.3. Results:

— results of solubility/extractivity in mg/l; individual and mean values for the extraction tests in the various solutions, broken down in polymer content and impurities, additives, etc.,
— results of solubility/extractivity in mg/g of polymer,
— TOC values of aqueous extracts, weight of the solute and calculated percentages, if measured,
— the pH of each sample,
— information about the blank values,
— where necessary, references to the chemical instability of the test substance, during both the testing process and the analytical process,
— all information which is important for the interpretation of the results.

4. REFERENCES

(1) DIN 53733 (1976) Zerkleinerung von Kunststoffergezeugnissen für Prüfzwecke.

▼B**A.21. OXIDISING PROPERTIES (LIQUIDS)****1. METHOD****1.1. INTRODUCTION**

This test method is designed to measure the potential for a liquid substance to increase the burning rate or burning intensity of a combustible substance, or to form a mixture with a combustible substance which spontaneously ignites, when the two are thoroughly mixed. It is based on the UN test for oxidising liquids (1) and is equivalent to it. However, as this method A.21 is primarily designed to satisfy the requirements of Regulation (EC) No 1907/2006, comparison with only one reference substance is required. Testing and comparison to additional reference substances may be necessary when the results of the test are expected to be used for other purposes. (1)

This test need not be performed when examination of the structural formula establishes beyond reasonable doubt that the substance is incapable of reacting exothermically with a combustible material.

It is useful to have preliminary information on any potential explosive properties of the substance before performing this test.

This test is not applicable to solids, gases, explosive or highly flammable substances, or organic peroxides.

This test may not need to be performed when results for the test substance in the UN test for oxidising liquids (1) are already available.

1.2. DEFINITIONS AND UNITS

Mean pressure rise time is the mean of the measured times for a mixture under test to produce a pressure rise from 690 kPa to 2 070 kPa above atmospheric.

1.3. REFERENCE SUBSTANCE

65 % (w/w) aqueous nitric acid (analytical grade) is required as a reference substance. (2)

(1) As, for example, in the framework of UN transport regulations.

(2) The acid should be titrated before testing to confirm its concentration.

▼ B

Optionally, if the experimenter foresees that the results of this test may eventually be used for other purposes ⁽¹⁾, testing of additional reference substances may also be appropriate. ⁽²⁾

1.4. PRINCIPLE OF THE TEST METHOD

The liquid to be tested is mixed in a 1 to 1 ratio, by mass, with fibrous cellulose and introduced into a pressure vessel. If during mixing or filling spontaneous ignition occurs, no further testing is necessary.

If spontaneous ignition does not occur the full test is carried out. The mixture is heated in a pressure vessel and the mean time taken for the pressure to rise from 690 kPa to 2 070 kPa above atmospheric is determined. This is compared with the mean pressure rise time for the 1:1 mixture of the reference substance(s) and cellulose.

1.5. QUALITY CRITERIA

In a series of five trials on a single substance no results should differ by more than 30 % from the arithmetic mean. Results that differ by more than 30 % from the mean should be discarded, the mixing and filling procedure improved and the testing repeated.

1.6. DESCRIPTION OF THE METHOD**1.6.1. Preparation****1.6.1.1. Combustible substance**

Dried, fibrous cellulose with a fibre length between 50 and 250 µm and a mean diameter of 25 µm ⁽³⁾, is used as the combustible material. It is dried to constant weight in a layer not more than 25 mm thick at 105 °C for four hours and kept in a desiccator, with desiccant, until cool and required for use. The water content of the dried cellulose should be less than 0,5 % by dry mass ⁽⁴⁾. If necessary, the drying time should be prolonged to achieve this. ⁽⁵⁾ The same batch of cellulose is to be used throughout the test.

⁽¹⁾ As, for example, in the framework of UN transport regulations.

⁽²⁾ E.g.: 50 % (w/w) perchloric acid and 40 % (w/w) sodium chlorate are used in reference 1.

⁽³⁾ E.g. Whatman Column Chromatographic Cellulose Powder CF 11, catalogue No 4021 050.

⁽⁴⁾ Confirmed by, e.g. Karl-Fisher titration.

⁽⁵⁾ Alternatively, this water content can also be achieved by, e.g. heating at 105 °C under vacuum for 24 h.

▼B1.6.1.2. *Apparatus*

1.6.1.2.1. Pressure vessel

A pressure vessel is required. The vessel consists of a cylindrical steel pressure vessel 89 mm in length and 60 mm in external diameter (see figure 1). Two flats are machined on opposite sides (reducing the cross-section of the vessel to 50 mm) to facilitate holding whilst fitting up the firing plug and vent plug. The vessel, which has a bore of 20 mm diameter is internally rebated at either end to a depth of 19 mm and threaded to accept 1" British Standard Pipe (BSP) or metric equivalent. A pressure take-off, in the form of a side arm, is screwed into the curved face of the pressure vessel 35 mm from one end and at 90° to the machined flats. The socket for this is bored to a depth of 12 mm and threaded to accept the 1/2" BSP (or metric equivalent) thread on the end of the side-arm. If necessary, an inert seal is fitted to ensure a gas-tight seal. The side-arm extends 55 mm beyond the pressure vessel body and has a bore of 6 mm. The end of the side-arm is rebated and threaded to accept a diaphragm type pressure transducer. Any pressure-measuring device may be used provided that it is not affected by the hot gases or the decomposition products and is capable of responding to rates of pressure rise of 690-2 070 kPa in not more than 5 ms.

The end of the pressure vessel farthest from the side-arm is closed with a firing plug which is fitted with two electrodes, one insulated from, and the other earthed to, the plug body. The other end of the pressure vessel is closed by a bursting disk (bursting pressure approximately 2 200 kPa) held in place with a retaining plug which has a 20 mm bore. If necessary, an inert seal is used with the firing plug to ensure a gas-tight fit. A support stand (figure 2) holds the assembly in the correct attitude during use. This usually comprises a mild steel base plate measuring 235 mm × 184 mm × 6 mm and a 185 mm length of square hollow section (S.H.S.) 70 mm × 70 mm × 4 mm.

A section is cut from each of two opposite sides at one end of the length of S.H.S. so that a structure having two flat sided legs surmounted by 86 mm length of intact box section results. The ends of these flat sides are cut to an angle of 60° to the horizontal and welded to the base plate. A slot measuring 22 mm wide × 46 mm deep is machined in one side of the upper end of the base section such that when the pressure vessel assembly is lowered, firing plug end first, into the box section support, the side-arm is accommodated in the slot. A piece of steel 30 mm wide and 6 mm thick is welded to the lower internal face of the box section to act as a spacer. Two 7 mm thumb screws, tapped into the opposite face, serve to hold the pressure vessel firmly in place. Two 12 mm wide strips of 6 mm thick steel, welded to the side pieces abutting the base of the box section, support the pressure vessel from beneath.

▼B

1.6.1.2.2. Ignition system

The ignition system consists of a 25 cm long Ni/Cr wire with a diameter 0,6 mm and a resistance of 3,85 ohm/m. The wire is wound, using a 5 mm diameter rod, in the shape of a coil and is attached to the firing plug electrodes. The coil should have one of the configurations shown in figure 3. The distance between the bottom of the vessel and the underside of the ignition coil should be 20 mm. If the electrodes are not adjustable, the ends of the ignition wire between the coil and the bottom of the vessel should be insulated by a ceramic sheath. The wire is heated by a constant current power supply able to deliver at least 10 A.

1.6.2. **Performance of the test** ⁽¹⁾

The apparatus, assembled complete with pressure transducer and heating system but without the bursting disk in position, is supported firing plug end down. 2,5 g of the liquid to be tested is mixed with 2,5 g of dried cellulose in a glass beaker using a glass stirring rod ⁽²⁾. For safety, the mixing should be performed with a safety shield between the operator and mixture. If the mixture ignites during mixing or filling, no further testing is necessary. The mixture is added, in small portions with tapping, to the pressure vessel making sure that the mixture is packed around the ignition coil and is in good contact with it. It is important that the coil is not distorted during the packing process as this may lead to erroneous results ⁽³⁾. The bursting disk is placed in position and the retaining plug is screwed in tightly. The charged vessel is transferred to the firing support stand, bursting disk uppermost, which should be located in a suitable, armoured fume cupboard or firing cell. The power supply is connected to the external terminals of the firing plug and 10 A applied. The time between the start of mixing and switching on the power should not exceed 10 minutes.

The signal produced by the pressure transducer is recorded on a suitable system which allows both evaluation and the generation of a permanent record of the time pressure profile obtained (e.g. a transient recorder coupled to a chart recorder). The mixture is heated until the bursting disk ruptures or until at least 60 s have elapsed. If the bursting disk does not rupture, the mixture should be allowed to cool before carefully dismantling the apparatus, taking precautions to allow for any pressurisation which may occur. Five trials are performed with the test substance and the reference substance(s). The time taken for the pressure to rise from 690 kPa to 2 070 kPa above atmospheric is noted. The mean pressure rise time is calculated.

In some cases, substances may generate a pressure rise (too high or too low), caused by chemical reactions not characterising the oxidising properties of the substance. In these cases, it may be necessary to repeat the test with an inert substance, e.g. diatomite (kieselguhr), in place of the cellulose in order to clarify the nature of the reaction.

⁽¹⁾ Mixtures of oxidisers with cellulose must be treated as potentially explosive and handled with due care.

⁽²⁾ In practice this can be achieved by preparing a 1:1 mixture of the liquid to be tested and cellulose in a greater amount than needed for the trial and transferring 5 ± 0,1 g to the pressure vessel. The mixture is to be freshly prepared for each trial.

⁽³⁾ In particular, contact between the adjacent turns of the coil must be avoided.

▼B**2. DATA**

Pressure rise times for both the test substance and the reference substance(s). Pressure rise times for the tests with an inert substance, if performed.

2.1. TREATMENT OF RESULTS

The mean pressure rise times for both the test substance and the reference substances(s) are calculated.

The mean pressure rise time for the tests with an inert substance (if performed) is calculated.

Some examples of results are shown in Table 1.

Table 1
Examples of results ^(a)

Substance ^(b)	Mean pressure rise time for a 1:1 mixture with cellulose (ms)
Ammonium dichromate, saturated aqueous solution	20 800
Calcium nitrate, saturated aqueous solution	6 700
Ferric nitrate, saturated aqueous solution	4 133
Lithium perchlorate, saturated aqueous solution	1 686
Magnesium perchlorate, saturated aqueous solution	777
Nickel nitrate, saturated aqueous solution	6 250
Nitric acid, 65 %	4 767 ^(c)
Perchloric acid, 50 %	121 ^(c)
Perchloric acid, 55 %	59
Potassium nitrate, 30 % aqueous solution	26 690
Silver nitrate, saturated aqueous solution	^(d)
Sodium chlorate, 40 % aqueous solution	2 555 ^(c)
Sodium nitrate, 45 % aqueous solution	4 133
<i>Inert substance</i>	
Water: cellulose	^(d)

^(a) See reference (1) for classification under the UN transport scheme.

^(b) Saturated solutions should be prepared at 20 °C.

^(c) Mean value from interlaboratory comparative trials.

^(d) Maximum pressure of 2 070 kPa not reached.

▼B**3. REPORT****3.1. TEST REPORT**

The test report should include the following information:

- the identity, composition, purity, etc. of the substance tested,
- the concentration of the test substance,
- the drying procedure of the cellulose used,
- the water content of the cellulose used,
- the results of the measurements,
- the results from tests with an inert substance, if any,
- the calculated mean pressure rise times,
- any deviations from this method and the reasons for them,
- all additional information or remarks relevant to the interpretation of the results.

3.2. INTERPRETATION OF THE RESULTS ⁽¹⁾

The test results are assessed on the basis of:

- (a) whether the mixture of test substance and cellulose spontaneously ignites; and
- (b) the comparison of the mean time taken for the pressure to rise from 690 kPa to 2 070 kPa with that of the reference substance(s).

A liquid substance is to be considered as an oxidiser when:

- (a) a 1:1 mixture, by mass, of the substance and cellulose spontaneously ignites; or
- (b) a 1:1 mixture, by mass, of the substance and cellulose exhibits a mean pressure rise time less than or equal to the mean pressure rise time of a 1:1 mixture, by mass, of 65 % (w/w) aqueous nitric acid and cellulose.

In order to avoid a false positive result, if necessary, the results obtained when testing the substance with an inert material should also be considered when interpreting the results.

⁽¹⁾ See reference 1 for interpretation of the results under the UN transport regulations using several reference substances.

▼B

4. REFERENCES

- (1) Recommendations on the Transport of Dangerous Goods, Manual of Tests and Criteria. 3rd revised edition. UN Publication No: ST/SG/AC.10/11/Rev. 3, 1999, page 342. Test O.2: Test for oxidising liquids.

Figure 1

Pressure vessel

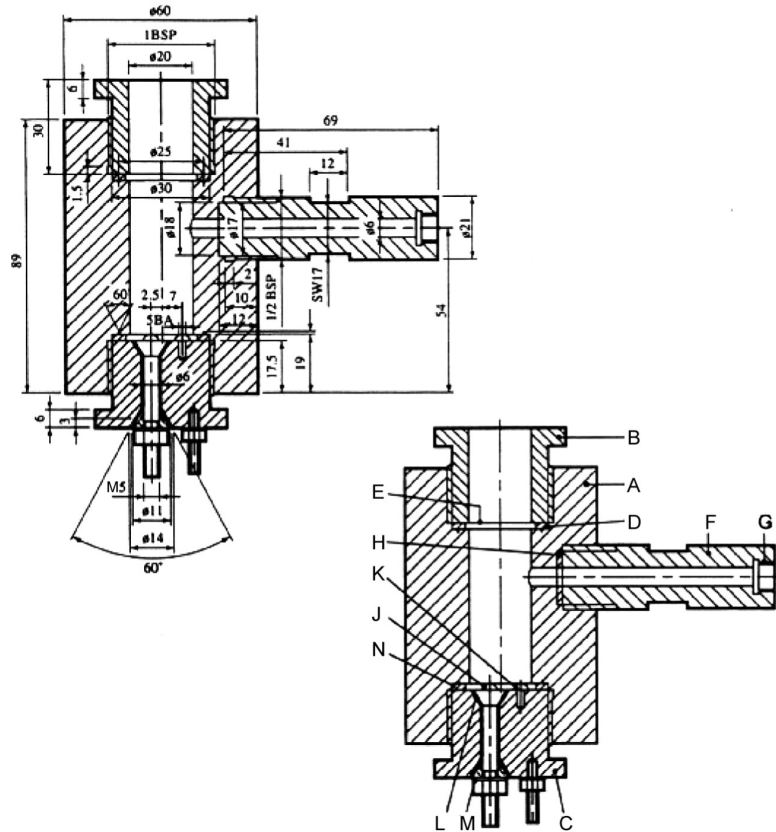

- | | | |
|------------------------------|----------------------------------|-------------------------|
| (A) Pressure vessel body | (B) Bursting disk retaining plug | (C) Firing plug |
| (D) Soft lead washer | (E) Bursting disc | (F) Side arm |
| (G) Pressure transducer head | (H) Washer | (J) Insulated electrode |
| (K) Earthed electrode | (L) Insulation | (M) Steel cone |
| (N) Washer distorting groove | | |

▼B

Figure 2
Support stand

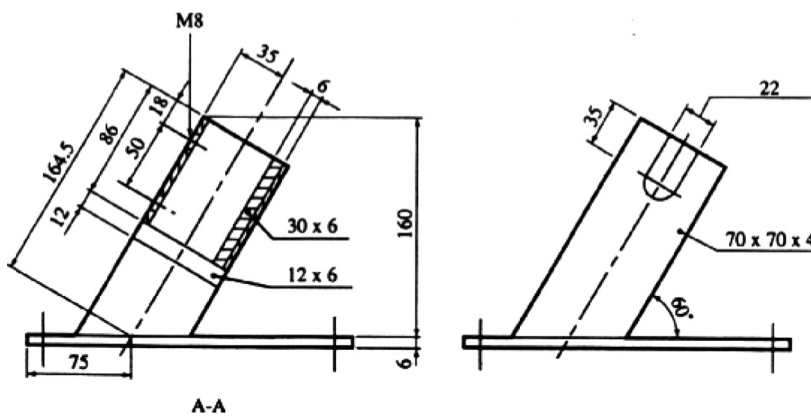
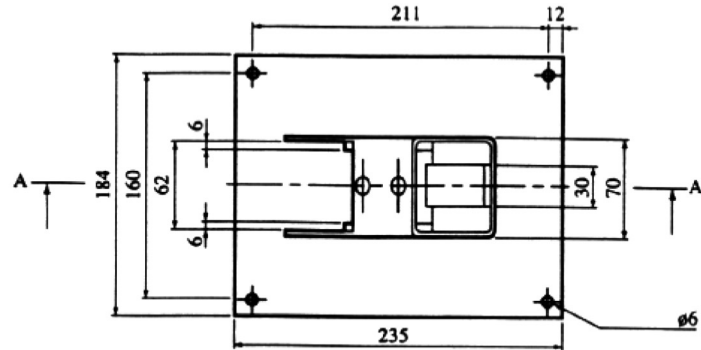
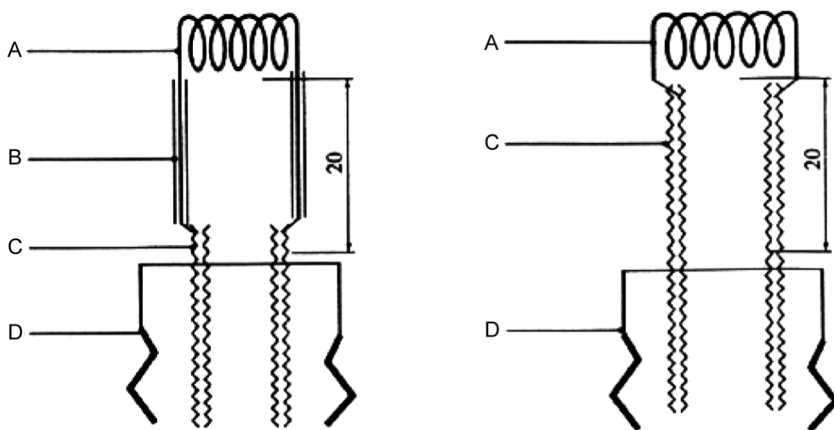

Figure 3
Ignition system

- (A) Ignition coil (B) Insulation (C) Electrodes (D) Firing plug



Note: either of these configurations may be used.

▼ M1**A.22. LENGTH WEIGHTED GEOMETRIC MEAN DIAMETER OF FIBRES****1. METHOD****1.1. INTRODUCTION**

This method describes a procedure to measure the Length Weighted Geometric Mean Diameter (LWGMD) of bulk Man Made Mineral Fibres (MMMMF). As the LWGMD of the population will have a 95 % probability of being between the 95 % confidence levels (LWGMD \pm two standard errors) of the sample, the value reported (the test value) will be the lower 95 % confidence limit of the sample (i.e. LWGMD — 2 standard errors). The method is based on an update (June 1994) of a draft HSE industry procedure agreed at a meeting between ECFIA and HSE at Chester on 26/9/93 and developed for and from a second inter-laboratory trial (1, 2). This measurement method can be used to characterise the fibre diameter of bulk substances or products containing MMMFs including refractory ceramic fibres (RCF), man-made vitreous fibres (MMVF), crystalline and polycrystalline fibres.

Length weighting is a means of compensating for the effect on the diameter distribution caused by the breakage of long fibres when sampling or handling the material. Geometric statistics (geometric mean) are used to measure the size distribution of MMMF diameters because these diameters usually have size distributions that approximate to log normal.

Measuring length as well as diameter is both tedious and time consuming but, if only those fibres that touch an infinitely thin line on a SEM field of view are measured, then the probability of selecting a given fibre is proportional to its length. As this takes care of the length in the length weighting calculations, the only measurement required is the diameter and the LWGMD-2SE can be calculated as described.

1.2. DEFINITIONS

Particle: An object with a length to width ratio of less than 3:1.

Fibre: An object with a length to width ratio (aspect ratio) of at least 3:1.

1.3. SCOPE AND LIMITATIONS

The method is designed to look at diameter distributions which have median diameters from 0,5 μm to 6 μm . Larger diameters can be measured by using lower SEM magnifications but the method will be increasingly limited for finer fibre distributions and a TEM (transmission electron microscope) measurement is recommended if the median diameter is below 0,5 μm .

▼ M1

1.4. PRINCIPLE OF THE TEST METHOD

A number of representative core samples are taken from the fibre blanket or from loose bulk fibre. The bulk fibres are reduced in length using a crushing procedure and a representative sub-sample dispersed in water. Aliquots are extracted and filtered through a 0,2 µm pore size, polycarbonate filter and prepared for examination using scanning electron microscope (SEM) techniques. The fibre diameters are measured at a screen magnification of $\times 10\,000$ or greater⁽¹⁾ using a line intercept method to give an unbiased estimate of the median diameter. The lower 95 % confidence interval (based on a one sided test) is calculated to give an estimate of the lowest value of the geometric mean fibre diameter of the material.

1.5. DESCRIPTION OF THE TEST METHOD

1.5.1. **Safety/precautions**

Personal exposure to airborne fibres should be minimised and a fume cupboard or glove box should be used for handling the dry fibres. Periodic personal exposure monitoring should be carried out to determine the effectiveness of the control methods. When handling MMMF's disposable gloves should be worn to reduce skin irritation and to prevent cross-contamination.

1.5.2. **Apparatus/equipment**

- Press and dyes (capable of producing 10 MPa).
- 0,2 µm pore size polycarbonate capillary pore filters (25 mm diameter).
- 5 µm pore size cellulose ester membrane filter for use as a backing filter.
- Glass filtration apparatus (or disposable filtration systems) to take 25 mm diameter filters (e.g. Millipore glass microanalysis kit, type No XX10 025 00).
- Freshly distilled water that has been filtered through a 0,2 µm pore size filter to remove micro-organisms.
- Sputter coater with a gold or gold/palladium target.
- Scanning electron microscope capable of resolving down to 10 nm and operating at $\times 10\,000$ magnification.
- Miscellaneous: spatulas, type 24 scalpel blade, tweezers, SEM tubes, carbon glue or carbon adhesive tape, silver dag.
- Ultrasonic probe or bench top ultrasonic bath.
- Core sampler or cork borer, for taking core samples from MMMF blanket.

⁽¹⁾ This magnification value is indicated for 3 µm fibres, for 6 µm fibres a magnification of $\times 5\,000$ may be more suitable.

▼ M1**1.5.3. Test Procedure****1.5.3.1. Sampling**

For blankets and bats a 25 mm core sampler or cork borer is used to take samples of the cross-section. These should be equally spaced across the width of a small length of the blanket or taken from random areas if long lengths of the blanket are available. The same equipment can be used to extract random samples from loose fibre. Six samples should be taken when possible, to reflect spatial variations in the bulk material.

The six core samples should be crushed in a 50 mm diameter dye at 10 MPa. The material is mixed with spatula and re-pressed at 10 MPa. The material is then removed from the dye and stored in a sealed glass bottle.

1.5.3.2. Sample Preparation

If necessary, organic binder can be removed by placing the fibre inside a furnace at 450 °C for about one hour.

Cone and quarter to subdivide the sample (this should be done inside a dust cupboard).

Using a spatula, add a small amount (< 0,5 g) of sample to 100 ml of freshly distilled water that has been filtered through a 0,2 µm membrane filter (alternative sources of ultra pure water may be used if they are shown to be satisfactory). Disperse thoroughly by the use of an ultrasonic probe operated at 100 W power and tuned so that cavitation occurs. (If a probe is not available use the following method: repeatedly shake and invert for 30 seconds; ultrasonic in a bench top ultrasonic bath for five minutes; then repeatedly shake and invert for a further 30 seconds.)

Immediately after dispersion of the fibre, remove a number of aliquots (e.g. three aliquots of 3, 6 and 10 ml) using a wide-mouthed pipette (2-5 ml capacity).

Vacuum filter each aliquot through a 0,2 µm polycarbonate filter supported by a 5 µm pore MEC backing filter, using a 25 mm glass filter funnel with a cylindrical reservoir. Approximately 5 ml of filtered distilled water should be placed into the funnel and the aliquot slowly pipetted into the water holding the pipette tip below the meniscus. The pipette and the reservoir must be flushed thoroughly after pipetting, as thin fibres have a tendency to be located more on the surface.

Carefully remove the filter and separate it from the backing filter before placing it in a container to dry.

▼ M1

Cut a quarter or half filter section of the filtered deposit with a type 24 scalpel blade using a rocking action. Carefully attach the cut section to a SEM stub using a sticky carbon tab or carbon glue. Silver dag should be applied in at least three positions to improve the electrical contact at the edges of the filter and the stub. When the glue/silver dag is dry, sputter coat approximately 50 nm of gold or gold/palladium onto the surface of the deposit.

1.5.3.3. *SEM calibration and operation*

1.5.3.3.1. Calibration

The SEM calibration should be checked at least once a week (ideally once a day) using a certified calibration grid. The calibration should be checked against a certified standard and if the measured value (SEM) is not within $\pm 2\%$ of the certified value, then the SEM calibration must be adjusted and re-checked.

The SEM should be capable of resolving at least a minimum visible diameter of 0,2 μm , using a real sample matrix, at a magnification of $\times 2\,000$.

1.5.3.3.2. Operation

The SEM should be operated at 10 000 magnification⁽¹⁾ using conditions that give good resolution with an acceptable image at slow scan rates of, for example, 5 seconds per frame. Although the operational requirements of different SEMs may vary, generally to obtain the best visibility and resolution, with relatively low atomic weight materials, accelerating voltages of 5-10 keV should be used with a small spot size setting and short working distance. As a linear traverse is being conducted, then a 0° tilt should be used to minimise re-focussing or, if the SEM has a eucentric stage, the eucentric working distance should be used. Lower magnification may be used if the material does not contain small (diameter) fibres and the fibre diameters are large ($> 5\ \mu\text{m}$).

1.5.3.4. *Sizing*

1.5.3.4.1. Low magnification examination to assess the sample

Initially the sample should be examined at low magnification to look for evidence of clumping of large fibres and to assess the fibre density. In the event of excessive clumping it is recommended that a new sample is prepared.

For statistical accuracy it is necessary to measure a minimum number of fibres and high fibre density may seem desirable as examining empty fields is time consuming and does not contribute to the analysis. However, if the filter is overloaded, it becomes difficult to measure all the measurable fibres and, because small fibres may be obscured by larger ones, they may be missed.

⁽¹⁾ For 3 μm fibres, see previous note.

▼ M1

Bias towards over estimating the LWGMD may result from fibre densities in excess of 150 fibres per millimetre of linear traverse. On the other hand, low fibre concentrations will increase the time of analysis and it is often cost effective to prepare a sample with a fibre density closer to the optimum than to persist with counts on low concentration filters. The optimum fibre density should give an average of about one or two countable fibre per fields of view at 5 000 magnification. Nevertheless the optimum density will depend on the size (diameter) of the fibres, so it is necessary that the operator uses some expert judgement in order to decide whether the fibre density is close to optimal or not.

1.5.3.4.2. Length weighting of the fibre diameters

Only those fibres that touch (or cross) an (infinitely) thin line drawn on the screen of the SEM are counted. For this reason a horizontal (or vertical) line is drawn across the centre of the screen.

Alternatively a single point is placed at the centre of the screen and a continuous scan in one direction across the filter is initiated. Each fibre of aspect ratio greater than 3:1 touching or crossing this point has its diameter measured and recorded.

1.5.3.4.3. Fibre sizing

It is recommended that a minimum of 300 fibres are measured. Each fibre is measured only once at the point of intersection with the line or point drawn on the image (or close to the point of intersection if the fibre edges are obscured). If fibres with non-uniform cross sections are encountered, a measurement representing the average diameter of the fibre should be used. Care should be taken in defining the edge and measuring the shortest distance between the fibre edges. Sizing may be done on line, or off-line on stored images or photographs. Semi-automated image measurement systems that download data directly into a spreadsheet are recommended, as they save time, eliminate transcription errors and calculations can be automated.

The ends of long fibres should be checked at low magnification to ensure that they do not curl back into the measurement field of view and are only measured once.

2. DATA

2.1. TREATMENT OF RESULTS

Fibre diameters do not usually have a normal distribution. However, by performing a log transformation it is possible to obtain a distribution that approximates to normal.

Calculate the arithmetic mean (mean lnD) and the standard deviation ($SD_{\ln D}$) of the log to base e values (lnD) of the n fibre diameters (D).

$$\text{mean } \ln D = \frac{\sum \ln D}{n} \quad (1)$$

▼ M1

$$SD_{\ln D} = \sqrt{\frac{\sum(\ln D - \text{mean } \ln D)^2}{n - 1}} \quad (2)$$

The standard deviation is divided by the square root of the number of measurements (n) to obtain the standard error (SE_{lnD}).

$$SE_{\ln D} = \frac{SD}{\sqrt{n}} \quad (3)$$

Subtract two times the standard error from the mean and calculate the exponential of this value (mean minus two standard errors) to give the geometric mean minus two geometric standard errors.

$$LWGMD - 2SE = e^{(\text{mean } \ln D - 2SE_{\ln D})} \quad (4)$$

3. REPORTING**TEST REPORT**

The test report should include at least the following information:

- The value of LWGMD-2SE.
- Any deviations and particularly those which may have an effect on the precision or accuracy of the results with appropriate justifications.

4. REFERENCES

1. B. Tylee SOP MF 240. Health and Safety Executive, February 1999.
2. G. Burdett and G. Revell. Development of a standard method to measure the length-weighted geometric mean fibre diameter: Results of the Second inter-laboratory exchange. IR/L/MF/94/07. Project R42.75 HPD. Health and Safety Executive, Research and Laboratory Services Division, 1994.

▼ M4**A.23. PARTITION COEFFICIENT (1-OCTANOL/WATER):
SLOW-STIRRING METHOD**

INTRODUCTION

1. This Test Method is equivalent to OECD Test Guideline (TG) 123 (2006). 1-octanol/water partition coefficient (P_{OW}) values up to a log P_{OW} of 8,2 have been accurately determined by the slow-stirring method (1). Therefore it is a suitable experimental approach for the direct determination of P_{OW} of highly hydrophobic substances.
2. Other methods for the determination of the 1-octanol/water partition coefficient (P_{OW}) are the 'shake-flask' method (2), and the determination of the P_{OW} from reversed phase HPLC-retention behaviour (3). The 'shake-flask' method is prone to artifacts due to transfer of octanol micro-droplets into the aqueous phase. With increasing values of P_{OW} the presence of these droplets in the aqueous phase leads to an increasing overestimation of the concentration of the test substance in the water. Therefore, its use is limited to substances with log $P_{OW} < 4$. The second method relies on solid data of directly determined P_{OW} values to calibrate the relationship between HPLC-retention behaviour and measured values of P_{OW} . A draft OECD guideline was available for determining 1-octanol/water partition coefficients of ionisable substances (4) but shall no longer be used.
3. This Test Method has been developed in The Netherlands. The precision of the methods described here has been validated and optimized in a ring-test validation study in which 15 laboratories participated (5).

INITIAL CONSIDERATIONS

Significance and use

4. For inert organic substances highly significant relationships have been found between 1-octanol/water partition coefficients (P_{OW}) and their bioaccumulation in fish. Moreover, P_{OW} has been demonstrated to be correlated to fish toxicity as well as to sorption of chemicals to solids such as soils and sediments. An extensive overview of the relationships has been given in reference (6).
5. A wide variety of relationships between the 1-octanol/water partition coefficient and other substance properties of relevance to environmental toxicology and chemistry have been established. As a consequence, the 1-octanol/water partition coefficient has evolved as a key parameter in the assessment of the environmental risk of chemicals as well as in the prediction of fate of chemicals in the environment.

Scope

6. The slow-stirring experiment is thought to reduce the formation of micro-droplets from 1-octanol droplets in the water phase. As a consequence, overestimation of the aqueous concentration due to test substance molecules associated to such droplets does not occur. Therefore, the slow-stirring method is particularly suitable for the determination of P_{OW} for substances with expected log P_{OW} values of 5 and higher, for which the shake-flask method (2) is prone to yield erroneous results.

▼M4

DEFINITION AND UNITS

7. The partition coefficient of a substance between water and a lipophilic solvent (1-octanol) characterizes the equilibrium distribution of the chemical between the two phases. The partition coefficient between water and 1-octanol (P_{OW}) is defined as the ratio of the equilibrium concentrations of the test substance in 1-octanol saturated with water (C_O) and water saturated with 1-octanol (C_W).

$$P_{OW} = C_O/C_W$$

As a ratio of concentrations it is dimensionless. Most frequently it is given as the logarithm to the base 10 ($\log P_{OW}$). P_{OW} is temperature dependent and reported data should include the temperature of the measurement.

PRINCIPLE OF THE METHOD

8. In order to determine the partitioning coefficient, water, 1-octanol, and the test substance are equilibrated with each other at constant temperature. Then the concentrations of the test substance in the two phases are determined.
9. The experimental difficulties associated with the formation of micro-droplets during the shake-flask experiment can be reduced in the slow-stirring experiment proposed here. In the slow-stirring experiment, water, 1-octanol and the test substance are equilibrated in a thermostated stirred reactor. Exchange between the phases is accelerated by stirring. The stirring introduces limited turbulence which enhances the exchange between 1-octanol and water without micro-droplets being formed (1).

APPLICABILITY OF THE TEST

10. Since the presence of substances other than the test substance might influence the activity coefficient of the test substance, the test substance should be tested as a pure substance. The highest purity commercially available should be employed for the 1-octanol/water partition experiment.
11. The present method applies to pure substances that do not dissociate or associate and that do not display significant interfacial activity. It can be applied to determine the 1-octanol/water partition ratio of such substances and of mixtures. When the method is used for mixtures, the 1-octanol/water partition ratios determined are conditional and depend on the chemical composition of the mixture tested and on the electrolyte composition employed as aqueous phase. Provided additional steps are taken, the method is also applicable to dissociating or associating compounds (paragraph 12).
12. Due to the multiple equilibria in water and 1-octanol involved in the 1-octanol/water partitioning of dissociating substances such as organic acids and phenols, organic bases, and organometallic substances, the 1-octanol/water partition ratio is a conditional constant strongly dependent on electrolyte composition (7)(8). Determination of the 1-octanol/water partition ratio therefore requires that pH and electrolyte composition be controlled in the experiment and reported. Expert judgement has to be employed in the evaluation of these partition ratios. Using the value of dissociation constant(s), suitable pH-values need to be selected, such that a partitioning ratio is determined for each ionization state. Non-complexing buffers must be used when testing organometallic compounds (8). Taking the existing knowledge on the aqueous chemistry (complexation constants, dissociation constants) into account, the experimental conditions should be chosen in such a manner that the speciation of the test substance in the aqueous phase can be estimated. The ionic strength should be identical in all experiments by employing a background electrolyte.

▼M4

13. Difficulties in the test may arise in conducting the test for substances with low water solubility or high P_{OW} , due to the fact that the concentrations in the water become very low such that their accurate determination is difficult. This Test Method provides guidance on how to deal with this problem.

INFORMATION ON THE TEST SUBSTANCE

14. Chemical reagents should be of analytical grade or of higher purity. The use of non-labelled test substances with known chemical composition and preferably at least 99 % purity, or of radiolabelled test substances with known chemical composition and radiochemical purity, is recommended. In the case of short half-life tracers, decay corrections should be applied. In the case of radiolabelled test substances, a chemical specific analytical method should be employed to ensure that the measured radioactivity is directly related to the test substance.
15. An estimate of $\log P_{OW}$ may be obtained by using commercially available software for estimation of $\log P_{OW}$, or by using the ratio of the solubilities in both solvents.
16. Before carrying out a slow-stirring experiment for determination of P_{OW} , the following information on the test substance should be available:
- (a) structural formula
 - (b) suitable analytical methods for determination of the concentration of the substance in water and 1-octanol
 - (c) dissociation constant(s) of ionisable substances (OECD Guideline 112 (9))
 - (d) aqueous solubility (10)
 - (e) abiotic hydrolysis (11)
 - (f) ready biodegradability (12)
 - (g) vapour pressure (13).

DESCRIPTION OF THE METHOD

Equipment and apparatus

17. Standard laboratory equipment is required, in particular, the following:
- magnetic stirrers and Teflon coated magnetic stir bars are employed to stir the water phase;
 - analytical instrumentation, suitable for determination of the concentration of the test substance at the expected concentrations;
 - stirring-vessel with a tap at the bottom. Dependent on the estimate of $\log P_{OW}$ and the Limit of Detection (LOD) of the test compound, the use of a reaction vessel of the same geometry larger than one litre has to be considered, so that a sufficient volume of water can be obtained for chemical extraction and analysis. This will result in higher concentrations in the water extract and thus a more reliable analytical determination. A table giving estimates of the minimum volume needed, the LOD of the compound, its estimated $\log P_{OW}$ and its water solubility is given in Appendix 1. The table is based on the relationship between $\log P_{OW}$ and the ratio between the solubilities in octanol and water, as presented by Pinsuwan *et al.* (14):

$$\log P_{OW} = 0,88 \log SR + 0,41$$

▼ M4

where

$$SR = S_{\text{oct}}/S_w \text{ (in molarity);}$$

and the relationship given by Lyman (15) for predicting water solubility. Water solubilities calculated with the equation given in Appendix 1 must be seen as a first estimate. It should be noted that the user is free to generate an estimate of water solubility by means of any relationship that is considered to better represent the relationship between hydrophobicity and solubility. For solid compounds, inclusion of melting point in the prediction of solubility is for instance recommended. In case a modified equation is used, it should be ascertained that the equation for calculation of solubility in octanol is still valid. A schematic drawing of a glass-jacketed stirring-vessel with a volume of ca. one litre is given in Appendix 2. The proportions of the vessel shown in Appendix 2 have proven favourable and should be maintained when apparatus of a different size is used;

— a means for keeping the temperature constant during the slow-stirring experiment is essential.

18. Vessels should be made from inert material such that adsorption to vessel surfaces is negligible.

Preparation of the test solutions

19. The P_{OW} determination should be carried out with the highest purity 1-octanol that is commercially available (at least + 99 %). Purification of 1-octanol by extraction with acid, base and water and subsequent drying is recommended. In addition, distillation can be used to purify 1-octanol. Purified 1-octanol is to be used to prepare standard solutions of the test substances. Water to be used in the P_{OW} determination should be glass or quartz distilled, or obtained from a purification system, or HPLC-grade water may be used. Filtration through a 0,22 μm filter is required for distilled water, and blanks should be included to check that no impurities are in the concentrated extracts that may interfere with the test substance. If a glass fibre filter is used, it should be cleaned by baking for at least three hours at 400 °C.
20. Both solvents are mutually saturated prior to the experiment by equilibrating them in a sufficiently large vessel. This is accomplished by slow-stirring the two-phase system for two days.
21. An appropriate concentration of test substance is selected and dissolved in 1-octanol (saturated with water). The 1-octanol/water partition coefficient needs to be determined in dilute solutions in 1-octanol and water. Therefore the concentration of the test substance should not exceed 70 % of its solubility with a maximum concentration of 0,1 M in either phase (1). The 1-octanol solutions used for the experiment must be devoid of suspended solid test substance.
22. The appropriate amount of test substance is dissolved in 1-octanol (saturated with water). If the estimate of $\log P_{OW}$ exceeds five, care has to be taken that the 1-octanol solutions used for the experiment are devoid of suspended solid test substance. To that end, the following procedure for chemicals with an estimated value of $\log P_{OW} > 5$ is followed:

— the test substance is dissolved in 1-octanol (saturated with water);

▼ M4

- the solution is given sufficient time for the suspended solid substance to settle out. During the settling period, the concentration of the test substance is monitored;

- after the measured concentrations in the 1-octanol-solution have attained stable values, the stock solution is diluted with an appropriate volume of 1-octanol;

- the concentration of the diluted stock solution is measured. If the measured concentration is consistent with the dilution, the diluted stock solution can be employed in the slow-stirring experiment.

Extraction and analysis of samples

23. A validated analytical method should be used for the assay of test substance. The investigators have to provide evidence that the concentrations in the water saturated 1-octanol as well as in the 1-octanol saturated water phase during the experiment are above the method limit of quantification of the analytical procedures employed. Analytical recoveries of the test substance from the water phase and from the 1-octanol phase need to be established prior to the experiment in those cases for which extraction methods are necessary. The analytical signal needs to be corrected for blanks and care should be taken that no carry-over of analyte from one sample to another can occur.

24. Extraction of the water phase with an organic solvent and preconcentration of extract are likely to be required prior to analysis, due to rather low concentrations of hydrophobic test substances in the water phase. For the same reason it is necessary to reduce eventual blank concentrations. To that end, it is necessary to employ high purity solvents, preferably solvents for residue analysis. Moreover, working with carefully pre-cleaned (e.g. solvent washing or baking at elevated temperature) glassware can help to avoid cross-contamination.

25. An estimate of $\log P_{OW}$ may be obtained from an estimation program or by expert judgment. If the value is higher than six then blank corrections and analyte carry-over need to be monitored closely. Similarly, if the estimate of $\log P_{OW}$ exceeds six, the use of a surrogate standard for recovery correction is mandatory, so that high preconcentration factors can be reached. A number of software programs for the estimation of $\log P_{OW}$ are commercially available⁽¹⁾, e.g. Clog P (16), KOWWIN (17), ProLogP (18) and ACD log P (19). Descriptions of the estimation approaches can be found in references (20-22).

26. The limits of quantification (LOQ) for determination of the test substance in 1-octanol and water are established using accepted methods. As a rule of thumb, the method limit of quantification can be determined as the concentration in water or 1-octanol that produces a signal to noise ratio of ten. A suitable extraction and pre-concentration method should be selected and analytical recoveries should also be specified. A suitable pre-concentration factor is selected in order to obtain a signal of the required size upon analytical determination.

⁽¹⁾ This information is only given for the convenience of users. Other equivalent computer programmes may be used if they can be shown to produce the same results.

▼ M4

27. On the basis of the parameters of the analytical method and the expected concentrations, an approximate sample size required for an accurate determination of the compound concentration is determined. The use of water samples that are too small to obtain a sufficient analytical signal should be avoided. Also, the use of excessively large water samples should be avoided, since otherwise there might be too little water left for the minimum number of analyses required ($n = 5$). In Appendix 1, the minimum sample volume is indicated as a function of the vessel volume, the LOD of the test substance and the solubility of the test substance.
28. Quantification of the test substances occurs by comparison with calibration curves of the respective compound. The concentrations in the samples analysed must be bracketed by concentrations of standards.
29. For test substances with a $\log P_{OW}$ estimate higher than six a surrogate standard has to be spiked to the water sample prior to extraction in order to register losses occurring during extraction and pre-concentration of the water samples. For accurate recovery correction, the surrogates must have properties that are very close to, or identical with, those of the test substance. Preferably, (stable) isotopically-labelled analogues of the substances of interest (for example, perdeuterated or ^{13}C -labelled) are used for this purpose. If the use of labelled stable isotopes, i.e. ^{13}C or 2H , is not possible it should be demonstrated from reliable data in the LITERATURE that the physical-chemical properties of the surrogate are very close to those of the test substance. During liquid-liquid extraction of the water phase emulsions can form. They can be reduced by addition of salt and allowing the emulsion to settle overnight. Methods used for extracting and pre-concentrating the samples need to be reported.
30. Samples withdrawn from the 1-octanol phase may, if necessary, be diluted with a suitable solvent prior to analysis. Moreover, the use of surrogate standards for recovery correction is recommended for substances for which the recovery experiments demonstrated a high degree of variation in the recovery experiments (relative standard deviation $> 10\%$).
31. The details of the analytical method need to be reported. This includes the method of extraction, pre-concentration and dilution factors, instrument parameters, calibration routine, calibration range, analytical recovery of the test substance from water, addition of surrogate standards for recovery correction, blank values, detection limits and limits of quantification.

Performance of the Test*Optimal 1-octanol/water volume ratios*

32. When choosing the water and 1-octanol volumes, the LOQ in 1-octanol and water, the pre-concentration factors applied to the water samples, the volumes sampled in 1-octanol and water, and the expected concentrations should be considered. For experimental reasons, the volume of 1-octanol in the slow-stirring system should be chosen such that the 1-octanol layer is sufficiently thick ($> 0,5$ cm) in order to allow for sampling of the 1-octanol phase without disturbing it.
33. Typical phase ratios used for the determinations of compounds with $\log P_{OW}$ of 4,5 and higher are 20 to 50 ml of 1-octanol and 950 to 980 ml of water in a one litre vessel.

▼ M4*Test conditions*

34. During the test the reaction vessel is thermostated to reduce temperature variation to below 1 °C. The assay should be performed at 25 °C.
35. The experimental system should be protected from daylight by either performing the experiment in a dark room or by covering the reaction vessel with aluminium foil.
36. The experiment should be performed in a dust-free (as far as possible) environment.
37. The 1-octanol-water system is stirred until equilibrium is attained. In a pilot experiment the length of the equilibration period is assessed by performing a slow-stirring experiment and sampling water and 1-octanol periodically. The sampling time points should be interspersed by a minimum period of five hours.
38. Each P_{OW} determination has to be performed employing at least three independent slow-stirring experiments.

Determination of the equilibration time

39. It is assumed that the equilibrium is achieved when a regression of the 1-octanol/water concentration ratio against time over a time span of four time points yields a slope that is not significantly different from zero at a p-level of 0,05. The minimum equilibration time is one day before sampling can be started. As a rule of thumb, sampling of substances with a log P_{OW} estimate of less than five can take place during days two and three. The equilibration might have to be extended for more hydrophobic compounds. For a compound with log P_{OW} of 8,23 (decachlorobiphenyl) 144 hours were sufficient for equilibration. Equilibrium is assessed by means of repeated sampling of a single vessel.

Starting the experiment

40. At the start of the experiment the reaction vessel is filled with 1-octanol-saturated water. Sufficient time should be allowed to reach the thermostated temperature.
41. The desired amount of test substance (dissolved in the required volume of 1-octanol saturated with water) is carefully added to the reaction vessel. This is a crucial step in the experiment, since turbulent mixing of the two phases has to be avoided. To that end, the 1-octanol phase can be pipetted slowly against the wall of the experimental vessel, close to the water surface. It will subsequently flow along the glass wall and form a film above the water phase. The decantation of 1-octanol directly into the flask should always be avoided; drops of 1-octanol should not be allowed to fall directly into the water.
42. After starting the stirring, the stirring rate should be increased slowly. If the stirring motors cannot be appropriately adjusted the use of a transformer should be considered. The stirring rate should be adjusted so that a vortex at the interface between water and 1-octanol of 0,5 to maximally 2,5 cm depth is created. The stirring rate should be reduced if the vortex depth of 2,5 cm is exceeded; otherwise micro-droplets may be formed from 1-octanol droplets in the water phase, leading to an overestimation of the concentration of the test substance in the water. The maximum stirring rate of 2,5 cm is recommended on the basis of the findings in the ring-test validation study (5). It is a compromise between achieving a rapid rate of equilibration, while limiting the formation of 1-octanol micro-droplets.

▼ M4*Sampling and Sample Treatment*

43. The stirrer should be turned off prior to sampling and the liquids should be allowed to stop moving. After sampling is completed, the stirrer is started again slowly, as described above, and then the stirring rate is increased gradually.

44. The water phase is sampled from a stopcock at the bottom of the reaction vessel. Always discard the dead volume of water contained in the taps (approximately 5 ml in the vessel shown in the Appendix 2). The water in the taps is not stirred and therefore not in equilibrium with the bulk. Note the volume of the water samples, and make sure that the amount of test substance present in the discarded water is taken into account when setting up a mass balance. Evaporative losses should be minimized by allowing the water to flow quiescently into the separatory funnel, such that there is no disturbance of the water/1-octanol layer.

45. 1-Octanol samples are obtained by withdrawing a small aliquot (ca. 100 µl) from the 1-octanol layer with a 100 microlitre all glass-metal syringe. Care should be taken not to disturb the boundary. The volume of the sampled liquid is recorded. A small aliquot is sufficient, since the 1-octanol sample will be diluted.

46. Unnecessary sample transfer steps should be avoided. To that end the sample volume should be determined gravimetrically. In case of water samples this can be achieved by collecting the water sample in a separatory funnel that contains already the required volume of solvent.

DATA AND REPORTING

47. According to the present Test Method, P_{OW} is determined by performing three slow-stirring experiments (three experimental units) with the compound under investigation employing identical conditions. The regression used to demonstrate attainment of equilibrium should be based on the results of at least four determinations of C_O/C_W at consecutive time points. This allows for calculating variance as a measure of the uncertainty of the average value obtained by each experimental unit.

48. The P_{OW} can be characterized by the variance in the data obtained for each experimental unit. This information is employed to calculate the P_{OW} as the weighted average of the results of the individual experimental units. To do so, the inverse of the variance of the results of the experimental units is employed as weight. As a result, data with a large variation (expressed as the variance) and thus with lower reliability have less influence on the result than data with a low variance.

49. Analogously, the weighted standard deviation is calculated. It characterizes the repeatability of the P_{OW} measurement. A low value of the weighted standard deviation indicates that the P_{OW} determination was very repeatable within one laboratory. The formal statistical treatment of the data is outlined below.

▼ **M4****Treatment of the results***Demonstration of attainment of equilibrium*

50. The logarithm of the ratio of the concentration of the test substance in 1-octanol and water ($\log(C_o/C_w)$) is calculated for each sampling time. Achievement of chemical equilibrium is demonstrated by plotting this ratio against time. A plateau in this plot that is based on at least four consecutive time points indicates that equilibrium has been attained, and that the compound is truly dissolved in 1-octanol. If not, the test needs to be continued until four successive time points yield a slope that is not significantly different from 0 at a p-level of 0,05, indicating that $\log C_o/C_w$ is independent of time.

Log P_{OW}-calculation

51. The value of $\log P_{OW}$ of the experimental unit is calculated as the weighted average value of $\log C_o/C_w$ for the part of the curve of $\log C_o/C_w$ vs. time, for which equilibrium has been demonstrated. The weighted average is calculated by weighting the data with the inverse of the variance so that the influence of the data on the final result is inversely proportional to the uncertainty in the data.

Average log P_{OW}

52. The average value of $\log P_{OW}$ of different experimental units is calculated as the average of the results of the individual experimental units weighted with their respective variances.

The calculation is performed as follows:

$$\log P_{OW,Av} = (\sum w_i \times \log P_{OW,i}) \times (\sum w_i)^{-1}$$

where:

$\log P_{OW,i}$ = the $\log P_{OW}$ value of the individual experimental unit i;

$\log P_{OW,Av}$ = the weighted average value of the individual $\log P_{OW}$ determinations;

w_i = the statistical weight assigned to the $\log P_{OW}$ value of the experimental unit i.

The reciprocal of the variance of $\log P_{OW,i}$ is employed as w_i ($w_i = \text{var}(\log P_{OW,i})^{-1}$)

53. The error of the average of $\log P_{OW}$ is estimated as the repeatability of $\log C_o/C_w$ determined during the equilibrium phase in the individual experimental units. It is expressed as the weighted standard deviation of $\log P_{OW,Av}$ ($\sigma_{\log P_{OW,Av}}$) which in turn is a measure of the error associated with $\log P_{OW,Av}$. The weighted standard deviation can be computed from the weighted variance ($\text{var}_{\log P_{OW,Av}}$) as follows:

$$\text{var}_{\log P_{OW,Av}} = (\sum w_i \times (\log P_{OW,i} - \log P_{OW,Av})^2) \times (\sum w_i \times (n - 1))^{-1}$$

$$\sigma_{\log P_{OW,Av}} = (\text{var}_{\log P_{OW,Av}})^{0,5}$$

The symbol n stands for the number of experimental units.

▼ M4**Test Report**

54. The test report should include the following information:

Test substance:

- common name, chemical name, CAS number, structural formula (indicating position of label when radiolabelled substance is used) and relevant physical-chemical properties (see paragraph 17)
- purity (impurities) of test substance
- label purity of labelled chemicals and molar activity (where appropriate)
- the preliminary estimate of $\log P_{ow}$, as well as the method used to derive the value.

Test conditions:

- dates of the performance of the studies
- temperature during the experiment
- volumes of 1-octanol and water at the beginning of the test
- volumes of withdrawn 1-octanol and water samples
- volumes of 1-octanol and water remaining in the test vessels
- description of the test vessels and stirring conditions (geometry of the stirring bar and of the test vessel, vortex height in mm, and when available: stirring rate) used
- analytical methods used to determine the test substance and the method limit of quantification
- sampling times
- the aqueous phase pH and the buffers used, when pH is adjusted for ionizable molecules
- number of replicates.

Results:

- repeatability and sensitivity of the analytical methods used
- determined concentrations of the test substance in 1-octanol and water as a function of time
- demonstration of mass balance
- temperature and standard deviation or the range of temperature during the experiment
- the regression of concentration ratio against time
- the average value $\log P_{ow,Av}$ and its standard error
- discussion and interpretation of the results

▼M4

- examples of raw data figures of representative analysis (all raw data have to be stored in accordance with GLP standards), including recoveries of surrogates, and the number of levels used in the calibration (along with the criteria for the correlation coefficient of the calibration curve), and results of quality assurance/quality control (QA/QC)
- when available: validation report of the assay procedure (to be indicated among references).

LITERATURE:

- (1) De Bruijn JHM, Busser F, Seinen W, Hermens J. (1989). Determination of octanol/water partition coefficients with the 'slow-stirring' method. *Environ. Toxicol. Chem.* 8: 499-512.
- (2) Chapter A.8 of this Annex, Partition Coefficient.
- (3) Chapter A.8 of this Annex, Partition Coefficient.
- (4) OECD (2000). OECD Draft Guideline for the Testing of Chemicals: 122 Partition Coefficient (n-Octanol/Water): pH-Metric Method for Ionisable Substances. Paris.
- (5) Tolls J (2002). Partition Coefficient 1-Octanol/Water (Pow) Slow-Stirring Method for Highly Hydrophobic Chemicals, Validation Report. RIVM contract-Nrs 602730 M/602700/01.
- (6) Boethling RS, Mackay D (eds.) (2000). Handbook of property estimation methods for chemicals. Lewis Publishers Boca Raton, FL, USA.
- (7) Schwarzenbach RP, Gschwend PM, Imboden DM (1993). Environmental Organic Chemistry. Wiley, New York, NY.
- (8) Arnold CG, Widenhaupt A, David MM, Müller SR, Haderlein SB, Schwarzenbach RP (1997). Aqueous speciation and 1-octanol-water partitioning of tributyl- and triphenyltin: effect of pH and ion composition. *Environ. Sci. Technol.* 31: 2596-2602.
- (9) OECD (1981) OECD Guidelines for the Testing of Chemicals: 112 Dissociation Constants in Water. Paris.
- (10) Chapter A.6 of this Annex, Water Solubility.
- (11) Chapter C.7 of this Annex, Degradation – Abiotic Degradation Hydrolysis as a Function of pH.
- (12) Chapter C.4 — Part II – VII (Method A to F) of this Annex, Determination of 'Ready' Biodegradability.
- (13) Chapter A.4 of this Annex, Vapour Pressure.
- (14) Pinsuwan S, Li A and Yalkowsky S.H. (1995). Correlation of octanol/water solubility ratios and partition coefficients, *J. Chem. Eng. Data.* 40: 623-626.
- (15) Lyman WJ (1990). Solubility in water. In: Handbook of Chemical Property Estimation Methods: Environmental Behavior of Organic Compounds, Lyman WJ, Reehl WF, Rosenblatt DH, Eds. American Chemical Society, Washington, DC, 2-1 to 2-52.
- (16) Leo A, Weininger D (1989). Medchem Software Manual. Daylight Chemical Information Systems, Irvine, CA.
- (17) Meylan W (1993). SRC-LOGKOW for Windows. SRC, Syracuse, N.Y.
- (18) Compudrug L (1992). ProLogP. Compudrug, Ltd, Budapest.
- (19) ACD. ACD logP; Advanced Chemistry Development: Toronto, Ontario M5H 3V9, Canada, 2001.

▼M4

- (20) Lyman WJ (1990). Octanol/water partition coefficient. In Lyman WJ, Reehl WF, Rosenblatt DH, eds, *Handbook of chemical property estimation*, American Chemical Society, Washington, D.C.
- (21) Rekker RF, de Kort HM (1979). The hydrophobic fragmental constant: An extension to a 1 000 data point set. *Eur. J. Med. Chem. Chim. Ther.* 14: 479-488.
- (22) Jübermann O (1958). Houben-Weyl, ed, *Methoden der Organischen Chemie*: 386-390.

▼ **M4***Appendix 1***Spreadsheet for computation of minimum volumes of water required for detection of test substances of different log P_{ow} values in aqueous phase**

Assumptions:

- Maximum volume of individual aliquots = 10 % of total volume; 5 aliquots = 50 % of total volume.
- Concentration of test substances = $0,7 \times$ solubility in either phase. In case of lower concentrations, larger volumes would be required.
- Volume used for LOD determination = 100 ml.
- log P_{ow} vs. log S_w and log P_{ow} vs. SR (S_{oct}/S_w) are reasonable representations of relationships for test substances.

Estimation of S_w

log P _{ow}	Equation	log S _w	S _w (mg/l)
4	$(-0,922 \times \log P_{ow} + 4,184)$	0,496	3,133E+00
4,5	$(-0,922 \times \log P_{ow} + 4,184)$	0,035	1,084E+00
5	$(-0,922 \times \log P_{ow} + 4,184)$	-0,426	3,750E-01
5,5	$(-0,922 \times \log P_{ow} + 4,184)$	-0,887	1,297E-01
6	$(-0,922 \times \log P_{ow} + 4,184)$	-1,348	4,487E-02
6,5	$(-0,922 \times \log P_{ow} + 4,184)$	-1,809	1,552E-02
7	$(-0,922 \times \log P_{ow} + 4,184)$	-2,270	5,370E-03
7,5	$(-0,922 \times \log P_{ow} + 4,184)$	-2,731	1,858E-03
8	$(-0,922 \times \log P_{ow} + 4,184)$	-3,192	6,427E-04

Estimation of S_{oct}

log P _{ow}	Equation	S _{oct} (mg/l)
4	$\log P_{ow} = 0,88 \log SR + 0,41$	3,763E+04
4,5	$\log P_{ow} = 0,88 \log SR + 0,42$	4,816E+04
5	$\log P_{ow} = 0,88 \log SR + 0,43$	6,165E+04
5,5	$\log P_{ow} = 0,88 \log SR + 0,44$	7,890E+04
6	$\log P_{ow} = 0,88 \log SR + 0,45$	1,010E+05
6,5	$\log P_{ow} = 0,88 \log SR + 0,46$	1,293E+05
7	$\log P_{ow} = 0,88 \log SR + 0,47$	1,654E+05
7,5	$\log P_{ow} = 0,88 \log SR + 0,48$	2,117E+05
8	$\log P_{ow} = 0,88 \log SR + 0,49$	2,710E+05

▼ **M4**

Total Mass test substance (mg)	Mass _{oct} /Mass _{water}	Mass _{H₂O} (mg)	Conc _{H₂O} (mg/l)	Mass _{oct} (mg)	Conc _{oct} (mg/l)
1 319	526	2,5017	2,6333	1 317	26 333
1 686	1 664	1,0127	1,0660	1 685	33 709
2 158	5 263	0,4099	0,4315	2 157	43 149
2 762	16 644	0,1659	0,1747	2 762	55 230
3 535	52 632	0,0672	0,0707	3 535	70 691
4 524	1664 36	0,0272	0,0286	4 524	90 480
5 790	5263 16	0,0110	0,0116	5 790	115 807
7 411	1 664 357	0,0045	0,0047	7 411	148 223
9 486	5 263 158	0,0018	0,0019	9 486	189 713

*Computation of volumes***Minimum volume required for H₂O phase at each LOD concentration**

log K _{ow}	LOD (micrograms/l)→	0,001	0,01	0,10	1,00	10
4		0,04	0,38	3,80	38	380
4,5		0,09	0,94	9,38	94	938
5		0,23	2,32	23,18	232	2 318
5,5		0,57	5,73	57,26	573	5 726
6		1,41	14,15	141	1 415	14 146
6,5		3,50	34,95	350	3 495	34 950
7		8,64	86,35	864	8 635	86 351
7,5		21,33	213	2 133	21 335	213 346
8		52,71	527	5 271	52 711	527 111
Volume used for LOD (l)	0,1					

Key to Computations

Represents < 10 % of total volume of aqueous phase, 1 litre equilibration vessel.

Represents < 10 % of total volume of aqueous phase, 2 litre equilibration vessel.

Represents < 10 % of total volume of aqueous phase, 5 litre equilibration vessel.

Represents < 10 % of total volume of aqueous phase, 10 litre equilibration vessel.

Exceeds 10 % of even the 10 liter equilibration vessel.

▼ **M4****Overview of volumes required, as a function of water solubility and Log P_{ow}**Minimum volume required for H₂O phase at each LOD concentration (ml)

log P _{ow}	S _w (mg/l)	LOD (micrograms/l)→	0,001	0,01	0,10	1,00	10
4	10		0,01	0,12	1,19	11,90	118,99
	5		0,02	0,24	2,38	23,80	237,97
	3		0,04	0,40	3,97	39,66	396,62
	1		0,12	1,19	11,90	118,99	1 189,86
4,5	5		0,02	0,20	2,03	20,34	203,37
	2		0,05	0,51	5,08	50,84	508,42
	1		0,10	1,02	10,17	101,68	1 016,83
	0,5		0,20	2,03	20,34	203,37	2 033,67
5	1		0,09	0,87	8,69	86,90	869,01
	0,5		0,17	1,74	17,38	173,80	1 738,02
	0,375		0,23	2,32	23,18	231,75	2 317,53
	0,2		0,43	4,35	43,45	434,51	4 345,05
5,5	0,4		0,19	1,86	18,57	185,68	1 856,79
	0,2		0,37	3,71	37,14	371,36	3 713,59
	0,1		0,74	7,43	74,27	742,72	7 427,17
	0,05		1,49	14,85	148,54	1 485,43	14 854,35
6	0,1		0,63	6,35	63,48	634,80	6 347,95
	0,05		1,27	12,70	126,96	1 269,59	12 695,91
	0,025		2,54	25,39	253,92	2 539,18	25 391,82
	0,0125		5,08	50,78	507,84	5 078,36	50 783,64
6,5	0,025		2,17	21,70	217,02	2 170,25	21 702,46
	0,0125		4,34	43,40	434,05	4 340,49	43 404,93
	0,006		9,04	90,43	904,27	9 042,69	90 426,93
	0,003		18,09	180,85	1 808,54	18 085,39	180 853,86
7	0,006		7,73	77,29	772,89	7 728,85	77 288,50
	0,003		15,46	154,58	1 545,77	15 457,70	154 577,01
	0,0015		23,19	231,87	2 318,66	23 186,55	231 865,51
	0,001		46,37	463,73	4 637,31	46 373,10	463 731,03
7,5	0,002		19,82	198,18	1 981,77	19 817,73	198 177,33
	0,001		39,64	396,35	3 963,55	39 635,47	396 354,66
	0,0005		79,27	792,71	7 927,09	79 270,93	792 709,32

▼ **M4**

log P _{ow}	S _w (mg/l)	LOD (micrograms/l)→	0,001	0,01	0,10	1,00	10
	0,00025		158,54	1 585,42	15 854,19	158 541,86	1 585 418,63
8	0,001		33,88	338,77	3 387,68	33 876,77	338 767,72
	0,0005		67,75	677,54	6 775,35	67 753,54	677 535,44
	0,00025		135,51	1 355,07	13 550,71	135 507,09	1 355 070,89
	0,000125		271,01	2 710,14	27 101,42	271 014,18	2 710 141,77
Volume used for LOD (l)		0,1					

▼ M4*Appendix 2*

An example of glass-jacketed test vessel for the slow-stirring experiment for determination of P_{OW}

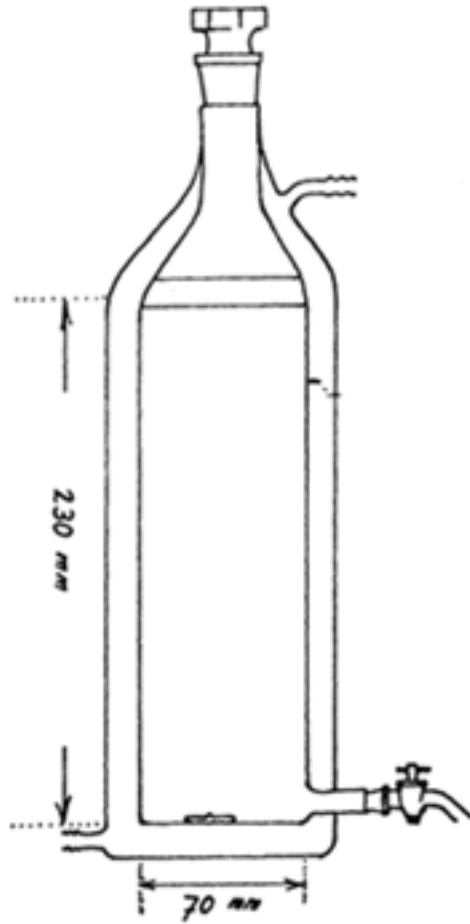

▼ M6**A.24. PARTITION COEFFICIENT (N-OCTANOL/WATER), HIGH PERFORMANCELIQUID CHROMATOGRAPHY (HPLC) METHOD**

INTRODUCTION

This test method is equivalent to OECD test guideline (TG) 117 (2004)

1. The partition coefficient (P) is defined as the ratio of the equilibrium concentrations of a dissolved substance in a two-phase system consisting of two largely immiscible solvents. In the case of n-octanol and water,

$$P_{ow} = \frac{C_{n\text{-octanol}}}{C_{\text{water}}}$$

The partition coefficient being the quotient of two concentrations, is dimensionless and is usually given in the form of its logarithm to base ten.

2. P_{ow} is a key parameter in studies of the environmental fate of chemical substances. A highly-significant relationship between the P_{ow} of non-ionised form of substances and their bioaccumulation in fish has been shown. It has also been shown that P_{ow} is a useful parameter in the prediction of adsorption on soil and sediments and for establishing quantitative structure-activity relationships for a wide range of biological effects.
3. The original proposal for this test method was based on an article by C.V. Eadsforth and P. Moser (1). The development of the test method and an OECD inter-laboratory comparison test were coordinated by the Umweltbundesamt of the Federal Republic of Germany during 1986 (2).

INITIAL CONSIDERATIONS

4. $\log P_{ow}$ values in the range – 2 to 4 (occasionally up to 5 and more) ⁽¹⁾ can be experimentally determined by the Shake-Flask method (Chapter A.8 of this Annex, OECD Test Guideline 107). The HPLC method covers $\log P_{ow}$ in the range of 0 to 6 (1)(2)(3)(4)(5). This method may require an estimation of P_{ow} to assign suitable reference substances and support any conclusions drawn from the data generated by the test. Calculation methods are briefly discussed in the Appendix to this test method. The HPLC operation mode is isocratic.
5. The P_{ow} values depend on the environmental conditions such as temperature, pH, ionic strength etc, and these should be defined in the experiment for the correct interpretation of P_{ow} data. For ionisable substances, another method (e.g. draft OECD guideline on pH metric method for ionised substances (6)) may become available and could be used as an alternative method. Although this draft OECD guideline may appropriate be suitable to determine P_{ow} for those ionisable substances, in some cases it is more appropriate to use the HPLC method at an environmentally relevant pH (see paragraph 9).

⁽¹⁾ An upper limit is given by the necessity to achieve a complete separation phase after adjustments of the partition equilibrium and before samples are taken out for analytical determinations. If proper care is taken, the upper limit can be extended to higher values of P_{ow}

▼ M6

PRINCIPLE OF THE METHOD

6. Reverse phase HPLC is performed on analytical columns packed with a commercially available solid phase containing long hydrocarbon chains (e.g. C₈, C₁₈) chemically bound onto silica.
7. A chemical injected on such a column partitions between the mobile solvent phase and the hydrocarbon stationary phase as it is transported along the column by the mobile phase. The substances are retained in proportion to their hydrocarbon-water partition coefficient, with hydrophilic substances eluted first and lipophilic substances last. The retention time is described by the capacity factor *k* given by the expression:

$$k = \frac{t_R - t_0}{t_0}$$

where *t_R* is the retention time of the test substance, and *t₀* is the dead-time, i.e. the average time a solvent molecule needs to pass the column. Quantitative analytical methods are not required and only the determination of retention times is necessary.

8. The octanol/water partition coefficient of a test substance can be computed by experimentally determining its capacity factor *k* and then inputting *k* into the following equation:

$$\log P_{ow} = a + b \times \log k$$

where

a, *b* = linear regression coefficients.

The equation above can be obtained by linearly regressing the log of octanol/water partition coefficients of reference substances against the log of capacity factors of the reference substances.

9. Reverse phase HPLC method enables partition coefficients to be estimated in the log *P_{ow}* range between 0 and 6, but can be expanded to cover the log *P_{ow}* range between 6 and 10 in exceptional cases. This may require that the mobile phase is modified (3). The method is not applicable to strong acids and bases, metal complexes, substances which react with the eluent, or surface-active agents. Measurements can be performed on ionisable substances in their non-ionised form (free acid or free base) only by using an appropriate buffer with a pH below the *pK_a* for a free acid or above the *pK_a* for a free base. Alternatively, the pH-metric method for the testing of ionisable substances (6) may become available and could be used as an alternative method (6). If the log *P_{ow}* value is determined for the use in environmental hazard classification or in environmental risk assessment, the test should be performed in the pH range relevant for the natural environment, i.e. in the pH range of 5,0 - 9.
10. In some cases impurities can make the interpretation of the results difficult due to uncertainty in peak assignments. For mixtures which result in an unresolved band, upper and lower limits of log *P_{ow}*, and the area % of each log *P_{ow}* peak should be reported. For mixtures which are a group of homologues, the weighted average log *P_{ow}* should also be stated (7), calculated based on the single *P_{ow}* values and the corresponding area % values (8). All peaks that contribute an area of 5 % or more to the total peak area should be taken into consideration in the calculation (9):

▼ M6

$$\text{weighted average log } P_{ow} = \frac{\sum_i (\log P_{owi})(\text{area } \%)}{\text{total peak area } \%} = \frac{\sum_i (\log P_{owi})(\text{area } \%_i)}{\sum_i \text{area } \%}$$

The weighed average log P_{ow} is valid only for substances or mixtures (e.g. tall oils) consisting of homologues (e.g. series of alkanes). Mixtures can be measured with meaningful results, provided that the analytical detector used has the same sensitivity towards all the substances in the mixture and that they can be adequately resolved.

INFORMATION ON THE TEST SUBSTANCE

11. The dissociation constant, structural formula, and solubility in the mobile phase should be known before the method is used. In addition, information on hydrolysis would be helpful.

QUALITY CRITERIA

12. In order to increase the confidence in the measurement, duplicate determinations must be made.

— Repeatability: The value of log P_{ow} derived from repeated measurements made under identical conditions and using the same set of reference substances should fall within a range of $\pm 0,1$ log units.

— Reproducibility: If the measurements are repeated with a different set of reference substances, results may differ. Typically, the correlation coefficient R for the relationship between log k and log P_{ow} for a set of test substances is around 0,9, corresponding to an octanol/water partition coefficient of log $P_{ow} \pm 0,5$ log units.

13. The inter-laboratory comparison test has shown that with the HPLC method log P_{ow} values can be obtained to within $\pm 0,5$ units of the Shake-Flask values (2). Other comparisons can be found in the literature (4)(5)(10)(11)(12). Correlation graphs based on structurally related reference substances give the most accurate results (13).

REFERENCE SUBSTANCES

14. In order to correlate the measured capacity factor k of a substance with its P_{ow} , a calibration graph using at least 6 points has to be established (see paragraph 24). It is up to the user to select the appropriate reference substances. The reference substances should normally have log P_{ow} values which encompass the log P_{ow} of the test substance, i.e. at least one reference substance should have a P_{ow} above that of the test substance, and another a P_{ow} below that of the test substance. Extrapolation should only be used in exceptional cases. It is preferable that these reference substances should be structurally related to the test substance. log P_{ow} values of the reference substances used for the calibration should be based on reliable experimental data. However, for substances with high log P_{ow} (normally more than 4), calculated values may be used unless reliable experimental data are available. If extrapolated values are used a limit value should be quoted.
15. Extensive lists of log P_{ow} values for many groups of chemicals are available (14)(15). If data on the partition coefficients of structurally related substances are not available, a more general calibration, established with other reference substances, may be used. Recommended reference substances and their P_{ow} values are listed in Table 1. For ionisable substances the values given apply to the non-ionised form. The values were checked for plausibility and quality during the inter-laboratory comparison test.

▼ **M6**

Table 1

Recommended reference substances

	CAS Number	Reference substance	log P _{ow}	pKa
1	78-93-3	2-Butanone (Methylethylketone)	0,3	
2	1122-54-9	4-Acetylpyridine	0,5	
3	62-53-3	Aniline	0,9	
4	103-84-4	Acetanilide	1,0	
5	100-51-6	Benzyl alcohol	1,1	
6	150-76-5	4-Methoxyphenol	1,3	pKa = 10,26
7	122-59-8	Phenoxyacetic acid	1,4	pKa = 3,12
8	108-95-2	Phenol	1,5	pKa = 9,92
9	51-28-5	2,4-Dinitrophenol	1,5	pKa = 3,96
10	100-47-0	Benzonitrile	1,6	
11	140-29-4	Phenylacetoneitrile	1,6	
12	589-18-4	4-Methylbenzyl alcohol	1,6	
13	98-86-2	Acetophenone	1,7	
14	88-75-5	2-Nitrophenol	1,8	pKa = 7,17
15	121-92-6	3-Nitrobenzoic acid	1,8	pKa = 3,47
16	106-47-8	4-Chloroaniline	1,8	pKa = 4,15
17	98-95-3	Nitrobenzene	1,9	
18	104-54-1	Cinnamyl alcohol (Cinnamic alcohol)	1,9	
19	65-85-0	Benzoic acid	1,9	pKa = 4,19
20	106-44-5	p-Cresol	1,9	pKa = 10,17
21	140-10-3 (trans)	Cinnamic acid	2,1	pKa = 3,89 (cis) 4,44 (trans)
22	100-66-3	Anisole	2,1	
23	93-58-3	Methyl benzoate	2,1	
24	71-43-2	Benzene	2,1	
25	99-04-7	3-Methylbenzoic acid	2,4	pKa = 4,27
26	106-48-9	4-Chlorophenol	2,4	pKa = 9,1
27	79-01-6	Trichloroethylene	2,4	
28	1912-24-9	Atrazine	2,6	
29	93-89-0	Ethyl benzoate	2,6	

▼ M6

	CAS Number	Reference substance	log P _{ow}	pKa
30	1194-65-6	2,6-Dichlorobenzonitrile	2,6	
31	535-80-8	3-Chlorobenzoic acid	2,7	pKa = 3,82
32	108-88-3	Toluene	2,7	
33	90-15-3	1-Naphthol	2,7	pKa = 9,34
34	608-27-5	2,3-Dichloroaniline	2,8	
35	108-90-7	Chlorobenzene	2,8	
36	1746-13-0	Allyl phenyl ether	2,9	
37	108-86-1	Bromobenzene	3,0	
38	100-41-4	Ethylbenzene	3,2	
39	119-61-9	Benzophenone	3,2	
40	92-69-3	4-Phenylphenol	3,2	pKa = 9,54
41	89-83-8	Thymol	3,3	
42	106-46-7	1,4-Dichlorobenzene	3,4	
43	122-39-4	Diphenylamine	3,4	pKa = 0,79
44	91-20-3	Naphthalene	3,6	
45	93-99-2	Phenyl benzoate	3,6	
46	98-82-8	Isopropylbenzene	3,7	
47	88-06-2	2,4,6-Trichlorophenol	3,7	pKa = 6
48	92-52-4	Biphenyl	4,0	
49	120-51-4	Benzyl benzoate	4,0	
50	88-85-7	2,4-Dinitro-6-sec-butylphenol	4,1	
51	120-82-1	1,2,4-Trichlorobenzene	4,2	
52	143-07-7	Dodecanoic acid	4,2	pKa = 5,3
53	101-84-8	Diphenyl ether	4,2	
54	85-01-8	Phenanthrene	4,5	
55	104-51-8	n-Butylbenzene	4,6	
56	103-29-7	Dibenzyl	4,8	
57	3558-69-8	2,6-Diphenylpyridine	4,9	
58	206-44-0	Fluoranthene	5,1	
59	603-34-9	Triphenylamine	5,7	
60	50-29-3	DDT	6,5	

▼ M6

DESCRIPTION OF THE METHOD

Preliminary estimate of the partition coefficient

16. If it is necessary, the partition coefficient of the test substance may be estimated preferably by using a calculation method (see Appendix, or where appropriate, by using the ratio of the solubility of the test substance in the pure solvents.

Apparatus

17. A liquid-phase chromatograph fitted with a low-pulse pump and a suitable detection system is required. A UV detector, using a wavelength of 210 nm, or an RI detector is applicable to the wide variety of chemical groups. The presence of polar groups in the stationary phase may seriously impair the performance of the HPLC column. Therefore, stationary phases should have a minimal percentage of polar groups (16). Commercial microparticulate reverse-phase packing or ready-packed columns can be used. A guard column may be positioned between the injection system and the analytical column.

Mobile phase

18. HPLC-grade methanol and distilled or de-ionised water are used to prepare the eluting solvent, which is degassed before use. Isocratic elution should be employed. Methanol/water ratios with minimum water content of 25 % should be used. Typically a 3:1 (v/v) methanol-water mixture is satisfactory for eluting substances with a log P of 6 within an hour, at a flow rate of 1 ml/min. For substances with a log P above 6 it may be necessary to shorten the elution time (and those of the reference substances) by decreasing the polarity of the mobile phase or the column length.
19. The test substance and the reference substances must be soluble in the mobile phase in sufficient concentration to allow their detection. Additives may be used with the methanol-water mixture in exceptional cases only, since they will change the properties of the column. In these cases it must be confirmed that the retention time of the test and reference substances are not influenced. If methanol-water is not appropriate, other organic solvent-water mixtures can be used, e.g. ethanol-water, acetonitrile-water or isopropyl alcohol (2-propanol)-water.
20. The pH of the eluent is critical for ionisable substances. It should be within the operating pH range of the column, usually between 2 and 8. Buffering is recommended. Care must be taken to avoid salt precipitation and column deterioration which occur with some organic phase/buffer mixtures. HPLC measurements with silica-based stationary phases above pH 8 are not normally advisable since the use of an alkaline mobile phase may cause rapid deterioration in the performance of the column.

Solutes

21. The test and reference substances must be sufficiently pure in order to assign the peaks in the chromatograms to the respective substances. Substances to be used for test or calibration purposes are dissolved in the mobile phase if possible. If a solvent other than the mobile phase is used to dissolve the test and reference substances, the mobile phase should be used for the final dilution prior to injection.

Test conditions

22. The temperature during the measurement should not vary by more than ± 1 °C.

▼ M6**Determination of dead time t_0**

23. The dead time t_0 can be measured by using unretained organic substances (e.g. thiourea or formamide). A more precise dead time can be derived from the retention times measured or a set of approximately seven members of a homologous series (e.g. n-alkyl methyl ketones) (17). The retention times $t_R(n_C + 1)$ are plotted against $t_R(n_C)$, where n_C is the number of carbon atoms. A straight line, $t_R(n_C + 1) = A t_R(n_C) + (1 - A)t_0$, is obtained, where A , representing $k(n_C + 1)/k(n_C)$, is constant. The dead time t_0 is obtained from the intercept $(1 - A)t_0$ and the slope A .

Regression Equation

24. The next step is to plot a correlation $\log k$ versus $\log P$ for appropriate reference substances with $\log P$ values near the value expected for the test substance. In practice, from 6 to 10 reference substances are injected simultaneously. The retention times are determined, preferably on a recording integrator linked to the detection system. The corresponding logarithms of the capacity factors, $\log k$, are plotted as a function of $\log P$. The regression equation is performed at regular intervals, at least once daily, so that account can be taken of possible changes in column performance.

DETERMINATION OF THE P_{OW} OF THE TEST SUBSTANCE

25. The test substance is injected in the smallest detectable quantities. The retention time is determined in duplicate. The partition coefficient of the test substance is obtained by interpolation of the calculated capacity factor on the calibration graph. For very low and very high partition coefficients extrapolation is necessary. Especially in these cases attention must be given to the confidence limits of the regression line. If the retention time of sample is outside the range of retention times obtained for the standards, a limit value should be quoted.

DATA AND REPORTING**Test report**

26. The following must be included in the report:
- if determined the preliminary estimate of the partition coefficient, the estimated values and the method used; and if a calculation method was used, its full description including identification of the data base and detailed information on the choice of fragments;
 - test and reference substances: purity, structural formula and CAS number,
 - description of equipment and operating conditions: analytical column, guard column,
 - mobile phase, means of detection, temperature range, pH;
 - elution profiles (chromatograms);
 - deadtime and how it was measured;
 - retention data and literature $\log P_{ow}$ values for reference substances used in calibration;
 - details on fitted regression line ($\log k$ versus $\log P_{ow}$) and the correlation coefficient of the line including confidence intervals;

▼M6

- average retention data and interpolated log P_{ow} value for the test substance;
- in case of a mixture: elution profile chromatogram with indicated cut-offs;
- log P_{ow} values relative to area % of the log P_{ow} peak;
- calculation using a regression line;
- calculated weighted average log P_{ow} values, when appropriate.

LITERATURE

- (1) C.V. Eadsforth and P. Moser. (1983). Assessment of Reverse Phase Chromatographic Methods for Determining Partition Coefficients. *Chemosphere*. 12, 1459.
- (2) W. Klein, W. Kördel, M. Weiss and H.J. Poremski. (1988). Updating of the OECD Test Guideline 107 Partition Coefficient n-Octanol-Water, OECD Laboratory Intercomparison Test on the HPLC Method. *Chemosphere*. 17, 361.
- (3) C.V. Eadsforth. (1986). Application of Reverse H.P.L.C. for the Determination of Partition Coefficient. *Pesticide Science*. 17, 311.
- (4) H. Ellgehausen, C. D'Hondt and R. Fuerer (1981). Reversed-phase chromatography as a general method for determining octan-1-ol/water partition coefficients. *Pesticide Science*. 12, 219.
- (5) B. McDuffie (1981). Estimation of Octanol Water Partition Coefficients for Organic Pollutants Using Reverse Phase High Pressure Liquid Chromatography. *Chemosphere*. 10, 73.
- (6) OECD (2000). Guideline for Testing of Chemicals — Partition Coefficient (n-octanol/water): pH-metric Method for Ionisable Substances. Draft Guideline, November 2000.
- (7) OSPAR (1995). 'Harmonised Offshore Chemicals Notification Format (HOCFN) 1995', Oslo and Paris Conventions for the Prevention of Marine Pollution Programmes and Measures Committee (PRAM), Annex 10, Oviedo, 20–24 February 1995.
- (8) M. Thatcher, M. Robinson, L. R. Henriquez and C. C. Karman. (1999). An User Guide for the Evaluation of Chemicals Used and Discharged Offshore, A CIN Revised CHARM III Report 1999. Version 1.0, 3. August.
- (9) E. A. Vik, S. Bakke and K. Bansal. (1998). Partitioning of Chemicals. Important Factors in Exposure Assessment of Offshore Discharges. *Environmental Modelling & Software* Vol. 13, pp. 529-537.
- (10) L.O. Renberg, S.G. Sundstroem and K. Sundh-Nygård. (1980). Partition coefficients of organic chemicals derived from reversed-phase thin-layer chromatography. Evaluation of methods and application on phosphate esters, polychlorinated paraffins and some PCB-substitutes. *Chemosphere*. 9, 683.
- (11) W.E. Hammers, G.J.Meurs and C.L. De-Ligny. (1982). Correlations between liquid chromatographic capacity ratio data on Lichrosorb RP-18 and partition coefficients in the octanol-water system. *J. Chromatography* 247, 1.
- (12) J.E. Haky and A.M. Young. (1984). Evaluation of a simple HPLC correlation method for the estimation of the octanol-water partition coefficients of organic compounds. *J. Liq. Chromatography*. 7, 675.
- (13) S. Fujisawa and E. Masuhara. (1981). Determination of Partition Coefficients of Acrylates Methacrylates and Vinyl Monomers Using High Performance Liquid Chromatography. *Journal of Biomedical Materials Research*. 15, 787.

▼M6

- (14) C. Hansch and A. J. Leo. (1979). *Substituent Constants for Correlation Analysis in Chemistry and Biology*. John Willey, New York.
- (15) C. Hansch, chairman; A.J. Leo, dir. (1982). *Log P and Parameter Database: A tool for the quantitative prediction of bioactivity* — Available from Pomona College Medical Chemistry Project, Pomona College, Claremont, California 91711.
- (16) R. F. Rekker, H. M. de Kort. (1979). The hydrophobic fragmental constant: An extension to a 1 000 data point set. *Eur. J. Med. Chem. — Chim. Ther.* 14, 479.
- (17) G.E. Berendsen, P.J. Schoenmakers, L. de Galan, G. Vigh, Z. Varga-Puchony, and J. Inczédy. (1980). On determination of hold-up time in reversed-phase liquid chromatography. *J. Liq. Chromato.* 3, 1669.

▼ **M6***Appendix***P_{ow} calculation methods**

INTRODUCTION

1. This appendix provides a short introduction to the calculation of P_{ow}. For further information the reader is referred to textbooks (1)(2).
2. Calculated values of P_{ow} are used for:
 - deciding which experimental method to use: Shake Flask method for log P_{ow} between – 2 and 4 and HPLC method for log P_{ow} between 0 and 6;
 - selecting conditions to be used in HPLC (reference substances, methanol/water ratio);
 - checking the plausibility of values obtained through experimental methods;
 - providing an estimate when experimental methods cannot be applied.

Principle of calculation methods

3. The calculation methods suggested here are based on the theoretical fragmentation of the molecule into suitable substructures for which reliable log P_{ow} increments are known. The log P_{ow} is obtained by summing the fragment values and the correction terms for intramolecular interactions. Lists of fragment constants and correction terms are available (1)(2)(3)(4)(5)(6). Some are regularly updated (3).

Reliability of calculated values

4. In general, the reliability of calculation methods decreases as the complexity of the substance under study increases. In the case of simple molecules of low molecular weight and with one or two functional groups, a deviation of 0,1 to 0,3 log P_{ow} units between the results of the different fragmentation methods and the measured values can be expected. The margin of error will depend on the reliability of the fragment constants used, the ability to recognise intramolecular interactions (e.g. hydrogen bonds) and the correct use of correction terms. In the case of ionising substances the charge and degree of ionisation must be taken into consideration (10).

Fujita-Hansch π -method

5. The hydrophobic substituent constant, π , originally introduced by Fujita et al. (7) is defined as:

$$\pi_X = \log P_{ow}(\text{PhX}) - \log P_{ow}(\text{PhH})$$

where PhX is an aromatic derivative and PhH the parent substance.

$$\begin{aligned} \text{e.g. } \pi_{\text{Cl}} &= \log P_{ow}(\text{C}_6\text{H}_5\text{Cl}) - \log P_{ow}(\text{C}_6\text{H}_6) \\ &= 2,84 - 2,13 \\ &= 0,71 \end{aligned}$$

The π -method is primarily of interest for aromatic substances. π -values for a large number of substituents are available (4)(5).

Rekker method

6. Using the Rekker method (8) the log P_{ow} value is calculated as:

$$\text{Log } P_{ow} = \sum_i a_i f_i + \sum_j (\text{interaction terms})$$

▼M6

where a_i is the number of times a given fragment occurs in the molecule and f_i is the log P_{ow} increment of the fragment. The interaction terms can be expressed as an integral multiple of one single constant C_m (so-called 'magic constant'). The fragment constants f_i and C_m have been determined from a list of 1 054 experimental P_{ow} values of 825 substances using multiple regression analysis (6)(8). The determination of the interaction terms is carried out according to set rules (6)(8)(9).

Hansch-Leo method

7. Using the Hansch and Leo method (4), the log P_{ow} value is calculated as:

$$\text{Log } P_{ow} = \sum_i a_i f_i + \sum_j b_j F_j$$

where f_i is a fragment constant, F_j a correction term (factor), a_i and b_j the corresponding frequency of occurrence. Lists of atomic and group fragmental values and of correction terms F_j were derived by trial and error from experimental P_{ow} values. The correction terms have been divided into several different classes (1)(4). Software packages have been developed to take into account all the rules and correction terms (3).

COMBINED METHOD

8. The calculation of log P_{ow} of complex molecules can be considerably improved, if the molecule is dissected into larger substructures for which reliable log P_{ow} values are available, either from tables (3)(4) or by existing measurements. Such fragments (e.g. heterocycles, anthraquinone, azobenzene) can then be combined with the Hansch- π values or with Rekker or Leo fragment constants.

Remarks:

- (i) The calculation methods are only applicable to partly or fully ionised substances when the necessary correction factors are taken into account.
- (ii) If the existence of intramolecular hydrogen bonds can be assumed, the corresponding correction terms (approx. + 0,6 to + 1,0 log P_{ow} units) must be added (1). Indications on the presence of such bonds can be obtained from stereo models or spectroscopic data.
- (iii) If several tautomeric forms are possible, the most likely form should be used as the basis of the calculation.
- (iv) The revisions of lists of fragment constants should be followed carefully.

LITERATURE ON CALCULATION METHODS

- (1) W.J. Lyman, W.F. Reehl and D.H. Rosenblatt (ed.). Handbook of Chemical Property Estimation Methods, McGraw-Hill, New York (1982).
- (2) W.J. Dunn, J.H. Block and R.S. Pearlman (ed.). Partition Coefficient, Determination and Estimation, Pergamon Press, Elmsford (New York) and Oxford (1986).
- (3) Pomona College, Medicinal Chemistry Project, Claremont, California 91711, USA, Log P Database and Med. Chem. Software (Program CLOGP-3).
- (4) C. Hansch and A.J. Leo. Substituent Constants for Correlation Analysis in Chemistry and Biology, John Wiley, New York (1979).

▼M6

- (5) Leo, C. Hansch and D. Elkins. (1971) Partition coefficients and their uses. *Chemical. Reviews.* 71, 525.
- (6) R. F. Rekker, H. M. de Kort. (1979). The hydrophobic fragmental constant: An extension to a 1 000 data point set. *Eur. J. Med. Chem. — Chim. Ther.* 14, 479.
- (7) Toshio Fujita, Junkichi Iwasa & Corwin Hansch (1964). A New Substituent Constant, π , Derived from Partition Coefficients. *J. Amer. Chem. Soc.* 86, 5175.
- (8) R.F. Rekker. The Hydrophobic Fragmental Constant, Pharmacochimistry Library, Vol. 1, Elsevier, New York (1977).
- (9) C.V. Eadsforth and P. Moser. (1983). Assessment of Reverse Phase Chromatographic Methods for Determining Partition Coefficients. *Chemosphere.* 12, 1459.
- (10) R.A. Scherrer. ACS — Symposium Series 255, p. 225, American Chemical Society, Washington, D.C. (1984).

▼M7**A.25. DISSOCIATION CONSTANTS IN WATER (TITRATION METHOD — SPECTROPHOTOMETRIC METHOD — CONDUCTOMETRIC METHOD)****INTRODUCTION**

This test method is equivalent to OECD test guideline 112 (1981)

Prerequisites

- Suitable analytical method
- Water solubility

Guidance information

- Structural formula
- Electrical conductivity for conductometric method

Qualifying statements

- All test methods may be carried out on pure or commercial grade substances. The possible effects of impurities on results should be considered.
- The titration method is not suitable for low solubility substances (see Test solutions, below).
- The spectrophotometric method is only applicable to substances having appreciably different UV/VIS-absorption spectra for the dissociated and undissociated forms. This method may also be suitable for low solubility substances and for non-acid/base dissociations, e.g. complex formation.
- In cases where the Onsager equation holds, the conductometric method may be used, even at moderately low concentrations and even in cases for non-acid/base equilibria.

Standard documents

This test method is based on methods given in the references listed in the section 'Literature' and on the Preliminary Draft Guidance for Premanufacture Notification EPA, August 18, 1978.

METHOD — INTRODUCTION, PURPOSE, SCOPE, RELEVANCE, APPLICATION AND LIMITS OF TEST

The dissociation of a substance in water is of importance in assessing its impact upon the environment. It governs the form of the substance which in turn determines its behaviour and transport. It may affect the adsorption of the chemical on soils and sediments and absorption into biological cells.

Definitions and units

Dissociation is the reversible splitting into two or more chemical species which may be ionic. The process is indicated generally by

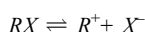

and the concentration equilibrium constant governing the reaction is

$$K = \frac{[R^+][X^-]}{[RX]}$$

For example, in the particular case where R is hydrogen (the substance is an acid), the constant is

▼ **M7**

$$K_a = [H^+] \cdot \frac{[X^-]}{[HX]}$$

or

$$pK_a = pH - \log \frac{[X^-]}{[HX]}$$

Reference substances

The following reference substances need not be employed in all cases when investigating a new substance. They are provided primarily so that calibration of the method may be performed from time to time and to offer the chance to compare the results when another method is applied.

	pK _a (1)	Temp. in °C
p-Nitrophenol	7,15	25 (1)
Benzoic acid	4,12	20
p-Chloroaniline	3,93	20

(1) No value for 20 °C is available, but it can be assumed that the variability of measurement results is higher than the temperature dependence to be expected.

It would be useful to have a substance with several pK_s as indicated in Principle of the method, below. Such a substance could be:

Citric acid	pK _a (8)	Temp. in °C
	(1) 3,14	20
	(2) 4,77	20
	(3) 6,39	20

Principle of the test method

The chemical process described is generally only slightly temperature dependent in the environmentally relevant temperature range. The determination of the dissociation constant requires a measure of the concentrations of the dissociated and undissociated forms of the chemical substance. From the knowledge of the stoichiometry of the dissociation reaction indicated in Definitions and units, above, the appropriate constant can be determined. In the particular case described in this test method the substance is behaving as an acid or a base, and the determination is most conveniently done by determining the relative concentrations of the ionised and unionised forms of the substance and the pH of the solution. The relationship between these terms is given in the equation for pK_a in Definitions and units, above. Some substances exhibit more than one dissociation constant and similar equations can be developed. Some of the methods described herein are also suitable for non-acid/base dissociation.

Quality criteria*Repeatability*

The dissociation constant should be replicated (a minimum of three determinations) to within ± 0,1 log units.

DESCRIPTION OF THE TEST PROCEDURES

There are two basic approaches to the determination of pK_a. One involves titrating a known amount of substance with standard acid or base, as appropriate; the other involves determining the relative concentration of the ionised and unionised forms and its pH dependence.

▼ M7**Preparations**

Methods based on those principles may be classified as titration, spectrophotometric and conductometric procedures.

Test solutions

For the titration method and conductometric method the chemical substance should be dissolved in distilled water. For spectrophotometric and other methods buffer solutions are used. The concentration of the test substance should not exceed the lesser of 0,01 M or half the saturation concentration, and the purest available form of the substance should be employed in making up the solutions. If the substance is only sparingly soluble, it may be dissolved in a small amount of a water-miscible solvent prior to adding to the concentrations indicated above.

Solutions should be checked for the presence of emulsions using a Tyndall beam, especially if a co-solvent has been used to enhance solubility. Where buffer solutions are used, the buffer concentration should not exceed 0,05 M.

Test conditions*Temperature*

The temperature should be controlled to at least ± 1 °C. The determination should preferably be carried out at 20 °C.

If a significant temperature dependence is suspected, the determination should be carried out at least at two other temperatures. The temperature intervals should be 10 °C in this case and the temperature control $\pm 0,1$ °C.

Analyses

The method will be determined by the nature of the substance being tested. It must be sufficiently sensitive to allow the determination of the different species at each test solution concentration.

Performance of the test*Titration method*

The test solution is determined by titration with the standard base or acid solution as appropriate, measuring the pH after each addition of titrant. At least 10 incremental additions should be made before the equivalence point. If equilibrium is reached sufficiently rapidly, a recording potentiometer may be used. For this method both the total quantity of substance and its concentration need to be accurately known. Precautions must be taken to exclude carbon dioxide. Details of procedure, precautions, and calculation are given in standard tests, e.g. references (1), (2), (3), (4).

Spectrophotometric method

A wavelength is found where the ionised and unionised forms of the substance have appreciably different extinction coefficients. The UV/VIS absorption spectrum is obtained from solutions of constant concentration under a pH condition where the substance is essentially unionised and fully ionised and at several intermediate pHs. This may be done, either by adding increments of concentrated acid (base) to a relatively large volume of a solution of the substance in a multicomponent buffer, initially at high (low) pH (ref. 5), or by adding equal volumes of a stock solution of the substance in e.g. water, methanol, to constant volumes of various buffer solutions covering the desired pH range. From the pH and absorbance values at the chosen wavelength, a sufficient number of values for the pK_a is calculated using data from at least 5 pHs where the substance is at least 10 per cent and less than 90 per cent ionised. Further experimental details and method of calculation are given in reference (1).

▼ M7*Conductometric method*

Using a cell of small, known cell constant, the conductivity of an approximately 0,1 M solution of the substance in conductivity water is measured. The conductivities of a number of accurately-made dilutions of this solution are also measured. The concentration is halved each time, and the series should cover at least an order of magnitude in concentration. The limiting conductivity at infinite dilution is found by carrying out a similar experiment with the Na salt and extrapolating. The degree of dissociation may then be calculated from the conductivity of each solution using the Onsager equation, and hence using the Ostwald Dilution Law the dissociation constant may be calculated as $K = \alpha^2 C / (1 - \alpha)$ where C is the concentration in moles per litre and α is the fraction dissociated. Precautions must be taken to exclude CO_2 . Further experimental details and method of calculation are given in standard texts and references (1), (6) and (7).

DATA AND REPORTING

Treatment of results*Titration method*

The pK_a is calculated for 10 measured points on the titration curve. The mean and standard deviation of such pK_a values are calculated. A plot of pH versus volume of standard base or acid should be included along with a tabular presentation.

Spectrophotometric methods

The absorbance and pH are tabulated from each spectrum. At least five values for the pK_a are calculated from the intermediate spectra data points, and the mean and standard deviation of these results are also calculated.

Conductometric method

The equivalent conductivity Λ is calculated for each acid concentration and for each concentration of a mixture of one equivalent of acid, plus 0,98 equivalent of carbonate-free sodium hydroxide. The acid is in excess to prevent an excess of OH^- due to hydrolysis. $1/\Lambda$ is plotted against \sqrt{C} and Λ_o of the salt can be found by extrapolation to zero concentration.

Λ_o of the acid can be calculated using literature values for H^+ and Na^+ . The pK_a can be calculated from $\alpha = \Lambda_i/\Lambda_o$ and $K_a = \alpha^2 C / (1 - \alpha)$ for each concentration. Better values for K_a can be obtained by making corrections for mobility and activity. The mean and standard deviations of the pK_a values should be calculated.

Test report

All raw data and calculated pK_a values should be submitted together with the method of calculation (preferably in a tabulated format, such as suggested in ref. 1) as should the statistical parameters described above. For titration methods, details of the standardisation of titrants should be given.

For the spectrophotometric method, all spectra should be submitted. For the conductometric method, details of the cell constant determination should be reported. Information on technique used, analytical methods and the nature of any buffers used should be given.

The test temperature(s) should be reported.

LITERATURE:

- (1) Albert, A. & Sergeant, E.P.: *Ionization Constants of Acids and Bases*, Wiley, Inc., New York, 1962.

▼ M7

- (2) Nelson, N.H. & Faust, S.D.: Acidic dissociation constants of selected aquatic herbicides, *Env. Sci. Tech.* 3, II, pp. 1186-1188 (1969).
- (3) ASTM D 1293 — Annual ASTM Standards, Philadelphia, 1974.
- (4) Standard Method 242. APHA/AWWA/WPCF, *Standard Methods for the Examination of Water and Waste Water*, 14th Edition, American Public Health Association, Washington, D.C., 1976.
- (5) Clark, J. & Cunliffe, A.E.: Rapid spectrophotometric measurement of ionisation constants in aqueous solution. *Chem. Ind. (London)* 281, (March 1973).
- (6) ASTM D 1125 — Annual ASTM Standards, Philadelphia, 1974.
- (7) Standard Method 205 — APHA/AWWA/NPCF (see above (4)).
- (8) *Handbook of Chemistry and Physics*, 60th ed. CRC-Press, Boca Raton, Florida, 33431 (1980).

▼B**PART B: METHODS FOR THE DETERMINATION OF TOXICITY AND
OTHER HEALTH EFFECTS**

TABLE OF CONTENTS

GENERAL INTRODUCTION

- B.1 bis. ACUTE ORAL TOXICITY — FIXED DOSE PROCEDURE
- B.1 tris. ACUTE ORAL TOXICITY — ACUTE TOXIC CLASS METHOD
- B.2. ACUTE INHALATION TOXICITY
- B.3. ACUTE TOXICITY (DERMAL)
- B.4. ACUTE DERMAL IRRITATION/CORROSION
- B.5. ACUTE EYE IRRITATION/CORROSION
- B.6. SKIN SENSITISATION
- B.7. REPEATED DOSE 28-DAY ORAL TOXICITY STUDY IN RODENTS
- B.8. SUBACUTE INHALATION TOXICITY: 28-DAY STUDY
- B.9. REPEATED DOSE (28 DAYS) TOXICITY (DERMAL)
- B.10. *IN VITRO* MAMMALIAN CHROMOSOMAL ABERRATION TEST
- B.11. MAMMALIAN BONE MARROW CHROMOSOMAL ABERRATION TEST
- B.12. MAMMALIAN ERYTHROCYTE MICRONUCLEUS TEST
- B.13/14. MUTAGENICITY: REVERSE MUTATION TEST USING BACTERIA
- B.17. *IN VITRO* MAMMALIAN CELL GENE MUTATION TESTS USING THE HPRT AND XPRT GENES
- B.21. *IN VITRO* MAMMALIAN CELL TRANSFORMATION TESTS
- B.22. RODENT DOMINANT LETHAL TEST

▼B

- B.23. MAMMALIAN SPERMATOGONIAL CHROMOSOMAL ABERRATION TEST
- B.25. MOUSE HERITABLE TRANSLOCATION
- B.26. SUB-CHRONIC ORAL TOXICITY TEST REPEATED DOSE 90 — DAY ORAL TOXICITY STUDY IN RODENTS
- B.27. SUB-CHRONIC ORAL TOXICITY TEST REPEATED DOSE 90 — DAY ORAL TOXICITY STUDY IN NON-RODENTS
- B.28. SUB-CHRONIC DERMAL TOXICITY STUDY 90-DAY REPEATED DERMAL DOSE STUDY USING RODENT SPECIES
- B.29. SUBCHRONIC INHALATION TOXICITY: 90-DAY STUDY
- B.30. CHRONIC TOXICITY STUDIES
- B.31. PRENATAL DEVELOPMENTAL TOXICITY STUDY
- B.32. CARCINOGENICITY STUDIES
- B.33. COMBINED CHRONIC TOXICITY/CARCINOGENICITY STUDIES
- B.34. ONE-GENERATION REPRODUCTION TOXICITY TEST
- B.35. TWO-GENERATION REPRODUCTION TOXICITY STUDY
- B.36. TOXICOKINETICS
- B.37. DELAYED NEUROTOXICITY OF ORGANOPHOSPHORUS SUBSTANCES FOLLOWING ACUTE EXPOSURE
- B.38. DELAYED NEUROTOXICITY OF ORGANOPHOSPHORUS SUBSTANCES 28 DAY REPEATED DOSE STUDY
- B.39. UNSCHEDULED DNA SYNTHESIS (UDS) TEST WITH MAMMALIAN LIVER CELLS *IN VIVO*
- B.40. *IN VITRO* SKIN CORROSION: TRANSCUTANEOUS ELECTRICAL RESISTANCE TEST METHOD (TER)
- B.40 BIS. *IN VITRO* SKIN CORROSION: RECONSTRUCTED HUMAN EPIDERMIS (RhE) TEST METHOD
- B.41. *IN VITRO* 3T3 NRU PHOTOTOXICITY TEST
- B.42. SKIN SENSITISATION: LOCAL LYMPH NODE ASSAY

▼ B

- B.43. NEUROTOXICITY STUDY IN RODENTS
- B.44. SKIN ABSORPTION: *IN VIVO* METHOD
- B.45. SKIN ABSORPTION: *IN VITRO* METHOD
- B.46. *IN VITRO* SKIN IRRITATION: RECONSTRUCTED HUMAN EPIDERMIS TEST METHOD
- B.47. BOVINE CORNEAL OPACITY AND PERMEABILITY TEST METHOD FOR IDENTIFYING (I) CHEMICALS INDUCING SERIOUS EYE DAMAGE AND (II) CHEMICALS NOT REQUIRING CLASSIFICATION FOR EYE IRRITATION OR SERIOUS EYE DAMAGE
- B.48. ISOLATED CHICKEN EYE TEST METHOD FOR IDENTIFYING I) CHEMICALS INDUCING SERIOUS EYE DAMAGE AND II) CHEMICALS NOT REQUIRING CLASSIFICATION FOR EYE IRRITATION OR SERIOUS EYE DAMAGE
- B.49. *IN VITRO* MAMMALIAN CELL MICRONUCLEUS TEST
- B.50. SKIN SENSITISATION: LOCAL LYMPH NODE ASSAY: DA
- B.51. SKIN SENSITISATION: LOCAL LYMPH NODE ASSAY: BrdU-ELISA
- B.52. ACUTE INHALATION TOXICITY — ACUTE TOXIC CLASS METHOD
- B.53. DEVELOPMENTAL NEUROTOXICITY STUDY
- B.54. UTEROTROPHIC BIOASSAY IN RODENTS: A SHORT-TERM SCREENING TEST FOR OESTROGENIC PROPERTIES
- B.55. HERSHBERGER BIOASSAY IN RATS: A SHORT-TERM SCREENING ASSAY FOR (ANTI)ANDROGENIC PROPERTIES
- B.56. EXTENDED ONE-GENERATION REPRODUCTIVE TOXICITY STUDY
- B.57. H295R STERIDOGENESIS ASSAY
- B.58. TRANSGENIC RODENT SOMATIC AND GERM CELL GENE MUTATION ASSAYS
- B.59. *IN CHEMICO* SKIN SENSITISATION: DIRECT PEPTIDE REACTIVITY ASSAY (DPRA)
- B.60. *IN VITRO* SKIN SENSITISATION: ARE-NRF2 LUCIFERASE TEST METHOD
- B.61. FLUORESCEIN LEAKAGE TEST METHOD FOR IDENTIFYING OCULAR CORROSIVES AND SEVERE IRRITANTS
- B.62. *IN VIVO* MAMMALIAN ALKALINE COMET ASSAY

▼B

- B.63. REPRODUCTION/DEVELOPMENTAL TOXICITY SCREENING TEST
- B.64. COMBINED REPEATED DOSE TOXICITY STUDY WITH THE REPRODUCTION/DEVELOPMENTAL TOXICITY SCREENING TEST
- B.65. *IN VITRO* MEMBRANE BARRIER TEST METHOD FOR SKIN CORROSION
- B.66. STABLY TRANSFECTED TRANSACTIVATION *IN VITRO* ASSAYS TO DETECT ESTROGEN RECEPTOR AGONISTS AND ANTAGONISTS
- B.67. *IN VITRO* MAMMALIAN CELL GENE MUTATION TESTS USING THE THYMIDINE KINASE GENE
- B.68. SHORT TIME EXPOSURE *IN VITRO* TEST METHOD FOR IDENTIFYING i) CHEMICALS INDUCING SERIOUS EYE DAMAGE AND ii) CHEMICALS NOT REQUIRING CLASSIFICATION FOR EYE IRRITATION OR SERIOUS EYE DAMAGE
- B.69. RECONSTRUCTED HUMAN CORNEA-LIKE EPITHELIUM (RhCE) TEST METHOD FOR IDENTIFYING CHEMICALS NOT REQUIRING CLASSIFICATION AND LABELLING FOR EYE IRRITATION OR SERIOUS EYE DAMAGE
- B.70. HUMAN RECOMBINANT ESTROGEN RECEPTOR (hrER) *IN VITRO* ASSAYS TO DETECT CHEMICALS WITH ER BINDING AFFINITY
- B.71. *IN VITRO* SKIN SENSITISATION ASSAYS ADDRESSING THE KEY EVENT ON ACTIVATION OF DENDRITIC CELLS ON THE ADVERSE OUTCOME PATHWAY (AOP) FOR SKIN SENSITISATION

▼B

GENERAL INTRODUCTION

A. **CHARACTERISATION OF THE TEST SUBSTANCE**

The composition of the test substance, including major impurities, and its relevant physico-chemical properties including stability, should be known prior to the initiation of any toxicity study.

The physico-chemical properties of the test substance provide important information for the selection of the route of administration, the design of each particular study and the handling and storage of the test substance.

The development of an analytical method for qualitative and quantitative determination of the test substance (including major impurities when possible) in the dosing medium and the biological material should precede the initiation of the study.

All information relating to the identification, the physico-chemical properties, the purity, and behaviour of the test substance should be included in the test report.

B. **ANIMAL CARE**

Stringent control of environmental conditions and proper animal care techniques are essential in toxicity testing.

(i) *Housing conditions*

The environmental conditions in the experimental animal rooms or enclosures should be appropriate to the test species. For rats, mice and guinea pigs, suitable conditions are a room temperature of $22 \text{ }^{\circ}\text{C} \pm 3 \text{ }^{\circ}\text{C}$ with a relative humidity of 30 to 70 %; for rabbits the temperature should be $20 \pm 3 \text{ }^{\circ}\text{C}$ with a relative humidity of 30 to 70 %.

Some experimental techniques are particularly sensitive to temperature effects and, in these cases, details of appropriate conditions are included in the description of the test method. In all investigations of toxic effects, the temperature and humidity should be monitored, recorded, and included in the final report of the study.

Lighting should be artificial, the sequence being 12 hours light, 12 hours dark. Details of the lighting pattern should be recorded and included in the final report of the study.

Unless otherwise specified in the method, animals may be housed individually, or be caged in small groups of the same sex; for group caging, no more than five animals should be housed per cage.

In reports of animal experiments, it is important to indicate the type of caging used and the number of animals housed in each cage both during exposure to the chemical and any subsequent observation period.

▼B(ii) *Feeding conditions*

Diets should meet all the nutritional requirements of the species under test. Where test substances are administered to animals in their diet the nutritional value may be reduced by interaction between the substance and a dietary constituent. The possibility of such a reaction should be considered when interpreting the results of tests. Conventional laboratory diets may be used with an unlimited supply of drinking water. The choice of the diet may be influenced by the need to ensure a suitable admixture of a test substance when administered by this method.

Dietary contaminants which are known to influence the toxicity should not be present in interfering concentrations.

C. ALTERNATIVE TESTING

The European Union is committed to promoting the development and validation of alternative techniques which can provide the same level of information as current animal tests, but which use fewer animals, cause less suffering or avoid the use of animals completely.

Such methods, as they become available, must be considered wherever possible for hazard characterisation and consequent classification and labelling for intrinsic hazards and chemical safety assessment.

D. EVALUATION AND INTERPRETATION

When tests are evaluated and interpreted, limitations in the extent to which the results of animal and *in vitro* studies can be extrapolated directly to man must be considered and therefore, evidence of adverse effects in humans, where available, may be used for confirmation of testing results.

E. LITERATURE REFERENCES

Most of these methods are developed within the framework of the OECD programme for Testing Guidelines, and should be performed in conformity with the principles of Good Laboratory Practice, in order to ensure as wide as possible 'mutual acceptance of data'.

Additional information may be found in the references listed in the OECD guidelines and the relevant literature published elsewhere.

▼B**B.1 bis. ACUTE ORAL TOXICITY — FIXED DOSE PROCEDURE****1. METHOD**

This test method is equivalent to OECD TG 420 (2001)

1.1. INTRODUCTION

Traditional methods for assessing acute toxicity use death of animals as an endpoint. In 1984, a new approach to acute toxicity testing was suggested by the British Toxicology Society based on the administration at a series of fixed dose levels (1). The approach avoided using death of animals as an endpoint, and relied instead on the observation of clear signs of toxicity at one of a series of fixed dose levels. Following UK (2) and international (3) *in vivo* validation studies the procedure was adopted as a testing method in 1992. Subsequently, the statistical properties of the Fixed Dose Procedure have been evaluated using mathematical models in a series of studies (4)(5)(6). Together, the *in vivo* and modelling studies have demonstrated that the procedure is reproducible, uses fewer animals and causes less suffering than the traditional methods and is able to rank substances in a similar manner to the other acute toxicity testing methods.

Guidance on the selection of the most appropriate test method for a given purpose can be found in the Guidance Document on Acute Oral Toxicity Testing (7). This guidance document also contains additional information on the conduct and interpretation of Testing Method B.1*bis*.

It is a principle of the method that in the main study only moderately toxic doses are used, and that administration of doses that are expected to be lethal should be avoided. Also, doses that are known to cause marked pain and distress, due to corrosive or severely irritant actions, need not be administered. Moribund animals, or animals obviously in pain or showing signs of severe and enduring distress shall be humanely killed, and are considered in the interpretation of the test results in the same way as animals that died on test. Criteria for making the decision to kill moribund or severely suffering animals, and guidance on the recognition of predictable or impending death, are the subject of a separate Guidance Document (8).

The method provides information on the hazardous properties and allows the substance to be ranked and classified according to the Globally Harmonised System (GHS) for the classification of chemicals which cause acute toxicity (9).

The testing laboratory should consider all available information on the test substance prior to conducting the study. Such information will include the identity and chemical structure of the substance; its physico-chemical properties; the results of any other *in vitro* or *in vivo* toxicity tests on the substance; toxicological data on structurally related substances; and the anticipated use(s) of the substance. This information is necessary to satisfy all concerned that the test is relevant for the protection of human health, and will help in the selection of an appropriate starting dose.

▼ B

1.2. DEFINITIONS

Acute oral toxicity: refers to those adverse effects occurring following oral administration of a single dose of a substance or multiple doses given within 24 hours.

Delayed death: means that an animal does not die or appear moribund within 48 hours but dies later during the 14-day observation period.

Dose: is the amount of test substance administered. Dose is expressed as weight of test substance per unit weight of test animal (e.g. mg/kg).

Evident toxicity: is a general term describing clear signs of toxicity following the administration of test substance (see (3) for examples) such that at the next highest fixed dose either severe pain and enduring signs of severe distress, moribund status (criteria are presented in the Humane Endpoints Guidance Document (8)), or probable mortality in most animals can be expected.

GHS: Globally Harmonised Classification System for Chemical Substances and Mixtures. A joint activity of OECD (human health and the environment), UN Committee of Experts on Transport of Dangerous Goods (physical-chemical properties) and ILO (hazard communication) and coordinated by the Interorganisation Programme for the Sound Management of Chemicals (IOMC).

Impending death: when moribund state or death is expected prior to the next planned time of observation. Signs indicative of this state in rodents could include convulsions, lateral position, recumbence and tremor. (See the Humane Endpoint Guidance Document (8) for more details).

LD₅₀ (median lethal dose): is a statistically derived single dose of a substance that can be expected to cause death in 50 % of animals when administered by the oral route. The LD₅₀ value is expressed in terms of weight of test substance per unit weight of test animal (mg/kg).

Limit dose: refers to a dose at an upper limitation on testing (2 000 or 5 000 mg/kg).

Moribund status: being in a state of dying or inability to survive, even if treated. (See the Humane Endpoint Guidance Document (8) for more details).

Predictable death: presence of clinical signs indicative of death at a known time in the future before the planned end of the experiment, for example: inability to reach water or food. (See the Humane Endpoint Guidance Document (8) for more details).

▼B

1.3. PRINCIPLE OF THE TEST METHOD

Groups of animals of a single sex are dosed in a stepwise procedure using the fixed doses of 5, 50, 300 and 2 000 mg/kg (exceptionally an additional fixed dose of 5 000 mg/kg may be considered, see Section 1.6.2). The initial dose level is selected on the basis of a sighting study as the dose expected to produce some signs of toxicity without causing severe toxic effects or mortality. Clinical signs and conditions associated with pain, suffering, and impending death, are described in detail in a separate OECD Guidance Document (8). Further groups of animals may be dosed at higher or lower fixed doses, depending on the presence or absence of signs of toxicity or mortality. This procedure continues until the dose causing evident toxicity or no more than one death is identified, or when no effects are seen at the highest dose or when deaths occur at the lowest dose.

1.4. DESCRIPTION OF THE TEST METHOD

1.4.1. **Selection of animal species**

The preferred rodent species is the rat, although other rodent species may be used. Normally females are used (7). This is because literature surveys of conventional LD₅₀ tests show that usually there is little difference in sensitivity between the sexes, but in those cases where differences are observed, females are generally slightly more sensitive (10). However, if knowledge of the toxicological or toxicokinetic properties of structurally related chemicals indicates that males are likely to be more sensitive then this sex should be used. When the test is conducted in males, adequate justification should be provided.

Healthy young adult animals of commonly used laboratory strains should be employed. Females should be nulliparous and non-pregnant. Each animal, at the commencement of its dosing, should be between eight and 12 weeks old and its weight should fall in an interval within $\pm 20\%$ of the mean weight of any previously dosed animals.

1.4.2. **Housing and feeding conditions**

The temperature of the experimental animal room should be 22 °C (± 3 °C). Although the relative humidity should be at least 30 % and preferably not exceed 70 % other than during room cleaning the aim should be 50-60 %. Lighting should be artificial, the sequence being 12 hours light, 12 hours dark. For feeding, conventional laboratory diets may be used with an unlimited supply of drinking water. Animals may be group-caged by dose, but the number of animals per cage must not interfere with clear observations of each animal.

1.4.3. **Preparation of animals**

The animals are randomly selected, marked to permit individual identification, and kept in their cages for at least five days prior to the start of dosing to allow for acclimatisation to the laboratory conditions.

▼ B**1.4.4. Preparation of doses**

In general test substances should be administered in a constant volume over the range of doses to be tested by varying the concentration of the dosing preparation. Where a liquid end product or mixture is to be tested however, the use of the undiluted test substance, i.e. at a constant concentration, may be more relevant to the subsequent risk assessment of that substance, and is a requirement of some regulatory authorities. In either case, the maximum dose volume for administration must not be exceeded. The maximum volume of liquid that can be administered at one time depends on the size of the test animal. In rodents, the volume should not normally exceed 1 ml /100 g of body weight: however in the case of aqueous solutions 2 ml/100 g body weight can be considered. With respect to the formulation of the dosing preparation, the use of an aqueous solution/suspension/emulsion is recommended wherever possible, followed in order of preference by a solution/suspension/emulsion in oil (e.g. corn oil) and then possibly solution in other vehicles. For vehicles other than water the toxicological characteristics of the vehicle should be known. Doses must be prepared shortly prior to administration unless the stability of the preparation over the period during which it will be used is known and shown to be acceptable.

1.5. PROCEDURE**1.5.1. Administration of doses**

The test substance is administered in a single dose by gavage using a stomach tube or a suitable intubation canula. In the unusual circumstance that a single dose is not possible, the dose may be given in smaller fractions over a period not exceeding 24 hours.

Animals should be fasted prior to dosing (e.g. with the rat, food but not water should be withheld over-night; with the mouse, food but not water should be withheld for three to four hours). Following the period of fasting, the animals should be weighed and the test substance administered. After the substance has been administered, food may be withheld for a further three to four hours in rats or one to two hours in mice. Where a dose is administered in fractions over a period of time, it may be necessary to provide the animals with food and water depending on the length of the period.

1.5.2. Sighting study

The purpose of the sighting study is to allow selection of the appropriate starting dose for the main study. The test substance is administered to single animals in a sequential manner following the flowcharts in Appendix 1. The sighting study is completed when a decision on the starting dose for the main study can be made (or if a death is seen at the lowest fixed dose).

The starting dose for the sighting study is selected from the fixed dose levels of 5, 50, 300 and 2 000 mg/kg as a dose expected to produce evident toxicity based, when possible, on evidence from *in vivo* and *in vitro* data from the same chemical and from structurally related chemicals. In the absence of such information, the starting dose will be 300 mg/kg.

A period of at least 24 hours will be allowed between the dosing of each animal. All animals should be observed for at least 14 days.

▼B

Exceptionally, and only when justified by specific regulatory needs, the use of an additional upper fixed dose level of 5 000 mg/kg may be considered (see Appendix 3). For reasons of animal welfare concern, testing of animals in GHS Category 5 ranges (2 000-5 000 mg/kg) is discouraged and should only be considered when there is a strong likelihood that the results of such a test have a direct relevance for protecting human or animal health or the environment.

In cases where an animal tested at the lowest fixed dose level (5 mg/kg) in the sighting study dies, the normal procedure is to terminate the study and assign the substance to GHS Category 1 (as shown in Appendix 1). However, if further confirmation of the classification is required, an optional supplementary procedure may be conducted, as follows. A second animal is dosed at 5 mg/kg. If this second animal dies, then GHS Category 1 will be confirmed and the study will be immediately terminated. If the second animal survives, then a maximum of three additional animals will be dosed at 5 mg/kg. Because there will be a high risk of mortality, these animals should be dosed in a sequential manner to protect animal welfare. The time interval between dosing each animal should be sufficient to establish that the previous animal is likely to survive. If a second death occurs, the dosing sequence will be immediately terminated and no further animals will be dosed. Because the occurrence of a second death (irrespective of the number of animals tested at the time of termination) falls into outcome A (two or more deaths), the classification rule of Appendix 2 at the 5 mg/kg fixed dose is followed (Category 1 if there are two or more deaths or Category 2 if there is no more than one death). In addition, Appendix 4 gives guidance on the classification in the EU system until the new GHS is implemented.

1.5.3. Main study**1.5.3.1. Numbers of animals and dose levels**

The action to be taken following testing at the starting dose level is indicated by the flowcharts in Appendix 2. One of three actions will be required; either stop testing and assign the appropriate hazard classification class, test at a higher fixed dose or test at a lower fixed dose. However, to protect animals, a dose level that caused death in the sighting study will not be revisited in the main study (see Appendix 2). Experience has shown that the most likely outcome at the starting dose level will be that the substance can be classified and no further testing will be necessary.

A total of five animals of one sex will normally be used for each dose level investigated. The five animals will be made up of one animal from the sighting study dosed at the selected dose level together with an additional four animals (except, unusually, if a dose level used on the main study was not included in the sighting study).

The time interval between dosing at each level is determined by the onset, duration, and severity of toxic signs. Treatment of animals at the next dose should be delayed until one is confident of survival of the previously dosed animals. A period of three or four days between dosing at each dose level is recommended, if needed, to allow for the observation of delayed toxicity. The time interval may be adjusted as appropriate, e.g. in case of inconclusive response.

▼ B

When the use of an upper fixed dose of 5 000 mg/kg is considered, the procedure outlined in Appendix 3 should be followed (see also section 1.6.2).

1.5.3.2. Limit test

The limit test is primarily used in situations where the experimenter has information indicating that the test material is likely to be nontoxic, i.e., having toxicity only above regulatory limit doses. Information about the toxicity of the test material can be gained from knowledge about similar tested compounds or similar tested mixtures or products, taking into consideration the identity and percentage of components known to be of toxicological significance. In those situations where there is little or no information about its toxicity, or in which the test material is expected to be toxic, the main test should be performed.

Using the normal procedure, a sighting study starting dose of 2 000 mg/kg (or exceptionally 5 000 mg/kg) followed by dosing of a further four animals at this level serves as a limit test for this guideline.

1.6. OBSERVATIONS

Animals are observed individually after dosing at least once during the first 30 minutes, periodically during the first 24 hours, with special attention given during the first four hours, and daily thereafter, for a total of 14 days, except where they need to be removed from the study and humanely killed for animal welfare reasons or are found dead. However, the duration of observation should not be fixed rigidly. It should be determined by the toxic reactions, time of onset and length of recovery period, and may thus be extended when considered necessary. The times at which signs of toxicity appear and disappear are important, especially if there is a tendency for toxic signs to be delayed (11). All observations are systematically recorded, with individual records being maintained for each animal.

Additional observations will be necessary if the animals continue to display signs of toxicity. Observations should include changes in skin and fur, eyes and mucous membranes, and also respiratory, circulatory, autonomic and central nervous systems, and somatomotor activity and behaviour pattern. Attention should be directed to observations of tremors, convulsions, salivation, diarrhoea, lethargy, sleep and coma. The principles and criteria summarised in the Humane Endpoints Guidance Document should be taken into consideration (8). Animals found in a moribund condition and animals showing severe pain or enduring signs of severe distress should be humanely killed. When animals are killed for humane reasons or found dead, the time of death should be recorded as precisely as possible.

1.6.1. Body weight

Individual weights of animals should be determined shortly before the test substance is administered and at least weekly thereafter. Weight changes should be calculated and recorded. At the end of the test surviving animals are weighed and then humanely killed.

▼ B1.6.2. **Pathology**

All test animals (including those that die during the test or are removed from the study for animal welfare reasons) should be subjected to gross necropsy. All gross pathological changes should be recorded for each animal. Microscopic examination of organs showing evidence of gross pathology in animals surviving 24 or more hours after the initial dosing may also be considered because it may yield useful information.

2. **DATA**

Individual animal data should be provided. Additionally, all data should be summarised in tabular form, showing for each test group the number of animals used, the number of animals displaying signs of toxicity, the number of animals found dead during the test or killed for humane reasons, time of death of individual animals, a description and the time course of toxic effects and reversibility, and necropsy findings.

3. **REPORTING**3.1. **TEST REPORT**

The test report must include the following information, as appropriate:

Test substance:

- physical nature, purity, and, where relevant, physico-chemical properties (including isomerisation),
- identification data, including CAS number.

Vehicle (if appropriate):

- justification for choice of vehicle, if other than water.

Test animals:

- species/strain used,
- microbiological status of the animals, when known,
- number, age and sex of animals (including, where appropriate, a rationale for use of males instead of females),
- source, housing conditions, diet, etc.

Test conditions:

- details of test substance formulation, including details of the physical form of the material administered,
- details of the administration of the test substance including dosing volumes and time of dosing,
- details of food and water quality (including diet type/source, water source),
- the rationale for the selection of the starting dose.

▼B

Results:

- tabulation of response data and dose level for each animal (i.e. animals showing signs of toxicity including mortality, nature, severity and duration of effects),
- tabulation of body weight and body weight changes,
- individual weights of animals at the day of dosing, in weekly intervals thereafter, and at time of death or sacrifice,
- date and time of death if prior to scheduled sacrifice,
- time course of onset of signs of toxicity and whether these were reversible for each animal,
- necropsy findings and histopathological findings for each animal, if available.

Discussion and interpretation of results.

Conclusions.

4. REFERENCES

- (1) British Toxicology Society Working Party on Toxicity (1984) Special report: a new approach to the classification of substances and preparations on the basis of their acute toxicity. *Human Toxicol.*, 3, p. 85-92.
- (2) Van den Heuvel, M.J., Dayan, A.D. and Shillaker, R.O (1987) Evaluation of the BTS approach to the testing of substances and preparations for their acute toxicity. *Human Toxicol.*, 6, p. 279-291.
- (3) Van den Heuvel, M.J., Clark, D.G., Fielder, R.J., Koundakjian, P.P., Oliver, G.J.A., Pelling, D., Tomlinson, N.J. and Walker, A.P (1990) The international validation of a fixed-dose procedure as an alternative to the classical LD₅₀ test. *Fd. Chem. Toxicol.* 28, p. 469-482.
- (4) Whitehead, A. and Curnow, R.N (1992) Statistical evaluation of the fixed-dose procedure. *Fd. Chem. Toxicol.*, 30, p. 313-324.
- (5) Stallard, N. and Whitehead, A (1995) Reducing numbers in the fixed-dose procedure. *Human Exptl. Toxicol.* 14, p. 315-323.
- (6) Stallard, N., Whitehead, A and Ridgeway, P. (2002) Statistical evaluation of the revised fixed dose procedure. *Hum. Exp. Toxicol.*, 21, p. 183-196.
- (7) OECD (2001) Guidance Document on Acute Oral Toxicity Testing. Environmental Health and Safety Monograph Series on Testing and Assessment No 24. Paris
- (8) OECD (2000) Guidance Document on the Recognition, Assessment and Use of Clinical Signs as Humane Endpoints for Experimental Animals Used in Safety Evaluation. Environmental Health and Safety Monograph Series on Testing and Assessment No 19.

▼B

- (9) OECD (1998) Harmonised Integrated Hazard Classification for Human Health and Environmental Effects of Chemical Substances as endorsed by the 28th Joint Meeting of the Chemicals Committee and the Working Party on Chemicals in November 1998, Part 2, p. 11 [<http://webnet1.oecd.org/oecd/pages/home/displaygeneral/0,3380, EN-documents-521-14-no-24-no-0,FF.html>].
- (10) Lipnick, R.L., Cotruvo, J.A., Hill, R.N., Bruce, R.D., Stitzel, K.A., Walker, A.P., Chu, I., Goddard, M., Segal, L., Springer, J.A. and Myers, R.C (1995) Comparison of the Up-and-Down, Conventional LD₅₀, and Fixed-Dose Acute Toxicity Procedures. *Fd. Chem. Toxicol.* 33, p. 223-231.
- (11) Chan P.K and A. W Hayes (1994) Chapter 16 Acute Toxicity and Eye Irritation. In: *Principles and Methods of Toxicology*. 3rd Edition. A.W. Hayes, Editor. Raven Press Ltd. New York, USA.

FLOW CHART FOR THE SIGHTING STUDY

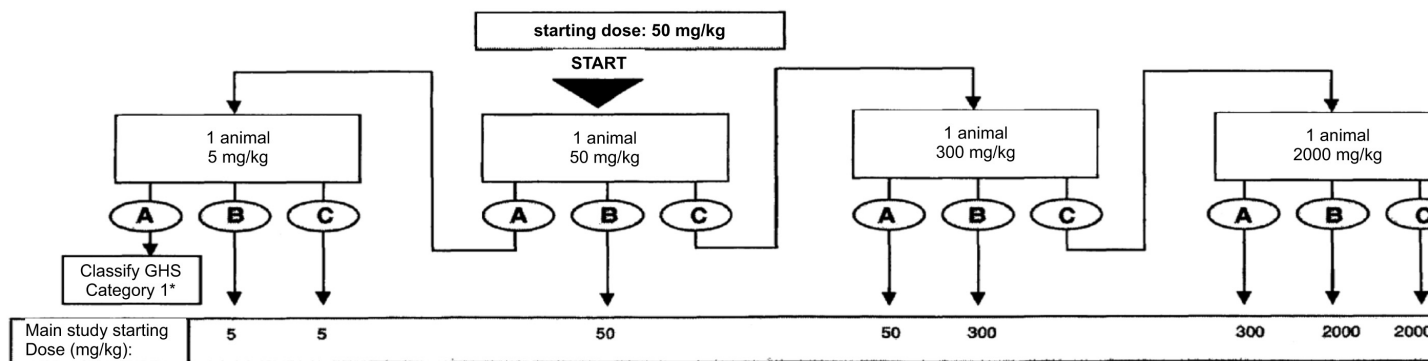
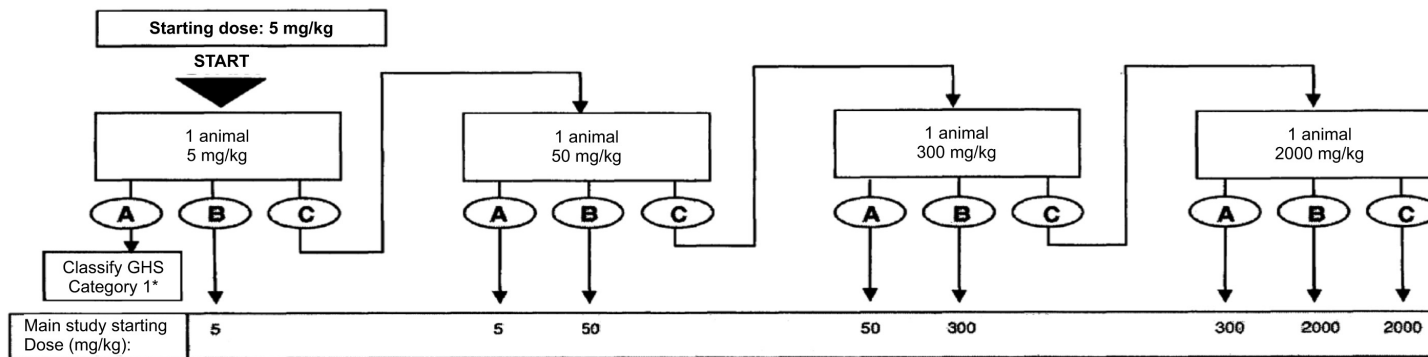

Outcome

A death

B evident toxicity

C no evident toxicity and no death

* for outcome **A** at 5 mg/kg there is an optional supplementary procedure to confirm the GHS classification: see section 1.5.2

▼B

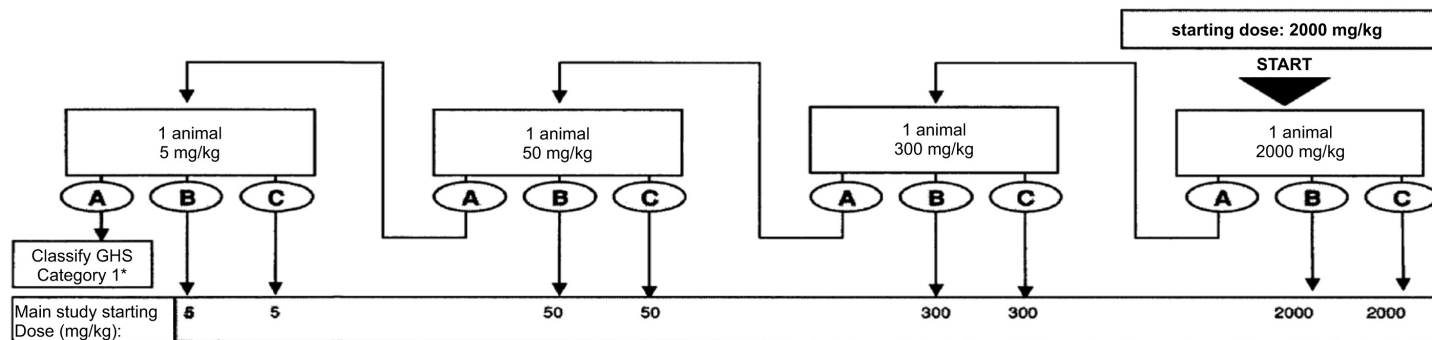
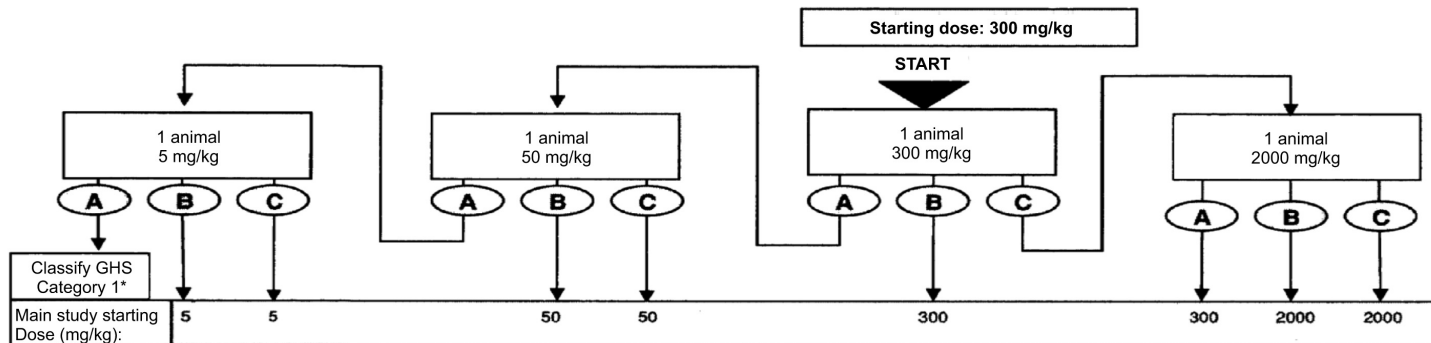

Outcome	
(A)	death
(B)	evident toxicity
(C)	no evident toxicity and no death

* for outcome (A) at 5 mg/kg there is an optional supplementary procedure to confirm the GHS classification: see section 1.5.2

FLOW CHART FOR THE MAIN STUDY

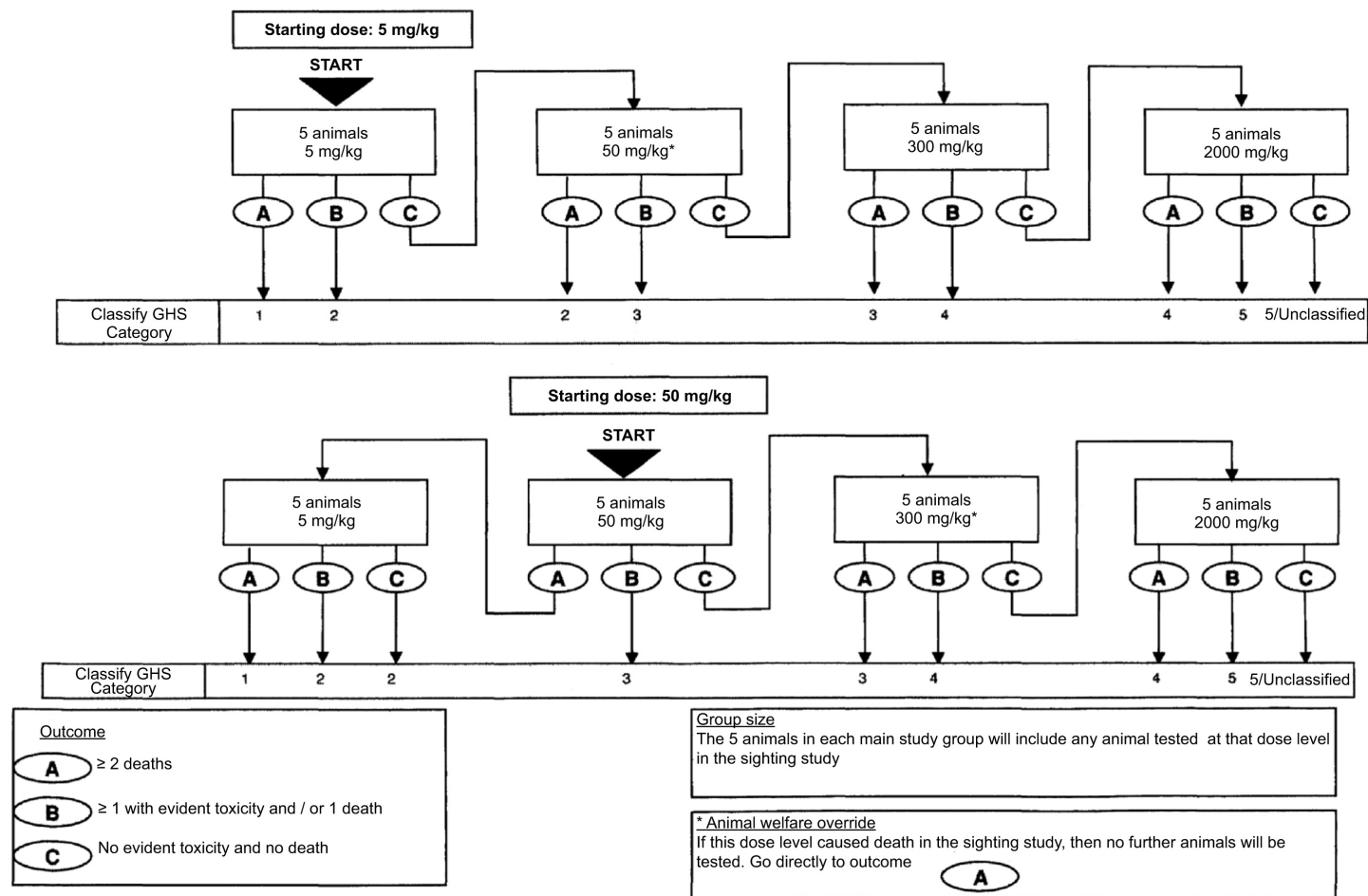

▼B

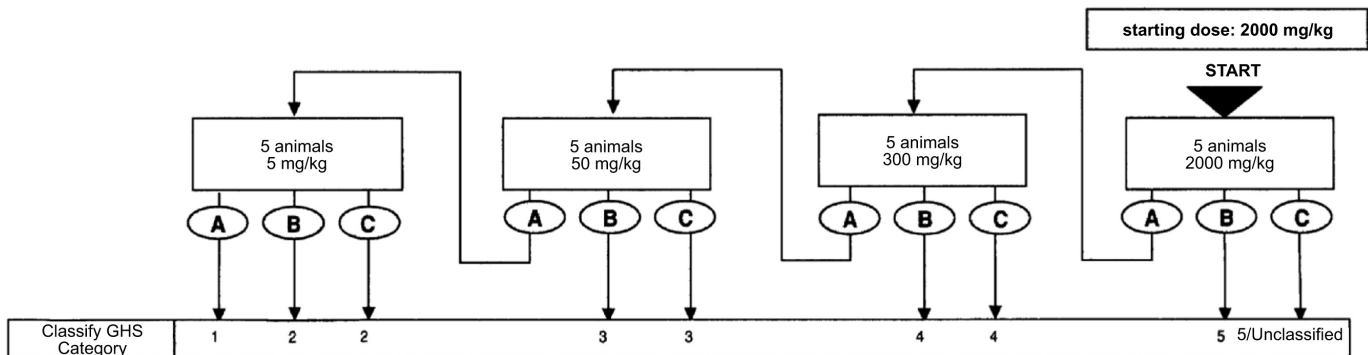
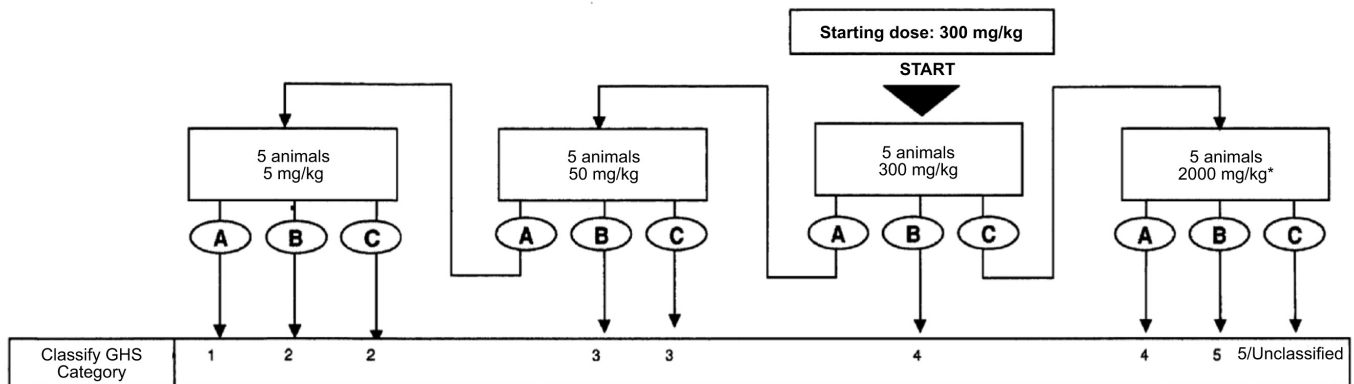

<u>Outcome</u>	
A	≥ 2 deaths
B	≥ 1 with evident toxicity and / or 1 death
C	No evident toxicity and no death

Group size
The 5 animals in each main study group will include any animal tested at that dose level in the sighting study

* Animal welfare override
If this dose level caused death in the sighting study, then no further animals will be tested. Go directly to outcome **A**

*Appendix 3***CRITERIA FOR CLASSIFICATION OF TEST SUBSTANCES WITH EXPECTED LD₅₀ VALUES EXCEEDING 2 000 MG/KG WITHOUT THE NEED FOR TESTING.**

Criteria for hazard Category 5 are intended to enable the identification of test substances which are of relatively low acute toxicity hazard but which, under certain circumstances may present a danger to vulnerable populations. These substances are anticipated to have an oral or dermal LD₅₀ in the range of 2 000-5 000 mg/kg or equivalent doses for other routes. Test substances could be classified in the hazard category defined by: 2 000 mg/kg < LD₅₀ < 5 000 mg/kg (Category 5 in the GHS) in the following cases:

- (a) if directed to this category by any of the testing schemes of Appendix 2, based on mortality incidences

- (b) if reliable evidence is already available that indicates the LD₅₀ to be in the range of Category 5 values; or other animal studies or toxic effects in humans indicate a concern for human health of an acute nature;

- (c) through extrapolation, estimation or measurement of data if assignment to a more hazardous class is not warranted; and
 - reliable information is available indicating significant toxic effects in humans, or

 - any mortality is observed when tested up to Category 4 values by the oral route, or

 - where expert judgement confirms significant clinical signs of toxicity, when tested up to Category 4 values, except for diarrhoea, piloerection or an ungroomed appearance, or

 - where expert judgement confirms reliable information indicating the potential for significant acute effects from the other animal studies.

TESTING AT DOSES ABOVE 2 000 MG/KG

Exceptionally, and only when justified by specific regulatory needs, the use of an additional upper fixed dose level of 5 000 mg/kg may be considered. Recognising the need to protect animal welfare, testing at 5 000 mg/kg is discouraged and should only be considered when there is a strong likelihood that the results of such a test would have a direct relevance for protecting animal or human health (9).

Sighting study

The decision rules governing the sequential procedure presented in Appendix 1 are extended to include a 5 000 mg/kg dose level. Thus, when a sighting study starting dose of 5 000 mg/kg is used outcome A (death) will require a second animal to be tested at 2 000 mg/kg; outcomes B and C (evident toxicity or no toxicity) will allow the selection of 5 000 mg/kg as the main study starting dose. Similarly, if a starting dose other than 5 000 mg/kg is used then testing will progress to 5 000 mg/kg in the event of outcomes B or C at 2 000 mg/kg; a subsequent 5 000 mg/kg outcome A will dictate a main study starting dose of 2 000 mg/kg and outcomes B and C will dictate a main study starting dose of 5 000 mg/kg.

▼ B**Main study**

The decision rules governing the sequential procedure presented in Appendix 2 are extended to include a 5 000 mg/kg dose level. Thus, when a main study starting dose of 5 000 mg/kg is used, outcome A (≥ 2 deaths) will require the testing of a second group at 2 000 mg/kg; outcome B (evident toxicity and/or ≤ 1 death) or C (no toxicity) will result in the substance being unclassified according to GHS. Similarly, if a starting dose other than 5 000 mg/kg is used then testing will progress to 5 000 mg/kg in the event of outcome C at 2 000 mg/kg; a subsequent 5 000 mg/kg outcome A will result in the substance being assigned to GHS Category 5 and outcomes B or C will lead to the substance being unclassified.

TEST METHOD B.1 bis

Guidance on classification according to the EU scheme to cover the transition period until full implementation of the Globally Harmonised Classification System (GHS) (taken from reference (8))

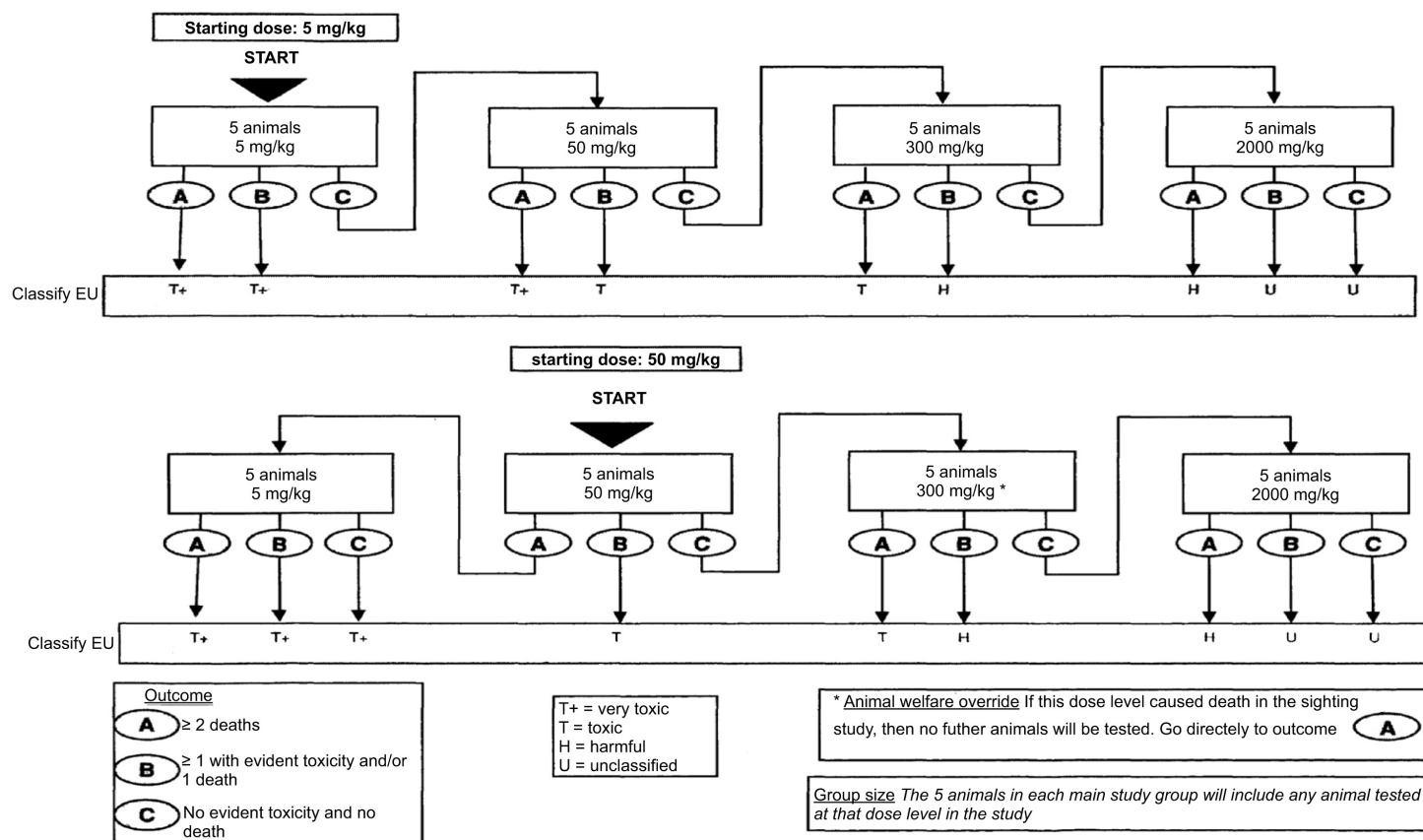

▼B

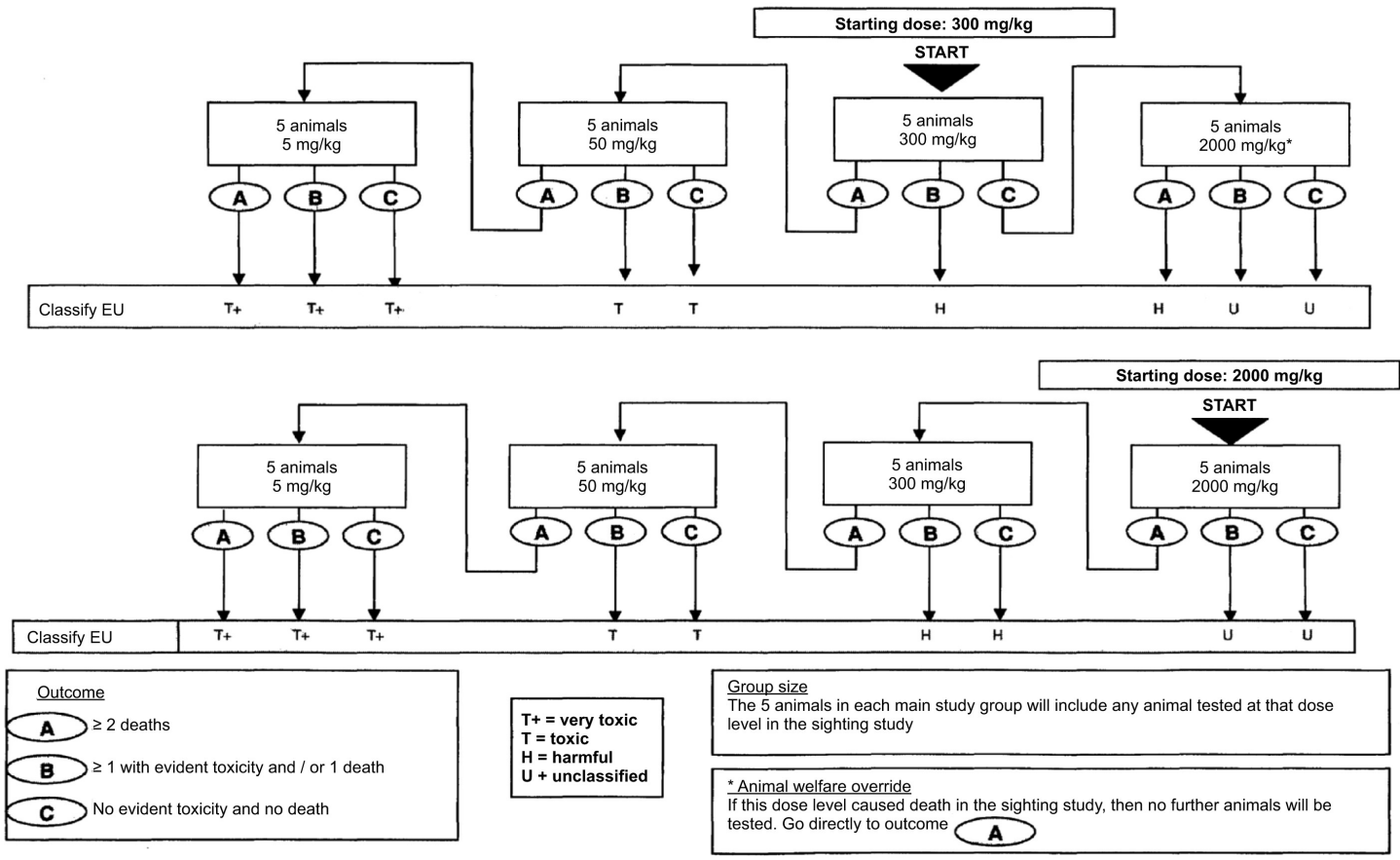

▼B**B.1 tris. ACUTE ORAL TOXICITY — ACUTE TOXIC CLASS METHOD****1. METHOD**

This test method is equivalent to OECD TG 423 (2001)

1.1. INTRODUCTION

The acute toxic class method (1) set out in this test is a stepwise procedure with the use of three animals of a single sex per step. Depending on the mortality and/or the moribund status of the animals, on average two to four steps may be necessary to allow judgement on the acute toxicity of the test substance. This procedure is reproducible, uses very few animals and is able to rank substances in a similar manner to the other acute toxicity testing methods. The acute toxic class method is based on biometric evaluations (2)(3)(4)(5) with fixed doses, adequately separated to enable a substance to be ranked for classification purposes and hazard assessment. The method as adopted in 1996 was extensively validated *in vivo* against LD₅₀ data obtained from the literature, both nationally (6) and internationally (7).

Guidance on the selection of the most appropriate test method for a given purpose can be found in the Guidance Document on Acute Oral Toxicity Testing (8). This Guidance Document also contains additional information on the conduct and interpretation of testing method B.1.tris.

Test substances, at doses that are known to cause marked pain and distress due to corrosive or severely irritant actions, need not be administered. Moribund animals, or animals obviously in pain or showing signs of severe and enduring distress shall be humanely killed, and are considered in the interpretation of the test results in the same way as animals that died on test. Criteria for making the decision to kill moribund or severely suffering animals, and guidance on the recognition of predictable or impending death, are the subject of a separate Guidance Document (9).

The method uses pre-defined doses and the results allow a substance to be ranked and classified according to the Globally Harmonised System for the classification of chemicals which cause acute toxicity (10).

In principle, the method is not intended to allow the calculation of a precise LD₅₀, but does allow for the determination of defined exposure ranges where lethality is expected since death of a proportion of the animals is still the major endpoint of this test. The method allows for the determination of an LD₅₀ value only when at least two doses result in mortality higher than 0 % and lower than 100 %. The use of a selection of pre-defined doses, regardless of test substance, with classification explicitly tied to number of animals observed in different states improves the opportunity for laboratory to laboratory reporting consistency and repeatability.

▼B

The testing laboratory should consider all available information on the test substance prior to conducting the study. Such information will include the identity and chemical structure of the substance; its physico-chemical properties; the result of any other *in vivo* or *in vitro* toxicity tests on the substance; toxicological data on the structurally related substances; and the anticipated use(s) of the substance. This information is necessary to satisfy all concerned that the test is relevant for the protection of human health and will help in the selection of the most appropriate starting dose.

1.2. DEFINITIONS

Acute oral toxicity: refers to those adverse effects occurring following oral administration of a single dose of a substance or multiple doses given within 24 hours.

Delayed death: means that an animal does not die or appear moribund within 48 hours but dies later during the 14-day observation period.

Dose: is the amount of test substance administered. Dose is expressed as weight of test substance per unit weight of test animal (e.g. mg/kg).

GHS: Globally Harmonised Classification System for Chemical Substances and Mixtures. A joint activity of OECD (human health and the environment), UN Committee of Experts on Transport of Dangerous Goods (physical-chemical properties) and ILO (hazard communication) and coordinated by the Interorganisation Programme for the Sound Management of Chemicals (IOMC).

Impending death: when moribund state or death is expected prior to the next planned time of observation. Signs indicative of this state in rodents could include convulsions, lateral position, recumbence and tremor (See the Humane Endpoint Guidance Document (9) for more details).

LD₅₀ (median lethal oral dose): is a statistically derived single dose of a substance that can be expected to cause death in 50 % of animals when administered by the oral route. The LD₅₀ value is expressed in terms of weight of test substance per unit weight of test animal (mg/kg).

Limit dose: refers to a dose at an upper limitation on testing (2 000 or 5 000 mg/kg).

Moribund status: being in a state of dying or inability to survive, even if treated (See the Humane Endpoint Guidance Document (9) for more details).

Predictable death: presence of clinical signs indicative of death at a known time in the future before the planned end of the experiment; for example: inability to reach water or food. (See the Humane Endpoint Guidance Document (9) for more details).

▼B

1.3. PRINCIPLE OF THE TEST

It is the principle of the test that, based on a stepwise procedure with the use of a minimum number of animals per step, sufficient information is obtained on the acute toxicity of the test substance to enable its classification. The substance is administered orally to a group of experimental animals at one of the defined doses. The substance is tested using a stepwise procedure, each step using three animals of a single sex (normally females). Absence or presence of compound-related mortality of the animals dosed at one step will determine the next step, i.e.;

— no further testing is needed,

— dosing of three additional animals, with the same dose,

— dosing of three additional animals at the next higher or the next lower dose level.

Details of the test procedure are described in Appendix 1. The method will enable a judgement with respect to classifying the test substance to one of a series of toxicity classes defined by fixed LD₅₀ cut-off values.

1.4. DESCRIPTION OF THE METHOD

1.4.1. **Selection of animal species**

The preferred rodent species is the rat, although other rodent species may be used. Normally females are used (9). This is because literature surveys of conventional LD₅₀ tests show that, although there is little difference in sensitivity between the sexes, in those cases where differences are observed females are generally slightly more sensitive (11). However if knowledge of the toxicological or toxicokinetic properties of structurally related chemicals indicates that males are likely to be more sensitive, then this sex should be used. When the test is conducted in males, adequate justification should be provided.

Healthy young adult animals of commonly used laboratory strains should be employed. Females should be nulliparous and non-pregnant. Each animal, at the commencement of its dosing, should be between eight and 12 weeks old and its weight should fall in an interval within $\pm 20\%$ of the mean weight of any previously dosed animals.

1.4.2. **Housing and feeding conditions**

The temperature in the experimental animal room should be 22 °C (± 3 °C). Although the relative humidity should be at least 30 % and preferably not exceed 70 % other than during room cleaning the aim should be 50-60 %. Lighting should be artificial, the sequence being 12 hours light, 12 hours dark. For feeding, conventional laboratory diets may be used with an unlimited supply of drinking water. Animals may be group-caged by dose, but the number of animals per cage must not interfere with clear observations of each animal.

▼B**1.4.3. Preparation of animals**

The animals are randomly selected, marked to permit individual identification, and kept in their cages for at least five days prior to dosing to allow for acclimatisation to the laboratory conditions.

1.4.4. Preparation of doses

In general, test substances should be administered in a constant volume over the range of doses to be tested by varying the concentration of the dosing preparation. Where a liquid end product or mixture is to be tested however, the use of the undiluted test substance, i.e. at a constant concentration, may be more relevant to the subsequent risk assessment of that substance, and is a requirement of some regulatory authorities. In either case, the maximum dose volume for administration must not be exceeded. The maximum volume of liquid that can be administered at one time depends on the size of the test animal. In rodents, the volume should not normally exceed 1 ml/100 g of body weight: however in the case of aqueous solutions 2 ml/100 g body weight can be considered. With respect to the formulation of the dosing preparation, the use of an aqueous solution/suspension/emulsion is recommended wherever possible, followed in order of preference by a solution/suspension/emulsion in oil (e.g. corn oil) and then possibly solution in other vehicles. For vehicles other than water the toxicological characteristics of the vehicle should be known. Doses must be prepared shortly prior to administration unless the stability of the preparation over the period during which it will be used is known and shown to be acceptable.

1.5. PROCEDURE**1.5.1. Administration of doses**

The test substance is administered in a single dose by gavage using a stomach tube or a suitable intubation canula. In the unusual circumstance that a single dose is not possible, the dose may be given in smaller fractions over a period not exceeding 24 hours.

Animals should be fasted prior to dosing (e.g. with the rat, food but not water should be withheld overnight, with the mouse, food but not water should be withheld for three or four hours). Following the period of fasting, the animals should be weighed and the test substance administered. After the substance has been administered, food may be withheld for a further three or four hours in rats or one or two hours in mice. Where a dose is administered in fractions over a period it may be necessary to provide the animals with food and water depending on the length of the period.

1.5.2. Number of animals and dose levels

Three animals are used for each step. The dose level to be used as the starting dose is selected from one of four fixed levels, 5, 50, 300 and 2 000 mg/kg body weight. The starting dose level should be that which is most likely to produce mortality in some of the dosed animals. The flowcharts of Appendix 1 describe the procedure that should be followed for each of the starting doses. In addition, Appendix 4 gives guidance on the classification in the EU system until the new GHS is implemented.

▼B

When available information suggests that mortality is unlikely at the highest starting dose level (2 000 mg/kg body weight), then a limit test should be conducted. When there is no information on a substance to be tested, for animal welfare reasons it is recommended to use the starting dose of 300 mg/kg body weight.

The time interval between treatment groups is determined by the onset, duration, and severity of toxic signs. Treatment of animals at the next dose should be delayed until one is confident of survival of the previously dosed animals.

Exceptionally, and only when justified by specific regulatory needs, the use of additional upper dose level of 5 000 mg/kg body weight may be considered (see Appendix 2). For reasons of animal welfare concern, testing of animals in GHS Category 5 ranges (2 000-5 000 mg/kg) is discouraged and should only be considered when there is a strong likelihood that the results of such a test would have a direct relevance for protecting human or animal health or the environment.

1.5.3. Limit test

The limit test is primarily used in situations where the experimenter has information indicating that the test material is likely to be non-toxic, i.e., having toxicity only above regulatory limit doses. Information about the toxicity of the test material can be gained from knowledge about similar tested compounds or similar tested mixtures or products, taking into consideration the identity and percentage of components known to be of toxicological significance. In those situations where there is little or no information about its toxicity, or in which the test material is expected to be toxic, the main test should be performed.

A limit test at one dose level of 2 000 mg/kg body weight may be carried out with six animals (three animals per step). Exceptionally a limit test at one dose level of 5 000 mg/kg may be carried out with three animals (see Appendix 2). If test substance-related mortality is produced, further testing at the next lower level may need to be carried out.

1.6. OBSERVATIONS

Animals are observed individually after dosing at least once during the first 30 minutes, periodically during the first 24 hours, with special attention given during the first four hours, and daily thereafter, for a total of 14 days, except where they need to be removed from the study and humanely killed for animal welfare reasons or are found dead. However, the duration of observation should not be fixed rigidly. It should be determined by the toxic reactions, time of onset and length of recovery period, and may thus be extended when considered necessary. The times at which signs of toxicity appear and disappear are important, especially if there is a tendency for toxic signs to be delayed (12). All observations are systematically recorded with individual records being maintained for each animal.

▼ B

Additional observations will be necessary if the animals continue to display signs of toxicity. Observations should include changes in skin and fur, eyes and mucous membranes, and also respiratory, circulatory, autonomic and central nervous systems, and somatomotor activity and behaviour pattern. Attention should be directed to observations of tremors, convulsions, salivation, diarrhoea, lethargy, sleep and coma. The principles and criteria summarised in the Humane Endpoints Guidance Document (9) should be taken into consideration. Animals found in a moribund condition and animals showing severe pain or enduring signs of severe distress should be humanely killed. When animals are killed for humane reasons or found dead, the time of death should be recorded as precisely as possible.

1.6.1. Body weight

Individual weights of animals should be determined shortly before the test substance is administered, and at least weekly thereafter. Weight changes should be calculated and recorded. At the end of the test surviving animals are weighed and humanely killed.

1.6.2. Pathology

All test animals (including those that die during the test or are removed from the study for animal welfare reasons) should be subjected to gross necropsy. All gross pathological changes should be recorded for each animal. Microscopic examination of organs showing evidence of gross pathology in animals surviving 24 or more hours may also be considered because it may yield useful information.

2. DATA

Individual animal data should be provided. Additionally, all data should be summarised in tabular form, showing for each test group the number of animals used, the number of animals displaying signs of toxicity, the number of animals found dead during the test or killed for humane reasons, time of death of individual animals, a description and the time course of toxic effects and reversibility, and necropsy findings.

3. REPORTING**3.1. Test report**

The test report must include the following information, as appropriate:

Test substance:

— physical nature, purity, and, where relevant, physico-chemical properties (including isomerisation),

— identification data, including CAS number.

Vehicle (if appropriate):

— justification for choice of vehicle, if other than water.

Test animals:

— species/strain used,

▼B

- microbiological status of the animals, when known,
- number, age, and sex of animals (including, where appropriate, a rationale for the use of males instead of females),
- source, housing conditions, diet, etc.

Test conditions:

- details of test substance formulation including details of the physical form of the material administered,
- details of the administration of the test substance including dosing volumes and time of dosing,
- details of food and water quality (including diet type/source, water source),
- the rationale for the selection of the starting dose.

Results:

- tabulation of response data and dose level for each animal (i.e. animals showing signs of toxicity including mortality; nature, severity, and duration of effects),
- tabulation of body weight and body weight changes,
- individual weights of animals at the day of dosing, in weekly intervals thereafter, and at the time of death or sacrifice,
- date and time of death if prior to scheduled sacrifice,
- time course of onset of signs of toxicity, and whether these were reversible for each animal,
- necropsy findings and histopathological findings for each animal, if available.

Discussion and interpretation of results.

Conclusions.

4.

REFERENCES

- (1) Roll R., Höfer-Bosse Th. And Kayser D (1986) New Perspectives in Acute Toxicity Testing of Chemicals. *Toxicol. Lett.*, Suppl. 31, p. 86.
- (2) Roll R., Riebschläger M., Mischke U. and Kayser D (1989) Neue Wege zur Bestimmung der akuten Toxizität von Chemikalien. *Bundesgesundheitsblatt* 32, p. 336-341.
- (3) Diener W., Sichha L., Mischke U., Kayser D. and Schlede E (1994) The Biometric Evaluation of the Acute-Toxic-Class Method (Oral). *Arch. Toxicol.* 68, p. 559-610.
- (4) Diener W., Mischke U., Kayser D. and Schlede E., (1995) The Biometric Evaluation of the OECD Modified Version of the Acute-Toxic-Class Method (Oral). *Arch. Toxicol.* 69, p. 729-734.
- (5) Diener W., and Schlede E., (1999) Acute Toxicity Class Methods: Alterations to LD/LC₅₀ Tests. *ALTEX* 16, p. 129-134.
- (6) Schlede E., Mischke U., Roll R. and Kayser D., (1992). A National Validation Study of the Acute-Toxic- Class Method — An Alternative to the LD₅₀ Test. *Arch. Toxicol.* 66, 455-470.

▼B

- (7) Schlede E., Mischke U., Diener W. and Kayser D., (1994) The International Validation Study of the Acute-Toxic-Class Method (Oral). *Arch. Toxicol.* 69, p. 659-670.
- (8) OECD, (2001) Guidance Document on Acute Oral Toxicity Testing. Environmental Health and Safety Monograph Series on Testing and Assessment No 24. Paris.
- (9) OECD, (2000) Guidance Document on the Recognition, Assessment and Use of Clinical Signs as Humane Endpoints for Experimental Animals Used in Safety Evaluation. Environmental Health and Safety Monograph Series on Testing and Assessment No 19.
- (10) OECD, (1998) Harmonised Integrated Hazard Classification System For Human Health And Environmental Effects Of Chemical Substances as endorsed by the 28th Joint Meeting of the Chemicals Committee and the Working Party on Chemicals in November 1998, Part 2, p. 11 [<http://webnet1.oecd.org/oecd/pages/home/displaygeneral/0,3380,EN-documents-521-14-no-24-no-0,FF.html>].
- (11) Lipnick R. L., Cotruvo, J.A., Hill R. N., Bruce R. D., Stitzel K. A., Walker A. P., Chu I.; Goddard M., Segal L., Springer J. A. and Myers R. C. (1995) Comparison of the Up-and Down, Conventional LD₅₀, and Fixed Dose Acute Toxicity Procedures. *Fd. Chem. Toxicol* 33, p. 223-231.
- (12) Chan P.K. and A.W. Hayes. (1994). Chap. 16. Acute Toxicity and Eye Irritancy. *Principles and Methods of Toxicology*. Third Edition. A.W. Hayes, Editor. Raven Press, Ltd., New York, USA.

▼B*Appendix 1***PROCEDURE TO BE FOLLOWED FOR EACH OF THE STARTING DOSES***GENERAL REMARKS*

For each starting dose, the respective testing schemes as included in this Appendix outline the procedure to be followed.

- Appendix 1 a: starting dose is 5 mg/kg bw,
- Appendix 1 b: starting dose is 50 mg/kg bw,
- Appendix 1 c: starting dose is: 300 mg/kg bw,
- Appendix 1 d: starting dose is: 2 000 mg/kg bw.

Depending on the number of humanely killed or dead animals, the test procedure follows the indicated arrows.

TEST PROCEDURE WITH A STARTING DOSE OF 5 MG/KG BODY WEIGHT

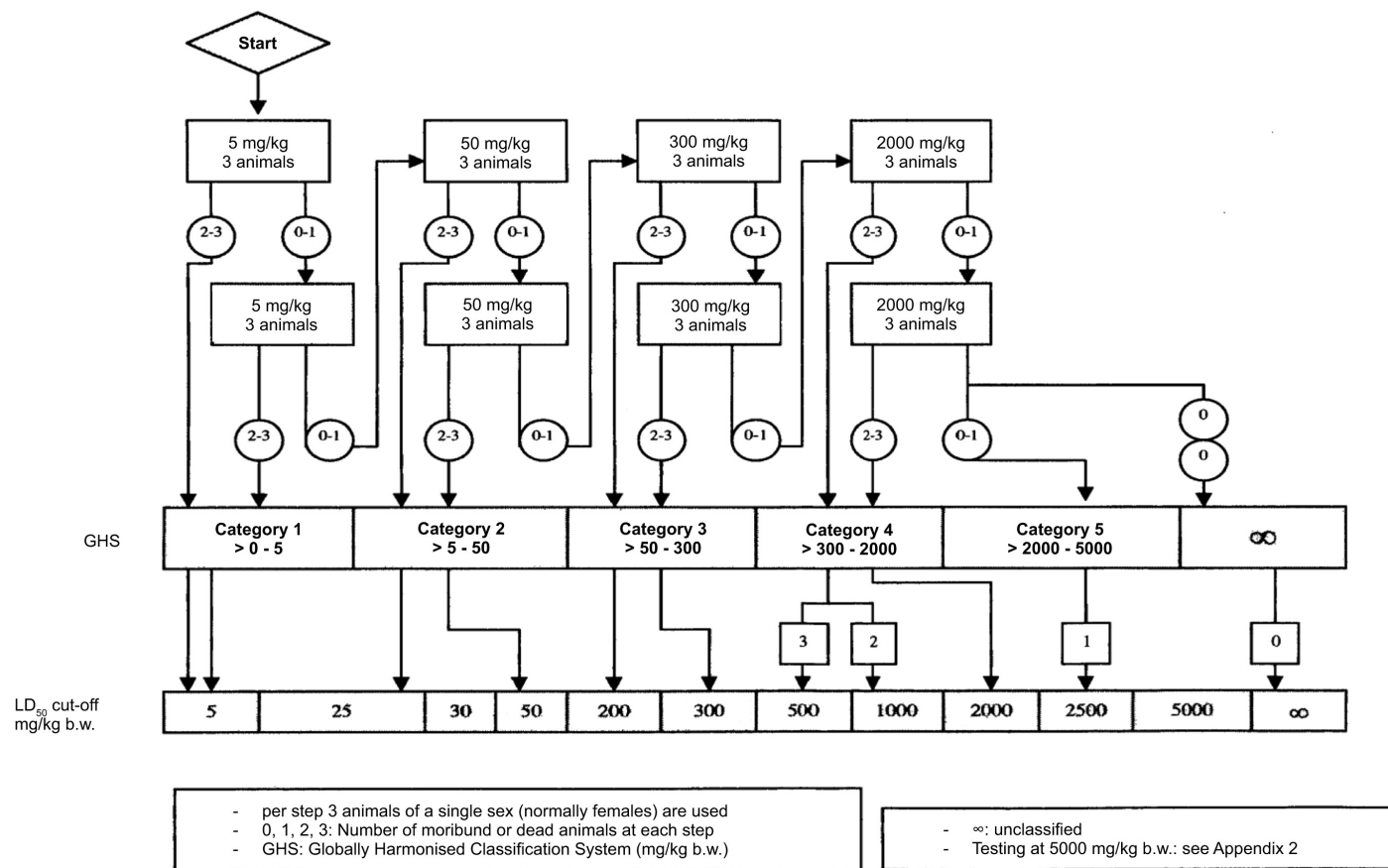

TEST PROCEDURE WITH A STARTING DOSE OF 50 MG/KG BODY WEIGHT

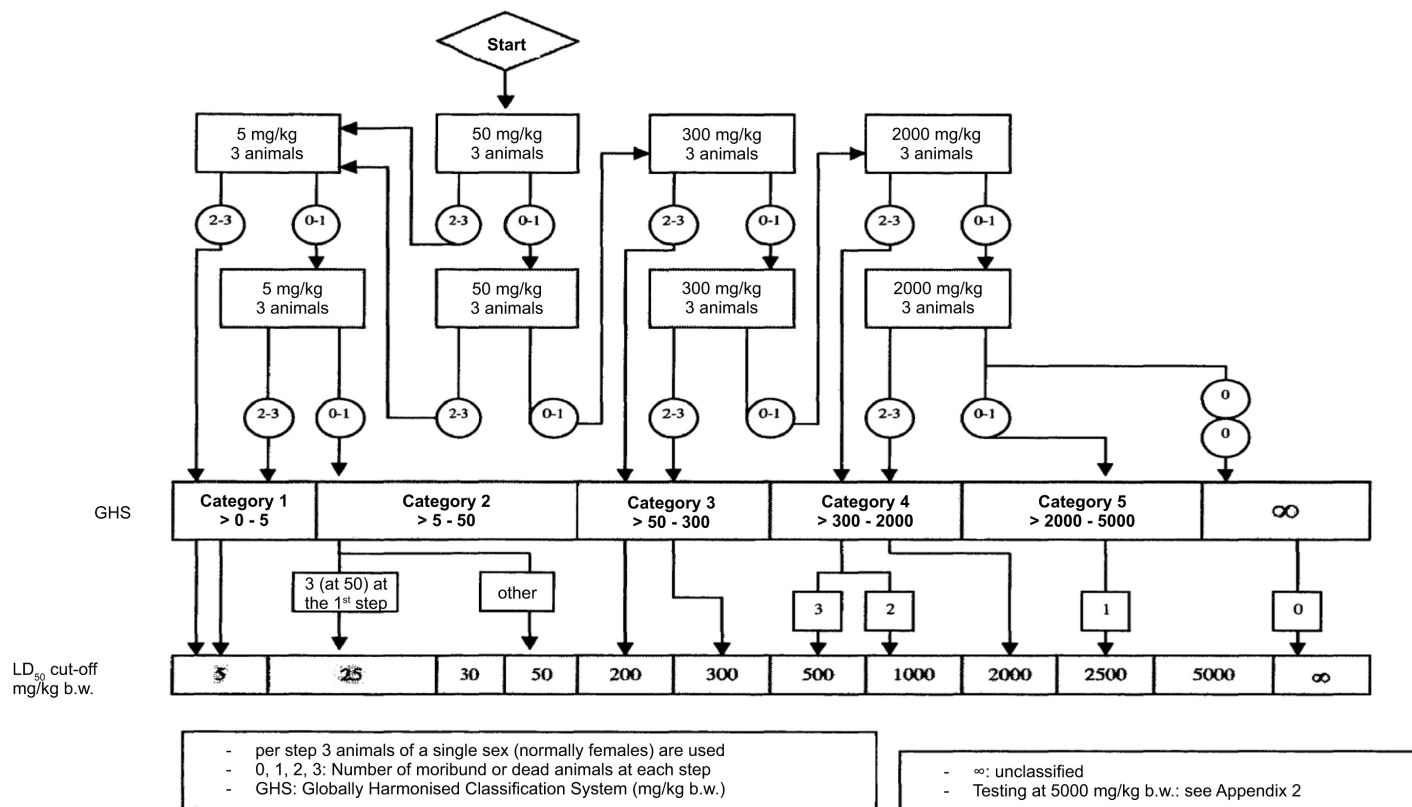

TEST PROCEDURE WITH A STARTING DOSE OF 300 MG/KG BODY WEIGHT

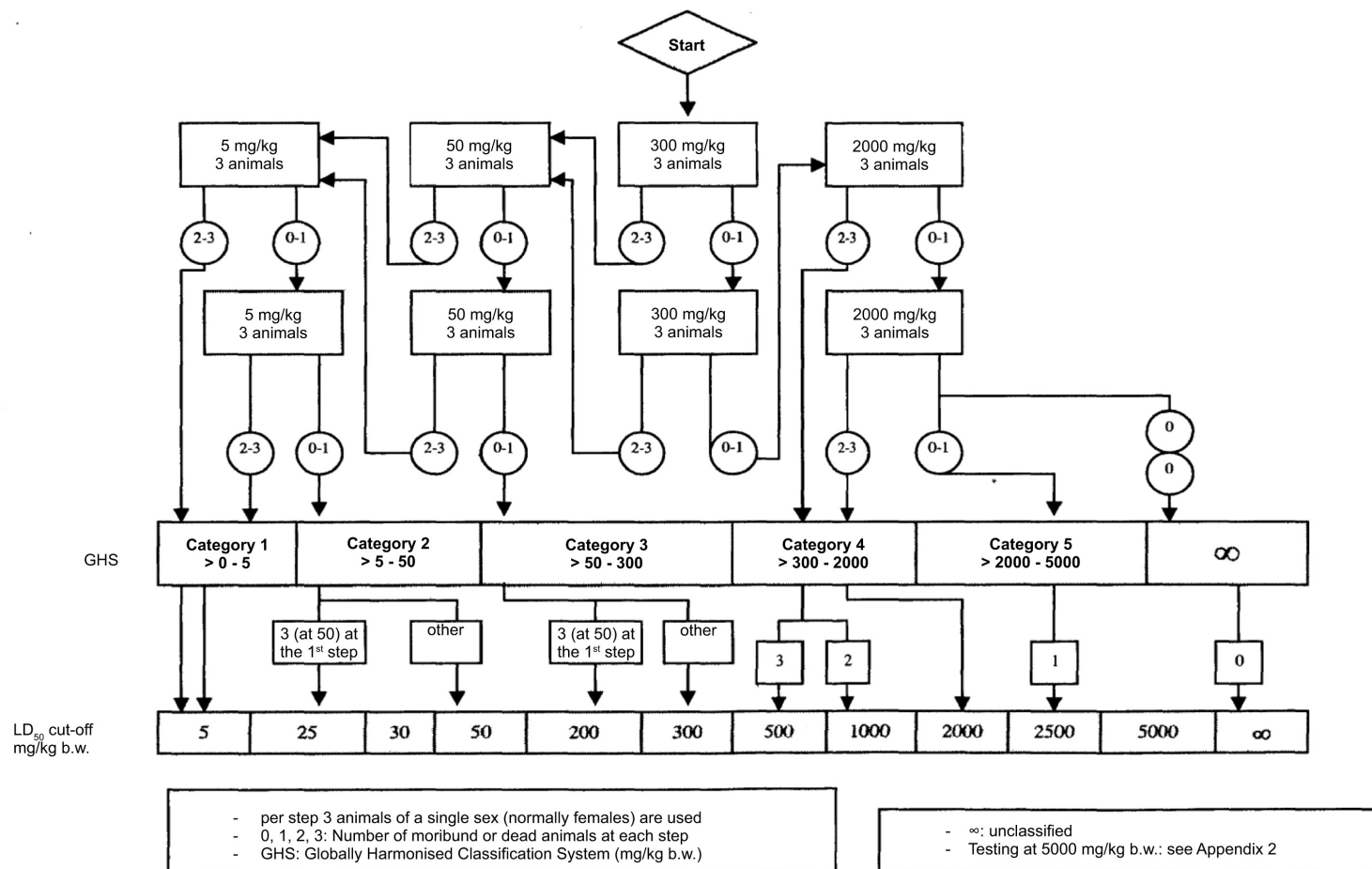

TEST PROCEDURE WITH A STARTING DOSE OF 2 000 MG/KG BODY WEIGHT

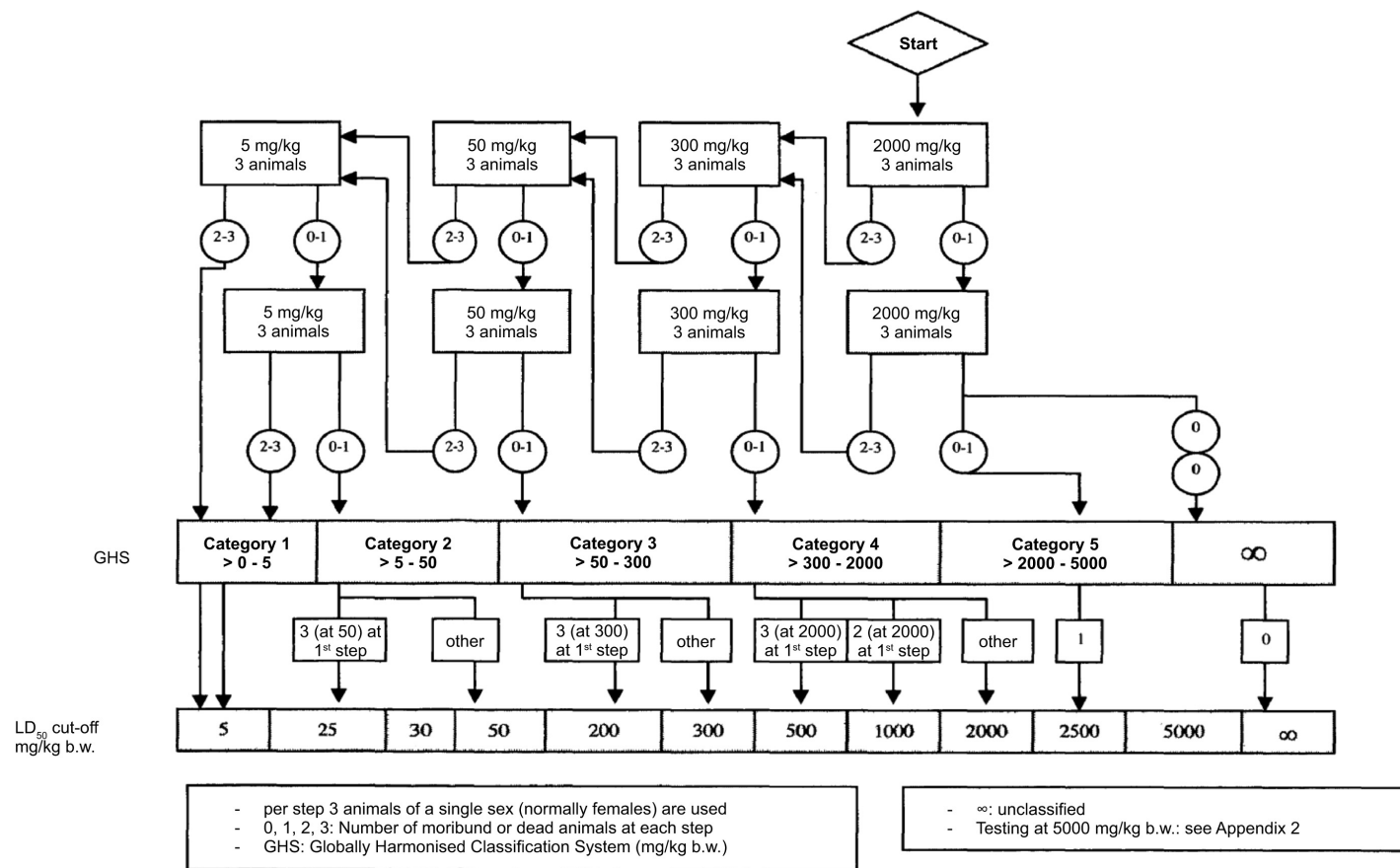

*Appendix 2***CRITERIA FOR CLASSIFICATION OF TEST SUBSTANCES WITH EXPECTED LD₅₀ VALUES EXCEEDING 2 000 MG/KG WITHOUT THE NEED FOR TESTING**

Criteria for hazard Category 5 are intended to enable the identification of test substances which are of relatively low acute toxicity hazard but which, under certain circumstances may present a danger to vulnerable populations. These substances are anticipated to have an oral or dermal LD₅₀ in the range of 2 000-5 000 mg/kg or equivalent doses for other routes. The test substance should be classified in the hazard category defined by: 2 000 mg/kg < LD₅₀ < 5 000 mg/kg (Category 5 in the GHS) in the following cases:

- (a) If directed to this category by any of the testing schemes of Appendix 1a-1d, based on mortality incidences;
- (b) if reliable evidence is already available that indicates the LD₅₀ to be in the range of Category 5 values; or other animal studies or toxic effects in humans indicate a concern for human health of an acute nature;
- (c) through extrapolation, estimation or measurement of data if assignment to a more hazardous class is not warranted; and
 - reliable information is available indicating significant toxic effects in humans, or
 - any mortality is observed when tested up to Category 4 values by the oral route, or
 - where expert judgement confirms significant clinical signs of toxicity, when tested up to Category 4 values, except for diarrhoea, piloerection or an ungroomed appearance, or
 - where expert judgement confirms reliable information indicating the potential for significant acute effects from the other animal studies.

TESTING AT DOSES ABOVE 2 000 MG/KG

Recognising the need to protect animal welfare, testing of animals in Category 5 (5 000 mg/kg) ranges is discouraged and should only be considered when there is a strong likelihood that results of such a test have a direct relevance for protecting human or animal health (10). No further testing should be conducted at higher dose levels.

When testing is required a dose of 5 000 mg/kg, only one step (i.e. three animals) is required. If the first animal dosed dies, then dosing proceeds at 2 000 mg/kg in accordance with the flowcharts in Appendix 1. If the first animal survives, two further animals are dosed. If only one of the three animals dies, the LD₅₀ value is expected to exceed 5 000 mg/kg. If both animals die, then dosing proceeds at 2 000 mg/kg.

▼B

Appendix 3

TEST METHOD B.1 tris: Guidance on classification according to EU scheme to cover the transition period until full implementation of the Globally Harmonised Classification System (GHS) (taken from reference (8))

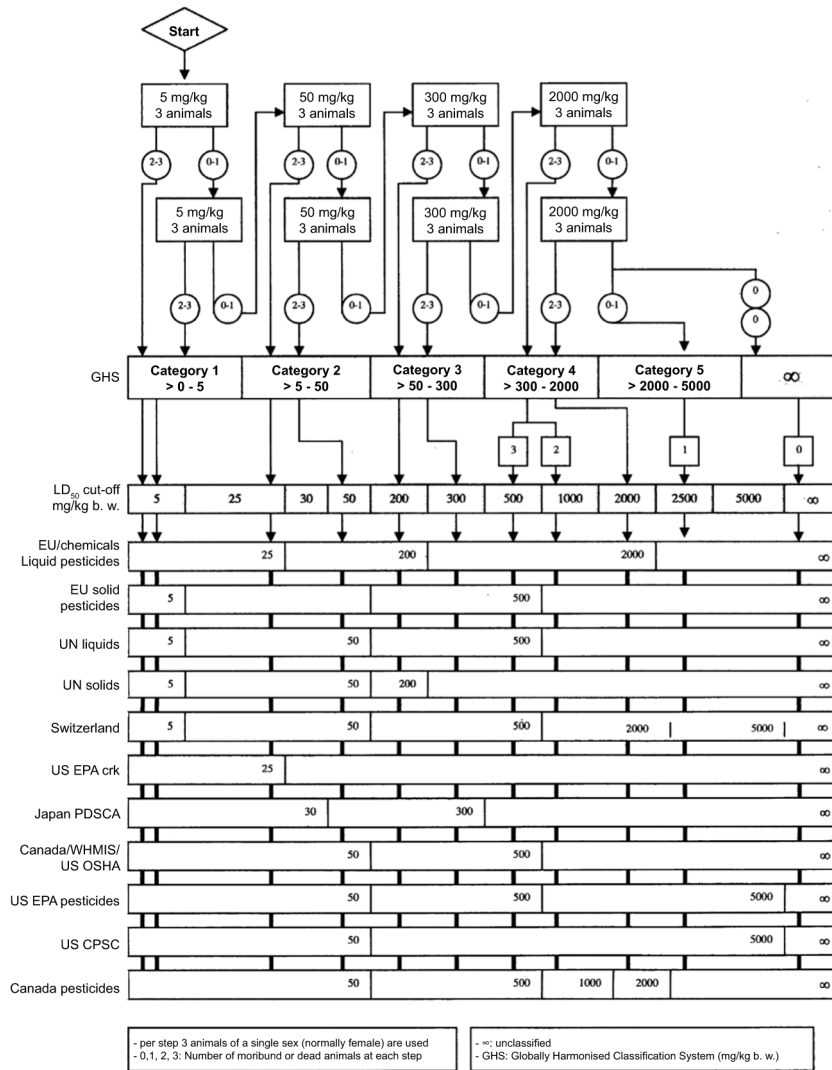

▼ B

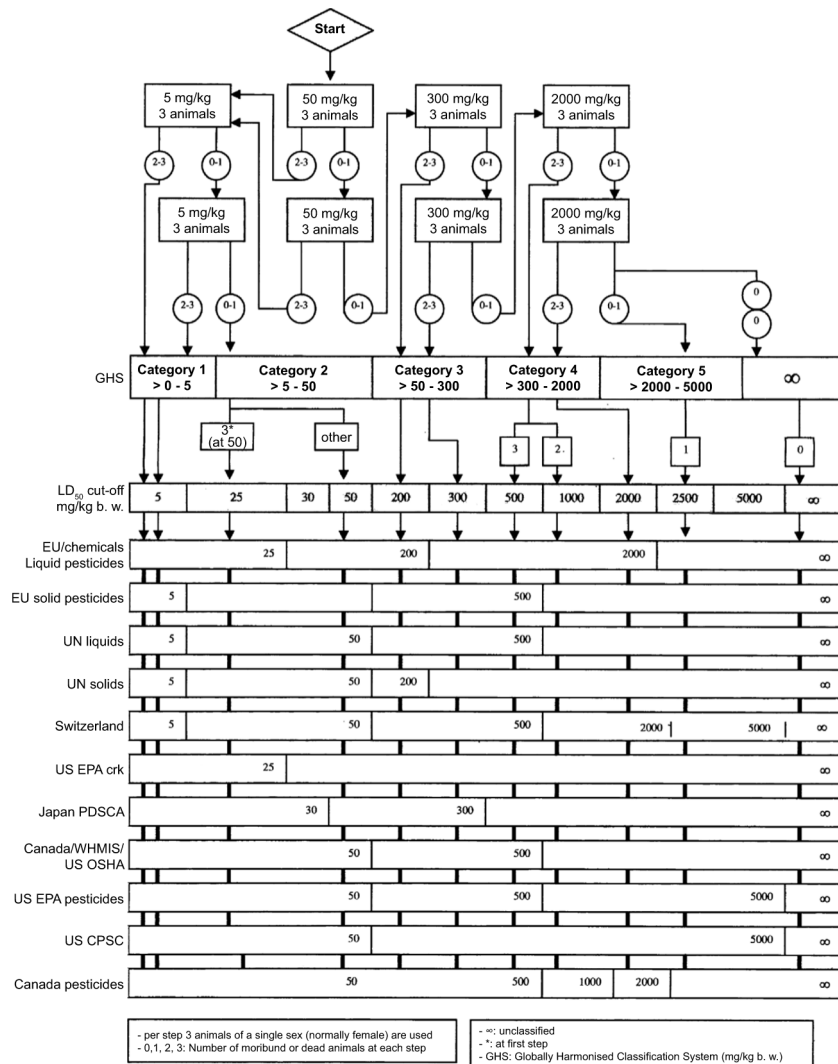

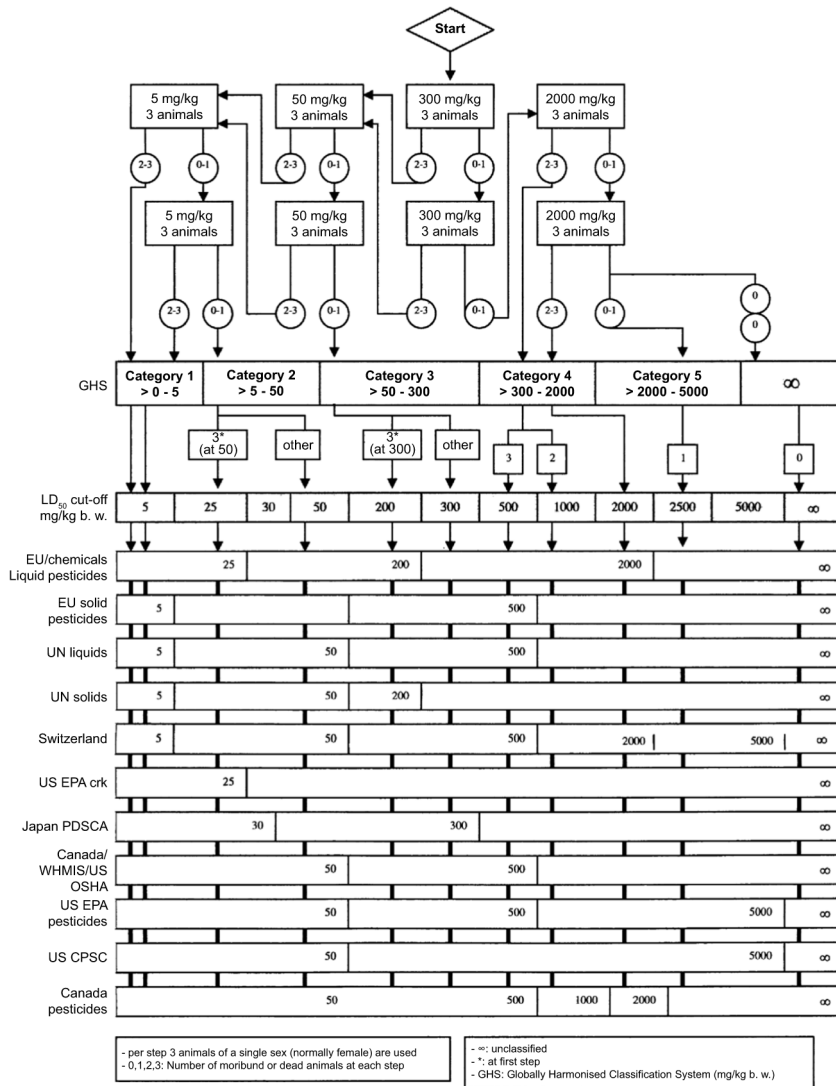

▼ B

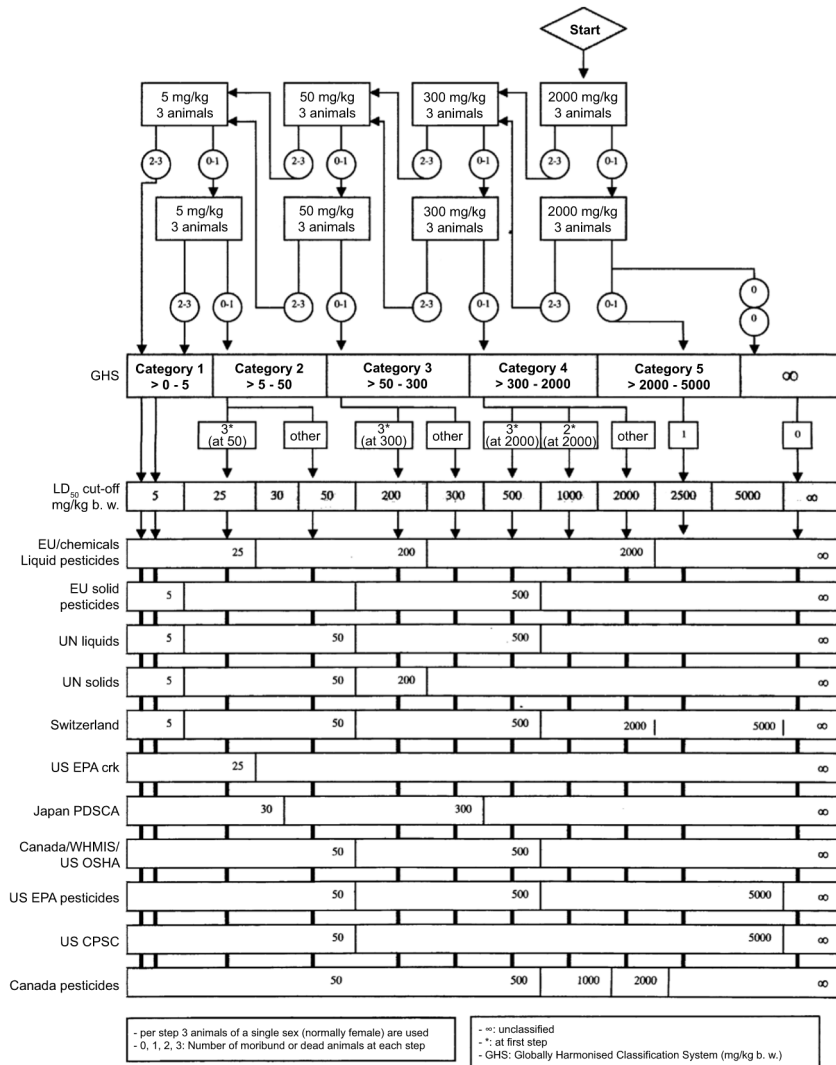

▼M4**B.2. ACUTE INHALATION TOXICITY**

INTRODUCTION

1. This Test Method is equivalent to OECD Test Guideline 403 (2009) (1). The original acute inhalation Test Guideline 403 (TG 403) was adopted in 1981. This revised Test Method B.2 (as equivalent to the revised TG 403) has been designed to be more flexible, to reduce animal usage, and to fulfil regulatory needs. The revised Test Method features two study types: a Traditional LC₅₀ protocol and a Concentration × Time (C × t) protocol. Primary features of this Test Method are the ability to provide a concentration-response relationship ranging from non-lethal to lethal outcomes in order to derive a median lethal concentration (LC₅₀), non-lethal threshold concentration (e.g. LC01), and slope, and to identify possible sex susceptibility. The C × t protocol should be used when there is a specific regulatory or scientific need that calls for the testing of animals over multiple time durations, such as for purposes of emergency response planning [e.g. deriving Acute Exposure Guideline Levels (AEGL), Emergency Response Planning Guidelines (ERPG), or Acute Exposure Threshold Levels (AETL) values], or for land-use planning.
2. Guidance on the conduct and interpretation of this Test Method studies can be found in the Guidance Document on Acute Inhalation Toxicity Testing (GD 39) (2).
3. Definitions used in the context of this Test Method are provided at the end of this chapter and in GD 39 (2).
4. This Test Method enables test chemical characterisation and quantitative risk assessment, and allows test chemicals to be ranked and classified according to Regulation (EC) No 1272/2008 (3). GD 39 (2) provides guidance in the selection of the appropriate Test Method for acute testing. When information on classification and labelling only is required, chapter B.52 of this Annex (4) is generally recommended [see GD 39 (2)]. This Test Method B.2 is not specifically intended for the testing of specialised materials, such as poorly soluble isometric or fibrous materials or manufactured nanomaterials.

INITIAL CONSIDERATIONS

5. Before considering testing in accordance with this Test Method all available information on the test chemical, including existing studies (e.g. chapter B.52 of this Annex (4)) whose data would support not doing additional testing should be considered by the testing laboratory in order to minimise animal usage. Information that may assist in the selection of the most appropriate species, strain, sex, mode of exposure and appropriate test concentrations include the identity, chemical structure, and physico-chemical properties of the test chemical; results of any *in vitro* or *in vivo* toxicity tests; anticipated uses and potential for human exposure; available (Q)SAR data and toxicological data on structurally related substances [see GD 39 (2)].

▼ M4

6. Testing corrosive and/or irritating test chemicals at concentrations that are expected to cause severe pain and/or distress should be avoided to the extent possible. The corrosive/irritating potential should be evaluated by expert judgment using such evidence as human and animal experience (e.g. from repeat dose studies performed at non-corrosive/irritant concentrations), existing *in vitro* data (e.g. from chapters B.40, (5), B.40bis (6) of this Annex or OECD TG 435 (7)), pH values, information from similar substances or any other pertinent data, for the purpose of investigating whether further testing can be waived. For specific regulatory needs (e.g. for emergency planning purposes), this Test Method may be used for exposing animals to these materials because it provides the study director or principal investigator with control over the selection of target concentrations. However, the targeted concentrations should not induce severe irritation/corrosive effects, yet sufficient to extend the concentration-response curve to levels that reach the regulatory and scientific objective of the test. These concentrations should be selected on a case-by-case basis and justification for concentration selection should be provided [see GD 39 (2)].

PRINCIPLE OF THE TEST

7. This revised Test Method B.2 has been designed to obtain sufficient information on the acute toxicity of a test chemical to enable its classification and to provide lethality data (e.g. LC₅₀, LC₀₁ and slope) for one or both sexes as needed for quantitative risk assessments. This Test Method offers two methods. The first method is a traditional protocol in which groups of animals are exposed to a limit concentration (limit test) or a series of concentrations in a stepwise procedure for a predetermined duration of usually 4 hours. Other durations of exposure may apply to serve specific regulatory purposes. The second method is a (C × t) protocol in which groups of animals are exposed to one (limit concentration) or a series of multiple concentrations over multiple durations.
8. Moribund animals or animals obviously in pain or showing signs of severe and enduring distress should be humanely killed and are considered in the interpretation of the test result in the same way as animals that died on test. Criteria for making the decision to kill moribund or severely suffering animals, and guidance on the recognition of predictable or impending death, are the subject of an OECD Guidance Document No 19 on Humane Endpoints (8).

DESCRIPTION OF THE METHOD**Selection of animal species**

9. Healthy young adult animals of commonly used laboratory strains should be used. The preferred species is the rat and justification should be provided if other species are used.

Preparation of animals

10. Females should be nulliparous and non-pregnant. On the exposure day, animals should be young adults 8 to 12 weeks of age, and body weights should be within ± 20 % of the mean weight for each sex of any previously exposed animals of the same age. The animals are randomly selected and marked for individual identification. The animals are kept in their cages for at least 5 days prior to the start of the test to allow for acclimatisation to laboratory conditions. Animals should also be acclimatised to the test apparatus for a short period prior to testing, as this will lessen the stress caused by introduction to the new environment.

▼ M4**Animal husbandry**

11. The temperature of the experimental animal maintenance room should be 22 ± 3 °C. The relative humidity should ideally be maintained in the range of 30 to 70 %, though this may not be possible when using water as a vehicle. Before and after exposures, animals generally should be caged in groups by sex and concentration, but the number of animals per cage should not interfere with clear observation of each animal and should minimise losses due to cannibalism and fighting. When animals are to be exposed nose-only, it may be necessary for them to be acclimated to the restraining tubes. The restraining tubes should not impose undue physical, thermal, or immobilisation stress on the animals. Restraint may affect physiological endpoints such as body temperature (hyperthermia) and/or respiratory minute volume. If generic data are available to show that no such changes occur to any appreciable extent, then pre-adaptation to the restraining tubes is not necessary. Animals exposed whole-body to an aerosol should be housed individually during exposure to prevent them from filtering the test aerosol through the fur of their cage mates. Conventional and certified laboratory diets may be used, except during exposure, accompanied with an unlimited supply of municipal drinking water. Lighting should be artificial, the sequence being 12 hours light/12 hours dark.

Inhalation chambers

12. The nature of the test chemical and the objective of the test should be considered when selecting an inhalation chamber. The preferred mode of exposure is nose-only (which term includes head-only, nose-only or snout-only). Nose-only exposure is generally preferred for studies of liquid or solid aerosols and for vapours that may condense to form aerosols. Special objectives of the study may be better achieved by using a whole-body mode of exposure, but this should be justified in the study report. To ensure atmosphere stability when using a whole-body chamber, the total volume of the test animals should not exceed 5 % of the chamber volume. Principles of the nose-only and whole body exposure techniques and their particular advantages and disadvantages are described in GD 39 (2).

EXPOSURE CONDITIONS**Administration of concentrations**

13. Nose-only exposures may be any duration up to 6 hours in rats. If mice are exposed nose-only, exposures generally should not exceed 4 hours. Justification should be provided if longer duration studies are needed [see GD 39 (2)]. Animals exposed to aerosols in whole-body chambers should be housed individually to prevent ingestion of test chemical due to grooming of cage mates. Feed should be withheld during the exposure period. Water may be provided throughout a whole-body exposure.

14. Animals are exposed to the test chemical as a gas, vapour, aerosol, or a mixture thereof. The physical state to be tested depends on the physico-chemical properties of the test chemical, the selected concentration, and/or the physical form most likely present during the handling and use of the test chemical. Hygroscopic and chemically reactive test chemicals should be tested under dry air conditions. Care should be taken to avoid generating explosive concentrations.

▼ M4**Particle-size distribution**

15. Particle sizing should be performed for all aerosols and for vapours that may condense to form aerosols. To allow for exposure of all relevant regions of the respiratory tract, aerosols with mass median aerodynamic diameters (MMAD) ranging from 1 to 4 µm with a geometric standard deviation (σ_g) in the range of 1,5 to 3,0 are recommended (2) (9) (10). Although a reasonable effort should be made to meet this standard, expert judgment should be provided if it cannot be achieved. For example, metal fumes may be smaller than this standard, and charged particles, fibres, and hygroscopic materials (which increase in size in the moist environment of the respiratory tract) may exceed this standard.

Test chemical preparation in a vehicle

16. A vehicle may be used to generate an appropriate concentration and particle size of the test chemical in the atmosphere. As a rule, water should be given preference. Particulate material may be subjected to mechanical processes to achieve the required particle size distribution, however, care should be taken to not decompose or alter the test chemical. In cases where mechanical processes are believed to have altered test chemical composition (e.g. extreme temperatures from excessive milling due to friction), the composition of the test chemical should be verified analytically. Adequate care should be taken to not contaminate the test chemical. It is not necessary to test non-friable granular materials which are purposefully formulated to be un-inhalable. An attrition test should be used to demonstrate that respirable particles are not produced when the granular material is handled. If an attrition test produces respirable substances, an inhalation toxicity test should be performed.

Control animals

17. A concurrent negative (air) control group is not necessary. When a vehicle other than water is used to assist in generating the test atmosphere, a vehicle control group should only be used when historical inhalation toxicity data are not available. If a toxicity study of a test chemical formulated in a vehicle reveals no toxicity, it follows that the vehicle is non-toxic at the concentration tested; thus, there is no need for a vehicle control.

MONITORING OF EXPOSURE CONDITIONS**Chamber airflow**

18. The flow of air through the chamber should be carefully controlled, continuously monitored, and recorded at least hourly during each exposure. The monitoring of test atmosphere concentration (or stability) is an integral measurement of all dynamic parameters and provides an indirect means to control all relevant dynamic atmosphere generation parameters. Special consideration should be given to avoiding re-breathing in nose-only chambers in cases where airflow through the exposure system are inadequate to provide dynamic flow of test chemical atmosphere. There are prescribed methodologies that can be used to demonstrate that re-breathing does not occur under the selected operation conditions (2) (11). Oxygen concentration should be at least 19 % and carbon dioxide concentration should not exceed 1 %. If there is reason to believe that these standards cannot be met, oxygen and carbon dioxide concentrations should be measured.

▼ M4**Chamber temperature and relative humidity**

19. Chamber temperature should be maintained at 22 ± 3 °C. Relative humidity in the animals' breathing zone, for both nose-only and whole-body exposures, should be monitored and recorded at least three times for durations of up to 4 hrs, and hourly for shorter durations. The relative humidity should ideally be maintained in the range of 30 to 70 %, but this may either be unattainable (e.g. when testing water based mixtures) or not measurable due to test chemical interference with the test method.

Test chemical: Nominal concentration

20. Whenever feasible, the nominal exposure chamber concentration should be calculated and recorded. The nominal concentration is the mass of generated test chemical divided by the total volume of air passed through the chamber system. The nominal concentration is not used to characterise the animals' exposure, but a comparison of the nominal concentration and the actual concentration gives an indication of the generation efficiency of the test system, and thus may be used to discover generation problems.

Test chemical: Actual concentration

21. The actual concentration is the test chemical concentration at the animals' breathing zone in an inhalation chamber. Actual concentrations can be obtained by specific methods (e.g. direct sampling, adsorptive or chemical reactive methods, and subsequent analytical characterisation) or by non-specific methods such as gravimetric filter analysis. The use of gravimetric analysis is acceptable only for single component powder aerosols or aerosols of low volatility liquids and should be supported by appropriate pre-study test chemical-specific characterisations. Multi-component powder aerosol concentration may also be determined by gravimetric analysis. However, this requires analytical data which demonstrate that the composition of airborne material is similar to the starting material. If this information is not available, a reanalysis of the test chemical (ideally in its airborne state) at regular intervals during the course of the study may be necessary. For aerosolised agents that may evaporate or sublime, it should be shown that all phases were collected by the method chosen. The target, nominal, and actual concentrations should be provided in the study report, but only actual concentrations are used in statistical analyses to calculate lethal concentration values.
22. One lot of the test chemical should be used, if possible, and the test sample should be stored under conditions that maintain its purity, homogeneity, and stability. Prior to the start of the study, there should be a characterisation of the test chemical, including its purity and, if technically feasible, the identity, and quantities of identified contaminants and impurities. This can be demonstrated by, but is not limited to, the following data: retention time and relative peak area, molecular weight from mass spectroscopy or gas chromatography analyses, or other estimates. Although the test sample's identity is not the responsibility of the test laboratory, it may be prudent for the test laboratory to confirm the sponsor's characterisation at least in a limited way (e.g. colour, physical nature, etc.).
23. The exposure atmosphere shall be held as constant as practicable and monitored continuously and/or intermittently depending on the method of analysis. When intermittent sampling is used, chamber atmosphere samples should be taken at least twice in a four hour study. If not feasible due to limited air flow rates or low concentrations, one sample may be collected over the entire exposure period. If marked sample-to-sample fluctuations occur, the next concentrations tested should use four samples per exposure.

▼ M4

Individual chamber concentration samples should not deviate from the mean concentration by more than $\pm 10\%$ for gases and vapours or $\pm 20\%$ for liquid or solid aerosols. Time to chamber equilibration (t_{95}) should be calculated and recorded. The duration of an exposure spans the time that the test chemical is generated and this takes into account the times required to attain t_{95} . Guidance for estimating t_{95} can be found in GD 39 (2).

24. For very complex mixtures consisting of gases/vapours, and aerosols (e.g. combustion atmospheres and test chemicals propelled from purpose-driven end-use products/devices), each phase may behave differently in an inhalation chamber so at least one indicator substance (analyte), normally the principal active substance in the mixture, of each phase (gas/vapour and aerosol) should be selected. When the test chemical is a mixture, the analytical concentration should be reported for the mixture and not just for the active substance or the component (analyte). Additional information regarding actual concentrations can be found in GD 39 (2).

Test chemical: Particle size distribution

25. The particle size distribution of aerosols should be determined at least twice during each 4 hour exposure by using a cascade impactor or an alternative instrument such as an aerodynamic particle sizer. If equivalence of the results obtained by a cascade impactor or an alternative instrument can be shown, then the alternative instrument may be used throughout the study. A second device, such as a gravimetric filter or an impinger/gas bubbler, should be used in parallel to the primary instrument to confirm the collection efficiency of the primary instrument. The mass concentration obtained by particle size analysis should be within reasonable limits of the mass concentration obtained by filter analysis [see GD 39 (2)]. If equivalence can be demonstrated in the early phase of the study, then further confirmatory measurements may be omitted. For animal welfare reasons, measures should be taken to minimise inconclusive data which may lead to a need to repeat an exposure. Particle sizing should be performed for vapours if there is any possibility that vapour condensation may result in the formation of an aerosol, or if particles are detected in a vapour atmosphere with potential for mixed phases (see paragraph 15).

PROCEDURE

26. Two study types are described below: the Traditional protocol, and the $C \times t$ protocol. Both protocols may include a sighting study, a main study, and/or a limit test (Traditional protocol) or testing at a limit concentration ($C \times t$). If one sex is known to be more susceptible, the study director may choose to perform these studies using only the susceptible sex. If rodent species other than rats are exposed nose-only, maximum exposure durations may be adjusted to minimise species-specific distress. Before commencing, all available data should be considered in order to minimise animal usage. For example, data generated using chapter B.52 of this Annex (4) may eliminate the need for a sighting study, and may also demonstrate whether one sex is more susceptible [see GD 39 (2)].

▼M4

TRADITIONAL PROTOCOL

General considerations: Traditional protocol

27. In a Traditional study, groups of animals are exposed to a test chemical for a fixed period of time (generally 4 hours) in either a nose-only or whole-body exposure chamber. Animals are exposed to either a limit concentration (limit test), or to at least three concentrations in a stepwise procedure (main study). A sighting study may precede a main study unless some information about the test chemical already exists, such as a previously performed B.52 study [see GD 39 (2)].

Sighting study: Traditional protocol

28. A sighting study is used to estimate test chemical potency, identify sex differences in susceptibility, and assist in selecting exposure concentration levels for the main study or limit test. When selecting concentration levels for the sighting study, all available information should be used including available (Q)SAR data and data for similar chemicals. No more than three males and three females should be exposed at each concentration (3 animals/sex may be needed to establish a sex difference). A sighting study may consist of a single concentration, but more concentrations may be tested if necessary. A sighting study should not test so many animals and concentrations that it resembles a main study. A previously performed B.52 study (4) may be used instead of a sighting study [see GD 39 (2)].

Limit test: Traditional protocol

29. A limit test is used when the test chemical is known or expected to be virtually non-toxic, i.e. eliciting a toxic response only above the regulatory limit concentration. In a limit test, a single group of three males and three females is exposed to the test chemical at a limit concentration. Information about the toxicity of the test chemical can be gained from knowledge about similar tested chemicals, taking into consideration the identity and percentage of components known to be of toxicological significance. In those situations where there is little or no information about its toxicity, or the test chemical is expected to be toxic, the main test should be performed.
30. The selection of limit concentrations usually depends on regulatory requirements. When Regulation (EC) No 1272/2008 is used, the limit concentrations for gases, vapours, and aerosols are 20 000 ppm, 20 mg/l and 5 mg/l, respectively (or the maximum attainable concentration) (3). It can be technically challenging to generate limit concentrations of some test chemicals, especially as vapours and aerosols. When testing aerosols, the primary goal should be to achieve a respirable particle size (MMAD of 1-4 µm). This is possible with most test chemicals at a concentration of 2 mg/l. Aerosol testing at greater than 2 mg/l should only be attempted if a respirable particle size can be achieved [see GD 39 (2)]. Regulation (EC) No 1272/2008 discourages testing in excess of a limit concentration for animal welfare reasons (3). The limit concentration should only be considered when there is a strong likelihood that results of such a test would have direct relevance for protecting human health (3), and justification provided in the study report. In the case of potentially explosive test chemicals, care should be taken to avoid conditions favourable for an explosion. To avoid an unnecessary use of animals, a test run without animals should be conducted prior to the limit test to ensure that the chamber conditions for a limit test can be achieved.

▼ M4

31. If mortality or moribundity is observed at the limit concentration, the results of the limit test can serve as a sighting study for further testing at other concentrations (see main study). If a test chemical's physical or chemical properties make it impossible to attain a limit concentration, the maximum attainable concentration should be tested. If less than 50 % lethality occurs at the maximum attainable concentration, no further testing is necessary. If the limit concentration could not be attained, the study report should provide an explanation and supportive data. If the maximum attainable concentration of a vapour does not elicit toxicity, it may be necessary to generate the test chemical as a liquid aerosol.

Main study: Traditional protocol

32. A main study is typically performed using five males and five females (or 5 animals of the susceptible sex, if known) per concentration level, with at least three concentration levels. Sufficient concentration levels should be used to obtain a robust statistical analysis. The time interval between exposure groups is determined by the onset, duration, and severity of toxic signs. Exposure of animals at the next concentration level should be delayed until there is reasonable confidence of survival for previously tested animals. This allows the study director to adjust the target concentration for the next exposure group. Due to the dependence on sophisticated technologies, this may not always be practical in inhalation studies, so the exposure of animals at the next concentration level should be based on previous experience and scientific judgement. GD 39 (2) should be consulted when testing mixtures.

CONCENTRATION × TIME (C × T) PROTOCOL**General considerations: C × t protocol**

33. A step-wise C × t study may be considered as an alternative to a Traditional protocol when assessing inhalation toxicity (12) (13) (14). This approach allows animals to be exposed to a test chemical at several concentration levels and for multiple time durations. All testing is performed in a nose-only chamber (whole-body chambers are not practical for this protocol). A flow diagram in Appendix 1 illustrates this protocol. A simulation analysis has shown that the Traditional protocol and the C × t protocol are both capable of yielding robust LC₅₀ values, but the C × t protocol is generally better at yielding robust LC₀₁ and LC₁₀ values (15).
34. A simulation analysis has demonstrated that using two animals per C × t interval (one per sex using both sexes, or two of the more susceptible sex) may generally be adequate when testing 4 concentrations and 5 exposure durations in a main study. Under some circumstances, the study director may elect to use two rats per sex per C × t interval (15). Using 2 animals per sex per concentration and time point may reduce bias and variability of the estimates, increase the estimation success rate, and improve confidence interval coverage. However, in case of an insufficient close fit to the data for estimation (when using one animal per sex or two animals of the more susceptible sex) a 5th exposure concentration may also suffice. Further guidance on the number of animals and concentrations to be used in a C × t study can be found in GD 39 (2).

▼ M4**Sighting study: C × t protocol**

35. A sighting study is used to estimate test chemical potency and to assist in selecting exposure concentration levels for the main study. A sighting study using up to three animals/sex/concentration [for details see Appendix III of GD 39 (2)] may be needed to choose an appropriate starting concentration for the main study and to minimise the number of animals used. It may be necessary to use three animals per sex to establish a sex difference. These animals should be exposed for a single duration, generally 240 min. The feasibility of generating adequate test atmospheres should be assessed during technical pre-tests without animals. It is generally not necessary to perform a sighting study if mortality data are available from a B.52 study (4). When selecting the initial target concentration in a B.2 study, the study director should consider the mortality patterns observed in any available B.52 studies (4) for both sexes and for all concentrations tested [see GD 39 (2)].

Initial Concentration: C × t protocol

36. The initial concentration (Exposure Session I) (Appendix 1) will either be a limit concentration or a concentration selected by the study director based on the sighting study. Groups of 1 animal/sex are exposed to this concentration for multiple durations (*e.g.* 15, 30, 60, 120, or 240 minutes), resulting in a total number of 10 animals (called Exposure Session I) (Appendix 1).
37. The selection of limit concentrations usually depends on regulatory requirements. When Regulation (EC) No 1272/2008 is used, the limit concentrations for gases, vapours, and aerosols are 20 000 ppm, 20 mg/l and 5 mg/l, respectively (or the maximum attainable concentration) (3). It can be technically challenging to generate limit concentrations of some test chemicals, especially as vapours and aerosols. When testing aerosols, the goal should be to achieve a respirable particle size (*i.e.* an MMAD of 1-4 µm) at a limit concentration of 2 mg/l. This is possible with most test chemicals. Aerosol testing at greater than 2 mg/l should only be attempted if a respirable particle size can be achieved [see GD 39 (2)]. Regulation (EC) No 1272/2008 discourages testing in excess of a limit concentration for animal welfare reasons (3). Testing in excess of the limit concentration should only be considered when there is a strong likelihood that results of such a test would have direct relevance for protecting human health (3), justification should be provided in the study report. In the case of potentially explosive test chemicals, care should be taken to avoid conditions favourable for an explosion. To avoid an unnecessary use of animals, a test run without animals should be conducted prior to testing at the initial concentration to ensure that the chamber conditions for this concentration can be achieved.
38. If mortality or moribundity is observed at the initial concentration, the results at this concentration can serve as a starting point for further testing at other concentrations (see main study). When a test chemical's physical or chemical properties make it impossible to attain a limit concentration, the maximum attainable concentration should be tested. If less than 50 % lethality occurs at the maximum attainable concentration, no further testing is necessary. If the limit concentration could not be attained, the study report should provide an explanation and supportive data. If the maximum attainable concentration of a vapour does not elicit toxicity, it may be necessary to generate the test chemical as a liquid aerosol.

▼ M4**Main study: C × t protocol**

39. The initial concentration (Exposure Session I) (Appendix 1) tested in the main study will either be a limit concentration or a concentration selected by the study director based on the sighting study. If mortality has been observed during or following Exposure Session I, the minimum exposure (C × t) which results in mortality will be taken as a guide to establish the concentration and periods of exposure for Exposure Session II. Each subsequent exposure session will depend on the previous session (see Appendix 1).

40. For many test chemicals the results obtained at the initial concentration, together with three additional exposure sessions with a smaller time grid (i.e. the geometric spacing of exposure periods as indicated by the factor between successive periods, generally $\sqrt{2}$), will be sufficient to establish the C × t mortality relationship (15), but there may be some benefit to using a 5th exposure concentration [see Appendix 1 and GD 39 (2)]. For mathematical treatment of results for the C × t protocol, see Appendix 1.

OBSERVATIONS

41. The animals should be clinically observed frequently during the exposure period. Following exposure, clinical observations should be made at least twice on the day of exposure, or more frequently when indicated by the response of the animals to treatment, and at least once daily thereafter for a total of 14 days. The length of the observation period is not fixed, but should be determined by the nature and time of onset of clinical signs and length of the recovery period. The times at which signs of toxicity appear and disappear are important, especially if there is a tendency for signs of toxicity to be delayed. All observations are systematically recorded with individual records being maintained for each animal. Animals found in a moribund condition and animals showing severe pain and/or enduring signs of severe distress should be humanely killed for animal welfare reasons. Care should be taken when conducting examinations for clinical signs of toxicity that initial poor appearance and transient respiratory changes, resulting from the exposure procedure, are not mistaken for test chemical-related toxicity that would require premature killing of the animals. The principles and criteria summarised in the Guidance Document on Humane Endpoints (GD 19) should be taken into consideration (7). When animals are killed for humane reasons or found dead, the time of death should be recorded as precisely as possible.

42. Cage-side observations should include changes in the skin and fur, eyes and mucous membranes, and also respiratory, circulatory, autonomic and central nervous systems, and somatomotor activity and behaviour patterns. When possible, any differentiation between local and systemic effects should be noted. Attention should be directed to observations of tremors, convulsions, salivation, diarrhoea, lethargy, sleep and coma. The measurement of rectal temperature may provide supportive evidence of reflex bradypnea or hypo/hyperthermia related to treatment or confinement.

Body weights

43. Individual animal weights should be recorded once during the acclimatization period, on the day of exposure prior to exposure (day 0), and at least on days 1, 3 and 7 (and weekly thereafter), and at the time of death or euthanasia if exceeding day 1. Body weight is recognised as a critical indicator of toxicity so animals exhibiting a sustained decrement of $\geq 20\%$, compared to pre-study values, should be closely monitored. Surviving animals are weighed and humanely killed at the end of the post-exposure period.

▼ M4**Pathology**

44. All test animals, including those which die during the test or are euthanised and removed from the study for animal welfare reasons, should be subjected to gross necropsy. If necropsy cannot be performed immediately after a dead animal is discovered, the animal should be refrigerated (not frozen) at temperatures low enough to minimise autolysis. Necropsies should be performed as soon as possible, normally within a day or two. All gross pathological changes should be recorded for each animal with particular attention to any changes in the respiratory tract.

45. Additional examinations included a priori by design may be considered to extend the interpretive value of the study, such as measuring lung weight of surviving rats, and/or providing evidence of irritation by microscopic examination of the respiratory tract. Examined organs may also include those showing evidence of gross pathology in animals surviving 24 or more hours, and organs known or expected to be affected. Microscopic examination of the entire respiratory tract may provide useful information for test chemicals that are reactive with water, such as acids and hygroscopic test chemicals.

DATA AND REPORTING

Data

46. Individual animal data on body weights and necropsy findings should be provided. Clinical observation data should be summarised in tabular form, showing for each test group the number of animals used, the number of animals displaying specific signs of toxicity, the number of animals found dead during the test or killed for humane reasons, time of death of individual animals, a description and time course of toxic effects and reversibility, and necropsy findings.

Test report

47. The test report should include the following information, as appropriate:

Test animals and husbandry

- Description of caging conditions, including: number (or change in number) of animals per cage, bedding material, ambient temperature and relative humidity, photoperiod, and identification of diet

- Species/strain used and justification for using a species other than the rat

- Number, age and sex of animals

- Method of randomisation

- Details of food and water quality (including diet type/source, water source)

- Description of any pre-test conditioning including diet, quarantine, and treatment for disease;

▼ M4*Test chemical*

- Physical nature, purity and, where relevant, physico-chemical properties (including isomerisation)
- Identification data and Chemical Abstract Services (CAS) Registry Number, if known;

Vehicle

- Justification for use of vehicle and justification for choice of vehicle (if other than water)
- Historical or concurrent data demonstrating that the vehicle does not interfere with the outcome of the study;

Inhalation chamber

- Description of the inhalation chamber including dimensions and volume
 - Source and description of equipment used for the exposure of animals as well as generation of atmosphere
 - Equipment for measuring temperature, humidity, particle-size, and actual concentration
 - Source of air and treatment of air supplied/extracted and system used for conditioning
 - Methods used for calibration of equipment to ensure a homogeneous test atmosphere
 - Pressure difference (positive or negative)
 - Exposure ports per chamber (nose-only); location of animals in the system (whole-body)
 - Temporal homogeneity/stability of test atmosphere
 - Location of temperature and humidity sensors and sampling of test atmosphere in the chamber
 - Air flow rates, air flow rate/exposure port (nose-only), or animal load/chamber (whole-body)
 - Information about the equipment used to measure oxygen and carbon dioxide, if applicable
 - Time required to reach inhalation chamber equilibrium (t_{95})
 - Number of volume changes per hour
 - Metering devices (if applicable);
- Exposure data*
- Rationale for target concentration selection in the main study
 - Nominal concentrations (total mass of test chemical generated into the inhalation chamber divided by the volume of air passed through the chamber)
 - Actual test chemical concentrations collected from the animals' breathing zone; for mixtures that produce heterogeneous physical forms (gases, vapours, aerosols), each may be analysed separately

▼ M4

- All air concentrations should be reported in units of mass (e.g. mg/l, mg/m³, etc.); units of volume (e.g. ppm, ppb, etc.) may also be reported parenthetically
- Particle size distribution, mass median aerodynamic diameter (MMAD), and geometric standard deviation (σ_g), including their methods of calculation. Individual particle size analyses should be reported;

Test conditions

- Details of test chemical preparation, including details of any procedures used to reduce the particle size of solid materials or to prepare solutions of the test chemical. In cases where mechanical processes may have altered test chemical composition, include the results of analyses to verify the composition of the test chemical
- A description (preferably including a diagram) of the equipment used to generate the test atmosphere and to expose the animals to the test atmosphere
- Details of the chemical analytical method used and method validation (including efficiency of recovery of test chemical from the sampling medium)
- The rationale for the selection of test concentrations;

Results

- Tabulation of chamber temperature, humidity, and airflow
- Tabulation of chamber nominal and actual concentration data
- Tabulation of particle size data including analytical sample collection data, particle size distribution and calculations of the MMAD and σ_g
- Tabulation of response data and concentration level for each animal (i.e. animals showing signs of toxicity including mortality, nature, severity, time of onset and duration of effects)
- Individual body weights of animals collected on study; date and time of death if prior to scheduled euthanasia, time course of onset of signs of toxicity and whether these were reversible for each animal
- Necropsy findings and histopathological findings for each animal, if available
- Lethality estimates (e.g. LC₅₀, LD₀₁) including 95 % confidence limits, and slope (if provided by the evaluation method)
- Statistical relation, including estimate for the exponent n ($C \times t$ protocol). The name of the statistical software used should be provided;

▼ M4*Discussion and interpretation of results*

- Particular emphasis should be made to the description of methods used to meet this Test Method's criteria, e.g. the limit concentration or the particle size
- The respirability of particles in light of the overall findings should be addressed, especially if the particle-size criteria could not be met
- An explanation should be provided if there was a need to humanely sacrifice animals in pain or showing signs of severe and enduring distress, based on the criteria in the OECD Guidance Document on Humane Endpoints (8)
- If testing with chapter B.52 of this Annex (4) was discontinued in favour of this Test Method B.2, justifications should be provided
- The consistency of methods used to determine nominal and actual concentrations, and the relation of actual concentration to nominal concentration should be included in the overall assessment of the study
- The likely cause of death and predominant mode of action (systemic versus local) should be addressed.

LITERATURE:

- (1) OECD (2009). Acute Inhalation Toxicity Testing. OECD Guideline for Testing of Chemicals No 403, OECD, Paris. Available at: [<http://www.oecd.org/env/testguidelines>]
- (2) OECD (2009). Guidance Document on Acute Inhalation Toxicity Testing. Environmental Health and Safety Monograph Series on Testing and Assessment No 39, OECD, Paris. Available at: [<http://www.oecd.org/env/testguidelines>]
- (3) Regulation (EC) No 1272/2008 of the European Parliament and of the Council of 16 December 2008 on classification, labelling and packaging of substances and mixtures, amending and repealing Directives 67/548/EEC and 1999/45/EC and amending Regulation (EC) No 1907/2006 (OJ L 353, 31.12.2008, p. 1).
- (4) Chapter B.52 of this Annex, Acute Inhalation Toxicity — Acute Toxic Class (ATC) Method.
- (5) Chapter B.40 of this Annex, In Vitro Skin Corrosion: Transcutaneous Electrical Resistance Test (TER).
- (6) Chapter B.40bis of this Annex, In Vitro Skin Corrosion: Human Skin Model Test.
- (7) OECD (2005), In Vitro Membrane Barrier Test Method For Skin Corrosion. OECD Guideline for Testing of Chemicals No 435, OECD, Paris. Available at: [<http://www.oecd.org/env/testguidelines>]
- (8) OECD (2000). Guidance Document on the Recognition, Assessment and Use of Clinical Signs as Humane Endpoints for Experimental Animals Used in Safety Evaluation. Environmental Health and Safety Monograph Series on Testing and Assessment No 19, OECD, Paris. Available at: [<http://www.oecd.org/env/testguidelines>]
- (9) SOT (1992). Technical Committee of the Inhalation Specialty Section, Society of Toxicology (SOT). Recommendations for the Conduct of Acute Inhalation Limit Tests. Fund. Appl. Toxicol. 18: 321-327.
- (10) Phalen RF (2009). Inhalation Studies: Foundations and Techniques. (2nd Edition) Informa Healthcare, New York.

▼M4

- (11) Pauluhn J and Thiel A (2007). A Simple Approach to Validation of Directed-Flow Nose-Only Inhalation Chambers. *J. Appl. Toxicol.* 27: 160-167.
- (12) Zwart JHE, Arts JM, ten Berge WF, Appelman LM (1992). Alternative Acute Inhalation Toxicity Testing by Determination of the Concentration-Time-Mortality Relationship: Experimental Comparison with Standard LC50 Testing. *Reg. Toxicol. Pharmacol.* 15: 278-290.
- (13) Zwart JHE, Arts JM, Klokman-Houweling ED, Schoen ED (1990). Determination of Concentration-Time-Mortality Relationships to Replace LC50 Values. *Inhal. Toxicol.* 2: 105-117.
- (14) Ten Berge WF and Zwart A (1989). More Efficient Use of Animals in Acute Inhalation Toxicity Testing. *J. Haz. Mat.* 21: 65-71.
- (15) OECD (2009). Performance Assessment: Comparison of 403 and $C \times t$ Protocols via Simulation and for Selected Real Data Sets. Environmental Health and Safety Monograph Series on Testing and Assessment No 104, OECD, Paris. Available at: [<http://www.oecd.org/env/testguidelines>]
- (16) Finney DJ (1977). *Probit Analysis*, 3rd ed. Cambridge University Press, London/New York.

DEFINITION

Test chemical: Any substance or mixture tested using this Test Method.

▼ M4*Appendix 1***C × t Protocol**

1. A step-wise Concentration × Time (C × t) study may be considered as an alternative to the Traditional protocol for assessing inhalation toxicity (12) (13) (14). It should be performed preferentially when there is a specific regulatory or scientific need that calls for the testing of animals over multiple time durations such as for emergency response planning or land use planning. This approach usually begins with testing at a limit concentration (Exposure Session I) in which animals are exposed to a test chemical for five time durations (e.g. 15, 30, 60, 120 and 240 min) so that multiple durations of time will be obtained within one exposure session (see Figure 1). When Regulation (EC) No 1272/2008 is used, the limit concentrations for gases, vapours, and aerosols are 20 000 ppm, 20 mg/l, and 5 mg/l, respectively. These levels may only be exceeded if there is a regulatory or scientific need for testing at these levels (see paragraph 37 in the B.2 main text).
2. In situations where there is little or no information about the toxicity of a test chemical, a sighting study should be performed in which groups of no more than 3 animals per sex are exposed to target concentrations selected by the study director, generally for 240 min.
3. If a limit concentration is tested during Exposure Session I and less than 50 % mortality is observed, no additional testing is needed. If there is a regulatory or scientific need to establish the concentration/time/response relationship at higher levels than the indicated limit concentration, the next exposure should be carried out at a higher level such as at two times the limit concentration (i.e. 2L in Figure 1).
4. If toxicity is observed at the limit concentration, additional testing (main study) is necessary. These additional exposures are carried out either at lower concentrations (in Figure 1: Exposure Sessions II, III or IV') or at higher concentrations using shorter durations (in Figure 1: Exposure Session IV) using durations that are adapted and not as widely spaced.
5. The test (initial concentration and additional concentrations) is carried out using 1 animal/sex per concentration/time point or with 2 animals of the more susceptible sex per concentration/time point. Under some circumstances, the study director may elect to utilise 2 rats per sex per concentration/time point (or 4 animals of the susceptible sex per concentration/time point) (15). Using 2 animals per sex per concentration/time point generally reduces bias and variability of the estimates, increases the estimation success rate, and improves confidence interval coverage relative to the protocol as described here. Further details are provided in GD 39 (2).
6. Ideally, each exposure session is carried out on one day. This gives the opportunity to delay the next exposure until there is reasonable confidence of survival, and it allows the study director to adjust the target concentration and durations for the next exposure session. It is advised to start each exposure session with the group that will be exposed the longest, e.g. the 240-min exposure group, followed by the 120 minute exposure group, and so on. If, for example, animals in the 240 minute group are dying after 90 minutes or showing severe signs of toxicity (e.g. extreme changes in breathing pattern such as laboured breathing), it would not make sense to expose a group for 120 minutes because mortality would likely be 100 %. Thus the study director should select shorter exposure durations for that concentration (e.g. 90, 65, 45, 33 and 25 minutes).

▼ **M4**

7. The chamber concentration should be measured frequently to determine the time-weighted-average concentration for each exposure duration. Whenever possible, the time of death for each animal (rather than the exposure duration) should be used in the statistical analysis.
8. The results of the first four exposure sessions should be examined to identify a data gap in the concentration-time curve (see Figure 1). In case of an insufficient fit, an additional exposure (5th concentration) may be performed. Concentration and exposure durations for the 5th exposure should be chosen to cover this gap.
9. All exposure sessions (including the first Exposure Session) will be used to calculate the concentration-time-response relationship using Statistical Analysis (16). If possible, for each $C \times t$ interval, the time-weighted average concentration and the duration of exposure until death (if death occurs during the exposure) should be used.

Figure 1

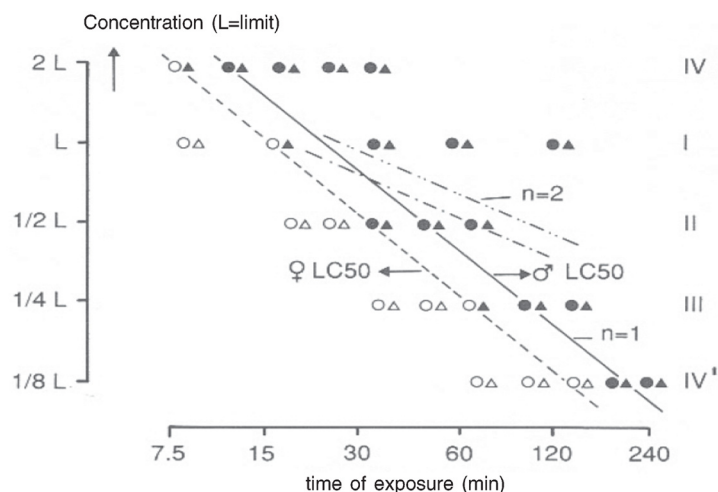
Hypothetical illustration of a concentration-time-mortality relationship in rats

Open symbols = survivors; closed symbols = dead animals

Triangles = females; circles = males

Solid line = LC_{50} values (range 7,5-240 min) for males with $n = 1$

Dashed line = LC_{50} values (range 7,5-240 min) for females with $n = 1$

Dotted lines = hypothetical LC_{50} values line for males and females if n had been equal to 2 (12).

Glossary

Concentration:

Time of exposure:

▼ **M4**

10. Below is an example of the stepwise procedure:

Exposure Session I — Testing at the limit concentration (see Figure 1)

- 1 animal/sex per concentration/time point; 10 animals in total ^(a)
- Target concentration ^(b) = limit concentration.
- Expose five groups of animals at this target concentration for durations of 15, 30, 60, 120 and 240 minutes, respectively.

↓

Exposure Session II ^(c) — Main Study

- 1 animal/sex per concentration/time point; 10 animals in total.
- Expose five groups of animals at a lower concentration ^(d) (1/2L) with slightly longer exposure durations (factor $\sqrt{2}$ spaced; see Figure 1).

↓

Exposure Session III — Main Study

- 1 animal/sex per concentration/time point; 10 animals total.
- Expose five groups of animals at a lower concentration ^(d) (1/4L) with slightly longer exposure durations (factor $\sqrt{2}$ spaced; see Figure 1).

↓

Exposure Session IV^e — Main Study

- 1 animal/sex per concentration/time point; 10 animals total.
- Expose five groups of animals at a lower concentration ^(d) (1/8L) with slightly longer exposure durations (factor $\sqrt{2}$ spaced; see Figure 1).

↓ or

^(a) If no sex susceptibility information is available, rats of both sexes will be used, *i.e.* 1 animal/sex per concentration. Based on existing information, or if it becomes apparent during this exposure session that one sex is more susceptible, 10 animals of the susceptible sex will be used (2 animals per concentration/time point) at each concentration level during subsequent testing.

^(b) When Regulation (EC) No 1272/2008 is used, the limit concentrations for gases, vapours, and aerosols are 20 000 ppm, 20 mg/l, and 5 mg/l, respectively. In case of expected toxicity or based on the results of the sighting study, lower starting concentrations should be chosen. In case of regulatory or scientific needs, higher concentrations may be used.

^(c) Ideally, exposure of animals at the next concentration level should be delayed until there is reasonable confidence of survival for previously treated animals. This allows the study director to adjust the target concentration and durations for the next exposure session.

^(d) The minimum dose (concentration x time) which resulted in mortality during testing at initial concentration (first exposure session) will be taken as a guide to establish the next combination of concentration and exposure durations. Typically, the concentration will be decreased two-fold (1/2L) and animals will be exposed over a new time range with a finer grid using a geometric division of exposure periods with a factor 1,4 ($\sqrt{2}$; see reference 11) around the time according to the minimum lethal dose level (time x concentration) observed during the first exposure. In this figure (Figure 1), mortality in Exposure session I was first observed at 15 min; the durations during session II are therefore centred around 30 min, and are 15, 21 30, 42 and 60 min. After the first two exposures, it is strongly advised to plot the data in a similar figure as indicated above, and to check whether the relationship between concentration and time has an angle of 45 degrees ($n = 1$) or if the concentration-time-response relationship is less steep (e.g. $n = 2$) or steeper (e.g. $n = 0,8$). In the latter cases it is strongly advised to adapt the next concentrations and durations accordingly.

▼ M4**Exposure Session IV — Main Study**

- 1 animal/sex per concentration/time point; 10 animals total.
- Expose five groups of animals at a higher concentration^(e) (2L) with slightly shorter exposure durations (factor $\sqrt{2}$ spaced; see Figure 1).

Mathematical treatment of results for the C × t protocol

11. A C × t procedure with 4 or 5 exposure concentrations and five durations will yield 20 or 25 data points, respectively. With these data points, the C × t relationship can be calculated using statistical analysis (16):

Equation 1:

$$\text{Probit}(P) = b_0 + b_1 \ln C + b_2 \ln t$$

where C = concentration; t = exposure duration, or

Equation 2:

$$\text{Response} = f(C^n t)$$

where $n = b_1/b_2$.

Using equation 1, the LC₅₀ value can be calculated for a given time period (e.g. 4 hour, 1 hour, 30 minutes, or any time period within the range of time periods tested) using P = 5 (50 % response). Note that Haber's rule is only applicable when n = 1. The LC₀₁ can be calculated using P = 2,67.

^(e) In certain cases it may be necessary to increase the concentration (2L) over a new time range with a still finer grid using a geometric division of exposure periods with a factor 1,4 ($\sqrt{2}$) around the time according to the minimum lethal concentration level observed during the first exposure. The minimum exposure duration should preferably exceed 5 minutes; the maximum exposure duration should not exceed 8 hours.

▼B**B.3. ACUTE TOXICITY (DERMAL)****1. METHOD****1.1. INTRODUCTION**

See General introduction Part B (A).

1.2. DEFINITION

See General introduction Part B (B).

1.3. REFERENCE SUBSTANCES

None.

1.4. PRINCIPLE OF THE TEST METHOD

The test substance is applied to the skin in graduated doses to several groups of experimental animals, one dose being used per group. Subsequently, observations of effects and deaths are made. Animals, which die during the test are necropsied and at the conclusion of the test surviving animals are necropsied.

Animals showing severe and enduring signs of distress and pain may need to be humanely killed. Dosing test substances in a way known to cause marked pain and distress due to corrosive or irritating properties need not be carried out.

1.5. QUALITY CRITERIA

None.

1.6. DESCRIPTION OF THE TEST METHOD**1.6.1. Preparations**

The animals are kept in their experimental cages under the experimental housing and feeding conditions for at least five days prior to the experiment. Before the test, healthy young adult animals are randomised and assigned to the treatment groups. Approximately 24 hours before the test, fur should be removed by clipping or shaving from the dorsal area of the trunk of the animals. When clipping or shaving the fur, care must be taken to avoid abrading the skin which could alter its permeability. Not less than 10 % of the body surface should be clear for the application of the test substance. When testing solids, which may be pulverised if appropriate, the test substance should be moistened sufficiently with water or, where necessary, a suitable vehicle to ensure good contact with the skin. When a vehicle is used, the influence of the vehicle on penetration of skin by the test substance should be taken into account. Liquid test substances are generally used undiluted.

1.6.2. Test conditions**1.6.2.1. Experimental animals**

The adult rat or rabbit may be used. Other species may be used but their use would require justification. Commonly used laboratory strains should be employed. For each sex, at the start of the test the range of weight variation in the animals used should not exceed $\pm 20\%$ of the appropriate mean value.

▼ B1.6.2.2. *Number and sex*

At least five animals are used at each dose level. They should all be of the same sex. If females are used, they should be nulliparous and non-pregnant. Where information is available demonstrating that a sex is markedly more sensitive, animals of this sex should be dosed.

Note: in acute toxicity tests with animals of a higher order than rodents, the use of smaller numbers should be considered. Doses should be carefully selected, and every effort should be made not to exceed moderately toxic doses. In such tests, administration of lethal doses of the test substance should be avoided.

1.6.2.3. *Dose levels*

These should be sufficient in number, at least three, and spaced appropriately to produce test groups with a range of toxic effects and mortality rates. Any irritant or corrosive effects should be taken into account when deciding on dose levels. The data should be sufficient to produce a dose/response curve and, where possible, permit an acceptable determination of the LD₅₀.

1.6.2.4. *Limit test*

A limit test at one dose level of at least 2 000 mg/kg bodyweight may be carried out in a group of five male and five female animals, using the procedures described above. If compound-related mortality is produced, a full study may need to be considered.

1.6.2.5. *Observation period*

The observation period should be at least 14 days. However, the duration of observation should not be rigidly fixed. It should be determined by the toxic reactions, their rate of onset and the length of the recovery period; it may thus be extended when considered necessary. The time at which signs of toxicity appear and disappear, their duration and the time of death are important, especially if there is a tendency for deaths to be delayed.

1.6.3. **Procedure**

Animals should be caged individually. The test substance should be applied uniformly over an area, which is approximately 10 % of the total body surface area. With highly toxic substances the surface area covered may be less but as much of the area should be covered with a layer as thin and uniform as possible.

Test substances should be held in contact with the skin with a porous gauze dressing and non-irritating tape throughout a 24-hour exposure period. The test site should be further covered in a suitable manner to retain the gauze dressing and test substance and ensure that the animals cannot ingest the test substance. Restraints may be used to prevent the ingestion of the test substance but complete immobilisation is not a recommended method.

▼B

At the end of the exposure period, residual test substance should be removed, where practicable, using water or some other appropriate method of cleansing the skin.

Observations should be recorded systematically as they are made. Individual records should be maintained for each animal. Observations should be made frequently during the first day. A careful clinical examination should be made at least once each working day, other observations should be made daily with appropriate actions taken to minimise loss of animals to the study, e.g. necropsy or refrigeration of those animals found dead and isolation or sacrifice of weak or moribund animals.

Observations should include changes in fur, treated skin, eyes and mucous membranes, and also respiratory, circulatory, autonomic and central nervous systems, and somatomotor activity and behaviour pattern. Particular attention should be directed to observations of tremors, convulsions, salivation, diarrhoea, lethargy, sleep and coma. The time of death must be recorded as precisely as possible. Animals that die during the test and those surviving at the termination of the test are subjected to necropsy. All gross pathological changes should be recorded. Where indicated, tissues should be taken for histopathological examination.

Assessment of toxicity in the other sex

After completion of the study in one sex, at least one group of five animals of the other sex is dosed to establish that animals of this sex are not markedly more sensitive to the test substance. The use of fewer animals may be justified in individual circumstances. Where adequate information is available to demonstrate that animals of the sex tested are markedly more sensitive, testing in animals of the other sex may be dispensed with.

2. DATA

Data should be summarised in tabular form, showing for each test group the number of animals at the start of the test, time of death of individual animals, number of animals displaying other signs of toxicity, description of toxic effects and necropsy findings. Individual weights of animals should be determined and recorded shortly before the test substance is applied, weekly thereafter, and at death; changes in weight should be calculated and recorded when survival exceeds one day. Animals, which are humanely killed due to compound-related distress and pain are recorded as compound-related deaths. The LD₅₀ should be determined by a recognised method.

Data evaluation should include an evaluation of relationships, if any, between the animal's exposure to the test substance and the incidence and severity of all abnormalities, including behavioural and clinical abnormalities, gross lesions, body weight changes, mortality, and any other toxicological effects.

3. REPORTING

3.1. TEST REPORT

The test report shall, if possible, include the following information:

▼B

- species, strain, source, environmental conditions, diet, etc.,
- test conditions (including method of skin cleansing and type of dressing: occlusive or not occlusive),
- dose levels (with vehicle, if used, and concentrations),
- sex of animals dosed,
- tabulation of response data by sex and dose level (i.e. number of animals that died or were killed during the test, number of animals showing signs of toxicity, number of animals exposed),
- time of death after dosing, reasons and criteria used for humane killing of animals,
- all observations,
- LD₅₀ value for the sex subjected to a full study, determined at 14 days with the method of determination specified,
- 95 % confidence interval for the LD₅₀ (where this can be provided),
- dose/mortality curve and slope where permitted by the method of determination,
- necropsy findings,
- any histopathological findings,
- results of any test on the other sex,
- discussion of results (particular attention should be given to the effect that humane killing of animals during the test may have on the calculated LD₅₀ value),
- interpretation of the results.

3.2. EVALUATION AND INTERPRETATION

See General introduction Part B (D).

4. REFERENCES

See General introduction Part B (E).

▼M8**B.4. ACUTE DERMAL IRRITATION/CORROSION**

INTRODUCTION

1. This test method is equivalent to OECD test guideline (TG) 404 (2015). OECD guidelines for testing of Chemicals are periodically reviewed to ensure that they reflect the best available science. In the review of OECD TG 404, special attention was given to possible improvements in relation to animal welfare concerns and to the evaluation of all existing information on the test chemical in order to avoid unnecessary testing in laboratory animals. The updated version of OECD TG 404 (originally adopted in 1981, revised in 1992, 2002 and 2015) includes reference to the Guidance Document on Integrated Approaches to Testing and Assessment (IATA) for Skin Irritation/Corrosion (1), proposing a modular approach for skin irritation and skin corrosion testing. The IATA describes several modules which group information sources and analysis tools, and (i) provides guidance on how to integrate and use existing testing and non-testing data for the assessment of the skin irritation and skin corrosion potentials of chemicals and (ii) proposes an approach when further testing is needed (1). In addition, where needed, the successive, instead of simultaneous, application of the three test patches to the animal in the initial *in vivo* test is recommended in that Guideline.
2. Definitions of dermal irritation and corrosion are set out in the Appendix to this test method.

INITIAL CONSIDERATIONS

3. In the interest of both sound science and animal welfare, *in vivo* testing should not be undertaken until all available data relevant to the potential dermal corrosivity/irritation of the test chemical have been evaluated in a weight-of-the-evidence (WoE) analysis as presented in the Guidance Document on Integrated Approaches to Testing and Assessment for Skin Corrosion and Irritation, i.e. over the three Parts of this guidance and their corresponding modules (1). Briefly, under Part 1 existing data is addressed over seven modules covering human data, *in vivo* data, *in vitro* data, physico-chemical properties data (e.g. pH, in particular strong acidity or alkalinity) and non-testing methods. Under Part 2, WoE analysis is performed. If this WoE is still inconclusive, Part 3 should be conducted with additional testing, starting with *in vitro* methods, and *in vivo* testing is used as last resort. This analysis should therefore decrease the need for *in vivo* testing for dermal corrosivity/irritation of test chemicals for which sufficient evidence already exists from other studies as to those two endpoints.

PRINCIPLE OF THE IN VIVO TEST

4. The test chemical to be tested is applied in a single dose to the skin of an experimental animal; untreated skin areas of the test animal serve as the control. The degree of irritation/corrosion is read and scored at specified intervals and is further described in order to provide a complete evaluation of the effects. The duration of the study should be sufficient to evaluate the reversibility or irreversibility of the effects observed.

▼M8

5. Animals showing continuing signs of severe distress and/or pain at any stage of the test should be humanely killed, and the test chemical assessed accordingly. Criteria for making the decision to humanely kill moribund and severely suffering animals are the subject of a separate Guidance Document (2).

PREPARATIONS FOR THE IN VIVO TEST

Selection of animal species

6. The albino rabbit is the preferable laboratory animal, and healthy young adult rabbits are used. A rationale for using other species should be provided.

Preparation of the animals

7. Approximately 24 hours before the test, fur should be removed by closely clipping the dorsal area of the trunk of the animals. Care should be taken to avoid abrading the skin, and only animals with healthy, intact skin should be used.
8. Some strains of rabbit have dense patches of hair that are more prominent at certain times of the year. Such areas of dense hair growth should not be used as test sites.

Housing and feeding conditions

9. Animals should be individually housed. The temperature of the experimental animal room should be 20 °C (\pm 3 °C) for rabbits. Although the relative humidity should be at least 30 % and preferably not exceed 70 %, other than during room cleaning, the aim should be 50-60 %. Lighting should be artificial, the sequence being 12 hours light, 12 hours dark. For feeding, conventional laboratory diets may be used with an unrestricted supply of drinking water

TEST PROCEDURE

Application of the test chemical

10. The test chemical should be applied to a small area (approximately 6 cm²) of skin and covered with a gauze patch, which is held in place with non-irritating tape. In cases in which direct application is not possible (e.g. liquids or some pastes), the test chemical should first be applied to the gauze patch, which is then applied to the skin. The patch should be loosely held in contact with the skin by means of a suitable semi-occlusive dressing for the duration of the exposure period. If the test chemical is applied to the patch, it should be attached to the skin in such a manner that there is good contact and uniform distribution of the test chemical on the skin. Access by the animal to the patch and ingestion or inhalation of the test chemical should be prevented.
11. Liquid test chemicals are generally used undiluted. When testing solids (which may be pulverised, if considered necessary), the test chemical should be moistened with the smallest amount of water (or, where necessary, of another suitable vehicle) sufficient to ensure good skin contact. When vehicles other than water are used, the potential influence of the vehicle on irritation of the skin by the test chemical should be minimal, if any.
12. At the end of the exposure period, which is normally 4 hours, residual test chemical should be removed, where practicable, using water or an appropriate solvent without altering the existing response or the integrity of the epidermis.

▼M8**Dose level**

13. A dose of 0,5 ml of liquid or 0,5 g of solid or paste is applied to the test site.

Initial test (In vivo dermal irritation/corrosion test using one animal)

14. When a test chemical has been judged to be corrosive, irritant or non-classified on the basis of a weight of evidence analyses or of previous *in vitro* testing, further *in vivo* testing is normally not necessary. However, in the cases where additional data are felt warranted, the *in vivo* test is performed initially using one animal and applying the following approach. Up to three test patches are applied sequentially to the animal. The first patch is removed after three minutes. If no serious skin reaction is observed, a second patch is applied at a different site and removed after one hour. If the observations at this stage indicate that exposure can humanely be allowed to extend to four hours, a third patch is applied and removed after four hours, and the response is graded.
15. If a corrosive effect is observed after any of the three sequential exposures, the test is immediately terminated. If a corrosive effect is not observed after the last patch is removed, the animal is observed for 14 days, unless corrosion develops at an earlier time point.
16. In those cases in which the test chemical is not expected to produce corrosion but may be irritating, a single patch should be applied to one animal for four hours.

Confirmatory test (In vivo dermal irritation test with additional animals)

17. If a corrosive effect is not observed in the initial test, the irritant or negative response should be confirmed using up to two additional animals, each with one patch, for an exposure period of four hours. If an irritant effect is observed in the initial test, the confirmatory test may be conducted in a sequential manner, or by exposing two additional animals simultaneously. In the exceptional case, in which the initial test is not conducted, two or three animals may be treated with a single patch, which is removed after four hours. When two animals are used, if both exhibit the same response, no further testing is needed. Otherwise, the third animal is also tested. Equivocal responses may need to be evaluated using additional animals.

Observation period

18. The duration of the observation period should be sufficient to evaluate fully the reversibility of the effects observed. However, the experiment should be terminated at any time that the animal shows continuing signs of severe pain or distress. To determine the reversibility of effects, the animals should be observed up to 14 days after removal of the patches. If reversibility is seen before 14 days, the experiment should be terminated at that time.

Clinical observations and grading of skin reactions

19. All animals should be examined for signs of erythema and oedema, and the responses scored at 60 minutes, and then at 24, 48 and 72 hours after patch removal. For the initial test in one animal, the test site is also examined immediately after the patch has been removed. Dermal reactions are graded and recorded according to the grades in the Table below. If there is damage to skin which cannot be identified as irritation or corrosion at 72 hours, observations may be needed until day 14 to determine the reversibility of the effects. In addition to the observation of irritation, all local toxic effects, such as defatting of the skin, and any systemic adverse effects (e.g. effects on

▼M8

clinical signs of toxicity and body weight), should be fully described and recorded. Histopathological examination should be considered to clarify equivocal responses.

20. The grading of skin responses is necessarily subjective. To promote harmonisation in grading of skin response and to assist testing laboratories and those involved in making and interpreting the observations, the personnel performing the observations need to be adequately trained in the scoring system used (see Table below). An illustrated guide for grading skin irritation and other lesions could be helpful (3).

DATA AND REPORTING

21. Study results should be summarised in tabular form in the final test report and should cover all items listed in paragraph 24.

Evaluation of results

22. The dermal irritation scores should be evaluated in conjunction with the nature and severity of lesions, and their reversibility or lack of reversibility. The individual scores do not represent an absolute standard for the irritant properties of a material, as other effects of the test material are also evaluated. Instead, individual scores should be viewed as reference values, which need to be evaluated in combination with all other observations from the study.
23. Reversibility of dermal lesions should be considered in evaluating irritant responses. When responses such as alopecia (limited area), hyperkeratosis, hyperplasia and scaling, persist to the end of the 14-day observation period, the test chemical should be considered an irritant.

Test report

24. The test report must include the following information:

Rationale for in vivo testing:

- Weight-of-evidence analysis of pre-existing test data, including results from sequential testing strategy;
- Description of relevant data available from prior testing;
- Data derived at each stage of testing strategy;
- Description of *in vitro* tests performed, including details of procedures, results obtained with test/reference substances;
- Weight-of-the-evidence analysis for performing *in vivo* study.

Test chemical:

- Mono-constituent substance: chemical identification, such as IUPAC or CAS name, CAS number, SMILES or InChI code, structural formula, purity, chemical identity of impurities as appropriate and practically feasible, etc;

▼M8

- Multi-constituent substance, mixture and substances of unknown or variable composition, complex reaction products or biological materials (UVCB): characterised as far as possible by chemical identity (see above), quantitative occurrence and relevant physico-chemical properties of the constituents;
- Physical appearance, water solubility, and additional relevant physico-chemical properties;
- Source, lot number if available;
- Treatment of the test chemical/control substance prior to testing, if applicable (e.g. warming, grinding);
- Stability of the test chemical, limit date for use, or date for re-analysis if known;
- Storage conditions.

Vehicle:

- Identification, concentration (where appropriate), volume used;
- Justification for choice of vehicle.

Test animal(s):

- Species/strain used, rationale for using animal(s) other than albino rabbit;
- Number of animal(s) of each sex;
- Individual animal weight(s) at start and conclusion of test;
- Age at start of study;
- Source of animal(s), housing conditions, diet, etc.

Test conditions:

- Technique of patch site preparation;
- Details of patch materials used and patching technique;
- Details of test chemical preparation, application, and removal.

Results:

- Tabulation of irritation/corrosion response scores for each animal at all time points measured;
- Descriptions of all lesions observed;
- Narrative description of nature and degree of irritation or corrosion observed, and any histopathological findings;
- Description of other adverse local (e.g. defatting of skin) and systemic effects in addition to dermal irritation or corrosion.

▼ M8

Discussion of results

Conclusions

LITERATURE

- (1) OECD (2014). Guidance document on Integrated Approaches to Testing and Assessment for Skin Irritation/Corrosion. Environmental Health and Safety Publications, Series on Testing and Assessment, (No 203), Organisation for Economic Cooperation and Development, Paris.
- (2) OECD (1998) Harmonized Integrated Hazard Classification System for Human Health and Environmental Effects of Chemical Substances, as endorsed by the 28th Joint Meeting of the Chemicals Committee and the Working Party on Chemicals, November 1998.
- (3) OECD (2000). Guidance Document on the Recognition, Assessment and Use of Clinical Signs as Humane Endpoints for Experimental Animals Used in Safety Evaluation. Environmental Health and Safety Publications, Series on Testing and Assessment (No 19), Organisation for Economic Cooperation and Development, Paris.

▼M8*Table***Grading of Skin Reactions****Erythema and Eschar Formation**

No erythema...	0
Very slight erythema (barely perceptible)...	1
Well defined erythema...	2
Moderate to severe erythema...	3
Severe erythema (beef redness) to eschar formation preventing grading of erythema...	4

Maximum possible: 4

Oedema Formation

No oedema...	0
Very slight oedema (barely perceptible)...	1
Slight oedema (edges of area well defined by definite raising)...	2
Moderate oedema (raised approximately 1 mm)...	3
Severe oedema (raised more than 1 mm and extending beyond area of exposure)...	4

Maximum possible: 4

Histopathological examination may be carried out to clarify equivocal responses.

▼ M8*Appendix*

DEFINITIONS

Chemical is a substance or a mixture.

Dermal irritation is the production of reversible damage of the skin following the application of a test chemical for up to 4 hours.

Dermal corrosion is the production of irreversible damage of the skin; namely, visible necrosis through the epidermis and into the dermis, following the application of a test chemical for up to four hours. Corrosive reactions are typified by ulcers, bleeding, bloody scabs, and, by the end of observation at 14 days, by discolouration due to blanching of the skin, complete areas of alopecia, and scars. Histopathology should be considered to evaluate questionable lesions.

Test chemical is any substance or mixture tested using this test method.

▼ M7

B.5. ACUTE EYE IRRITATION/CORROSION

INTRODUCTION

This test method is equivalent to OECD test guideline (TG) 405 (2012). OECD test guidelines for Testing of Chemicals are periodically reviewed to ensure that they reflect the best available science. In previous reviews of this test guideline, special attention was given to possible improvements through the evaluation of all existing information on the test chemical in order to avoid unnecessary testing in laboratory animals and thereby address animal welfare concerns. TG 405 (adopted in 1981 and updated in 1987, 2002, and 2012) includes the recommendation that prior to undertaking the described *in vivo* test for acute eye irritation/corrosion, a weight-of-the-evidence analysis should be performed (1) on the existing relevant data. Where insufficient data are available, it is recommended that they should be developed through application of sequential testing (2) (3). The testing strategy includes the performance of validated and accepted *in vitro* tests and is provided as a supplement to this test method. For the purpose of Regulation (EC) No 1907/2006 concerning the registration, evaluation, authorization and restriction of chemicals (REACH) (1), an integrated testing strategy is also included in the relevant ECHA Guidance (21). Testing in animals should only be conducted if determined to be necessary after consideration of available alternative methods, and use of those determined to be appropriate. At the time of drafting of this updated test method, there are instances where using this test method is still necessary or required under some regulatory frameworks.

The latest update mainly focused on the use of analgesics and anesthetics without impacting the basic concept and structure of the test guideline. ICCVAM (2) and an independent international scientific peer review panel reviewed the usefulness and limitations of routinely using topical anesthetics, systemic analgesics, and humane endpoints during *in vivo* ocular irritation safety testing (12). The review concluded that the use of topical anesthetics and systemic analgesics could avoid most or all pain and distress without affecting the outcome of the test, and recommended that these substances should always be used. This test method takes this review into account. Topical anesthetics, systemic analgesics, and humane endpoints should be routinely used during acute eye irritation and corrosion *in vivo* testing. Exceptions to their use should be justified. The refinements described in this method will substantially reduce or avoid animal pain and distress in most testing situations where *in vivo* ocular safety testing is still necessary.

Balanced preemptive pain management should include (i) routine pretreatment with a topical anesthetic (e.g. proparacaine or tetracaine) and a systemic analgesic (e.g. buprenorphine), (ii) routine post-treatment schedule of systemic analgesia (e.g. buprenorphine and meloxicam), (iii) scheduled observation, monitoring, and recording of animals for clinical signs of pain and/or distress, and (iv) scheduled observation, monitoring, and recording of the nature, severity, and progression of all eye injuries. Further detail is provided in the updated procedures described below. Following test chemical administration, no additional topical anesthetics or analgesics should be applied in order to avoid interference with the study.

(1) Regulation (EC) No 1907/2006 of the European Parliament and of the Council of 18 December 2006 concerning the Registration, Evaluation, Authorisation and Restriction of Chemicals (REACH), establishing a European Chemicals Agency, amending Directive 1999/45/EC and repealing Council Regulation (EEC) No 793/93 and Commission Regulation (EC) No 1488/94 as well as Council Directive 76/769/EEC and Commission Directives 91/155/EEC, 93/67/EEC, 93/105/EC and 2000/21/EC (OJ L 304, 22.11.2007, p. 1).

(2) The US Interagency Coordinating Committee on the Validation of Alternative Methods.

▼ M7

Analgesics with anti-inflammatory activity (e.g. meloxicam) should not be applied topically, and doses used systemically should not interfere with ocular effects.

Definitions are set out in the Appendix to the test method.

INITIAL CONSIDERATIONS

In the interest of both sound science and animal welfare, *in vivo* testing should not be considered until all available data relevant to the potential eye corrosivity/irritation of the chemical have been evaluated in a weight-of-the-evidence analysis. Such data include evidence from existing studies in humans and/or laboratory animals, evidence of eye corrosivity/irritation of one or more structurally related substances or mixtures of such substances, data demonstrating high acidity or alkalinity of the chemical (4) (5), and results from validated and accepted *in vitro* or *ex vivo* tests for skin corrosion and eye corrosion/irritation (6) (13) (14) (15) (16) (17). The studies may have been conducted prior to, or as a result of, a weight-of-the-evidence analysis.

For certain chemical, such an analysis may indicate the need for *in vivo* studies of the ocular corrosion/irritation potential of the chemical. In all such cases, before considering the use of the *in vivo* eye test, preferably a study of the *in vitro* and/or *in vivo* skin corrosion effects of the chemical should be conducted first and evaluated in accordance with the sequential testing strategy in test method B.4 (7) or the integrated testing strategy described in ECHA Guidance (21).

A sequential testing strategy, which includes the performance of validated *in vitro* or *ex vivo* eye corrosion/irritation tests, is included as a Supplement to this test method, and, for the purpose of REACH, in ECHA Guidance (21). It is recommended that such a testing strategy be followed prior to undertaking *in vivo* testing. For new chemicals, a stepwise testing approach is recommended for developing scientifically sound data on the corrosivity/irritation of the chemical. For existing chemicals with insufficient data on skin and eye corrosion/irritation, the strategy can be used to fill missing data gaps. The use of a different testing strategy or procedure or the decision not to use a stepwise testing approach, should be justified.

PRINCIPLE OF THE *IN VIVO* TEST

Following pretreatment with a systemic analgesic and induction of appropriate topical anesthesia, the chemical to be tested is applied in a single dose to one of the eyes of the experimental animal; the untreated eye serves as the control. The degree of eye irritation/corrosion is evaluated by scoring lesions of conjunctiva, cornea, and iris, at specific intervals. Other effects in the eye and adverse systemic effects are also described to provide a complete evaluation of the effects. The duration of the study should be sufficient to evaluate the reversibility or irreversibility of the effects.

Animals showing signs of severe distress and/or pain at any stage of the test or lesions consistent with the humane endpoints described in this test method (see Paragraph 26) should be humanely killed, and the chemical assessed accordingly. Criteria for making the decision to humanely kill moribund and severely suffering animals are the subject of an OECD Guidance document (8).

▼ M7**PREPARATIONS FOR THE *IN VIVO* TEST****Selection of species**

The albino rabbit is the preferable laboratory animal and healthy young adult animals are used. A rationale for using other strains or species should be provided.

Preparation of animals

Both eyes of each experimental animal provisionally selected for testing should be examined within 24 hours before testing starts. Animals showing eye irritation, ocular defects, or pre-existing corneal injury should not be used.

Housing and feeding conditions

Animals should be individually housed. The temperature of the experimental animal room should be 20 °C (\pm 3 °C) for rabbits. Although the relative humidity should be at least 30 % and preferably not exceed 70 %, other than during room cleaning, the aim should be 50-60 %. Lighting should be artificial, the sequence being 12 hours light, 12 hours dark. Excessive light intensity should be avoided. For feeding, conventional laboratory diets may be used with an unrestricted supply of drinking water.

TEST PROCEDURE**Use of topical anesthetics and systemic analgesics**

The following procedures are recommended to avoid or minimize pain and distress in ocular safety testing procedures. Alternate procedures that have been determined to provide as good or better avoidance or relief of pain and distress may be substituted.

- Sixty minutes prior to test chemical application (TCA), buprenorphine 0,01 mg/kg is administered by subcutaneous injection (SC) to provide a therapeutic level of systemic analgesia. Buprenorphine and other similar opioid analgesics administered systemically are not known or expected to alter ocular responses (12).

- Five minutes prior to TCA, one or two drops of a topical ocular anesthetic (e.g. 0,5 % proparacaine hydrochloride or 0,5 % tetracaine hydrochloride) are applied to each eye. In order to avoid possible interference with the study, a topical anesthetic that does not contain preservatives is recommended. The eye of each animal that is not treated with a test chemical, but which is treated with topical anesthetics, serves as a control. If the test chemical is anticipated to cause significant pain and distress, it should not normally be tested *in vivo*. However, in case of doubt or where testing is necessary, consideration should be given to additional applications of the topical anesthetic at 5-minute intervals prior to TCA. Users should be aware that multiple applications of topical anesthetics could potentially cause a slight increase in the severity and/or time required for chemically-induced lesions to clear.

- Eight hours after TCA, buprenorphine 0,01 mg/kg SC and meloxicam 0,5 mg/kg SC are administered to provide a continued therapeutic level of systemic analgesia. While there are no data to suggest that meloxicam has anti-inflammatory effects on the eye when administered SC once daily, meloxicam should not be administered until at least 8 hours after TCA in order to avoid any possible interference with the study (12).

- After the initial 8-hour post-TCA treatment, buprenorphine 0,01 mg/kg SC should be administered every 12 hours, in conjunction with meloxicam 0,5 mg/kg SC every 24 hours, until the ocular lesions resolve and no clinical

▼M7

signs of pain and distress are present. Sustained-release preparations of analgesics are available that could be considered to decrease the frequency of analgesic dosing.

- ‘Rescue’ analgesia should be given immediately after TCA if pre-emptive analgesia and topical anesthesia are inadequate. If an animal shows signs of pain and distress during the study, a ‘rescue’ dose of buprenorphine 0,03 mg/kg SC would be given immediately and repeated as often as every 8 hours, if necessary, instead of 0,01 mg/kg SC every 12 hours. Meloxicam 0,5 mg/kg SC would be administered every 24 hours in conjunction with the ‘rescue’ dose of buprenorphine, but not until at least 8 hours post-TCA.

Application of the test chemical

The test chemical should be placed in the conjunctival sac of one eye of each animal after gently pulling the lower lid away from the eyeball. The lids are then gently held together for about one second in order to prevent loss of the material. The other eye, which remains untreated, serves as a control.

Irrigation

The eyes of the test animals should not be washed for at least 24 hours following instillation of the test chemical, except for solids (see paragraph 18), and in case of immediate corrosive or irritating effects. At 24 hours a washout may be used if considered appropriate.

Use of a satellite group of animals to investigate the influence of washing is not recommended unless it is scientifically justified. If a satellite group is needed, two rabbits should be used. Conditions of washing should be carefully documented, e.g. time of washing; composition and temperature of wash solution; duration, volume, and velocity of application.

Dose level*(1) Testing of liquids*

For testing liquids, a dose of 0,1 ml is used. Pump sprays should not be used for instilling the chemical directly into the eye. The liquid spray should be expelled and collected in a container prior to instilling 0,1 mL into the eye.

(2) Testing of solids

When testing solids, pastes, and particulate chemicals, the amount used should have a volume of 0,1 ml or a weight of not more than 100 mg. The test chemical should be ground to a fine dust. The volume of solid material should be measured after gently compacting it, e.g. by tapping the measuring container. If the solid test chemical has not been removed from the eye of the test animal by physiological mechanisms at the first observation time point of 1 hour after treatment, the eye may be rinsed with saline or distilled water.

(3) Testing of aerosols

It is recommended that all pump sprays and aerosols be collected prior to instillation into the eye. The one exception is for chemicals in pressurised aerosol containers, which cannot be collected due to vaporisation. In such cases, the eye should be held open, and the test chemical administered to the eye in a simple burst of about one second, from a distance of 10 cm directly in front of the eye. This distance may vary depending on the pressure of the spray and its contents. Care should be taken not to damage the eye from the pressure of the spray. In appropriate cases, there may be a need to evaluate the potential for ‘mechanical’ damage to the eye from the force of the spray.

▼M7

An estimate of the dose from an aerosol can be made by simulating the test as follows: the chemical is sprayed on to weighing paper through an opening the size of a rabbit eye placed directly before the paper. The weight increase of the paper is used to approximate the amount sprayed into the eye. For volatile chemicals, the dose may be estimated by weighing a receiving container before and after removal of the test chemical.

Initial test (*in vivo* eye irritation/corrosion test using one animal)

It is strongly recommended that the *in vivo* test be performed initially using one animal (see Supplement to this test method: A Sequential Testing Strategy for Eye Irritation and Corrosion). Observations should allow for determination of severity and reversibility before proceeding to a confirmatory test in a second animal.

If the results of this test indicate the chemical to be corrosive or a severe irritant to the eye using the procedure described, further testing for ocular irritancy should not be performed.

Confirmatory test (*in vivo* eye irritation test with additional animals)

If a corrosive or severe irritant effect is not observed in the initial test, the irritant or negative response should be confirmed using up to two additional animals. If an irritant effect is observed in the initial test, it is recommended that the confirmatory test be conducted in a sequential manner in one animal at a time, rather than exposing the two additional animals simultaneously. If the second animal reveals corrosive or severe irritant effects, the test is not continued. If results from the second animal are sufficient to allow for a hazard classification determination, then no further testing should be conducted.

Observation period

The duration of the observation period should be sufficient to evaluate fully the magnitude and reversibility of the effects observed. However, the experiment should be terminated at any time that the animal shows signs of severe pain or distress (8). To determine reversibility of effects, the animals should be observed normally for 21 days post administration of the test chemical. If reversibility is seen before 21 days, the experiment should be terminated at that time.

Clinical observations and grading of eye reactions

The eyes should be comprehensively evaluated for the presence or absence of ocular lesions one hour post-TCA, followed by at least daily evaluations. Animals should be evaluated several times daily for the first 3 days to ensure that termination decisions are made in a timely manner. Test animals should be routinely evaluated for the entire duration of the study for clinical signs of pain and/or distress (e.g. repeated pawing or rubbing of the eye, excessive blinking, excessive tearing) (9) (10) (11) at least twice daily, with a minimum of 6 hours between observations, or more often if necessary. This is necessary to (i) adequately assess animals for evidence of pain and distress in order to make informed decisions on the need to increase the dosage of analgesics and (ii) assess animals for evidence of established humane endpoints in order to make informed decisions on whether it is appropriate to humanely euthanize animals, and to ensure that such decisions are made in a timely manner. Fluorescein staining should be routinely used and a slit lamp biomicroscope used when considered appropriate (e.g. assessing depth of injury when corneal ulceration

▼ M7

is present) as an aid in the detection and measurement of ocular damage, and to evaluate if established endpoint criteria for humane euthanasia have been met. Digital photographs of observed lesions may be collected for reference and to provide a permanent record of the extent of ocular damage. Animals should be kept on test no longer than necessary once definitive information has been obtained. Animals showing severe pain or distress should be humanely killed without delay, and the chemical assessed accordingly.

Animals with the following eye lesions post-instillation should be humanely killed (refer to Table 1 for a description of lesion grades): corneal perforation or significant corneal ulceration including staphyloma; blood in the anterior chamber of the eye; grade 4 corneal opacity; absence of a light reflex (iridial response grade 2) which persists for 72 hours; ulceration of the conjunctival membrane; necrosis of the conjunctivae or nictitating membrane; or sloughing. This is because such lesions generally are not reversible. Furthermore, it is recommended that the following ocular lesions be used as humane endpoints to terminate studies before the end of the scheduled 21-day observation period. These lesions are considered predictive of severe irritant or corrosive injuries and injuries that are not expected to fully reverse by the end of the 21-day observation period: severe depth of injury (e.g. corneal ulceration extending beyond the superficial layers of the stroma), limbus destruction > 50 % (as evidenced by blanching of the conjunctival tissue), and severe eye infection (purulent discharge). A combination of: vascularisation of the cornea surface (i.e., pannus); area of fluorescein staining not diminishing over time based on daily assessment; and/or lack of re-epithelialisation 5 days after test chemical application could also be considered as potentially useful criteria to influence the clinical decision on early study termination. However, these findings individually are insufficient to justify early study termination. Once severe ocular effects have been identified, an attending or qualified laboratory animal veterinarian or personnel trained to identify the clinical lesions should be consulted for a clinical examination to determine if the combination of these effects warrants early study termination. The grades of ocular reaction (conjunctivae, cornea and iris) should be obtained and recorded at 1, 24, 48, and 72 hours following test chemical application (Table 1). Animals that do not develop ocular lesions may be terminated not earlier than 3 days post instillation. Animals with ocular lesions that are not severe should be observed until the lesions clear, or for 21 days, at which time the study is terminated. Observations should be performed and recorded at a minimum of 1 hour, 24 hours, 48 hours, 72 hours, 7 days, 14 days, and 21 days in order to determine the status of the lesions, and their reversibility or irreversibility. More frequent observations should be performed if necessary in order to determine whether the test animal should be euthanized out of humane considerations or removed from the study due to negative results

The grades of ocular lesions (Table 1) should be recorded at each examination. Any other lesions in the eye (e.g. pannus, staining, anterior chamber changes) or adverse systemic effects should also be reported.

Examination of reactions can be facilitated by use of a binocular loupe, hand slit-lamp, biomicroscope, or other suitable device. After recording the observations at 24 hours, the eyes may be further examined with the aid of fluorescein.

The grading of ocular responses is necessarily subjective. To promote harmonisation of grading of ocular response and to assist testing laboratories and those involved in making and interpreting the observations, the personnel performing the observations need to be adequately trained in the scoring system used.

▼ M7**DATA AND REPORTING****Evaluation of results**

The ocular irritation scores should be evaluated in conjunction with the nature and severity of lesions, and their reversibility or lack of reversibility. The individual scores do not represent an absolute standard for the irritant properties of a chemical, as other effects of the test chemical are also evaluated. Instead, individual scores should be viewed as reference values and are only meaningful when supported by a full description and evaluation of all observations.

Test report

The test report should include the following information:

Rationale for in vivo testing: weight-of-the-evidence analysis of pre-existing test data, including results from sequential testing strategy:

- description of relevant data available from prior testing;
- data derived in each step of testing strategy;
- description of in vitro tests performed, including details of procedures, results obtained with test/reference chemicals;
- description of in vivo dermal irritation / corrosion study performed, including results obtained;
- weight-of-the-evidence analysis for performing in vivo study.

Test chemical:

- identification data (e.g. chemical name and if available CAS number, purity, known impurities, source, lot number);
- physical nature and physicochemical properties (e.g. pH, volatility, solubility, stability, reactivity with water);
- in case of a mixture, components should be identified including identification data of the constituent substances (e.g. chemical names and if available CAS numbers) and their concentrations;
- dose applied.

Vehicle:

- identification, concentration (where appropriate), volume used;
- justification for choice of vehicle.

Test animals:

- species/strain used, rationale for using animals other than albino rabbit;
- age of each animal at start of study;
- number of animals of each sex in test and control groups (if required);
- individual animal weights at start and conclusion of test;
- source, housing conditions, diet, etc.

▼ M7*Anaesthetics and analgesics*

- doses and times when topical anaesthetics and systemic analgesics were administered;
- if local anaesthetic is used, identification, purity, type, and potential interaction with test chemical.

Results:

- description of method used to score irritation at each observation time (e.g. hand slitlamp, biomicroscope, fluorescein);
- tabulation of irritant/corrosive response data for each animal at each observation time up to removal of each animal from the test;
- narrative description of the degree and nature of irritation or corrosion observed;
- description of any other lesions observed in the eye (e.g. vascularisation, pannus formation, adhesions, staining);
- description of non-ocular local and systemic adverse effects, record of clinical signs of pain and distress, digital photographs, and histopathological findings, if any.

*Discussion of results***Interpretation of the results**

Extrapolation of the results of eye irritation studies in laboratory animals to humans is valid only to a limited degree. In many cases the albino rabbit is more sensitive than humans to ocular irritants or corrosives.

Care should be taken in the interpretation of data to exclude irritation resulting from secondary infection.

LITERATURE:

- (1) Barratt, M.D., *et al.* (1995), The Integrated Use of Alternative Approaches for Predicting Toxic Hazard, ECVAM Workshop Report 8, ATLA 23, 410 - 429.
- (2) de Silva, O., *et al.* (1997), Evaluation of Eye Irritation Potential: Statistical Analysis and Tier Testing Strategies, Food Chem. Toxicol 35, 159 - 164.
- (3) Worth A.P. and Fentem J.H. (1999), A general approach for evaluating stepwise testing strategies ATLA 27, 161-177.
- (4) Young, J.R., *et al.* (1988), Classification as Corrosive or Irritant to Skin of Preparations Containing Acidic or Alkaline Substance Without Testing on Animals, Toxicol. *In Vitro*, 2, 19 - 26.
- (5) Neun, D.J. (1993), Effects of Alkalinity on the Eye Irritation Potential of Solutions Prepared at a Single pH, J. Toxicol. Cut. Ocular Toxicol. 12, 227 - 231.
- (6) Fentem, J.H., *et al.* (1998), The ECVAM international validation study on *in vitro* tests for skin corrosivity. 2. Results and evaluation by the Management Team, Toxicology *in vitro* 12, pp.483 - 524.
- (7) Chapter B.4 of this Annex, *Acute Dermal Irritation/Corrosion*.

▼ M7

- (8) OECD (2000), Guidance Document on the Recognition, Assessment and Use of Clinical Signs as Humane Endpoints for Experimental Animals Used in Safety Evaluation. OECD Environmental Health and Safety Publications, Series on Testing and Assessment No. 19. (<http://www.oecd.org/ehs/test/monos.htm>).
- (9) Wright EM, Marcella KL, Woodson JF. (1985), Animal pain: evaluation and control, Lab Animal, May/June, 20-36.
- (10) National Research Council (NRC) (2008), Recognition and Alleviation of Distress in Laboratory Animals, Washington, DC: The National Academies Press.
- (11) National Research Council (NRC) (2009), Recognition and Alleviation of Pain in Laboratory Animals, Washington, DC: The National Academies Press.
- (12) ICCVAM (2010), ICCVAM Test Method Evaluation Report: Recommendations for Routine Use of Topical Anesthetics, Systemic Analgesics, and Humane Endpoints to Avoid or Minimize Pain and Distress in Ocular Safety Testing, NIH Publication No. 10-7514, Research Triangle Park, NC, USA: National Institute of Environmental Health Sciences.

<http://iccvam.niehs.nih.gov/methods/ocutox/OcuAnest-TMER.htm>
- (13) Chapter B.40 of this Annex, *In Vitro Skin Corrosion: Transcutaneous Electrical Resistance Test (TER)*.
- (14) Chapter B.40bis of this Annex, *In Vitro Skin Corrosion: Human Skin Model Test*.
- (15) OECD (2006), *Test No. 435: In vitro Membrane Barrier Test Method for Skin corrosion*, OECD Guidelines for the Testing of Chemicals, Section 4, OECD Paris.
- (16) Chapter B.47 of this Annex, *Bovine Corneal Opacity and Permeability Test Method for Identifying i) Chemicals Inducing Serious Eye Damage and ii) Chemicals Not Requiring Classification for Eye Irritation or Serious Eye Damage*.
- (17) Chapter B.48 of this Annex, *Isolated Chicken Eye Test Method for Identifying i) Chemicals Inducing Serious Eye Damage and ii) Chemicals Not Requiring Classification for Eye Irritation or Serious Eye Damage*.
- (18) U.S. EPA (2003), Label Review Manual: 3rd Edition, EPA737-B-96-001, Washington, DC: U.S., Environmental Protection Agency.
- (19) UN (2011), Globally Harmonized System of Classification and Labelling of Chemicals (GHS), Fourth revised edition, New York & Geneva: United Nations Publications.
- (20) EC (2008), Regulation (EC) No 1272/2008 of the European Parliament and of the Council of 16 December 2008 on Classification, Labelling and Packaging of Substances and Mixtures, amending and repealing Directives 67/548/EEC and 1999/45/EC, and amending Regulation (EC) No. 1907/2006 (OJ L 353, 31.12.2008, p. 1).
- (21) ECHA Guidance on information requirements and chemical safety assessment, Chapter R.7a: Endpoint specific guidance.

http://echa.europa.eu/documents/10162/13632/information_requirements_r7a_en.pdf

▼ **M7***Table 1***Grading of ocular lesions**

Cornea	Grade
Opacity: degree of density (readings should be taken from most dense area) (*)	
No ulceration or opacity	0
Scattered or diffuse areas of opacity (other than slight dulling of normal lustre); details of iris clearly visible	1
Easily discernible translucent area; details of iris slightly obscured	2
Necrotic area; no details of iris visible; size of pupil barely discernible	3
Opaque cornea; iris not discernible through the opacity	4
Maximum possible: 4	
Iris	
Normal	0
Markedly deepened rugae, congestion, swelling, moderate circumcorneal hyperaemia; or injection; iris reactive to light (a sluggish reaction is considered to be an effect)	1
Hemorrhage, gross destruction, or no reaction to light	2
Maximum possible: 2	
Conjunctivae	
Redness (refers to palpebral and bulbar conjunctivae; excluding cornea and iris)	
Normal	0
Some blood vessels hyperaemic (injected)	1
Diffuse, crimson colour; individual vessels not easily discernible	2
Diffuse beefy red	3
Maximum possible: 3	
Chemosis	
Swelling (refers to lids and/or nictating membranes)	
Normal	0
Some swelling above normal	1
Obvious swelling, with partial eversion of lids	2
Swelling, with lids about half closed	3
Swelling, with lids more than half closed	4
Maximum possible: 4	

(*) The area of corneal opacity should be noted.

▼ M7*Appendix*

DEFINITIONS:

Acid/alkali reserve: For acidic preparations, this is the amount (g) of sodium hydroxide/100 g of preparation required to produce a specified pH. For alkaline preparations, it is the amount (g) of sodium hydroxide equivalent to the g sulphuric acid/100 g of preparation required to produce a specified pH (Young *et al.* 1988).

Chemical: A substance or a mixture.

Non irritants: Substances that are not classified as EPA Category I, II, or III ocular irritants; or GHS eye irritants Category 1, 2, 2A, or 2B; or EU Category 1 or 2 (17) (18) (19).

Ocular corrosive: (a) A chemical that causes irreversible tissue damage to the eye; (b) Chemicals that are classified as GHS eye irritants Category 1, or EPA Category I ocular irritants, or EU Category 1 (17) (18) (19).

Ocular irritant: (a) A chemical that produces a reversible change in the eye; (b) Chemicals that are classified as EPA Category II or III ocular irritants; or GHS eye irritants Category 2, 2A or 2B; or EU Category 2 (17) (18) (19).

Ocular severe irritant: (a) A chemical that causes tissue damage in the eye that does not resolve within 21 days of application or causes serious physical decay of vision; (b) Chemicals that are classified as GHS eye irritant Category 1, or EPA Category I ocular irritants, or EU Category 1 (17) (18) (19).

Test chemical: Any substance or mixture tested using this test method.

Tiered approach: A stepwise testing strategy where all existing information on a test chemical is reviewed, in a specified order, using a weight-of-evidence process at each tier to determine if sufficient information is available for a hazard classification decision, prior to progression to the next tier. If the irritancy potential of a test chemical can be assigned based on the existing information, no additional testing is required. If the irritancy potential of a test chemical cannot be assigned based on the existing information, a step-wise sequential animal testing procedure is performed until an unequivocal classification can be made.

Weight-of-the-evidence (process): The strengths and weaknesses of a collection of information are used as the basis for a conclusion that may not be evident from the individual data.

▼ M7**SUPPLEMENT TO TEST METHOD B.5 (1)****A SEQUENTIAL TESTING STRATEGY FOR EYE IRRITATION AND CORROSION****General considerations**

In the interests of sound science and animal welfare, it is important to avoid the unnecessary use of animals, and to minimise testing that is likely to produce severe responses in animals. All information on a chemical relevant to its potential ocular irritation/corrosivity should be evaluated prior to considering *in vivo* testing. Sufficient evidence may already exist to classify a test chemical as to its eye irritation or corrosion potential without the need to conduct testing in laboratory animals. Therefore, utilizing a weight-of-the-evidence analysis and sequential testing strategy will minimise the need for *in vivo* testing, especially if the chemical is likely to produce severe reactions.

It is recommended that a weight-of-the-evidence analysis be used to evaluate existing information pertaining to eye irritation and corrosion of chemicals and to determine whether additional studies, other than *in vivo* eye studies, should be performed to help characterise such potential. Where further studies are needed, it is recommended that the sequential testing strategy be utilised to develop the relevant experimental data. For substances which have no testing history, the sequential testing strategy should be utilised to develop the data needed to evaluate its eye corrosion/irritation. The initial testing strategy described in this Supplement was developed at an OECD workshop (1). It was subsequently affirmed and expanded in the Harmonised Integrated Hazard Classification System for Human Health and Environmental Effects of Chemical Substances, as endorsed by the 28th Joint Meeting of the Chemicals Committee and the Working Party on Chemicals, in November 1998 (2), and updated by an OECD expert group in 2011.

Although this testing strategy is not an integrated part of test method B.5, it expresses the recommended approach for the determination of eye irritation/corrosion properties. This approach represents both best practice and an ethical benchmark for *in vivo* testing for eye irritation/corrosion. The test method provides guidance for the conduct of the *in vivo* test and summarises the factors that should be addressed before considering such a test. The sequential testing strategy provides a weight-of-the-evidence approach for the evaluation of existing data on the eye irritation/corrosion properties of chemicals and a tiered approach for the generation of relevant data on chemicals for which additional studies are needed or for which no studies have been performed. The strategy includes the performance first of validated and accepted *in vitro* or *ex vivo* tests and then of TM B.4 studies under specific circumstances (3) (4).

Description of the stepwise testing strategy

Prior to undertaking tests as part of the sequential testing strategy (Figure), all available information should be evaluated to determine the need for *in vivo* eye testing. Although significant information might be gained from the evaluation of single parameters (e.g. extreme pH), the totality of existing information should be assessed. All relevant data on the effects of the chemical in question, and its structural analogues, should be evaluated in making a weight-of-the-evidence decision, and a rationale for the decision should be presented. Primary emphasis should be placed upon existing human and animal data on the chemical, followed by

(1) For the use of an integrated testing strategy for eye irritation under the REACH see also the ECHA Guidance on information requirements and chemical safety assessment, Chapter R.7a: Endpoint specific guidance http://echa.europa.eu/documents/10162/13632/information_requirements_r7a_en.pdf

▼ M7

the outcome of *in vitro* or *ex vivo* testing. *In vivo* studies of corrosive chemicals should be avoided whenever possible. The factors considered in the testing strategy include:

Evaluation of existing human and/or animal data and/or *in vitro* data from validated and internationally accepted methods (Step 1)

Existing human data, e.g. clinical and occupational studies, and case reports, and/or animal test data from ocular studies and/or *in vitro* data from validated and internationally accepted methods for eye irritation/corrosion should be considered first, because they provide information directly related to effects on the eyes. Thereafter, available data from human and/or animal studies investigating dermal corrosion/irritation, and/or *in vitro* studies from validated and internationally accepted methods for skin corrosion should be evaluated. Chemicals with known corrosivity or severe irritancy to the eye should not be instilled into the eyes of animals, nor should chemicals showing corrosive or severe irritant effects to the skin; such chemicals should be considered to be corrosive and/or irritating to the eyes as well. Chemicals with sufficient evidence of non-corrosivity and non-irritancy from previously performed ocular studies should also not be tested in *in vivo* eye studies.

Analysis of structure activity relationships (SAR) (Step 2)

The results of testing of structurally related chemicals should be considered, if available. When sufficient human and/or animal data are available on structurally related substances or mixtures of such substances to indicate their eye corrosion/irritancy potential, it can be presumed that the test chemical will produce the same responses. In those cases, the chemical may not need to be tested. Negative data from studies of structurally related substances or mixtures of such substances do not constitute sufficient evidence of non-corrosivity/non-irritancy of a chemical under the sequential testing strategy. Validated and accepted SAR approaches should be used to identify the corrosion and irritation potential for both dermal and ocular effects.

Physicochemical properties and chemical reactivity (Step 3)

Chemicals exhibiting pH extremes such as $\leq 2,0$ or $\geq 11,5$ may have strong local effects. If extreme pH is the basis for identifying a chemical as corrosive or irritant to the eye, then its acid/alkaline reserve (buffering capacity) may also be taken into consideration (5)(6)(7). If the buffering capacity suggests that a chemical may not be corrosive to the eye (i.e., chemicals with extreme pH and low acid/alkaline reserve), then further testing should be undertaken to confirm this, preferably by the use of a validated and accepted *in vitro* or *ex vivo* test (see paragraph 10).

Consideration of other existing information (Step 4)

All available information on systemic toxicity via the dermal route should be evaluated at this stage. The acute dermal toxicity of the test chemical should also be considered. If the test chemical has been shown to be highly toxic by the dermal route, it may not need to be tested in the eye. Although there is not

▼M7

necessarily a relationship between acute dermal toxicity and eye irritation/corrosion, it can be assumed that if an agent is highly toxic via the dermal route, it will also exhibit high toxicity when instilled into the eye. Such data may also be considered between Steps 2 and 3.

Assessment of dermal corrosivity of the chemical if also required for regulatory purposes (Step 5)

The skin corrosion and severe irritation potential should be evaluated first in accordance with test method B.4 (4) and the accompanying Supplement (8), including the use of validated and internationally accepted *in vitro* skin corrosion test methods (9) (10) (11). If the chemical is shown to produce corrosion or severe skin irritation, it may also be considered to be a corrosive or severely irritant to the eye. Thus, no further testing would be required. If the chemical is not corrosive or severely irritating to the skin, an *in vitro* or *ex vivo* eye test should be performed.

Results from *in vitro* or *ex vivo* tests (Step 6).

Chemicals that have demonstrated corrosive or severe irritant properties in an *in vitro* or *ex vivo* test (12) (13) that has been validated and internationally accepted for the assessment specifically of eye corrosivity/irritation, need not be tested in animals. It can be presumed that such chemicals will produce similar severe effects *in vivo*. If validated and accepted *in vitro/ex vivo* tests are not available, one should bypass Step 6 and proceed directly to Step 7.

In vivo test in rabbits (Steps 7 and 8)

In vivo ocular testing should begin with an initial test using one animal. If the results of this test indicate the chemical to be a severe irritant or corrosive to the eyes, further testing should not be performed. If that test does not reveal any corrosive or severe irritant effects, a confirmatory test is conducted with two additional animals. Depending upon the results of the confirmatory test, further tests may be needed. [see test method B.5]

▼ **M7****TESTING AND EVALUATION STRATEGY FOR EYE IRRITATION/CORROSION**

	Activity	Finding	Conclusion
1	Existing human and/or animal data, and/or <i>in vitro</i> data from validated and internationally accepted methods showing effects on eyes	Severe damage to eyes	Apical endpoint; consider corrosive to eyes. No testing is needed.
		Eye irritant	Apical endpoint; consider irritating to eyes. No testing is needed.
		Not corrosive/not irritating to eyes	Apical endpoint; considered non-corrosive and non-irritating to eyes. No testing required.
	Existing human and/or animal data and/or <i>in vitro</i> data from validated and internationally accepted methods showing corrosive effects on skin	Skin corrosive	Assume corrosivity to eyes. No testing is needed.
	Existing human and/or animal data and/or <i>in vitro</i> data from validated and internationally accepted methods showing severe irritant effects on skin	Severe skin irritant	Assume irritating to eyes. No testing is needed
	↓		
	<i>no information available, or available information is not conclusive</i>		
	↓		
2	Perform SAR for eye corrosion/irritation	Predict severe damage to eyes	Assume corrosivity to eyes. No testing is needed.
		Predict irritation to eyes	Assume irritating to eyes. No testing is needed.
	Consider SAR for skin corrosion	Predict skin corrosivity	Assume corrosivity to eyes. No testing is needed.
	↓		
	<i>No predictions can be made, or predictions are not conclusive or negative</i>		
	↓		
3	Measure pH (buffering capacity, if relevant)	$pH \leq 2$ or $\geq 11,5$ (with high buffering capacity, if relevant)	Assume corrosivity to eyes. No testing is needed.
	↓		
	<i>$2 < pH < 11,5$, or $pH \leq 2,0$ or $\geq 11,5$ with low/no buffering capacity, if relevant</i>		
	↓		
4	Consider existing systemic toxicity data via the dermal route	Highly toxic at concentrations that would be tested in the eye.	Chemical would be too toxic for testing. No testing is needed.

▼ M7

	Activity	Finding	Conclusion
	↓		
	<i>Such information is not available, or chemical is not highly toxic</i>		
	↓		
5	Experimentally assess skin corrosion potential according to the testing strategy in chapter B.4 of this Annex if also required for regulatory purposes	Corrosive or severe irritant response	Assume corrosive to eyes. No further testing is needed.
	↓		
	<i>Chemical is not corrosive or severely irritating to skin</i>		
	↓		
6	Perform validated and accepted <i>in vitro</i> or <i>ex vivo</i> ocular test(s)	Corrosive or severe irritant response	Assume corrosive or severe irritant to eyes, provided the test performed can be used to identify corrosives/ severe irritants and the chemical is within the applicability domain of the test. No further testing is needed.
		Irritant response	Assume irritant to eyes, provided the test(s) performed can be used to correctly identify corrosive, severe irritants, and irritants, and the chemical is within the applicability domain of the test(s). No further testing is needed.
		Non-irritant response	Assume non-irritant to eyes, provided the test(s) performed can be used to correctly identify non-irritants, correctly distinguish these from chemicals that are irritants, severe irritants, or ocular corrosives, and the chemical is within the applicability domain of the test. No further testing is needed.
	↓		
	<i>Validated and accepted in vitro or ex vivo ocular test(s) cannot be used to reach a conclusion</i>		
	↓		

▼ M7

	Activity	Finding	Conclusion
7	Perform initial <i>in vivo</i> rabbit eye test using one animal	Severe damage to eyes	Consider corrosive to eyes. No further testing is needed.
	↓		
	<i>No severe damage, or no response</i>		
	↓		
8	Perform confirmatory test using one or two additional animals	Corrosive or irritating	Consider corrosive or irritating to eyes. No further testing is needed
		Not corrosive or irritating	Consider non-irritating and non-corrosive to eyes. No further testing is needed.

LITERATURE:

- (1) OECD (1996) OECD Test Guidelines Programme: Final Report of the OECD Workshop on Harmonization of Validation and Acceptance Criteria for Alternative Toxicological Test Methods. Held in Solna, Sweden, 22 - 24 January 1996 (<http://www.oecd.org/ehs/test/background.htm>).
- (2) OECD (1998) Harmonized Integrated Hazard Classification System for Human Health and Environmental Effects of Chemical Substances, as endorsed by the 28th Joint Meeting of the Chemicals Committee and the Working Party on Chemicals, November 1998 (<http://www.oecd.org/ehs/Class/HCL6.htm>).
- (3) Worth, A.P. and Fentem J.H. (1999). A General Approach for Evaluating Stepwise Testing Strategies. *ATLA* 27, 161-177.
- (4) Chapter B.4 of this Annex, Acute Dermal Irritation/Corrosion.
- (5) Young, J.R., How, M.J., Walker, A.P., Worth W.M.H. (1988) Classification as Corrosive or Irritant to Skin of Preparations Containing Acidic or Alkaline Substance Without Testing on Animals. *Toxicol. In Vitro*, 2, 19 - 26.
- (6) Fentem, J.H., Archer, G.E.B., Balls, M., Botham, P.A., Curren, R.D., Earl, L.K., Edsail, D.J., Holzhutter, H.G. and Liebsch, M. (1998) The ECVAM international validation study on *in vitro* tests for skin corrosivity. 2. Results and evaluation by the Management Team. *Toxicology in vitro* 12, pp.483 - 524.
- (7) Neun, D.J. (1993) Effects of Alkalinity on the Eye Irritation Potential of Solutions Prepared at a Single pH. *J. Toxicol. Cut. Ocular Toxicol.* 12, 227 - 231.
- (8) Supplement to Chapter B.4 of this Annex, A Sequential Testing Strategy for Skin Irritation and Corrosion.
- (9) Chapter B.40 of this Annex, *In Vitro* Skin Corrosion: Transcutaneous Electrical Resistance Test (TER).
- (10) Chapter B.40bis of this Annex, *In Vitro* Skin Corrosion: Human Skin Model Test.
- (11) OECD (2006), *Test No. 435: In vitro Membrane Barrier Test Method for Skin corrosion*, OECD Guidelines for the Testing of Chemicals, Section 4, OECD Paris.

▼ **M7**

- (12) Chapter B.47 of this Annex, Bovine Corneal Opacity and Permeability Test Method for Identifying i) Chemicals Inducing Serious Eye Damage and ii) Chemicals Not Requiring Classification for Eye Irritation or Serious Eye Damage.

- (13) Chapter B.48 of this Annex, Isolated Chicken Eye Test Method for Identifying i) Chemicals Inducing Serious Eye Damage and ii) Chemicals Not Requiring Classification for Eye Irritation or Serious Eye Damage.

▼ B**B.6. SKIN SENSITISATION****1. METHOD****1.1. INTRODUCTION***Remarks:*

The sensitivity and ability of tests to detect potential human skin sensitisers are considered important in a classification system for toxicity relevant to public health.

There is no single test method which will adequately identify all substances with a potential for sensitising human skin and which is relevant for all substances.

Factors such as the physical characteristics of a substance, including its ability to penetrate the skin, must be considered in the selection of a test.

Two types of tests using guinea pigs have been developed: the adjuvant-type tests, in which an allergic state is potentiated by dissolving or suspending the test substance in Freund's Complete Adjuvant (FCA), and the non-adjuvant tests.

Adjuvant-type tests are likely to be more accurate in predicting a probable skin sensitising effect of a substance in humans than those methods not employing Freund's Complete Adjuvant and are thus the preferred methods.

The Guinea-Pig Maximisation Test (GPMT) is a widely used adjuvant-type test. Although several other methods can be used to detect the potential of a substance to provoke skin sensitisation reaction, the GPMT is considered to be the preferred adjuvant technique.

With many chemical classes, non-adjuvant tests (the preferred one being the Buehler test) are considered to be less sensitive.

In certain cases there may be good reasons for choosing the Buehler test involving topical application rather than the intradermal injection used in the Guinea-Pig Maximisation Test. Scientific justification should be given when the Buehler test is used.

The Guinea-Pig Maximisation Test (GPMT) and the Buehler test are described in this method. Other methods may be used provided that they are well-validated and scientific justification is given.

If a positive result is seen in a recognised screening test, a test substance may be designated as a potential sensitiser, and it may not be necessary to conduct a further guinea pig test. However, if a negative result is seen in such a test, the guinea pig test must be conducted using the procedure described in this test method.

See also General introduction Part B.

▼B

1.2. DEFINITIONS

Skin sensitisation: (allergic contact dermatitis) is an immunologically mediated cutaneous reaction to a substance. In the human, the responses may be characterised by pruritis, erythema, oedema, papules, vesicles, bullae or a combination of these. In other species the reactions may differ and only erythema and oedema may be seen.

Induction exposure: an experimental exposure of a subject to a test substance with the intention of inducing a hypersensitive state.

Induction period: a period of at least one week following an induction exposure during which a hypersensitive state may be developed.

Challenge exposure: an experimental exposure of a previously treated subject to a test substance following an induction period, to determine if the subject reacts in a hypersensitive manner.

1.3. REFERENCE SUBSTANCES

The sensitivity and reliability of the experimental technique used should be assessed every six months by use of substances, which are known to have mild-to-moderate skin sensitisation properties.

In a properly conducted test, a response of at least 30 % in an adjuvant test and at least 15 % in a non-adjuvant test should be expected for mild/moderate sensitisers.

The following substances are preferred.

CAS numbers	EINECS numbers	EINECS names	Common names
101-86-0	202-983-3	α -hexylcinnamaldehyde	α -hexylcinnamaldehyde
149-30-4	205-736-8	Benzothiazole-2-thiol (mercapto-benzothiazole)	kaptax
94-09-7	202-303-5	Benzocaine	norcaine

There may be circumstances where, given adequate justification other control substances meeting the above criteria may be used.

1.4. PRINCIPLE OF THE TEST METHOD

The test animals are initially exposed to the test substance by intradermal injections and/or epidermal application (induction exposure). Following a rest period of 10 to 14 days (induction period), during which an immune response may develop, the animals are exposed to a challenge dose. The extent and degree of skin reaction to the challenge exposure in the test animals is compared with that demonstrated by control animals which undergo sham treatment during induction and receive the challenge exposure.

1.5. DESCRIPTION OF THE TEST METHODS

If removal of the test substance is considered necessary, this should be achieved using water or an appropriate solvent without altering the existing response or the integrity of the epidermis.

▼B1.5.1. *Guinea-Pig Maximisation Test (GPMT)*

1.5.1.1. Preparations

Healthy young adult albino guinea pigs are acclimatised to the laboratory conditions for at least five days prior to the test. Before the test, animals are randomised and assigned to the treatment groups. Removal of hair is by clipping, shaving or possibly by chemical depilation, depending on the test method used. Care should be taken to avoid abrading the skin. The animals are weighed before the test commences and at the end of the test.

1.5.1.2. Test conditions

1.5.1.2.1. Test animals

Commonly used laboratory strains of albino guinea-pigs are used.

1.5.1.2.2. Number and sex

Male and/or female animals can be used. If females are used, they should be nulliparous and non-pregnant.

A minimum of 10 animals is used in the treatment group and at least five animals in the control group. When fewer than 20 test and 10 control guinea pigs have been used, and it is not possible to conclude that the test substance is a sensitiser, testing in additional animals to give a total of at least 20 test and 10 control animals is strongly recommended.

1.5.1.2.3. Dose levels

The concentration of the test substance used for each induction exposure should be well-tolerated systemically and should be the highest to cause mild-to-moderate skin irritation. The concentration used for the challenge exposure should be the highest non-irritant dose. The appropriate concentrations should be determined from a pilot study using two or three animals, if other information is not available. Consideration should be given to the use of FCA-treated animals for this purpose.

1.5.1.3. Procedure

1.5.1.3.1. Induction

Day 0-treated group

Three pairs of intradermal injections of 0,1 ml volume are given in the shoulder region which is cleared of hair so that one of each pair lies on each side of the midline.

Injection 1: a 1:1 mixture (v/v) FCA/water or physiological saline.

Injection 2: the test substance in an appropriate vehicle at the selected concentration.

Injection 3: the test substance at the selected concentration formulated in a 1:1 mixture (v/v) FCA/water or physiological saline.

In injection 3, water soluble substances are dissolved in the aqueous phase prior to mixing with FCA. Liposoluble or insoluble substances are suspended in FCA prior to combining with the aqueous phase. The final concentration of test substance shall be equal to that used in injection 2.

▼B

Injections 1 and 2 are given close to each other and nearest the head, while 3 is given towards the caudal part of the test area.

Day 0-control group

Three pairs of intradermal injections of 0,1 ml volume are given in the same sites as in the treated animals.

Injection 1: a 1:1 mixture (v/v) FCA/water or physiological saline.

Injection 2: the undiluted vehicle.

Injection 3: a 50 % w/v formulation of the vehicle in a 1:1 mixture (v/v) FCA/water or physiological saline.

Day 5-7-treated and control groups

Approximately 24 hours before the topical induction application, if the substance is not a skin irritant, the test area, after close-clipping and/or shaving is treated with 0,5 ml of 10 % sodium lauryl sulphate in vaseline, in order to create a local irritation.

Day 6-8-treated group

The test area is again cleared of hair. A filter paper (2 × 4 cm) is fully-loaded with test substance in a suitable vehicle and applied to the test area and held in contact by an occlusive dressing for 48 hours. The choice of the vehicle should be justified. Solids are finely pulverised and incorporated in a suitable vehicle. Liquids can be applied undiluted, if appropriate.

Day 6-8-control group

The test area is again cleared of hair. The vehicle only is applied in a similar manner to the test area and held in contact by an occlusive dressing for 48 hours.

1.5.1.3.2. Challenge

Day 20-22-treated and control groups

The flanks of treated and control animals are cleared of hair. A patch or chamber loaded with the test substance is applied to one flank of the animals and, when relevant, a patch or chamber loaded with the vehicle only may also be applied to the other flank. The patches are held in contact by an occlusive dressing for 24 hours.

1.5.1.3.3. Observation and Grading: treated and control groups

- approximately 21 hours after removing the patch the challenge area is cleaned and closely-clipped and/or shaved and depilated if necessary;
- approximately three hours later (approximately 48 hours from the start of the challenge application) the skin reaction is observed and recorded according to the grades shown in the Appendix;
- approximately 24 hours after this observation a second observation (72 hours) is made and once again recorded.

Blind reading of test and control animals is encouraged.

If it is necessary to clarify the results obtained in the first challenge, a second challenge (i.e. a rechallenge), where appropriate with a new control group, should be considered approximately one week after the first one. A rechallenge may also be performed on the original control group.

▼B

All skin reactions and any unusual findings, including systemic reactions, resulting from induction and challenge procedures should be observed and recorded according to the grading scale of Magnusson/Kligman (See Appendix). Other procedures, e.g. histopathological examination, the measurement of skin fold thickness, may be carried out to clarify doubtful reactions.

1.5.2. *Buehler test*

1.5.2.1. Preparations

Healthy young adult albino guinea-pigs are acclimatised to the laboratory conditions for at least five days prior to the test. Before the test, animals are randomised and assigned to the treatment groups. Removal of hair is by clipping, shaving or possibly by chemical depilation, depending on the test method used. Care should be taken to avoid abrading the skin. The animals are weighed before the test commences and at the end of the test.

1.5.2.2. Test conditions

1.5.2.2.1. Test animals

Commonly used laboratory strains of albino guinea-pigs are used.

1.5.2.2.2. Number and sex

Male and/or female animals can be used. If females are used, they should be nulliparous and non-pregnant.

A minimum of 20 animals is used in the treatment group and at least 10 animals in the control group.

1.5.2.2.3. Dose levels

The concentration of test substance used for each induction exposure should be the highest possible to produce a mild but not excessive irritation. The concentration used for the challenge exposure should be the highest non-irritating dose. If necessary, the appropriate concentration can be determined from a pilot study using two or three animals.

For water soluble test materials, it is appropriate to use water or a dilute non-irritating solution of surfactant as the vehicle. For other test materials 80 % ethanol/water is preferred for induction and acetone for challenge.

1.5.2.3. Procedure

1.5.2.3.1. Induction

Day 0-treated group

One flank is cleared of hair (closely-clipped). The test patch system should be fully loaded with test substance in a suitable vehicle (the choice of the vehicle should be justified; liquid test substances can be applied undiluted, if appropriate).

The test patch system is applied to the test area and held in contact with the skin by an occlusive patch or chamber and a suitable dressing for six hours.

▼B

The test patch system must be occlusive. A cotton pad is appropriate and can be circular or square, but should approximate 4-6 cm². Restraint using an appropriate restrainer is preferred to assure occlusion. If wrapping is used, additional exposures may be required.

Day 0-control group

One flank is cleared of hair (closely-clipped). The vehicle only is applied in a similar manner to that used for the treated group. The test patch system is held in contact with the skin by an occlusive patch or chamber and a suitable dressing for six hours. If it can be demonstrated that a sham control group is not necessary, a naive control group may be used.

Days 6-8 and 13-15-treated and control group

The same application as on day 0 is carried out on the same test area (cleared of hair if necessary) of the same flank on day 6-8, and again on day 13-15.

1.5.2.3.2. Challenge

Day 27-29-treated and control group

The untreated flank of treated and control animals is cleared of hair (closely-clipped). An occlusive patch or chamber containing the appropriate amount of test substance is applied, at the maximum non-irritant concentration, to the posterior untreated flank of treated and control animals.

When relevant, an occlusive patch or chamber with vehicle only is also applied to the anterior untreated flank of both treated and control animals. The patches or chambers are held in contact by a suitable dressing for six hours.

1.5.2.3.3. Observation and grading

- approximately 21 hours after removing the patch the challenge area is cleared of hair,
- approximately three hours later (approximately 30 hours after application of the challenge patch) the skin reactions are observed and recorded according to the grades shown in the Appendix,
- approximately 24 hours after the 30 hour observation (approximately 54 hours after application of the challenge patch) skin reactions are again observed and recorded.

Blind reading of the test and control animals is encouraged.

If it is necessary to clarify the results obtained in the first challenge, a second challenge (i.e. a rechallenge), where appropriate with a new control group, should be considered approximately one week after the first one. A rechallenge may also be performed on the original control group.

▼ B

All skin reactions and any unusual findings, including systemic reactions, resulting from induction and challenge procedures should be observed and recorded according to the Magnusson/Kligman grading scale (See Appendix). Other procedures, e.g. histopathological examination, the measurement of skin fold thickness, may be carried out to clarify doubtful reactions.

2. DATA (GPMT and Buehler test)

Data should be summarised in tabular form, showing for each animal the skin reactions at each observation.

3. REPORTING (GPMT and Buehler test)

If a screening assay is performed before the guinea pig test the description or reference of the test (e.g. Mouse Ear Swelling Test (MEST)), including details of the procedure, must be given together with results obtained with the test and reference substances.

Test report (GMPT and Buehler test)

The test report shall, if possible, include the following information:

Test animals:

- strain of guinea-pig used,
- number, age and sex of animals,
- source, housing conditions, diet, etc.,
- individual weights of animals at the start of the test.

Test conditions:

- technique of patch site preparation,
- details of patch materials used and patching technique,
- result of pilot study with conclusion on induction and challenge concentrations to be used in the test,
- details of test substance preparation, application and removal,
- justification for choice of vehicle,
- vehicle and test substance concentrations used for induction and challenge exposures and the total amount of substance applied for induction and challenge.

Results:

- a summary of the results of the latest sensitivity and reliability check (see 1.3) including information on substance, concentration and vehicle used,

▼B

- on each animal including grading system,
- narrative description of the nature and degree effects observed,
- any histopathological findings.

Discussion of results.

Conclusions.

4. **REFERENCES**

This method is analogous to OECD TG 406.

▼B

Appendix

TABLE

Magnusson/Kligman grading scale for the evaluation of challenge patch test reactions

0 = no visible change

1 = discrete or patchy erythema

2 = moderate and confluent erythema

3 = intense erythema and swelling

▼M4**B.7. REPEATED DOSE 28-DAY ORAL TOXICITY STUDY IN RODENTS**

INTRODUCTION

1. This Test Method is equivalent to OECD Test Guideline 407 (2008). The original Test Guideline 407 was adopted in 1981. In 1995 a revised version was adopted, to obtain additional information from the animal used in the study, in particular on neurotoxicity and immunotoxicity.
2. In 1998, the OECD initiated a high-priority activity, to revise existing Test Guidelines and to develop new Test Guidelines for the screening and testing of potential endocrine disruptors (8). One element of the activity was to update the existing OECD guideline for 'repeated dose 28-day oral toxicity study in rodents' (TG 407) by parameters suitable to detect endocrine activity of test chemicals. This procedure underwent an extensive international program to test for the relevance and practicability of the additional parameters, the performance of these parameters for chemicals with (anti)oestrogenic, (anti)androgenic, and (anti)thyroid activity, the intra- and inter-laboratory reproducibility, and the interference of the new parameters with those required by the prior TG 407. The large amount of data thereby obtained has been compiled and evaluated in detail in a comprehensive OECD report (9). This updated Test Method B.7 (as equivalent to TG 407) is the outcome of the experience and results gained during the international test program. This Test Method allows certain endocrine mediated effects to be put into context with other toxicological effects.

INITIAL CONSIDERATIONS AND LIMITATIONS

3. In the assessment and evaluation of the toxic characteristics of a chemical, the determination of oral toxicity using repeated doses may be carried out after initial information on toxicity has been obtained by acute toxicity testing. This Test Method is intended to investigate effects on a very broad variety of potential targets of toxicity. It provides information on the possible health hazards likely to arise from repeated exposure over a relatively limited period of time, including effects on the nervous, immune and endocrine systems. Regarding these particular endpoints, it should identify chemicals with neurotoxic potential, which may warrant further in-depth investigation of this aspect, and chemicals that interfere with thyroid physiology. It may also provide data on chemicals that affect the male and/or female reproductive organs in young adult animals and may give an indication of immunological effects.
4. The results from this Test Method B.7 should be used for hazard identification and risk assessment. The results obtained by the endocrine related parameters should be seen in the context of the 'OECD Conceptual Framework for Testing and Assessment of Endocrine Disrupting Chemicals' (11). The method comprises the basic repeated dose toxicity study that may be used for chemicals on which a 90-day study is not warranted (e.g. when the production volume does not exceed certain limits) or as a preliminary to a long-term study. The duration of exposure should be 28 days.

▼ M4

5. The international program conducted on the validation of parameters suitable to potentially detect endocrine activity of a test chemical showed that the quality of data obtained by this Test Method B.7 will depend much on the experience of the test laboratory. This relates specifically to the histopathological determination of cyclic changes in the female reproductive organs and to the weight determination of the small hormone dependent organs which are difficult to dissect. Guidance on histopathology has been developed (19). It is available on the OECD public website on Test Guidelines. It is intended to assist pathologists in their examinations and help increase the sensitivity of the assay. A variety of parameters were found to be indicative of endocrine-related toxicity and have been incorporated in the Test Method. Parameters for which insufficient data were available to prove usefulness or which showed only weak evidence in the validation programme of their ability to help in detection of endocrine disrupters are proposed as optional endpoints (see Appendix 2).

6. On the basis of data generated in the validation process, it must be emphasised that the sensitivity of this assay is not sufficient to identify all substances with (anti)androgenic or (anti)oestrogenic modes of action (9). The Test Method is not performed in a life-stage that is most sensitive to endocrine disruption. The Test Method nevertheless, during the validation process identified substances weakly and strongly affecting thyroid function, and strong and moderate endocrine active substances acting through oestrogen or androgen receptors, but in most cases failed to identify endocrine active substances that weakly affect oestrogen or androgen receptors. Thus it cannot be described as a screening assay for endocrine activity.

7. Consequently, the lack of effects related to these modes of action can not be taken as evidence for the lack of effects on the endocrine system. Regarding endocrine mediated effects, substance characterisation should not therefore be based on the results of this Test Method alone but should be used in a weight of evidence approach incorporating all existing data on a chemical to characterise potential endocrine activity. For this reason, regulatory decision making on endocrine activity (substance characterisation) should be a broadly based approach, not solely reliant on results from application of this test method.

8. It is acknowledged that all animal-based procedures will conform to local standards of animal care; the descriptions of care and treatment set forth below are minimal performance standards, and will be superseded by local regulations where more stringent. Further guidance of the humane treatment of animals is given by the OECD (14).

9. Definitions used are given in Appendix 1.

PRINCIPLE OF THE TEST

10. The test chemical is orally administered daily in graduated doses to several groups of experimental animals, one dose level per group for a period of 28 days. During the period of administration the animals are observed closely, each day for signs of toxicity. Animals that die or are euthanised during the test are necropsied and at the conclusion of the test surviving animals are euthanised and necropsied. A 28 day study provides information on the

▼ M4

effects of repeated oral exposure and can indicate the need for further longer term studies. It can also provide information on the selection of concentrations for longer term studies. The data derived from using the Test Method should allow for the characterisation of the test chemical toxicity, for an indication of the dose response relationship and the determination of the No-Observed Adverse Effect Level (NOAEL).

DESCRIPTION OF THE METHOD**Selection of animal species**

11. The preferred rodent species is the rat, although other rodent species may be used. If the parameters specified within this Test Method B.7 are investigated in another rodent species a detailed justification should be given. Although it is biologically plausible that other species should respond to toxicants in a similar manner to the rat, the use of smaller species may result in increased variability due to technical challenges of dissecting smaller organs. In the international validation program for the detection of endocrine disrupters, the rat was the only species used. Young healthy adult animals of commonly used laboratory strains should be employed. Females should be nulliparous and non pregnant. Dosing should begin as soon as feasible after weaning, and, in any case, before the animals are nine weeks old. At the commencement of the study the weight variation of animals used should be minimal and not exceed $\pm 20\%$ of the mean weight of each sex. When a repeated oral dose is conducted as a preliminary to a longer-term study, it is preferable that animals from the same strain and source should be used in both studies.

Housing and feeding

12. All procedures should conform to local standards of laboratory animal care. The temperature in the experimental animal room should be $22\text{ }^{\circ}\text{C}$ ($\pm 3\text{ }^{\circ}\text{C}$). Although the relative humidity should be at least 30% and preferably not to exceed 70% other than during room cleaning, the aim should be $50\text{--}60\%$. Lighting should be artificial, the photoperiod being 12 hours light, 12 hours dark. For feeding, conventional laboratory diets may be used with an unlimited supply of drinking water. The choice of diet may be influenced by the need to ensure a suitable admixture of a test chemical when administered by this method. Animals should be group housed in small groups of the same sex; animals may be housed individually if scientifically justified. For group caging, no more than five animals should be housed per cage.
13. The feed should be regularly analysed for contaminants. A sample of the diet should be retained until finalisation of the report.

Preparation of animals

14. Healthy young adult animals are randomly assigned to the control and treatment groups. Cages should be arranged in such a way that possible effects due to cage placement are minimised. The animals are identified uniquely and kept in their cages for at least five days prior to the start of the treatment study to allow for acclimatisation to the laboratory conditions.

Preparation of doses

15. The test chemical is administered by gavage or via the diet or drinking water. The method of oral administration is dependent on the purpose of the study, and the physical/chemical/toxico-kinetic properties of the test chemical.

▼M4

16. Where necessary, the test chemical is dissolved or suspended in a suitable vehicle. It is recommended that, wherever possible, the use of an aqueous solution/suspension be considered first, followed by consideration of a solution/suspension in oil (e.g. corn oil) and then by possible solution in other vehicles. For vehicles other than water the toxic characteristics of the vehicle must be known. The stability of the test chemical in the vehicle should be determined.

PROCEDURE**Number and sex of animals**

17. At least 10 animals (five female and five male) should be used at each dose level. If interim euthanasia are planned, the number should be increased by the number of animals scheduled to be euthanised before the completion of the study. Consideration should be given to an additional satellite group of ten animals (five per sex) in the control and in the top dose group for observation of reversibility, persistence, or delayed occurrence of toxic effects, for at least 14 days post treatment.

Dosage

18. Generally, at least three test groups and a control group should be used, but if from assessment of other data, no effects would be expected at a dose of 1 000 mg/kg bw/d, a limit test may be performed. If there are no suitable data available, a range finding study (animals of the same strain and source) may be performed to aid the determination of the doses to be used. Except for treatment with the test chemical, animals in the control group should be handled in an identical manner to the test group subjects. If a vehicle is used in administering the test chemical, the control group should receive the vehicle in the highest volume used.
19. Dose levels should be selected taking into account any existing toxicity and (toxico-) kinetic data available for the test chemical or related chemicals. The highest dose level should be chosen with the aim of inducing toxic effects but not death or severe suffering. Thereafter, a descending sequence of dose levels should be selected with a view to demonstrating any dosage related response and no-observed-adverse effects at the lowest dose level (NOAEL). Two to four fold intervals are frequently optimal for setting the descending dose levels and addition of a fourth test group is often preferable to using very large intervals (e.g. more than a factor of 10) between dosages.
20. In the presence of observed general toxicity (e.g. reduced body weight, liver, heart, lung or kidney effects, etc.) or other changes that may not be toxic responses (e.g. reduced food intake, liver enlargement), observed effects on immune, neurological or endocrine sensitive endpoints should be interpreted with caution.

Limit test

21. If a test at one dose level of at least 1 000 mg/kg body weight/day or, for dietary or drinking water administration, an equivalent percentage in the diet, or drinking water (based upon body weight determinations), using the procedures described for this study, produces no observable toxic effects and if toxicity would not be expected based upon data from structurally related chemicals, then a full study using three dose levels may not be considered necessary. The limit test applies except when human exposure indicates the need for a higher dose level to be used.

▼ M4**Administration of doses**

22. The animals are dosed with test chemical daily 7 days each week for a period of 28 days. When the test chemical is administered by gavage, this should be done in a single dose to the animals using a stomach tube or a suitable intubation cannula. The maximum volume of liquid that can be administered at one time depends on the size of the test animal. The volume should not exceed 1 ml/100 g body weight except in the case of aqueous solutions where 2 ml/100 g body weight may be used. Except for irritating or corrosive chemicals, which will normally reveal exacerbated effects with higher concentrations, variability in test volume should be minimized by adjusting the concentration to ensure a constant volume at all dose levels.

23. For chemicals administered via the diet or drinking water it is important to ensure that the quantities of the test chemical involved do not interfere with normal nutrition or water balance. When the test chemical is administered in the diet either a constant dietary concentration (ppm) or a constant dose level in terms of the animals' body weight may be used; the alternative used must be specified. For a chemical administered by gavage, the dose should be given at similar times each day, and adjusted as necessary to maintain a constant dose level in terms of animal body weight. Where a repeated dose study is used as a preliminary to a long term study, a similar diet should be used in both studies.

Observations

24. The observation period should be 28 days. Animals in a satellite group scheduled for follow-up observations should be kept for at least 14 days without treatment to detect delayed occurrence, or persistence of, or recovery from toxic effects.

25. General clinical observations should be made at least once a day, preferably at the same time(s) each day and considering the peak period of anticipated effects after dosing. The health condition of the animals should be recorded. At least twice daily, all animals are observed for morbidity and mortality.

26. Once before the first exposure (to allow for within-subject comparisons), and at least once a week thereafter, detailed clinical observations should be made in all animals. These observations should be made outside the home cage in a standard arena and preferably at the same time of day on each occasion. They should be carefully recorded, preferably using scoring systems, explicitly defined by the testing laboratory. Effort should be made to ensure that variations in the test conditions are minimal and that observations are preferably conducted by observers unaware of the treatment. Signs noted should include, but not be limited to, changes in skin, fur, eyes, mucous membranes, occurrence of secretions and excretions and autonomic activity (e.g. lacrimation, piloerection, pupil size, unusual respiratory pattern). Changes in gait, posture and response to handling as well as the presence of clonic or tonic movements, stereotypies (e.g. excessive grooming, repetitive circling) or bizarre behaviour (e.g. self-mutilation, walking backwards) should also be recorded (2).

27. In the fourth exposure week sensory reactivity to stimuli of different types (2) (e.g. auditory, visual and proprioceptive stimuli) (3)(4)(5), assessment of grip strength (6) and motor activity assessment (7) should be conducted. Further details of the procedures that could be followed are given in the respective references. However, alternative procedures than those referenced could be used.

▼ M4

28. Functional observations conducted in the fourth exposure week may be omitted when the study is conducted as a preliminary study to a subsequent subchronic (90-day) study. In that case, the functional observations should be included in this follow-up study. On the other hand, the availability of data on functional observations from the repeated dose study may enhance the ability to select dose levels for a subsequent subchronic study.
29. As an exception, functional observations may also be omitted for groups that otherwise reveal signs of toxicity to an extent that would significantly interfere with the functional test performance.
30. At necropsy, the oestrus cycle of all females could be determined (optional) by taking vaginal smears. These observations will provide information regarding the stage of oestrus cycle at the time of sacrifice and assist in histological evaluation of estrogen sensitive tissues [see guidance on histopathology (19)].

Body weight and food/water consumption

31. All animals should be weighed at least once a week. Measurements of food consumption should be made at least weekly. If the test chemical is administered via the drinking water, water consumption should also be measured at least weekly.

Haematology

32. The following haematological examinations should be made at the end of the test period: haematocrit, haemoglobin concentrations, erythrocyte count, reticulocytes, total and differential leucocyte count, platelet count and a measure of blood clotting time/potential. Other determinations that should be carried out, if the test chemical or its putative metabolites have or are suspected to have oxidising properties include methaemoglobin concentration and Heinz bodies.
33. Blood samples should be taken from a named site just prior to or as part of the procedure for euthanasia of the animals, and stored under appropriate conditions. Animals should be fasted overnight prior to euthanasia⁽¹⁾.

Clinical biochemistry

34. Clinical biochemistry determinations to investigate major toxic effects in tissues and, specifically, effects on kidney and liver, should be performed on blood samples obtained of all animals just prior to or as part of the procedure for euthanasia of the animals (apart from those found moribund and/or euthanised prior to the termination of the study). Investigations of plasma or serum shall include sodium, potassium, glucose, total cholesterol, urea, creatinine, total protein and albumin, at least two enzymes indicative of hepatocellular effects (such as alanin aminotransferase, aspartate aminotransferase, alkaline phosphatase, γ -glutamyl trans-peptidase and glutamate dehydrogenase), and bile acids. Measurements of additional enzymes (of hepatic or other origin) and bilirubin may provide useful information under certain circumstances.
35. Optionally, the following urinalysis determinations could be performed during the last week of the study using timed urine volume collection; appearance, volume, osmolality or specific gravity, pH, protein, glucose and blood/blood cells.

⁽¹⁾ For a number of measurements in serum and plasma, most notably for glucose, overnight fasting would be preferable. The major reason for this preference is that the increased variability which would inevitably result from non-fasting, would tend to mask more subtle effects and make interpretation difficult. On the other hand, however, overnight fasting may interfere with the general metabolism of the animals and, particularly in feeding studies, may disturb the daily exposure to the test chemical. If overnight fasting is adopted, clinical biochemical determinations should be performed after the conduct of functional observations in week 4 of the study.

▼ M4

36. In addition, studies to investigate plasma or serum markers of general tissue damage should be considered. Other determinations that should be carried out, if the known properties of the test chemical may, or are suspected to, affect related metabolic profiles include calcium, phosphate, triglycerides, specific hormones, and cholinesterase. These need to be identified for chemicals in certain classes or on a case-by-case basis.
37. Although in the international evaluation of the endocrine related endpoints a clear advantage for the determination of thyroid hormones (T3, T4) and TSH could not be demonstrated, it may be helpful to retain plasma or serum samples to measure T3, T4 and TSH (optional) if there is an indication for an effect on the pituitary-thyroid axis. These samples may be frozen at -20° for storage. The following factors may influence the variability and the absolute concentrations of the hormone determinations:

— time of sacrifice because of diurnal variation of hormone concentrations

— method of sacrifice to avoid undue stress to the animals that may affect hormone concentrations

— test kits for hormone determinations that may differ by their standard curves.

Definitive identification of thyroid-active chemicals is more reliable by histopathological analysis rather than hormone levels.

38. Plasma samples specifically intended for hormone determination should be obtained at a comparable time of the day. It is recommended that consideration should be given to T3, T4 and TSH determinations triggered based upon alterations of thyroid histopathology. The numerical values obtained when analysing hormone concentrations differ with various commercial assay kits. Consequently, it may not be possible to provide performance criteria based upon uniform historical data. Alternatively, laboratories should strive to keep control coefficients of variation below 25 for T3 and T4 and below 35 for TSH. All concentrations are to be recorded in ng/ml.
39. If historical baseline data are inadequate, consideration should be given to determination of haematological and clinical biochemistry variables before dosing commences or preferably in a set of animals not included in the experimental groups.

PATHOLOGY

Gross necropsy

40. All animals in the study shall be subjected to a full, detailed gross necropsy which includes careful examination of the external surface of the body, all orifices, and the cranial, thoracic and abdominal cavities and their contents. The liver, kidneys, adrenals, testes, epididymides, prostate + seminal vesicles with coagulating glands as a whole, thymus, spleen, brain and heart of all animals (apart from those found moribund and/or euthanised prior to the termination of the study) should be trimmed of any adherent tissue, as appropriate, and their wet weight taken as soon as possible after dissection to avoid drying. Care must be exercised when trimming the prostate complex to avoid puncture of the fluid filled seminal vesicles. Alternatively, seminal vesicles and prostate may be trimmed and weighed after fixation.

▼ M4

41. In addition, two other tissues could be optionally weighed as soon as possible after dissection, to avoid drying: paired ovaries (wet weight) and uterus, including cervix (guidance on removal and preparation of the uterine tissues for weight measurement is provided in OECD TG 440 (18)).

42. The thyroid weight (optional) could be determined after fixation. Trimming should also be done very carefully and only after fixation to avoid tissue damage. Tissue damage could compromise histopathology analysis.

43. The following tissues should be preserved in the most appropriate fixation medium for both the type of tissue and the intended subsequent histopathological examination (see paragraph 47): all gross lesions, brain (representative regions including cerebrum, cerebellum and pons), spinal cord, eye, stomach, small and large intestines (including Peyer's patches), liver, kidneys, adrenals, spleen, heart, thymus, thyroid, trachea and lungs (preserved by inflation with fixative and then immersion), gonads (testis and ovaries), accessory sex organs (uterus and cervix, epididymides, prostate + seminal vesicles with coagulating glands), vagina, urinary bladder, lymph nodes [besides the most proximal draining node another lymph node should be taken according to the laboratory's experience (15)], peripheral nerve (sciatic or tibial) preferably in close proximity to the muscle, skeletal muscle and bone, with bone marrow (section or, alternatively, a fresh mounted bone marrow aspirate). It is recommended that testes be fixed by immersion in Bouin's or modified Davidson's fixative (16) (17). The tunica albuginea must be gently and shallowly punctured at the both poles of the organ with a needle to permit rapid penetration of the fixative. The clinical and other findings may suggest the need to examine additional tissues. Also any organs considered likely to be target organs based on the known properties of the test chemical should be preserved.

44. The following tissues may give valuable indication for endocrine-related effects: Gonads (ovaries and testes), accessory sex organs (uterus including cervix, epididymides, seminal vesicles with coagulation glands, dorsolateral and ventral prostate), vagina, pituitary, male mammary gland, the thyroid and adrenal gland. Changes in male mammary glands have not been sufficiently documented but this parameter may be very sensitive to substances with oestrogenic action. Observation of organs/tissues that are not listed in paragraph 43 is optional (see Appendix 2).

45. The Guidance on histopathology (19) details extra information on dissection, fixation, sectioning and histopathology of endocrine tissues.

46. In the international test program some evidence was obtained that subtle endocrine effects by chemicals with a low potency for affecting sex hormone homeostasis may be identified by disturbance of the synchronisation of the oestrus cycle in different tissues and not so much by frank histopathological alterations in female sex organs. Although no definitive proof was obtained for such effects, it is recommended that evidence of possible asynchrony of the oestrus cycle should be taken into account in interpretation of the histopathology of the ovaries (follicular, thecal, and granulosa cells), uterus, cervix and vagina. If assessed, the stage of cycle as determined by vaginal smears could be included in this comparison as well.

▼ M4**Histopathology**

47. Full histopathology should be carried out on the preserved organs and tissues of all animals in the control and high dose groups. These examinations should be extended to animals of all other dosage groups, if treatment-related changes are observed in the high dose group.
48. All gross lesions shall be examined.
49. When a satellite group is used, histopathology should be performed on tissues and organs identified as showing effects in the treated groups.

DATA AND REPORTING**Data**

50. Individual data should be provided. Additionally, all data should be summarised in tabular form showing for each test group the number of animals at the start of the test, the number of animals found dead during the test or euthanised for humane reasons and the time of any death or euthanasia, the number showing signs of toxicity, a description of the signs of toxicity observed, including time of onset, duration, and severity of any toxic effects, the number of animals showing lesions, the type of lesions, their severity and the percentage of animals displaying each type of lesion.
51. When possible, numerical results should be evaluated by an appropriate and generally acceptable statistical method. Comparisons of the effect along a dose range should avoid the use of multiple t-tests. The statistical methods should be selected during the design of the study.
52. For quality control it is proposed that historical control data are collected and that for numerical data coefficients of variation are calculated, especially for the parameters linked with endocrine disrupter detection. These data can be used for comparison purposes when actual studies are evaluated.

Test report

53. The test report must include the following information:

Test chemical:

- physical nature, purity and physicochemical properties;
- identification data.

Vehicle (if appropriate):

- justification for choice of vehicle, if other than water.

Test animals:

- species/strain used;
- number, age and sex of animals;
- source, housing conditions, diet, etc.;
- individual weights of animals at the start of the test.
- justification for species if not rat

Test conditions:

- rationale for dose level selection;
- details of test chemical formulation/diet preparation, achieved concentration, stability and homogeneity of the preparation;

▼ M4

- details of the administration of the test chemical;
- conversion from diet/drinking water test chemical concentration (ppm) to the actual dose (mg/kg body weight/day), if applicable;
- details of food and water quality.

Optional endpoints investigated

- list of optional endpoints investigated

Results:

- body weight/body weight changes;
- food consumption, and water consumption, if applicable;
- toxic response data by sex and dose level, including signs of toxicity;
- nature, severity and duration of clinical observations (whether reversible or not);
- sensory activity, grip strength and motor activity assessments;
- haematological tests with relevant base-line values;
- clinical biochemistry tests with relevant base-line values;
- body weight at euthanasia and organ weight data;
- necropsy findings;
- a detailed description of all histopathological findings;
- absorption data if available;
- statistical treatment of results, where appropriate.

*Discussion of results**Conclusions*

▼ M4*Appendix 1*

DEFINITIONS

Androgenicity is the capability of a chemical to act like a natural androgenic hormone (e.g. testosterone) in a mammalian organism.

Antiandrogenicity is the capability of a chemical to suppress the action of a natural androgenic hormone (e.g. testosterone) in a mammalian organism.

Antioestrogenicity is the capability of a chemical to suppress the action of a natural oestrogenic hormone (e.g. oestradiol 17 β) in a mammalian organism.

Antithyroid activity is the capability of a chemical to suppress the action of a natural thyroid hormone (e.g. T₃) in a mammalian organism.

Dosage is a general term comprising of dose, its frequency and the duration of dosing.

Dose is the amount of test chemical administered. The dose is expressed as weight of test chemical per unit body weight of test animal per day (e.g. mg/kg body weight/day), or as a constant dietary concentration.

Evident toxicity is a general term describing clear signs of toxicity following administration of test chemical. These should be sufficient for hazard assessment and should be such that an increase in the dose administered can be expected to result in the development of severe toxic signs and probable mortality.

NOAEL is the abbreviation for no-observed-adverse-effect level. This is the highest dose level where no adverse treatment-related findings are observed due to treatment.

Oestrogenicity is the capability of a chemical to act like a natural oestrogenic hormone (e.g. oestradiol 17 β) in a mammalian organism.

Test chemical: Any substance or mixture tested using this Test Method.

Thyroid activity is the capability of a chemical to act like a natural thyroid hormone (e.g. T₃) in a mammalian organism.

Validation is a scientific process designed to characterise the operational requirements and limitations of a test method and to demonstrate its reliability and relevance for a particular purpose.

▼ **M4***Appendix 2***Endpoints recommended for the detection of endocrine disruptors (EDs) in this Test Method B.7**

Mandatory endpoints	Optional endpoints
Weight	
<ul style="list-style-type: none"> — Testes — Epididymides — Adrenals — Prostate + seminal vesicles with coagulating glands 	<ul style="list-style-type: none"> — Ovaries — Uterus, including cervix — Thyroid
Histopathology	
<ul style="list-style-type: none"> — Gonads: <ul style="list-style-type: none"> — Testes and — Ovaries — Accessory sex organs: <ul style="list-style-type: none"> — Epididymides, — Prostate + seminal vesicle with coagulating glands — Uterus, including cervix — Adrenal — Thyroid — Vagina 	<ul style="list-style-type: none"> — Vaginal smears — Male mammary glands — Pituitary
Hormones measurement	
	<ul style="list-style-type: none"> — Circulating levels of T3, T4 — Circulating levels of TSH

LITERATURE:

- (1) OECD (Paris, 1992). Chairman's Report of the Meeting of the ad hoc Working Group of Experts on Systemic Short-term and (Delayed) Neurotoxicity.
- (2) IPCS (1986). Principles and Methods for the Assessment of Neurotoxicity Associated with Exposure to Chemicals. Environmental Health Criteria Document No 60.
- (3) Tupper DE, Wallace RB (1980). Utility of the Neurologic Examination in Rats. *Acta Neurobiol. Exp.* 40: 999-1003.
- (4) Gad SC (1982). A Neuromuscular Screen for Use in Industrial Toxicology. *J. Toxicol Environ. Health* 9: 691-704.
- (5) Moser VC, McDaniel KM, Phillips PM (1991). Rat Strain and Stock Comparisons Using a Functional Observational Battery: Baseline Values and Effects of Amitraz. *Toxicol. Appl. Pharmacol.* 108: 267-283.
- (6) Meyer OA, Tilson HA, Byrd WC, Riley MT (1979). A Method for the Routine Assessment of Fore- and Hindlimb Grip Strength of Rats and Mice. *Neurobehav. Toxicol.* 1: 233-236.

▼M4

- (7) Crofton KM, Howard JL, Moser VC, Gill MW, Reiter LW, Tilson HA, MacPhail RC (1991). Interlaboratory Comparison of Motor Activity Experiments: Implication for Neurotoxicological Assessments. *Neurotoxicol. Teratol.* 13: 599-609.
- (8) OECD (1998). Report of the First Meeting of the OECD Endocrine Disrupter Testing and Assessment (EDTA) Task Force, 10th-11 March 1998, ENV/MC/CHEM/RA(98)5.
- (9) OECD. (2006). Report of the Validation of the Updated Test Guideline 407: Repeat Dose 28-day Oral Toxicity Study in Laboratory Rats. Series on Testing and Assessment No 59, ENV/JM/MONO(2006)26.
- (10) OECD (2002). Detailed Review Paper on the Appraisal of Test Methods for Sex Hormone Disrupting Chemicals. Series on Testing and Assessment No 21, ENV/JM/MONO(2002)8.
- (11) OECD (2012). Conceptual Framework for Testing and Assessment of Endocrine Disrupting Chemicals. http://www.oecd.org/document/58/0,3343,fr_2649_37407_2348794_1_1_1_37407,00.html
- (12) OECD (2006). Final Summary report of the meeting of the Validation Management Group for mammalian testing. ENV/JM/TG/EDTA/M(2006)2.
- (13) OECD. Draft Summary record of the meeting of the Task Force on Endocrine Disrupters Testing and Assessment. ENV/JM/TG/EDTA/M(2006)3.
- (14) OECD (2000). Guidance document on the recognition, assessment and use of clinical signs as humane endpoints for experimental animals used in safety evaluation. Series on Testing and Assessment No 19. ENV/JM/MONO(2000)7.
- (15) Haley P, Perry R, Ennulat D, Frame S, Johnson C, Lapointe J-M, Nyska A, Snyder PW, Walker D, Walter G (2005). STP Position Paper: Best Practice Guideline for the Routine Pathology Evaluation of the Immune System. *Toxicol Pathol* 33: 404-407.
- (16) Hess RA, Moore BJ (1993). Histological Methods for the Evaluation of the Testis. In: *Methods in Reproductive Toxicology*, Chapin RE and Heindel JJ (eds). Academic Press: San Diego, CA, pp. 52-85.
- (17) Latendresse JR, Warbritton AR, Jonassen H, Creasy DM. (2002) Fixation of testes and eyes using a modified Davidson's fluid: comparison with Bouin's fluid and conventional Davidson's fluid. *Toxicol. Pathol.* 30, 524-533.
- (18) OECD (2007). OECD Guideline for Testing of Chemicals No 440: Uterotrophic Bioassay in Rodents: A short-term screening test for oestrogenic properties.
- (19) OECD (2009). Guidance Document 106 on Histologic evaluation of Endocrine and Reproductive Tests in Rodents ENV/JM/Mono(2009)11.

▼ M4**B.8. SUBACUTE INHALATION TOXICITY: 28-DAY STUDY****SUMMARY**

This revised Test Method B.8 has been designed to fully characterise test chemical toxicity by the inhalation route following repeated exposure for a limited period of time (28 days), and to provide data for quantitative inhalation risk assessments. Groups of at least 5 male and 5 female rodents are exposed 6 hours per day for 28 days to a) the test chemical at three or more concentration levels, b) filtered air (negative control), and/or c) the vehicle (vehicle control). Animals are generally exposed 5 days per week but exposure for 7 days per week is also allowed. Males and females are always tested, but they may be exposed at different concentration levels if it is known that one sex is more susceptible to a given test chemical. This method allows the study director the flexibility to include satellite (reversibility) groups, bronchoalveolar lavage (BAL), neurologic tests, and additional clinical pathology and histopathological evaluations in order to better characterise the toxicity of a test chemical.

INTRODUCTION

1. This Test Method is equivalent to OECD Test Guideline 412 (2009). The original subacute inhalation Test Guideline 412 (TG 412) was adopted in 1981 (1). This Test Method B.8 (as equivalent to the revised TG 412) has been updated to reflect the state of science and to meet current and future regulatory needs.
2. This method enables the characterisation of adverse effects following repeated daily inhalation exposure to a test chemical for 28 days. The data derived from 28-day sub-acute inhalation toxicity studies can be used for quantitative risk assessments [if not followed by a 90-day subchronic inhalation toxicity study (Chapter B.29 of this Annex)]. The data can also provide information on the selection of concentrations for longer term studies such as the 90-day subchronic inhalation toxicity study. This test method is not specifically intended for the testing of nano-materials. Definitions used in the context of this Test Method are provided at the end of this chapter and in the Guidance Document 39 (2).

INITIAL CONSIDERATIONS

3. All available information on the test chemical should be considered by the testing laboratory prior to conducting the study in order to enhance the quality of the study and minimize animal usage. Information that will assist in the selection of appropriate test concentrations might include the identity, chemical structure, and physico-chemical properties of the test chemical; results of any *in vitro* or *in vivo* toxicity tests; anticipated use(s) and potential for human exposure; available (Q)SAR data and toxicological data on structurally related chemicals; and data derived from acute inhalation toxicity testing. If neurotoxicity is expected or is observed in the course of the study, the study director may choose to include appropriate evaluations such as a functional observational battery (FOB) and measurement of motor activity. Although the timing of exposures relative to specific examinations may be critical, the performance of these additional activities should not interfere with the basic study design.

▼M4

4. Dilutions of corrosive or irritating test chemicals may be tested at concentrations that will yield the desired degree of toxicity [refer to GD 39 (2)]. When exposing animals to these materials, the targeted concentrations should be low enough to not cause marked pain and distress, yet sufficient to extend the concentration-response curve to levels that reach the regulatory and scientific objective of the test. These concentrations should be selected on a case-by-case basis, preferably based upon an adequately designed range-finding study that provides information regarding the critical endpoint, any irritation threshold, and the time of onset (see paragraphs 11-13). The justification for concentration selection should be provided.

5. Moribund animals or animals obviously in pain or showing signs of severe and enduring distress should be humanely killed. Moribund animals are considered in the same way as animals that die on test. Criteria for making the decision to kill moribund or severely suffering animals, and guidance on the recognition of predictable or impending death, are the subject of an OECD Guidance Document on Humane Endpoints (3).

DESCRIPTION OF THE METHOD**Selection of Animal Species**

6. Healthy young adult rodents of commonly used laboratory strains should be employed. The preferred species is the rat. Justification should be provided if other species are used.

Preparation of Animals

7. Females should be nulliparous and non-pregnant. On the day of randomisation, animals should be young adults 7 to 9 weeks of age. Body weights should be within $\pm 20\%$ of the mean weight for each sex. The animals are randomly selected, marked for individual identification, and kept in their cages for at least 5 days prior to the start of the test to allow for acclimatisation to laboratory conditions.

Animal Husbandry

8. Animals should be individually identified, if possible with subcutaneous transponders, to facilitate observations and avoid confusion. The temperature of the experimental animal maintenance room should be 22 ± 3 °C. The relative humidity should ideally be maintained in the range of 30 to 70 %, though this may not be possible when using water as a vehicle. Before and after exposures, animals generally should be caged in groups by sex and concentration, but the number of animals per cage should not interfere with clear observation of each animal and should minimise losses due to cannibalism and fighting. When animals are to be exposed nose-only, it may be necessary for them to be acclimated to the restraining tubes. The restraining tubes should not impose undue physical, thermal, or immobilisation stress on the animals. Restraint may affect physiological endpoints such as body temperature (hyperthermia) and/or respiratory minute volume. If generic data are available to show that no such changes occur to any appreciable extent, then pre-adaptation to the restraining tubes is not necessary. Animals exposed whole-body to an aerosol should be housed individually during exposure to prevent them from filtering the test aerosol through the fur of their cage mates. Conventional and certified laboratory diets may be used, except during exposure, accompanied with an unlimited supply of municipal drinking water. Lighting should be artificial, the sequence being 12 hours light/12 hours dark.

▼ M4**Inhalation Chambers**

9. The nature of the test chemical and the object of the test should be considered when selecting an inhalation chamber. The preferred mode of exposure is nose-only (which term includes head-only, nose-only, or snout-only). Nose-only exposure is generally preferred for studies of liquid or solid aerosols and for vapours that may condense to form aerosols. Special objectives of the study may be better achieved by using a whole-body mode of exposure, but this should be justified in the study report. To ensure atmosphere stability when using a whole-body chamber, the total 'volume' of the test animals should not exceed 5 % of the chamber volume. Principles of the nose-only and whole-body exposure techniques and their particular advantages and disadvantages are addressed in GD 39 (2).

TOXICITY STUDIES

Limit Concentrations

10. Unlike with acute studies, there are no defined limit concentrations in 28-day sub-acute inhalation toxicity studies. The maximum concentration tested should consider: (1) the maximum attainable concentration, (2) the 'worst case' human exposure level, (3) the need to maintain an adequate oxygen supply, and/or (4) animal welfare considerations. In the absence of data-based limits, the acute limits of the Regulation (EC) No 1272/2008 (13) may be used (i.e. up to a maximum concentration of 5 mg/l for aerosols, 20 mg/l for vapours and 20 000 ppm for gases); refer to GD 39 (2). Justification should be provided if it is necessary to exceed these limits when testing gases or highly volatile test chemicals (e.g. refrigerants). The limit concentration should elicit unequivocal toxicity without causing undue stress to the animals or affecting their longevity (3).

Range-Finding Study

11. Before commencing with the main study, it may be necessary to perform a range-finding study. A range-finding study is more comprehensive than a sighting study because it is not limited to concentration selection. Knowledge learned from a range-finding study can lead to a successful main study. A range-finding study may, for example, provide technical information regarding analytical methods, particle sizing, discovery of toxic mechanisms, clinical pathology and histopathological data, and estimations of what may be NOAEL and MTC concentrations in a main study. The study director may choose to use the range-finding study to identify the threshold of respiratory tract irritation (e.g. with histopathology of the respiratory tract, pulmonary function testing, or bronchoalveolar lavage), the upper concentration which is tolerated without undue stress to the animals, and the parameters that will best characterise a test chemical's toxicity.
12. A range-finding study may consist of one or more concentration levels. No more than three males and three females should be exposed at each concentration level. A range-finding study should last a minimum of 5 days and generally no more than 14 days. The rationale for the selection of concentrations for the main study should be provided in the study report. The objective of the main study is to demonstrate a concentration-response relationship based on what is anticipated to be the most sensitive endpoint. The low concentration should ideally be a no-observed-adverse effect concentration while the high concentration should elicit unequivocal toxicity without causing undue stress to the animals or affecting their longevity (3).

▼ M4

13. When selecting concentration levels for the range-finding study, all available information should be considered including structure-activity relationships and data for similar chemicals (see paragraph 3). A range-finding study may verify/refute what are considered to be the most sensitive mechanistically based endpoints, e.g. cholinesterase inhibition by organophosphates, methaemoglobin formation by erythrocytotoxic agents, thyroidal hormones (T₃, T₄) for thyrotoxicants, protein, LDH, or neutrophils in bronchoalveolar lavage for innocuous poorly soluble particles or pulmonary irritant aerosols.

Main Study

14. The main sub-acute toxicity study generally consists of three concentration levels, and also concurrent negative (air) and/or vehicle controls as needed (see paragraph 17). All available data should be utilised to aid selection of appropriate exposure levels, including the results of systemic toxicity studies, metabolism and kinetics (particular emphasis should be given to avoiding high concentration levels which saturate kinetic processes). Each test group contains at least 10 rodents (5 male and 5 female) that are exposed to the test chemical for 6 hours per day on a 5 day per week basis for a period of 4 weeks (total study duration of 28 days). Animals may also be exposed 7 days per week (e.g. when testing inhaled pharmaceuticals). If one sex is known to be more susceptible to a given test chemical, the sexes may be exposed at different concentration levels in order to optimise the concentration-response as described in paragraph 15. If rodent species other than rats are exposed nose-only, maximum exposure durations may be adjusted to minimise species-specific distress. A rationale should be provided when using an exposure duration less than 6 hours/day, or when it is necessary to conduct a long duration (e.g. 22 hours/day) whole-body exposure study [refer to GD 39 (2)]. Feed should be withheld during the exposure period unless exposure exceeds 6 hours. Water may be provided throughout a whole-body exposure.

15. The target concentrations selected should identify the target organ(s) and demonstrate a clear concentration-response:

- The high concentration level should result in toxic effects but not cause lingering signs or lethality which would prevent a meaningful evaluation.
- The intermediate concentration level(s) should be spaced to produce a gradation of toxic effects between that of the low and high concentration.
- The low concentration level should produce little or no evidence of toxicity.

Satellite (Reversibility) Study

16. A satellite (reversibility) study may be used to observe reversibility, persistence, or delayed occurrence of toxicity for a post-treatment period of an appropriate length, but no less than 14 days. Satellite (reversibility) groups consist of five males and five females exposed contemporaneously with the experimental animals in the main study. Satellite (reversibility) study groups should be exposed to the test chemical at the highest concentration level and there should be concurrent air and/or vehicle controls as needed (see paragraph 17).

▼M4**Control Animals**

17. Concurrent negative (air) control animals should be handled in a manner identical to the test group animals except that they are exposed to filtered air rather than test chemical. When water or another substance is used to assist in generating the test atmosphere, a vehicle control group, instead of a negative (air) control group, should be included in the study. Water should be used as the vehicle whenever possible. When water is used as the vehicle, the control animals should be exposed to air with the same relative humidity as the exposed groups. The selection of a suitable vehicle should be based on an appropriately conducted pre-study or historical data. If a vehicle's toxicity is not well known, the study director may choose to use both a negative (air) control and a vehicle control, but this is strongly discouraged. If historical data reveal that a vehicle is non-toxic, then there is no need for a negative (air) control group and only a vehicle control should be used. If a pre-study of a test chemical formulated in a vehicle reveals no toxicity, it follows that the vehicle is non-toxic at the concentration tested and this vehicle control should be used.

EXPOSURE CONDITIONS**Administration of Concentrations**

18. Animals are exposed to the test chemical as a gas, vapour, aerosol, or a mixture thereof. The physical state to be tested depends on the physico-chemical properties of the test chemical, the selected concentration, and/or the physical form most likely present during the handling and use of the test chemical. Hygroscopic and chemically reactive test chemicals should be tested under dry air conditions. Care should be taken to avoid generating explosive concentrations. Particulate material may be subjected to mechanical processes to decrease the particle size. Further guidance is provided in GD 39 (2).

Particle-Size Distribution

19. Particle sizing should be performed for all aerosols and for vapours that may condense to form aerosols. To allow for exposure of all relevant regions of the respiratory tract, aerosols with mass median aerodynamic diameters (MMAD) ranging from 1 to 3 μm with a geometric standard deviation (σ_g) in the range of 1,5 to 3,0 are recommended (4). Although a reasonable effort should be made to meet this standard, expert judgement should be provided if it cannot be achieved. For example, metal fume particles may be smaller than this standard, and charged particles and fibres may exceed it.

Test chemical Preparation in a Vehicle

20. Ideally, the test chemical should be tested without a vehicle. If it is necessary to use a vehicle to generate an appropriate test chemical concentration and particle size, water should be given preference. Whenever a test chemical is dissolved in a vehicle, its stability should be demonstrated.

MONITORING OF EXPOSURE CONDITIONS**Chamber Airflow**

21. The flow of air through the exposure chamber should be carefully controlled, continuously monitored, and recorded at least hourly during each exposure. The real-time monitoring of the test atmosphere concentration (or temporal stability) is an integral measurement of all dynamic parameters and provides an indirect means to control all relevant dynamic inhalation parameters. If the concentration is monitored real-time, the frequency of measurement of air flows may be reduced to one single

▼ M4

measurement per exposure per day. Special consideration should be given to avoiding re-breathing in nose-only chambers. Oxygen concentration should be at least 19 % and carbon dioxide concentration should not exceed 1 %. If there is reason to believe that this standard cannot be met, oxygen and carbon dioxide concentrations should be measured. If measurements on the first day of exposure show that these gases are at proper levels, no further measurements should be necessary.

Chamber Temperature and Relative Humidity

22. Chamber temperature should be maintained at 22 ± 3 °C. Relative humidity in the animals' breathing zone, for both nose-only and whole-body exposures, should be monitored continuously and recorded hourly during each exposure where possible. The relative humidity should preferably be maintained in the range of 30 to 70 %, but this may either be unattainable (e.g. when testing water based mixtures) or not measurable due to test chemical interference with the Test Method.

Test chemical: Nominal Concentration

23. Whenever feasible, the nominal exposure chamber concentration should be calculated and recorded. The nominal concentration is the mass of generated test chemical divided by the total volume of air passed through the inhalation chamber system. The nominal concentration is not used to characterise the animals' exposure, but a comparison of the nominal concentration and the actual concentration gives an indication of the generation efficiency of the test system, and thus may be used to discover generation problems.

Test chemical: Actual Concentration

24. The actual concentration is the test chemical concentration as sampled at the animals' breathing zone in an inhalation chamber. Actual concentrations can be obtained either by specific methods (e.g. direct sampling, adsorptive or chemical reactive methods, and subsequent analytical characterisation) or by non-specific methods such as gravimetric filter analysis. The use of gravimetric analysis is acceptable only for single component powder aerosols or aerosols of low volatility liquids and should be supported by appropriate pre-study test chemical-specific characterisations. Multi-component powder aerosol concentration may also be determined by gravimetric analysis. However, this requires analytical data which demonstrate that the composition of airborne material is similar to the starting material. If this information is not available, a reanalysis of the test chemical (ideally in its airborne state) at regular intervals during the course of the study may be necessary. For aerosolised agents that may evaporate or sublimate, it should be shown that all phases were collected by the method chosen.
25. One lot of the test chemical should be used throughout the duration of the study, if possible, and the test sample should be stored under conditions that maintain its purity, homogeneity, and stability. Prior to the start of the study, there should be a characterisation of the test chemical including its purity and, if technically feasible, the identity, and quantities of identified contaminants and impurities. This can be demonstrated but is not limited by the following data: retention time and relative peak area, molecular weight from mass spectroscopy or gas chromatography analyses, or other estimates. Although the test sample's identity is not the responsibility of the test laboratory, it may be prudent for the test laboratory to confirm the sponsor's characterisation at least in a limited way (e.g. colour, physical nature, etc.).

▼ M4

26. The exposure atmosphere should be held as constant as practicable. A real-time monitoring device, such as an aerosol photometer for aerosols or a total hydrocarbon analyser for vapours may be used to demonstrate the stability of the exposure conditions. Actual chamber concentration should be measured at least 3 times during each exposure day for each exposure level. If not feasible due to limited air flow rates or low concentrations, one sample per exposure period is acceptable. Ideally, this sample should then be collected over the entire exposure period. Individual chamber concentration samples should deviate from the mean chamber concentration by no more than $\pm 10\%$ for gases and vapours, and by no more than $\pm 20\%$ for liquid or solid aerosols. Time to attain chamber equilibration (t_{95}) should be calculated and reported. The duration of an exposure spans the time that the test chemical is generated. This takes into account the times required to attain chamber equilibration (t_{95}) and decay. Guidance for estimating t_{95} can be found in GD 39 (2).
27. For very complex mixtures consisting of gases/vapours and aerosols (e.g. combustion atmospheres and test chemicals propelled from purpose-driven end-use products/devices), each phase may behave differently in an inhalation chamber. Therefore, at least one indicator substance (analyte), normally the principal active substance in the mixture, of each phase (gas/vapour and aerosol) should be selected. When the test chemical is a mixture, the analytical concentration should be reported for the total mixture, and not just for the active ingredient or the indicator substance (analyte). Additional information regarding actual concentrations can be found in GD 39 (2).

Test chemical: Particle Size Distribution

28. The particle size distribution of aerosols should be determined at least weekly for each concentration level by using a cascade impactor or an alternative instrument, such as an aerodynamic particle sizer (APS). If equivalence of the results obtained by a cascade impactor and the alternative instrument can be shown, then the alternative instrument may be used throughout the study.
29. A second device, such as a gravimetric filter or an impinger/gas bubbler, should be used in parallel to the primary instrument to confirm the collection efficiency of the primary instrument. The mass concentration obtained by particle size analysis should be within reasonable limits of the mass concentration obtained by filter analysis [see GD 39 (2)]. If equivalence can be demonstrated at all concentrations tested in the early phase of the study, then further confirmatory measurements may be omitted. For the sake of animal welfare, measures should be taken to minimise inconclusive data which may lead to a need to repeat a study.
30. Particle sizing should be performed for vapours if there is any possibility that vapour condensation may result in the formation of an aerosol, or if particles are detected in a vapour atmosphere with potential for mixed phases.

OBSERVATIONS

31. The animals should be clinically observed before, during and after the exposure period. More frequent observations may be indicated depending on the response of the animals during exposure. When animal observation is hindered by the use of animal restraint tubes, poorly lit whole body chambers, or opaque atmospheres, animals should be carefully observed after exposure. Observations before the next day's exposure can assess any reversibility or exacerbation of toxic effects.

▼ M4

32. All observations are recorded with individual records being maintained for each animal. When animals are killed for humane reasons or found dead, the time of death should be recorded as precisely as possible.

33. Cage-side observations should include changes in the skin and fur, eyes, and mucous membranes; changes in the respiratory and circulatory systems, changes in the nervous system, and changes in somatomotor activity and behaviour patterns. Attention should be directed to observations of tremors, convulsions, salivation, diarrhoea, lethargy, sleep, and coma. The measurement of rectal temperatures may provide supportive evidence of reflex bradypnea or hypo/hyperthermia related to treatment or confinement. Additional assessments may be included in the study protocol such as kinetics, biomonitoring, lung function, retention of poorly soluble materials that accumulate in lung tissue, and behavioural changes.

BODY WEIGHTS

34. Individual animal weights should be recorded shortly before the first exposure (day 0), twice weekly thereafter (for example: on Fridays and Mondays to demonstrate recovery over an exposure-free weekend or at a time interval to allow assessment of systemic toxicity), and at the time of death or euthanasia. If there are no effects in the first 2 weeks, body weights may be measured weekly for the remainder of the study. Satellite (reversibility) animals (if used) should continue to be weighed weekly throughout the recovery period. At study termination, all animals should be weighed shortly before sacrifice to allow for an unbiased calculated of organ to body weight ratios.

FOOD AND WATER CONSUMPTION

35. Food consumption should be measured weekly. Water consumption may also be measured.

CLINICAL PATHOLOGY

36. Clinical pathology assessments should be made for all animals, including control and satellite (reversibility) animals, when they are sacrificed. The time interval between the end of exposure and blood collection should be recorded, particularly when the reconstitution of the addressed endpoint is rapid. Sampling following the end of exposure is indicated for those parameters with a short plasma half-time (e.g. COHb, CHE, and Methb).

37. Table 1 lists the clinical pathology parameters that are generally required for all toxicology studies. Urinalysis is not required on a routine basis, but may be performed when deemed useful based on expected or observed toxicity. The study director may choose to assess additional parameters in order to better characterise a test chemical's toxicity (e.g. cholinesterase, lipids, hormones, acid/base balance, methaemoglobin or Heinz bodies, creatine kinase, myeloid/erythroid ratio, troponins, arterial blood gases, lactate dehydrogenase, sorbitol dehydrogenase, glutamate dehydrogenase, and gamma glutamyl transpeptidase).

▼ **M4**

Table 1
Standard Clinical Pathology Parameters

Haematology	
Erythrocyte count	Total leukocyte count
Haematocrit	Differential leukocyte count
Haemoglobin concentration	Platelet count
Mean corpuscular haemoglobin	Clotting potential (select one):
Mean corpuscular volume	— Prothrombin time
Mean corpuscular haemoglobin concentration	— Clotting time
Reticulocytes	— Partial thromboplastin time
Clinical Chemistry	
Glucose (*)	Alanine aminotransferase
Total cholesterol	Aspartate aminotransferase
Triglycerides	Alkaline phosphatase
Blood urea nitrogen	Potassium
Total bilirubin	Sodium
Creatinine	Calcium
Total protein	Phosphorus
Albumin	Chloride
Globulin	
Urinalysis (optional)	
Appearance (colour and turbidity)	Total protein
Volume	Glucose
Specific gravity or osmolality	Blood/blood cells
pH	

(*) Because a lengthy fasting period can introduce bias in glucose measurements for the treated versus control animals, the study director should determine whether it is appropriate to fast the animals. If a fasting period is used, it should be appropriate to the species used; for the rat this may be 16 h (overnight fasting). Determination of fasting glucose may be carried out after overnight fasting during the last exposure week, or after overnight fasting prior to necropsy (in the latter case together with all other clinical pathology parameters).

38. When there is evidence that the lower respiratory tract (i.e., the alveoli) is the primary site of deposition and retention, then bronchoalveolar lavage (BAL) may be the technique of choice to quantitatively analyse hypothesis-based dose-effect parameters focusing on alveolitis, pulmonary inflammation, and phospholipidosis. This allows for dose-response and time-course changes of alveolar injury to be suitably probed. The BAL fluid may be analysed for total and differential leukocyte counts, total protein, and lactate dehydrogenase. Other parameters that may be considered are those indicative of lysosomal injury, phospholipidosis, fibrosis, and irritant or allergic inflammation which may include the determination of pro-inflammatory cytokines/chemokines. BAL measurements generally complement the results from histopathology examinations but cannot replace them. Guidance on how to perform lung lavage can be found in GD 39 (2).

▼ **M4****GROSS PATHOLOGY AND ORGAN WEIGHTS**

39. All test animals, including those which die during the test or are removed from the study for animal welfare reasons, should be subjected to complete exsanguination (if feasible) and gross necropsy. The time between the end of each animal's last exposure and their sacrifice should be recorded. If a necropsy cannot be performed immediately after a dead animal is discovered, the animal should be refrigerated (not frozen) at a temperature low enough to minimise autolysis. Necropsies should be performed as soon as possible, normally within a day or two. All gross pathological changes should be recorded for each animal with particular attention to any changes in the respiratory tract.
40. Table 2 lists the organs and tissues that should be preserved in a suitable medium during gross necropsy for histopathological examination. The preservation of the [bracketed] organs and tissues and any other organs and tissues is at the discretion of the study director. The **bolded** organs should be trimmed and weighed wet as soon as possible after dissection to avoid drying. The thyroid and epididymides should only be weighed if needed because trimming artefacts may hinder histopathological evaluation. Tissues and organs should be fixed in 10 % buffered formalin or another suitable fixative as soon as necropsy is performed, and no less than 24-48 hours prior to trimming depending on the fixative to be used.

*Table 2***Organs and Tissues Preserved During Gross Necropsy**

Adrenals	Seminal vesicles
Bone marrow (and/or fresh aspirate)	Spinal cord (cervical, mid-thoracic, and lumbar)
Brain (including sections of cerebrum, cerebellum, and medulla/pons)	Spleen
[Eyes (retina, optic nerve) and eyelids]	Stomach
Heart	Testes
Kidneys	Thymus
Larynx (3 levels, 1 level to include the base of the epiglottis)	Thyroid
Liver	Trachea (at least 2 levels including 1 longitudinal section through the carina and 1 transverse section)
Lung (all lobes at one level, including main bronchi)	[Urinary bladder]
Lymph nodes from the hilar region of the lung, especially for poorly soluble particulate test chemicals. For more in depth examinations and/or studies with immunological focus, additional lymph nodes may be considered, e.g. those from the mediastinal, cervical/submandibular and/or auricular regions.	Uterus
Nasopharyngeal tissues (at least 4 levels; 1 level to include the nasopharyngeal duct and the Nasal Associated Lymphoid Tissue(NALT))	All gross lesions
Oesophagus	
[Olfactory bulb]	
Ovaries	

▼M4

41. The lungs should be removed intact, weighed, and instilled with a suitable fixative at a pressure of 20-30 cm of water to ensure that lung structure is maintained (5). Sections should be collected for all lobes at one level, including main bronchi, but if lung lavage is performed, the unlavaged lobe should be sectioned at three levels (not serial sections).
42. At least 4 levels of the nasopharyngeal tissues should be examined, one of which should include the nasopharyngeal duct, (5, 6, 7, 8, 9) to allow adequate examination of the squamous, transitional (non-ciliated respiratory), respiratory (ciliated respiratory) and olfactory epithelium, and the draining lymphatic tissue (NALT; 10, 11). Three levels of the larynx should be examined, and one of these levels should include the base of the epiglottis (12). At least two levels of the trachea should be examined including one longitudinal section through the carina of the bifurcation of the extrapulmonary bronchi and one transverse section.

HISTOPATHOLOGY

43. A histopathological evaluation of all the organs and tissues listed in Table 2 should be performed for the control and high concentration groups, and for all animals which die or are sacrificed during the study. Particular attention should be paid to the respiratory tract, target organs, and gross lesions. The organs and tissues that have lesions in the high concentration group should be examined in all groups. The study director may choose to perform histopathological evaluations for additional groups to demonstrate a clear concentration response. When a satellite (reversibility) group is used, histopathological evaluation should be performed for all tissues and organs identified as showing effects in the treated groups. If there are excessive early deaths or other problems in the high exposure group that compromise the significance of the data, the next lower concentration should be examined histopathologically. An attempt should be made to correlate gross observations with microscopic findings.

DATA AND REPORTING**Data**

44. Individual animal data on body weights, food consumption, clinical pathology, gross pathology, organ weights, and histopathology should be provided. Clinical observation data should be summarised in tabular form showing for each test group the number of animals used, the number of animals displaying specific signs of toxicity, the number of animals found dead during the test or killed for humane reasons, time of death of individual animals, a description and time course of toxic effects and reversibility, and necropsy findings. All results, quantitative and incidental, should be evaluated by an appropriate statistical method. Any generally accepted statistical method may be used and the statistical methods should be selected during the design of the study.

Test Report

45. The test report should include the following information, as appropriate:

Test animals and husbandry

- Description of caging conditions, including: number (or change in number) of animals per cage, bedding material, ambient temperature and relative humidity, photoperiod, and identification of diet.

▼ M4

- Species/strain used and justification for using a species other than the rat. Source and historical data may be provided, if they are from animals exposed under similar exposure, housing, and fasting conditions.
- Number, age, and sex of animals.
- Method of randomisation.
- Description of any pre-test conditioning including diet, quarantine, and treatment for disease.

Test chemical

- Physical nature, purity, and, where relevant, physico-chemical properties (including isomerisation).
- Identification data and Chemical Abstract Services (CAS) Registry Number, if known.

Vehicle

- Justification for use of vehicle and justification for choice of vehicle (if other than water).
- Historical or concurrent data demonstrating that the vehicle does not interfere with the outcome of the study.

Inhalation chamber

- Detailed description of the inhalation chamber including volume and a diagram.
- Source and description of equipment used for the exposure of animals as well as generation of the atmosphere.
- Equipment for measuring temperature, humidity, particle-size, and actual concentration.
- Source of air and system used for conditioning.
- Methods used for calibration of equipment to ensure a homogeneous test atmosphere.
- Pressure difference (positive or negative).
- Exposure ports per chamber (nose-only); location of animals in the chamber (whole-body).
- Stability of the test atmosphere.
- Location of temperature and humidity sensors and sampling of test atmosphere in the chamber.
- Treatment of air supplied/extracted.
- Air flow rates, air flow rate/exposure port (nose-only), or animal load/chamber (whole-body).
- Time to inhalation chamber equilibrium (t_{95}).
- Number of volume changes per hour.
- Metering devices (if applicable).

Exposure data

- Rationale for target concentration selection in the main study.

▼ M4

- Nominal concentrations (total mass of test chemical generated into the inhalation chamber divided by the volume of air passed through the chamber).
- Actual test chemical concentrations collected from the animals' breathing zone; for mixtures that produce heterogeneous physical forms (gases, vapours, aerosols), each may be analysed separately.
- All air concentrations should be reported in units of mass (mg/l mg/m³, etc.) rather than in units of volume (ppm, ppb, etc.).
- Particle size distribution, mass median aerodynamic diameter (MMAD), and geometric standard deviation (σ_g), including their methods of calculation. Individual particle size analyses should be reported.

Test conditions

- Details of test chemical preparation, including details of any procedures used to reduce the particle size of solids or to prepare solutions of the test chemical.
- A description (preferably including a diagram) of the equipment used to generate the test atmosphere and to expose the animals to the test atmosphere.
- Details of the equipment used to monitor chamber temperature, humidity, and chamber airflow (i.e. development of a calibration curve).
- Details of the equipment used to collect samples for determination of chamber concentration and particle size distribution.
- Details of the chemical analytical method used and method validation (including efficiency of recovery of test chemical from the sampling medium).
- Method of randomisation in assigning animals to test and control groups.
- Details of food and water quality (including diet type/source, water source).
- The rationale for the selection of test concentrations.

Results

- Tabulation of chamber temperature, humidity, and airflow.
- Tabulation of chamber nominal and actual concentration data.
- Tabulation of particle size data including analytical sample collection data, particle size distribution, and calculations of the MMAD and σ_g .
- Tabulation of response data and concentration level for each animal (i.e. animals showing signs of toxicity including mortality, nature, severity, time of onset, and duration of effects).

▼M4

- Tabulation of individual animal weights.
- Tabulation of food consumption
- Tabulation of clinical pathology data
- Necropsy findings and histopathological findings for each animal, if available.
- Tabulation of any other parameters measured

Discussion and interpretation of results

- Particular emphasis should be made to the description of methods used to meet the criteria of this Test Method, e.g. the limit concentration or the particle size.
- The respirability of particles in light of the overall findings should be addressed, especially if the particle-size criteria could not be met.
- The consistency of methods used to determine nominal and actual concentrations, and the relation of actual concentration to nominal concentration should be included in the overall assessment of the study.
- The likely cause of death and predominant mode of action (systemic versus local) should be addressed.
- An explanation should be provided if there was a need to humanely sacrifice animals in pain or showing signs of severe and enduring distress, based on the criteria in the OECD Guidance Document on Humane Endpoints (3).
- The target organ(s) should be identified.
- The NOAEL and LOAEL should be determined.

LITERATURE:

- (1) OECD (1981). Subchronic Inhalation Toxicity Testing, Original Test Guideline No 412, Environment Directorate, OECD, Paris.
- (2) OECD (2009). Guidance Document on Acute Inhalation Toxicity Testing, Environmental Health and Safety Monograph Series on Testing and Assessment No 39, ENV/JM/MONO(2009)28, OECD, Paris.
- (3) OECD (2000). Guidance Document on the Recognition, Assessment and Use of Clinical Signs as Humane Endpoints for Experimental Animals Used in Safety Evaluation, Environmental Health and Safety Monograph Series on Testing and Assessment No 19, ENV/JM/MONO(2000)7, OECD, Paris.
- (4) Whalan JE and Redden JC (1994). Interim Policy for Particle Size and Limit Concentration Issues in Inhalation Toxicity Studies. Office of Pesticide Programs, United States Environmental Protection Agency.
- (5) Dungworth DL, Tyler WS, Plopper CE (1985). Morphological Methods for Gross and Microscopic Pathology (Chapter 9) in Toxicology of Inhaled Material, Witschi, H.P. and Brain, J.D. (eds), Springer Verlag Heidelberg, pp. 229-258.
- (6) Young JT (1981). Histopathological examination of the rat nasal cavity. Fundam. Appl. Toxicol. 1: 309-312.
- (7) Harkema JR (1990). Comparative pathology of the nasal mucosa in laboratory animals exposed to inhaled irritants. Environ. Health Perspect. 85: 231-238.

▼M4

- (8) Woutersen RA, Garderen-Hoetmer A, van Slootweg PJ, Feron VJ (1994). Upper respiratory tract carcinogenesis in experimental animals and in humans. In: Waalkes MP and Ward JM (eds) *Carcinogenesis. Target Organ Toxicology Series*, Raven Press, New York, 215-263.
- (9) Mery S, Gross EA, Joyner DR, Godo M, Morgan KT (1994). Nasal diagrams: A tool for recording the distribution of nasal lesions in rats and mice. *Toxicol. Pathol.* 22: 353-372.
- (10) Kuper CF, Koornstra PJ, Hameleers DMH, Biewenga J, Spit BJ, Duijvestijn AM, Breda Vriesman van PJC, Sminia T (1992). The role of nasopharyngeal lymphoid tissue. *Immunol. Today* 13: 219-224.
- (11) Kuper CF, Arts JHE, Feron VJ (2003). Toxicity to nasal-associated lymphoid tissue. *Toxicol. Lett.* 140-141: 281-285.
- (12) Lewis DJ (1981). Mitotic Indices of Rat Laryngeal Epithelia. *Journal of Anatomy* 132(3): 419-428.
- (13) Regulation (EC) No 1272/2008 of the European Parliament and of the Council of 16 December 2008 on classification, labelling and packaging of substances and mixtures, amending and repealing Directives 67/548/EEC and 1999/45/EC, and amending Regulation (EC) No 1907/2006 (OJ L 353, 31.12.2008, p. 1).

▼ M4

Appendix 1

DEFINITION

Test chemical: Any substance or mixture tested using this Test Method.

▼B**B.9. REPEATED DOSE (28 DAYS) TOXICITY (DERMAL)****1. METHOD****1.1. INTRODUCTION**

See General introduction Part B (A).

1.2. DEFINITIONS

See General introduction Part B (B).

1.3. REFERENCE SUBSTANCES

None.

1.4. PRINCIPLE OF THE TEST METHOD

The test substance is applied daily to the skin in graduated doses to several groups of experimental animals, one dose per group, for a period of 28 days. During the period of application, the animals are observed daily to detect signs of toxicity. Animals, which die during the test, are necropsied and at the conclusion of the test surviving animals are necropsied.

1.5. QUALITY CRITERIA

None.

1.6. DESCRIPTION OF THE TEST METHOD**1.6.1. Preparations**

The animals are kept under the experimental housing and feeding conditions for at least five days prior to the test. Before the test, healthy young animals are randomised and assigned to the treatment and control groups. Shortly before testing, fur is clipped from the dorsal area of the trunk of the test animals. Shaving may be employed but it should be carried out approximately 24 hours before the test. Repeat clipping or shaving is usually needed at approximately weekly intervals. When clipping or shaving the fur, care must be taken to avoid abrading the skin. Not less than 10 % of the body surface area should be clear for the application of the test substance. The weight of the animal should be taken into account when deciding on the area to be cleared and on the dimensions of the covering. When testing solids, which may be pulverised if appropriate, the test substance should be moistened sufficiently with water or, where necessary, a suitable vehicle to ensure good contact with the skin. Liquid test substances are generally used undiluted. Daily application on a five to seven-day per week basis is used.

1.6.2. Test conditions**1.6.2.1. *Experimental animals***

The adult rat, rabbit or guinea-pig may be used. Other species may be used but their use would require justification.

▼B

At the commencement of the study, the range of weight variation in the animals used should not exceed $\pm 20\%$ of the appropriate mean value.

1.6.2.2. *Number and sex*

At least 10 animals (five female and five male) with healthy skin should be used at each dose level. The females should be nulliparous and non-pregnant. If interim sacrifices are planned, the numbers should be increased by the number of animals scheduled to be sacrificed before the completion of the study. In addition, a satellite group of 10 animals (five animals per sex) may be treated with the high dose level for 28 days and observed for reversibility, persistence, or delayed occurrence of toxic effects for 14 days post-treatment. A satellite group of 10 control animals (five animals per sex) is also used.

1.6.2.3. *Dose levels*

At least three dose levels are required with a control or a vehicle control if a vehicle is used. The exposure period should be at least six hours per day. The application of the test substance should be made at similar times each day, and adjusted at intervals (weekly or bi-weekly) to maintain a constant dose level in terms of animal body-weight. Except for treatment with the test substance, animals in the control group should be handled in an identical manner to the test group subjects. Where a vehicle is used to facilitate dosing, the vehicle control group should be dosed in the same way as the treated groups, and receive the same amount as that received by the highest dose level group. The highest dose level should result in toxic effects but produce no, or few, fatalities. The lowest dose level should not produce any evidence of toxicity. Where there is a usable estimation of human exposure, the lowest level should exceed this. Ideally, the intermediate dose level should produce minimal observable toxic effects. If more than one intermediate dose is used the dose levels should be spaced to produce a gradation of toxic effects. In the low and intermediate groups and in the controls, the incidence of fatalities should be low in order to permit a meaningful evaluation of the results.

If application of the test substance produces severe skin irritation, the concentrations should be reduced and this may result in a reduction in, or absence of, other toxic effects at the high dose level. Moreover if the skin has been badly damaged it may be necessary to terminate the study and undertake a new study at lower concentrations.

1.6.2.4. *Limit test*

If a preliminary study at a dose level of 1 000 mg/kg, or a higher dose level related to possible human exposure where this is known, produces no toxic effects, further testing may not be considered necessary.

1.6.2.5. *Observation period*

The experimental animals should be observed daily for signs of toxicity. The time of death and the time at which signs of toxicity appear and disappear should be recorded.

▼B**1.6.3. Procedure**

Animals should be caged individually. The animals are treated with the test substance, ideally on seven days per week, for a period of 28 days. Animals in any satellite groups scheduled for follow-up observations should be kept for a further 14 days without treatment to detect recovery from or persistence of toxic effects. Exposure time should be at least six hours per day.

The test substance should be applied uniformly over an area, which is approximately 10 % of the total body surface area. With highly toxic substances, the surface area covered may be less but as much of the area as possible should be covered with as thin and uniform a layer as possible.

During exposure the test substance is held in contact with the skin with porous gauze dressing and non-irritating tape. The test site should be further covered in a suitable manner to retain the gauze dressing and test substance and ensure that the animals cannot ingest the test substance. Restrainers may be used to prevent the ingestion of the test substance but complete immobilisation is not a recommended method. As an alternative a 'collar protective device' may be used.

At the end of the exposure period, residual test substance should be removed, where practicable, using water or some other appropriate method of cleansing the skin.

All the animals should be observed daily and signs of toxicity recorded including the time of onset, their degree and duration. Observations should include changes in skin and fur, eyes and mucous membranes as well as respiratory, circulatory, autonomic and central nervous systems, somatomotor activity and behaviour pattern. Measurements should be made weekly of the animals' weight. It is also recommended that food consumption is measured weekly. Regular observation of the animals is necessary to ensure that animals are not lost from the study due to causes such as cannibalism, autolysis of tissues or misplacement. At the end of the study period, all survivors in the non-satellite treatment groups are necropsied. Moribund animals and animals in severe distress or pain should be removed when noticed, humanely killed and necropsied.

The following examinations shall be made at the end of the test on all animals including the controls:

- (1) haematology, including at least haematocrit, haemoglobin concentration, erythrocyte count, total and differential leucocyte count, and a measure of clotting potential;
- (2) clinical blood biochemistry including at least one parameter of liver and kidney function: serum alanine aminotransferase (formerly known as glutamic pyruvic transaminase), serum aspartate aminotransferase (formerly known as glutamic oxaloacetic transaminase), urea nitrogen, albumin, blood creatinine, total bilirubin and total serum protein;

Other determinations which may be necessary for an adequate toxicological evaluation include calcium, phosphorus, chloride, sodium, potassium, fasting glucose, analysis of lipids, hormones, acid/base balance, methaemoglobin and cholinesterase activity.

▼B

Additional clinical biochemistry may be employed, where necessary, to extend the investigation of observed effects.

1.6.4. Gross necropsy

All animals in the study should be subjected to a full gross necropsy. At least the liver, kidneys, adrenals, and testes should be weighed wet as soon as possible after dissection, to avoid drying. Organs and tissues, i.e. normal and treated skin, liver, kidney, spleen, testes, adrenals, heart, and target organs (that is those organs showing gross lesions or changes in size) should be preserved in a suitable medium for possible future histopathological examination.

1.6.5. Histopathological examination

In the high dose group and in the control group, histological examination should be performed on the preserved organs and tissues. Organs and tissues showing defects attributable to the test substance at the highest dosage level should be examined in all lower-dosage groups. Animals in the satellite group should be examined histologically with particular emphasis on those organs and tissues identified as showing effects in the other treated groups.

2. DATA

Data should be summarised in tabular form, showing for each test group the number of animals at the start of the test and the number of animals displaying each type of lesion.

All observed results should be evaluated by an appropriate statistical method. Any recognised statistical method may be used.

3. REPORTING**3.1. TEST REPORT**

The test report shall, if possible, include the following information:

- animal data (species, strain, source, environmental conditions, diet, etc.),
- test conditions (including the type of dressing: occlusive or not-occlusive),
- dose levels (including vehicle, if used) and concentrations,
- no-effect level, where possible,
- toxic response data by sex and dose,
- time of death during the study or whether animals survived to termination,
- toxic or other effects,
- the time of observation of each abnormal sign and its subsequent course,
- food and body-weight data,
- haematological tests employed and results,

▼B

- clinical biochemistry tests employed and results,
- necropsy findings,
- a detailed description of all histopathological findings,
- statistical treatment of results where possible,
- discussion of the results,
- interpretation of the results.

3.2. **EVALUATION AND INTERPRETATION**

See General introduction Part B (D).

4. **REFERENCES**

See General introduction Part B (E).

▼ M7**B.10. IN VITRO MAMMALIAN CHROMOSOMAL ABERRATION TEST****INTRODUCTION**

This test method is equivalent to OECD test guideline 473 (2016). It is part of a series of test methods on genetic toxicology. An OECD document that provides succinct information on genetic toxicology testing and an overview of the recent changes that were made to these Test Guidelines has been developed (1).

The purpose of the *in vitro* chromosomal aberration test is to identify chemicals that cause structural chromosomal aberrations in cultured mammalian cells (2) (3) (4). Structural aberrations may be of two types, chromosome or chromatid. Polyploidy (including endoreduplication) could arise in chromosome aberration assays *in vitro*. While aneuploidy can induce polyploidy, polyploidy alone does not indicate aneuploid potential and can simply indicate cell cycle perturbation or cytotoxicity (5). This test is not designed to measure aneuploidy. An *in vitro* micronucleus test (6) would be recommended for the detection of aneuploidy.

The *in vitro* chromosomal aberration test may employ cultures of established cell lines or primary cell cultures of human or rodent origin. The cells used should be selected on the basis of growth ability in culture, stability of the karyotype (including chromosome number) and spontaneous frequency of chromosomal aberrations (7). At the present time, the available data do not allow firm recommendations to be made but suggest it is important, when evaluating chemical hazards to consider the *p53* status, genetic (karyotype) stability, DNA repair capacity and origin (rodent *versus* human) of the cells chosen for testing. The users of this test method are thus encouraged to consider the influence of these and other cell characteristics on the performance of a cell line in detecting the induction of chromosomal aberrations, as knowledge evolves in this area.

Definitions used are provided in Appendix 1.

INITIAL CONSIDERATIONS AND LIMITATIONS

Tests conducted *in vitro* generally require the use of an exogenous source of metabolic activation unless the cells are metabolically competent with respect to the test chemicals. The exogenous metabolic activation system does not entirely mimic *in vivo* conditions. Care should be taken to avoid conditions that could lead to artifactual positive results, *i.e.* chromosome damage not caused by direct interaction between the test chemicals and chromosomes; such conditions include changes in pH or osmolality (8) (9) (10), interaction with the medium components (11) (12) or excessive levels of cytotoxicity (13) (14) (15) (16).

This test is used to detect chromosomal aberrations that may result from clastogenic events. The analysis of chromosomal aberration induction should be done using cells in metaphase. It is thus essential that cells should reach mitosis both in treated and in untreated cultures. For manufactured nanomaterials, specific adaptations of this test method may be needed but are not described in this test method.

Before use of the test method on a mixture for generating data for an intended regulatory purpose, it should be considered whether, and if so why, it may provide adequate results for that purpose. Such considerations are not needed, when there is a regulatory requirement for testing of the mixture.

▼ M7**PRINCIPLE OF THE TEST**

Cell cultures of human or other mammalian origin are exposed to the test chemical both with and without an exogenous source of metabolic activation unless cells with an adequate metabolizing capability are used (see paragraph 13). At appropriate predetermined intervals after the start of exposure of cell cultures to the test chemical, they are treated with a metaphase-arresting chemical (e.g. colcemid or colchicine), harvested, stained and metaphase cells are analysed microscopically for the presence of chromatid-type and chromosome-type aberrations.

DESCRIPTION OF THE METHOD**Preparations***Cells*

A variety of cell lines (e.g. Chinese Hamster Ovary (CHO), Chinese Hamster lung V79, Chinese Hamster Lung (CHL)/IU, TK6) or primary cell cultures, including human or other mammalian peripheral blood lymphocytes, can be used (7). The choice of the cell lines used should be scientifically justified. When primary cells are used, for animal welfare reasons, the use of primary cells from human origin should be considered where feasible and sampled in accordance with the human ethical principles and regulations. Human peripheral blood lymphocytes should be obtained from young (approximately 18-35 years of age), non-smoking individuals with no known illness or recent exposures to genotoxic agents (e.g. chemicals, ionizing radiations) at levels that would increase the background incidence of chromosomal aberrations. This would ensure the background incidence of chromosomal aberrations to be low and consistent. The baseline incidence of chromosomal aberrations increases with age and this trend is more marked in females than in males (17) (18). If cells from more than one donor are pooled for use, the number of donors should be specified. It is necessary to demonstrate that the cells have divided from the beginning of treatment with the test chemical to cell sampling. Cell cultures are maintained in an exponential cell growth phase (cell lines) or stimulated to divide (primary cultures of lymphocytes), to expose the cells at different stages of the cell cycle, since the sensitivity of cell stages to the test chemicals may not be known. The primary cells that need to be stimulated with mitogenic agents in order to divide are generally no longer synchronized during exposure to the test chemical (e.g. human lymphocytes after a 48-hour mitogenic stimulation). The use of synchronized cells during treatment is not recommended, but can be acceptable if justified.

Media and culture conditions

Appropriate culture medium and incubation conditions (culture vessels, humidified atmosphere of 5 % CO₂ if appropriate, incubation temperature of 37 °C) should be used for maintaining cultures. Cell lines should be checked routinely for the stability of the modal chromosome number and the absence of *Mycoplasma* contamination (7) (19), and cells should not be used if contaminated or if the modal chromosome number has changed. The normal cell cycle time of cell lines or primary cultures used in the testing laboratory should be established and should be consistent with the published cell characteristics (20).

Preparation of cultures

Cell lines: cells are propagated from stock cultures, seeded in culture medium at a density such that the cells in suspensions or in monolayers will continue to grow exponentially until harvest time (e.g. confluence should be avoided for cells growing in monolayers).

▼ M7

Lymphocytes: whole blood treated with an anti-coagulant (e.g. heparin) or separated lymphocytes are cultured (e.g. for 48 hours for human lymphocytes) in the presence of a mitogen [e.g. phytohaemagglutinin (PHA) for human lymphocytes] in order to induce cell division prior to exposure to the test chemical.

Metabolic activation

Exogenous metabolising systems should be used when employing cells which have inadequate endogenous metabolic capacity. The most commonly used system that is recommended by default, unless otherwise justified, is a co-factor-supplemented post-mitochondrial fraction (S9) prepared from the livers of rodents (generally rats) treated with enzyme-inducing agents such as Aroclor 1254 (21) (22) (23) or a combination of phenobarbital and β -naphthoflavone (24) (25) (26) (27) (28) (29). The latter combination does not conflict with the Stockholm Convention on Persistent Organic Pollutants (30) and has been shown to be as effective as Aroclor 1254 for inducing mixed-function oxidases (24) (25) (26) (28). The S9 fraction typically is used at concentrations ranging from 1 to 2 % (v/v) but may be increased to 10 % (v/v) in the final test medium. The use of products that reduce the mitotic index, especially calcium complexing products (31) should be avoided during treatment. The choice of type and concentration of exogenous metabolic activation system or metabolic inducer employed may be influenced by the class of chemicals being tested.

Test chemical preparation

Solid test chemicals should be prepared in appropriate solvents and diluted, if appropriate, prior to treatment of the cells (see paragraph 23). Liquid test chemicals may be added directly to the test system and/or diluted prior to treatment of the test system. Gaseous or volatile test chemicals should be tested by appropriate modifications to the standard protocols, such as treatment in sealed culture vessels (32) (33) (34). Preparations of the test chemical should be made just prior to treatment unless stability data demonstrate the acceptability of storage.

Test conditions*Solvents*

The solvent should be chosen to optimize the solubility of the test chemicals without adversely impacting the conduct of the assay, e.g. changing cell growth, affecting the integrity of the test chemical, reacting with culture vessels, impairing the metabolic activation system. It is recommended that, wherever possible, the use of an aqueous solvent (or culture medium) should be considered first. Well established solvents are for example water or dimethyl sulfoxide. Generally organic solvents should not exceed 1 % (v/v) and aqueous solvents (saline or water) should not exceed 10 % (v/v) in the final treatment medium. If not well-established solvents are used (e.g. ethanol or acetone), their use should be supported by data indicating their compatibility with the test chemicals, the test system and their lack of genetic toxicity at the concentration used. In the absence of that supporting data, it is important to include untreated controls (see Appendix 1) to demonstrate that no deleterious or clastogenic effects are induced by the chosen solvent.

Measuring cell proliferation and cytotoxicity and choosing treatment concentrations

When determining the highest test chemical concentration, concentrations that have the capability of producing artifactual positive responses, such as those producing excessive cytotoxicity (see paragraph 22), precipitation in the culture

▼ M7

medium (see paragraph 23), or marked changes in pH or osmolality (see paragraph 5), should be avoided. If the test chemical causes a marked change in the pH of the medium at the time of addition, the pH might be adjusted by buffering the final treatment medium so as to avoid artifactual positive results and to maintain appropriate culture conditions.

Measurements of cell proliferation are made to assure that a sufficient number of treated cells have reached mitosis during the test and that the treatments are conducted at appropriate levels of cytotoxicity (see paragraphs 18 and 22). Cytotoxicity should be determined with and without metabolic activation in the main experiment using an appropriate indication of cell death and growth. While the evaluation of cytotoxicity in an initial test may be useful to better define the concentrations to be used in the main experiment, an initial test is not mandatory. If performed, it should not replace the measurement of cytotoxicity in the main experiment.

Relative Population Doubling (RPD) or Relative Increase in Cell Count (RICC) are appropriate methods for the assessment of cytotoxicity in cytogenetic tests (13) (15) (35) (36) (55) (see Appendix 2 for formulas). In case of long-term treatment and sampling times after the beginning of treatment longer than 1,5 normal cell cycle lengths (i.e. longer than 3 cell cycle lengths in total), RPD might underestimate cytotoxicity (37). Under these circumstances RICC might be a better measure or the evaluation of cytotoxicity after 1,5 normal cell cycle lengths would be a helpful estimate using RPD.

For lymphocytes in primary cultures, while the mitotic index (MI) is a measure of cytotoxic/cytostatic effects, it is influenced by the time after treatment it is measured, the mitogen used and possible cell cycle disruption. However, the MI is acceptable because other cytotoxicity measurements may be cumbersome and impractical and may not apply to the target population of lymphocytes growing in response to PHA stimulation.

While RICC and RPD for cell lines and MI for primary culture of lymphocytes are the recommended cytotoxicity parameters, other indicators (e.g. cell integrity, apoptosis, necrosis, cell cycle) could provide useful additional information.

At least three test concentrations (not including the solvent and positive controls) that meet the acceptability criteria (appropriate cytotoxicity, number of cells, etc) should be evaluated. Whatever the types of cells (cell lines or primary cultures of lymphocytes), either replicate or single treated cultures may be used at each concentration tested. While the use of duplicate cultures is advisable, single cultures are also acceptable provided that the same total number of cells are scored for either single or duplicate cultures. The use of single cultures is particularly relevant when more than 3 concentrations are assessed (see paragraph 31). The results obtained in the independent replicate cultures at a given concentration can be pooled for the data analysis (38). For test chemicals demonstrating little or no cytotoxicity, concentration intervals of approximately 2 to 3 fold will usually be appropriate. Where cytotoxicity occurs, the test concentrations selected should cover a range from that producing cytotoxicity as described in paragraph 22 and including concentrations at which there is moderate and little or no cytotoxicity. Many test chemicals exhibit steep concentration response curves and in order to obtain data at low and moderate cytotoxicity or to study the dose response relationship in detail, it will be necessary to

▼ M7

use more closely spaced concentrations and/or more than three concentrations (single cultures or replicates), in particular in situations where a repeat experiment is required (see paragraph 47).

If the maximum concentration is based on cytotoxicity, the highest concentration should aim to achieve 55 ± 5 % cytotoxicity using the recommended cytotoxicity parameters (*i.e.* reduction in RICC and RPD for cell lines and reduction in MI for primary cultures of lymphocytes to 45 ± 5 % of the concurrent negative control). Care should be taken in interpreting positive results only to be found in the higher end of this 55 ± 5 % cytotoxicity range (13).

For poorly soluble test chemicals that are not cytotoxic at concentrations lower than the lowest insoluble concentration, the highest concentration analysed should produce turbidity or a precipitate visible by eye or with the aid of an inverted microscope at the end of the treatment with the test chemical. Even if cytotoxicity occurs above the lowest insoluble concentration, it is advisable to test at only one concentration producing turbidity or with a visible precipitate because artifactual effects may result from the precipitate. At the concentration producing a precipitate, care should be taken to assure that the precipitate does not interfere with the conduct of the test (e.g. staining or scoring). The determination of solubility in the culture medium prior to the experiment may be useful.

If no precipitate or limiting cytotoxicity is observed, the highest test concentration should correspond to 10 mM, 2 mg/ml or 2 µl/ml, whichever is the lowest (39) (40) (41). When the test chemical is not of defined composition, e.g. a substance of unknown or variable composition, complex reaction products or biological material (UVCB) (42), environmental extract etc., the top concentration may need to be higher (e.g. 5 mg/ml), in the absence of sufficient cytotoxicity, to increase the concentration of each of the components. It should be noted however that these requirements may differ for human pharmaceuticals (43).

Controls

Concurrent negative controls (see paragraph 15), consisting of solvent alone in the treatment medium and treated in the same way as the treatment cultures, should be included for every harvest time.

Concurrent positive controls are needed to demonstrate the ability of the laboratory to identify clastogens under the conditions of the test protocol used and the effectiveness of the exogenous metabolic activation system, when applicable. Examples of positive controls are given in the table 1 below. Alternative positive control chemicals can be used, if justified. Because *in vitro* mammalian cell tests for genetic toxicity are sufficiently standardized, the use of positive controls may be confined to a clastogen requiring metabolic activation. Provided it is done concurrently with the non-activated test using the same treatment duration, this single positive control response will demonstrate both the activity of the metabolic activation system and the responsiveness of the test system. Long term treatment (without S9) should however have its own positive control as the treatment duration will differ from the test using metabolic activation. Each positive control should be used at one or more concentrations expected to give reproducible and detectable increases over background in order to demonstrate the sensitivity of the test system (*i.e.* the effects are clear but do not immediately reveal the identity of the coded slides to the reader), and the response should not be compromised by cytotoxicity exceeding the limits specified in the test method.

▼ **M7**

Table 1

Reference chemicals recommended for assessing laboratory proficiency and for selection of positive controls

Category	Chemical	CASRN
1. Clastogens active without metabolic activation		
	Methyl methanesulphonate	66-27-3
	Mitomycin C	50-07-7
	4-Nitroquinoline-N-Oxide	56-57-5
	Cytosine arabinoside	147-94-4
2. Clastogens requiring metabolic activation		
	Benzo(a)pyrene	50-32-8
	Cyclophosphamide	50-18-0

PROCEDURE**Treatment with test chemical**

Proliferating cells are treated with the test chemical in the presence and absence of a metabolic activation system.

Culture harvest time

For thorough evaluation, which would be needed to conclude a negative outcome, all three of the following experimental conditions should be conducted using a short term treatment with and without metabolic activation and long term treatment without metabolic activation (see paragraphs 43, 44 and 45):

- Cells should be exposed to the test chemical without metabolic activation for 3-6 hours, and sampled at a time equivalent to about 1,5 normal cell cycle lengths after the beginning of treatment (18),
- Cells should be exposed to the test chemical with metabolic activation for 3-6 hours, and sampled at a time equivalent to about 1,5 normal cell cycle lengths after the beginning of treatment (18),
- Cells should be continuously exposed without metabolic activation until sampling at a time equivalent to about 1,5 normal cell cycle lengths. Certain chemicals (e.g. nucleoside analogues) may be more readily detected by treatment/sampling times longer than 1,5 normal cell cycle lengths (24).

In the event that any of the above experimental conditions lead to a positive response, it may not be necessary to investigate any of the other treatment regimens.

Chromosome preparation

Cell cultures are treated with colcemid or colchicine usually for one to three hours prior to harvesting. Each cell culture is harvested and processed separately for the preparation of chromosomes. Chromosome preparation involves hypotonic treatment of the cells, fixation and staining. In monolayers, mitotic cells (identifiable as being round and detaching from the surface) may be present

▼M7

at the end of the 3-6 hour treatment. Because these mitotic cells are easily detached, they can be lost when the medium containing the test chemical is removed. If there is evidence for a substantial increase in the number of mitotic cells compared with controls, indicating likely mitotic arrest, then the cells should be collected by centrifugation and added back to cultures, to avoid losing cells that are in mitosis, and at risk for chromosome aberration, at the time of harvest.

Analysis

All slides, including those of the positive and negative controls, should be independently coded before microscopic analysis for chromosomal aberrations. Since fixation procedures often result in a proportion of metaphase cells which have lost chromosomes, the cells scored should, therefore, contain a number of centromeres equal to the modal number ± 2 .

At least 300 well-spread metaphases should be scored per concentration and control to conclude a test chemical as clearly negative (see paragraph 45). The 300 cells should be equally divided among the replicates, when replicate cultures are used. When single cultures are used per concentration (see paragraph 21), at least 300 well spread metaphases should be scored in this single culture. Scoring 300 cells has the advantage of increasing the statistical power of the test and in addition, zero values will be rarely observed (expected to be only 5 %) (44). The number of metaphases scored can be reduced when high numbers of cells with chromosome aberrations are observed and the test chemical considered as clearly positive.

Cells with structural chromosomal aberration(s) including and excluding gaps should be scored. Breaks and gaps are defined in Appendix 1 according to (45) (46). Chromatid- and chromosome-type aberrations should be recorded separately and classified by sub-types (breaks, exchanges). Procedures in use in the laboratory should ensure that analysis of chromosomal aberrations is performed by well-trained scorers and peer-reviewed if appropriate.

Although the purpose of the test is to detect structural chromosomal aberrations, it is important to record polyploidy and endoreduplication frequencies when these events are seen. (See paragraph 2).

Proficiency of the laboratory

In order to establish sufficient experience with the test prior to using it for routine testing, the laboratory should have performed a series of experiments with reference positive chemicals acting via different mechanisms and various negative controls (using various solvents/vehicle). These positive and negative control responses should be consistent with the literature. This is not applicable to laboratories that have experience, *i.e.* that have an historical data base available as defined in paragraph 37.

A selection of positive control chemicals (see Table 1 in paragraph 26) should be investigated with short and long treatments in the absence of metabolic activation, and also with short treatment in the presence of metabolic activation, in order to demonstrate proficiency to detect clastogenic chemicals and determine the effectiveness of the metabolic activation system. A range of concentrations of the selected chemicals should be chosen so as to give reproducible and concentration-related increases above the background in order to demonstrate the sensitivity and dynamic range of the test system.

▼ M7**Historical control data**

The laboratory should establish:

- A historical positive control range and distribution,
- A historical negative (untreated, solvent) control range and distribution.

When first acquiring data for an historical negative control distribution, concurrent negative controls should be consistent with published control data, where they exist. As more experimental data are added to the control distribution, concurrent negative controls should ideally be within the 95 % control limits of that distribution (44) (47). The laboratory's historical negative control database should initially be built with a minimum of 10 experiments but would preferably consist of at least 20 experiments conducted under comparable experimental conditions. Laboratories should use quality control methods, such as control charts (e.g. C-charts or X-bar charts (48)), to identify how variable their positive and negative control data are, and to show that the methodology is 'under control' in their laboratory (44). Further recommendations on how to build and use the historical data (i.e. criteria for inclusion and exclusion of data in historical data and the acceptability criteria for a given experiment) can be found in the literature (47).

Any changes to the experimental protocol should be considered in terms of their consistency with the laboratory's existing historical control databases. Any major inconsistencies should result in the establishment of a new historical control database.

Negative control data should consist of the incidence of cells with chromosome aberrations from a single culture or the sum of replicate cultures as described in paragraph 21. Concurrent negative controls should ideally be within the 95 % control limits of the distribution of the laboratory's historical negative control database (44) (47). Where concurrent negative control data fall outside the 95 % control limits they may be acceptable for inclusion in the historical control distribution as long as these data are not extreme outliers and there is evidence that the test system is 'under control' (see paragraph 37) and evidence of absence of technical or human failure.

DATA AND REPORTING**Presentation of the results**

The percentage of cells with structural chromosomal aberration(s) should be evaluated. Chromatid- and chromosome-type aberrations classified by sub-types (breaks, exchanges) should be listed separately with their numbers and frequencies for experimental and control cultures. Gaps are recorded and reported separately but not included in the total aberration frequency. Percentage of polyploidy and/or endoreduplicated cells are reported when seen.

Concurrent measures of cytotoxicity for all treated, negative and positive control cultures in the main aberration experiment(s) should be recorded.

Individual culture data should be provided. Additionally, all data should be summarised in tabular form.

Acceptability Criteria

Acceptance of a test is based on the following criteria:

- The concurrent negative control is considered acceptable for addition to the laboratory historical negative control database as described in paragraph 39.

▼M7

- Concurrent positive controls (see paragraph 26) should induce responses that are compatible with those generated in the historical positive control data base and produce a statistically significant increase compared with the concurrent negative control.
- Cell proliferation criteria in the solvent control should be fulfilled (paragraphs 17 and 18).
- All three experimental conditions were tested unless one resulted in positive results (see paragraph 28).
- Adequate number of cells and concentrations are analysable (paragraphs 31 and 21).
- The criteria for the selection of top concentration are consistent with those described in paragraphs 22, 23 and 24.

Evaluation and interpretation of results

Providing that all acceptability criteria are fulfilled, a test chemical is considered to be clearly positive if, in any of the experimental conditions examined (see paragraph 28):

- (a) at least one of the test concentrations exhibits a statistically significant increase compared with the concurrent negative control,
- (b) the increase is dose-related when evaluated with an appropriate trend test,
- (c) any of the results are outside the distribution of the historical negative control data (e.g. Poisson-based 95 % control limits; see paragraph 39).

When all of these criteria are met, the test chemical is then considered able to induce chromosomal aberrations in cultured mammalian cells in this test system. Recommendations for the most appropriate statistical methods can be found in the literature (49) (50) (51).

Providing that all acceptability criteria are fulfilled, a test chemical is considered clearly negative if, in all experimental conditions examined (see paragraph 28):

- (a) none of the test concentrations exhibits a statistically significant increase compared with the concurrent negative control,
- (b) there is no concentration-related increase when evaluated with an appropriate trend test,
- (c) all results are inside the distribution of the historical negative control data (e.g. Poisson-based 95 % control limits; see paragraph 39).

The test chemical is then considered unable to induce chromosomal aberrations in cultured mammalian cells in this test system.

There is no requirement for verification of a clearly positive or negative response.

In case the response is neither clearly negative nor clearly positive as described above or in order to assist in establishing the biological relevance of a result, the data should be evaluated by expert judgement and/or further investigations. Scoring additional cells (where appropriate) or performing a repeat experiment possibly using modified experimental conditions (e.g. concentration spacing, other metabolic activation conditions (i.e. S9 concentration or S9 origin)) could be useful.

In rare cases, even after further investigations, the data set will preclude making a conclusion of positive or negative results, and therefore the test chemical response will be concluded to be equivocal.

▼M7

An increase in the number of polyploid cells may indicate that the test chemicals have the potential to inhibit mitotic processes and to induce numerical chromosomal aberrations (52). An increase in the number of cells with endoreduplicated chromosomes may indicate that the test chemicals have the potential to inhibit cell cycle progress (53) (54) (see paragraph 2). Therefore, incidence of polyploid cells and cells with endoreduplicated chromosomes should be recorded separately.

Test report

The test report should include the following information:

Test chemical:

- source, lot number, limit date for use, if available
- stability of the test chemical itself, if known;
- solubility and stability of the test chemical in solvent, if known.
- measurement of pH, osmolality and precipitate in the culture medium to which the test chemical was added, as appropriate.

Mono-constituent substance:

- physical appearance, water solubility, and additional relevant physico-chemical properties;
- chemical identification, such as IUPAC or CAS name, CAS number, SMILES or InChI code, structural formula, purity, chemical identity of impurities as appropriate and practically feasible, etc.

Multi-constituent substance, UVCBs and mixtures:

- characterised as far as possible by chemical identity (see above), quantitative occurrence and relevant physicochemical properties of the constituents.

Solvent:

- justification for choice of solvent.
- percentage of solvent in the final culture medium should also be indicated.

Cells:

- type and source of cells
- karyotype features and suitability of the cell type used;
- absence of mycoplasma, for cell lines;
- for cell lines, information on cell cycle length, doubling time or proliferation index;
- sex of blood donors, age and any relevant information on the donor, whole blood or separated lymphocytes, mitogen used;
- number of passages, if available, for cell lines;
- methods for maintenance of cell cultures, for cell lines;
- modal number of chromosomes, for cell lines.

▼M7*Test conditions:*

- identity of the metaphase-arresting chemical, its concentration and duration of cell exposure;
- concentration of test chemical expressed as final concentration in the culture medium (e.g. µg or mg/mL or mM of culture medium).
- rationale for selection of concentrations and number of cultures including, e.g. cytotoxicity data and solubility limitations;
- composition of media, CO₂ concentration if applicable, humidity level;
- concentration (and/or volume) of solvent and test chemical added in the culture medium;
- incubation temperature;
- incubation time;
- duration of treatment;
- harvest time after treatment;
- cell density at seeding, if appropriate;
- type and composition of metabolic activation system (source of S9, method of preparation of the S9 mix, the concentration or volume of S9 mix and S9 in the final culture medium, quality controls of S9);
- positive and negative control chemicals, final concentrations for each conditions of treatment;
- methods of slide preparation and staining technique used;
- criteria for acceptability of assays;
- criteria for scoring aberrations;
- number of metaphases analysed;
- methods for the measurements of cytotoxicity;
- any supplementary information relevant to cytotoxicity and method used;
- criteria for considering studies as positive, negative or equivocal;
- methods used to determine pH, osmolality and precipitation.

Results:

- the number of cells treated and the number of cells harvested for each culture when cell lines are used
- cytotoxicity measurements, e.g. RPD, RICC, MI, other observations if any;
- information on cell cycle length, doubling time or proliferation index in case of cell lines;
- signs of precipitation and time of the determination;

▼ **M7**

- definition for aberrations, including gaps;
- Number of cells scored, number of cells with chromosomal aberrations and type of chromosomal aberrations given separately for each treated and control culture, including and excluding gaps;
- changes in ploidy (polyploid cells and cells with endoreduplicated chromosomes, given separately) if seen;
- concentration-response relationship, where possible;
- concurrent negative (solvent) and positive control data (concentrations and solvents);
- historical negative (solvent) and positive control data, with ranges, means and standard deviations and 95 % control limits for the distribution, as well as the number of data;
- statistical analyses, p-values if any.

Discussion of the results.

Conclusions.

LITERATURE:

- (1) OECD (2016). Overview of the set of OECD Genetic Toxicology Test Guidelines and updates performed in 2014-2015. ENV Publications. Series on Testing and Assessment, No. 234, OECD, Paris.
- (2) Evans, H.J. (1976), 'Cytological Methods for Detecting Chemical Mutagens', in *Chemical Mutagens, Principles and Methods for their Detection*, Vol. 4, Hollaender, A. (ed.), Plenum Press, New York and London, pp. 1-29
- (3) Ishidate, M. Jr., T. Sofuni (1985), 'The *in vitro* Chromosomal Aberration Test Using Chinese Hamster Lung (CHL) Fibroblast Cells in Culture' in *Progress in Mutation Research*, Vol. 5, Ashby, J. *et al.* (eds.), Elsevier Science Publishers, Amsterdam-New York- Oxford, pp. 427-432.
- (4) Galloway, S.M. *et al.* (1987), Chromosomal aberration and sister chromatid exchanges in Chinese hamster ovary cells: Evaluation of 108 chemicals, *Environmental and Molecular Mutagenesis*, Vol. 10/suppl. 10, pp. 1-175.
- (5) Muehlbauer, P.A. *et al.* (2008), 'Improving dose selection and identification of aneugens in the *in vitro* chromosome aberration test by integration of flow cytometry-based methods', *Environmental and Molecular Mutagenesis*, Vol. 49/4, pp. 318-327.
- (6) Chapter B.49 of this Annex: *In Vitro Mammalian Cell Micronucleus Test*.
- (7) ILSI paper (draft), Lorge, E., M. Moore, J. Clements, M. O Donovan, F. Darroudi, M. Honma, A. Czich, J van Benthem, S. Galloway, V. Thybaud, B. Gollapudi, M. Aardema, J. Kim, D.J. Kirkland, Recommendations for good cell culture practices in genotoxicity testing.
- (8) Scott, D. *et al.* (1991), Genotoxicity under Extreme Culture Conditions. A report from ICPEMC Task Group 9, *Mutation Research/Reviews in Genetic Toxicology*, Vol.257/2, pp. 147-204.
- (9) Morita, T. *et al.* (1992), Clastogenicity of Low pH to Various Cultured Mammalian Cells, *Mutation Research/Genetic Toxicology and Environmental Mutagenesis*, Vol. 268/2, pp. 297-305.
- (10) Brusick, D. (1986), Genotoxic effects in cultured mammalian cells produced by low pH treatment conditions and increased ion concentrations, *Environmental and Molecular Mutagenesis*, Vol. 8/6, pp. 789-886.

▼ **M7**

- (11) Long, L.H. *et al.* (2007), Different cytotoxic and clastogenic effects of epigallocatechin gallate in various cell-culture media due to variable rates of its oxidation in the culture medium, *Mutation Research/Genetic Toxicology and Environmental Mutagenesis*, Vol. 634/1-2, pp. 177-183.
- (12) Nesslany, F. *et al.* (2008), Characterization of the Genotoxicity of Nitrotri-acetic Acid, *Environmental and Molecular Mutagenesis*, Vol. 49/6, pp. 439-452.
- (13) Galloway, S. (2000), Cytotoxicity and chromosome aberrations *in vitro*: Experience in industry and the case for an upper limit on toxicity in the aberration assay, *Environmental and Molecular Mutagenesis*, Vol. 35/3, pp. 191-201.
- (14) Kirkland, D. *et al.* (2005), Evaluation of the ability of a battery of three *in vitro* genotoxicity tests to discriminate rodent carcinogens and non-carcinogens. I: Sensitivity, specificity and relative predictivity, *Mutation Research/Genetic Toxicology and Environmental Mutagenesis*, Vol. 584/1-2, pp. 1-256.
- (15) Greenwood, S. *et al.* (2004), Population doubling: a simple and more accurate estimation of cell growth suppression in the *in vitro* assay for chromosomal aberrations that reduces irrelevant positive results, *Environmental and Molecular Mutagenesis*, Vol. 43/1, pp. 36-44.
- (16) Hilliard, C.A. *et al.* (1998), Chromosome aberrations *in vitro* related to cytotoxicity of nonmutagenic chemicals and metabolic poisons, *Environmental and Molecular Mutagenesis*, Vol. 31/4, pp. 316-326.
- (17) Hedner K. *et al.* (1982), Sister chromatid exchanges and structural chromosomal aberrations in relation to age and sex, *Human Genetics*, Vol. 62, pp. 305-309.
- (18) Ramsey M.J. *et al.* (1995), The effects of age and lifestyle factors on the accumulation of cytogenetic damage as measured by chromosome painting, *Mutation Research*, Vol. 338, pp. 95-106.
- (19) Coecke S. *et al.* (2005), Guidance on Good Cell Culture Practice. A Report of the Second ECVAM Task Force on Good Cell Culture Practice, *ATLA*, Vol. 33/3, pp. 261-287.
- (20) Henderson, L. *et al.* (1997), Industrial Genotoxicology Group collaborative trial to investigate cell cycle parameters in human lymphocyte cytogenetics studies, *Mutagenesis*, Vol.12/3, pp.163-167.
- (21) Ames, B.N., J. McCann, E. Yamasaki (1975), Methods for Detecting Carcinogens and Mutagens with the Salmonella/Mammalian Microsome Mutagenicity Test, *Mutation Research/Environmental Mutagenesis and Related Subjects*, Vol. 31/6, pp. 347-363.
- (22) Maron, D.M., B.N. Ames (1983), Revised Methods for the Salmonella Mutagenicity Test, *Mutation Research/Environmental Mutagenesis and Related Subjects*, Vol. 113/3-4, pp. 173-215.
- (23) Natarajan, A.T. *et al.* (1976), Cytogenetic Effects of Mutagens/Carcinogens after Activation in a Microsomal System *In Vitro*, I. Induction of Chromosomal Aberrations and Sister Chromatid Exchanges by Diethylnitrosamine (DEN) and Dimethylnitrosamine (DMN) in CHO Cells in the Presence of Rat-Liver Microsomes, *Mutation Research*, Vol. 37/1, pp. 83-90.
- (24) Matsuoka, A., M. Hayashi, M. Jr. Ishidate (1979), Chromosomal Aberration Tests on 29 Chemicals Combined with S9 Mix *in vitro*, *Mutation Research/Genetic Toxicology*, Vol. 66/3, pp. 277-290.
- (25) Ong, T.-m. *et al.* (1980), Differential effects of cytochrome P450-inducers on promutagen activation capabilities and enzymatic activities of S-9 from rat liver, *Journal of Environmental Pathology and Toxicology*, Vol. 4/1, pp. 55-65.
- (26) Elliot, B.M. *et al.* (1992), Report of UK Environmental Mutagen Society Working Party. Alternatives to Aroclor 1254-induced S9 in *in vitro* Genotoxicity Assays, *Mutagenesis*, Vol. 7/3, pp. 175-177.

▼ M7

- (27) Matsushima, T. *et al.* (1976), 'A Safe Substitute for Polychlorinated Biphenyls as an Inducer of Metabolic Activation Systems', in *In Vitro Metabolic Activation in Mutagenesis Testing*, de Serres, F.J. *et al.* (eds.), Elsevier, North-Holland, pp. 85-88.
- (28) Galloway, S.M. *et al.* (1994). Report from Working Group on *in vitro* Tests for Chromosomal Aberrations, *Mutation Research/Environmental Mutagenesis and Related Subjects*, Vol. 312/3, pp. 241-261.
- (29) Johnson, T.E., D.R. Umbenhauer, S.M. Galloway (1996), Human liver S-9 metabolic activation: proficiency in cytogenetic assays and comparison with phenobarbital/beta-naphthoflavone or Aroclor 1254 induced rat S-9, *Environmental and Molecular Mutagenesis*, Vol. 28/1, pp. 51-59.
- (30) UNEP (2001), Stockholm Convention on Persistent Organic Pollutants, United Nations Environment Programme (UNEP). Available at: <http://www.pops.int/>.
- (31) Tucker, J.D., M.L. Christensen (1987), Effects of anticoagulants upon sister-chromatid exchanges, cell-cycle kinetics, and mitotic index in human peripheral lymphocytes, *Mutation Research*, Vol. 190/3, pp. 225-8.
- (32) Krahn, D.F., F.C. Barsky, K.T. McCooley (1982), 'CHO/HGPRT Mutation Assay: Evaluation of Gases and Volatile Liquids', in *Genotoxic Effects of Airborne Agents*, Tice, R.R., D.L. Costa, K.M. Schaich (eds.), Plenum, New York, pp. 91-103.
- (33) Zamora, P.O. *et al.* (1983), Evaluation of an Exposure System Using Cells Grown on Collagen Gels for Detecting Highly Volatile Mutagens in the CHO/HGPRT Mutation Assay, *Environmental and Molecular Mutagenesis*, Vol. 5/6, pp. 795-801.
- (34) Asakura, M. *et al.* (2008), An improved system for exposure of cultured mammalian cells to gaseous compounds in the chromosomal aberration assay, *Mutation Research*, Vol. 652/2, pp. 122-130.
- (35) Lorge, E. *et al.* (2008), Comparison of different methods for an accurate assessment of cytotoxicity in the *in vitro* micronucleus test. I. Theoretical aspects, *Mutation Research/Genetic Toxicology and Environmental Mutagenesis*, Vol. 655/1-2, pp. 1-3.
- (36) Galloway, S. *et al.* (2011), Workshop summary: Top concentration for *in vitro* mammalian cell genotoxicity assays; and Report from working group on toxicity measures and top concentration for *in vitro* cytogenetics assays (chromosome aberrations and micronucleus), *Mutation Research/Genetic Toxicology and Environmental Mutagenesis*, Vol. 723/2, pp. 77-83.
- (37) Honma, M. (2011), Cytotoxicity measurement in *in vitro* chromosome aberration test and micronucleus test, *Mutation Research/Fundamental and Molecular Mechanisms of Mutagenesis*, Vol. 724/1-2, pp. 86-87.
- (38) Richardson, C. *et al.* (1989), *Analysis of Data from In Vitro Cytogenetic Assays. In: Statistical Evaluation of Mutagenicity Test Data*, Kirkland, D.J. (ed.) Cambridge University Press, Cambridge, pp. 141-154.
- (39) OECD (2014), Document supporting the WNT decision to implement revised criteria for the selection of the top concentration in the *in vitro* mammalian cell assays on genotoxicity (Test Guidelines 473, 476 and 487) ENV/JM/TG(2014)17. Available upon request.
- (40) Morita, T., M. Honma, K. Morikawa (2012), Effect of reducing the top concentration used in the *in vitro* chromosomal aberration test in CHL cells on the evaluation of industrial chemical genotoxicity, *Mutation Research/Genetic Toxicology and Environmental Mutagenesis*, Vol. 741/1-2, pp. 32-56.
- (41) Brookmire, L., J.J. Chen, D.D. Levy (2013), Evaluation of the Highest Concentrations Used in the In Vitro Chromosome Aberrations Assay, *Environmental and Molecular Mutagenesis*, Vol. 54/1, pp. 36-43.

▼ M7

- (42) EPA, Office of Chemical Safety and Pollution Prevention (2011), Chemical Substances of Unknown or Variable Composition, Complex Reaction Products and Biological Materials: UVCB Substances, <http://www.epa.gov/opptintr/newchems/pubs/uvcb.txt>.
- (43) USFDA (2012), International Conference on Harmonisation (ICH) Guidance S2 (R1) on Genotoxicity Testing and Data Interpretation for Pharmaceuticals Intended For Human Use. Available at: <https://federalregister.gov/a/2012-13774>.
- (44) OECD (2014), 'Statistical analysis supporting the revision of the genotoxicity Test Guidelines, OECD Environment, Health and Safety Publications (EHS)', Series on Testing and Assessment, No. 198, OECD Publishing, Paris.
- (45) ISCN (2013), *An International System for Human Cytogenetic Nomenclature*, Schaffer, L.G., J. MacGowan-Gordon, M. Schmid (eds.), Karger Publishers Inc., Connecticut.
- (46) Scott, D. *et al.* (1990), 'Metaphase chromosome aberration assays *in vitro*', in *Basic Mutagenicity Tests: UKEMS Recommended Procedures*, Kirkland, D.J. (ed.), Cambridge University Press, Cambridge, pp. 62-86.
- (47) Hayashi, M. *et al.* (2011), Compilation and use of genetic toxicity historical control Data, *Mutation Research*, Vol. 723/2, pp. 87-90.
- (48) Ryan, T. P. (2000), *Statistical Methods for Quality Improvement*, 2nd Edition, John Wiley and Sons, New York.
- (49) Fleiss, J. L., B. Levin, M.C. Paik (2003), *Statistical Methods for Rates and Proportions*, 3rd ed., John Wiley & Sons, New York.
- (50) Galloway, S.M. *et al.* (1987), Chromosome aberration and sister chromatid exchanges in Chinese hamster ovary cells: Evaluation of 108 chemicals, *Environmental and Molecular Mutagenesis*, Vol. 10/suppl. 10, pp. 1-175.
- (51) Richardson, C. *et al.* (1989), 'Analysis of Data from *In Vitro* Cytogenetic Assays', in *Statistical Evaluation of Mutagenicity Test Data*, Kirkland, D.J. (ed.), Cambridge University Press, Cambridge, pp. 141-154.
- (52) Warr, T.J., E.M. Parry, J.M. Parry (1993), A comparison of two *in vitro* mammalian cell cytogenetic assays for the detection of mitotic aneuploidy using 10 known or suspected aneugens, *Mutation Research*, Vol. 287/1, pp. 29-46.
- (53) Locke-Huhle, C. (1983), Endoreduplication in Chinese hamster cells during alpha-radiation induced G2 arrest, *Mutation Research*, Vol. 119/3, pp. 403-413.
- (54) Huang, Y., C. Change, J.E. Trosko (1983), Aphidicolin — induced endoreduplication in Chinese hamster cells, *Cancer Research*, Vol. 43/3, pp. 1362-1364.
- (55) Soper, K.A., S.M. Galloway (1994), Cytotoxicity measurement in *in vitro* chromosome aberration test and micronucleus test, *Mutation Research*, Vol. 312, pp. 139-149.

▼ M7*Appendix 1*

DEFINITIONS

Aneuploidy: any deviation from the normal diploid (or haploid) number of chromosomes by a single chromosome or more than one, but not by entire set(s) of chromosomes (polyploidy).

Apoptosis: programmed cell death characterised by a series of steps leading to a disintegration of cells into membrane-bound particles that are then eliminated by phagocytosis or by shedding.

Cell proliferation: increase in cell number as a result of mitotic cell division.

Chemical: a substance or a mixture.

Chromatid break: discontinuity of a single chromatid in which there is a clear misalignment of one of the chromatids.

Chromatid gap: non-staining region (achromatic lesion) of a single chromatid in which there is minimal misalignment of the chromatid.

Chromatid-type aberration: structural chromosome damage expressed as breakage of single chromatids or breakage and reunion between chromatids.

Chromosome-type aberration: structural chromosome damage expressed as breakage, or breakage and reunion, of both chromatids at an identical site.

Clastogen: any chemical which causes structural chromosomal aberrations in populations of cells or eukaryotic organisms.

Concentrations: refer to final concentrations of the test chemical in the culture medium.

Cytotoxicity: For the assays covered in this test method using cell lines, cytotoxicity is identified as a reduction in relative population doubling (RPD) or relative increase in cell count (RICC) of the treated cells as compared to the negative control (see paragraph 17 and Appendix 2). For the assays covered in this test method using primary cultures of lymphocytes, cytotoxicity is identified as a reduction in mitotic index (MI) of the treated cells as compared to the negative control (see paragraph 18 and Appendix 2).

Endoreduplication: a process in which after an S period of DNA replication, the nucleus does not go into mitosis but starts another S period. The result is chromosomes with 4, 8, 16..., chromatids.

Genotoxic: a general term encompassing all types of DNA or chromosome damage, including breaks, deletions, adducts, nucleotides modifications and linkages, rearrangements, gene mutations, chromosome aberrations, and aneuploidy. Not all types of genotoxic effects result in mutations or stable chromosome damage.

Mitotic index (MI): the ratio of cells in metaphase divided by the total number of cells observed in a population of cells; an indication of the degree of proliferation of that population.

Mitosis: division of the cell nucleus usually divided into prophase, prometaphase, metaphase, anaphase and telophase.

Mutagenic: produces a heritable change of DNA base-pair sequences(s) in genes or of the structure of chromosomes (chromosome aberrations).

▼ M7

Numerical aberration: a change in the number of chromosomes from the normal number characteristic of the cells utilised.

Polyploidy: numerical chromosomal aberrations in cells or organisms involving entire set(s) of chromosomes, as opposed to an individual chromosome or chromosomes (aneuploidy).

p53 status: p53 protein is involved in cell cycle regulation, apoptosis and DNA repair. Cells deficient in functional p53 protein, unable to arrest cell cycle or to eliminate damaged cells via apoptosis or other mechanisms (e.g. induction of DNA repair) related to p53 functions in response to DNA damage, should be theoretically more prone to gene mutations or chromosomal aberrations.

Relative Increase in Cell Counts (RICC): the increase in the number of cells in chemically-exposed cultures versus increase in non-treated cultures, a ratio expressed as a percentage.

Relative Population Doubling (RPD): the increase in the number of population doublings in chemically-exposed cultures versus increase in non-treated cultures, a ratio expressed as a percentage.

S9 liver fraction: supernatant of liver homogenate after 9 000 g centrifugation, i.e. raw liver extract.

S9 mix: mix of the S9 liver fraction and cofactors necessary for metabolic enzymes activity.

Solvent control: General term to define the control cultures receiving the solvent alone used to dissolve the test chemical.

Structural aberration: a change in chromosome structure detectable by microscopic examination of the metaphase stage of cell division, observed as deletions and fragments, intrachanges or interchanges.

Test chemical: Any substance or mixture tested using this test method.

Untreated controls: cultures that receive no treatment (i.e. no test chemical nor solvent) but are processed concurrently in the same way as the cultures receiving the test chemical.

▼ M7*Appendix 2***FORMULAS FOR CYTOTOXICITY ASSESSMENT****Mitotic index (MI):**

$$\text{MI}(\%) = \frac{\text{Number of mitotic cells}}{\text{Total number of Cells scored}} \times 100$$

Relative Increase in Cell Counts (RICC) or **Relative Population Doubling (RPD)** is recommended, as both take into account the proportion of the cell population which has divided.

$$\text{RICC}(\%) = \frac{(\text{Increase in number of cells in treated cultures}(\text{final} - \text{starting}))}{(\text{Increase in numbers of cells in control cultures}(\text{final} - \text{starting}))} \times 100$$

$$\text{RPD}(\%) = \frac{(\text{No. of Population doublings in treated cultures})}{(\text{No. of population doublings in control cultures})} \times 100$$

where:

$$\text{Population Doubling} = [\log (\text{Post-treatment cell number} \div \text{Initial cell number})] \div \log 2$$

For example, a RICC, or a RPD of 53 % indicates 47 % cytotoxicity/cytostasis and 55 % cytotoxicity/cytostasis measured by MI means that the actual MI is 45 % of control.

In any case, the number of cells before treatment should be measured and the same for treated and negative control cultures.

While RCC (i.e. Number of cells in treated cultures/Number of cells in control cultures) had been used as cytotoxicity parameter in the past, is no longer recommended because it can underestimate cytotoxicity

In the negative control cultures, population doubling should be compatible with the requirement to sample cells after treatment at a time equivalent to about 1,5 normal cell cycle length and mitotic index should be higher enough to get a sufficient number of cells in mitosis and to reliably calculate a 50 % reduction.

▼M7**B.11. MAMMALIAN BONE MARROW CHROMOSOMAL
ABERRATION TEST****INTRODUCTION**

This test method is equivalent to OECD test guideline 475 (2016). It is part of a series of test methods on genetic toxicology. An OECD document that provides succinct information on genetic toxicology testing and an overview of the recent changes that were made to these Test Guidelines has been developed (1).

The mammalian *in vivo* bone marrow chromosomal aberration test is especially relevant for assessing genotoxicity because, although they may vary among species, factors of *in vivo* metabolism, pharmacokinetics and DNA-repair processes are active and contribute to the responses. An *in vivo* assay is also useful for further investigation of genotoxicity detected by an *in vitro* system.

The mammalian *in vivo* chromosomal aberration test is used for the detection of structural chromosome aberrations induced by test chemicals in bone marrow cells of animals, usually rodents (2) (3) (4) (5). Structural chromosomal aberrations may be of two types, chromosome or chromatid. While the majority of genotoxic chemical-induced aberrations are of the chromatid-type, chromosome-type aberrations also occur. Chromosomal damage and related events are the cause of many human genetic diseases and there is substantial evidence that, when these lesions and related events cause alterations in oncogenes and tumour suppressor genes, they are involved in cancer in humans and experimental systems. Polyploidy (including endoreduplication) could arise in chromosome aberration assays *in vivo*. However, an increase in polyploidy per se does not indicate aneugenic potential and can simply indicate cell cycle perturbation or cytotoxicity. This test is not designed to measure aneuploidy. An *in vivo* mammalian erythrocyte micronucleus test (Chapter B.12 of this Annex) or the *in vitro* mammalian cell micronucleus test (Chapter B.49 of this Annex) would be the *in vivo* and *in vitro* tests, respectively, recommended for the detection of aneuploidy.

Definitions of terminology used are set out in Appendix 1.

INITIAL CONSIDERATIONS

Rodents are routinely used in this test, but other species may in some cases be appropriate if scientifically justified. Bone marrow is the target tissue in this test since it is a highly vascularised tissue and it contains a population of rapidly cycling cells that can be readily isolated and processed. The scientific justification for using species other than rats and mice should be provided in the report. If species other than rodents are used, it is recommended that the measurement of bone marrow chromosomal aberration be integrated into another appropriate toxicity test.

If there is evidence that the test chemical(s), or its metabolite(s), will not reach the target tissue, it may not be appropriate to use this test.

Before use of the test method on a mixture for generating data for an intended regulatory purpose, it should be considered whether, and if so why, it may provide adequate results for that purpose. Such considerations are not needed, when there is a regulatory requirement for testing of the mixture.

▼ M7**PRINCIPLE OF THE TEST METHOD**

Animals are exposed to the test chemical by an appropriate route of exposure and are humanely euthanised at an appropriate time after treatment. Prior to euthanasia, animals are treated with a metaphase-arresting agent (e.g. colchicine or colcemid). Chromosome preparations are then made from the bone marrow cells and stained, and metaphase cells are analysed for chromosomal aberrations.

VERIFICATION OF LABORATORY PROFICIENCY**Proficiency Investigations**

In order to establish sufficient experience with the conduct of the assay prior to using it for routine testing, the laboratory should have demonstrated the ability to reproduce expected results from published data (e.g. (6)) for chromosomal aberration frequencies with a minimum of two positive control chemicals (including weak responses induced by low doses of positive controls), such as those listed in Table 1 and with compatible vehicle/solvent controls (see paragraph 22). These experiments should use doses that give reproducible and dose related increases and demonstrate the sensitivity and dynamic range of the test system in the tissue of interest (bone marrow) and using the scoring method to be employed within the laboratory. This requirement is not applicable to laboratories that have experience, i.e. that have a historical database available as defined in paragraphs 10-14.

Historical Control Data

During the course of the proficiency investigations, the laboratory should establish:

- A historical positive control range and distribution, and

- A historical negative control range and distribution.

When first acquiring data for a historical negative control distribution, concurrent negative controls should be consistent with published control data, where they exist. As more experimental data are added to the historical control distribution, concurrent negative controls should ideally be within the 95 % control limits of that distribution. The laboratory's historical negative control database should be statistically robust to ensure the ability of the laboratory to assess the distribution of their negative control data. The literature suggests that a minimum of 10 experiments may be necessary but would preferably consist of at least 20 experiments conducted under comparable experimental conditions. Laboratories should use quality control methods, such as control charts (e.g. C-charts or X-bar charts (7)), to identify how variable their data are, and to show that the methodology is 'under control' in their laboratory. Further recommendations on how to build and use the historical data (i.e. criteria for inclusion and exclusion of data in historical data and the acceptability criteria for a given experiment) can be found in the literature (8).

Where the laboratory does not complete a sufficient number of experiments to establish a statistically robust negative control distribution (see paragraph 11) during the proficiency investigations (described in paragraph 9), it is acceptable that the distribution can be built during the first routine tests. This approach should follow the recommendations set out in the literature (8) and the negative control results obtained in these experiments should remain consistent with published negative control data.

▼ M7

Any changes to the experimental protocol should be considered in terms of their impact on the resulting data remaining consistent with the laboratory's existing historical control database. Only major inconsistencies should result in the establishment of a new historical control database, where expert judgement determines that it differs from the previous distribution (see paragraph 11). During the re-establishment, a full negative control database may not be needed to permit the conduct of an actual test, provided that the laboratory can demonstrate that their concurrent negative control values remain either consistent with their previous database or with the corresponding published data.

Negative control data should consist of the incidence of structural chromosomal aberration (excluding gaps) in each animal. Concurrent negative controls should ideally be within the 95 % control limits of the distribution of the laboratory's historical negative control database. Where concurrent negative control data fall outside the 95 % control limits, they may be acceptable for inclusion in the historical control distribution as long as these data are not extreme outliers and there is evidence that the test system is 'under control' (see paragraph 11) and no evidence of technical or human failure.

DESCRIPTION OF THE METHOD**Preparations***Selection of animal species*

Commonly used laboratory strains of healthy young adult animals should be employed. Rats are commonly used, although mice may also be appropriate. Any other appropriate mammalian species may be used, if scientific justification is provided in the report.

Animal housing and feeding conditions

For rodents, the temperature in the animal room should be 22 °C (\pm 3 °C). Although the relative humidity ideally should be 50-60 %, it should be at least 40 % and preferably not exceed 70 % other than during room cleaning. Lighting should be artificial, the sequence being 12 hours light, 12 hours dark. For feeding, conventional laboratory diets may be used with an unlimited supply of drinking water. The choice of diet may be influenced by the need to ensure a suitable admixture of a test chemical when administered by this route. Rodents should be housed in small groups (no more than five per cage) of the same sex and treatment group if no aggressive behaviour is expected, preferably in solid floor cages with appropriate environmental enrichment. Animals may be housed individually only if scientifically justified.

Preparation of the animals

Healthy young adult animals (for rodents, ideally 6-10 weeks old at start of treatment, though slightly older animals are also acceptable) are normally used, and are randomly assigned to the control and treatment groups. The individual animals are identified uniquely using a humane, minimally invasive method (e.g. by ringing, tagging, micro-chipping or biometric identification, but not ear or toe clipping) and acclimated to the laboratory conditions for at least five days. Cages should be arranged in such a way that possible effects due to cage placement are minimised. Cross contamination by the positive control and the test chemical should be avoided. At the commencement of the study, the weight variation of animals should be minimal and not exceed \pm 20 % of the mean weight of each sex.

Preparation of doses

Solid test chemicals should be dissolved or suspended in appropriate solvents or vehicles or admixed in diet or drinking water prior to dosing the animals. Liquid test chemicals may be dosed directly or diluted prior to dosing. For inhalation

▼ M7

exposures, test chemicals can be administered as a gas, vapour, or a solid/liquid aerosol, depending on their physicochemical properties. Fresh preparations of the test chemical should be employed unless stability data demonstrate the acceptability of storage and define the appropriate storage conditions.

Solvent/vehicle

The solvent/vehicle should not produce toxic effects at the dose levels used, and should not be suspected of chemical reaction with the test chemicals. If other than well-known solvents/vehicles are used, their inclusion should be supported with reference data indicating their compatibility. It is recommended that wherever possible, the use of an aqueous solvent/vehicle should be considered first. Examples of commonly used compatible solvents/vehicles include water, physiological saline, methylcellulose solution, carboxymethyl cellulose sodium salt solution, olive oil and corn oil. In the absence of historical or published control data showing that no structural aberrations or other deleterious effects are induced by a chosen atypical solvent/vehicle, an initial study should be conducted in order to establish the acceptability of the solvent/vehicle control.

Controls*Positive controls*

A group of animals treated with a positive control chemical should normally be included with each test. This may be waived when the testing laboratory has demonstrated proficiency in the conduct of the test and has established a historical positive control range. When a concurrent positive control group is not included, scoring controls (fixed and unstained slides) should be included in each experiment. These can be obtained by including within the scoring of the study appropriate reference samples that have been obtained and stored from a separate positive control experiment conducted periodically (e.g. every 6-18 months) in the laboratory where the test is performed; for example, during proficiency testing and on a regular basis thereafter, where necessary.

Positive control chemicals should reliably produce a detectable increase in the frequency of cells with structural chromosomal aberrations over the spontaneous level. Positive control doses should be chosen so that the effects are clear but do not immediately reveal the identity of the coded samples to the scorer. It is acceptable that the positive control be administered by a route different from the test chemical, using a different treatment schedule, and for sampling to occur only at a single time point. In addition, the use of chemical class-related positive control chemicals may be considered, when appropriate. Examples of positive control chemicals are included in Table 1.

*Table 1***Examples of positive control chemicals**

Chemical	CASRN
Ethyl methanesulphonate	62-50-0
Methyl methanesulphonate	66-27-3
Ethyl nitrosourea	759-73-9
Mitomycin C	50-07-7
Cyclophosphamide (monohydrate)	50-18-0 (6055-19-2)
Triethylenemelamine	51-18-3

▼ M7*Negative controls*

Negative control group animals should be included at every sampling time and otherwise handled in the same way as the treatment groups, except for not receiving treatment with the test chemical. If a solvent/vehicle is used in administering the test chemical, the control group should receive this solvent/vehicle. However, if consistent inter-animal variability and frequencies of cells with structural aberrations are demonstrated by historical negative control data at each sampling time for the testing laboratory, only a single sampling for the negative control may be necessary. Where a single sampling is used for negative controls, it should be the first sampling time used in the study.

PROCEDURE

Number and sex of animals

In general, the micronucleus response is similar between male and female animals (9) and it is expected that this will be true also for structural chromosomal aberrations; therefore, most studies could be performed in either sex. Data demonstrating relevant differences between males and females (e.g. differences in systemic toxicity, metabolism, bioavailability, bone marrow toxicity, etc. including e.g. a range-finding study) would encourage the use of both sexes. In this case, it may be appropriate to perform a study in both sexes, e.g. as part of a repeated dose toxicity study. It might be appropriate to use the factorial design in case both sexes are used. Details on how to analyse the data using this design are given in Appendix 2.

Group sizes at study initiation should be established with the aim of providing a minimum of 5 analysable animals of one sex, or of each sex if both are used, per group. Where human exposure to chemicals may be sex-specific, as for example with some pharmaceuticals, the test should be performed with the appropriate sex. As a guide to maximum typical animal requirements, a study in bone marrow at two sampling times with three dose groups and a concurrent negative control group, plus a positive control group (each group composed of five animals of a single sex), would require 45 animals.

Dose levels

If a preliminary range-finding study is performed because there are no suitable data already available to aid in dose selection, it should be performed in the same laboratory, using the same species, strain, sex, and treatment regimen to be used in the main study (10). The study should aim to identify the maximum tolerated dose (MTD), defined as the highest dose that will be tolerated without evidence of study-limiting toxicity, relative to the duration of the study period (for example, by inducing body weight depression or hematopoietic system cytotoxicity), but not death or evidence of pain, suffering or distress necessitating humane euthanasia (11).

The highest dose may also be defined as a dose that produces some indication of toxicity to the bone marrow.

Chemicals that exhibit saturation of toxicokinetic properties, or induce detoxification processes that may lead to a decrease in exposure after long-term treatment may be exceptions to the dose-setting criteria and should be evaluated on a case-by-case basis.

In order to obtain dose response information, a complete study should include a negative control group and a minimum of three dose levels generally separated by a factor of 2, but not greater than 4. If the test chemical does not produce toxicity in a range-finding study or based on existing data, the highest dose for a single administration should be 2 000 mg/kg body weight. However, if the test chemical does cause toxicity, the MTD should be the highest dose administered and the dose levels used should preferably cover a range from the maximum to a

▼ M7

dose producing little or no toxicity. When target tissue (bone marrow) toxicity is observed at all dose levels tested, further study at non-toxic doses is advisable. Studies intending to more fully characterise the quantitative dose-response information may require additional dose groups. For certain types of test chemicals (e.g. human pharmaceuticals) covered by specific requirements, these limits may vary.

Limit test

If dose range-finding experiments, or existing data from related animal strains, indicate that a treatment regime of at least the limit dose (described below) produces no observable toxic effects, (including no depression of bone marrow proliferation or other evidence of target tissue cytotoxicity), and if genotoxicity would not be expected based upon *in vitro* genotoxicity studies or data from structurally related chemicals, then a full study using three dose levels may not be considered necessary, provided it has been demonstrated that the test chemical(s) reach(es) the target tissue (bone marrow). In such cases, a single dose level, at the limit dose, may be sufficient. For an administration period of > 14 days, the limit dose is 1 000 mg/kg body weight/day. For administration periods of 14 days or less, the limit dose is 2 000 mg/kg/body weight/day.

Administration of doses

The anticipated route of human exposure should be considered when designing an assay. Therefore, routes of exposure such as dietary, drinking water, topical, subcutaneous, intravenous, oral (by gavage), inhalation, intratracheal, or implantation may be chosen as justified. In any case, the route should be chosen to ensure adequate exposure of the target tissue(s). Intraperitoneal injection is generally not recommended since it is not an intended route of human exposure, and should only be used with specific scientific justification. If the test chemical is admixed in diet or drinking water, especially in case of single dosing, care should be taken that the delay between food and water consumption and sampling should be sufficient to allow detection of the effects (see paragraphs 33-34). The maximum volume of liquid that can be administered by gavage or injection at one time depends on the size of the test animal. The volume should not normally exceed 1 ml/100 g body weight except in the case of aqueous solutions where a maximum of 2 ml/100 g may be used. The use of volumes greater than this should be justified. Except for irritating or corrosive test chemicals, which will normally produce exacerbated effects at higher concentrations, variability in test volume should be minimised by adjusting the concentration to ensure administration of a constant volume in relation to body weight at all dose levels.

Treatment schedule

Test chemicals are normally administered as a single treatment, but may be administered as a split dose (i.e. two or more treatments on the same day separated by no more than 2-3 hours) to facilitate administering a large volume. Under these circumstances, or when administering the test chemical by inhalation, the sampling time should be scheduled based on the time of the last dosing or the end of exposure.

There are little data available on the suitability of a repeated-dose protocol for this test. However, in circumstances where it is desirable to integrate this test with a repeated-dose toxicity test, care should be taken to avoid loss of chromosomally damaged mitotic cells as may occur with toxic doses. Such integration is

▼ M7

acceptable when the highest dose is greater or equal to the limit dose (see paragraph 29) and a dose group is administered the limit dose for the duration of the treatment period. The micronucleus test (test method B.12) should be viewed as the *in vivo* test of choice for chromosomal aberrations when integration with other studies is desired.

Bone marrow samples should be taken at two separate times following single treatments. For rodents, the first sampling interval should be the time necessary to complete 1,5 normal cell cycle lengths (the latter being normally 12-18 hours following the treatment period). Since the time required for uptake and metabolism of the test chemical(s) as well as its effect on cell cycle kinetics can affect the optimum time for chromosomal aberration detection, a later sample collection 24 hours after the first sampling time is recommended. At the first sampling time, all dose groups should be treated and samples collected for analysis; however, at the later sampling time(s), only the highest dose needs to be administered. If dose regimens of more than one day are used based on scientific justification, one sampling time at up to approximately 1,5 normal cell cycle lengths after the final treatment should generally be used.

Following treatment and prior to sample collection, animals are injected intraperitoneally with an appropriate dose of a metaphase-arresting agent (e.g. colcemid or colchicine), and samples are collected at an appropriate interval thereafter. For mice this interval is approximately 3-5 hours prior to collection and for rats it is 2-5 hours. Cells are harvested from the bone marrow, swollen, fixed and stained, and analysed for chromosomal aberrations (12).

Observations

General clinical observations of the test animals should be made and clinical signs recorded at least once a day, preferably at the same time(s) each day and considering the peak period of anticipated effects after dosing. At least twice daily during the dosing period, all animals should be observed for morbidity and mortality. All animals should be weighed at study initiation, at least once a week during repeated-dose studies, and at euthanasia. In studies of at least one-week duration, measurements of food consumption should be made at least weekly. If the test chemical is administered via the drinking water, water consumption should be measured at each change of water and at least weekly. Animals exhibiting non-lethal indicators of excessive toxicity should be humanely euthanised prior to completion of the test period (11).

Target tissue exposure

A blood sample should be taken at appropriate time(s) in order to permit investigation of the plasma levels of the test chemicals for the purposes of demonstrating that exposure of the bone marrow occurred, where warranted and where other exposure data do not exist (see paragraph 44).

Bone marrow and chromosome preparations

Immediately after humane euthanasia, bone marrow cells are obtained from the femurs or tibias of the animals, exposed to hypotonic solution and fixed. The metaphase cells are then spread on slides and stained using established methods (see (3) (12)).

▼ M7**Analysis**

All slides, including those of positive and negative controls, should be independently coded before analysis and should be randomised so the scorer is unaware of the treatment condition.

The mitotic index should be determined as a measure of cytotoxicity in at least 1 000 cells per animal for all treated animals (including positive controls), untreated or vehicle/solvent negative control animals.

At least 200 metaphases should be analysed for each animal for structural chromosomal aberrations including and excluding gaps (6). However, if the historical negative control database indicates the mean background structural chromosomal aberration frequency is < 1 % in the testing laboratory, consideration should be given to scoring additional cells. Chromatid and chromosome-type aberrations should be recorded separately and classified by sub-types (breaks, exchanges). Procedures in use in the laboratory should ensure that analysis of chromosomal aberrations is performed by well-trained scorers and peer-reviewed if appropriate. Recognising that slide preparation procedures often result in the breakage of a proportion of metaphases with a resulting loss of chromosomes, the cells scored should, therefore, contain a number of centromeres not less than $2n \pm 2$, where n is the haploid number of chromosomes for that species.

DATA AND REPORTING**Treatment of Results**

Individual animal data should be presented in tabular form. The mitotic index, the number of metaphase cells scored, the number of aberrations per metaphase cell and the percentage of cells with structural chromosomal aberration(s) should be evaluated for each animal. Different types of structural chromosomal aberrations should be listed with their numbers and frequencies for treated and control groups. Gaps, as well as polyploid cells and cells with endoreduplicated chromosomes are recorded separately. The frequency of gaps is reported but generally not included in the analysis of the total structural aberration frequency. If there is no evidence for a difference in response between the sexes, the data may be combined for statistical analysis. Data on animal toxicity and clinical signs should also be reported.

Acceptability Criteria

The following criteria determine the acceptability of the test:

- (a) The concurrent negative control data are considered acceptable for addition to the laboratory historical control database (see paragraphs 11-14);
- (b) The concurrent positive controls or scoring controls should induce responses that are compatible with those generated in the historical positive control database and produce a statistically significant increase compared with the negative control (see paragraphs 20-21);
- (c) The appropriate number of doses and cells has been analysed;
- (d) The criteria for the selection of highest dose are consistent with those described in paragraphs 25-28.

Evaluation and Interpretation of Results

Providing that all acceptability criteria are fulfilled, a test chemical is considered clearly positive if:

▼M7

- (a) At least one of the treatment groups exhibits a statistically significant increase in the frequency of cells with structural chromosomal aberrations (excluding gaps) compared with the concurrent negative control,
- (b) This increase is dose-related at least at one sampling time when evaluated with an appropriate trend test, and
- (c) Any of these results are outside the distribution of the historical negative control data (e.g. Poisson-based 95 % control limits).

If only the highest dose is examined at a particular sampling time, a test chemical is considered clearly positive if there is a statistically significant increase compared with the concurrent negative control and the results are outside the distribution of the historical negative control data (e.g. Poisson-based 95 % control limits). Recommendations for appropriate statistical methods can be found in the literature (13). When conducting a dose-response analysis, at least three treated dose groups should be analysed. Statistical tests should use the animal as the experimental unit. Positive results in the chromosomal aberration test indicate that a test chemical induces structural chromosomal aberrations in the bone marrow of the species tested.

Providing that all acceptability criteria are fulfilled, a test chemical is considered clearly negative if in all experimental conditions examined:

- (a) None of the treatment groups exhibits a statistically significant increase in the frequency of cells with structural chromosomal aberrations (excluding gaps) compared with the concurrent negative control,
- (b) There is no dose-related increase at any sampling time when evaluated by an appropriate trend test,
- (c) All results are inside the distribution of the historical negative control data (e.g. Poisson-based 95 % control limits), and
- (d) Bone marrow exposure to the test chemical(s) occurred.

Recommendations for the most appropriate statistical methods can be found in the literature (13). Evidence of exposure of the bone marrow to a test chemical may include a depression of the mitotic index or measurement of the plasma or blood levels of the test chemical(s). In the case of intravenous administration, evidence of exposure is not needed. Alternatively, ADME data, obtained in an independent study using the same route and same species can be used to demonstrate bone marrow exposure. Negative results indicate that, under the test conditions, the test chemical does not induce structural chromosomal aberrations in the bone marrow of the species tested.

There is no requirement for verification of a clear positive or clear negative response.

In cases where the response is not clearly negative or positive and in order to assist in establishing the biological relevance of a result (e.g. a weak or borderline increase), the data should be evaluated by expert judgement and/or further investigations of the existing experiments completed. In some cases, analysing more cells or performing a repeat experiment using modified experimental conditions could be useful.

▼M7

In rare cases, even after further investigations, the data will preclude making a conclusion that the test chemical produces either positive or negative results, and the study will therefore be concluded as equivocal.

The frequencies of polyploid and endoreduplicated metaphases among total metaphases should be recorded separately. An increase in the number of polyploid/endoreduplicated cells may indicate that the test chemical has the potential to inhibit mitotic processes or cell cycle progression (see paragraph 3).

Test Report

The test report should include the following information:

*Summary**Test chemical:*

- source, lot number, limit date for use if available;
- stability of the test chemical, if known.

Mono-constituent substance:

- physical appearance, water solubility, and additional relevant physico-chemical properties;
- chemical identification, such as IUPAC or CAS name, CAS number, SMILES or InChI code, structural formula, purity, chemical identity of impurities as appropriate and practically feasible, etc.

Multi-constituent substance, UVCBs and mixtures:

- characterised as far as possible by chemical identity (see above), quantitative occurrence and relevant physicochemical properties of the constituents.

Test chemical preparation:

- justification for choice of vehicle;
- solubility and stability of the test chemical in solvent/vehicle, if known;
- preparation of dietary, drinking water or inhalation formulations;
- analytical determinations on formulations (e.g. stability, homogeneity, nominal concentrations), when conducted.

Test animals:

- species/strain used and justification for use;
- number, age and sex of animals;
- source, housing conditions, diet, etc.;
- method for uniquely identifying the animals;
- for short-term studies: individual weight of the animals at the start and end of the test; for studies longer than one week: individual body weights during the study and food consumption. Body weight range, mean and standard deviation for each group should be included.

▼M7*Test conditions:*

- positive and negative (vehicle/solvent) controls;
- data from range-finding study, if conducted;
- rationale for dose level selection;
- details of test chemical preparation;
- details of the administration of the test chemical;
- rationale for route and duration of administration;
- methods for verifying that the test chemical(s) reached the general circulation or bone marrow;
- actual dose (mg/kg body weight/day) calculated from diet/drinking water test chemical concentration (ppm) and consumption, if applicable;
- details of food and water quality;
- method of euthanasia;
- method of analgesia (where used);
- detailed description of treatment and sampling schedules and justifications for the choices;
- methods of slide preparation;
- methods for measurement of toxicity;
- identity of metaphase arresting chemical, its concentration, dose and time of administration before sampling;
- procedures for isolating and preserving samples;
- criteria for scoring aberrations;
- number of metaphase cells analysed per animal and the number of cells analysed for mitotic index determination;
- criteria for acceptability of the study;
- criteria for considering studies as positive, negative or inconclusive.

Results:

- animal condition prior to and throughout the test period, including signs of toxicity;
- mitotic index, given separately for each animal;
- type and number of aberrations and of aberrant cells, given separately for each animal;
- total number of aberrations per group with means and standard deviations;
- number of cells with aberrations per group with means and standard deviations;
- changes in ploidy, if seen, including frequencies of polyploid and/or endore-duplicated cells;

▼M7

- dose-response relationship, where possible;
- statistical analyses and method applied;
- data supporting that exposure of the bone marrow occurred;
- concurrent negative control and positive control data with ranges, means and standard deviations;
- historical negative and positive control data with ranges, means, standard deviations, and 95 % control limits for the distribution, as well as the time period covered and number of observations;
- criteria met for a positive or negative response.

Discussion of the results.

Conclusion.

References.

LITERATURE:

- (1) OECD (2016). Overview of the set of OECD Genetic Toxicology Test Guidelines and updates performed in 2014-2015. ENV Publications. Series on Testing and Assessment, No. 234, OECD, Paris.
- (2) Adler, I.D. (1984), 'Cytogenetic Tests in Mammals', in Mutagenicity Testing: A Practical Approach, Venittand, S., J.M. Parry (eds.), IRL Press, Washington, DC, pp. 275-306.
- (3) Preston, R.J. *et al.* (1987), Mammalian *in vivo* cytogenetic assays. Analysis of chromosome aberrations in bone marrow cells, Mutation Research, Vol. 189/2, pp. 157-165.
- (4) Richold, M. *et al.* (1990), 'In Vivo Cytogenetics Assays', in Basic Mutagenicity Tests, UKEMS Recommended Procedures. UKEMS Subcommittee on Guidelines for Mutagenicity Testing. Report. Part I revised, Kirkland, D.J. (ed.), Cambridge University Press, Cambridge, pp. 115-141.
- (5) Tice, R.R. *et al.* (1994), Report from the working group on the *in vivo* mammalian bone marrow chromosomal aberration test, Mutation Research, Vol. 312/3, pp. 305-312.
- (6) Adler, I.D. *et al.* (1998), Recommendations for statistical designs of *in vivo* mutagenicity tests with regard to subsequent statistical analysis, Mutation Research/Genetic Toxicology and Environmental Mutagenesis, Vol. 417/1, pp. 19-30.
- (7) Ryan, T.P. (2000), Statistical Methods for Quality Improvement, 2nd ed., John Wiley and Sons, New York.
- (8) Hayashi, M. *et al.* (2011), Compilation and use of genetic toxicity historical control data, Mutation Research/Fundamental and Molecular Mechanisms of Mutagenesis, Vol. 723/2, pp. 87-90.
- (9) Hayashi, M. *et al.* (1994), *in vivo* rodent erythrocyte micronucleus assay, Mutation Research/Environmental Mutagenesis and Related Subjects, Vol. 312/3, pp. 293-304.
- (10) Fielder, R.J. *et al.* (1992), Report of British Toxicology Society/UK Environmental Mutagen Society Working Group. Dose setting in *in vivo* mutagenicity assays, Mutagenesis, Vol. 7/5, pp. 313-319.

▼ M7

- (11) OECD (2000), 'Guidance Document on the Recognition, Assessment and Use of Clinical Signs as Humane Endpoints for Experimental Animals Used in Safety Evaluation', OECD Environment, Health and Safety Publications (EHS), Series on Testing and Assessment, N°19, OECD Publishing, Paris.
- (12) Pacchierotti, F., V. Stocchi (2013), Analysis of chromosome aberrations in somatic and germ cells of the mouse, *Methods in Molecular Biology*, Vol. 1044, pp. 147-163.
- (13) Lovell, D.P. *et al.* (1989), 'Statistical Analysis of *in vivo* Cytogenetic Assays', in *Statistical Evaluation of Mutagenicity Test Data*. UKEMS SubCommittee on Guidelines for Mutagenicity Testing, Report, Part III, Kirkland, D.J. (ed.), Cambridge University Press, Cambridge, pp. 184-232.

▼ M7*Appendix 1*

DEFINITIONS

Aneuploidy: Any deviation from the normal diploid (or haploid) number of chromosomes by one or more chromosomes, but not by multiples of entire set(s) of chromosomes (*cf.* polyploidy).

Centromere: Region(s) of a chromosome with which spindle fibers are associated during cell division, allowing orderly movement of daughter chromosomes to the poles of the daughter cells.

Chemical: a substance or a mixture.

Chromatid-type aberration: Structural chromosome damage expressed as breakage of single chromatids or breakage and reunion between chromatids.

Chromosome-type aberration: Structural chromosome damage expressed as breakage, or breakage and reunion, of both chromatids at an identical site.

Endoreduplication: A process in which after an S period of DNA replication, the nucleus does not go into mitosis but starts another S period. The result is chromosomes with 4,8,16...chromatids.

Gap: An achromatic lesion smaller than the width of one chromatid, and with minimum misalignment of the chromatids.

Mitotic index: The ratio between the number of cells in mitosis and the total number of cells in a population, which is a measure of the proliferation status of that cell population.

Numerical aberration: A change in the number of chromosomes from the normal number characteristic of the animals utilised (aneuploidy).

Polyploidy: A numerical chromosomal aberration involving a change in the number of the entire set of chromosomes, as opposed to a numerical change in part of the chromosome set (*cf.* aneuploidy).

Structural chromosomal aberration: A change in chromosome structure detectable by microscopic examination of the metaphase stage of cell division, observed as deletions and fragments, intrachanges or interchanges.

Test chemical: Any substance or mixture tested using this test method.

▼ **M7***Appendix 2***THE FACTORIAL DESIGN FOR IDENTIFYING SEX DIFFERENCES IN THE *IN VIVO* CHROMOSOMAL ABERRATION ASSAY****The factorial design and its analysis**

In this design, a minimum of 5 males and 5 females are tested at each concentration level resulting in a design using a minimum of 40 animals (20 males and 20 females, plus relevant positive controls).

The design, which is one of the simpler factorial designs, is equivalent to a two-way analysis of variance with sex and concentration level as the main effects. The data can be analysed using many standard statistical software packages such as SPSS, SAS, STATA, Genstat as well as using R.

The analysis partitions the variability in the dataset into that between the sexes, that between the concentrations and that related to the interaction between the sexes and the concentrations. Each of the terms is tested against an estimate of the variability between the replicate animals within the groups of animals of the same sex given the same concentration. Full details of the underlying methodology are available in many standard statistical textbooks (see references) and in the 'help' facilities provided with statistical packages.

The analysis proceeds by inspecting the sex x concentration interaction term in the ANOVA table⁽¹⁾. In the absence of a significant interaction term the combined values across sexes or across concentration levels provide valid statistical tests between the levels based upon the pooled within group variability term of the ANOVA.

The analysis continues by partitioning the estimate of the between concentrations variability into contrasts which provide for a test for linear and quadratic contrasts of the responses across the concentration levels. When there is a significant sex x concentration interaction this term can also be partitioned into linear x sex and quadratic x sex interaction contrasts. These terms provide tests of whether the concentration responses are parallel for the two sexes or whether there is a differential response between the two sexes.

The estimate of the pooled within group variability can be used to provide pair-wise tests of the difference between means. These comparisons could be made between the means for the two sexes and between the means for the different concentration level such as for comparisons with the negative control levels. In those cases where there is a significant interaction comparisons can be made between the means of different concentrations within a sex or between the means of the sexes at the same concentration.

References

There are many statistical textbooks which discuss the theory, design, methodology, analysis and interpretation of factorial designs ranging from the simplest two factor analyses to the more complex forms used in Design of Experiment methodology. The following is a non-exhaustive list. Some books provide worked examples of comparable designs, in some cases with code for running the analyses using various software packages.

⁽¹⁾ Statisticians who take a modelling approach such as using General Linear Models (GLMs) may approach the analysis in a different but comparable way but will not necessarily derive the traditional anova table, which dates back to algorithmic approaches to calculating the statistics developed in a pre-computer age.

▼M7

Box, G.E.P, Hunter, W.G. and Hunter, J.S. (1978). *Statistics for Experimenters. An Introduction to Design, Data Analysis, and Model Building*. New York: John Wiley & Sons.

Box G.E.P. & Draper, N.R. (1987). *Empirical model-building and response surfaces*. John Wiley & Sons Inc.

Doncaster, C.P. & Davey, A.J.H. (2007). *Analysis of Variance and Covariance: How to Choose and Construct Models for the Life Sciences*. Cambridge University Press.

Mead, R. (1990). *The Design of Experiments. Statistical principles for practical application*. Cambridge University Press.

Montgomery D.C. (1997). *Design and Analysis of Experiments*. John Wiley & Sons Inc.

Winer, B.J. (1971). *Statistical Principles in Experimental Design*. McGraw Hill.

Wu, C.F.J & Hamada, M.S. (2009). *Experiments: Planning, Analysis and Optimization*. John Wiley & Sons Inc.

▼M7**B.12. MAMMALIAN ERYTHROCYTE MICRONUCLEUS TEST**

INTRODUCTION

This test method is equivalent to OECD test guideline 474 (2016). It is part of a series of test methods on genetic toxicology. An OECD document that provides succinct information on genetic toxicology testing and an overview of the recent changes that were made to these Test Guidelines has been developed (1).

The mammalian *in vivo* micronucleus test is especially relevant for assessing genotoxicity because, although they may vary among species, factors of *in vivo* metabolism, pharmacokinetics and DNA repair processes are active and contribute to the responses. An *in vivo* assay is also useful for further investigation of genotoxicity detected by an *in vitro* system.

The mammalian *in vivo* micronucleus test is used for the detection of damage induced by the test chemical to the chromosomes or the mitotic apparatus of erythroblasts. The test evaluates micronucleus formation in erythrocytes sampled either in the bone marrow or peripheral blood cells of animals, usually rodents.

The purpose of the micronucleus test is to identify chemicals that cause cytogenetic damage which results in the formation of micronuclei containing either lagging chromosome fragments or whole chromosomes.

When a bone marrow erythroblast develops into an immature erythrocyte (sometimes also referred to as a polychromatic erythrocyte or reticulocyte), the main nucleus is extruded; any micronucleus that has been formed may remain behind in the cytoplasm. Visualisation or detection of micronuclei is facilitated in these cells because they lack a main nucleus. An increase in the frequency of micronucleated immature erythrocytes in treated animals is an indication of induced structural or numerical chromosomal aberrations.

Newly formed micronucleated erythrocytes are identified and quantitated by staining followed by either visual scoring using a microscope, or by automated analysis. Counting sufficient immature erythrocytes in the peripheral blood or bone marrow of adult animals is greatly facilitated by using an automated scoring platform. Such platforms are acceptable alternatives to manual evaluation (2). Comparative studies have shown that such methods, using appropriate calibration standards, can provide better inter- and intra-laboratory reproducibility and sensitivity than manual microscopic scoring (3) (4). Automated systems that can measure micronucleated erythrocyte frequencies include, but are not limited to, flow cytometers (5), image analysis platforms (6) (7), and laser scanning cytometers (8).

Although not normally done as part of the test, chromosome fragments can be distinguished from whole chromosomes by a number of criteria. These include identification of the presence or absence of a kinetochore or centromeric DNA, both of which are characteristic of intact chromosomes. The absence of kinetochore or centromeric DNA indicates that the micronucleus contains only fragments of chromosomes, while the presence is indicative of chromosome loss.

Definitions of terminology used are set out in Appendix 1.

▼M7**INITIAL CONSIDERATIONS**

The bone marrow of young adult rodents is the target tissue for genetic damage in this test since erythrocytes are produced in this tissue. The measurement of micronuclei in immature erythrocytes in peripheral blood is acceptable in other mammalian species for which adequate sensitivity to detect chemicals that cause structural or numerical chromosomal aberrations in these cells has been demonstrated (by induction of micronuclei in immature erythrocytes) and scientific justification is provided. The frequency of micronucleated immature erythrocytes is the principal endpoint. The frequency of mature erythrocytes that contain micronuclei in the peripheral blood also can be used as an endpoint in species without strong splenic selection against micronucleated cells and when animals are treated continuously for a period that exceeds the lifespan of the erythrocyte in the species used (e.g. 4 weeks or more in the mouse).

If there is evidence that the test chemical(s), or its metabolite(s), will not reach the target tissue, it may not be appropriate to use this test.

Before use of the test method on a mixture for generating data for an intended regulatory purpose, it should be considered whether, and if so why, it may provide adequate results for that purpose. Such considerations are not needed, when there is a regulatory requirement for testing of the mixture.

PRINCIPLE OF THE TEST METHOD

Animals are exposed to the test chemical by an appropriate route. If bone marrow is used, the animals are humanely euthanised at an appropriate time(s) after treatment, the bone marrow is extracted, and preparations are made and stained (9) (10) (11) (12) (13) (14) (15). When peripheral blood is used, the blood is collected at an appropriate time(s) after treatment and preparations are made and stained (12) (16) (17) (18). When treatment is administered acutely, it is important to select bone marrow or blood harvest times at which the treatment-related induction of micronucleated immature erythrocytes can be detected. In the case of peripheral blood sampling, enough time must also have elapsed for these events to appear in circulating blood. Preparations are analysed for the presence of micronuclei, either by visualisation using a microscope, image analysis, flow cytometry, or laser scanning cytometry.

VERIFICATION OF LABORATORY PROFICIENCY**Proficiency Investigations**

In order to establish sufficient experience with the conduct of the assay prior to using it for routine testing, the laboratory should have demonstrated the ability to reproduce expected results from published data (17) (19) (20) (21) (22) for micronucleus frequencies with a minimum of two positive control chemicals (including weak responses induced by low doses of positive controls), such as those listed in Table 1 and with compatible vehicle/solvent controls (see paragraph 26). These experiments should use doses that give reproducible and dose-related increases and demonstrate the sensitivity and dynamic range of the test system in the tissue of interest (bone marrow or peripheral blood) and using the scoring method to be employed within the laboratory. This requirement is not applicable to laboratories that have experience, i.e. that have a historical database available as defined in paragraphs 14-18.

Historical Control Data

During the course of the proficiency investigations, the laboratory should establish:

— A historical positive control range and distribution, and

▼ M7

— A historical negative control range and distribution.

When first acquiring data for a historical negative control distribution, concurrent negative controls should be consistent with published control data, where they exist. As more experimental data are added to the historical control distribution, concurrent negative controls should ideally be within the 95 % control limits of that distribution. The laboratory's historical negative control database should be statistically robust to ensure the ability of the laboratory to assess the distribution of their negative control data. The literature suggests that a minimum of 10 experiments may be necessary but would preferably consist of at least 20 experiments conducted under comparable experimental conditions. Laboratories should use quality control methods, such as control charts (e.g. C-charts or X-bar charts (23)), to identify how variable their data are, and to show that the methodology is 'under control' in their laboratory. Further recommendations on how to build and use the historical data (i.e. criteria for inclusion and exclusion of data in historical data and the acceptability criteria for a given experiment) can be found in the literature (24).

Where the laboratory does not complete a sufficient number of experiments to establish a statistically robust negative control distribution (see paragraph 15) during the proficiency investigations (described in paragraph 13), it is acceptable that the distribution can be built during the first routine tests. This approach should follow the recommendations set out in the literature (24) and the negative control results obtained in these experiments should remain consistent with published negative control data.

Any changes to the experimental protocol should be considered in terms of their impact on the resulting data remaining consistent with the laboratory's existing historical control database. Only major inconsistencies should result in the establishment of a new historical control database where expert judgement determines that it differs from the previous distribution (see paragraph 15). During the re-establishment, a full negative control database may not be needed to permit the conduct of an actual test, provided that the laboratory can demonstrate that their concurrent negative control values remain either consistent with their previous database or with the corresponding published data.

Negative control data should consist of the incidence of micronucleated immature erythrocytes in each animal. Concurrent negative controls should ideally be within the 95 % control limits of the distribution of the laboratory's historical negative control database. Where concurrent negative control data fall outside the 95 % control limits, they may be acceptable for inclusion in the historical control distribution as long as these data are not extreme outliers and there is evidence that the test system is 'under control' (see paragraph 15) and no evidence of technical or human failure.

DESCRIPTION OF THE METHOD

Preparations

Selection of animal species

Commonly used laboratory strains of healthy young adult animals should be employed. Mice, rats, or another appropriate mammalian species may be used. When peripheral blood is used, it must be established that splenic removal of micronucleated cells from the circulation does not compromise the detection of induced micronuclei in the species selected. This has been clearly demonstrated

▼M7

for mouse and rat peripheral blood (2). The scientific justification for using species other than rats and mice should be provided in the report. If species other than rodents are used, it is recommended that the measurement of induced micronuclei be integrated into another appropriate toxicity test.

Animal housing and feeding conditions

For rodents, the temperature in the animal room should be 22 °C (\pm 3 °C). Although the relative humidity ideally should be 50-60 %, it should be at least 40 % and preferably not exceed 70 % other than during room cleaning. Lighting should be artificial, the sequence being 12 hours light, 12 hours dark. For feeding, conventional laboratory diets may be used with an unlimited supply of drinking water. The choice of diet may be influenced by the need to ensure a suitable admixture of a test chemical when administered by this route. Rodents should be housed in small groups (no more than five per cage) of the same sex and treatment group if no aggressive behaviour is expected, preferably in solid floor cages with appropriate environmental enrichment. Animals may be housed individually only if scientifically justified.

Preparation of the animals

Healthy young adult animals (for rodents, ideally 6-10 weeks old at start of treatment, though slightly older animals are also acceptable) are normally used, and are randomly assigned to the control and treatment groups. The individual animals are identified uniquely using a humane, minimally invasive method (e.g. by ringing, tagging, micro-chipping or biometric identification, but not ear or toe clipping) and acclimated to the laboratory conditions for at least five days. Cages should be arranged in such a way that possible effects due to cage placement are minimised. Cross contamination by the positive control and the test chemical should be avoided. At the commencement of the study, the weight variation of animals should be minimal and not exceed \pm 20 % of the mean weight of each sex.

Preparation of doses

Solid test chemicals should be dissolved or suspended in appropriate solvents or vehicles or admixed in diet or drinking water prior to dosing the animals. Liquid test chemicals may be dosed directly or diluted prior to dosing. For inhalation exposures, test chemicals can be administered as a gas, vapour, or a solid/liquid aerosol, depending on their physicochemical properties. Fresh preparations of the test chemical should be employed unless stability data demonstrate the acceptability of storage and define the appropriate storage conditions.

Test Conditions*Solvent/vehicle*

The solvent/vehicle should not produce toxic effects at the dose levels used, and should not be capable of chemical reaction with the test chemicals. If other than well-known solvents/vehicles are used, their inclusion should be supported with reference data indicating their compatibility. It is recommended that wherever possible, the use of an aqueous solvent/vehicle should be considered first. Examples of commonly used compatible solvents/vehicles include water, physiological saline, methylcellulose solution, carboxymethyl cellulose sodium salt solution, olive oil and corn oil. In the absence of historical or published control data showing that no micronuclei and other deleterious effects are induced by a chosen atypical solvent/vehicle, an initial study should be conducted in order to establish the acceptability of the solvent/vehicle control.

▼ **M7****Controls***Positive controls*

A group of animals treated with a positive control chemical should normally be included with each test. This may be waived when the testing laboratory has demonstrated proficiency in the conduct of the test and has established a historical positive control range. When a concurrent positive control group is not included, scoring controls (fixed and unstained slides or cell suspension samples, as appropriate for the method of scoring) should be included in each experiment. These can be obtained by including within the scoring of the study appropriate reference samples that have been obtained and stored from a separate positive control experiment conducted periodically (e.g. every 6-18 months); for example, during proficiency testing and on a regular basis thereafter, where necessary.

Positive control chemicals should reliably produce a detectable increase in micronucleus frequency over the spontaneous level. When employing manual scoring by microscopy, positive control doses should be chosen so that the effects are clear but do not immediately reveal the identity of the coded samples to the scorer. It is acceptable that the positive control be administered by a route different from the test chemical, using a different treatment schedule, and for sampling to occur only at a single time point. In addition, the use of chemical class-related positive control chemicals may be considered, when appropriate. Examples of positive control chemicals are included in Table 1.

*Table 1***Examples of positive control chemicals**

Chemicals and CASRN
Ethyl methanesulphonate [CASRN 62-50-0]
Methyl methanesulphonate [CASRN 66-27-3]
Ethyl nitrosourea [CASRN 759-73-9]
Mitomycin C [CASRN 50-07-7]
Cyclophosphamide (monohydrate) [CASRN 50-18-0 (CASRN 6055-19-2)]
Triethylenemelamine [CASRN 51-18-3]
Colechicine [CASRN 64-86-8] or Vinblastine [CASRN 865-21-4] — as aneugens

Negative controls

Negative control group animals should be included at every sampling time and otherwise handled in the same way as the treatment groups, except for not receiving treatment with the test chemical. If a solvent/vehicle is used in administering the test chemical, the control group should receive this solvent/vehicle. However, if consistent inter-animal variability and frequencies of cells with micronuclei are demonstrated by historical negative control data at each sampling time for the testing laboratory, only a single sampling for the negative control may be necessary. Where a single sampling is used for negative controls, it should be the first sampling time used in the study.

▼ M7

If peripheral blood is used, a pre-treatment sample is acceptable instead of a concurrent negative control for short-term studies when the resulting data are consistent with the historical control database for the testing laboratory. It has been shown for rats that pre-treatment sampling of small volumes (e.g. below 100 µl/day) has minimal impact on micronucleus background frequency (25).

PROCEDURE**Number and sex of animals**

In general, the micronucleus response is similar between male and female animals and, therefore, most studies could be performed in either sex (26). Data demonstrating relevant differences between males and females (e.g. differences in systemic toxicity, metabolism, bioavailability, bone marrow toxicity, etc. including e.g. in a range-finding study) would encourage the use of both sexes. In this case, it may be appropriate to perform a study in both sexes, e.g. as part of a repeated dose toxicity study. It might be appropriate to use the factorial design in case both sexes are used. Details on how to analyse the data using this design are given in Appendix 2.

Group sizes at study initiation should be established with the aim of providing a minimum of 5 analysable animals of one sex, or of each sex if both are used, per group. Where human exposure to chemicals may be sex-specific, as for example with some pharmaceuticals, the test should be performed with the appropriate sex. As a guide to maximum typical animal requirements, a study in bone marrow conducted according to the parameters established in paragraph 37 with three dose groups and concurrent negative and positive controls (each group composed of five animals of a single sex) would require between 25 and 35 animals.

Dose levels

If a preliminary range-finding study is performed because there are no suitable data already available to aid in dose selection, it should be performed in the same laboratory, using the same species, strain, sex, and treatment regimen to be used in the main study (27). The study should aim to identify the maximum tolerated dose (MTD), defined as the highest dose that will be tolerated without evidence of study-limiting toxicity, relative to the duration of the study period (for example, by inducing body weight depression or hematopoietic system cytotoxicity, but not death or evidence of pain, suffering or distress necessitating humane euthanasia (28)).

The highest dose may also be defined as a dose that produces toxicity in the bone marrow (e.g. a reduction in the proportion of immature erythrocytes among total erythrocytes in the bone marrow or peripheral blood of more than 50 %, but to not less than 20 % of the control value). However, when analysing CD71-positive cells in peripheral blood circulation (i.e., by flow cytometry), this very young fraction of immature erythrocytes responds to toxic challenges more quickly than the larger RNA-positive cohort of immature erythrocytes. Therefore, higher apparent toxicity may be evident with acute exposure designs examining the CD71-positive immature erythrocyte fraction as compared to those that identify immature erythrocytes based on RNA content. For this reason, when experiments utilise five or fewer days of treatment, the highest dose level for test chemicals causing toxicity may be defined as the dose that causes a statistically significant reduction in the proportion of CD71-positive immature erythrocytes among total erythrocytes but not to less than 5 % of the control value (29).

▼M7

Chemicals that exhibit saturation of toxicokinetic properties, or induce detoxification processes that may lead to a decrease in exposure after long-term administration may be exceptions to the dose-setting criteria and should be evaluated on a case-by-case basis.

In order to obtain dose response information, a complete study should include a negative control group and a minimum of three dose levels generally separated by a factor of 2, but not greater than 4. If the test chemical does not produce toxicity in a range-finding study or based on existing data, the highest dose for an administration period of 14 days or more should be 1 000 mg/kg body weight/day, or for administration periods of less than 14 days, 2 000 mg/kg/body weight/day. However, if the test chemical does cause toxicity, the MTD should be the highest dose administered and the dose levels used should preferably cover a range from the maximum to a dose producing little or no toxicity. When target tissue (bone marrow) toxicity is observed at all dose levels tested, further study at non-toxic doses is advisable. Studies intending to more fully characterise the quantitative dose-response information may require additional dose groups. For certain types of test chemicals (e.g. human pharmaceuticals) covered by specific requirements, these limits may vary.

Limit test

If dose range-finding experiments, or existing data from related animal strains, indicate that a treatment regime of at least the limit dose (described below) produces no observable toxic effects, (including no depression of bone marrow proliferation or other evidence of target tissue cytotoxicity), and if genotoxicity would not be expected based upon *in vitro* genotoxicity studies or data from structurally related chemicals, then a full study using three dose levels may not be considered necessary, provided it has been demonstrated that the test chemical(s) reach(es) the target tissue (bone marrow). In such cases, a single dose level, at the limit dose, may be sufficient. When administration occurs for 14 days or more, the limit dose is 1 000 mg/kg body weight/day. For administration periods of less than 14 days, the limit dose is 2 000 mg/kg/body weight/day.

Administration of doses

The anticipated route of human exposure should be considered when designing an assay. Therefore, routes of exposure such as dietary, drinking water, topical subcutaneous, intravenous, oral (by gavage), inhalation, intratracheal, or implantation may be chosen as justified. In any case, the route should be chosen to ensure adequate exposure of the target tissue(s). Intraperitoneal injection is generally not recommended since it is not an intended route of human exposure, and should only be used with specific scientific justification. If the test chemical is admixed in diet or drinking water, especially in case of single dosing, care should be taken that the delay between food and water consumption and sampling should be sufficient to allow detection of the effects (see paragraph 37). The maximum volume of liquid that can be administered by gavage or injection at one time depends on the size of the test animal. The volume should not normally exceed 1 ml/100 g body weight except in the case of aqueous solutions where a maximum of 2 ml/100 g may be used. The use of volumes greater than this should be justified. Except for irritating or corrosive test chemicals, which will normally produce exacerbated effects at higher concentrations, variability in test volume should be minimised by adjusting the concentration to ensure administration of a constant volume in relation to body weight at all dose levels.

▼ M7**Treatment schedule**

Preferably, 2 or more treatments are performed, administered at 24-hour intervals, especially when integrating this test into other toxicity studies. In the alternative, single treatments can be administered, if scientifically justified (e.g. test chemicals known to block cell cycle). Test chemicals also may be administered as a split dose, i.e., two or more treatments on the same day separated by no more than 2-3 hours, to facilitate administering a large volume. Under these circumstances, or when administering the test chemical by inhalation, the sampling time should be scheduled based on the time of the last dosing or the end of exposure.

The test may be performed in mice or rats in one of three ways:

- (a) Animals are treated with the test chemical once. Samples of bone marrow are taken at least twice (from independent groups of animals), starting not earlier than 24 hours after treatment, but not extending beyond 48 hours after treatment with appropriate interval(s) between samples, unless a test chemical is known to have an exceptionally long half-life. The use of sampling times earlier than 24 hours after treatment should be justified. Samples of peripheral blood are taken at least twice (from the same group of animals), starting not earlier than 36 hours after treatment, with appropriate interval(s) following the first sample, but not extending beyond 72 hours. At the first sampling time, all dose groups should be treated and samples collected for analysis; however, at the later sampling time(s), only the highest dose needs to be administered. When a positive response is detected at one sampling time, additional sampling is not required unless quantitative dose-response information is needed. The described harvest times are a consequence of the kinetics of appearance and disappearance of the micronuclei in these 2 tissue compartments.
- (b) If 2 daily treatments are used (e.g. two treatments at 24 hour intervals), samples should be collected once between 18 and 24 hours following the final treatment for the bone marrow or once between 36 and 48 hours following the final treatment for peripheral blood (30). The described harvest times are a consequence of the kinetics of appearance and disappearance of the micronuclei in these 2 tissue compartments.
- (c) If three or more daily treatments are used (e.g. three or more treatments at approximately 24 hour intervals), bone marrow samples should be collected no later than 24 hours after the last treatment and peripheral blood should be collected no later than 40 hours after the last treatment (31). This treatment option accommodates combination of the comet assay (e.g. sampling 2-6 hours after the last treatment) with the micronucleus test, and integration of the micronucleus test with repeated-dose toxicity studies. Accumulated data suggested that micronucleus induction can be observed over these wider timeframes when 3 or more administrations have occurred (15).

Other dosing or sampling regimens may be used when relevant and scientifically justified, and to facilitate integration with other toxicity tests.

Observations

General clinical observations of the test animals should be made and clinical signs recorded at least once a day, preferably at the same time(s) each day and considering the peak period of anticipated effects after dosing. At least twice daily during the dosing period, all animals should be observed for morbidity and mortality. All animals should be weighed at study initiation, at least once a week during repeated dose studies, and at euthanasia. In studies of at least one-week duration, measurements of food consumption should be made at least weekly. If

▼ M7

the test chemical is administered via the drinking water, water consumption should be measured at each change of water and at least weekly. Animals exhibiting non-lethal indicators of excessive toxicity should be humanely euthanised prior to completion of the test period (28). Under certain circumstances, animal body temperature could be monitored, since treatment-induced hyper- and hypothermia have been implicated in producing spurious results (32) (33) (34).

Target tissue exposure

A blood sample should be taken at appropriate time(s) in order to permit investigation of the plasma levels of the test chemicals for the purposes of demonstrating that exposure of the bone marrow occurred, where warranted and where other exposure data do not exist (see paragraph 48).

Bone marrow / blood preparation

Bone marrow cells are usually obtained from the femurs or tibias of the animals immediately following humane euthanasia. Commonly, cells are removed, prepared and stained using established methods. Small volumes of peripheral blood can be obtained, according to adequate animal welfare standards, either using a method that permits survival of the test animal, such as bleeding from the tail vein or other appropriate blood vessel, or by cardiac puncture or sampling from a large vessel at animal euthanasia. For both bone marrow or peripheral blood-derived erythrocytes, depending on the method of analysis, cells may be immediately stained supravivally (16) (17) (18), smear preparations are made and then stained for microscopy, or fixed and stained appropriately for flow cytometric analysis. The use of a DNA specific stain [e.g. acridine orange (35) or Hoechst 33258 plus pyronin-Y (36)] can eliminate some of the artifacts associated with using a non-DNA specific stain. This advantage does not preclude the use of conventional stains (e.g. Giemsa for microscopic analysis). Additional systems [e.g. cellulose columns to remove nucleated cells (37) (38)] also can be used provided that these systems have been demonstrated to be compatible with sample preparation in the laboratory.

Where these methods are applicable, anti-kinetochore antibodies (39), FISH with pancentromeric DNA probes (40), or primed *in situ* labelling with pancentromere-specific primers, together with appropriate DNA counterstaining (41), can be used to identify the nature of the micronuclei (chromosome/chromosomal fragment) in order to determine whether the mechanism of micronucleus induction is due to clastogenic and/or aneugenic activity. Other methods for differentiation between clastogens and aneugens may be used if they have been shown to be effective.

Analysis (manual and automated)

All slides or samples for analysis, including those of positive and negative controls, should be independently coded before any type of analysis and should be randomised so the manual scorer is unaware of the treatment condition; such coding is not necessary when using automated scoring systems which do not rely on visual inspection and cannot be affected by operator bias. The proportion of immature among total (immature + mature) erythrocytes is determined for each animal by counting a total of at least 500 erythrocytes for bone marrow and 2 000 erythrocytes for peripheral blood (42). At least 4 000 immature erythrocytes per animal should be scored for the incidence of micronucleated immature erythrocytes (43). If the historical negative control database indicates the mean background micronucleated immature erythrocyte frequency is < 0,1 % in the testing laboratory, consideration should be given to scoring additional cells. When analysing samples, the proportion of immature erythrocytes to total erythrocytes in treated animals should not be less than 20 % of the vehicle/solvent control proportion when scoring by microscopy and not less than approximately 5 % of the vehicle/solvent control proportion

▼M7

when scoring CD71+ immature erythrocytes by cytometric methods (see paragraph 31) (29). For example, for a bone marrow assay scored by microscopy, if the control proportion of immature erythrocytes in the bone marrow is 50 %, the upper limit of toxicity would be 10 % immature erythrocytes.

Because the rat spleen sequesters and destroys micronucleated erythrocytes, to maintain high assay sensitivity when analysing rat peripheral blood, it is preferable to restrict the analysis of micronucleated immature erythrocytes to the youngest fraction. When using automated analysis methods, these most immature erythrocytes can be identified based on their high RNA content, or the high level of transferrin receptors (CD71+) expressed on their surface (31). However, direct comparison of different staining methods has shown that satisfactory results can be obtained with various methods, including conventional acridine orange staining (3) (4).

DATA AND REPORTING**Treatment of Results**

Individual animal data should be presented in tabular form. The number of immature erythrocytes scored, the number of micronucleated immature erythrocytes, and the proportion of immature among total erythrocytes should be listed separately for each animal analysed. When mice are treated continuously for 4 weeks or more, the data on the number and proportion of micronucleated mature erythrocytes also should be given if collected. Data on animal toxicity and clinical signs should also be reported.

Acceptability Criteria

The following criteria determine the acceptability of the test:

- (a) The concurrent negative control data are considered acceptable for addition to the laboratory historical control database (see paragraphs 15-18).
- (b) The concurrent positive controls or scoring controls should induce responses that are compatible with those generated in the historical positive control database and produce a statistically significant increase compared with the concurrent negative control (see paragraphs 24-25).
- (c) The appropriate number of doses and cells has been analysed.
- (d) The criteria for the selection of highest dose are consistent with those described in paragraphs 30-33.

Evaluation and Interpretation of Results

Providing that all acceptability criteria are fulfilled, a test chemical is considered clearly positive if:

- (a) At least one of the treatment groups exhibits a statistically significant increase in the frequency of micronucleated immature erythrocytes compared with the concurrent negative control,
- (b) This increase is dose-related at least at one sampling time when evaluated with an appropriate trend test, and
- (c) Any of these results are outside the distribution of the historical negative control data (e.g. Poisson-based 95 % control limits).

▼ M7

If only the highest dose is examined at a particular sampling time, a test chemical is considered clearly positive if there is a statistically significant increase compared with the concurrent negative control and the results are outside the distribution of the historical negative control data (e.g. Poisson-based 95 % control limits). Recommendations for the most appropriate statistical methods can be found in the literature (44) (45) (46) (47). When conducting a dose-response analysis, at least three treated dose groups should be analysed. Statistical tests should use the animal as the experimental unit. Positive results in the micronucleus test indicate that a test chemical induces micronuclei, which are the result of chromosomal damage or damage to the mitotic apparatus in the erythroblasts of the test species. In the case where a test was performed to detect centromeres within micronuclei, a test chemical that produces centromere-containing micronuclei (centromeric DNA or kinetochore, indicative of whole chromosome loss) is evidence that the test chemical is an aneugen.

Providing that all acceptability criteria are fulfilled, a test chemical is considered clearly negative if, in all experimental conditions examined:

- (a) None of the treatment groups exhibits a statistically significant increase in the frequency of micronucleated immature erythrocytes compared with the concurrent negative control,
- (b) There is no dose-related increase at any sampling time when evaluated by an appropriate trend test,
- (c) All results are inside the distribution of the historical negative control data (e.g. Poisson-based 95 % control limits), and
- (d) Bone marrow exposure to the test chemical(s) occurred.

Recommendations for the most appropriate statistical methods can be found in the literature (44) (45) (46) (47). Evidence of exposure of the bone marrow to a test chemical may include a depression of the immature to mature erythrocyte ratio or measurement of the plasma or blood levels of the test chemical. In case of intravenous administration, evidence of exposure is not needed. Alternatively, ADME data, obtained in an independent study using the same route and same species can be used to demonstrate bone marrow exposure. Negative results indicate that, under the test conditions, the test chemical does not produce micronuclei in the immature erythrocytes of the test species.

There is no requirement for verification of a clear positive or clear negative response.

In cases where the response is not clearly negative or positive and in order to assist in establishing the biological relevance of a result (e.g. a weak or borderline increase), the data should be evaluated by expert judgement and/or further investigations of the existing experiments completed. In some cases, analysing more cells or performing a repeat experiment using modified experimental conditions could be useful.

In rare cases, even after further investigations, the data will preclude making a conclusion that the test chemical produces either positive or negative results, and the study will therefore be concluded as equivocal.

Test Report

The test report should include the following information:

*Summary**Test chemical:*

— source, lot number, limit date for use, if available;

▼ M7

- stability of the test chemical, if known.

Mono-constituent substance:

- physical appearance, water solubility, and additional relevant physico-chemical properties;
- chemical identification, such as IUPAC or CAS name, CAS number, SMILES or InChI code, structural formula, purity, chemical identity of impurities as appropriate and practically feasible, etc.

Multi-constituent substance, UVCBs and mixtures:

- characterised as far as possible by chemical identity (see above), quantitative occurrence and relevant physicochemical properties of the constituents.

Test chemical preparation:

- justification for choice of vehicle;
- solubility and stability of the test chemical in the solvent/vehicle, if known;
- preparation of dietary, drinking water or inhalation formulations;
- analytical determinations on formulations (e.g. stability, homogeneity, nominal concentrations), when conducted.

Test animals:

- species/strain used and justification for use;
- number, age and sex of animals;
- source, housing conditions, diet, etc.;
- method for uniquely identifying the animals;
- for short term studies: individual weight of the animals at the start and end of the test; for studies longer than one week: individual body weights during the study and food consumption. Body weight range, mean and standard deviation for each group should be included.

Test conditions:

- positive and negative (vehicle/solvent) control data;
- data from range-finding study, if conducted;
- rationale for dose level selection;
- details of test chemical preparation;
- details of the administration of the test chemical;
- rationale for route and duration of administration;
- methods for verifying that the test chemical(s) reached the general circulation or target tissue;

▼M7

- actual dose (mg/kg body weight/day) calculated from diet/drinking water test chemical concentration (ppm) and consumption, if applicable;
- details of food and water quality;
- method of euthanasia;
- method of analgesia (where used);
- detailed description of treatment and sampling schedules and justifications for the choices;
- methods of slide preparation;
- procedures for isolating and preserving samples;
- methods for measurement of toxicity;
- criteria for scoring micronucleated immature erythrocytes;
- number of cells analysed per animal in determining the frequency of micronucleated immature erythrocytes and for determining the proportion of immature to mature erythrocytes;
- criteria for acceptability of the study;
- methods, such as use of anti-kinetochore antibodies or centromere-specific DNA probes, to characterise whether micronuclei contain whole or fragmented chromosomes, if applicable.

Results:

- animal condition prior to and throughout the test period, including signs of toxicity;
- proportion of immature erythrocytes among total erythrocytes;
- number of micronucleated immature erythrocytes, given separately for each animal;
- mean \pm standard deviation of micronucleated immature erythrocytes per group;
- dose-response relationship, where possible;
- statistical analyses and methods applied;
- concurrent negative and positive control data with ranges, means and standard deviations;
- historical negative and positive control data with ranges, means, standard deviations and 95 % control limits for the distribution, as well as the time period covered and the number of data points;
- data supporting that exposure of the bone marrow occurred;
- characterisation data indicating whether micronuclei contain whole or fragmented chromosomes, if applicable;
- criteria for a positive or negative response that are met.

▼ M7

Discussion of the results.

Conclusion.

References.

LITERATURE:

- (1) OECD (2016). Overview of the set of OECD Genetic Toxicology Test Guidelines and updates performed in 2014-2015. ENV Publications. Series on Testing and Assessment, No. 234, OECD, Paris.
- (2) Hayashi, M. *et al.* (2007), *in vivo* erythrocyte micronucleus assay III. Validation and regulatory acceptance of automated scoring and the use of rat peripheral blood reticulocytes, with discussion of non-hematopoietic target cells and a single dose-level limit test, *Mutation Research/Genetic Toxicology and Environmental Mutagenesis*, Vol. 627/1, pp. 10-30.
- (3) MacGregor, J.T. *et al.* (2006), Flow cytometric analysis of micronuclei in peripheral blood reticulocytes: II. An efficient method of monitoring chromosomal damage in the rat, *Toxicology Sciences*, Vol. 94/1, pp. 92-107.
- (4) Dertinger, S.D. *et al.* (2006), Flow cytometric analysis of micronuclei in peripheral blood reticulocytes: I. Intra- and interlaboratory comparison with microscopic scoring, *Toxicological Sciences*, Vol. 94/1, pp. 83-91.
- (5) Dertinger, S.D. *et al.* (2011), Flow cytometric scoring of micronucleated erythrocytes: an efficient platform for assessing *in vivo* cytogenetic damage, *Mutagenesis*, Vol. 26/1, pp. 139-145.
- (6) Parton, J.W., W.P. Hoffman, M.L. Garriott (1996), Validation of an automated image analysis micronucleus scoring system, *Mutation Research*, Vol. 370/1, pp. 65-73.
- (7) Asano, N. *et al.* (1998), An automated new technique for scoring the rodent micronucleus assay: computerized image analysis of acridine orange supravivally stained peripheral blood cells, *Mutation Research/Fundamental and Molecular Mechanisms of Mutagenesis*, Vol. 404/1-2, pp. 149-154.
- (8) Styles, J.A. *et al.* (2001), Automation of mouse micronucleus genotoxicity assay by laser scanning cytometry, *Cytometry*, Vol. 44/2, pp. 153-155.
- (9) Heddle, J.A. (1973), A rapid *in vivo* test for chromosomal damage, *Mutation Research/Fundamental and Molecular Mechanisms of Mutagenesis*, Vol. 18/2, pp. 187-190.
- (10) Schmid, W. (1975), The micronucleus test, *Mutation Research*, Vol. 31/1, pp. 9-15.
- (11) Heddle, J.A. *et al.* (1983), The induction of micronuclei as a measure of genotoxicity. A report of the U.S. Environmental Protection Agency Gene-Tox Program, *Mutation Research/Reviews in Genetic Toxicology*, Vol. 123/1, pp. 61-118.
- (12) Mavournin, K.H. *et al.* (1990), The *in vivo* micronucleus assay in mammalian bone marrow and peripheral blood. A report of the U.S. Environmental Protection Agency Gene-Tox Program, *Mutation Research/Reviews in Genetic Toxicology*, Vol. 239/1, pp. 29-80.
- (13) MacGregor, J.T. *et al.* (1983), Micronuclei in circulating erythrocytes: a rapid screen for chromosomal damage during routine toxicity testing in mice, *Developments in Toxicology Environmental Science*, Vol. 11, pp. 555-558.

▼ M7

- (14) MacGregor, J.T. *et al.* (1987), Guidelines for the conduct of micronucleus assays in mammalian bone marrow erythrocytes, *Mutation Research/Genetic Toxicology*, Vol. 189/2, pp. 103-112.
- (15) MacGregor, J.T. *et al.* (1990), The *in vivo* erythrocyte micronucleus test: measurement at steady state increases assay efficiency and permits integration with toxicity studies, *Fundamental and Applied Toxicology*, Vol. 14/3, pp. 513-522.
- (16) Hayashi, M. *et al.* (1990), The micronucleus assay with mouse peripheral blood reticulocytes using acridine orange-coated slides, *Mutation Research/Genetic Toxicology*, Vol. 245/4, pp. 245-249.
- (17) CSGMT/JEMS.MMS — The Collaborative Study Group for the Micronucleus Test (1992), Micronucleus test with mouse peripheral blood erythrocytes by acridine orange supravital staining: the summary report of the 5th collaborative study, *Mutation Research/Genetic Toxicology*, Vol. 278/2-3, pp. 83-98.
- (18) CSGMT/JEMS.MMS — The Mammalian Mutagenesis Study Group of the Environmental Mutagen Society of Japan (1995), Protocol recommended by the CSGMT/JEMS.MMS for the short-term mouse peripheral blood micronucleus test. The Collaborative Study Group for the Micronucleus Test (CSGMT) (CSGMT/JEMS.MMS, The Mammalian Mutagenesis Study Group of the Environmental Mutagen Society of Japan), *Mutagenesis*, Vol. 10/3, pp. 153-159.
- (19) Salamone, M.F., K.H. Mavournin (1994), Bone marrow micronucleus assay: a review of the mouse stocks used and their published mean spontaneous micronucleus frequencies, *Environmental and Molecular Mutagenesis*, Vol. 23/4, pp. 239-273.
- (20) Krishna, G., G. Urda, J. Paulissen (2000), Historical vehicle and positive control micronucleus data in mice and rats, *Mutation Research/Fundamental and Molecular Mechanisms of Mutagenesis*, Vol. 453/1, pp. 45-50.
- (21) Hayes, J. *et al.* (2009), The rat bone marrow micronucleus test—study design and statistical power, *Mutagenesis*, Vol. 24/5, pp. 419-424.
- (22) Wakata, A. *et al.* (1998), Evaluation of the rat micronucleus test with bone marrow and peripheral blood: summary of the 9th collaborative study by CSGMT/JEMS. MMS. Collaborative Study Group for the Micronucleus Test. Environmental Mutagen Society of Japan. Mammalian Mutagenicity Study Group, *Environmental and Molecular Mutagenesis*, Vol. 32/1, pp. 84-100.
- (23) Ryan, T.P. (2000), *Statistical Methods for Quality Improvement*, 2nd ed., John Wiley and Sons, New York.
- (24) Hayashi, M. *et al.* (2011), Compilation and use of genetic toxicity historical control data, *Mutation Research/Fundamental and Molecular Mechanisms of Mutagenesis*, Vol. 723/2, pp. 87-90.
- (25) Rothfuss, A. *et al.* (2011), Improvement of *in vivo* genotoxicity assessment: combination of acute tests and integration into standard toxicity testing, *Mutation Research/Genetic Toxicology and Environmental Mutagenesis*, Vol. 723/2, pp. 108-120.
- (26) Hayashi, M. *et al.* (1994), *in vivo* rodent erythrocyte micronucleus assay, *Mutation Research/Environmental Mutagenesis and Related Subjects*, Vol. 312/3, pp. 293-304.
- (27) Fielder, R.J. *et al.* (1992), Report of British Toxicology Society/UK Environmental Mutagen Society Working Group. Dose setting in *in vivo* mutagenicity assays, *Mutagenesis*, Vol. 7/5, pp. 313-319.

▼ M7

- (28) OECD (2000), 'Guidance Document on the Recognition, Assessment and Use of Clinical Signs as Humane Endpoints for Experimental Animals Used in Safety Evaluation', OECD Environment, Health and Safety Publications (EHS), Series on Testing and Assessment, No. 19, OECD Publishing, Paris.
- (29) LeBaron, M.J. *et al.* (2013), Influence of counting methodology on erythrocyte ratios in the mouse micronucleus test, *Environmental and Molecular Mutagenesis*, Vol. 54/3, pp. 222-228.
- (30) Higashikuni, N., S. Sutou (1995), An optimal, generalized sampling time of 30 +/- 6 h after double dosing in the mouse peripheral blood micronucleus test, *Mutagenesis*, Vol. 10/4, pp. 313-319.
- (31) Hayashi, M. *et al.* (2000), *in vivo* rodent erythrocyte micronucleus assay. II. Some aspects of protocol design including repeated treatments, integration with toxicity testing, and automated scoring, *Environmental and Molecular Mutagenesis*, Vol. 35/3, pp. 234-252.
- (32) Asanami, S., K. Shimono (1997), High body temperature induces micronuclei in mouse bone marrow, *Mutation Research/Genetic Toxicology and Environmental Mutagenesis*, Vol. 390/1-2, pp. 79-83.
- (33) Asanami, S., K. Shimono, S. Kaneda (1998), Transient hypothermia induces micronuclei in mice, *Mutation Research/Genetic Toxicology and Environmental Mutagenesis*, Vol. 413/1, pp. 7-14.
- (34) Spencer, P.J. *et al.* (2007), Induction of micronuclei by phenol in the mouse bone marrow: I. Association with chemically induced hypothermia, *Toxicological Sciences*, Vol. 97/1, pp. 120-127.
- (35) Hayashi, M., T. Sofuni, M. Jr. Ishidate (1983), An application of Acridine Orange fluorescent staining to the micronucleus test, *Mutation Research Letters*, Vol. 120/4, pp. 241-247.
- (36) MacGregor, J.T., C.M. Wehr, R.G. Langlois (1983), A simple fluorescent staining procedure for micronuclei and RNA in erythrocytes using Hoechst 33258 and pyronin Y, *Mutation Research*, Vol. 120/4, pp. 269-275.
- (37) Romagna, F., C.D. Staniforth (1989), The automated bone marrow micronucleus test, *Mutation Research/Fundamental and Molecular Mechanisms of Mutagenesis*, Vol. 213/1, pp. 91-104.
- (38) Sun, J.T., M.J. Armstrong, S.M. Galloway (1999), Rapid method for improving slide quality in the bone marrow micronucleus assay; an adapted cellulose column procedure, *Mutation Research*, Vol. 439/1, pp. 121-126.
- (39) Miller, B.M., I.D. Adler (1990), Application of antikinetochores antibody staining (CREST staining) to micronuclei in erythrocytes induced *in vivo*, *Mutagenesis*, Vol. 5/4, pp. 411-415.
- (40) Miller, B.M. *et al.* (1991), Classification of micronuclei in murine erythrocytes: immunofluorescent staining using CREST antibodies compared to *in situ* hybridization with biotinylated gamma satellite DNA, *Mutagenesis*, Vol. 6/4, pp. 297-302.
- (41) Russo, A. (2002), PRINS tandem labeling of satellite DNA in the study of chromosome damage, *American Journal of Medical Genetics*, Vol. 107/2, pp. 99-104.
- (42) Gollapudi, B.B., L.G. McFadden (1995), Sample size for the estimation of polychromatic to normochromatic erythrocyte ratio in the bone marrow micronucleus test, *Mutation Research*, Vol. 347/2, pp. 97-99.
- (43) OECD (2014), 'Statistical analysis supporting the revision of the genotoxicity Test Guidelines', OECD Environment, Health and Safety Publications (EHS), Series on Testing and Assessment, No. 198, OECD Publishing, Paris.

▼M7

- (44) Richold, M. *et al.* (1990), 'In Vivo Cytogenetics Assays', in Basic Mutagenicity Tests, UKEMS Recommended Procedures. UKEMS Subcommittee on Guidelines for Mutagenicity Testing. Report. Part I revised, Kirkland, D.J. (ed.), Cambridge University Press, Cambridge, pp. 115-141.
- (45) Lovell, D.P. *et al.* (1989), 'Statistical Analysis of *in vivo* Cytogenetic Assays', in Statistical Evaluation of Mutagenicity Test Data. UKEMS Subcommittee on Guidelines for Mutagenicity Testing, Report, Part III, Kirkland, D.J. (ed.), Cambridge University Press, Cambridge, pp. 184-232.
- (46) Hayashi, M. *et al.* (1994), Statistical analysis of data in mutagenicity assays: rodent micronucleus assay, Environmental Health Perspectives, Vol. 102/Suppl 1, pp. 49-52.
- (47) Kim, B.S., M. Cho, H.J. Kim (2000), Statistical analysis of *in vivo* rodent micronucleus assay, Mutation Research/Genetic Toxicology and Environmental Mutagenesis, Vol. 469/2, pp. 233-241.

▼ **M7***Appendix 1*

DEFINITIONS

Centromere: Region(s) of a chromosome with which spindle fibers are associated during cell division, allowing orderly movement of daughter chromosomes to the poles of the daughter cells.

Chemical: a substance or a mixture.

Erythroblast: An early stage of erythrocyte development, immediately preceding the immature erythrocyte, where the cell still contains a nucleus.

Kinetochore: The protein structure that forms on the centromere of eukaryotic cells, which links the chromosome to microtubule polymers from the mitotic spindle during mitosis and meiosis and functions during cell division to pull sister chromatids apart.

Micronuclei: Small nuclei, separate from and additional to the main nuclei of cells, produced during telophase of mitosis (meiosis) by lagging chromosome fragments or whole chromosomes.

Normochromatic or mature erythrocyte: A fully matured erythrocyte that has lost the residual RNA that remains after enucleation and/or has lost other short-lived cell markers that characteristically disappear after enucleation following the final erythroblast division.

Polychromatic or immature erythrocyte: A newly formed erythrocyte in an intermediate stage of development, that stains with both the blue and red components of classical blood stains such as Wright's Giemsa because of the presence of residual RNA in the newly-formed cell. Such newly formed cells are approximately the same as reticulocytes, which are visualised using a vital stain that causes the residual RNA to clump into a reticulum. Other methods, including monochromatic staining of RNA with fluorescent dyes or labeling of short-lived surface markers such as CD71 with fluorescent antibodies, are now often used to identify the newly formed red blood cell. Polychromatic erythrocytes, reticulocytes, and CD71-positive erythrocytes are all immature erythrocytes, though each has a somewhat different age distribution.

Reticulocyte: A newly formed erythrocyte stained with a vital stain that causes residual cellular RNA to clump into a characteristic reticulum. Reticulocytes and polychromatic erythrocytes have a similar cellular age distribution.

Test chemical: Any substance or mixture tested using this test method.

▼ **M7***Appendix 2***THE FACTORIAL DESIGN FOR IDENTIFYING SEX DIFFERENCES IN THE *IN VIVO* MICRONUCLEUS ASSAY****The factorial design and its analysis**

In this design, a minimum of 5 males and 5 females are tested at each concentration level resulting in a design using a minimum of 40 animals (20 males and 20 females, plus relevant positive controls).

The design, which is one of the simpler factorial designs, is equivalent to a two-way analysis of variance with sex and concentration level as the main effects. The data can be analysed using many standard statistical software packages such as SPSS, SAS, STATA, Genstat as well as using R.

The analysis partitions the variability in the dataset into that between the sexes, that between the concentrations and that related to the interaction between the sexes and the concentrations. Each of the terms is tested against an estimate of the variability between the replicate animals within the groups of animals of the same sex given the same concentration. Full details of the underlying methodology are available in many standard statistical textbooks (see references) and in the 'help' facilities provided with statistical packages.

The analysis proceeds by inspecting the sex x concentration interaction term in the ANOVA table⁽¹⁾. In the absence of a significant interaction term the combined values across sexes or across concentration levels provide valid statistical tests between the levels based upon the pooled within group variability term of the ANOVA.

The analysis continues by partitioning the estimate of the between concentrations variability into contrasts which provide for a test for linear and quadratic contrasts of the responses across the concentration levels. When there is a significant sex x concentration interaction this term can also be partitioned into linear x sex and quadratic x sex interaction contrasts. These terms provide tests of whether the concentration responses are parallel for the two sexes or whether there is a differential response between the two sexes.

The estimate of the pooled within group variability can be used to provide pair-wise tests of the difference between means. These comparisons could be made between the means for the two sexes and between the means for the different concentration levels such as for comparisons with the negative control levels. In those cases where there is a significant interaction comparisons can be made between the means of different concentrations within a sex or between the means of the sexes at the same concentration.

References

There are many statistical textbooks which discuss the theory, design, methodology, analysis and interpretation of factorial designs ranging from the simplest two factor analyses to the more complex forms used in Design of Experiment methodology. The following is a non-exhaustive list. Some books provide worked examples of comparable designs, in some cases with code for running the analyses using various software packages.

⁽¹⁾ Statisticians who take a modelling approach such as using General Linear Models (GLMs) may approach the analysis in a different but comparable way but will not necessarily derive the traditional ANOVA table, which dates back to algorithmic approaches to calculating the statistics developed in a pre-computer age.

▼M7

Box, G.E.P, Hunter, W.G. and Hunter, J.S. (1978). *Statistics for Experimenters. An Introduction to Design, Data Analysis, and Model Building*. New York: John Wiley & Sons.

Box G.E.P. & Draper, N.R. (1987). *Empirical model-building and response surfaces*. John Wiley & Sons Inc.

Doncaster, C.P. & Davey, A.J.H. (2007). *Analysis of Variance and Covariance: How to Choose and Construct Models for the Life Sciences*. Cambridge University Press.

Mead, R. (1990). *The Design of Experiments. Statistical principles for practical application*. Cambridge University Press.

Montgomery D.C. (1997). *Design and Analysis of Experiments*. John Wiley & Sons Inc.

Winer, B.J. (1971). *Statistical Principles in Experimental Design*. McGraw Hill.

Wu, C.F.J & Hamada, M.S. (2009). *Experiments: Planning, Analysis and Optimization*. John Wiley & Sons Inc.

▼B**B.13/14. MUTAGENICITY: REVERSE MUTATION TEST USING BACTERIA****1. METHOD**

This method is a replicate of the OECD TG 471, Bacterial Reverse Mutation Test (1997).

1.1. INTRODUCTION

The bacterial reverse mutation test uses amino-acid requiring strains of *Salmonella typhimurium* and *Escherichia coli* to detect point mutations, which involve substitution, addition or deletion of one or a few DNA base pairs (1)(2)(3). The principle of this bacterial reverse mutation test is that it detects mutations, which revert mutations present in the test strains and restore the functional capability of the bacteria to synthesise an essential amino acid. The revertant bacteria are detected by their ability to grow in the absence of the amino-acid required by the parent test strain.

Point mutations are the cause of many human genetic diseases and there is substantial evidence that point mutations in oncogenes and tumour-suppressor genes of somatic cells are involved in tumour formation in humans and experimental animals. The bacterial reverse mutation test is rapid, inexpensive and relatively easy to perform. Many of the test strains have several features that make them more sensitive for the detection of mutations including responsive DNA sequences at the reversion sites, increased cell permeability to large molecules and elimination of DNA repair systems or enhancement of error-prone DNA repair processes. The specificity of the test strains can provide some useful information on the types of mutations that are induced by genotoxic agents. A very large data base of results for a wide variety of structures is available for bacterial reverse mutation tests and well-established methodologies have been developed for testing chemicals with different physico-chemical properties, including volatile compounds.

See also General introduction Part B.

1.2. DEFINITIONS

A reverse mutation test in either *Salmonella typhimurium* or *Escherichia coli* detects mutation in an amino-acid requiring strain (histidine or tryptophan, respectively) to produce a strain independent of an outside supply of amino-acid.

Base pair substitution mutagens are agents that cause a base change in DNA. In a reversion test this change may occur at the site of the original mutation, or at a second site in the bacterial genome.

Frameshift mutagens are agents that cause the addition or deletion of one or more base pairs in the DNA, thus changing the reading frame in the RNA.

▼B

1.3. INITIAL CONSIDERATIONS

The bacterial reverse mutation test utilises prokaryotic cells, which differ from mammalian cells in such factors as uptake, metabolism, chromosome structure and DNA repair processes. Tests conducted *in vitro* generally require the use of an exogenous source of metabolic activation. *In vitro* metabolic activation systems cannot mimic entirely the mammalian *in vivo* conditions. The test therefore does not provide direct information on the mutagenic and carcinogenic potency of a substance in mammals.

The bacterial reverse mutation test is commonly employed as an initial screen for genotoxic activity and, in particular, for point mutation-inducing activity. An extensive database has demonstrated that many chemicals that are positive in this test also exhibit mutagenic activity in other tests. There are examples of mutagenic agents, which are not detected by this test; reasons for these shortcomings can be ascribed to the specific nature of the endpoint detected, differences in metabolic activation, or differences in bioavailability. On the other hand, factors, which enhance the sensitivity of the bacterial reverse mutation test can lead to an overestimation of mutagenic activity.

The bacterial reverse mutation test may not be appropriate for the evaluation of certain classes of chemicals, for example highly bactericidal compounds (e.g. certain antibiotics) and those which are thought (or known) to interfere specifically with the mammalian cell replication system (e.g. some topoisomerase inhibitors and some nucleoside analogues). In such cases, mammalian mutation tests may be more appropriate.

Although many compounds that are positive in this test are mammalian carcinogens, the correlation is not absolute. It is dependent on chemical class and there are carcinogens that are not detected by this test because they act through other, non-genotoxic, mechanisms or mechanisms absent in bacterial cells.

1.4. PRINCIPLE OF THE TEST METHOD

Suspensions of bacterial cells are exposed to the test substance in the presence and in the absence of an exogenous metabolic activation system. In the plate incorporation method, these suspensions are mixed with an overlay agar and plated immediately onto minimal medium. In the preincubation method, the treatment mixture is incubated and then mixed with an overlay agar before plating onto minimal medium. For both techniques, after two or three days of incubation, revertant colonies are counted and compared to the number of spontaneous revertant colonies on solvent control plates.

Several procedures for performing the bacterial reverse mutation test have been described. Among those commonly used are the plate incorporation method (1)(2)(3)(4), the preincubation method (2)(3)(5)(6)(7)(8), the fluctuation method (9)(10), and the suspension method (11). Modifications for the testing of gases or vapours have been described (12).

▼B

The procedures described in the method pertain primarily to the plate incorporation and preincubation methods. Either of them is acceptable for conducting experiments both with and without metabolic activation. Some substances may be detected more efficiently using the preincubation method. These substances belong to chemical classes that include short chain aliphatic nitrosamines, divalent metals, aldehydes, azo-dyes and diazo compounds, pyrrolizidine alkaloids, allyl compounds and nitro compounds (3). It is also recognised that certain classes of mutagens are not always detected using standard procedures such as the plate incorporation method or preincubation method. These should be regarded as 'special cases' and it is strongly recommended that alternative procedures should be used for their detection. The following 'special cases' could be identified (together with examples of procedures that could be used for their detection): azo-dyes and diazo compounds (3)(5)(6)(13), gases and volatile chemicals (12)(14)(15)(16) and glycosides (17)(18). A deviation from the standard procedure needs to be scientifically justified.

1.5. DESCRIPTION OF THE TEST METHOD

1.5.1. **Preparations**1.5.1.1. *Bacteria*

Fresh cultures of bacteria should be grown up to the late exponential or early stationary phase of growth (approximately 10^9 cells per ml). Cultures in late stationary phase should not be used. It is essential that the cultures used in the experiment contain a high titre of viable bacteria. The titre may be demonstrated either from historical control data on growth curves, or in each assay through the determination of viable cell numbers by a plating experiment.

The recommended incubation temperature is 37 °C.

At least five strains of bacteria should be used. These should include four strains of *S. typhimurium* (TA 1535; TA 1537 or TA97a or TA97; TA98; and TA100) that have been shown to be reliable and reproducibly responsive between laboratories. These four *S. typhimurium* strains have GC base pairs at the primary reversion site and it is known that may not detect certain oxidising mutagens, cross-linking agents and hydrazines. Such substances may be detected by *E. coli* WP2 strains or *S. typhimurium* TA102 (19), which have an AT base pair at the primary reversion site. Therefore the recommended combination of strains is:

— *S. typhimurium* TA1535, and

— *S. typhimurium* TA1537 or TA97 or TA97a, and

— *S. typhimurium* TA98, and

— *S. typhimurium* TA100, and

— *E. coli* WP2 uvrA, or *E. coli* WP2 uvrA (pKM101), or *S. typhimurium* TA102.

In order to detect cross-linking mutagens it may be preferable to include TA102 or to add a DNA repair-proficient strain of *E. coli* [e.g. *E. coli* WP2 or *E. coli* WP2 (pKM101)]

▼ B

Established procedures for stock culture preparation, marker verification and storage should be used. The amino-acid requirement for growth should be demonstrated for each frozen stock culture preparation (histidine for *S. typhimurium* strains, and tryptophan for *E. coli* strains). Other phenotypic characteristics should be similarly checked, namely: the presence or absence of R-factor plasmids where appropriate [i.e. ampicillin resistance in strains TA98, TA100 and TA97a or TA97, WP2 uvrA and WP2 uvrA (pKM101), and ampicillin + tetracycline resistance in strain TA102]; the presence of characteristic mutations (i.e. rfa mutation in *S. typhimurium* through sensitivity to crystal violet, and uvrA mutation in *E. coli* or uvrB mutation in *S. typhimurium*, through sensitivity to ultraviolet light) (2)(3). The strains should also yield spontaneous revertant colony plate counts within the frequency ranges expected from the laboratory's historical control data and preferably within the range reported in the literature.

1.5.1.2. Medium

An appropriate minimal agar (e.g. containing Vogel-Bonner minimal medium E and glucose), and an overlay agar containing histidine and biotin or tryptophan to allow for a few cell divisions, is used (1)(2)(9).

1.5.1.3. Metabolic activation

Bacteria should be exposed to the test substance both in the presence and absence of an appropriate metabolic activation system. The most commonly used system is a cofactor-supplemented post-mitochondrial fraction (S9) prepared from the livers of rodents treated with enzyme-inducing agents such as Aroclor 1254 (1)(2) or a combination of Phenobarbitone and β -naphthoflavone (18)(20)(21). The post-mitochondrial fraction is usually used at concentrations in the range from 5 to 30 % v/v in the S9-mix. The choice and condition of a metabolic activation system may depend upon the class of chemical being tested. In some cases, it may be appropriate to utilise more than one concentration of post-mitochondrial fraction. For azo-dyes and diazo-compounds, using a reductive metabolic activation system may be more appropriate (6)(13).

1.5.1.4. Test substance/Preparation

Solid test substances should be dissolved or suspended in appropriate solvents or vehicles and diluted if appropriate prior to treatment of the bacteria. Liquid test substances may be added directly to the test systems and/or diluted prior to treatment. Fresh preparations should be employed unless stability data demonstrate the acceptability of storage.

The solvent/vehicle should not be suspected of chemical reaction with the test substance and should be compatible with the survival of the bacteria and the S9 activity (22). If other than well-known solvent/vehicles are used, their inclusion should be supported by data indicating their compatibility. It is recommended that wherever possible, the use of an aqueous solvent/vehicle be considered first. When testing water-unstable substances, the organic solvents used should be free of water.

▼B1.5.2. **Test conditions**1.5.2.1. *Test strains (see 1.5.1.1)*1.5.2.2. *Exposure concentration*

Amongst the criteria to be taken into consideration when determining the highest amount of the test substance to be used are the cytotoxicity and the solubility in the final treatment mixture.

It may be useful to determine toxicity and insolubility in a preliminary experiment. Cytotoxicity may be detected by a reduction in the number of revertant colonies, a clearing or diminution of the background lawn, or the degree of survival of treated cultures. The cytotoxicity of a substance may be altered in the presence of metabolic activation systems. Insolubility should be assessed as precipitation in the final mixture under the actual test conditions and evident to the unaided eye.

The recommended maximum test concentration for soluble non-cytotoxic substances is 5 mg/plate or 5 µl/plate. For non-cytotoxic substances that are not soluble at 5 mg/plate or 5 µl/plate, one or more concentrations tested should be insoluble in the final treatment mixture. Test substances that are cytotoxic already below 5 mg/plate or 5 µl/plate should be tested up to a cytotoxic concentration. The precipitate should not interfere with the scoring.

At least five different analysable concentrations of the test substance should be used with approximately half log (i.e. $\sqrt{10}$) intervals between test points for an initial experiment. Smaller intervals may be appropriate when a concentration-response is being investigated. Testing above the concentration of 5 mg/plate or 5 µl/plate may be considered when evaluating substances containing substantial amounts of potentially mutagenic impurities.

1.5.2.3. *Negative and positive controls*

Concurrent strain-specific positive and negative (solvent or vehicle) controls, both with and without metabolic activation, should be included in each assay. Positive control concentrations that demonstrate the effective performance of each assay should be selected.

For assays employing a metabolic activation system, the positive control reference substance(s) should be selected on the basis of the type of bacteria strains used.

The following substances are examples of suitable positive controls for assays with metabolic activation:

CA numbers	EINECS numbers	Names
781-43-1	212-308-4	9,10-dimethylanthracene
57-97-6	200-359-5	7,12-dimethylbenz[a]anthracene
50-32-8	200-028-5	benzo[a]pyrene
613-13-8	210-330-9	2-aminoanthracene

▼B

CA numbers	EINECS numbers	Names
50-18-0		cyclophosphamide
6055-19-2	200-015-4	cyclophosphamide monohydrate

The following substance is a suitable positive control for the reductive metabolic activation method:

CA numbers	EINECS numbers	Names
573-58-0	209-358-4	Congo Red

2-Aminoanthracene should not be used as the sole indicator of the efficacy of the S9-mix. If 2-aminoanthracene is used, each batch of S9 should also be characterised with a mutagen that requires metabolic activation by microsomal enzymes, e.g. benzo[a]pyrene, dimethylbenzanthracene.

The following substances are examples of strain-specific positive controls for assays performed without exogenous metabolic activation system:

CAS numbers	EINECS numbers	Names	Strain
26628-22-8	247-852-1	Sodium azide	TA 1535 and TA 100
607-57-8	210-138-5	2-nitrofluorene	TA 98
90-45-9	201-995-6	9-aminoacridine	TA 1537, TA 97 and TA 97a
17070-45-0	241-129-4	ICR 191	TA 1537, TA 97 and TA 97a
80-15-9	201-254-7	Cumene hydroperoxide	TA 102
50-07-7	200-008-6	Mitomycin C	WP2 uvrA and TA102
70-25-7	200-730-1	N-ethyl-N-nitro-N-nitrosoguanidine	WP2, WP2uvrA and WP2uvrA(pKM101)
56-57-5	200-281-1	4-nitroquinoline-1-oxide	WP2, WP2uvrA and WP2uvrA(pKM101)
3688-53-7		Furylfuramide (AF2)	plasmid-containing strains

Other appropriate positive control reference substances may be used. The use of chemical class-related positive control chemicals should be considered, when available.

Negative controls, consisting of solvent or vehicle alone, without test substance, and otherwise treated in the same way as the treatment groups, should be included. In addition, untreated controls should also be used unless there are historical control data demonstrating that no deleterious or mutagenic effects are induced by the chosen solvent.

▼ B**1.5.3. Procedure**

For the plate incorporation method (1)(2)(3)(4), without metabolic activation, usually 0,05 ml or 0,1 ml of the test solutions, 0,1 ml of fresh bacterial culture (containing approximately 10^8 viable cells) and 0,5 ml of sterile buffer are mixed with 2,0 ml of overlay agar. For the assay with metabolic activation, usually 0,5 ml of metabolic activation mixture containing an adequate amount of post-mitochondrial fraction (in the range from 5 to 30 % v/v in the metabolic activation mixture) are mixed with the overlay agar (2,0 ml), together with the bacteria and test substance/test solution. The contents of each tube are mixed and poured over the surface of a minimal agar plate. The overlay agar is allowed to solidify before incubation.

For the preincubation method (2)(3)(5)(6), the test substance/test solution is preincubated with the test strain (containing approximately 10^8 viable cells) and sterile buffer or the metabolic activation system (0,5 ml) usually for 20 min. or more at 30-37 °C prior to mixing with the overlay agar and pouring onto the surface of a minimal agar plate. Usually, 0,05 or 0,1 ml of test substance/test solution, 0,1 ml of bacteria, and 0,5 ml of S9-mix or sterile buffer are mixed with 2,0 ml of overlay agar. Tubes should be aerated during pre-incubation by using a shaker.

For an adequate estimate of variation, triplicate plating should be used at each dose level. The use of duplicate plating is acceptable when scientifically justified. The occasional loss of a plate does not necessarily invalidate the assay.

Gaseous or volatile substances should be tested by appropriate methods, such as in sealed vessels (12)(14)(15)(16).

1.5.4. Incubation

All plates in a given assay should be incubated at 37 °C for 48-72 hours. After the incubation period, the number of revertant colonies per plate is counted.

2. DATA**2.1. TREATMENT OF RESULTS**

Data should be presented as the number of revertant colonies per plate. The number of revertant colonies on both negative (solvent control, and untreated control if used) and positive control plates should also be given. Individual plate counts, the mean number of revertant colonies per plate and the standard deviation should be presented for the test substance and positive and negative (untreated and/or solvent) controls.

There is no requirement for verification of a clear positive response. Equivocal results should be clarified by further testing preferably using a modification of experimental conditions. Negative results need to be confirmed on a case-by-case basis. In those cases where confirmation of negative results is not considered necessary, justification should be provided. Modification of study parameters to extend the range of conditions assessed should be considered in follow-up experiments. Study parameters that might be modified include the concentration spacing, the method of treatment (plate-incorporation or liquid pre-incubation), and metabolic activation conditions.

▼ B

2.2. EVALUATION AND INTERPRETATION OF RESULTS

There are several criteria for determining a positive result, such as a concentration-related increase over the range tested and/or a reproducible increase at one or more concentrations in the number of revertant colonies per plate in at least one strain with or without metabolic activation system (23). Biological relevance of the results should be considered first. Statistical methods may be used as an aid in evaluating the test results (24). However, statistical significance should not be the only determining factor for a positive response.

A test substance for which the results do not meet the above criteria is considered non-mutagenic in this test.

Although most experiments will give clearly positive or negative results, in rare cases the data set will preclude making a definite judgement about the activity of the test substance. Results may remain equivocal or questionable regardless of the number of times the experiment is repeated.

Positive results from the bacterial reverse mutation test indicate that the substance induces point mutations by base substitutions or frameshifts in the genome of either *Salmonella typhimurium* and/or *Escherichia coli*. Negative results indicate that under the test conditions, the test substance is not mutagenic in the tested species.

3. **REPORTING**

TEST REPORT

The test report must include the following information:

Solvent/Vehicle:

- justification for choice of solvent/vehicle,
- solubility and stability of the test substance in solvent/vehicle, if known.

Strains:

- strains used,
- number of cells per culture,
- strain characteristics.

Test conditions:

- amount of test substance per plate (mg/plate or µl/plate) with rationale for selection of dose and number of plates per concentration,
- media used,
- type and composition of metabolic activation system, including acceptability criteria,
- treatment procedures.

Results:

- signs of toxicity,
- signs of precipitation,
- individual plate counts,

▼B

- the mean number of revertant colonies per plate and standard deviation,
- dose-response relationship, where possible,
- statistical analyses, if any,
- concurrent negative (solvent/vehicle) and positive control data, with ranges, means and standard deviations,
- historical negative (solvent/vehicle) and positive control data with ranges, means and standard deviations.

Discussion of results.

Conclusions.

4. REFERENCES

- (1) Ames, B.N., McCann, J. and Yamasaki E., (1975) Methods for Detecting Carcinogens and Mutagens with the Salmonella/Mammalian-Microsome Mutagenicity Test. *Mutation Res.*, 31, p. 347-364.
- (2) Maron, D.M. and Ames, B.N., (1983) Revised Methods for the Salmonella Mutagenicity Test. *Mutation Res.*, 113, p. 173-215.
- (3) Gatehouse, D., Haworth, S., Cebula, T., Gocke, E., Kier, L., Matsushima, T., Melcion, C., Nohmi, T., Venitt, S. and Zeiger, E., (1994) Recommendations for the Performance of Bacterial Mutation Assays. *Mutation Res.*, 312, p. 217-233.
- (4) Kier, L.D., Brusick D.J., Auletta, A.E., Von Halle, E.S., Brown, M.M., Simmon, V.F., Dunkel, V., McCann, J., Mortelmans, K., Prival, M., Rao, T.K. and Ray V., (1986) The *Salmonella typhimurium*/Mammalian Microsomal Assay: A Report of the U.S. Environmental Protection Agency Gene-Tox Program. *Mutation Res.*, 168, p. 69-240.
- (5) Yahagi, T., Degawa, M., Seino, Y.Y., Matsushima, T., Nagao, M., Sugimura, T. and Hashimoto, Y., (1975) Mutagenicity of Carcinogen Azo Dyes and their Derivatives, *Cancer Letters*, 1, p. 91-96.
- (6) Matsushima, M., Sugimura, T., Nagao, M., Yahagi, T., Shirai, A. and Sawamura, M., (1980) Factors Modulating Mutagenicity Microbial Tests. In: *Short-term Test Systems for Detecting Carcinogens*. Ed. Norpoth K.H. and Garner, R.C., Springer, Berlin-Heidelberg-New York. p. 273-285.
- (7) Gatehouse, D.G., Rowland, I.R., Wilcox, P., Callender, R.D. and Foster, R., (1980) Bacterial Mutation Assays. In: *Basic Mutagenicity Tests: UKEMS Part 1 Revised*. Ed. D.J. Kirkland, Cambridge University Press, p. 13-61.
- (8) Aeschacher, H.U., Wolleb, U. and Porchet, L., (1987) Liquid Preincubation Mutagenicity Test for Foods. *J. Food Safety*, 8, p. 167-177.
- (9) Green, M.H.L., Muriel, W.J. and Bridges, B.A., (1976) Use of a simplified fluctuation test to detect low levels of mutagens. *Mutation Res.*, 38, p. 33-42.
- (10) Hubbard, S.A., Green, M.H.L., Gatehouse, D. and J.W. Bridges (1984) The Fluctuation Test in Bacteria. In: *Handbook of Mutagenicity Test Procedures*. 2nd Edition. Ed. Kilbey, B.J., Legator, M., Nichols, W. and Ramel, C., Elsevier, Amsterdam-New York-Oxford, p. 141-161.

▼B

- (11) Thompson, E.D. and Melampy, P.J., (1981) An Examination of the Quantitative Suspension Assay for Mutagenesis with Strains of *Salmonella typhimurium*. Environmental Mutagenesis, 3, p. 453-465.
- (12) Araki, A., Noguchi, T., Kato, F. and T. Matsushima (1994) Improved Method for Mutagenicity Testing of Gaseous Compounds by Using a Gas Sampling Bag. Mutation Res., 307, p. 335-344.
- (13) Prival, M.J., Bell, S.J., Mitchell, V.D., Reipert, M.D. and Vaughn, V.L., (1984) Mutagenicity of Benzidine and Benzidine-Congener Dyes and Selected Monoazo Dyes in a Modified Salmonella Assay. Mutation Res., 136, p. 33-47.
- (14) Zeiger, E., Anderson, B.E., Haworth, S., Lawlor, T. and Mortelmans, K., (1992) Salmonella Mutagenicity Tests. V. Results from the Testing of 311 Chemicals. Environ. Mol. Mutagen., 19, p. 2-141.
- (15) Simmon, V., Kauhanen, K. and Tardiff, R.G., (1977) Mutagenic Activity of Chemicals Identified in Drinking Water. In Progress in Genetic Toxicology, D. Scott, B. Bridges and F. Sobels (Eds.) Elsevier, Amsterdam, p. 249-258.
- (16) Hughes, T.J., Simmons, D.M., Monteith, I.G. and Claxton, L.D., (1987) Vaporisation Technique to Measure Mutagenic Activity of Volatile Organic Chemicals in the Ames/Salmonella Assay. Environmental Mutagenesis, 9, p. 421-441.
- (17) Matsushima, T., Matsumoto, A., Shirai, M., Sawamura, M., and Sugimura, T., (1979) Mutagenicity of the Naturally Occurring Carcinogen Cycasin and Synthetic Methylazoxy Methane Conjugates in *Salmonella typhimurium*. Cancer Res., 39, p. 3780-3782.
- (18) Tamura, G., Gold, C., Ferro-Luzzi, A. and Ames, B.N., (1980) Fecalase: A Model for Activation of Dietary Glycosides to Mutagens by Intestinal Flora. Proc. Natl. Acad. Sci. USA, 77, p. 4961-4965.
- (19) Wilcox, P., Naidoo, A., Wedd, D.J. and Gatehouse, D.G., (1990) Comparison of *Salmonella typhimurium* TA 102 with *Escherichia coli* WP2 Tester strains. Mutagenesis, 5, p. 285-291.
- (20) Matsushima, T., Sawamura, M., Hara, K. and Sugimura, T., (1976) A Safe Substitute for Polychlorinated Biphenyls as an Inducer or Metabolic Activation Systems. In: 'In vitro metabolic Activation in Mutagenesis Testing' Eds. F.J. de Serres et al. Elsevier, North Holland, p. 85-88.
- (21) Elliot, B.M., Combes, R.D., Elcombe, C.R., Gatehouse, D.G., Gibson, G.G., Mackay, J.M. and Wolf, R.C., (1992) Alternatives to Aroclor 1254-induced S9 in *in vitro* Genotoxicity Assays. Mutagenesis, 7, p. 175-177.
- (22) Maron, D., Katzenellenbogen, J. and Ames, B.N., (1981) Compatibility of Organic Solvents with the Salmonella/Microsome Test. Mutation Res., p. 88343-350.
- (23) Claxton, L.D., Allen, J., Auletta, A., Mortelmans, K., Nestmann, E. and Zeiger, E., (1987) Guide for the *Salmonella typhimurium*/Mammalian Microsome Tests for Bacterial Mutagenicity. Mutation Res. 189, p. 83-91.

▼ B

- (24) Mahon, G.A.T., Green, M.H.L., Middleton, B., Mitchell, I., Robinson, W.D. and Tweats, D.J., (1989) Analysis of Data from Microbial Colony Assays. In: UKEMS Sub-Committee on Guidelines for Mutagenicity Testing. Part II. Statistical Evaluation of Mutagenicity Test Data. Ed. Kirkland, D.J., Cambridge University Press, p. 28-65.

▼ M7

▼M8**B.17. *IN VITRO* MAMMALIAN CELL GENE MUTATION TESTS
USING THE HPRT AND XPRT GENES**

INTRODUCTION

1. This test method (TM) is equivalent to the OECD test guideline 476 (2016). Test methods are periodically reviewed in the light of scientific progress, changing regulatory needs and animal welfare. This current revised version of TM B.17 reflects nearly thirty years of experience with this test and also results from the development of a separate new method dedicated to *in vitro* mammalian cell gene mutation tests using the thymidine kinase gene. TM B.17 is part of a series of test methods on genetic toxicology. A document that provides succinct information on genetic toxicology testing and an overview of the recent changes that were made to genetic toxicity OECD test guidelines has been developed by OECD (1).
2. The purpose of the *in vitro* mammalian cell gene mutation test is to detect gene mutations induced by chemicals. The cell lines used in these tests measure forward mutations in reporter genes, specifically the endogenous hypoxanthine-guanine phosphoribosyl transferase gene (Hprt in rodent cells, HPRT in human cells; collectively referred to as the Hprt gene and HPRT test in this test method), and the xanthine-guanine phosphoribosyl transferase transgene (gpt) (referred to as the XPRT test). The HPRT and XPRT mutation tests detect different spectra of genetic events. In addition to the mutational events detected by the HPRT test (e.g. base pair substitutions, frameshifts, small deletions and insertions) the autosomal location of the gpt transgene may allow the detection of mutations resulting from large deletions and possibly mitotic recombination not detected by the HPRT test because the Hprt gene is located on the X-chromosome (2) (3) (4) (5) (6) (7). The XPRT is currently less widely used than the HPRT test for regulatory purposes.
3. Definitions used are provided in Appendix 1.

INITIAL CONSIDERATIONS AND LIMITATIONS

4. Tests conducted *in vitro* generally require the use of an exogenous source of metabolic activation. The exogenous metabolic activation system does not entirely mimic *in vivo* conditions.
5. Care should be taken to avoid conditions that would lead to artefactual positive results, (i.e. possible interaction with the test system), not caused by direct interaction between the test chemicals and the genetic material of the cell; such conditions include changes in pH or osmolality (8) (9) (10), interaction with the medium components (11) (12), or excessive levels of cytotoxicity (13). Cytotoxicity exceeding the recommended top cytotoxicity levels as defined in paragraph 19 is considered excessive for the HPRT test.

▼M8

6. Before use of the test method on a mixture for generating data for an intended regulatory purpose, it should be considered whether, and if so why, it may provide adequate results for that purpose. Such considerations are not needed when there is a regulatory requirement for testing of the mixture.

PRINCIPLE OF THE TEST

7. Mutant cells deficient in Hprt enzyme activity in the HPRT test or xprt enzyme activity in the XPRT test are resistant to the cytostatic effects of the purine analogue 6-thioguanine (TG). The Hprt (in the HPRT test) or gpt (in XPRT test) proficient cells are sensitive to TG, which causes the inhibition of cellular metabolism and halts further cell division. Thus, mutant cells are able to proliferate in the presence of TG, whereas normal cells, which contain the Hprt (in the HPRT test) or gpt (in XPRT test) enzyme, are not.
8. Cells in suspension or monolayer cultures are exposed to the test chemical, both with and without an exogenous source of metabolic activation (see paragraph 14), for a suitable period of time (3-6 hours), and then sub-cultured to determine cytotoxicity and to allow phenotypic expression prior to mutant selection (14) (15) (16) (17). Cytotoxicity is determined by relative survival (RS), i.e. cloning efficiency measured immediately after treatment and adjusted for any cell loss during treatment as compared to the negative control (paragraph 18 and Appendix 2). The treated cultures are maintained in growth medium for a sufficient period of time, characteristic of each cell type, to allow near-optimal phenotypic expression of induced mutations (typically a minimum of 7-9 days). Following phenotypic expression, mutant frequency is determined by seeding known numbers of cells in medium containing the selective agent to detect mutant colonies, and in medium without selective agent to determine the cloning efficiency (viability). After a suitable incubation time, colonies are counted. Mutant frequency is calculated based on the number of mutant colonies corrected by the cloning efficiency at the time of mutant selection.

DESCRIPTION OF THE METHOD**Preparations***Cells*

9. The cell types used for the HPRT and XPRT tests should have a demonstrated sensitivity to chemical mutagens, a high cloning efficiency, a stable karyotype, and a stable spontaneous mutant frequency. The most commonly used cells for the HPRT test include the CHO, CHL and V79 lines of Chinese hamster cells, L5178Y mouse lymphoma cells, and TK6 human lymphoblastoid cells (18) (19). CHO-derived AS52 cells containing the gpt transgene (and having the Hprt gene deleted) are used for the XPRT test (20) (21); the HPRT test cannot be performed in AS52 cells because the hprt gene has been deleted. The use of other cell lines should be justified and validated.
10. Cell lines should be checked routinely for the stability of the modal chromosome number and the absence of Mycoplasma contamination (22) (23), and cells should not be used if contaminated or if the modal chromosome number has changed. The normal cell cycle time used in the testing laboratory should be established and should be consistent with the

▼ M8

published cell characteristics. The spontaneous mutant frequency in the master cell stock should also be checked, and the stock should not be used if the mutant frequency is not acceptable.

11. Prior to use in this test, the cultures may need to be cleansed of pre-existing mutant cells, e.g. by culturing in HAT medium for HPRT test and MPA for XPRT test (5) (24) (See Appendix 1). The cleansed cells can be cryopreserved and then thawed to use as working stocks. The newly thawed working stock can be used for the test after normal doubling times are attained. When conducting the XPRT test, routine culture of AS52 cells should use conditions that assure the maintenance of the gpt transgene (20).

Media and culture conditions

12. Appropriate culture medium and incubation conditions (culture vessels, humidified atmosphere of 5 % CO₂, and incubation temperature of 37 °C) should be used for maintaining cultures. Cell cultures should always be maintained under conditions that ensure that they are growing in log phase. It is particularly important that media and culture conditions be chosen to ensure optimal growth of cells during the expression period and optimal cloning efficiency for both mutant and non-mutant cells.

Preparation of cultures

13. Cell lines are propagated from stock cultures, seeded in culture medium at a density such that the cells in suspensions or in monolayers will continue to grow exponentially through the treatment and expression periods (e.g. confluence should be avoided for cells growing in monolayers).

Metabolic activation

14. Exogenous metabolising systems should be used when employing cells which have inadequate endogenous metabolic capacity. The most commonly used system, that is recommended by default, unless otherwise justified, is a co-factor-supplemented post-mitochondrial fraction (S9) prepared from the livers of rodents (generally rats) treated with enzyme-inducing agents such as Aroclor 1254 (25) (26) (27) (28) or a combination of phenobarbital and β -naphthoflavone (29) (30) (31) (32). The latter combination does not conflict with the Stockholm Convention on Persistent Organic Pollutants (33) and has been shown to be as effective as Aroclor 1254 for inducing mixed-function oxidases (29) (31). The S9 fraction typically is used at concentrations ranging from 1 to 2 % (v/v) but may be increased to 10 % (v/v) in the final test medium. The choice of the type and concentration of exogenous metabolic activation system or metabolic inducer employed may be influenced by the class of substances being tested (34) (35) (36).

Test chemical preparation

15. Solid test chemicals should be prepared in appropriate solvents and diluted, if appropriate, prior to treatment of the cells (see paragraph 16). Liquid test chemicals may be added directly to the test system and/or diluted prior to treatment of the test system. Gaseous or volatile test chemicals should be tested by appropriate modifications to the standard protocols, such as treatment in sealed culture vessels (37) (38). Preparations of the test chemical should be made just prior to treatment unless stability data demonstrate the acceptability of storage.

▼M8**TEST CONDITIONS****Solvents**

16. The solvent should be chosen to optimise the solubility of the test chemicals without adversely impacting the conduct of the test e.g. changing cell growth, affecting the integrity of the test chemical, reacting with culture vessels, impairing the metabolic activation system. It is recommended that, wherever possible, the use of an aqueous solvent (or culture medium) should be considered first. Well established solvents are for example, water and dimethyl sulfoxide. Generally, organic solvents should not exceed 1 % (v/v) and aqueous solvents (saline or water) should not exceed 10 % (v/v) in the final treatment medium. If the solvents used are not well-established (e.g. ethanol or acetone), their use should be supported by data indicating their compatibility with the test chemicals and the test system, and their lack of genetic toxicity at the concentration used. In the absence of that supporting data, it is important to add untreated controls (see Appendix 1) to demonstrate that no deleterious or mutagenic effects are induced by the chosen solvent.

Measuring cytotoxicity and choosing exposure concentrations

17. When determining the highest test chemical concentration, concentrations that have the capability of producing artefactual positive responses, such as those producing excessive cytotoxicity (see paragraph 20), precipitation in the culture medium (see paragraph 21), or marked changes in pH or osmolality (see paragraph 5) should be avoided. If the test chemical causes a marked change in the pH of the medium at the time of addition, the pH might be adjusted by buffering the final treatment medium so as to avoid artefactual positive results and to maintain appropriate culture conditions.
18. Concentration selection is based on cytotoxicity and other considerations (see paragraphs 20-22). While the evaluation of cytotoxicity in an initial test may be useful to better define the concentrations to be used in the main experiment, an initial test is not required. Even if an initial cytotoxicity evaluation is performed, the measurement of cytotoxicity for each culture is still required in the main experiment. Cytotoxicity should be evaluated using RS, i.e. cloning efficiency (CE) of cells plated immediately after treatment, adjusted by any loss of cells during treatment, based on cell count, as compared with adjusted cloning efficiency in negative controls (assigned a survival of 100 %) (see Appendix 2 for the formula).
19. At least four test concentrations (not including the solvent and positive controls) that meet the acceptability criteria (appropriate cytotoxicity, number of cells, etc.) should be evaluated. While the use of duplicate cultures is advisable, either replicate or single treated cultures may be used at each concentration tested. The results obtained in the independent replicate cultures at a given concentration should be reported separately but can be pooled for the data analysis (17). For test chemicals demonstrating little or no cytotoxicity, concentration intervals of approximately 2 to 3 fold will usually be appropriate. Where cytotoxicity occurs, the test concentrations selected should cover a range from that producing cytotoxicity to concentrations at which there is moderate and little or no cytotoxicity. Many test

▼ M8

chemicals exhibit steep concentration response curves and in order to cover the whole range of cytotoxicity or to study the concentration response relationship in detail, it may be necessary to use more closely spaced concentrations and more than four concentrations, in particular in situations where a repeat experiment is required (see paragraph 43). The use of more than 4 concentrations may be particularly important when using single cultures.

20. If the maximum concentration is based on cytotoxicity, the highest concentration should aim to achieve between 20 and 10 % RS. Care should be taken when interpreting positive results only found at 10 % RS or below (paragraph 43).
21. For poorly soluble test chemicals that are not cytotoxic at concentrations below the lowest insoluble concentration, the highest concentration analysed should produce turbidity or a precipitate visible by eye or with the aid of an inverted microscope at the end of the treatment with the test chemical. Even if cytotoxicity occurs above the lowest insoluble concentration, it is advisable to test at only one concentration producing turbidity or with a visible precipitate because artefactual effects may result from the precipitate. At the concentration producing a precipitate, care should be taken to assure that the precipitate does not interfere with the conduct of the test. The determination of solubility in the culture medium prior to the experiment may be useful.
22. If no precipitate or limiting cytotoxicity is observed, the highest test concentration should correspond to 10 mM, 2 mg/ml or 2 µl/ml, whichever is the lowest (39) (40). When the test chemical is not of defined composition, e.g. substance of unknown or variable composition, complex reaction products or biological materials (i.e. Chemical Substances of Unknown or Variable Composition (UVCBs)) (41), environmental extracts, etc., the top concentration may need to be higher (e.g. 5 mg/mL), in the absence of sufficient cytotoxicity, to increase the concentration of each of the components. It should be noted however that these requirements may differ for human pharmaceuticals (42).

Controls

23. Concurrent negative controls (see paragraph 16), consisting of solvent alone in the treatment medium and handled in the same way as the treatment cultures, should be included for every experimental condition.
24. Concurrent positive controls are needed to demonstrate the ability of the laboratory to identify mutagens under the conditions of the test protocol used and the effectiveness of the exogenous metabolic activation system, when applicable. Examples of positive controls are given in Table 1 below. Alternative positive control substances can be used, if justified. Because *in vitro* mammalian cell tests for genetic toxicity are sufficiently standardised, tests using treatments with and without exogenous metabolic activation may be conducted using only a positive control requiring metabolic activation. In this case, this single positive control response will demonstrate both the activity of the metabolic activation system and the responsiveness of the test system. Each positive control should be used at one or more concentrations expected to give reproducible and detectable increases over background in order to demonstrate the sensitivity of the test system, and the response should not be compromised by cytotoxicity exceeding the limits specified in this test method (see paragraph 20).

▼ **M8**

Table 1

Reference substances recommended for assessing laboratory proficiency and for selection of positive controls

Metabolic Activation condition	Locus	Substance and CAS No
Absence of exogenous metabolic activation	<i>Hprt</i>	Ethylmethanesulfonate [CAS no. 62-50-0] Ethylnitrosourea [CAS no. 759-73-9] 4-Nitroquinoline 1-oxide [CAS no. 56-57-5]
	<i>xprt</i>	Streptonigrin [CAS no. 3930-19-6] Mitomycin C [CAS no. 50-07-7]
Presence of exogenous metabolic activation	<i>Hprt</i>	3-Methylcholanthrene [CAS no. 56-49-5] 7,12-Dimethylbenzanthracene [CAS no. 57-97-6] Benzo[a]pyrene [CAS no. 50-32-8]
	<i>xprt</i>	Benzo[a]pyrene [CAS no. 50-32-8]

PROCEDURE**Treatment with test chemical**

25. Proliferating cells are treated with the test chemical in the presence and absence of a metabolic activation system. Exposure should be for a suitable period of time (usually 3 to 6 hours is adequate).

26. The minimum number of cells used for each test (control and treated) culture at each stage in the test should be based on the spontaneous mutant frequency. A general guide is to treat and passage sufficient cells as to maintain 10 spontaneous mutants in every culture in all phases of the test (17). The spontaneous mutant frequency is generally between 5 and 20×10^{-6} . For a spontaneous mutant frequency of 5×10^{-6} and to maintain a sufficient number of spontaneous mutants (10 or more) even for the cultures treated at concentrations that cause 90 % cytotoxicity during treatment (10 % RS), it would be necessary to treat at least 20×10^6 cells. In addition a sufficient number of cells (but never less than 2 million) must be cultured during the expression period and plated for mutant selection (17).

Phenotypic expression time and measuring mutant frequency

27. After the treatment period, cells are cultured to allow expression of the mutant phenotype. A minimum of 7 to 9 days generally is sufficient to allow near optimal phenotypic expression of newly induced *Hprt* and *xprt* mutants (43) (44). During this period, cells are regularly sub-cultured to maintain them in exponential growth. After phenotypic expression, cells are re-plated in medium with and without selective agent (6-thioguanine) for the determination of the number of mutants and cloning efficiency at the time of selection, respectively. This plating can be accomplished using dishes for monolayer cultures or microwell plates for cells in suspension. For mutant selection, cells should be plated at a density to assure optimum mutant recovery (i.e. avoid metabolic cooperation) (17). Plates are incubated for an appropriate length of time for optimum colony growth (e.g. 7-12 days) and colonies counted. Mutant frequency is calculated based on the number of mutant colonies corrected by the cloning efficiency at the time of mutant selection (see Appendix 2 for formulas).

▼ M8**Proficiency of the laboratory**

28. In order to establish sufficient experience with the test prior to using it for routine testing, the laboratory should have performed a series of experiments with reference positive substances acting via different mechanisms (at least one active with and one active without metabolic activation selected from the substances listed in Table 1) and various negative controls (using various solvents/vehicles). These positive and negative control responses should be consistent with the literature. This is not applicable to laboratories that have experience, i.e. that have an historical data base available as defined in paragraphs 30 to 33.

29. A selection of positive control substances (see Table 1 in paragraph 25) should be investigated in the absence and in the presence of metabolic activation, in order to demonstrate proficiency to detect mutagenic chemicals, to determine the effectiveness of the metabolic activation system and to demonstrate the appropriateness of the cell growth conditions during treatment, phenotypic expression and mutant selection and of the scoring procedures. A range of concentrations of the selected substances should be chosen so as to give reproducible and concentration-related increases above the background in order to demonstrate the sensitivity and dynamic range of the test system.

Historical control data

30. The laboratory should establish:
 - A historical positive control range and distribution,

 - A historical negative (untreated, solvent) control range and distribution.

31. When first acquiring data for an historical negative control distribution, concurrent negative controls should be consistent with published control data (22). As more experimental data are added to the control distribution, concurrent negative controls should ideally be within the 95 % control limits of that distribution (17) (45) (46).

32. The laboratory's historical negative control database should initially be built with a minimum of 10 experiments but would preferably consist of at least 20 experiments conducted under comparable experimental conditions. Laboratories should use quality control methods, such as control charts (e.g. C-charts or X-bar charts (47)), to identify how variable their positive and negative control data are, and to show that the methodology is 'under control' in their laboratory (46). Further recommendations on how to build and use the historical data (i.e. criteria for inclusion and exclusion of data in historical data and the acceptability criteria for a given experiment) can be found in the literature (45).

33. Negative control data should consist of mutant frequencies from single or preferably replicate cultures as described in paragraph 23. Concurrent negative controls should ideally be within the 95 % control limits of the distribution of the laboratory's historical negative control database (17) (45) (46). Where concurrent negative control data fall outside the 95 % control limit they may be acceptable for inclusion in the historical control distribution as long as these data are not extreme outliers and there is evidence that the test system is 'under control' (see above) and there is evidence of no technical or human failure.

▼M8

34. Any changes to the experimental protocol should be considered in terms of their consistency with the laboratory's existing historical control databases. Any major inconsistencies should result in the establishment of a new historical control database.

DATA AND REPORTING**Presentation of the results**

35. The presentation of results should include all of the data needed to calculate cytotoxicity (expressed as RS). The data, for both treated and control cultures, should include the number of cells at the end of treatment, the number of cells plated immediately following treatment, and the colony counts (or number of wells without colonies for the microwell method). RS for each culture should be expressed as a percentage relative to the concurrent solvent control (refer to Appendix 1 for definitions).
36. The presentation of results should also include all of the data needed to calculate the mutant frequency. Data for both treated and control cultures, should include: (1) the number of cells plated with and without selective agent (at the time the cells are plated for mutant selection), and (2) the number of colonies counted (or the number of wells without colonies for the microwell method) from the plates with and without selective agent. Mutant frequency is calculated based on the number of mutant colonies (in the plates with selective agent) corrected by the cloning efficiency (from the plates without selective agent). The mutant frequency should be expressed as the number of mutant cells per million viable cells (refer to Appendix 1 for definitions).
37. Individual culture data should be provided. Additionally, all data should be summarised in tabular form.

Acceptability Criteria

38. Acceptance of a test is based on the following criteria:
- The concurrent negative control is considered acceptable for addition to the laboratory historical negative control database as described in paragraph 33.
 - Concurrent positive controls (see paragraph 24) should induce responses that are compatible with those generated in the historical positive control data base and produce a statistically significant increase compared with the concurrent negative control.
 - Two experimental conditions (i.e. with and without metabolic activation) were tested unless one resulted in positive results (see paragraph 25).
 - Adequate number of cells and concentrations are analysable (paragraphs 25, 26 and 19).
 - The criteria for the selection of top concentration are consistent with those described in paragraphs 20, 21 and 22.

Evaluation and interpretation of results

39. Providing that all acceptability criteria are fulfilled, a test chemical is considered to be clearly positive if, in any of the experimental conditions examined:

▼M8

- at least one of the test concentrations exhibits a statistically significant increase compared with the concurrent negative control,
- the increase is concentration-related when evaluated with an appropriate trend test,
- any of the results are outside the distribution of the historical negative control data (e.g. Poisson-based 95 % control limit; see paragraph 33).

When all of these criteria are met, the test chemical is then considered able to induce gene mutations in cultured mammalian cells in this test system. Recommendations for the most appropriate statistical methods can be found in the literature (46) (48).

40. Providing that all acceptability criteria are fulfilled, a test chemical is considered clearly negative if, in all experimental conditions examined:

- none of the test concentrations exhibits a statistically significant increase compared with the concurrent negative control,
- there is no concentration-related increase when evaluated with an appropriate trend test,
- all results are inside the distribution of the historical negative control data (e.g. Poisson-based 95 % control limit; see paragraph 33).

The test chemical is then considered unable to induce gene mutations in cultured mammalian cells in this test system.

41. There is no requirement for verification of a clearly positive or negative response.

42. In cases when the response is neither clearly negative nor clearly positive as described above, or in order to assist in establishing the biological relevance of a result, the data should be evaluated by expert judgement and/or further investigations. Performing a repeat experiment possibly using modified experimental conditions (e.g. concentration spacing, other metabolic activation conditions [i.e. S9 concentration or S9 origin]) could be useful.

43. In rare cases, even after further investigations, the data set will preclude making a conclusion of positive or negative results. Therefore the test chemical response should be concluded to be equivocal (interpreted as equally likely to be positive or negative).

Test report

44. The test report should include the following information:

Test chemical:

- source, lot number, limit date for use, if available;
- stability of the test chemical itself, if known;
- solubility and stability of the test chemical in solvent, if known;
- measurement of pH, osmolality and precipitate in the culture medium to which the test chemical was added, as appropriate.

▼M8

Mono-constituent substance:

- physical appearance, water solubility, and additional relevant physico-chemical properties;
- chemical identification, such as IUPAC or CAS name, CAS number, SMILES or InChI code, structural formula, purity, chemical identity of impurities as appropriate and practically feasible, etc.

Multi-constituent substance, UVCBs and mixtures:

- characterised as far as possible by chemical identity (see above), quantitative occurrence and relevant physicochemical properties of the constituents.

Solvent:

- justification for choice of solvent;
- percentage of solvent in the final culture medium.

Cells:

For Laboratory master cultures:

- type, source of cell lines;
- number of passages, if available, and history in the laboratory;
- karyotype features and/or modal number of chromosomes;
- methods for maintenance of cell cultures;
- absence of mycoplasma;
- cell doubling times.

Test conditions:

- rationale for selection of concentrations and number of cultures including, e.g. cytotoxicity data and solubility limitations;
- composition of media, CO₂ concentration, humidity level;
- concentration of test chemical expressed as final concentration in the culture medium (e.g. µg or mg/ml or mM of culture medium);
- concentration (and/or volume) of solvent and test chemical added in the culture medium;
- incubation temperature;
- incubation time;
- duration of treatment;
- cell density during treatment;
- type and composition of metabolic activation system (source of S9, method of preparation of the S9 mix, the concentration or volume of S9 mix and S9 in the final culture medium, quality controls of S9);
- positive and negative control substances, final concentrations for each condition of treatment;

▼M8

- length of expression period (including number of cells seeded, and subcultures and feeding schedules, if appropriate);
- identity of the selective agent and its concentration;
- criteria for acceptability of tests;
- methods used to enumerate numbers of viable and mutant cells;
- methods used for the measurements of cytotoxicity;
- any supplementary information relevant to cytotoxicity and method used;
- duration of incubation times after plating;
- criteria for considering studies as positive, negative or equivocal;
- methods used to determine pH, osmolality and precipitation.

Results:

- number of cells treated and number of cells sub-cultured for each culture;
- cytotoxicity measurements and other observations if any;
- signs of precipitation and time of the determination;
- number of cells plated in selective and non-selective medium;
- number of colonies in non-selective medium and number of resistant colonies in selective medium, and related mutant frequencies;
- concentration-response relationship, where possible;
- concurrent negative (solvent) and positive control data (concentrations and solvents);
- historical negative (solvent) and positive control data, with ranges, means and standard deviations and confidence interval (e.g. 95 %) as well as the number of data;
- statistical analyses (for individual cultures and pooled replicates if appropriate), and p-values if any.

*Discussion of the results.**Conclusion***LITERATURE**

- (1) OECD (2016). Overview of the set of OECD Genetic Toxicology Test Guidelines and updates performed in 2014-2015. ENV Publications. Series on Testing and Assessment, No 234, OECD, Paris.
- (2) Moore M.M., DeMarini D.M., DeSerres F.J. and Tindall, K.R. (Eds.) (1987). Banbury Report 28: Mammalian Cell Mutagenesis, Cold Spring Harbor Laboratory, New York, New York.

▼ **M8**

- (3) Chu E.H.Y. and Malling H.V. (1968). Mammalian Cell Genetics. II. Chemical Induction of Specific Locus Mutations in Chinese Hamster Cells *In Vitro*, Proc. Natl. Acad. Sci., USA, 61, 1306-1312.
- (4) Moore M.M., Harrington-Brock K., Doerr C.L. and Dearfield K.L. (1989). Differential Mutant Quantitation at the Mouse Lymphoma TK and CHO HGPRT Loci. *Mutagen. Res.*, 4, 394-403.
- (5) Aaron C.S. and Stankowski Jr. L.F. (1989). Comparison of the AS52/XPRT and the CHO/HPRT Assays: Evaluation of Six Drug Candidates. *Mutation Res.*, 223, 121-128.
- (6) Aaron C.S., Bolcsfoldi G., Glatt H.R., Moore M., Nishi Y., Stankowski L., Theiss J. and Thompson E. (1994). Mammalian Cell Gene Mutation Assays Working Group Report. Report of the International Workshop on Standardisation of Genotoxicity Test Procedures. *Mutation Res.*, 312, 235-239.
- (7) Li A.P., Gupta R.S., Heflich R.H. and Wasson J. S. (1988). A Review and Analysis of the Chinese Hamster Ovary/Hypoxanthine Guanine Phosphoribosyl Transferase System to Determine the Mutagenicity of Chemical Agents: A Report of Phase III of the U.S. Environmental Protection Agency Gene-tox Program. *Mutation Res.*, 196, 17-36.
- (8) Scott D., Galloway S.M., Marshall R.R., Ishidate M., Brusick D., Ashby J. and Myhr B.C. (1991). Genotoxicity Under Extreme Culture Conditions. A Report from ICPEMC Task Group 9. *Mutation Res.*, 257, 147-204.
- (9) Morita T., Nagaki T., Fukuda I. and Okumura K. (1992). Clastogenicity of Low pH to Various Cultured Mammalian Cells. *Mutation Res.*, 268, 297-305.
- (10) Brusick D. (1986). Genotoxic Effects in Cultured Mammalian Cells Produced by Low pH Treatment Conditions and Increased Ion concentrations, *Environ. Mutagen.*, 8, 789-886.
- (11) Nesslany F., Simar-Meintieres S., Watzinger M., Talahari I. and Marzin D. (2008). Characterization of the Genotoxicity of Nitrilotriacetic Acid. *Environ. Mol. Mutation Res.*, 49, 439-452.
- (12) Long L.H., Kirkland D., Whitwell J. and Halliwell B. (2007). Different Cytotoxic and Clastogenic Effects of Epigallocatechin Gallate in Various Cell-Culture Media Due to Variable Rates of its Oxidation in the Culture Medium, *Mutation Res.*, 634, 177-183.
- (13) Kirkland D., Aardema M., Henderson L., and Müller L. (2005). Evaluation of the Ability of a Battery of Three *In Vitro* Genotoxicity Tests to Discriminate Rodent Carcinogens and Non-Carcinogens. I: Sensitivity, Specificity and Relative Predictivity. *Mutation Res.*, 5841-256.
- (14) Li A.P., Carver J.H., Choy W.N., Hsie A.W., Gupta R.S., Loveday K.S., O'Neill J.P., Riddle J.C., Stankowski L.F. Jr. and Yang L.L. (1987). A Guide for the Performance of the Chinese Hamster Ovary Cell/Hypoxanthine-Guanine Phosphoribosyl Transferase Gene Mutation Assay. *Mutation Res.*, 189, 135-141.
- (15) Liber H.L., Yandell D.W. and Little J.B. (1989). A Comparison of Mutation Induction at the TK and HPRT Loci in Human Lymphoblastoid Cells; Quantitative Differences are Due to an Additional Class of Mutations at the Autosomal TK Locus. *Mutation Res.*, 216, 9-17.
- (16) Stankowski L.F. Jr., Tindall K.R. and Hsie A.W. (1986). Quantitative and Molecular Analyses of Ethyl Methanesulfonate- and ICR 191-Induced Molecular Analyses of Ethyl Methanesulfonate- and ICR 191-Induced Mutation in AS52 Cells. *Mutation Res.*, 160, 133-147.

▼M8

- (17) Arlett C.F., Smith D.M., Clarke G.M., Green M.H.L., Cole J., McGregor D.B. and Asquith J.C. (1989). Mammalian Cell Gene Mutation Assays Based upon Colony Formation. In: Statistical Evaluation of Mutagenicity Test Data, Kirkland, D.J. (Eds.), Cambridge University Press, pp. 66-101.
- (18) Hsie A.W., Casciano D.A., Couch D.B., Krahn D.F., O'Neill J.P., and Whitfield B.L. (1981). The Use of Chinese Hamster Ovary Cells to Quantify Specific Locus Mutation and to Determine Mutagenicity of Chemicals; a Report of the Gene-Tox Program, *Mutation Res.*, 86, 193-214.
- (19) Li A.P. (1981). Simplification of the CHO/HGPRT Mutation Assay Through the Growth of Chinese Hamster Ovary Cells as Unattached Cultures, *Mutation Res.*, 85, 165-175.
- (20) Tindall K.R., Stankowski Jr., L.F., Machanoff R., and Hsie A.W. (1984). Detection of Deletion Mutations in pSV2*gpt*-Transformed Cells, *Mol. Cell. Biol.*, 4, 1411-1415.
- (21) Hsie A. W., Recio L., Katz D. S., Lee C. Q., Wagner M., and Schenley R. L. (1986). Evidence for Reactive Oxygen Species Inducing Mutations in Mammalian Cells. *Proc Natl Acad Sci.*, 83(24): 9616–9620.
- (22) Lorge E., Moore M., Clements J., Donovan M. O., Honma M., Kohara A., Van Benthem J., Galloway S., Armstrong M.J., Thybaud V., Gollapudi B., Aardema M., Kim J., Sutter A., Kirkland D.J. (2015). Standardized Cell Sources and Recommendations for Good Cell Culture Practices in Genotoxicity Testing. (Manuscript in preparation).
- (23) Coecke S., Balls M., Bowe G., Davis J., Gstraunthaler G., Hartung T., Hay R., Merten O.W., Price A., Schechtman L., Stacey G. and Stokes W. (2005). Guidance on Good Cell Culture Practice. A Report of the Second ECVAM Task Force on Good Cell Culture Practice, *ATLA*, 33, 261-287.
- (24) Rosen M.P., San R.H.C. and Stich H.F. (1980). Mutagenic Activity of Ascorbate in Mammalian Cell Cultures, *Can. Lett.* 8, 299-305.
- (25) Natarajan A.T., Tates A.D, Van Buul P.P.W., Meijers M. and de Vogel N. (1976). Cytogenetic Effects of Mutagens/Carcinogens after Activation in a Microsomal System *In Vitro*, I. Induction of Chromosomal Aberrations and Sister Chromatid Exchanges by Diethylnitrosamine (DEN) and Dimethylnitrosamine (DMN) in CHO Cells in the Presence of Rat-Liver Microsomes. *Mutation Res.*, 37, 83-90.
- (26) Abbondandolo A., Bonatti S., Corti G., Fiorio R., Loprieno N. and Mazzacaro A. (1977). Induction of 6-Thioguanine-Resistant Mutants in V79 Chinese Hamster Cells by Mouse-Liver Microsome-Activated Dimethylnitrosamine. *Mutation Res.*, 46, 365-373.
- (27) Ames B.N., McCann J. and Yamasaki E. (1975). Methods for Detecting Carcinogens and Mutagens with the Salmonella/Mammalian-Microsome Mutagenicity Test. *Mutation Res.*, 31, 347-364.
- (28) Maron D.M. and Ames B.N. (1983). Revised Methods for the Salmonella Mutagenicity Test. *Mutation Res.*, 113, 173, 215.
- (29) Elliott B.M., Combes R.D., Elcombe C.R., Gatehouse D.G., Gibson G.G., Mackay J.M. and Wolf R.C. (1992) Alternatives to Aroclor 1254-Induced S9 in *In Vitro* Genotoxicity Assays. *Mutagen.* 7, 175-177.
- (30) Matsushima T., Sawamura M., Hara K. and Sugimura T. (1976). A Safe Substitute for Polychlorinated Biphenyls as an Inducer of Metabolic Activation Systems. In: *In Vitro* Metabolic Activation in Mutagenesis Testing, de Serres F.J., Fouts J.R., Bend J.R. and Philpot R.M. (Eds), Elsevier, North-Holland, pp. 85-88.

▼M8

- (31) Ong T.-m., Mukhtar M., Wolf C.R. and Zeiger E. (1980). Differential Effects of Cytochrome P450-Inducers on Promutagen Activation Capabilities and Enzymatic Activities of S-9 from Rat Liver, *J. Environ. Pathol. Toxicol.*, 4, 55-65.
- (32) Johnson T.E., Umbenhauer D.R. and Galloway S.M. (1996). Human Liver S-9 Metabolic Activation: Proficiency in Cytogenetic Assays and Comparison with Phenobarbital/beta-Naphthoflavone or Aroclor 1254 Induced Rat S-9, *Environ. Mol. Mutagen.*, 28, 51-59.
- (33) UNEP. (2001). Stockholm Convention on Persistent Organic Pollutants, United Nations Environment Programme (UNEP). Available at: [<http://www.pops.int.html>].
- (34) Tan E.-L. and Hsie A.W. (1981). Effect of Calcium Phosphate and Alumina Gels on the Mutagenicity and Cytotoxicity of Dimethylnitrosamine as Studied in the CHO/HGPRT System. *Mutation Res.*, 84, 147-156.
- (35) O'Neill J.P., Machanoff R., San Sebastian J.R., Hsie A.W. (1982). Cytotoxicity and Mutagenicity of Dimethylnitrosamine in Camalian Cells (CHO/HGPRT system): Enhancement by Calcium Phosphate. *Environ. Mol. Mutation.*, 4, 7-18.
- (36) Li, A.P. (1984). Use of Aroclor 1254-Induced Rat Liver Homogenate in the Assaying of Promutagens in Chinese Hamster Ovary Cells. *Environ. Mol. Mutation*, 4, 7-18.
- (37) Krahn D.F., Barsky F.C. and McCooey K.T. (1982). CHO/HGPRT Mutation Assay: Evaluation of Gases and Volatile Liquids. In: Tice, R.R., Costa, D.L., Schaich, K.M. (eds.) *Genotoxic Effects of Airborne Agents*. New York, Plenum, pp. 91-103.
- (38) Zamora P.O., Benson J.M., Li A.P. and Brooks A.L. (1983). Evaluation of an Exposure System Using Cells Grown on Collagen Gels for Detecting Highly Volatile Mutagens in the CHO/HGPRT Mutation Assay. *Environ. Mutagen.*, 5, 795-801.
- (39) OECD (2014). Document Supporting the WNT Decision to Implement Revised Criteria for the Selection of the Top Concentration in the *In Vitro* Mammalian Cell Assays on Genotoxicity (Test Guidelines 473, 476 and 487). Available upon request from the Organisation for Economic Cooperation and Development.
- (40) Brookmire L., Chen J.J. and Levy D.D. (2013). Evaluation of the Highest Concentrations Used in the *In Vitro* Chromosome Aberrations Assay, *Environ. Mol. Mutation*, 54, 36-43.
- (41) EPA, Office of Chemical Safety and Pollution Prevention. (2011). *Chemical Substances of Unknown or Variable Composition, Complex Reaction Products and Biological Materials: UVCB Substances*,
- (42) USFDA (2012). International Conference on Harmonisation (ICH) Guidance S2 (R1) on Genotoxicity Testing and Data Interpretation for Pharmaceuticals Intended for Human Use. Available at: [<https://federalregister.gov/a/2012-13774>].
- (43) O'Neill J.P. and Hsie A.W. (1979). Phenotypic Expression Time of Mutagen-Induced 6-thioguanine resistance in Chinese hamster ovary cells (CHO/HGPRT system), *Mutation, Res.*, 59, 109-118.
- (44) Chiewchanwit T., Ma H., El Zein R., Hallberg L., and Au W.W. (1995). Induction of Deletion Mutations by Methoxyacetaldehyde in Chinese Hamster Ovary (CHO)-AS52 cells. *Mutation, Res.*, 1335(2):121-8.

▼M8

- (45) Hayashi M., Dearfield K., Kasper P., Lovell D., Martus H.J., and Thybaud V. (2011). Compilation and Use of Genetic Toxicity Historical Control Data, *Mutation, Res.*, 723, 87-90.
- (46) OECD (2014). Statistical Analysis Supporting the Revision of the Genotoxicity Test Guidelines. Environmental, Health and Safety, Series on testing and assessment (No 199), Organisation for Economic Cooperation and Development, Paris.
- (47) Richardson C., Williams D.A., Allen J.A., Amphlett G., Chanter D.O., and Phillips B. (1989). Analysis of Data from *In Vitro* Cytogenetic Assays. In: Statistical Evaluation of Mutagenicity Test Data. Kirkland, D.J., (Ed) Cambridge University Press, Cambridge, pp. 141-154.
- (48) Fleiss J. L., Levin B., and Paik M. C. (2003). Statistical Methods for Rates and Proportions, Third Edition, New York: John Wiley & Sons

▼M8*Appendix 1*

DEFINITIONS

Base pair substitution mutagens: chemicals that cause substitution of base pairs in the DNA.

Chemical: A substance or a mixture.

Cloning efficiency: The percentage of cells plated at a low density that are able to grow into a colony that can be counted.

Concentrations: refer to final concentrations of the test chemical in culture medium

Cytotoxicity: For the assays covered in this test method, cytotoxicity is identified as a reduction in relative survival of the treated cells as compared to the negative control (see specific paragraph).

Forward mutation: a gene mutation from the parental type to the mutant form which gives rise to an alteration or a loss of the enzymatic activity or the function of the encoded protein.

Frameshift mutagens: chemicals which cause the addition or deletion of single or multiple base pairs in the DNA molecule.

Genotoxic: a general term encompassing all types of DNA or chromosomal damage, including DNA breaks, adducts, rearrangements, mutations, chromosome aberrations, and aneuploidy. Not all types of genotoxic effects result in mutations or stable chromosomal damage

HAT medium: medium containing Hypoxanthine, Aminopterin and Thymidine, used for cleansing of Hprt mutants.

Mitotic recombination: during mitosis, recombination between homologous chromatids possibly resulting in the induction of DNA double strand breaks or in a loss of heterozygosity.

MPA medium: medium containing Xanthine, Adenine, Thymidine, Aminopterin and Mycophenolic acid, used for cleansing of Xprt mutants.

Mutagenic: produces a heritable change of DNA base-pair sequences(s) in genes or of the structure of chromosomes (chromosome aberrations).

Mutant frequency (MF): the number of mutant colonies observed divided by the number of cells plated in selective medium, corrected for cloning efficiency (or viability) at the time of selection.

Phenotypic expression time: The time after treatment during which the genetic alteration is fixed within the genome and any preexisting gene products are depleted to the point that the phenotypic trait is altered.

Relative survival (RS): RS is used as the measure of treatment-related cytotoxicity. RS is cloning efficiency (CE) of cells plated immediately after treatment adjusted by any loss of cells during treatment as compared with cloning efficiency in negative controls (assigned a survival of 100 %).

S9 liver fractions: supernatant of liver homogenate after 9 000g centrifugation, i.e. raw liver extract

▼M8

S9 mix: mix of the liver S9 fraction and cofactors necessary for metabolic enzyme activity.

Solvent control: General term to define the control cultures receiving the solvent alone used to dissolve the test chemical.

Test chemical: Any substance or mixture tested using this test method.

Untreated control: cultures that receive no treatment (i.e. neither test chemical nor solvent) but are processed concurrently and in the same way as the cultures receiving the test chemical

UVCB: Chemical Substances of Unknown or Variable Composition, Complex Reaction Products and Biological Materials

▼ M8*Appendix 2***FORMULAS FOR ASSESSMENT OF CYTOTOXICITY AND MUTANT FREQUENCY**

Cytotoxicity is evaluated by relative survival, i. e., cloning efficiency (CE) of cells plated immediately after treatment adjusted by any loss of cells during treatment as compared with adjusted cloning efficiency in negative controls (assigned a survival of 100 %) (see RS formula below).

Adjusted CE for a culture treated by a test chemical is calculated as:

$$\text{Adjusted CE} = \frac{\text{Number of cells at the end of treatment}}{\text{Number of cells at the beginning of treatment}}$$

RS for a culture treated by a test chemical is calculated as:

$$\text{RS} = \frac{\text{Adjusted CE in treated culture}}{\text{Adjusted CE in the solvent control}} \times 100$$

Mutant frequency is the cloning efficiency of mutant colonies in selective medium divided by the cloning efficiency in non-selective medium measured for the same culture at the time of selection.

$$\text{Mutant frequency} = \frac{\text{Cloning efficiency of mutant colonies in selective medium}}{\text{Cloning efficiency in non – selective medium}}$$

When plates are used for cloning efficiency:

CE = Number of colonies / Number of cells plated.

When micro-well plates are used for cloning efficiency:

The number of colonies per well on micro-wells plates follows a Poisson distribution.

Cloning Efficiency = $-\text{LnP}(0)$ / Number of cells plated per well

Where $-\text{LnP}(0)$ is the probable number of empty wells out of the seeded wells and is described by the following formula

$\text{LnP}(0) = -\text{Ln}$ (number of empty wells / number of plated wells)

▼ M7

▼ B**B.21. IN VITRO MAMMALIAN CELL TRANSFORMATION TESTS****1. METHOD****1.1. INTRODUCTION**

See General introduction Part B.

1.2. DEFINITION

See General introduction Part B.

1.3. REFERENCE SUBSTANCES

None.

1.4. PRINCIPLE OF THE TEST METHOD

Mammalian cell culture systems may be used to detect phenotypic changes *in vitro* induced by chemical substances associated with malignant transformation *in vivo*. Widely used cells include C3H10T_{1/2}, 3T3, SHE, Fischer rat and the tests rely on changes in cell morphology, focus formation or changes in anchorage dependence in semi-solid agar. Less widely used systems exist which detect other physiological or morphological changes in cells following exposure to carcinogenic chemicals. None of the *in vitro* test endpoints has an established mechanistic link with cancer. Some of the test systems are capable of detecting tumour promoters. Cytotoxicity may be determined by measuring the effect of the test material on colony-forming abilities (cloning efficiency) or growth rates of the cultures. The measurement of cytotoxicity is to establish that exposure to the test chemical has been toxicologically relevant but cannot be used to calculate transformation: frequency in all assays since some may involve prolonged incubation and/or replating.

1.5. QUALITY CRITERIA

None.

1.6. DESCRIPTION OF THE TEST METHOD*Preparations***C e l l s**

A variety of cell lines or primary cells are available depending on the transformation test being used. The investigator must ensure that the cells in the test being performed exhibit the appropriate phenotypic change after exposure to known carcinogens and that the test, in the investigator's laboratory, is of proven and documented validity and reliability.

M e d i u m

Media and experimental conditions should be used that are appropriate to the transformation assay in use.

▼ B**Test substance**

Test substances may be prepared in culture media or dissolved or suspended in appropriate vehicles prior to treatment of the cells. The final concentration of the vehicle in the culture system should not affect cell viability, growth rate or transformation incidence.

Metabolic activation

Cells should be exposed to the test substance both in the presence and absence of an appropriate metabolic activation system. Alternatively, when cell types are used that possess intrinsic metabolic activity, the nature of the activity should be known to be appropriate to the chemical class being tested.

*Test conditions***Use of negative and positive controls**

Positive controls, using both a direct-acting compound and a compound requiring metabolic activation should be included in each experiment; a negative (vehicle) control should also be used.

The following are examples of substances, which might be used as positive controls:

— Direct-acting chemicals:

— Ethylmethanesulphonate,

— β -propiolactone,

— Compounds requiring metabolic activation:

— 2-acetylaminofluorene,

— 4-dimethylaminoazobenzene,

— 7,12-dimethylbenzanthracene.

When appropriate, an additional positive control of the same chemical class as the compound under test should be included.

Exposure concentrations

Several concentrations of the test substance should be used. These concentrations should yield a concentration-related toxic effect, the highest concentration producing a low level of survival and the survival in the lowest concentration being approximately the same as that in the negative control. Relatively water-insoluble substances should be tested up to the limit of solubility using appropriate procedures. For freely water-soluble non-toxic substances the upper test substance concentration should be determined on a case-by-case basis.

▼ B*Procedure*

Cells should be exposed for a suitable period of time depending on the test system in use, and this may involve re-dosing accompanied by a change of medium (and if necessary, fresh metabolic activation mixture) if exposure is prolonged. Cells without sufficient intrinsic metabolic activity should be exposed to the test substance in the presence and absence of an appropriate metabolic activation system. At the end of the exposure period, cells are washed free of test substance and cultured under conditions appropriate for the appearance of the transformed phenotype being monitored and the incidence of transformation determined. All results are confirmed in an independent experiment.

2. DATA

Data should be presented in tabular form and may take a variety of forms according to the assay being used e.g. plate counts, positive plates or numbers of transformed cells. Where appropriate, survival should be expressed as a percentage of control levels and transformation frequency expressed as the number of transformants per number of survivors. Data should be evaluated using appropriate statistical methods.

3. REPORTING**3.1. TEST REPORT**

The test report shall, if possible, contain the following information:

- cell type used, number of cell cultures, methods for maintenance of cell cultures,
- test conditions: concentration of test substance, vehicle used, incubation time, duration and frequency of treatment, cell density during treatment, type of exogenous metabolic activation system used, positive and negative controls, specification of phenotype being monitored, selective system used (if appropriate), rationale for dose selection,
- method used to enumerate viable and transformed cells,
- statistical evaluation,
- discussion of results,
- interpretation of results.

3.2. EVALUATION AND INTERPRETATION

See General introduction Part B.

4. REFERENCES

See General introduction Part B.

▼M8**B.22. RODENT DOMINANT LETHAL TEST**

INTRODUCTION

1. This test method (TM) is equivalent to the OECD test guideline (TG) 478 (2016). Test methods are periodically reviewed in the light of scientific progress, changing regulatory needs, and animal welfare considerations. This modified version of the test method reflects more than thirty years of experience with this test and the potential for integrating or combining this test with other toxicity tests such as developmental, reproductive toxicity, or genotoxicity studies; however due to its limitations and the use of a large number of animals this assay is not intended for use as a primary method, but rather as a supplemental test method which can only be used when there is no alternative for regulatory requirements. Combining toxicity testing has the potential to spare large numbers of animals from use in toxicity tests. A document that provides succinct information on genetic toxicology testing and an overview of the recent changes that were made to genetic toxicity OECD test guidelines has been developed by OECD (1).
2. The purpose of the Dominant lethal (DL) test is to investigate whether chemicals produce mutations resulting from chromosomal aberrations in germ cells. In addition, the dominant lethal test is relevant to assessing genotoxicity because, although they may vary among species, factors of *in vivo* metabolism, pharmacokinetics and DNA-repair processes are active and contribute to the response. Induction of a DL mutation after exposure to a test chemical indicates that the chemical has affected germinal tissue of the test animal.
3. DL mutations cause embryonic or foetal death. Induction of DL mutation after exposure to a test chemical indicates that the chemical has affected the germ cells of the test animal.
4. A DL assay is useful for confirmation of positive results of tests using somatic *in vivo* endpoints, and is a relevant endpoint for the prediction of human hazard and risk of genetic diseases transmitted through the germline. However, this assay requires a large number of animals and is labour-intensive; as a result, it is very expensive and time-consuming to conduct. Because the spontaneous frequency of dominant lethal mutations is quite high, the sensitivity of the assay for detection of small increases in the frequency of mutations is generally limited.
5. Definitions of key terms are set out in Appendix 1.

INITIAL CONSIDERATIONS

6. The test is most often conducted in mice (2) (3) (4) but other species, such as rats (5) (6) (7) (8), may in some cases be appropriate if scientifically justified. DLs generally are the result of gross chromosomal aberrations (structural and numerical abnormalities) (9) (10) (11), but gene mutations

▼M8

cannot be excluded. A DL mutation is a mutation occurring in a germ cell per se, or is fixed post fertilisation in the early embryo, that does not cause dysfunction of the gamete, but is lethal to the fertilised egg or developing embryo.

7. Individual males are mated sequentially to virgin females at appropriate intervals. The number of matings following treatment is dependent on the ultimate purpose of the DL study (Paragraph 23) and should ensure that all phases of male germ cell maturation are evaluated for DLs (12).
8. If there is evidence that the test chemical, or its metabolite(s), will not reach the testis, it is not appropriate to use this test.

PRINCIPLE OF THE TEST

9. Generally, male animals are exposed to a test chemical by an appropriate route of exposure and mated to untreated virgin females. Different germ cell types can be tested by the use of sequential mating intervals. Following mating, the females are euthanised after an appropriate period of time, and their uteri are examined to determine the numbers of implants and live and dead embryos. The dominant lethality of a test chemical is determined by comparing the live implants per female in the treated group with the live implants per female in the vehicle/solvent control group. The increase of dead implants per female in the treated group over the dead implants per female in the control group reflects the test-chemical-induced post-implantation loss. The post-implantation loss is calculated by determining the ratio of dead to total implants in the treated group compared to the ratio of dead to total implants in the control group. Pre-implantation loss can be estimated by comparing corpora lutea counts minus total implants or the total implants per female in treated and control groups.

VERIFICATION OF LABORATORY PROFICIENCY

10. Competence in this assay should be established by demonstrating the ability to reproduce dominant lethal frequencies from published data (e.g. (13) (14) (15) (16) (17) (18)) with positive control substances (including weak responses) such as those listed in Table 1, and vehicle controls and obtaining negative control frequencies that are consistent acceptable range of data (see references above) or with the laboratory's historical control distribution, if available.

DESCRIPTION OF THE METHOD**Preparations***Selection of animal species*

11. Commonly used laboratory strains of healthy sexually mature animals should be employed. Mice are commonly used but rats may also be appropriate. Any other appropriate mammalian species may be used, if scientific justification is provided in the report.

▼M8*Animal housing and feeding conditions*

12. For rodents, the temperature in the animal room should be 22 °C (\pm 3 °C). Although the relative humidity ideally should be 50-60 %, it should be at least 40 % and preferably not exceed 70 %, other than during room cleaning. Lighting should be artificial, the sequence being 12 hours light, followed by 12 hours dark. For feeding, conventional laboratory diets may be used with an unlimited supply of drinking water. The choice of diet may be influenced by the need to ensure a suitable admixture of a test chemical when administered by this route. Prior to treatment or mating, rodents should be housed in small groups (no more than five) of the same sex if no aggressive behaviour is expected or observed, preferably in solid cages with appropriate environmental enrichment. Animals may be housed individually if scientifically justified.

Preparation of the animals

13. Healthy and sexually mature male and female adult animals are randomly assigned to the control and treatment groups. The individual animals are identified uniquely using a humane, minimally invasive method (e.g. by ringing, tagging, micro-chipping, or biometric identification, but not toe and ear clipping) and acclimated to the laboratory conditions for at least five days. Cages should be arranged in such a way that possible effects due to cage placement are minimised. Cross contamination by the positive control and the test chemical should be avoided. At the commencement of the study, the weight variation of animals should be minimal and not exceed \pm 20 % of the mean weight of each sex.

Preparation of doses

14. Solid test chemicals should be dissolved or suspended in appropriate solvents or vehicles or admixed in diet or drinking water prior to dosing of the animals. Liquid test chemicals may be dosed directly or diluted prior to dosing. For inhalation exposures, test chemicals can be administered as gas, vapour, or a solid/liquid aerosol, depending on their physicochemical properties. Fresh preparations of the test chemical should be employed unless stability data demonstrate the acceptability of storage and define the appropriate storage conditions.

Test Conditions*Solvent/vehicle*

15. The solvent/vehicle should not produce toxic effects at the dose volumes used, and should not be suspected of chemical reaction with the test chemical. If other than well-known solvents/vehicles are used, their inclusion should be supported with reference data indicating their compatibility. It is recommended that wherever possible, the use of an aqueous solvent/vehicle should be considered first. Examples of commonly used compatible solvents/vehicles include water, physiological saline, methylcellulose solution, carboxymethyl cellulose sodium salt solution, olive oil and corn oil.

Positive controls

16. Concurrent positive control animals should always be used unless the laboratory has demonstrated proficiency in the conduct of the test and has used the test routinely in the recent past (e.g. within the last 5 years). However, it is not necessary to treat positive control animals by the same route as animals receiving the test chemical, or sample all the mating

▼M8

intervals. The positive control substances should be known to produce DLs under the conditions used for the test. Except for the treatment, animals in the control groups should be handled in an identical manner to animals in the treated groups.

17. The doses of the positive control substances should be selected so as to produce weak or moderate effects that critically assess the performance and sensitivity of the assay, but which consistently produce positive dominant lethal effects. Examples of positive control substances, and appropriate doses, are included in Table 1.

Table 1

Examples of Positive Control Substances.

Substance [CAS no.] (reference no.)	Effective Dose range (mg/kg) (rodent species)	Administration Time (days)
Triethylenemelamine [51-18-3] (15)	0,25 (mice)	1
Cyclophosphamide [50-18-0] (19)	50-150 (mice)	5
Cyclophosphamide [50-18-0] (5)	25-100 (rats)	1
Ethyl methanesulphonate [62-50-0] (13)	100-300 (mice)	5
Monomeric Acrylamide [79-06-1] (17)	50 (mice)	5
Chlorambucil [305-03-3] (14)	25 (mice)	1

Negative controls

18. Negative control animals, treated with solvent or vehicle alone, and otherwise treated in the same way as the treatment groups, should be included for every sampling time (20). In the absence of historical or published control data showing that no DLs or other deleterious effects are induced by the chosen solvent/vehicle, untreated control animals should also be included for every sampling time in order to establish acceptability of the vehicle control.

PROCEDURE

Number of Animals

19. Individual males are mated sequentially at appropriate predetermined intervals (e.g. weekly intervals, Paragraphs 21 & 23) preferably to one virgin female. The number of males per group should be predetermined to be sufficient (in combination with the number of mated females at each mating interval) to provide the statistical power necessary to detect at least a doubling in DL frequency (Paragraph 44).
20. The number of females per mating interval should also be predetermined by statistical power calculations to permit the detection of at least a doubling in the DL frequency (i.e. sufficient pregnant females to provide at least 400 total implants) (20) (21) (22) (23) and that at least one dead implant per analysis unit (i.e. mating group per dose) is expected (24).

▼M8**Administration Period and Mating Intervals**

21. The number of mating intervals following treatment is governed by the treatment schedule and should ensure that all phases of male germ cell maturation are evaluated for DL induction (12) (25). For a single treatment up to five daily dose administrations, there should be 8 (mouse) or 10 (rat) matings conducted at weekly intervals following the last treatment. For multiple dose administrations, the number of mating intervals may be reduced in proportion to the increased time of the administration period, but maintaining the goal of evaluating all phases of spermatogenesis (e.g. after a 28-day exposure, only 4 weekly matings are sufficient to evaluate all phases of spermatogenesis in the mouse). All treatment and mating schedules should be scientifically justified.

22. Females should remain with the males for at least the duration of one oestrus cycle (e.g. one week covers one oestrus cycle in both mice and rats). Females that did not mate during a one-week interval can be used for a subsequent mating interval. Alternatively, until mating has occurred, as determined by the presence of sperm in the vagina or by the presence of a vaginal plug.

23. The exposure and mating regimen used is dependent on the ultimate purpose of the DL study. If the goal is to determine whether a given chemical induces DL mutations *per se*, then the accepted method would be to expose an entire round of spermatogenesis (e.g. 7 weeks in the mouse, 5-7 treatments per week) and mate once at the end. However, if the goal is to identify the sensitive germ cell type for DL induction, then a single or 5 day exposure followed by weekly mating is preferred.

Dose Levels

24. If a preliminary range-finding study is performed because there are no suitable data already available to aid in dose selection, it should be performed in the same laboratory, using the same species, strain, sex, and treatment regimen to be used in the main study (26). The study should aim to identify the maximum tolerated dose (MTD), defined as the highest dose that will be tolerated without evidence of study-limiting toxicity, relative to the duration of the study period (for example, abnormal behaviour or reactions, minor body weight depression or hematopoietic system cytotoxicity), but not death or evidence of pain, suffering or distress necessitating humane euthanasia (27).

25. The MTD must also not adversely affect mating success (21).

26. Test chemicals with specific biological activities at low non-toxic doses (such as hormones and mitogens), and chemicals which exhibit saturation of toxicokinetic properties may be exceptions to the dose-setting criteria and should be evaluated on a case-by-case basis.

27. In order to obtain dose response information, a complete study should include a negative control group and a minimum of three dose levels generally separated by a factor of 2, but not greater than 4. If the test chemical does not produce toxicity in a range-finding study, or based on existing data, the highest dose for a single administration should be 2 000 mg/kg body weight. However, if the test chemical does cause

▼M8

toxicity, the MTD should be the highest dose administered and the dose levels used should preferably cover a range from the maximum to a dose producing little or no toxicity. For not-toxic chemicals, the limit dose for an administration period of 14 days or more is 1 000 mg/kg body weight/day, and for administration periods of less than 14 days the limit dose is 2 000 mg/kg body weight/day.

Administration of Doses

28. The anticipated route of human exposure should be considered when designing an assay. Therefore, routes of exposures such as dietary, drinking water, subcutaneous, intravenous, topical, inhalation, oral (by gavage), or implantation may be chosen as justified. In any case, the route should be chosen to ensure adequate exposure of the target tissue(s). Intra-peritoneal injection is not normally recommended since it is not an intended route of human exposure, and should only be used with specific scientific justification. If the test chemical is admixed in diet or drinking water, especially in case of single dosing, care should be taken that the delay between food and water consumption and mating should be sufficient to allow detection of the effects (paragraph 31). The maximum volume of liquid that can be administered by gavage or injection at one time depends on the size of the test animal. The volume should not normally exceed 1 ml/100g body weight except in the case of aqueous solutions where a maximum of 2 ml/100g may be used. The use of volumes greater than this (if permitted by animal welfare legislation) should be justified. Variability in test volume should be minimised by adjusting the concentration to ensure a constant volume in relation to body weight at all dose levels.

Observations

29. General clinical observations of the test animals should be made and clinical signs recorded at least once a day, preferably at the same time(s) each day and considering the peak period of anticipated effects after dosing. At least twice daily during the dosing period, all animals should be observed for morbidity and mortality. All animals should be weighed at the beginning of the study and at least once a week during repeated dose studies, and at the time of euthanasia. Measurements of food consumption should be made at least weekly. If the test chemical is administered via the drinking water, water consumption should be measured at each change of water and at least weekly. Animals exhibiting non-lethal indicators of excess toxicity should be euthanised prior to completion of the test period (27).

Tissue Collection and Processing

30. Females are euthanised in the second half of pregnancy at gestation day (GD) 13 for mice and GD 14-15 for rats. Uteri are examined for dominant lethal effects to determine the number of implants, live and dead embryos, and corpora lutea.
31. The uterine horns and ovaries are exposed for counting of corpora lutea, and fetuses are removed, counted, and weighted. Care should be taken to examine the uteri for resorptions obscured by live fetuses and to ensure that all resorptions are enumerated. Fetal mortality is recorded. The number of successfully impregnated females and the number of total implantations, pre-implantation losses, and post-implantation mortality (included

▼M8

early and late resorptions) also are recorded. In addition, the visible fetuses may be preserved in Bouin's fixative for at least 2 weeks followed by examination for major external malformations (28) to provide additional information on the reproductive and developmental effects of the test agent.

DATA AND REPORTING**Treatment of Results**

32. Data should be tabulated to show the number of males mated, the number of pregnant females, and the number of non-pregnant females. Results of each mating, including the identity of each male and female, should be reported individually. The mating interval, dose level for treated males, and the numbers of live implants and dead implants should be enumerated for each female.
33. The post-implantation loss is calculated by determining the ratio of dead to total implants from the treated group compared to the ratio of dead to total implants from the vehicle/solvent control group.
34. Pre-implantation loss is calculated as the difference between the number of corpora lutea and the number of implants, or as a reduction in the average number of implants per female in comparison with control matings. Where pre-implantation loss is estimated, it should be reported.
35. The Dominant Lethal factor is estimated as: $(\text{post-implantation deaths}/\text{total implantations per female}) \times 100$.
36. Data on toxicity and clinical signs (as per Paragraph 29) should be reported.

Acceptability Criteria

37. The following criteria determine the acceptability of a test.
 - Concurrent negative control is consistent with published norms for historical negative control data, and the laboratory's historical control data if available (see Paragraphs 10 and 18).
 - Concurrent positive controls induce responses that are consistent with published norms for historic positive control data, or the laboratory's historical positive control database, if available, and produce a statistically significant increase compared with the negative control (see Paragraphs 17 and 18).
 - Adequate number total implants and doses have been analysed (Paragraph 20).
 - The criteria for the selection of top dose are consistent with those described in Paragraphs 24 and 27.

Evaluation and Interpretation of Results

38. At least three treated dose groups should be analysed in order to provide sufficient data for dose-response analysis.

▼ M8

39. Providing that all acceptability criteria are fulfilled, a test chemical is considered a clear positive if:

- at least one of the test doses exhibits a statistically significant increase compared with the concurrent negative control;
- the increase is dose-related in at least one experimental condition (e.g. a weekly mating interval) when evaluated with an appropriate test; and,
- any of the results are outside of the acceptable range of negative control data, or the distribution of the laboratory's historical negative control data (e.g. Poisson-based 95 % control limit) if available.

The test chemical is then considered able to induce dominant lethal mutations in germ cells of the test animals. Recommendations for the most appropriate statistical methods are described in Paragraph 44; other recommend statistical approaches can also be found in the literature (20) (21) (22) (24) (29). Statistical tests used should consider the animal as the experimental unit.

40. Providing that all acceptability criteria are fulfilled, a test chemical is considered a clear negative if:

- none of the test doses exhibits a statistically significant increase compared with the concurrent negative control;
- there is no dose-related increase in any experimental condition; and
- all results are within acceptable range of negative control data, or the laboratory's historical negative control data (e.g. Poisson-based 95 % control limit), if available.

The test chemical is then considered unable to induce dominant lethal mutations in germ cells of the test animals.

41. There is no requirement for verification of a clear positive or a clear negative response.

42. If the response is not clearly negative or positive, and in order to assist in establishing the biological relevance of a result (e.g. a weak or borderline increase), the data should be evaluated by expert judgment and/or further investigations using the existing experimental data, such as consideration whether the positive result is outside the acceptable range of negative control data, or the laboratory's historical, negative control data (30).

43. In rare cases, even after further investigations, the data set will preclude making a conclusion of positive or negative results, and will therefore be concluded as equivocal.

44. Statistical tests used should consider the male animal as the experimental unit. While it is possible that count data (e.g. number of implants per female) may be Poisson distributed and/or proportions (e.g. proportion of dead implants) may be binomially distributed, it is often the case that such data are overdispersed (31). Accordingly, statistical analysis should first employ a test for over- underdispersion using variance tests such as Cochran's binomial variance test (32) or Tarone's $C(\alpha)$ test for binomial overdispersion (31) (33). If no departure from binomial dispersion is detected, trends in proportions across dose levels may be tested using the Cochran-Armitage trend test (34) and pairwise comparisons with the control group may be tested using Fisher's exact test (35). Likewise, if no departure from

▼ M8

Poisson dispersion is detected, trends in counts may be tested using Poisson regression (36) and pairwise comparisons with the control group may be tested within the context of the Poisson model, using pairwise contrasts (36). If significant overdispersion or underdispersion is detected, nonparametric methods are recommended (23) (31). These include rank-based tests, such as the Jonckheere-Terpstra test for trend (37) and Mann-Whitney tests (38) for pairwise comparisons with the vehicle/solvent control group, as well as permutation, resampling, or bootstrap tests for trend and pairwise comparisons with the control group (31) (39).

45. A positive DL assay provides evidence for the genotoxicity of the test chemical in the germ cells of the treated male of the test species.
46. Consideration of whether the observed values are within or outside of the historical control range can provide guidance when evaluating the biological significance of the response (40).

Test Report

47. The test report should include the following information.

*Summary.**Test chemical:*

- source, lot number, limit date for use, if available;
- stability of the test chemical itself, if known;
- solubility and stability of the test chemical in solvent, if known;
- measurement of pH, osmolality, and precipitate in the culture medium to which the test chemical was added, as appropriate.

Mono-constituent substance:

- physical appearance, water solubility, and additional relevant physico-chemical properties;
- chemical identification, such as IUPAC or CAS name, CAS number, SMILES or InChI code, structural formula, purity, chemical identity of impurities as appropriate and practically feasible, etc.

Multi-constituent substance, UVCBs and mixtures:

- characterised as far as possible by chemical identity (see above), quantitative occurrence and relevant physicochemical properties of the constituents.

Test chemical preparation:

- justification for choice of vehicle;
- solubility and stability of the test chemical in the solvent/vehicle, if known;

▼M8

- preparation of dietary, drinking water or inhalation formulations;
- analytical determinations on formulations (e.g. stability, homogeneity, nominal concentrations) when conducted.

Test animals:

- species/strain used and justification for the choice;
- number, age and sex of animals;
- source, housing conditions, diet, etc.;
- method of uniquely identifying the animals;
- for short-term studies: individual body weight of the male animals at the start and end of the test; for studies longer than one week: individual body weights during the study and food consumption. Body weight range, mean and standard deviation for each group should be included.

Test conditions:

- positive and negative (vehicle/solvent) control data;
- data from the range-finding study;
- rationale for dose level selection;
- details of test chemical preparation;
- details of the administration of the test chemical;
- rationale for route of administration;
- methods for measurement of animal toxicity, including, where available, histopathological or hematological analyses and the frequency with which animal observations and body weights were taken;
- methods for verifying that the test chemical reached the target tissue, or general circulation, if negative results are obtained;
- actual dose (mg/kg body weight/day) calculated from diet/drinking water test chemical concentration (ppm) and consumption, if applicable;
- details of food and water quality;
- details on cage environment enrichment;
- detailed description of treatment and sampling schedules and justifications for the choices;
- method of analgesia
- method of euthanasia;

▼M8

- procedures for isolating and preserving tissues;
- source and lot numbers of all kits and reagents (where applicable);
- methods for enumeration of DLs;
- mating schedule;
- methods used to determine that mating has occurred;
- time of euthanasia;
- criteria for scoring DL effects, including, corpora lutea, implantations, resorptions and pre-implantation losses, live implants, dead implants.

Results:

- animal condition prior to and throughout the test period, including signs of toxicity;
- male body weight during the treatment and mating periods;
- number of mated females;
- dose-response relationship, where possible;
- concurrent and historical negative control data with ranges, means and standard deviations;
- concurrent positive control data;
- tabulated data for each dam including: number of corpora lutea per dam; number of implantations per dam; number of resorptions and pre-implantation losses per dam; number of live implants per dam; number of dead implants per dam; fetus weights;
- the above data summarised for each mating period and dose, with Dominant Lethal frequencies;
- statistical analyses and methods applied.

*Discussion of the results.**Conclusion.***LITERATURE**

- (1) OECD (2016). Overview of the set of OECD Genetic Toxicology Test Guidelines and updates performed in 2014-2015. ENV Publications. Series on Testing and Assessment, No 234, OECD, Paris.
- (2) Bateman, A.J. (1977). The Dominant Lethal Assay in the Male Mouse, in Handbook of Mutagenicity Test Procedures B.J. Kilbey *et. al.* (Eds.) pp. 235-334, Elsevier, Amsterdam
- (3) Ehling U.H., Ehling, U.H., Macherer, L., Buselmaier, E., Dycka, D., Froberg, H., Kratochvilova, J., Lang, R., Lorke, D., Muller, D., Peh, J., Rohrborn, G., Roll, R., Schulze-Schencking, M., and Wiemann, H. (1978). Standard Protocol for the Dominant Lethal Test on Male Mice. Set up by the Work Group 'Dominant' lethal mutations of the ad hoc Committee Chemogenetics, Arch. Toxicol., 39, 173-185

▼M8

- (4) Shelby M.D. (1996). Selecting Chemicals and Assays for Assessing Mammalian Germ Cell Mutagenicity. *Mutation Res.*, 352:159-167.
- (5) Knudsen I., Knudsen, I., Hansen, E.V., Meyer, O.A. and Poulsen, E. (1977). A proposed Method for the Simultaneous Detection of Germ-Cell Mutations Leading to Fetal Death (Dominant Lethality) and of Malformations (Male Teratogenicity) in Mammals. *Mutation Res.*, 48:267-270.
- (6) Anderson D., Hughes, J.A., Edwards, A.J. and Brinkworth, M.H. (1998). A Comparison of Male-Mediated Effects in Rats and Mice Exposed to 1,3-Butadiene. *Mutation Res.*, 397:77-74.
- (7) Shively C.A., C.A., White, D.M., Blauch, J.L. and Tarka, S.M. Jr. (1984). Dominant Lethal Testing of Theobromine in Rats. *Toxicol. Lett.* 20:325-329.
- (8) Rao K.S., Cobel-Gear, S.R., Young, J.T., Hanley, T.R. Jr., Hayes, W.C., John, J.A. and Miller, R.R. (1983). Ethyl Glycol Monomethyl Ether II. Reproductive and dominant Lethal Studies in Rats. *Fundam. Appl. Toxicol.*, 3:80-85.
- (9) Brewen J.G., Payne, H.S., Jones, K.P., and Preston, R.J. (1975). Studies on Chemically Induced Dominant Lethality. I. The Cytogenetic Basis of MMS-Induced Dominant Lethality in Post-Meiotic Male Germ Cells, *Mutation Res.*, 33, 239-249.
- (10) Marchetti F., Bishop, J.B., Cosentino, L., Moore II, D. and Wyrobek, A.J. (2004). Paternally Transmitted Chromosomal Aberrations in Mouse Zygotes Determine their Embryonic Fate. *Biol. Reprod.*, 70:616-624.
- (11) Marchetti F. and Wyrobek, A.J. (2005). Mechanisms and Consequences of Paternally Transmitted Chromosomal Aberrations. *Birth Defects Res., C* 75:112-129.
- (12) Adler I.D. (1996). Comparison of the Duration of Spermatogenesis Between Rodents and Humans. *Mutation Res.*, 352:169-172.
- (13) Favor J., and Crenshaw J.W. (1978). EMS-Induced Dominant Lethal Dose Response Curve in DBA/1J Male Mice, *Mutation Res.*, 53: 21-27.
- (14) Generoso W.M., Witt, K.L., Cain, K.T., Hughes, L. Cacheiro, N.L.A., Lockhart, A.M.C. and Shelby, M.D. (1995). Dominant Lethal and Heritable Translocation Test with Chlorambucil and Melphalan. *Mutation Res.*, 345:167-180.
- (15) astings S.E., Huffman K.W. and Gallo M.A. (1976). The dominant Lethal Effect of Dietary Triethylenemelamine, *Mutation Res.*, 40:371-378.
- (16) James D.A. and Smith D.M. (1982). Analysis of Results from a Collaborative Study of the Dominant Lethal Assay, *Mutation Res.*, 99:303-314.
- (17) Shelby M.D., Cain, K.T., Hughes, L.A., Braden, P.W. and Generoso, W.M. (1986). Dominant Lethal Effects of Acrylamide in Male Mice. *Mutation Res.*, 173:35-40.

▼ **M8**

- (18) Sudman P.D., Rutledge, J.C., Bishop, J.B. and Generoso W.M. (1992). Bleomycin: Female-Specific Dominant Lethal Effects in Mice, *Mutation Res.*, 296: 143-156.
- (19) Holstrom L.M., Palmer A.K. and Favor, J. (1993). The Rodent Dominant Lethal Assay. In *Supplementary Mutagenicity Tests*. Kirkland D.J. and Fox M. (Eds.), Cambridge University Press, pp. 129-156.
- (20) Adler I-D., Bootman, J., Favor, J., Hook, G., Schriever-Schwemmer, G., Welzl, G., Whorton, E., Yoshimura, I. and Hayashi, M. (1998). Recommendations for Statistical Designs of *In Vivo* Mutagenicity Tests with Regard to Subsequent Statistical Analysis, *Mutation Res.*, 417:19–30.
- (21) Adler I.D., Shelby M. D., Bootman, J., Favor, J., Generoso, W., Pacchierotti, F., Shibuya, T. and Tanaka N. (1994). International Workshop on Standardisation of Genotoxicity Test Procedures. Summary Report of the Working Group on Mammalian Germ Cell Tests. *Mutation Res.*, 312:313-318.
- (22) Generoso W.M. and Piegorsch W.W. (1993). Dominant Lethal Tests in Male and Female Mice. *Methods, Toxicol.*, 3A:124-141.
- (23) Haseman J.K. and Soares E.R. (1976). The Distribution of Fetal Death in Control Mice and its Implications on Statistical Tests for Dominant Lethal Effects. *Mutation. Res.*, 41: 277-288.
- (24) Whorton E.B. Jr. (1981). Parametric Statistical Methods and Sample Size Considerations for Dominant Lethal Experiments. The Use of Clustering to Achieve Approximate Normality, *Teratogen. Carcinogen. Mutagen.*, 1:353 – 360.
- (25) Anderson D., Anderson, D., Hodge, M.C.E., Palmer, S., and Purchase, I.F.H. (1981). Comparison of Dominant Lethal and Heritable Translocation Methodologies. *Mutation. Res.*, 85:417-429.
- (26) Fielder R. J., Allen, J. A., Boobis, A. R., Botham, P. A., Doe, J., Esdaile, D. J., Gatehouse, D. G., Hodson-Walker, G., Morton, D. B., Kirkland, D. J. and Richold, M. (1992). Report of British Toxicology Society/UK Environmental Mutagen Society Working Group: Dose Setting in *In Vivo* Mutagenicity Assays. *Mutagen.*, 7:313-319.
- (27) OECD (2000). Guidance Document on the Recognition, Assessment and Use of Clinical Signs as Humane Endpoints for Experimental Animals Used in Safety Evaluation. Environment, Health and Safety Publications, Series on Testing and Assessment (No.19.), Organisation for Economic Cooperation and Development, Paris.
- (28) Barrow M.V., Taylor W.J and Morphol J. (1969). A Rapid Method for Detecting Malformations in Rat Fetuses, 127, 291–306.
- (29) Kirkland D.J., (Ed.)(1989). *Statistical Evaluation of Mutagenicity Test Data*, Cambridge University Press.
- (30) Hayashi, M., Dearfield, K., Kasper P., Lovell D., Martus H.-J. and Thybaud V. (2011). 'Compilation and Use of Genetic Toxicity Historical Control Data', *Mutation. Res.*, 723:87-90.
- (31) Lockhart A.C., Piegorsch W.W. and Bishop J.B. (1992). Assessing Over Dispersion and Dose-Response in the Male Dominant Lethal Assay. *Mutation. Res.*, 272:35-58.
- (32) Cochran W.G. (1954). Some Methods for Strengthening the Common χ^2 Tests. *Biometrics*, 10: 417-451.

▼M8

- (33) Tarone R.E. (1979). Testing the Goodness of Fit of the Binomial Distribution. *Biometrika*, 66: 585-590.
- (34) Margolin B.H. (1988). Test for Trend in Proportions. In *Encyclopedia of Statistical Sciences*, Volume 9, Kotz S. and Johnson N. L. (Eds.), pp. 334-336. John Wiley and Sons, New York.
- (35) Cox D.R., Analysis of Binary Data. Chapman and Hall, London (1970).
- (36) Neter J.M., Kutner, H.C., Nachtsheim, J. and Wasserman, W. (1996). Applied Linear Statistical Models, Fourth Edition, Chapters 14 and 17. McGraw-Hill, Boston
- (37) Jonckheere R. (1954). A Distribution-Free K-Sample Test Against Ordered Alternatives. *Biometrika*, 41:133-145.
- (38) Conover W.J. (1971). Practical Nonparametric Statistics. John Wiley and Sons, New York
- (39) Efron, B. (1982). The Jackknife, the Bootstrap and Other Resampling Plans. Society for Industrial and Applied Mathematics, Philadelphia, PA.
- (40) Fleiss J. (1973). Statistical Methods for Rates and Proportions. John Wiley and Sons, New York.

▼ M8*Appendix 1*

DEFINITIONS

Chemical: A substance or a mixture

Corpora luteum (lutea): the hormonal secreting structure formed on the ovary at the site of a follicle that has released the egg. The number of corpora lutea in the ovaries corresponds to the number of eggs that were ovulated.

Dominant Lethal Mutation: a mutation occurring in a germ cell, or is fixed after fertilisation, that causes embryonic or foetal death.

Fertility rate: the number of mated pregnant female over the number of mated females.

Mating interval: the time between the end of exposure and mating of treated males. By controlling this interval, chemical effects on different germ cell types can be assessed. In the mouse mating during the 1, 2, 3, 4, 5, 6, 7 and 8 week after the end of exposure measures effects in sperm, condensed spermatids, round spermatids, pachytene spermatocytes, early spermatocytes, differentiated spermatogonia, differentiating spermatogonia and stem cell spermatogonia.

Preimplantation loss: the difference between the number of implants and the number of corpora lutea. It can also be estimated by comparing the total implants per female in treated and control groups.

Postimplantation loss: the ratio of dead implant in the treated group compared to the ratio of dead to total implants in the control group.

Test chemical: Any substance or mixture tested using this test method.

UVCB: Chemical Substance of Unknown or Variable Composition, Complex Reaction Products and Biological Materials

▼ M8

Appendix 2

TIMING OF SPERMATOGENESIS IN MAMMALS

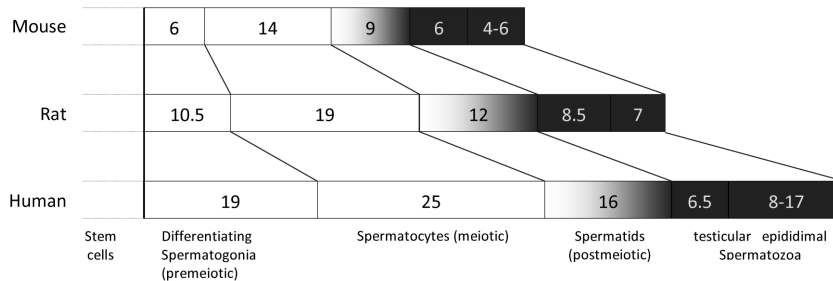

Fig.1: Comparison of the duration (days) of male germ cell development in mice, rats and humans. DNA repair does not occur during the periods indicated by shading.

A schematic of spermatogenesis in the mouse, rat and human is shown above (taken from Adler, 1996). Undifferentiated spermatogonia include: A-single; A-paired; and A-aligned spermatogonia (Hess and de Franca, 2008). A-single is considered the true stem cells; therefore, to assess effects on stem cells at least 49 days (in the mouse) must pass between the last injection of the test chemical and mating.

References

Adler, ID (1996). Comparison of the duration of spermatogenesis between rodents and humans. *Mutat Res*, 352:169-172.

Hess, RA, De Franca LR (2008). Spermatogenesis and cycle of the seminiferous epithelium. In: *Molecular Mechanisms in Spermatogenesis*, C. Yan Cheng (Ed), Landes Biosciences and Springer Science&Business Media:1-15.

▼M8**B.23. MAMMALIAN SPERMATOGONIAL CHROMOSOMAL ABERRATION TEST**

INTRODUCTION

1. This test method (TM) is equivalent to the OECD test guideline 483 (2016). Test methods are periodically reviewed in the light of scientific progress, changing regulatory needs, and animal welfare considerations. This modified version of the test method reflects many years of experience with this assay and the potential for integrating or combining this test with other toxicity or genotoxicity studies. Combining toxicity studies has the potential to reduce the numbers of animals used in toxicity testing. This test method is part of a series of test methods on genetic toxicology. A document that provides succinct information on genetic toxicology testing and an overview of the recent changes that were made to genetic toxicity OECD test guidelines has been developed by OECD (1).
2. The purpose of the *in vivo* mammalian spermatogonial chromosomal aberration test is to identify those chemicals that cause structural chromosomal aberrations in mammalian spermatogonial cells (2) (3) (4). In addition, this test is relevant to assessing genotoxicity because, although they may vary among species, factors of *in vivo* metabolism, pharmacokinetics and DNA-repair processes are active and contribute to the response. This test method is not designed to measure numerical abnormalities; the assay is not routinely used for this purpose.
3. This test measures structural chromosomal aberrations (both chromosome- and chromatid-type) in dividing spermatogonial germ cells and is, therefore, expected to be predictive of induction of heritable mutations in these germ cells.
4. Definitions of key terms are set out in the Appendix.

INITIAL CONSIDERATIONS

5. Rodents are routinely used in this test but other species may in some cases be appropriate if scientifically justified. Standard cytogenetic preparations of rodent testes generate mitotic (spermatogonia) and meiotic (spermatocyte) metaphases. Mitotic and meiotic metaphases are identified based on the morphology of the chromosomes (4). This *in vivo* cytogenetic test detects structural chromosomal aberrations in spermatogonial mitoses. Other target cells are not the subject of this test method.
6. To detect chromatid-type aberrations in spermatogonial cells, the first mitotic cell division following treatment should be examined before these aberrations are converted into chromosome-type-aberrations in subsequent cell divisions. Additional information from treated spermatocytes can be obtained by meiotic chromosome analysis for chromosomal structural aberrations at diakinesis-metaphase I and metaphase II.

▼M8

7. A number of generations of spermatogonia are present in the testis (5), and these different germ cell types may have a spectrum of sensitivity to chemical treatment. Thus, the aberrations detected represent an aggregate response of treated spermatogonial cell populations. The majority of mitotic cells in testis preparations are B spermatogonia, which have a cell cycle of approximately 26 hr (3).

8. If there is evidence that the test chemical, or its metabolite(s), will not reach the testis it is not appropriate to use this test.

PRINCIPLE OF THE TEST METHOD

9. Generally, animals are exposed to the test chemical by an appropriate route of exposure and are euthanised at appropriate times after treatment. Prior to euthanasia, animals are treated with a metaphase-arresting agent (e.g. colchicine or Colcemid®). Chromosome preparations are then made from germ cells and stained, and metaphase cells are analysed for chromosome aberrations.

VERIFICATION OF LABORATORY PROFICIENCY

10. Competency in this assay should be established by demonstrating the ability to reproduce expected results for structural chromosomal aberration frequencies in spermatogonia with positive control substances (including weak responses) such as those listed in Table 1 and obtaining negative control frequencies that are consistent with acceptable range of control data in the published literature (e.g. (2)(3)(6)(7)(8)(9)(10)) or with the laboratory's historical control distribution, if available.

DESCRIPTION OF THE METHOD**Preparations***Selection of animal species*

11. Commonly used laboratory strains of healthy young adult animals should be employed. Male mice are commonly used; however, males of other appropriate mammalian species may be used when scientifically justified and to allow this test to be run in conjunction with another test method. The scientific justification for using species other than rodents should be provided in the report.

Animal Housing and feeding conditions

12. For rodents, the temperature in the animal room should be 22 °C (\pm 3 °C). Although the relative humidity ideally should be 50-60 %, it should be at least 40 % and preferably not exceed 70 % other than during room cleaning. Lighting should be artificial, the sequence being 12 hours light, 12 hours dark. For feeding, conventional laboratory diets may be used with an unlimited supply of drinking water. The choice of diet may be influenced by the need to ensure a suitable admixture of a test chemical when administered by this route. Rodents should be housed in small groups (no more than five per cage) if no aggressive behaviour is expected, preferably in solid floor cages with appropriate environmental enrichment. Animals may be housed individually if scientifically justified.

▼M8*Preparation of the animals*

13. Healthy young adult male animals (8-12 weeks old at start of treatment) are normally used, and are randomly assigned to the control and treatment groups. The individual animals are identified uniquely using a humane, minimally invasive method (e.g. by ringing, tagging, micro-chipping or biometric identification, but not ear or toe clipping) and acclimated to the laboratory conditions for at least five days. Cages should be arranged in such a way that possible effects due to cage placement are minimised. Cross contamination by the positive control and test chemical should be avoided. At the commencement of the study, the variation between individual animal weights should be minimal and not exceed $\pm 20\%$.

Preparation of doses

14. Solid test chemicals should be dissolved or suspended in appropriate solvents or vehicles or admixed in diet or drinking water prior to dosing of the animals. Liquid test chemicals may be dosed directly or diluted prior to dosing. For inhalation exposures, test chemicals can be administered as gas, vapour, or a solid/liquid aerosol, depending on their physicochemical properties. Fresh preparations of the test chemical should be employed unless stability data demonstrate the acceptability of storage and define the appropriate storage conditions.

Test conditions - Solvent/vehicle

15. The solvent/vehicle should not produce toxic effects at the dose levels used, and should not be capable of chemical reaction with the test chemicals. If other than well-known solvents/vehicles are used, their inclusion should be supported with reference data indicating their compatibility. It is recommended that, wherever possible, the use of an aqueous solvent/vehicle should be considered first. Examples of commonly used compatible solvents/vehicles include water, physiological saline, methylcellulose solution, carboxymethyl cellulose sodium salt solution, olive oil and corn oil. In the absence of historical or published control data showing that no structural chromosomal aberrations and other deleterious effects are induced by a chosen atypical solvent/vehicle, an initial study should be conducted in order to establish the acceptability of the solvent/vehicle control.

Positive controls

16. Concurrent positive control animals should always be used unless the laboratory has demonstrated proficiency in the conduct of the test and has used the test routinely in the recent past (e.g. within the last 5 years). When a concurrent positive control group is not included, scoring controls (fixed and unstained slides) should be included in each experiment. These can be obtained by including within the scoring of the study appropriate reference samples that have been obtained and stored from a separate positive control experiment conducted periodically (e.g. every 6-18 months) in the laboratory where the test is performed; for example, during proficiency testing and on a regular basis thereafter, where necessary.
17. Positive control substances should reliably produce a detectable increase in the frequencies of cells with structural chromosomal aberrations over the spontaneous levels. Positive control doses should be chosen so that the effects are clear but do not immediately reveal the identity of the coded samples to the scorer. Examples of positive control substances are included in Table 1.

▼ **M8***Table 1***Examples of positive control substances.**

Substances [CAS No] (reference no)
Cyclophosphamide (monohydrate) [CAS no. 50-18-0 (CAS no. 6055-19-2)] (9)
Cyclohexylamine [CAS no. 108-91-8] (7)
Mitomycin C [CAS no. 50-07-7] (6)
Monomeric acrylamide [CAS 79-06-1] (10)
Triethylenemelamine [CAS 51-18-3] (8)

Negative controls

18. Negative control animals, treated with solvent or vehicle alone, and otherwise treated in the same way as the treatment groups, should be included for every sampling time. In the absence of historical or published control data showing that no chromosomal aberrations or other deleterious effects are induced by the chosen solvent/vehicle, untreated control animals also should be included for every sampling time in order to establish acceptability of the vehicle control.

PROCEDURE**Number of animals**

19. Group sizes at study initiation should be established with the aim of providing a minimum of 5 male animals per group. This number of animals per group is considered to be sufficient to provide adequate statistical power (i.e. generally able to detect at least a doubling in chromosomal aberration frequency when the negative control level is 1,0 % or greater with 80 % probability at a significance level of 0,05) (3) (11). As a guide to typical maximum animal requirements, a study at two sampling times with three dose groups and a concurrent negative control group, plus a positive control group (each composed of five animals per group), would require 45 animals.

Treatment schedule

20. Test chemicals are usually administered once (i.e. as a single treatment); other dose regimens may be used, provided they are scientifically justified.
21. In the highest dose group two sampling times after treatment are used. Since the time required for uptake and metabolism of the test chemical(s), as well as its effect on cell cycle kinetics, can affect the optimum time for chromosomal aberration detection, one early and one late sampling time approximately 24 and 48 hours after treatment are used. For doses other than the highest dose, an early sampling time of 24 hours (less than or equal to the cell cycle time of B spermatogonia and thus optimising the probability of scoring first post-treatment metaphases) after treatment should be taken, unless another sampling time is known to be more appropriate and justified.
22. Other sampling times may be used. For example in the case of chemicals that exert S-independent effects, earlier sampling times (i.e. less than 24 hr) may be appropriate.

▼M8

23. A repeat dose treatment regimen can be used, such as in conjunction with a test on another endpoint that uses a 28 day administration period (e.g., TM B.58); however, additional animal groups would be required to accommodate different sampling times. Accordingly, the appropriateness of such a schedule needs to be justified scientifically on a case-by-case basis.

24. Prior to euthanasia, animals are injected intraperitoneally with an appropriate dose of a metaphase arresting chemical (e.g. Colcemid® or colchicine). Animals are sampled at an appropriate interval thereafter. For mice and rats, this interval is approximately 3 - 5 hours.

Dose levels

25. If a preliminary range-finding study is performed because there are no suitable data already available to aid in dose selection, it should be performed in the same laboratory, using the same species, strain, and treatment regimen to be used in the main study, according to recommendations for conducting dose range-finding studies (12). This study should aim to identify the maximum tolerated dose (MTD), defined as the dose inducing slight toxic effects relative to the duration of the study period (for example, abnormal behaviour or reactions, minor body weight depression or hematopoietic system cytotoxicity) but not death or evidence of pain, suffering or distress necessitating euthanasia of the animals (13).

26. The highest dose may also be defined as a dose that produces some indication of toxicity in the spermatogonial cells (e.g. a reduction in the ratio of spermatogonial mitoses to first and second meiotic metaphases). This reduction should not exceed 50 %.

27. Test chemicals with specific biological activities at low non-toxic doses (such as hormones and mitogens), and chemicals which exhibit saturation of toxicokinetic properties may be exceptions to the dose-setting criteria and should be evaluated on a case-by-case basis.

28. In order to obtain dose response information, a complete study should include a negative control group (paragraph 18) and a minimum of three dose levels generally separated by a factor of 2, but by no greater than 4. If the test chemical does not produce toxicity in a range-finding study or based on existing data, the highest dose for a single administration should be 2 000 mg/kg body weight. However, if the test chemical does cause toxicity, the MTD should be the highest dose administered, and the dose levels used should preferably cover a range from the maximum to a dose producing little or no toxicity. When target tissue (i.e. testis) toxicity is observed at all dose levels tested, further study at non-toxic doses is advisable. Studies intending to more fully characterise the quantitative dose-response information may require additional dose groups. For certain types of test chemicals (e.g. human pharmaceuticals) covered by specific requirements, these limits may vary. If the test chemical does produce toxicity, the limit dose plus two lower doses (as described above) should be selected. The limit dose for an administration period of 14 days or more is 1 000 mg/kg body weight/day, and for administration periods of less than 14 days, the limit dose is 2 000 mg/kg/body weight/day.

▼ M8**Administration of doses**

29. The anticipated route of human exposure should be considered when designing an assay. Therefore, routes of exposure such as dietary, drinking water, topical subcutaneous, intravenous, oral (by gavage), inhalation, or implantation may be chosen as justified. In any case, the route should be chosen to ensure adequate exposure of the target tissue. Intraperitoneal injection is not normally recommended unless scientifically justified since it is not usually a physiologically relevant route of human exposure. If the test chemical is admixed in diet or drinking water, especially in case of single dosing, care should be taken that the delay between food and water consumption and sampling should be sufficient to allow detection of the effects (see paragraph 33). The maximum volume of liquid that can be administered by gavage or injection at one time depends on the size of the test animal. The volume should not normally exceed 1 ml/100g body weight except in the case of aqueous solutions where a maximum of 2 ml/100g body weight may be used. The use of volumes greater than this (if permitted by animal welfare legislation) should be justified. Variability in test volume should be minimised by adjusting the concentration to ensure a constant volume in relation to body weight at all dose levels.

Observations

30. General clinical observations of the test animals should be made and clinical signs recorded at least once a day, preferably at the same time(s) each day and considering the peak period of anticipated effects after dosing. At least twice daily, all animals should be observed for morbidity and mortality. All animals should be weighed at study initiation, at least once a week during repeated-dose studies, and at euthanasia. In studies of at least one-week duration, measurements of food consumption should be made at least weekly. If the test chemical is administered via the drinking water, water consumption should be measured at each change of water and at least weekly. Animals exhibiting non-lethal indicators of excess toxicity should be euthanised prior to completion of the test period (13).

Chromosome preparation

31. Immediately after euthanasia, germ cell suspensions are obtained from one, or both, testes, exposed to hypotonic solution and fixed following established protocols (e.g. (2) (14) (15)). The cells are then spread on slides and stained (16) (17). All slides should be coded so that their identity is not available to the scorer.

Analysis

32. At least 200 well spread metaphases should be scored for each animal (3) (11). If the historical negative control frequency is < 1 %, more than 200 cells/animal should be scored to increase the statistical power (3). Staining methods that permit the identification of the centromere should be used.
33. Chromosome and chromatid-type aberrations should be recorded separately and classified by sub-types (breaks, exchanges). Gaps should be recorded, but not considered, when determining whether a chemical induces significant increases in the incidence of cells with chromosomal aberrations. Procedures in use in the laboratory should ensure that analysis of chromosomal aberrations is performed by well-trained scorers. Recognising that slide preparation

▼M8

procedures often result in the breakage of a proportion of metaphases with a resulting loss of chromosomes, the cells scored should, therefore, contain a number of centromeres not less than $2n \pm 2$, where n is the haploid number of chromosomes for that species.

34. Although the purpose of the test is to detect structural chromosomal aberrations, it is important to record the frequencies of polyploid cells and cells with endoreduplicated chromosomes when these events are seen (see Paragraph 44).

DATA AND REPORTING**Treatment of results**

35. Individual animal data should be presented in tabular form. For each animal the number of cells with structural chromosomal aberration(s) and the number of chromosome aberrations per cell should be evaluated. Chromatid- and chromosome-type aberrations classified by sub-types (breaks, exchanges) should be listed separately with their numbers and frequencies for experimental and control groups. Gaps are recorded separately. The frequency of gaps is reported but generally not included in the analysis of the total structural chromosomal aberration frequency. Percentage of polyploidy and cells with endoreduplicated chromosomes are reported when seen.

36. Data on toxicity and clinical signs (as per Paragraph 30) should be reported.

Acceptability Criteria

37. The following criteria determine the acceptability of a test.
- Concurrent negative control is consistent with published norms for historical negative control data, which are generally expected to be $> 0\%$ and $\leq 1,5\%$ cells with chromosomal aberrations, and the laboratory's historical control data if available (see Paragraphs 10 and 18).
 - Concurrent positive controls induce responses that are consistent with published norms for historical positive control data, or the laboratory's historical positive control database, if available, and produce a statistically significant increase compared with the negative control (see Paragraphs 17, 18).
 - Adequate numbers of cells and doses have been analysed (see Paragraphs 28 and 32).
 - The criteria for the selection of top dose are consistent with those described in Paragraphs 25, and 26.
38. If both mitosis and meiosis are observed, the ratio of spermatogonial mitoses to first and second meiotic metaphases should be determined as a measure of cytotoxicity for all treated and negative control animals in a total sample of 100 dividing cells per animal. If only mitosis is observed, the mitotic index should be determined in at least 1 000 cells for each animal.

Evaluation and interpretation of results

39. At least three treated dose groups should be analysed in order to provide sufficient data for dose-response analysis.

▼M8

40. Providing that all acceptability criteria are fulfilled, a test chemical is considered a clear positive if:

- at least one of the test doses exhibits a statistically significant increase compared with the concurrent negative control;
- the increase is dose-related at least at one sampling time; and,
- any of the results are outside acceptable range of negative control data, or the distribution of the laboratory's historical negative control data (e.g. Poisson-based 95 % control limit) if available.

The test chemical is then considered able to induce chromosomal aberrations in spermatogonial cells of the test animals. Recommendations for the most appropriate statistical methods can also be found in the literature (11) (18). Statistical tests used should consider the animal as the experimental unit.

41. Providing that all acceptability criteria are fulfilled, a test chemical is considered a clear negative if:

- none of the test doses exhibits a statistically significant increase compared with the concurrent negative control;
- there is no dose-related increase in any experimental condition; and,
- all results are within acceptable range of negative control data, or the laboratory's historical negative control data (e.g. Poisson-based 95 % control limit), if available.

The test chemical is then considered unable to induce chromosomal aberrations in the spermatogonial cells of the test animals. Recommendations for the most appropriate statistical methods can also be found in the literature (11) (18). A negative result does not exclude the possibility that the chemical may induce chromosomal aberrations at later developmental phases not studied, or gene mutations.

42. There is no requirement for verification of a clear positive or clear negative response.

43. If the response is not clearly negative or positive, and in order to assist in establishing the biological relevance of a result (e.g. a weak or borderline increase), the data should be evaluated by expert judgment and/or further investigations using the existing experimental data, such as consideration whether the positive result is outside the acceptable range of negative control data, or the laboratory's historical negative control data (19).

44. In rare cases, even after further investigations, the data set will preclude making a conclusion of positive or negative results, and will therefore be concluded as equivocal.

45. An increase in the number of polyploid cells may indicate that the test chemical has the potential to inhibit mitotic processes and to induce numerical chromosomal aberrations (20). An increase in the number of cells with endoreduplicated chromosomes may indicate that the test chemical has the potential to inhibit cell cycle progress (21) (22), which is a different mechanism of inducing numerical chromosome changes than inhibition of mitotic processes (see Paragraph 2). Therefore incidence of polyploid cells and cells with endoreduplicated chromosomes should be recorded separately.

▼M8**Test report**

46. The test report should include the following information:

*Summary.**Test chemical:*

- source, lot number, limit date for use, if available;
- stability of the test chemical itself, if known;
- solubility and stability of the test chemical in solvent, if known;
- measurement of pH, osmolality, and precipitate in the culture medium to which the test chemical was added, as appropriate.

Mono-constituents substance:

- physical appearance, water solubility, and additional relevant physico-chemical properties;
- chemical identification, such as IUPAC or CAS name, CAS number, SMILES or InChI code, structural formula, purity, chemical identity of impurities as appropriate and practically feasible, etc.

Multi-constituent substance, UVCBs and mixtures:

- characterised as far as possible by chemical identity (see above), quantitative occurrence and relevant physicochemical properties of the constituents.

Test chemical preparation:

- justification for choice of vehicle;
- solubility and stability of the test chemical in solvent/vehicle.
- preparation of dietary, drinking water or inhalation formulations;
- analytical determinations on formulations (e.g. stability, homogeneity, nominal concentrations when conducted).

Test animals:

- species/strain used and justification for use;
- number and age of animals;
- source, housing conditions, diet, etc.;
- method for uniquely identifying the animals
- for short-term studies: individual weight of the animals at the start and end of the test; for studies longer than one week: individual body weights during the study and food consumption. Body weight range, mean and standard deviation for each group should be included.

Test conditions:

- positive and negative (vehicle/solvent) control data;

▼M8

- data from range finding study, if conducted;
- rationale for dose level selection;
- rationale for route of administration;
- details of test chemical preparation;
- details of the administration of the test chemical;
- rationale for sacrifice times;
- methods for measurement of animal toxicity, including, where available, histopathological or hematological analyses and the frequency with which animal observations and body weights were taken;
- methods for verifying that the test chemical reached the target tissue, or general circulation, if negative results are obtained;
- actual dose (mg/kg body weight/day) calculated from diet/drinking water test chemical concentration (ppm) and consumption, if applicable;
- details of food and water quality;
- detailed description of treatment and sampling schedules and justifications for the choices;
- method of euthanasia;
- method of analgesia (where used)
- procedures for isolating tissues;
- identity of metaphase arresting chemical, its concentration and duration of treatment;
- methods of slide preparation;
- criteria for scoring aberrations;
- number of cells analysed per animal;
- criteria for considering studies as positive, negative or equivocal.

Results:

- animal condition prior to and throughout the test period, including signs of toxicity;
- body and organ weights at sacrifice (if multiple treatments are employed, body weights taken during the treatment regimen);
- signs of toxicity;
- mitotic index;
- ratio of spermatogonial mitoses cells to first and second meiotic metaphases, or other evidence of exposure to the target tissue;
- type and number of aberrations, given separately for each animal;
- total number of aberrations per group with means and standard deviations;

▼M8

- number of cells with aberrations per group with means and standard deviations;
- dose-response relationship, where possible;
- statistical analyses and methods applied;
- concurrent negative control data;
- historical negative control data with ranges, means, standard deviations, and 95 % confidence interval (where available), or published historical negative control data used for acceptability of the test results;
- concurrent positive control data;
- changes in ploidy, if seen, including frequencies of polyploidy and/or endoreduplicated cells.

*Discussion of the results**Conclusion***LITERATURE**

- (1) OECD (2016). Overview of the set of OECD Genetic Toxicology Test Guidelines and updates performed in 2014-2015. ENV Publications. Series on Testing and Assessment, No 234, OECD, Paris
- (2) Adler, I.-D. (1984). Cytogenetic Tests in Mammals. In: Mutagenicity Testing: a Practical Approach. Ed. S. Venitt and J. M. Parry. IRL Press, Oxford, Washington DC, pp. 275-306.
- (3) Adler I.-D., Shelby M. D., Bootman, J., Favor, J., Generoso, W., Pacchierotti, F., Shibuya, T. and Tanaka N. (1994). International Workshop on Standardisation of Genotoxicity Test Procedures. Summary Report of the Working Group on Mammalian Germ Cell Tests. *Mutation Res.*, 312, 313-318.
- (4) Russo, A. (2000). *In Vivo* Cytogenetics: Mammalian Germ Cells. *Mutation Res.*, 455, 167-189.
- (5) Hess, R.A. and de Franca L.R. (2008). Spermatogenesis and Cycle of the Seminiferous Epithelium. In: *Molecular Mechanisms in Spermatogenesis*, Cheng C.Y. (Ed.) Landes Bioscience and Springer Science+Business Media, pp. 1-15.
- (6) Adler, I.-D. (1974). Comparative Cytogenetic Study after Treatment of Mouse Spermatogonia with Mitomycin C, *Mutation. Res.*, 23(3): 368-379. Adler, I.D. (1986). Clastogenic Potential in Mouse Spermatogonia of Chemical Mutagens Related to their Cell-Cycle Specifications. In: *Genetic Toxicology of Environmental Chemicals, Part B: Genetic Effects and Applied Mutagenesis*, Ramel C., Lambert B. and Magnusson J. (Eds.) Liss, New York, pp. 477-484.
- (7) Cattanach, B.M., and Pollard C.E. (1971). Mutagenicity Tests with Cyclohexylamine in the Mouse, *Mutation Res.*, 12, 472-474.
- (8) Cattanach, B.M., and Williams, C.E. (1971). A search for Chromosome Aberrations Induced in Mouse Spermatogonia by Chemical Mutagens, *Mutation Res.*, 13, 371-375.
- (9) Rathenburg, R. (1975). Cytogenetic Effects of Cyclophosphamide on Mouse Spermatogonia, *Humangenetik* 29, 135-140.

▼ **M8**

- (10) Shiraishi, Y. (1978). Chromosome Aberrations Induced by Monomeric Acrylamide in Bone Marrow and Germ Cells of Mice, *Mutation Res.*, 57(3): 313–324.
- (11) Adler I-D., Bootman, J., Favor, J., Hook, G., Schriever-Schwemmer, G., Welzl, G., Whorton, E., Yoshimura, I. and Hayashi, M. (1998). Recommendations for Statistical Designs of *In Vivo* Mutagenicity Tests with Regard to Subsequent Statistical Analysis, *Mutation Res.*, 417, 19–30.
- (12) Fielder, R. J., Allen, J. A., Boobis, A. R., Botham, P. A., Doe, J., Esdaile, D. J., Gatehouse, D. G., Hodson-Walker, G., Morton, D. B., Kirkland, D. J. and Richold, M. (1992). Report of British Toxicology Society/UK Environmental Mutagen Society Working Group: Dose setting in *In Vivo* Mutagenicity Assays. *Mutagenesis*, 7, 313-319.
- (13) OECD (2000). Guidance Document on the Recognition, Assessment and Use of Clinical Signs as Humane Endpoints for Experimental Animals Used in Safety Evaluation, Series on Testing and Assessment, (No 19.), Organisation for Economic Cooperation and Development, Paris.
- (14) Yamamoto, K. and Kikuchi, Y. (1978). A New Method for Preparation of Mammalian Spermatogonial Chromosomes. *Mutation Res.*, 52, 207-209.
- (15) Hsu, T.C., Elder, F. and Pathak, S. (1979). Method for Improving the Yield of Spermatogonial and Meiotic Metaphases in Mammalian Testicular Preparations. *Environ. Mutagen.*, 1, 291-294.
- (16) Evans, E.P., Breckon, G., and Ford, C.E. (1964). An Air-Drying Method for Meiotic Preparations from Mammalian Testes. *Cytogenetics and Cell Genetics*, 3, 289-294.
- (17) Richold, M., Ashby, J., Bootman, J., Chandley, A., Gatehouse, D.G. and Henderson, L. (1990). *In Vivo* Cytogenetics Assays, In: D.J. Kirkland (Ed.) Basic Mutagenicity Tests, UKEMS Recommended Procedures. UKEMS Subcommittee on Guidelines for Mutagenicity Testing. Report. Part I revised. Cambridge University Press, Cambridge, New York, Port Chester, Melbourne, Sydney, pp. 115-141.
- (18) Lovell, D.P., Anderson, D., Albanese, R., Amphlett, G.E., Clare, G., Ferguson, R., Richold, M., Papworth, D.G. and Savage, J.R.K. (1989). Statistical Analysis of *In Vivo* Cytogenetic Assays In: D.J. Kirkland (Ed.) Statistical Evaluation of Mutagenicity Test Data. UKEMS Sub-Committee on Guidelines for Mutagenicity Testing, Report, Part III. Cambridge University Press, Cambridge, New York, Port Chester, Melbourne, Sydney, pp. 184-232.
- (19) Hayashi, M., Dearfield, K., Kasper, P., Lovell, D., Martus, H.-J. and Thybaud, V. (2011). Compilation and Use of Genetic Toxicity Historical Control Data. *Mutation Res.*, 723, 87-90.
- (20) Warr T.J., Parry E.M. and Parry J.M. (1993). A Comparison of Two *In Vitro* Mammalian Cell Cytogenetic Assays for the Detection of Mitotic Aneuploidy Using 10 Known or Suspected Aneugens, *Mutation Res.*, 287, 29-46.
- (21) Huang, Y., Change, C. and Trosko, J.E. (1983). Aphidicolin-Induced Endoreduplication in Chinese Hamster Cells. *Cancer Res.*, 43, 1362-1364.
- (22) Locke-Huhle, C. (1983). Endoreduplication in Chinese Hamster Cells during Alpha-Radiation Induced G2 Arrest. *Mutation Res.*, 119, 403-413.

▼ M8*Appendix*

DEFINITIONS

Aneuploidy: any deviation from the normal diploid (or haploid) number of chromosomes by a single chromosome or more than one, but not by entire set(s) of chromosomes (polyploidy).

Centromere: Region(s) of a chromosome with which spindle fibers are associated during cell division, allowing orderly movement of daughter chromosomes to the poles of the daughter cells.

Chemical: A substance or a mixture

Chromosome diversity: diversity of chromosome shapes (e.g. metacentric, acrocentric, etc) and sizes.

Chromatid-type aberration: structural chromosome damage expressed as breakage of single chromatids or breakage and reunion between chromatids.

Chromosome-type aberration: structural chromosome damage expressed as breakage, or breakage and reunion, of both chromatids at an identical site.

Clastogen: any chemical which causes structural chromosomal aberrations in populations of cells or organisms.

Gap: an achromatic lesion smaller than the width of one chromatid, and with minimum misalignment of the chromatids.

Genotoxic: a general term encompassing all types of DNA or chromosome damage, including breaks, deletions, adducts, nucleotides modifications and linkages, rearrangements, mutations, chromosome aberrations, and aneuploidy. Not all types of genotoxic effects result in mutations or stable chromosome damage.

Mitotic index (MI): the ratio of cells in metaphase divided by the total number of cells observed in a population of cells; an indication of the degree of proliferation of that population.

Mitosis: division of the cell nucleus usually divided into prophase, prometaphase, metaphase, anaphase, and telophase.

Mutagenic: produces a heritable change of DNA base-pair sequence(s) in genes or of the structure of chromosomes (chromosome aberrations).

Numerical abnormality: a change in the number of chromosomes from the normal number characteristic of the animals utilised.

Polyploidy: a multiple of the haploid chromosome number (n) other than the diploid number (i.e., $3n$, $4n$ and so on).

Structural aberration: a change in chromosome structure detectable by microscopic examination of the metaphase stage of cell division, observed as deletions and fragments, exchanges.

Test chemical: Any substance or mixture tested using this test method.

UVCB: Chemical Substances of Unknown or Variable Composition, Complex Reaction Products and Biological Materials

▼ M7

▼ B**B.25. MOUSE HERITABLE TRANSLOCATION****1. METHOD****1.1. INTRODUCTION**

See General introduction Part B.

1.2. DEFINITION

See General introduction Part B.

1.3. REFERENCE SUBSTANCES

None.

1.4. PRINCIPLE OF THE TEST METHOD

The mouse heritable translocation test detects structural and numerical chromosome changes in mammalian germ cells as recovered in first generation progeny. The types of chromosome changes detected are reciprocal translocations and, if female progeny are included, X-chromosome loss. Carriers of translocations and XO-females show reduced fertility which is used to select F₁ progeny for cytogenetic analysis. Complete sterility is caused by certain types of translocations (X-autosome and c-t type). Translocations are cytogenetically observed in meiotic cells at diakinesis- metaphase I of male individuals, either F₁ males or male offspring of F₁ females. The XO-females are cytogenetically identified by the presence of only 39 chromosomes in bone marrow mitoses.

1.5. QUALITY CRITERIA

None.

1.6. DESCRIPTION OF THE TEST METHOD*Preparations*

The test chemicals are dissolved in isotonic saline. If insoluble they are dissolved or suspended in appropriate vehicles. Freshly prepared solutions of the test compound are employed. If a vehicle is used to facilitate dosing, it must not interfere with the test compound or produce toxic effects.

Route of administration

Routes of administration are usually oral intubation or intraperitoneal injection. Other routes of administration may be appropriate.

Experimental animals

For the ease of breeding and cytological verification these experiments are performed with mice. No specific mouse strain is required. However, the average litter-size of the strain should be greater than eight and be relatively constant.

Healthy sexually mature animals are used.

▼B**Number of animals**

The number of animals necessary depends upon the spontaneous translocation frequency and the minimal rate of induction required for a positive result.

The test is usually performed by analyses of male F₁ progeny. At least 500 male F₁ progeny should be tested per dose group. If female F₁ progeny are included, 300 males and 300 females are required.

Use of negative and positive controls

Adequate control data, derived from concurrent and historic control should be available. When acceptable positive control results are available from experiments conducted recently in the same laboratory these results can be used instead of a concurrent positive control.

Dose levels

One dose level is tested, usually the highest dose associated with the production of minimal toxic effects, but without affecting reproductive behaviour or survival. To establish a dose/response relationship two additional lower doses are required. For non-toxic chemicals exposure to the maximum practicable dose should be used.

*Procedure***Treatment and mating**

Two treatment schedules are available. Single administration of the test substance is most widely used. Administration of the test substance on seven days per week for 35 days may also be used. The number of matings following treatment is governed by the treatment schedule and should ensure that all treated germ cell stages are sampled. At the end of the mating period females are caged individually. When females give birth, the date, litter size and sex of progeny are recorded. All male progeny are weaned and all female progeny are discarded unless they are included in the experiment.

Testing for translocation heterozygosity

One of two possible methods is used:

- fertility testing of F₁ progeny and subsequent verification of possible translocation carriers by cytogenetic analysis,
- cytogenetic analysis of all male F₁ progeny without prior selection by fertility testing.

(a) Fertility testing

Reduced fertility of an F₁ individual can be established by litter size observation and/or analysis of uterine contents of female mates.

Criteria for determining normal and reduced fertility must be established for the mouse strain used.

▼ B

Litter size observation: F₁ males to be tested are caged individually with females either from the same experiment or from the colony. Cages are inspected daily beginning 18 days after mating. Litter size and sex of the F₂ progeny are recorded at birth and litters are discarded thereafter. If female F₁ progeny are tested the F₂ progeny of small litters are kept for further testing. Female translocation carriers are verified by cytogenetic analysis of a translocation in any of their male offspring. XO-females are recognised by the change in sex ratio among their progeny from 1:1 to 1:2 males *versus* females. In a sequential procedure, normal F₁ animals are eliminated from further testing if the first F₂ litter reaches or exceeds a predetermined normal value, otherwise a second or third F₂ litter is observed.

F₁ animals that cannot be classified as normal after observation of up to three F₂ litters are either tested further by analysis of uterine contents of female mates or directly subjected to cytogenetic analysis.

Analysis of uterine contents: the reduction in litter size of translocation carriers is due to embryonic death so that a high number of dead implants is indicative of the presence of a translocation in the animal under test. F₁ males to be tested are mated to two to three females each. Conception is established by daily inspection for vaginal plugs in the morning. Females are sacrificed 14 to 16 days later and living and dead implants in their uteri are recorded.

(b) Cytogenetic analysis

Testes preparations are made by the air-drying technique. Translocation carriers are identified by the presence of multivalent configurations at diakinesis-metaphase I in primary spermatocytes. Observation of at least two cells with multivalent association constitutes the required evidence that the tested animal is a translocation carrier.

If no breeding selection has been performed all F₁ males are inspected cytogenetically. A minimum of 25 diakinesis-metaphase I cells per male must be scored microscopically. Examination of mitotic metaphases, in spermatogonia or bone-marrow, is required in F₁ males with small testes and meiotic breakdown before diakinesis or from F₁ female XO suspects. The presence of an unusually long and/or short chromosome in each of 10 cells is evidence for a particular male sterile translocation (c-t type). Some X-autosome translocations that cause male sterility may only be identified by banding analysis of mitotic chromosomes. The presence of 39 chromosomes in all of 10 mitoses is evidence for an XO condition in a female.

2. **DATA**

Data are presented in tabular form.

The mean litter size and sex ratio from parental matings at birth and weaning are reported for each mating interval.

▼ B

For fertility assessment of F₁ animals, the mean litter size of all normal matings and the individual litter sizes of F₁ translocation carriers are presented. For analysis of uterine contents, the mean number of living and dead implants of normal matings and the individual numbers of living and dead implants for each mating of F₁ translocation carriers are reported.

For cytogenetic analysis of diakinesis-metaphase I, the numbers of types of multivalent configurations and the total number of cells are listed for each translocation carrier.

For sterile F₁ individuals, the total number of matings and the duration of the mating period are reported. Testes weights and cytogenetic analysis details are given.

For XO females, the mean litter size, sex ratio of F₁ progeny and cytogenetic analysis results are reported.

Where possible F₁ translocation carriers are preselected by fertility tests, the tables have to include information on how many of these were confirmed translocation heterozygotes.

Data from negative controls and the positive control experiments are reported.

3. REPORTING**3.1. TEST REPORT**

The test report shall, if possible, contain the following information:

- strain of mice, age of animals, weights of treated animals,
- numbers of parental animals of each sex in experimental and control groups,
- test conditions, detailed description of treatment, dose levels, solvents, mating schedule,
- number and sex of offspring per female, number and sex of offspring raised for translocation analysis,
- time and criteria of translocation analysis,
- number and detailed description of translocation carriers, including breeding data and uterine content data, if applicable;
- cytogenetic procedures and details of microscopic analysis, preferably with pictures,
- statistical evaluation,
- discussion of results,
- interpretation of results.

▼B

- 3.2. EVALUATION AND INTERPRETATION
See General introduction Part B.
- 4. **REFERENCES**
See General introduction Part B.

▼ B**B.26. SUB-CHRONIC ORAL TOXICITY TEST REPEATED DOSE 90
– DAY ORAL TOXICITY STUDY IN RODENTS****1. METHOD**

This sub-chronic oral toxicity test method is a replicate of the OECD TG 408 (1998).

1.1. INTRODUCTION

In the assessment and evaluation of the toxic characteristics of a chemical, the determination of sub-chronic oral toxicity using repeated doses may be carried out after initial information on toxicity has been obtained from acute or repeated dose 28-day toxicity tests. The 90-day study provides information on the possible health hazards likely to arise from repeated exposure over a prolonged period of time covering post-weaning maturation and growth well into adulthood. The study will provide information on the major toxic effects, indicate target organs and the possibility of accumulation, and can provide an estimate of a no-observed-adverse-effect level of exposure which can be used in selecting dose levels for chronic studies and for establishing safety criteria for human exposure.

The method places additional emphasis on neurological endpoints and gives an indication of immunological and reproductive effects. The need for careful clinical observations of the animals, so as to obtain as much information as possible, is also stressed. This study should allow for the identification of chemicals with the potential to cause neurotoxic, immunological or reproductive organ effects, which may warrant further in-depth investigation.

See also General introduction Part B.

1.2. DEFINITIONS

Dose: is the amount of test substance administered. Dose is expressed as weight (g, mg) or as weight of test substance per unit weight of test animal (e.g. mg/kg), or as constant dietary concentrations (ppm).

Dosage: is a general term comprising of dose, its frequency and the duration of dosing.

NOAEL: is the abbreviation for no-observed-adverse-effect level and is the highest dose level where no adverse treatment-related findings are observed.

1.3. PRINCIPLE OF THE TEST METHOD

The test substance is orally administered daily in graduated doses to several groups of experimental animals, one dose level per group for a period of 90 days. During the period of administration the animals are observed closely for signs of toxicity. Animals, which die or are killed during the test are necropsied and, at the conclusion of the test, surviving animals are also killed and necropsied.

▼B

1.4. DESCRIPTION OF THE TEST METHOD

1.4.1. **Preparations of animals**

Healthy animals, which have been acclimated to laboratory conditions for at least five days and have not been subjected to previous experimental procedures, should be used. The test animals should be characterised as to species, strain, source, sex, weight and/or age. Animals should be randomly assigned to the control and treatment groups. Cages should be arranged in such a way that possible effects due to cage placement are minimised. Each animal should be assigned a unique identification number.

1.4.2. **Preparations of doses**

The test substance is administered by gavage or via the diet or drinking water. The method of oral administration is dependent on the purpose of the study, and the physical/chemical properties of the test material.

Where necessary, the test substance is dissolved or suspended in a suitable vehicle. It is recommended that, wherever possible, the use of an aqueous solution/suspension be considered first, followed by consideration of a solution/emulsion in oil (e.g. corn oil) and then by possible solution in other vehicles. For vehicles other than water the toxic characteristics of the vehicle must be known. The stability of the test substance under the conditions of administration should be determined.

1.4.3. **Test conditions**1.4.3.1. *Experimental animals*

The preferred species is the rat, although other rodent species, e.g. the mouse, may be used. Commonly used laboratory strains of young healthy adult animals should be employed. The females should be nulliparous and non-pregnant. Dosing should begin as soon as possible after weaning and, in any case, before the animals are nine weeks old. At the commencement of the study the weight variation of animals used should be minimal and not exceed $\pm 20\%$ of the mean weight of each sex. Where the study is conducted as a preliminary to a long term chronic toxicity study, animals from the same strain and source should be used in both studies.

1.4.3.2. *Number and sex*

At least 20 animals (10 female and 10 male) should be used at each dose level. If interim kills are planned, the number should be increased by the number of animals scheduled to be killed before the completion of the study. Based on previous knowledge of the chemical or a close analogue, consideration should be given to including an additional satellite group of ten animals (five per sex) in the control and in the top dose group for observation, after the treatment period, of reversibility or persistence of any toxic effects. The duration of this post-treatment period should be fixed appropriately with regard to the effects observed.

▼B1.4.3.3. *Dose levels*

At least three dose levels and a concurrent control shall be used, except where a limit test is conducted (see 1.4.3.4). Dose levels may be based on the results of repeated dose or range finding studies and should take into account any existing toxicological and toxicokinetic data available for the test substance or related materials. Unless limited by the physical-chemical nature or biological effects of the test substance, the highest dose level should be chosen with the aim to induce toxicity but not death or severe suffering. A descending sequence of dose levels should be selected with a view to demonstrating any dosage related response and a no-observed-adverse-effect level (NOAEL) at the lowest dose level. Two to four-fold intervals are frequently optimal for setting the descending dose levels and addition of a fourth test group is often preferable to using very large intervals (e.g. more than a factor of about 6-10) between dosages.

The control group shall be an untreated group or a vehicle-control group if a vehicle is used in administering the test substance. Except for treatment with the test substance, animals in the control group should be handled in an identical manner to those in the test groups. If a vehicle is used, the control group shall receive the vehicle in the highest volume used. If a test substance is administered in the diet, and causes reduced dietary intake, then a pair-fed control group may be useful in distinguishing between reductions due to palatability or toxicological alterations in the test model.

Consideration should be given to the following characteristics of the vehicle and other additives, as appropriate: effects on the absorption, distribution, metabolism, or retention of the test substance; effects on the chemical properties of the test substance which may alter its toxic characteristics; and effects on the food or water consumption or the nutritional status of the animals.

1.4.3.4. *Limit test*

If a test at one dose level, equivalent to at least 1 000 mg/kg body weight/day, using the procedures described for this study, produces no-observed-adverse-effects and if toxicity would not be expected based upon data from structurally related substances, then a full study using three dose levels may not be considered necessary. The limit test applies except when human exposure indicates the need for a higher dose level to be used.

1.5. PROCEDURE

1.5.1. **Administration of doses**

The animals are dosed with the test substance daily seven days each week for a period of 90 days. Any other dosing regime, e.g. five days per week, needs to be justified. When the test substance is administered by gavage, this should be done in a single dose to the animals using a stomach tube or a suitable intubation cannula. The maximum volume of liquid that can be administered at one time depends on the size of the test animal. The volume should not exceed 1 ml/100 g body weight, except in the case of aqueous solutions where 2 ml/100 g body weight may be used. Except for irritating or corrosive substances, which will normally reveal exacerbated effects with higher concentrations, variability in test volume should be minimised by adjusting the concentration to ensure a constant volume at all dose levels.

▼B

For substances administered via the diet or drinking water it is important to ensure that the quantities of the test substance involved do not interfere with normal nutrition or water balance. When the test substance is administered in the diet either a constant dietary concentration (ppm) or a constant dose level in terms of the animal's body weight may be used; the alternative used must be specified. For a substance administered by gavage, the dose should be given at similar times each day, and adjusted as necessary to maintain a constant dose level in terms of animal body weight. Where a 90-day study is used as a preliminary to a long term chronic toxicity study, a similar diet should be used in both studies.

1.5.2. Observations

The observation period should be at least 90 days. Animals in a satellite group scheduled for follow-up observations should be kept for an appropriate period without treatment to detect persistence of, or recovery from toxic effects.

General clinical observations should be made at least once a day, preferably at the same time(s) each day, taking into consideration the peak period of anticipated effects after dosing. The clinical condition of the animals should be recorded. At least twice daily, usually at the beginning and end of each day, all animals are inspected for signs of morbidity and mortality.

At least once prior to the first exposure (to allow for within-subject comparisons), and once a week thereafter, detailed clinical observations should be made in all animals. These observations should be made outside the home cage, preferably in a standard arena and at similar times on each occasion. They should be carefully recorded, preferably using scoring systems, explicitly defined by the testing laboratory. Effort should be made to ensure that variations in the observation conditions are minimal. Signs noted should include, but not be limited to, changes in skin, fur, eyes, mucous membranes, occurrence of secretions and excretions and autonomic activity (e.g. lacrimation, pilo-erection, pupil size, unusual respiratory pattern). Changes in gait, posture and response to handling as well as the presence of clonic or tonic movements, stereotypes (e.g. excessive grooming, repetitive circling) or bizarre behaviour (e.g. self-mutilation, walking backwards) should also be recorded (1).

Ophthalmological examination, using an ophthalmoscope or equivalent suitable equipment, should be made prior to the administration of the test substance and at the termination of the study, preferably in all animals but at least in the high dose and control groups. If changes in the eyes are detected all animals should be examined.

Towards the end of the exposure period and in any case not earlier than in week 11, sensory reactivity to stimuli of different types (1) (e.g. auditory, visual and proprioceptive stimuli) (2), (3), (4), assessment of grip strength (5) and motor activity assessment (6) should be conducted. Further details of the procedures that could be followed are given in the respective references. However, alternative procedures than those referenced could also be used.

Functional observations conducted towards the end of the study may be omitted when data on functional observations are available from other studies and the daily clinical observations did not reveal any functional deficits.

▼ B

Exceptionally, functional observations may also be omitted for groups that otherwise reveal signs of toxicity to an extent that would significantly interfere with the functional test performance.

1.5.2.1. *Body weight and food/water consumption*

All animals should be weighed at least once a week. Measurements of food consumption should be made at least weekly. If the test substance is administered via the drinking water, water consumption should also be measured at least weekly. Water consumption may also be considered for dietary or gavage studies during which drinking activity may be altered.

1.5.2.2. *Haematology and clinical biochemistry*

Blood samples should be taken from a named site and stored, if applicable, under appropriate conditions. At the end of the test period, samples are collected just prior to or as part of the procedure for killing the animals.

The following haematological examinations should be made at the end of the test period and when any interim blood samples may have been collected: haematocrit, haemoglobin concentration, erythrocyte count, total and differential leukocyte count, platelet count and a measure of blood clotting time/potential.

Clinical biochemistry determinations to investigate major toxic effects in tissues and, specifically, effects on kidney and liver, should be performed on blood samples obtained from each animal just prior to or as part of the procedure for killing the animals (apart from those found moribund and/or intercurrently killed). In a similar manner to haematological investigations, interim sampling for clinical biochemical tests may be performed. Overnight fasting of the animals prior to blood sampling is recommended⁽¹⁾. Determinations in plasma or serum should include sodium, potassium, glucose, total cholesterol, urea, blood urea nitrogen, creatinine, total protein and albumin, and more than two enzymes indicative of hepatocellular effects (such as alanine aminotransferase, aspartate aminotransferase, alkaline phosphatase, gamma glutamyl transpeptidase, and sorbitol dehydrogenase). Measurements of additional enzymes (of hepatic or other origin) and bile acids, which may provide useful information under certain circumstances, may also be included.

Optionally, the following urinalysis determinations could be performed during the last week of the study using timed urine collection: appearance, volume, osmolality or specific gravity, pH, protein, glucose and blood/blood cells.

In addition, studies to investigate serum markers of general tissue damage should be considered. Other determinations that should be carried out if the known properties of the test substance may, or are suspected to, affect related metabolic profiles include calcium, phosphorus, fasting triglycerides, specific hormones, methaemoglobin and cholinesterase. These need to be identified for chemicals in certain classes or on a case-by-case basis.

⁽¹⁾ For a number of measurements in serum and plasma, most notably for glucose, overnight fasting would be preferable. The major reason for this preference is that the increased variability which would inevitably result from non-fasting, would tend to mask more subtle effects and make interpretation difficult. On the other hand, however, overnight fasting may interfere with the general metabolism of the animals and, particularly in feeding studies, may disturb the daily exposure to the test substance. If overnight fasting is adopted, clinical biochemical determinations should be performed after the conduct of functional observations of the study.

▼ B

Overall, there is a need for a flexible approach, depending on the species and the observed and/or expected effect from a given substance.

If historical baseline data are inadequate, consideration should be given as to whether haematological and clinical biochemistry variables need to be determined before dosing commences; it is generally not recommended that this data be generated before treatment (7).

1.5.2.3. *Gross necropsy*

All animals in the study shall be subjected to a full, detailed gross necropsy which includes careful examination of the external surface of the body, all orifices, and the cranial, thoracic and abdominal cavities and their contents. The liver, kidneys, adrenals, testes, epididymides, uterus, ovaries, thymus, spleen, brain and heart of all animals (apart from those found moribund and/or intercurrently killed) should be trimmed of any adherent tissue, as appropriate, and their wet weight taken as soon as possible after dissection to avoid drying.

The following tissues should be preserved in the most appropriate fixation medium for both the type of tissue and the intended subsequent histopathological examination: all gross lesions, brain (representative regions including cerebrum, cerebellum and medulla/pons), spinal cord (at three levels: cervical, mid-thoracic and lumbar), pituitary, thyroid, parathyroid, thymus, oesophagus, salivary glands, stomach, small and large intestines (including Peyer's patches), liver, pancreas, kidneys, adrenals, spleen, heart, trachea and lungs (preserved by inflation with fixative and then immersion), aorta, gonads, uterus, accessory sex organs, female mammary gland, prostate, urinary bladder, gall bladder (mouse), lymph nodes (preferably one lymph node covering the route of administration and another one distant from the route of administration to cover systemic effects), peripheral nerve (sciatic or tibial) preferably in close proximity to the muscle, a section of bone marrow (and/or a fresh bone marrow aspirate), skin and eyes (if changes were observed during ophthalmological examinations). The clinical and other findings may suggest the need to examine additional tissues. Also any organs considered likely to be target organs based on the known properties of the test substance should be preserved.

1.5.2.4. *Histopathology*

Full histopathology should be carried out on the preserved organs and tissues of all animals in the control and high dose groups. These examinations should be extended to animals of all other dosage groups, if treatment-related changes are observed in the high dose group.

All gross lesions should be examined.

When a satellite group is used, histopathology should be performed on tissues and organs identified as showing effects in the treated groups.

▼ B**2. DATA AND REPORTING****2.1. DATA**

Individual data should be provided. Additionally, all data should be summarised in tabular form showing for each test group the number of animals at the start of the test, the number of animals found dead during the test or killed for humane reasons and the time of any death or humane kill, the number showing signs of toxicity, a description of the signs of toxicity observed, including time of onset, duration, and severity of any toxic effects, the number of animals showing lesions, the type of lesions and the percentage of animals displaying each type of lesion.

When applicable, numerical results should be evaluated by an appropriate and generally acceptable statistical method. The statistical methods and the data to be analysed should be selected during the design of the study.

2.2. TEST REPORT

The test report must include the following information:

2.2.1. Test substance:

- physical nature, purity and physico-chemical properties,
- identification data,
- vehicle (if appropriate): justification for choice of vehicle, if other than water.

2.2.2. Test species:

- species and strain used,
- number, age and sex of animals,
- source, housing conditions, diet etc.,
- individual weights of animals at the start of the test.

2.2.3. Test conditions:

- rationale for dose level selection,
- details of test substance formulation/diet preparation, achieved concentration, stability and homogeneity of the preparation,
- details of the administration of the test substance,
- actual doses (mg/kg body weight/day), and conversion factor from diet/drinking water test substance concentration (ppm) to the actual dose, if applicable,
- details of food and water quality.

2.2.4. Results:

- body weight and body weight changes,
- food consumption, and water consumption, if applicable,
- toxic response data by sex and dose level, including signs of toxicity,

▼B

- nature, severity and duration of clinical observations (whether reversible or not),
- results of ophthalmological examination,
- sensory activity, grip strength and motor activity assessments (when available),
- haematological tests with relevant base-line values,
- clinical biochemistry tests with relevant base-line values,
- terminal body weight, organ weights and organ/body weight ratios,
- necropsy findings,
- a detailed description of all histopathological findings,
- absorption data if available,
- statistical treatment of results, where appropriate,

Discussion of results.

Conclusions.

3. REFERENCES

- (1) IPCS (1986) Principles and Methods for the Assessment of Neurotoxicity Associated with Exposure to Chemicals. Environmental Health Criteria Document No 60.
- (2) Tupper, D.E., Wallace, R.B., (1980) Utility of the Neurologic Examination in Rats. *Acta Neurobiol. Exp.*, 40, p. 999-1003.
- (3) Gad, S.C., (1982) A Neuromuscular Screen for Use in Industrial Toxicology. *J.Toxicol. Environ. Health*, 9, p. 691-704.
- (4) Moser, V.C., Mc Daniel, K.M., Phillips, P.M., (1991) Rat Strain and Stock Comparisons Using a Functional Observational Battery: Baseline Values and Effects of Amitraz. *Toxicol. Appl. Pharmacol.*, 108, p. 267-283.
- (5) Meyer O.A., Tilson H.A., Byrd W.C., Riley M.T., (1979) A Method for the Routine Assessment of Fore- and Hind- limb grip Strength of Rats and Mice. *Neurobehav. Toxicol.*, 1, p. 233-236.
- (6) Crofton K.M., Howard J.L., Moser V.C., Gill M.W., Reiter L.W., Tilson H.A., MacPhail R.C., (1991) Interlaboratory Comparison of Motor Activity Experiments: Implication for Neurotoxicological Assessments. *Neurotoxicol. Teratol.*, 13, p. 599-609.
- (7) Weingand K., Brown G., Hall R. *et al.*, (1996) 'Harmonisation of Animal Clinic Pathology Testing in Toxicity and Safety Studies', *Fundam. & Appl. Toxicol.*, 29, p. 198-201.

▼B**B.27. SUB-CHRONIC ORAL TOXICITY TEST REPEATED DOSE 90-DAY ORAL TOXICITY STUDY IN NON-RODENTS****1. METHOD**

This sub-chronic oral toxicity test method is a replicate of the OECD TG 409 (1998).

1.1. INTRODUCTION

In the assessment and evaluation of the toxic characteristics of a chemical, the determination of sub-chronic oral toxicity using repeated doses may be carried out after initial information on toxicity has been obtained from acute or repeated dose 28-day toxicity tests. The 90-day study provides information on the possible health hazards likely to arise from repeated exposure over a period of rapid growth and into young adulthood. The study will provide information on the major toxic effects, indicate target organs and the possibility of accumulation, and can provide an estimate of a no-observed-adverse-effect level of exposure which can be used in selecting dose levels for chronic studies and for establishing safety criteria for human exposure.

The test method allows for the identification in non-rodent species of adverse effects of chemical exposure and should only be used:

- where effects observed in other studies indicate a need for clarification/characterisation in a second, non-rodent species, or
- where toxicokinetic studies indicate that the use of a specific non-rodent species is the most relevant choice of laboratory animal, or
- where other specific reasons justify the use of a non-rodent species.

See also General introduction Part B.

1.2. DEFINITIONS

Dose: is the amount of test substance administered. Dose is expressed as weight (g, mg) or as weight of test substance per unit weight of test animal (e.g. mg/kg), or as constant dietary concentrations (ppm).

Dosage: is a general term comprising of dose, its frequency and the duration of dosing.

NOAEL: is the abbreviation for no-observed-adverse-effect level and is the highest dose level where no adverse treatment-related findings are observed.

1.3. PRINCIPLE OF THE TEST METHOD

The test substance is orally administered daily in graduated doses to several groups of experimental animals, one dose level per group for a period of 90 days. During the period of administration the animals are observed closely for signs of toxicity. Animals, which die or are killed during the test are necropsied and at the conclusion of the test surviving animals are also killed and necropsied.

▼B

1.4. DESCRIPTION OF THE TEST METHOD

1.4.1. **Selection of animal species**

The commonly used non-rodent species is the dog, which should be of a defined breed; the beagle is frequently used. Other species, e.g. swine, mini-pigs, may also be used. Primates are not recommended and their use should be justified. Young, healthy animals should be employed, and in the case of the dog, dosing should begin preferably at four to six months and not later than nine months of age. Where the study is conducted as a preliminary to a long-term chronic toxicity study, the same species/breed should be used in both studies.

1.4.2. **Preparation of animals**

Healthy young animals, which have been acclimated to laboratory conditions and have not been subjected to previous experimental procedures, should be used. The duration of acclimatisation will depend upon the selected test species and their source. At least five days for dogs or purpose bred swine from a resident colony and at least two weeks for these animals if from external sources are recommended. The test animals should be characterised as to species, strain, source, sex, weight and/or age. Animals should be randomly assigned to the control and treatment groups. Cages should be arranged in such a way that possible effects due to cage placement are minimised. Each animal should be assigned a unique identification number.

1.4.3. **Preparations of doses**

The test substance may be administered in the diet or in the drinking water, by gavage or in capsules. The method of oral administration is dependent on the purpose of the study, and the physical-chemical properties of the test material.

Where necessary, the test substance is dissolved or suspended in a suitable vehicle. It is recommended that, wherever possible, the use of an aqueous solution/suspension be considered first, followed by consideration of a solution/emulsion in oil (e.g. corn oil) and then by possible solution in other vehicles. For vehicles other than water the toxic characteristics of the vehicle must be known. The stability of the test substance under the conditions of administration should be determined.

1.5. PROCEDURE

1.5.1. **Number and sex of animals**

At least eight animals (four female and four male) should be used at each dose level. If interim kills are planned, the number should be increased by the number of animals scheduled to be killed before the completion of the study. The number of animals at the termination of the study must be adequate for a meaningful evaluation of toxic effects. Based on previous knowledge of the substance or a close analogue, consideration should be given to including an additional satellite group of eight animals (four per sex) in control and in top dose group for observation after the treatment period of reversibility or persistence of any toxic effects. The duration of this post-treatment period should be fixed appropriately with regard to the effects observed.

▼ B**1.5.2. Dosage**

At least three dose levels and a concurrent control shall be used, except where a limit test is conducted (see 1.5.3). Dose levels may be based on the results of repeated dose or range finding studies and should take into account any existing toxicological and toxicokinetic data available for the test compound or related materials. Unless limited by the physical-chemical nature or biological effects of the test substance, the highest dose level should be chosen with the aim to induce toxicity but not death or severe suffering. A descending sequence of dose levels should be selected with a view to demonstrating any dosage related response and a no-observed-adverse-effect level (NOAEL) at the lowest dose level. Two to fourfold intervals are frequently optimal for setting the descending dose levels and addition of a fourth test group is often preferable to using very large intervals (e.g. more than a factor of about 6–10) between dosages.

The control group shall be an untreated group or a vehicle-control group if a vehicle is used in administering the test substance. Except for treatment with the test substance, animals in the control group should be handled in an identical manner to those in the test groups. If a vehicle is used, the control group shall receive the vehicle in the highest volume used. If a test substance is administered in the diet, and causes reduced dietary intake, then a pair-fed control group may be useful in distinguishing between reductions due to palatability or toxicological alterations in the test model.

Consideration should be given to the following characteristics of the vehicle and other additives, as appropriate: effects on the absorption, distribution, metabolism, or retention of the test substance; effects on the chemical properties of the test substance which may alter its toxic characteristics; and effects on the food or water consumption or the nutritional status of the animals.

1.5.3. Limit test

If a test at one dose level, equivalent to at least 1 000 mg/kg body weight/day, using the procedures described for this study, produces no-observed-adverse-effects and if toxicity would not be expected based upon data from structurally related substances, then a full study using three dose levels may not be considered necessary. The limit test applies except when human exposure indicates the need for a higher dose level to be used.

1.5.4. Administration of doses

The animals are dosed with the test substance daily seven days each week for a period of 90 days. Any other dosing regime, e.g. five days per week, needs to be justified. When the test substance is administered by gavage, this should be done in a single dose to the animals using a stomach tube or a suitable intubation cannula. The maximum volume of liquid that can be administered at one time depends on the size of the test animal. Normally the volume should be kept as low as possible. Except for irritating or corrosive substances which will normally reveal exacerbated effects with higher concentrations, variability in test volume should be minimised by adjusting the concentration to ensure a constant volume at all dose levels.

▼ B

For substances administered via the diet or drinking water it is important to ensure that the quantities of the test substance involved do not interfere with normal nutrition or water balance. When the test substance is administered in the diet either a constant dietary concentration (ppm) or a constant dose level in terms of the animal's body weight may be used; any alternative used must be specified. For a substance administered by gavage or by capsule, the dose should be given at similar times each day, and adjusted as necessary to maintain a constant dose level in terms of animal body weight. Where the 90 day study is used as a preliminary to a long term chronic toxicity study, a similar diet should be used in both studies.

1.5.5. Observations

The observation period should be at least 90 days. Animals in a satellite group scheduled for follow-up observations should be kept for an appropriate period without treatment to detect persistence of, or recovery from toxic effects.

General clinical observations should be made at least once a day, preferably at the same time(s) each day, taking into consideration the peak period of anticipated effects after dosing. The clinical condition of the animals should be recorded. At least twice daily, usually at the beginning and end of each day, all animals should be inspected for signs of morbidity and mortality.

At least once prior to the first exposure (to allow for within-subject comparisons), and once a week thereafter, detailed clinical observations should be made in all animals. These observations should be made, where practical outside the home cage in a standard arena and preferably at similar times on each occasion. Effort should be made to ensure that variations in the observation conditions are minimal. Signs of toxicity should be carefully recorded, including time of onset, degree and duration. Observations should include, but not be limited to, changes in skin, fur, eyes, mucous membranes, occurrence of secretions and excretions and autonomic activity (e.g. lacrimation, pilo-erection, pupil size, unusual respiratory pattern). Changes in gait, posture and response to handling as well as the presence of clonic or tonic movements, stereotypes (e.g. excessive grooming, repetitive circling) or any bizarre behaviour should also be recorded.

Ophthalmological examination, using an ophthalmoscope or equivalent suitable equipment, should be made prior to the administration of the test substance and at the termination of the study, preferably in all animals but at least in the high dose and control groups. If treatment related changes in the eyes are detected all animals should be examined.

1.5.5.1. *Body weight and food/water consumption*

All animals should be weighed at least once a week. Measurements of food consumption should be made at least weekly. If the test substance is administered via the drinking water, water consumption should also be measured at least weekly. Water consumption may also be considered for dietary or gavage studies during which drinking activity may be altered.

▼ B1.5.5.2. *Haematology and clinical biochemistry*

Blood samples should be taken from a named site and stored, if applicable, under appropriate conditions. At the end of the test period, samples are collected just prior to or as part of the procedure for killing the animals.

Haematology, including haematocrit, haemoglobin concentration, erythrocyte count, total and differential leukocyte count, platelet count and a measure of clotting potential such as clotting time, prothrombin time, or thromboplastin time should be investigated at the start of the study, then either at monthly intervals or midway through the test period and finally at the end of the test period.

Clinical biochemistry determinations to investigate major toxic effects in tissues and, specifically, effects on kidney and liver, should be performed on blood samples obtained from all animals at the start, then either at monthly intervals or midway through the test and finally at the end of the test period. Test areas, which should be considered are electrolyte balance, carbohydrate metabolism, and liver and kidney function. The selection of specific tests will be influenced by observations on the mode of action of the test substance. Animals should be fasted for a period appropriate to the species prior to blood sampling. Suggested determinations include calcium, phosphorus, chloride, sodium, potassium, fasting glucose, alanine aminotransferase, aspartate aminotransferase, ornithine decarboxylase, gamma glutamyl transpeptidase, urea nitrogen, albumin, blood creatinine, total bilirubin and total serum protein measurements.

Urinalysis determinations should be performed at least at the start, then midway and finally at the end of the study using timed urine volume collection. Urinalysis determinations include appearance, volume, osmolality or specific gravity, pH, protein, glucose and blood/blood cells. Additional parameters may be employed where necessary to extend the investigation of observed effect(s).

In addition, studies to investigate markers of general tissue damage should be considered. Other determinations, which may be necessary for an adequate toxicological evaluation include analyses of lipids, hormones, acid/base balance, methaemoglobin, and cholinesterase inhibition. Additional clinical biochemistry may be employed where necessary to extend the investigation of observed effects. These need to be identified for chemicals in certain classes or on a case-by-case basis.

Overall, there is a need for a flexible approach, depending on the species and the observed and/or expected effect from a given substance.

1.5.5.3. *Gross necropsy*

All animals in the study shall be subjected to a full, detailed gross necropsy which includes careful examination of the external surface of the body, all orifices, and the cranial, thoracic and abdominal cavities and their contents. The liver with gall bladder, kidneys, adrenals, testes, epididymides, ovaries, uterus, thyroid (with parathyroids), thymus, spleen, brain and heart of all animals (apart from those found moribund and/or inter-currently killed) should be trimmed of any adherent tissue, as appropriate, and their wet weight taken as soon as possible after dissection to avoid drying.

▼ B

The following tissues should be preserved in the most appropriate fixation medium for both the type of tissue and the intended subsequent histopathological examination: all gross lesions, brain (representative regions including cerebrum, cerebellum and medulla/pons), spinal cord (at three levels: cervical, mid-thoracic and lumbar), pituitary, eyes, thyroid, parathyroid, thymus, oesophagus, salivary glands, stomach, small and large intestines (including Peyer's patches), liver, gall bladder, pancreas, kidneys, adrenals, spleen, heart, trachea and lungs, aorta, gonads, uterus, accessory sex organs, female mammary gland, prostate, urinary bladder, lymph nodes (preferably one lymph node covering the route of administration and another one distant from the route of administration to cover systemic effects), peripheral nerve (sciatic or tibial) preferably in close proximity to the muscle, a section of bone marrow (and/or a fresh bone marrow aspirate) and skin. The clinical and other findings may suggest the need to examine additional tissues. Also any organs considered likely to be target organs based on the known properties of the test substance should be preserved.

1.5.5.4. Histopathology

Full histopathology should be carried out on the preserved organs and tissues in at least all animals in control and high dose group. The examination should be extended to animals of all other dosage groups, if treatment-related changes are observed in the high dose group.

All gross lesions should be examined.

When a satellite group is used, histopathology should be performed on tissues and organs identified as showing effects in the treated groups.

2. DATA AND REPORTING**2.1. DATA**

Individual data should be provided. Additionally, all data should be summarised in tabular form showing for each test group the number of animals at the start of the test, the number of animals found dead during the test or killed for humane reasons and the time of any death or humane kill, the number showing signs of toxicity, a description of the signs of toxicity observed, including time of onset, duration, and severity of any toxic effects, the number of animals showing lesions, the type of lesions and the percentage of animals displaying each type of lesion.

When applicable, numerical results should be evaluated by an appropriate and generally acceptable statistical method. The statistical methods and the data to be analysed should be selected during the design of the study.

2.2. TEST REPORT

The test report must include the following information:

▼ B

- 2.2.1. **Test substance:**
- physical nature, purity and physico-chemical properties,
 - identification data,
 - vehicle (if appropriate): justification for choice of vehicle, if other than water.
- 2.2.2. **Test species:**
- species and strain used,
 - number, age and sex of animals,
 - source, housing conditions, diet etc.,
 - individual weights of animals at the start of the test.
- 2.2.3. **Test conditions:**
- rationale for dose level selection,
 - details of test substance formulation/diet preparation, achieved concentration, stability and homogeneity of the preparation,
 - details of the administration of the test substance,
 - actual doses (mg/kg body weight/day), and conversion factor from diet/drinking water test substance concentration (ppm) to the actual dose, if applicable,
 - details of food and water quality.
- 2.2.4. **Results:**
- body weight/body weight changes,
 - food consumption, and water consumption, if applicable,
 - toxic response data by sex and dose level, including signs of toxicity,
 - nature, severity and duration of clinical observations (whether reversible or not),
 - ophthalmological examination,
 - haematological tests with relevant base-line values,
 - clinical biochemistry tests with relevant base-line values,
 - terminal body weight, organ weights and organ/body weight ratios,
 - necropsy findings,
 - a detailed description of all histopathological findings,
 - absorption data if available,
 - statistical treatment of results, where appropriate.
- Discussion of results.
- Conclusions.

▼B**B.28. SUB-CHRONIC DERMAL TOXICITY STUDY 90-DAY REPEATED DERMAL DOSE STUDY USING RODENT SPECIES****1. METHOD****1.1. INTRODUCTION**

See General introduction Part B.

1.2. DEFINITIONS

See General introduction Part B.

1.3. REFERENCE SUBSTANCES

None.

1.4. PRINCIPLE OF THE TEST METHOD

The test substance is applied daily to the skin in graduated doses to several groups of experimental animals, one dose per group for a period of 90 days. During the period of application the animals are observed daily to detect signs of toxicity. Animals, which die during the test are necropsied, and at the conclusion of the test surviving animals are necropsied.

1.5. QUALITY CRITERIA

None.

1.6. DESCRIPTION OF THE TEST METHOD**1.6.1. Preparations**

The animals are kept under the experimental housing and feeding conditions for at least five days prior to the test. Before the test healthy young animals are randomised and assigned to the treated and control groups. Shortly before testing fur is clipped from the dorsal area of the trunk of the test animals. Shaving may be employed but it should be carried out approximately 24 hours before the test. Repeat clipping or shaving is usually needed at approximately weekly intervals. When clipping or shaving the fur, care must be taken to avoid abrading the skin. Not less than 10 % of the body surface area should be clear for the application of the test substance. The weight of the animal should be taken into account when deciding on the area to be cleared and on the dimensions of the covering. When testing solids, which may be pulverised if appropriate, the test substance should be moistened sufficiently with water or, where necessary, a suitable vehicle to ensure good contact with the skin. Liquid test substances are generally used undiluted. Daily application on a five to seven-day per week basis is used.

1.6.2. Test conditions**1.6.2.1. Experimental animals**

The adult rat, rabbit or guinea pig may be used. Other species may be used but their use would require justification. At the commencement of the test the range of the weight variation should be $\pm 20\%$ of the mean weight. Where a sub-chronic dermal study is conducted as a preliminary to a long-term study, the same species and strain should be used in both studies.

▼B

1.6.2.2. Number and sex

At least 20 animals (10 female and 10 male) with healthy skin should be used at each dose level. The females should be nulliparous and non-pregnant. If interim sacrifices are planned the number should be increased by the number of animals scheduled to be sacrificed before the completion of the study. In addition, a satellite group of 20 animals (10 animals per sex) may be treated with the high-dose level for 90 days and observed for reversibility, persistence, or delayed occurrence of toxic effects for 28 days post-treatment.

1.6.2.3. Dose levels

At least three dose levels are required with a control or a vehicle control if a vehicle is used. The exposure period should be at least six hours per day. The application of the test substance should be made at similar times each day, and the amount of substance applied adjusted at intervals (weekly or bi-weekly) to maintain a constant dose level in terms of animal body weight. Except for treatment with the test substance, animals in the control group should be handled in an identical manner to the test group subjects. Where a vehicle is used to facilitate dosing, the vehicle control group should be dosed in the same way as the treated groups, and receive the same amount as that received by the highest dose level group. The highest dose level should result in toxic effects but produce no, or few, fatalities. The lowest dose level should not produce any evidence of toxicity. Where there is a usable estimation of human exposure the lowest level should exceed this. Ideally, the intermediate dose level should produce minimal observable toxic effects. If more than one intermediate dose is used, the dose levels should be spaced to produce a gradation of toxic effects. In the low and intermediate groups, and in the controls, the incidence of fatalities should be low, in order to permit a meaningful evaluation of the results.

If application of the test substance produces severe skin irritation the concentrations should be reduced and this may result in a reduction in, or absence of, other toxic effects at the high-dose level. If the skin has been badly damaged it may be necessary to terminate the study and undertake a new study at lower concentrations.

1.6.3. Limit test

If a preliminary study at a dose level of 1 000 mg/kilograms, or a higher dose level related to possible human exposure where this is known, produces no toxic effects, further testing may not be considered necessary.

1.6.4. Observation period

The experimental animals should be observed daily for signs of toxicity. The time of death and the time at which signs of toxicity appear and disappear should be recorded.

▼B

1.6.5. Procedure

Animals should be caged individually. The animals are treated with the test substance, ideally on seven days per week, for a period of 90 days.

Animals in any satellite groups scheduled for follow-up observations should be kept for a further 28 days without treatment to detect recovery from, or persistence of, toxic effects. Exposure time should be six hours per day.

The test substance should be applied uniformly over an area, which is approximately 10 % of the total body surface area. With highly toxic substances, the surface area covered may be less but as much of the area should be covered with as thin and uniform a film as possible.

During exposure the test substance is held in contact with the skin with a porous gauze dressing and non-irritating tape. The test site should be further covered in a suitable manner to retain the gauze dressing and test substance and ensure that the animals cannot ingest the test substance. Restrainers may be used to prevent the ingestion of the test substance but complete immobilisation is not a recommended method.

At the end of the exposure period, residual test substance should be removed where practicable using water or some other appropriate method of cleansing the skin.

All the animals should be observed daily and signs of toxicity recorded, including the time of onset, their degree and duration. Cageside observations should include changes in skin and fur, eyes and mucous membranes, as well as respiratory, circulatory, autonomic and central nervous systems, somatomotor activity and behavior pattern. Measurements should be made of food consumption weekly and the animals weighed weekly. Regular observations of the animals are necessary to ensure that animals are not lost from the study due to causes such as cannibalism, autolysis of tissues or misplacement. At the end of the study period all survivors in the non-satellite treatment groups are necropsied. Moribund animals should be removed and necropsied when noticed.

The following examinations are customarily made on all animals including the controls:

- (a) ophthalmological examination, using an ophthalmoscope or equivalent suitable equipment, should be made prior to exposure to the test substance and at the termination of the study, preferably in all animals but at least in the high-dose and control groups. If changes in the eyes are detected all animals should be examined.
- (b) haematology, including haematocrit, haemoglobin concentration, erythrocyte count, total and differential leucocyte count, and a measure of clotting potential, such as clotting time, prothrombin time, thromboplastin time, or platelet count, should be investigated at the end of the test period.

▼B

- (c) clinical biochemistry determination on blood should be carried out at the end of the test period. Test areas, which are considered appropriate to all studies are electrolyte balance, carbohydrate metabolism, liver and kidney function. The selection of specific tests will be influenced by observations on the mode of action of the substance. Suggested determinations are calcium, phosphorus, chloride, sodium, potassium, fasting glucose (with period of fasting appropriate to the species), serum glutamic pyruvic transaminase ⁽¹⁾, serum glutamic oxaloacetic transaminase ⁽²⁾, ornithine decarboxylase, gamma glutamyl transpeptidase, urea nitrogen, albumin, blood creatinine, total bilirubin and total serum protein measurements. Other determinations which may be necessary for an adequate toxicological evaluation include analyses of lipids, hormones, acid/base balance, methaemoglobin and cholinesterase activity. Additional clinical biochemistry may be employed, where necessary, to extend the investigation of observed effects.
- (d) urinalysis is not required on a routine basis but only when there is an indication based on expected or observed toxicity.

If historical baseline data are inadequate, consideration should be given to determination of haem a to logical and clinical biochemistry parameters before dosing commences.

Gross necropsy

All animals should be subjected to a full gross necropsy which includes examination of the external surface of the body, all orifices, and the cranial, thoracic and abdominal cavities and their contents. The liver, kidneys, adrenals and testes must be weighed wet as soon as possible after dissection to avoid drying. The following organs and tissues should be preserved in a suitable medium for possible future histopathological examination: all gross lesions, brain — including sections of medulla/pons, cerebellar cortex and cerebral cortex, pituitary, thyroid/parathyroid, any thymic tissue, (trachea), lungs, heart, aorta, salivary glands, liver, spleen, kidneys, adrenals, pancreas, gonads, uterus, accessory genital organs, gall bladder (if present), oesophagus, stomach, duodenum, jejunum, ileum, caecum, colon, rectum, urinary bladder, representative lymph node, (female mammary gland), (thigh musculature), peripheral nerve, (eyes), (sternum with bone marrow), (femur — including articular surface), (spinal cord at three levels — cervical, mid-thoracic and lumbar), and (exorbital lachrymal glands). The tissues mentioned between brackets need only be examined if indicated by signs of toxicity or target organ involvement.

Histopathological examination

- (a) Full histopathology should be carried out on normal and treated skin and on organs and tissues of animals in the control and high-dose groups.
- (b) all gross lesions should be examined.

⁽¹⁾ Now known as serum alanine aminotransferase.

⁽²⁾ Now known as serum aspartate aminotransferase.

▼B

- (c) target organs in other dose groups should be examined.
- (d) where rats are used, lungs of animals in the low- and intermediate-dose groups should be subjected to histopathological examination for evidence of infection, since this provides a convenient assessment of the state of health of the animals. Further histopathological examination may not be required routinely on the animals in these groups, but must always be carried out in organs, which show evidence of lesions in the high-dose group.
- (e) when a satellite group is used, histopathology should be performed on tissues and organs identified as showing effects in the other treated groups.

2. DATA

Data should be summarised in tabular form, showing for each test group the number of animals at the start of the test, the number of animals showing lesions, the type of lesions and the percentage of animals displaying each type of lesion. Results should be evaluated by an appropriate statistical method. Any recognised statistical method may be used.

3. REPORTING**3.1. TEST REPORT**

The test report shall, if possible, contain the following information:

- species, strain, source, environmental conditions, diet,
- test conditions,
- dose levels (including vehicle, if used) and concentrations,
- toxic response data by sex and dose,
- no-effect level, where possible,
- time of death during the study or whether animals survived to termination,
- description of toxic or other effects,
- the time of observation of each abnormal sign and its subsequent course,
- food and bodyweight data,
- ophthalmological findings,
- haematological tests employed and all results,
- clinical biochemistry tests employed and all results (including results of any urinalysis),
- necropsy findings,

▼B

- a detailed description of all histopathological findings,
- statistical treatment of results where possible,
- discussion of the results,
- interpretation of the results.

3.2. **EVALUATION AND INTERPRETATION**

See General introduction Part B.

4. **REFERENCES**

See General introduction Part B.

▼M4**B.29. SUBCHRONIC INHALATION TOXICITY: 90-DAY STUDY****SUMMARY**

This revised Test Method B.29 has been designed to fully characterise test chemical toxicity by the inhalation route for a subchronic duration (90 days), and to provide robust data for quantitative inhalation risk assessments. Groups of 10 male and 10 female rodents are exposed 6 hours per day during a 90 day (13 week) period to a) the test chemical at three or more concentration levels, b) filtered air (negative control), and/or c) the vehicle (vehicle control). Animals are generally exposed 5 days per week but exposure for 7 days per week is also allowed. Males and females are always tested, but they may be exposed at different concentration levels if it is known that one sex is more susceptible to a given test chemical. This method allows the study director the flexibility to include satellite (reversibility) groups, interim sacrifices, bronchoalveolar lavage (BAL), neurologic tests, and additional clinical pathology and histopathological evaluations in order to better characterise the toxicity of a test chemical.

INTRODUCTION

1. This Test Method is equivalent to OECD Test Guideline 413 (2009). The original subchronic inhalation Test Guideline 413 (TG 413) was adopted in 1981 (1). This Test Method B.29 (as equivalent to the revised TG 413 (2009)) has been updated to reflect the state of the science and to meet current and future regulatory needs.
2. Subchronic inhalation toxicity studies are primarily used to derive regulatory concentrations for assessing worker risk in occupation settings. They are also used to assess human residential, transportation, and environmental risk. This method enables the characterisation of adverse effects following repeated daily inhalation exposure to a test chemical for 90 days (approximately 10 % of the lifespan of a rat). The data derived from subchronic inhalation toxicity studies can be used for quantitative risk assessments and for the selection of concentrations for chronic studies. This test method is not specifically intended for the testing of nanomaterials. Definitions used in the context of this Test Method are provided at the end of this chapter and in the Guidance Document (GD) 39 (2).

INITIAL CONSIDERATIONS

3. All available information on the test chemical should be considered by the testing laboratory prior to conducting the study in order to enhance the quality of the study and minimise animal usage. Information that will assist in the selection of appropriate test concentrations might include the identity, chemical structure, and physico-chemical properties of the test chemical; results of any *in vitro* or *in vivo* toxicity tests; anticipated use(s) and potential for human exposure; available (Q)SAR data and toxicological data on structurally related chemicals; and data derived from other repeated exposure studies. If neurotoxicity is expected or is observed in the course of the study, the study director may choose to include appropriate evaluations such as a functional observational battery (FOB) and measurement of motor activity. Although the timing of exposures relative to specific examinations may be critical, the performance of these additional activities should not interfere with the basic study design.

▼M4

4. Dilutions of corrosive or irritating test chemicals may be tested at concentrations that will yield the desired degree of toxicity. Please refer to GD 39 (2) for further information. When exposing animals to these materials, the targeted concentrations should be low enough to not cause marked pain and distress, yet sufficient to extend the concentration-response curve to levels that reach the regulatory and scientific objective of the test. These concentrations should be selected on a case-by-case basis, preferably based upon an adequately designed range-finding study that provides information regarding the critical endpoint, any irritation threshold, and the time of onset (see paragraphs 11-13). The justification for concentration selection should be provided.

5. Moribund animals or animals obviously in pain or showing signs of severe and enduring distress should be humanely killed. Moribund animals are considered in the same way as animals that die on test. Criteria for making the decision to kill moribund or severely suffering animals, and guidance on the recognition of predictable or impending death, are the subject of an OECD Guidance Document on Humane Endpoints (3).

DESCRIPTION OF THE METHOD**Selection of Animal Species**

6. Healthy young adult rodents of commonly used laboratory strains should be employed. The preferred species is the rat. Justification should be provided if other species are used.

Preparation of Animals

7. Females should be nulliparous and non-pregnant. On the day of randomisation, animals should be young adults 7 to 9 weeks of age. Body weights should be within $\pm 20\%$ of the mean weight for each sex. The animals are randomly selected, marked for individual identification, and kept in their cages for at least 5 days prior to the start of the test to allow for acclimatization to laboratory conditions.

Animal Husbandry

8. Animals should be individually identified, preferably with subcutaneous transponders, to facilitate observations and avoid confusion. The temperature of the experimental animal maintenance room should be 22 ± 3 °C. The relative humidity should ideally be maintained in the range of 30 to 70 %, though this may not be possible when using water as a vehicle. Before and after exposures, animals generally should be caged in groups by sex and concentration, but the number of animals per cage should not interfere with clear observation of each animal and should minimise losses due to cannibalism and fighting. When animals are to be exposed nose-only, it may be necessary for them to be acclimated to the restraining tubes. The restraining tubes should not impose undue physical, thermal, or immobilisation stress on the animals. Restraint may affect physiological endpoints such as body temperature (hyperthermia) and/or respiratory minute volume. If generic data are available to show that no such changes occur to any appreciable extent, then pre-adaptation to the restraining tubes is not necessary. Animals exposed whole-body to an aerosol should be housed individually during exposure to prevent them from filtering the test aerosol through the fur of their cage mates. Conventional and certified laboratory diets may be used, except during exposure, accompanied with an unlimited supply of municipal drinking water. Lighting should be artificial, the sequence being 12 hours light/12 hours dark.

▼ M4**Inhalation Chambers**

9. The nature of the test chemical and the object of the test should be considered when selecting an inhalation chamber. The preferred mode of exposure is nose-only (which term includes head-only, nose-only, or snout-only). Nose-only exposure is generally preferred for studies of liquid or solid aerosols and for vapours that may condense to form aerosols. Special objectives of the study may be better achieved by using a whole-body mode of exposure, but this should be justified in the study report. To ensure atmosphere stability when using a whole-body chamber, the total volume of the test animals should not exceed 5 % of the chamber volume. Principles of the nose-only and whole body exposure techniques and their particular advantages and disadvantages are addressed in GD 39 (2).

TOXICITY STUDIES**Limit Concentrations**

10. Unlike with acute studies, there are no defined limit concentrations in subchronic inhalation toxicity studies. The maximum concentration tested should consider: 1) the maximum attainable concentration, 2) the 'worst case' human exposure level, 3) the need to maintain an adequate oxygen supply, and/or 4) animal welfare considerations. In the absence of data-based limits, the acute limits of Regulation (EC) No 1272/2008 (13) may be used (i.e. up to a maximum concentration of 5 mg/l for aerosols, 20 mg/l for vapours, and 20 000 ppm for gases); refer to GD 39 (2). Justification should be provided if it is necessary to exceed these limits when testing gases or highly volatile test chemicals (e.g. refrigerants). The limit concentration should elicit unequivocal toxicity without causing undue stress to the animals or affecting their longevity (3).

Range-Finding Study

11. Before commencing with the main study, it is generally necessary to perform a range-finding study. A range-finding study is more comprehensive than a sighting study because it is not limited to concentration selection. Knowledge learned from a range-finding study can lead to a successful main study. A range-finding study may, for example, provide technical information regarding analytical methods, particle sizing, discovery of toxic mechanisms, clinical pathology and histopathological data, and estimations of what may be NOAEL and MTC concentrations in a main study. The study director may choose to use the range-finding study to identify the threshold of respiratory tract irritation (e.g. with histopathology of the respiratory tract, pulmonary function testing, or bronchoalveolar lavage), the upper concentration which is tolerated without undue stress to the animals, and the parameters that will best characterise a test chemical's toxicity.
12. A range-finding study may consist of one or more concentration levels. Depending on the endpoints chosen, three to six males and three to six females should be exposed at each concentration level. A range-finding study should last a minimum of 5 days and generally no more than 28 days. The rationale for the selection of concentrations for the main study should be provided in the study report. The objective of the main study is to demonstrate a concentration-response relationship based on what is anticipated to be the most sensitive endpoint. The low concentration should ideally be a no-observed-adverse effect concentration while the high concentration should elicit unequivocal toxicity without causing undue stress to the animals or affecting their longevity (3).

▼ M4

13. When selecting concentration levels for the range-finding study, all available information should be considered including structure-activity relationships and data for similar chemicals (see paragraph 3). A range-finding study may verify/refute what are considered to be the most sensitive mechanistically based endpoints, e.g. cholinesterase inhibition by organophosphates, methaemoglobin formation by erythrocytotoxic agents, thyroidal hormones (T₃, T₄) for thyrotoxicants, protein, LDH, or neutrophils in bronchoalveolar lavage for innocuous poorly soluble particles or pulmonary irritant aerosols.

Main Study

14. The main subchronic toxicity study generally consists of three concentration levels, and also concurrent negative (air) and/or vehicle controls as needed (see paragraph 18). All available data should be utilised to aid selection of appropriate exposure levels, including the results of systemic toxicity studies, metabolism and kinetics (particular emphasis should be given to avoiding high concentration levels which saturate kinetic processes). Each test group contains 10 male and 10 female rodents that are exposed to the test chemical for 6 hours per day on a 5 day per week basis for a period of 13 weeks (total study duration of at least 90 days). Animals may also be exposed 7 days per week (e.g. when testing inhaled pharmaceuticals). If one sex is known to be more susceptible to a given test chemical, the sexes may be exposed at different concentration levels in order to optimise the concentration-response as described in paragraph 15. If rodent species other than rats are exposed nose-only, maximum exposure durations may be adjusted to minimise species-specific distress. A rationale should be provided when using an exposure duration less than 6 hours/day, or when it is necessary to conduct a long duration (e.g. 22 hours/day) whole-body exposure study (refer to GD 39) (2). Feed should be withheld during the exposure period unless exposure exceeds 6 hours. Water may be provided throughout a whole-body exposure.
15. The target concentrations selected should identify the target organ(s) and demonstrate a clear concentration-response:
 - The high concentration level should result in toxic effects but not cause lingering signs or lethality which would prevent a meaningful evaluation.
 - The intermediate concentration level(s) should be spaced to produce a gradation of toxic effects between that of the low and high concentration.
 - The low concentration level should produce little or no evidence of toxicity.

Interim Sacrifices

16. If interim sacrifices are planned, the number of animals at each exposure level should be increased by the number to be sacrificed before study completion. The rationale for using interim sacrifices should be provided, and statistical analyses should properly account for them.

▼ M4**Satellite (Reversibility) Study**

17. A satellite (reversibility) study may be used to observe reversibility, persistence, or delayed occurrence of toxicity for a post-treatment period of an appropriate length, but no less than 14 days. Satellite (reversibility) groups consist of 10 males and 10 females exposed contemporaneously with the experimental animals in the main study. Satellite (reversibility) study groups should be exposed to the test chemical at the highest concentration level and there should be concurrent air and/or vehicle controls as needed (see paragraph 18).

Control Animals

18. Concurrent negative (air) control animals should be handled in a manner identical to the test group animals except that they are exposed to filtered air rather than test chemical. When water or another substance is used to assist in generating the test atmosphere, a vehicle control group, instead of a negative (air) control group, should be included in the study. Water should be used as the vehicle whenever possible. When water is used as the vehicle, the control animals should be exposed to air with the same relative humidity as the exposed groups. The selection of a suitable vehicle should be based on an appropriately conducted pre-study or historical data. If a vehicle's toxicity is not well known, the study director may choose to use both a negative (air) control and a vehicle control, but this is strongly discouraged. If historical data reveal that a vehicle is non-toxic, then there is no need for a negative (air) control group and only a vehicle control should be used. If a pre-study of a test chemical formulated in a vehicle reveals no toxicity, it follows that the vehicle is non-toxic at the concentration tested and this vehicle control should be used.

EXPOSURE CONDITIONS**Administration of Concentrations**

19. Animals are exposed to the test chemical as a gas, vapour, aerosol, or a mixture thereof. The physical state to be tested depends on the physico-chemical properties of the test chemical, the selected concentrations, and/or the physical form most likely present during the handling and use of the test chemical. Hygroscopic and chemically reactive test chemicals should be tested under dry air conditions. Care should be taken to avoid generating explosive concentrations. Particulate materials may be subjected to mechanical processes to decrease the particle size. Further guidance is provided in GD 39 (2).

Particle-Size Distribution

20. Particle sizing should be performed for all aerosols and for vapours that may condense to form aerosols. To allow for exposure of all relevant regions of the respiratory tract, aerosols with mass median aerodynamic diameters (MMAD) ranging from 1 to 3 μm with a geometric standard deviation (σ_g) in the range of 1,5 to 3,0 are recommended (4). Although a reasonable effort should be made to meet this standard, expert judgement should be provided if it cannot be achieved. For example, metal fume particles will be smaller than this standard, and charged particles and fibres may exceed it.

▼ M4**Test chemical Preparation in a Vehicle**

21. Ideally, the test chemical should be tested without a vehicle. If it is necessary to use a vehicle to generate an appropriate test chemical concentration and particle size, water should be given preference. Whenever a test chemical is dissolved in a vehicle, its stability should be demonstrated.

MONITORING OF EXPOSURE CONDITIONS**Chamber Airflow**

22. The flow of air through the exposure chamber should be carefully controlled, continuously monitored, and recorded at least hourly during each exposure. The real-time monitoring of the test atmosphere concentration (or temporal stability) is an integral measurement of all dynamic parameters and provides an indirect means to control all relevant dynamic inhalation parameters. If the concentration is monitored real-time, the frequency of measurement of air flows may be reduced to one single measurement per exposure per day. Special consideration should be given to avoiding rebreathing in nose-only chambers. Oxygen concentration should be at least 19 % and carbon dioxide concentration should not exceed 1 %. If there is reason to believe that this standard cannot be met, oxygen and carbon dioxide concentrations should be measured. If measurements on the first day of exposure show that these gases are at proper levels, no further measurements should be necessary.

Chamber Temperature and Relative Humidity

23. Chamber temperature should be maintained at 22 ± 3 °C. Relative humidity in the animals' breathing zone, for both nose-only and whole-body exposures, should be monitored continuously and recorded hourly during each exposure where possible. The relative humidity should preferably be maintained in the range of 30 to 70 %, but this may either be unattainable (e.g. when testing water based mixtures) or not measurable due to test chemical interference with the Test Method.

Test chemical: Nominal Concentration

24. Whenever feasible, the nominal exposure chamber concentration should be calculated and recorded. The nominal concentration is the mass of generated test chemical divided by the total volume of air passed through the inhalation chamber system. The nominal concentration is not used to characterise the animals' exposure, but a comparison of the nominal concentration and the actual concentration gives an indication of the generation efficiency of the test system, and thus may be used to discover generation problems.

Test chemical: Actual Concentration

25. The actual concentration is the test chemical concentration as sampled at the animals' breathing zone in an inhalation chamber. Actual concentrations can be obtained either by specific methods (e.g. direct sampling, adsorptive or chemical reactive methods, and subsequent analytical characterisation) or by non-specific methods such as gravimetric filter analysis. The use of gravimetric analysis is acceptable only for single component powder aerosols or aerosols of low volatility liquids and should be supported by appropriate pre-study test chemical-specific characterisations. Multi-component powder

▼ M4

aerosol concentration may also be determined by gravimetric analysis. However, this requires analytical data which demonstrate that the composition of airborne material is similar to the starting material. If this information is not available, a reanalysis of the test chemical (ideally in its airborne state) at regular intervals during the course of the study may be necessary. For aerosolised agents that may evaporate or sublimate, it should be shown that all phases were collected by the method chosen.

26. One lot of the test chemical should be used throughout the duration of the study, if possible, and the test sample should be stored under conditions that maintain its purity, homogeneity, and stability. Prior to the start of the study, there should be a characterisation of the test chemical, including its purity and, if technically feasible, the identity, and quantities of identified contaminants and impurities. This can be demonstrated by, but is not limited to, the following data: retention time and relative peak area, molecular weight from mass spectroscopy or gas chromatography analyses, or other estimates. Although the test sample's identity is not the responsibility of the test laboratory, it may be prudent for the test laboratory to confirm the sponsor's characterisation at least in a limited way (e.g. colour, physical nature, etc.).

27. The exposure atmosphere should be held as constant as practicable. A real-time monitoring device, such as an aerosol photometer for aerosols or a total hydrocarbon analyser for vapours, may be used to demonstrate the stability of the exposure conditions. Actual chamber concentration should be measured at least 3 times during each exposure day for each exposure level. If not feasible due to limited air flow rates or low concentrations, one sample per exposure period is acceptable. Ideally, this sample should then be collected over the entire exposure period. Individual chamber concentration samples should deviate from the mean chamber concentration by no more than $\pm 10\%$ for gases and vapours, and by no more than $\pm 20\%$ for liquid or solid aerosols. Time to attain chamber equilibration (t_{95}) should be calculated and reported. The duration of an exposure spans the time that the test chemical is generated. This takes into account the times required to attain chamber equilibration (t_{95}) and decay. Guidance for estimating t_{95} can be found in GD 39 (2).

28. For very complex mixtures consisting of gases/vapours and aerosols (e.g. combustion atmospheres and test chemicals propelled from purpose-driven end-use products/devices), each phase may behave differently in an inhalation chamber. Therefore, at least one indicator substance (analyte), normally the principal active ingredient in the mixture, of each phase (gas/vapour and aerosol) should be selected. When the test chemical is a mixture, the analytical concentration should be reported for the total mixture, and not just for the active ingredient or the indicator substance (analyte). Additional information regarding actual concentrations can be found in GD 39 (2).

Test chemical: Particle Size Distribution

29. The particle size distribution of aerosols should be determined at least weekly for each concentration level by using a cascade impactor or an alternative instrument such as an aerodynamic particle sizer (APS). If equivalence of the results obtained by a cascade impactor and the alternative instrument can be shown, then the alternative instrument may be used throughout the study.

▼M4

30. A second device, such as a gravimetric filter or an impinger/gas bubbler, should be used in parallel to the primary instrument to confirm the collection efficiency of the primary instrument. The mass concentration obtained by particle size analysis should be within reasonable limits of the mass concentration obtained by filter analysis [see GD 39 (2)]. If equivalence can be demonstrated at all concentrations tested in the early phase of the study, then further confirmatory measurements may be omitted. For the sake of animal welfare, measures should be taken to minimise inconclusive data which may lead to a need to repeat a study.

31. Particle sizing should be performed for vapours if there is any possibility that vapour condensation may result in the formation of an aerosol, or if particles are detected in a vapour atmosphere with potential for mixed phases.

OBSERVATIONS

32. The animals should be clinically observed before, during, and after the exposure period. More frequent observations may be indicated depending on the response of the animals during exposure. When animal observation is hindered by the use of animal restraint tubes, poorly lit whole body chambers, or opaque atmospheres, animals should be carefully observed after exposure. Observations before the next day's exposure can assess any reversibility or exacerbation of toxic effects.

33. All observations are recorded with individual records being maintained for each animal. When animals are killed for humane reasons or found dead, the time of death should be recorded as precisely as possible.

34. Cage-side observations should include changes in the skin and fur, eyes, and mucous membranes; changes in the respiratory and circulatory systems; changes in the nervous system; and changes in somatomotor activity and behaviour patterns. Attention should be directed to observations of tremors, convulsions, salivation, diarrhoea, lethargy, sleep, and coma. The measurement of rectal temperatures may provide supportive evidence of reflex bradypnea or hypo/hyperthermia related to treatment or confinement. Additional assessments may be included in the study protocol such as kinetics, biomonitoring, lung function, retention of poorly soluble materials that accumulate in lung tissue, and behavioural changes.

BODY WEIGHTS

35. Individual animal weights should be recorded shortly before the first exposure (day 0), twice weekly thereafter (for example: on Fridays and Mondays to demonstrate recovery over an exposure-free weekend, or at a time interval to allow assessment of systemic toxicity), and at the time of death or euthanasia. If there are no effects in the first 4 weeks, body weights may be measured weekly for the remainder of the study. Satellite (reversibility) animals (if used) should continue to be weighed weekly throughout the recovery period. At study termination, all animals should be weighed shortly before sacrifice to allow for an unbiased calculated of organ to body weight ratios.

FOOD AND WATER CONSUMPTION

36. Food consumption should be measured weekly. Water consumption may also be measured.

▼ **M4****CLINICAL PATHOLOGY**

37. Clinical pathology assessments should be made for all animals, including controls and satellite (reversibility) animals, when they are sacrificed. The time interval between the end of exposure and blood collection should be recorded, particularly when the reconstitution of the addressed endpoint is rapid. Sampling following the end of exposure is indicated for those parameters with a short plasma half-time (e.g. COHb, CHE, and Methb).
38. Table 1 lists the clinical pathology parameters that are generally required for all toxicology studies. Urinalysis is not required on a routine basis, but may be performed when deemed useful based on expected or observed toxicity. The study director may choose to assess additional parameters in order to better characterise a test chemical's toxicity (e.g. cholinesterase, lipids, hormones, acid/base balance, methaemoglobin or Heinz bodies, creatine kinase, myeloid/erythroid ratio, troponins, arterial blood gases, lactate dehydrogenase, sorbital dehydrogenase, glutamate dehydrogenase, and gamma glutamyl transpeptidase).

*Table 1***Standard Clinical Pathology Parameters**

Haematology	
Erythrocyte count	Total leukocyte count
Haematocrit	Differential leukocyte count
Haemoglobin concentration	Platelet count
Mean corpuscular haemoglobin	Clotting potential (select one):
Mean corpuscular volume	— Prothrombin time
Mean corpuscular haemoglobin concentration	— Clotting time
Reticulocytes	— Partial thromboplastin time
Clinical Chemistry	
Glucose (*)	Alanine aminotransferase
Total cholesterol	Aspartate aminotransferase
Triglycerides	Alkaline phosphatase
Blood urea nitrogen	Potassium
Total bilirubin	Sodium
Creatinine	Calcium
Total protein	Phosphorus
Albumin	Chloride
Globulin	
Urinalysis (optional)	
Appearance (colour and turbidity)	Total protein
Volume	Glucose
Specific gravity or osmolality	Blood/blood cells
pH	

(*) Because a lengthy fasting period can introduce bias in glucose measurements for the treated versus control animals, the study director should determine whether it is appropriate to fast the animals. If a fasting period is used, it should be appropriate to the species used; for the rat this may be 16 h (overnight fasting). Determination of fasting glucose may be carried out after overnight fasting during the last exposure week, or after overnight fasting prior to necropsy (in the latter case together with all other clinical pathology parameters).

▼ M4

39. When there is evidence that the lower respiratory tract (i.e. the alveoli) is the primary site of deposition and retention, then bronchoalveolar lavage (BAL) may be the technique of choice to quantitatively analyse hypothesis-based dose-effect parameters focusing on alveolitis, pulmonary inflammation, and phospholipidosis. This allows for dose-response and time-course changes of alveolar injury to be suitably probed. The BAL fluid may be analysed for total and differential leukocyte counts, total protein, and lactate dehydrogenase. Other parameters that may be considered are those indicative of lysosomal injury, phospholipidosis, fibrosis, and irritant or allergic inflammation which may include the determination of pro-inflammatory cytokines/chemokines. BAL measurements generally complement the results from histopathology examinations but cannot replace them. Guidance on how to perform lung lavage can be found in GD 39 (2).

OPHTHALMOLOGICAL EXAMINATION

40. Using an ophthalmoscope or an equivalent device, ophthalmological examinations of the fundus, refractive media, iris, and conjunctivae should be performed for all animals prior to the administration of the test chemical, and for all high concentration and control groups at termination. If changes in the eyes are detected, all animals in the other groups should be examined including the satellite (reversibility) group.

GROSS PATHOLOGY AND ORGAN WEIGHTS

41. All test animals, including those which die during the test or are removed from the study for animal welfare reasons, should be subjected to complete exsanguination (if feasible) and gross necropsy. The time between the end of each animal's last exposure and its sacrifice should be recorded. If a necropsy cannot be performed immediately after a dead animal is discovered, the animal should be refrigerated (not frozen) at a temperature low enough to minimise autolysis. Necropsies should be performed as soon as possible, normally within a day or two. All gross pathological changes should be recorded for each animal with particular attention to any changes in the respiratory tract.
42. Table 2 lists the organs and tissues that should be preserved in a suitable medium during gross necropsy for histopathological examination. The preservation of the [bracketed] organs and tissues and any other organs and tissues is at the discretion of the study director. The **bolded** organs should be trimmed and weighed wet as soon as possible after dissection to avoid drying. The thyroid and epididymides should only be weighed if needed because trimming artefacts may hinder histopathological evaluation. Tissues and organs should be fixed in 10 % buffered formalin or another suitable fixative as soon as necropsy is performed, and no less than 24-48 hours prior to trimming depending on the fixative to be used.

▼ **M4**

Table 2

Organs and Tissues Preserved During Gross Necropsy

Adrenals	Oesophagus
Aorta	[Olfactory bulb]
Bone marrow (and/or fresh aspirate)	Ovaries
Brain (including sections of cerebrum, cerebellum, and medulla/pons)	Pancreas
Caecum	Parathyroids
Colon	Peripheral nerve (sciatic or tibial, preferably close to muscle)
Duodenum	Pituitary
[Epididymides]	Prostate
[Eyes (retina, optic nerve) and eyelids]	Rectum
Femur and stifle joint	Salivary glands
Gallbladder (where present)	Seminal vesicles
[Harderian glands]	Skin
Heart	Spinal cord (cervical, mid-thoracic, and lumbar)
Ileum	Spleen
Jejunum	Sternum
Kidneys	Stomach
[Lacrimal glands (extraorbital)]	Teeth
Larynx (3 levels including the base of the epiglottis)	Testes
Liver	Thymus
Lung (all lobes at one level, including main bronchi)	Thyroids
Lymph nodes from the hilar region of the lung, especially for poorly soluble particulate test chemicals. For more in depth examinations and/or studies with immunological focus, additional lymph nodes may be considered, e.g. those from the mediastinal, cervical/submandibular and/or auricular regions.	[Tongue]
Lymph nodes (distal from the portal-of-entry)	Trachea (at least 2 levels including 1 longitudinal section through the carina and 1 transverse section)
Mammary gland (female)	[Ureter]
Muscle (thigh)	[Urethra]
Nasopharyngeal tissues (at least 4 levels; 1 level to include the nasopharyngeal duct and the Nasal Associated Lymphoid Tissue (NALT))	Urinary bladder
	Uterus
	Target organs
	All gross lesions and masses

▼ M4

43. The lungs should be removed intact, weighed, and instilled with a suitable fixative at a pressure of 20-30 cm of water to ensure that lung structure is maintained (5). Sections should be collected for all lobes at one level, including main bronchi, but if lung lavage is performed, the unlavaged lobe should be sectioned at three levels (not serial sections).
44. At least 4 levels of the nasopharyngeal tissues should be examined, one of which should include the nasopharyngeal duct (5) (6) (7) (8) (9) to allow adequate examination of the squamous, transitional (non-ciliated respiratory), respiratory (ciliated respiratory) and olfactory epithelium, and the draining lymphatic tissue (NALT) (10) (11). Three levels of the larynx should be examined, and one of these levels should include the base of the epiglottis (12). At least two levels of the trachea should be examined including one longitudinal section through the carina of the bifurcation of the extrapulmonary bronchi and one transverse section.

HISTOPATHOLOGY

45. A histopathological evaluation of all the organs and tissues listed in Table 2 should be performed for the control and high concentration groups, and for all animals which die or are sacrificed during the study. Particular attention should be paid to the respiratory tract, target organs, and gross lesions. The organs and tissues that have lesions in the high concentration group should be examined in all groups. The study director may choose to perform histopathological evaluations for additional groups to demonstrate a clear concentration response. When a satellite (reversibility) group is used, histopathological evaluation should be performed for all tissues and organs identified as showing effects in the treated groups. If there are excessive early deaths or other problems in the high exposure group that compromise the significance of the data, the next lower concentration should be examined histopathologically. An attempt should be made to correlate gross observations with microscopic findings.

DATA AND REPORTING**Data**

46. Individual animal data on body weights, food consumption, clinical pathology, gross pathology, organ weights, and histopathology should be provided. Clinical observation data should be summarised in tabular form showing for each test group the number of animals used, the number of animals displaying specific signs of toxicity, the number of animals found dead during the test or killed for humane reasons, time of death of individual animals, a description and time course of toxic effects and reversibility, and necropsy findings. All results, quantitative and incidental, should be evaluated by an appropriate statistical method. Any generally accepted statistical method may be used and the statistical methods should be selected during the design of the study.

Test Report

47. The test report should include the following information, as appropriate:

Test animals and husbandry

- Description of caging conditions, including: number (or change in number) of animals per cage, bedding material, ambient temperature and relative humidity, photoperiod, and identification of diet.

▼ M4

- Species/strain used and justification for using a species other than the rat. Source and historical data may be provided, if they are for animals exposed under similar exposure, housing, and fasting conditions.
- Number, age, and sex of animals.
- Method of randomisation.
- Description of any pre-test conditioning including diet, quarantine, and treatment for disease.

Test chemical

- Physical nature, purity, and, where relevant, physico-chemical properties (including isomerisation).
- Identification data and Chemical Abstract Services (CAS) Registry Number, if known.

Vehicle

- Justification for use of vehicle and justification for choice of vehicle (if other than water).
- Historical or concurrent data demonstrating that the vehicle does not interfere with the outcome of the study.

Inhalation chamber

- Detailed description of the inhalation chamber including volume and a diagram.
- Source and description of equipment used for the exposure of animals as well as generation of atmosphere.
- Equipment for measuring temperature, humidity, particle-size, and actual concentration.
- Source of air and system used for conditioning.
- Methods used for calibration of equipment to ensure a homogeneous test atmosphere.
- Pressure difference (positive or negative).
- Exposure ports per chamber (nose-only); location of animals in the chamber (whole-body).
- Stability of the test atmosphere.
- Location of temperature and humidity sensors and sampling of test atmosphere in the chamber.
- Treatment of air supplied/extracted.
- Air flow rates, air flow rate/exposure port (nose-only), or animal load/chamber (whole-body).
- Time to inhalation chamber equilibrium (t_{95}).
- Number of volume changes per hour.
- Metering devices (if applicable).

Exposure data

- Rationale for target concentration selection in the main study.

▼ M4

- Nominal concentrations (total mass of test chemical generated into the inhalation chamber divided by the volume of air passed through the chamber).
- Actual test chemical concentrations collected from the animals' breathing zone; for mixtures that produce heterogeneous physical forms (gases, vapours, aerosols), each may be analysed separately.
- All air concentrations should be reported in units of mass (mg/l, mg/m³, etc.) rather than in units of volume (ppm, ppb, etc.).
- Particle size distribution, mass median aerodynamic diameter (MMAD), and geometric standard deviation (σ_g), including their methods of calculation. Individual particle size analyses should be reported.

Test conditions

- Details of test chemical preparation, including details of any procedures used to reduce the particle size of solid materials or to prepare solutions of the test chemical.
- A description (preferably including a diagram) of the equipment used to generate the test atmosphere and to expose the animals to the test atmosphere.
- Details of the equipment used to monitor chamber temperature, humidity, and chamber airflow (i.e. development of a calibration curve).
- Details of the equipment used to collect samples for determination of chamber concentration and particle size distribution.
- Details of the chemical analytical method used and method validation (including efficiency of recovery of test chemical from the sampling medium).
- Method of randomisation in assigning animals to test and control groups.
- Details of food and water quality (including diet type/source, water source).
- The rationale for the selection of test concentrations.

Results

- Tabulation of chamber temperature, humidity, and airflow.
- Tabulation of chamber nominal and actual concentration data.
- Tabulation of particle size data including analytical sample collection data, particle size distribution, and calculations of the MMAD and σ_g .
- Tabulation of response data and concentration level for each animal (i.e. animals showing signs of toxicity including mortality, nature, severity, time of onset, and duration of effects).

▼ M4

- Tabulation of individual animal weights.
- Tabulation of food consumption
- Tabulation of clinical pathology data
- Necropsy findings and histopathological findings for each animal, if available.

Discussion and interpretation of results

- Particular emphasis should be made to the description of methods used to meet the criteria of this Test Method, e.g. the limit concentration or the particle size.
- The respirability of particles in light of the overall findings should be addressed, especially if the particle-size criteria could not be met.
- The consistency of methods used to determine nominal and actual concentrations, and the relation of actual concentration to nominal concentration should be included in the overall assessment of the study.
- The likely cause of death and predominant mode of action (systemic versus local) should be addressed.
- An explanation should be provided if there was a need to humanely sacrifice animals in pain or showing signs of severe and enduring distress, based on the criteria in the OECD Guidance Document on Humane Endpoints (3).
- The target organ(s) should be identified.
- The NOAEL and LOAEL should be determined.

LITERATURE:

- (1) OECD (1981). *Subchronic Inhalation Toxicity Testing*, Original Test Guideline No 413, Environment Directorate, OECD, Paris.
- (2) OECD (2009). *Guidance Document on Acute Inhalation Toxicity Testing*, Environmental Health and Safety Monograph Series on Testing and Assessment No 39, ENV/JM/MONO(2009)28, OECD, Paris.
- (3) OECD (2000). *Guidance Document on the Recognition, Assessment and Use of Clinical Signs as Humane Endpoints for Experimental Animals Used in Safety Evaluation*, Environmental Health and Safety Monograph Series on Testing and Assessment No 19, ENV/JM/MONO(2000)7, OECD, Paris.
- (4) Whalan.E and Redden JC (1994). *Interim Policy for Particle Size and Limit Concentration Issues in Inhalation Toxicity Studies*. Office of Pesticide Programs, United States Environmental Protection Agency.
- (5) Dungworth DL, Tyler WS, Plopper CE (1985). *Morphological Methods for Gross and Microscopic Pathology (Chapter 9) in Toxicology of Inhaled Material*, Witschi, H.P. and Brain, J.D. (eds), Springer Verlag Heidelberg, pp. 229-258.
- (6) Young JT (1981). *Histopathological examination of the rat nasal cavity*. *Fundam. Appl. Toxicol.* 1: 309-312.
- (7) Harkema JR (1990). *Comparative pathology of the nasal mucosa in laboratory animals exposed to inhaled irritants*. *Environ. Health Perspect.* 85: 231-238.

▼M4

- (8) Woutersen RA, Garderen-Hoetmer A, van Slootweg PJ, Feron VJ (1994). Upper respiratory tract carcinogenesis in experimental animals and in humans. In: Waalkes MP and Ward JM (eds) Carcinogenesis. Target Organ Toxicology Series, Raven Press, New York, 215-263.
- (9) Mery S, Gross EA, Joyner DR, Godo M, Morgan KT (1994). Nasal diagrams: A tool for recording the distribution of nasal lesions in rats and mice. *Toxicol. Pathol.* 22: 353-372.
- (10) Kuper CF, Koornstra PJ, Hameleers DMH, Biewenga J, Spit BJ, Duijvestijn AM, Breda Vriesman van PJC, Sminia T (1992). The role of nasopharyngeal lymphoid tissue. *Immunol. Today* 13: 219-224.
- (11) Kuper CF, Arts JHE, Feron VJ (2003). Toxicity to nasal-associated lymphoid tissue. *Toxicol. Lett.* 140-141: 281-285.
- (12) Lewis DJ (1981). Mitotic Indices of Rat Laryngeal Epithelia. *Journal of Anatomy* 132(3): 419-428.
- (13) Regulation (EC) No 1272/2008 of the European Parliament and of the Council of 16 December 2008 on classification, labelling and packaging of substances and mixtures, amending and repealing Directives 67/548/EEC and 1999/45/EC, and amending Regulation (EC) No 1907/2006 (OJ L 353, 31.12.2008, p. 1).

▼ M4

Appendix 1

DEFINITION

Test chemical: Any substance or mixture tested using this Test Method.

▼ M4**B.30. CHRONIC TOXICITY STUDIES**

INTRODUCTION

1. This Test Method is equivalent to OECD Test Guideline (TG) 452 (2009). The original TG 452 was adopted in 1981. Development of this revised Test Method B.30 was considered necessary in order to reflect recent developments in the field of animal welfare and regulatory requirements (1) (2) (3) (4). The updating of this Test Method B.30 has been carried out in parallel with revisions of Chapter B.32 of this Annex, Carcinogenicity Studies, and Chapter B.33 of this Annex, Combined Chronic Toxicity/ Carcinogenicity studies, with the objective of obtaining additional information from the animals used in the study and providing further detail on dose selection. This Test Method is designed to be used in the testing of a broad range of chemicals, including pesticides and industrial chemicals.
2. The majority of chronic toxicity studies are carried out in rodent species, and this Test Method is intended therefore to apply primarily to studies carried out in these species. Should such studies be required in non-rodent species, the principles and procedures outlined in this Test Method, together with those outlined in Chapter B.27 of this Annex, Repeated Dose 90-day Oral Toxicity Study in Non-Rodents (5), may also be applied, with appropriate modifications, as outlined in the OECD Guidance Document No 116 on the Design and Conduct of Chronic Toxicity and Carcinogenicity Studies (6).
3. The three main routes of administration used in chronic toxicity studies are oral, dermal and inhalation. The choice of the route of administration depends on the physical and chemical characteristics of the test chemical and the predominant route of exposure of humans. Additional information on choice of route of exposure is provided in the OECD Guidance Document No 116 (6).
4. This Test Method focuses on exposure via the oral route, the route most commonly used in chronic toxicity studies. While long-term chronic toxicity studies involving exposure via the dermal or inhalation routes may also be necessary for human health risk assessment and/or may be required under certain regulatory regimes, both routes of exposure involve considerable technical complexity. Such studies will need to be designed on a case-by-case basis, although the Test Method outlined here for the assessment and evaluation of chronic toxicity by oral administration could form the basis of a protocol for inhalation and/or dermal studies, with respect to recommendations for treatment periods, clinical and pathology parameters, etc. OECD Guidance is available on the administration of test chemicals by the inhalation (6) (7) and dermal routes (6). Chapter B.8 of this Annex (8) and Chapter B.29 of this Annex (9), together with the OECD Guidance Document on acute inhalation testing (7), should be specifically consulted in the design of longer term studies involving exposure via the inhalation route. Chapter B.9 of this Annex (10) should be consulted in the case of testing carried out by the dermal route.

▼M4

5. The chronic toxicity study provides information on the possible health hazards likely to arise from repeated exposure over a considerable part of the lifespan of the species used. The study will provide information on the toxic effects of the test chemical; indicate target organs and the possibility of accumulation. It can also provide an estimate of the no-observed-adverse effect level which can be used for establishing safety criteria for human exposure. The need for careful clinical observations of the animals, so as to obtain as much information as possible, is also stressed.

6. The objectives of studies covered by this Test Method include:
 - The identification of the chronic toxicity of a test chemical;

 - The identification of target organs;

 - Characterisation of the dose-response relationship;

 - Identification of a no-observed-adverse-effect level (NOAEL) or point of departure for establishment of a Benchmark Dose (BMD);

 - The prediction of chronic toxicity effects at human exposure levels;

 - Provision of data to test hypotheses regarding mode of action (6).

INITIAL CONSIDERATIONS

7. In the assessment and evaluation of the toxicological characteristics of a test chemical, all available information on the test chemical should be considered by the testing laboratory prior to conducting the study, in order to focus the design of the study to more efficiently test for chronic toxicity potential and to minimize animal usage. Information that will assist in the study design includes the identity, chemical structure, and physico-chemical properties of the test chemical; any information on the mode of action; results of any *in vitro* or *in vivo* toxicity tests; anticipated use(s) and potential for human exposure; available (Q)SAR data and toxicological data on structurally-related chemicals; available toxicokinetic data (single dose and also repeat dose kinetics where available) and data derived from other repeated exposure studies. The determination of chronic toxicity should only be carried out after initial information on toxicity has been obtained from repeated dose 28-day and/or 90-day toxicity tests. A phased testing approach to chronic toxicity testing should be considered as part of the overall assessment of the potential adverse health effects of a particular test chemical (11) (12) (13) (14).

8. The statistical methods most appropriate for the analysis of results, given the experimental design and objectives, should be established before commencing the study. Issues to consider include whether the statistics should include adjustment for survival and analysis in the event of premature termination of one or more groups. Guidance on the appropriate statistical analyses and key references to internationally accepted statistical methods are given in Guidance Document No 116 (6), and also in Guidance Document No 35 on the analysis and evaluation of chronic toxicity and carcinogenicity studies (15).

▼ M4

9. In conducting a chronic toxicity study, the guiding principles and considerations outlined in the OECD Guidance Document No 19 on the recognition, assessment, and use of clinical signs as humane endpoints for experimental animals used in safety evaluation (16), in particular paragraph 62 thereof, should always be followed. This paragraph states that *‘In studies involving repeated dosing, when an animal shows clinical signs that are progressive, leading to further deterioration in condition, an informed decision as to whether or not to humanely kill the animal should be made. The decision should include consideration as to the value of the information to be gained from the continued maintenance of that animal on study relative to its overall condition. If a decision is made to leave the animal on test, the frequency of observations should be increased, as needed. It may also be possible, without adversely affecting the purpose of the test, to temporarily stop dosing if it will relieve the pain or distress, or reduce the test dose.’*
10. Detailed guidance on and discussion of the principles of dose selection for chronic toxicity and carcinogenicity studies can be found in Guidance Document No 116 (6), as well as two International Life Sciences Institute publications (17) (18). The core dose selection strategy is dependent on the primary objective or objectives of the study (paragraph 6). In selecting appropriate dose levels, a balance should be achieved between hazard screening on the one hand and characterisation of low-dose responses and their relevance on the other. This is particularly relevant in the situation where a combined chronic toxicity and carcinogenicity study (Chapter B.33 of this Annex) is to be carried out (paragraph 11).
11. Consideration should be given to carrying out a combined chronic toxicity and carcinogenicity study (Chapter B.33 of this Annex), rather than separate execution of a chronic toxicity study (this Test Method B.30) and carcinogenicity study (Chapter B.32 of this Annex). The combined test provides greater efficiency in terms of time and cost compared to conducting two separate studies, without compromising the quality of the data in either the chronic phase or the carcinogenicity phase. Careful consideration should however be given to the principles of dose selection (paragraphs 9 and 20-25) when undertaking a combined chronic toxicity and carcinogenicity study (Chapter B.33 of this Annex), and it is also recognised that separate studies may be required under certain regulatory frameworks.
12. Definitions used in the context of this Test Method can be found at the end of this chapter and in the Guidance Document No 116 (6).

PRINCIPLE OF THE TEST

13. The test chemical is administered daily in graduated doses to several groups of experimental animals, normally for a period of 12 months, although longer or shorter durations may also be chosen depending on regulatory requirements (see paragraph 33). This duration is chosen to be sufficiently long to allow any effects of cumulative toxicity to become manifest, without the confounding effects of geriatric changes. Deviations from exposure duration of 12 months should be justified, particularly in the case of shorter durations. The test chemical is normally administered by the oral route although testing by the inhalation or dermal route may also be appropriate. The study design may also include one or more interim kills, e.g. at 3 and 6 months, and additional groups of animals may be included to accommodate this (see paragraph 19). During the period of administration the animals are observed closely for signs of toxicity. Animals which die or are killed during the test are necropsied and, at the conclusion of the test, surviving animals are killed and necropsied.

▼ M4**DESCRIPTION OF THE METHOD****Selection of animal species**

14. This Test Method primarily covers assessment and evaluation of chronic toxicity in rodents (see paragraph 2) although it is recognised that similar studies in non-rodents may be required under certain regulatory regimes. The choice of species should be justified. The design and conduct of chronic toxicity studies in non-rodent species, when required, should be based on the principles outlined in this Test Method together with those in Chapter B.27 of this Annex, Repeated Dose 90-day Oral Toxicity Study in Non-Rodents (5). Additional information on choice of species and strain is provided in Guidance Document No 116 (6).

15. In this Test Method, the preferred rodent species is the rat, although other rodent species, e.g. the mouse, may be used. Rats and mice have been preferred experimental models because of their relatively short life span, their widespread use in pharmacological and toxicological studies, their susceptibility to tumour induction, and the availability of sufficiently characterised strains. As a consequence of these characteristics, a large amount of information is available on their physiology and pathology. Young healthy adult animals of commonly used laboratory strains should be employed. The chronic toxicity study should be carried out in animals from the same strain and source as those used in preliminary toxicity study(ies) of shorter duration. The females should be nulliparous and non-pregnant.

Housing and feeding conditions

16. Animals may be housed individually, or be caged in small groups of the same sex; individual housing should be considered only if scientifically justified (19) (20) (21). Cages should be arranged in such a way that possible effects due to cage placement are minimised. The temperature in the experimental animal room should be 22 °C (\pm 3 °C). Although the relative humidity should be at least 30 % and preferably not exceed 70 % other than during room cleaning, the aim should be 50-60 %. Lighting should be artificial, the sequence being 12 hours light, 12 hours dark. For feeding, conventional laboratory diets may be used with an unlimited supply of drinking water. The diet should meet all the nutritional requirements of the species tested and the content of dietary contaminants including but not limited to pesticide residues, persistent organic pollutants, phytoestrogens, heavy metals and mycotoxins, that might influence the outcome of the test, should be as low as possible. Analytical information on the nutrient and dietary contaminant levels should be generated periodically, at least at the beginning of the study and when there is a change in the batch used, and should be included in the final report. Analytical information on the drinking water used in the study should similarly be provided. The choice of diet may be influenced by the need to ensure a suitable admixture of a test chemical and to meet the nutritional requirements of the animals when the test chemical is administered by the dietary route.

Preparation of animals

17. Healthy animals, which have been acclimated to laboratory conditions for at least 7 days and have not been subjected to previous experimental procedures, should be used. In the case of rodents, dosing of the animals should begin as soon as possible after weaning and acclimatisation and preferably before the animals are 8 weeks old. The test animals should be characterised as to species, strain, source, sex, weight and age. At the commencement of the study, the weight variation for each sex of animals used should be minimal and not exceed \pm 20 % of the mean weight of all

▼ M4

the animals within the study, separately for each sex. Animals should be randomly assigned to the control and treatment groups. After randomisation, there should be no significant differences in mean body weights between groups within each sex. If there are statistically significant differences, then the randomisation step should be repeated, if possible. Each animal should be assigned a unique identification number, and permanently marked with this number by tattooing, microchip implant, or other suitable method.

PROCEDURE**Number and sex of animals**

18. Both sexes should be used. A sufficient number of animals should be used so that at the end of the study enough animals in every group are available for thorough biological and statistical evaluation. For rodents, at least 20 animals per sex per group should normally be used at each dose level, while for non-rodents a minimum of 4 per sex per group is recommended. In studies involving mice, additional animals may be needed in each dose group to conduct all required haematological determinations.

Provision for interim kills, satellite groups and sentinel animals

19. The study may make provision for interim kills (at least 10 animals/sex/group), e.g. at 6 months, to provide information on progression of toxicological changes and mechanistic information, if scientifically justified. Where such information is already available from previous repeat dose toxicity studies on the test chemical, interim kills may not be scientifically justified. Satellite groups may also be included to monitor the reversibility of any toxicological changes induced by the test chemical under investigation; these will normally be restricted to the highest dose level of the study plus control. An additional group of sentinel animals (typically 5 animals per sex) may also be included for monitoring of disease status, if necessary, during the study (22). If interim kills or inclusion of satellite or sentinel groups are planned, the number of animals included in the study design should be increased by the number of animals scheduled to be killed before the completion of the study. These animals should normally undergo the same observations, including body weight, food/water consumption, haematological and clinical biochemistry measurements and pathological investigations as the animals in the chronic toxicity phase of the main study, although provision may also be made (in the interim kill groups) for measurements to be restricted to specific, key measures such as neurotoxicity or immunotoxicity.

Dose groups and dosage

20. Guidance on all aspects of dose selection and dose level spacing is provided in Guidance Document No 116 (6). At least three dose levels and a concurrent control should be used, except where a limit test is conducted (see paragraph 27). Dose levels will generally be based on the results of shorter-term repeated dose or range finding studies and should take into account any existing toxicological and toxicokinetic data available for the test chemical or related chemicals.

▼M4

21. Unless limited by the physical-chemical nature or biological effects of the test chemical, the highest dose level should normally be chosen to identify the principal target organs and toxic effects while avoiding suffering, severe toxicity, morbidity, or death. While taking into account the factors outlined in paragraph 22 below, the highest dose level should be chosen to elicit evidence of toxicity, as evidenced by, for example, depression of body weight gain (approximately 10 %).
22. However, dependent on the objectives of the study (see paragraph 6), a top dose lower than the dose providing evidence of toxicity may be chosen, e.g. if a dose elicits an adverse effect of concern that nonetheless has little impact on lifespan or body weight. The top dose should not exceed 1 000 mg/kg body weight/day (limit dose, see paragraph 27).
23. Dose levels and dose level spacing may be selected to establish a dose-response and a NOAEL or other intended outcome of the study, e.g. a BMD (see paragraph 25) at the lowest dose level. Factors that should be considered in the placement of lower doses include the expected slope of the dose-response curve, the doses at which important changes may occur in metabolism or mode of toxic action, where a threshold is expected, or where a point of departure for low-dose extrapolation is expected.
24. The dose level spacing selected will depend on the characteristics of the test chemical, and cannot be prescribed in this Test Method, but two to four fold intervals frequently provide good test performance when used for setting the descending dose levels and addition of a fourth test group is often preferable to using very large intervals (e.g. more than a factor of about 6-10) between dosages. In general the use of factors greater than 10 should be avoided, and should be justified if used.
25. As outlined further in Guidance Document No 116 (6), points to be considered in dose selection include:
 - Known or suspected nonlinearities or inflection points in the dose-response;
 - Toxicokinetics, and dose ranges where metabolic induction, saturation, or nonlinearity between external and internal doses does or does not occur;
 - Precursor lesions, markers of effect, or indicators of the operation of key underlying biological processes;
 - Key (or suspected) aspects of mode of action, such as doses at which cytotoxicity begins to arise, hormone levels are perturbed, homeostatic mechanisms are overwhelmed, etc.;
 - Regions of the dose-response curve where particularly robust estimation is needed, e.g. in the range of the anticipated BMD or a suspected threshold;
 - Consideration of anticipated human exposure levels.

▼ M4

26. The control group shall be an untreated group or a vehicle-control group if a vehicle is used in administering the test chemical. Except for treatment with the test chemical, animals in the control group should be handled in an identical manner to those in the test groups. If a vehicle is used, the control group shall receive the vehicle in the highest volume used among the dose groups. If a test chemical is administered in the diet, and causes significantly reduced dietary intake due to the reduced palatability of the diet, an additional pair-fed control group may be useful, to serve as a more suitable control.

27. If it can be anticipated, based on information from preliminary studies, that a test at one dose level, equivalent to at least 1 000 mg/kg body weight/day, using the procedures described for this study, is unlikely to produce adverse effects and if toxicity would not be expected based upon data from structurally related chemicals, then a full study using three dose levels may not be considered necessary. A limit of 1 000 mg/kg body weight/day may apply except when human exposure indicates the need for a higher dose level to be used.

Preparation of doses and administration of test chemical

28. The test chemical is normally administered orally, via the diet or drinking water, or by gavage. Additional information on routes and methods of administration is provided in Guidance Document No 116 (6). The route and method of administration is dependent on the purpose of the study, the physical/chemical properties of the test chemical, its bioavailability and the predominant route and method of exposure of humans. A rationale should be provided for the chosen route and method of administration. In the interests of animal welfare, oral gavage should normally be selected only for those agents for which this route and method of administration reasonably represent potential human exposure (e.g. pharmaceuticals). For dietary or environmental chemicals including pesticides, administration is typically via the diet or drinking water. However, for some scenarios, e.g. occupational exposure, administration via other routes may be more appropriate.

29. Where necessary, the test chemical is dissolved or suspended in a suitable vehicle. Consideration should be given to the following characteristics of the vehicle and other additives, as appropriate: effects on the absorption, distribution, metabolism, or retention of the test chemical; effects on the chemical properties of the test chemical which may alter its toxic characteristics; and effects on the food or water consumption or the nutritional status of the animals. It is recommended that, wherever possible, the use of an aqueous solution/suspension be considered first, followed by consideration of a solution/emulsion in oil (e.g. corn oil) and then by possible solution in other vehicles. For vehicles other than water, the toxic characteristics of the vehicle should be known. Information should be available on the stability of the test chemical and the homogeneity of dosing solutions or diets (as appropriate) under the conditions of administration (e.g. diet).

30. For chemicals administered via the diet or drinking water it is important to ensure that the quantities of the test chemical involved do not interfere with normal nutrition or water balance. In long-term toxicity studies using dietary administration, the concentration of the test chemical in the feed should not normally exceed an upper limit of 5 % of the total diet, in order to avoid nutritional imbalances. When the test chemical is administered in the diet, either a constant dietary concentration (mg/kg diet or ppm) or a constant dose level in terms of the animal's body weight (mg/kg body weight), calculated on a weekly basis, may be used. The alternative used should be specified.

▼ M4

31. In the case of oral administration, the animals are dosed with the test chemical daily (seven days each week), normally for a period of 12 months (see also paragraph 33), although a longer duration may be required depending on regulatory requirements. Any other dosing regime, e.g. five days per week, needs to be justified. In the case of dermal administration, animals are normally treated with the test chemical for at least 6 hours per day, 7 days per week, as specified in Chapter B.9 of this Annex (10), for a period of 12 months. Exposure by the inhalation route is carried out for 6 hours per day, 7 days per week, but exposure for 5 days per week may also be used, if justified. The period of exposure will normally be for a period of 12 months. If rodent species other than rats are exposed nose-only, maximum exposure durations may be adjusted to minimise species-specific distress. A rationale should be provided when using an exposure duration of less than 6 hours per day. See also Chapter B.8 of this Annex (8).

32. When the test chemical is administered by gavage to the animals this should be done using a stomach tube or a suitable intubation cannula, at similar times each day. Normally a single dose will be administered once daily, where for example a chemical is a local irritant, it may be possible to maintain the daily dose-rate by administering it as a split dose (twice a day). The maximum volume of liquid that can be administered at one time depends on the size of the test animal. The volume should be kept as low as practical, and should not normally exceed 1 ml/100 g body weight for rodents (22). Variability in test volume should be minimised by adjusting the concentration to ensure a constant volume at all dose levels. Potentially corrosive or irritant chemicals are the exception, and need to be diluted to avoid severe local effects. Testing at concentrations that are likely to be corrosive or irritant to the gastrointestinal tract should be avoided.

Duration of study

33. While this Test Method primarily is designed as a 12 month chronic toxicity study, the study design also allows for and can be applied to either shorter (e.g. 6 or 9 months) or longer (e.g. 18 or 24 months) duration studies, depending on the requirements of particular regulatory regimes or for specific mechanistic purposes. Deviations from an exposure duration of 12 months should be justified, particularly in the case of shorter durations. Satellite groups included to monitor the reversibility of any toxicological changes induced by the test chemical under investigation should be maintained without dosing for a period not less than 4 weeks and not more than one third of the total study duration after cessation of exposure. Further guidance, including consideration of survival in the study, is provided in Guidance Document No 116 (6).

OBSERVATIONS

34. All animals should be checked for morbidity or mortality, usually at the beginning and end of each day, including at weekends and holidays. General clinical observations should be made at least once a day, preferably at the same time(s) each day, taking into consideration the peak period of anticipated effects after dosing in the case of gavage administration.

▼ M4

35. Detailed clinical observations should be made on all animals at least once prior to the first exposure (to allow for within-subject comparisons), at the end of the first week of the study and monthly thereafter. The protocol for observations should be arranged such that variations between individual observers are minimised and independent of test group. These observations should be made outside the home cage, preferably in a standard arena and at similar times on each occasion. They should be carefully recorded, preferably using scoring systems, explicitly defined by the testing laboratory. Efforts should be made to ensure that variations in the observation conditions are minimal. Signs noted should include, but not be limited to, changes in skin, fur, eyes, mucous membranes, occurrence of secretions and excretions and autonomic activity (e.g. lacrimation, piloerection, pupil size, and unusual respiratory pattern). Changes in gait, posture and response to handling as well as the presence of clonic or tonic movements, stereotypies (e.g. excessive grooming, repetitive circling) or bizarre behaviour (e.g. self-mutilation, walking backwards) should also be recorded (24).

36. Ophthalmological examination, using an ophthalmoscope or other suitable equipment, should be carried out on all animals prior to the first administration of the test chemical. At the termination of the study, this examination should be preferably conducted in all animals but at least in the high dose and control groups. If treatment-related changes in the eyes are detected, all animals should be examined. If structural analysis or other information suggests ocular toxicity, then the frequency of ocular examination should be increased.

37. For chemicals where previous repeated dose 28-day and/or 90-day toxicity tests indicated the potential to cause neurotoxic effects, sensory reactivity to stimuli of different types (24) (e.g. auditory, visual and proprioceptive stimuli) (25), (26), (27), assessment of grip strength (28) and motor activity assessment (29) may optionally be conducted before commencement of the study and at 3 month periods after study initiation up to and including 12 months, as well as at study termination (if longer than 12 months). Further details of the procedures that could be followed are given in the respective references. However, alternative procedures than those referenced could also be used.

38. For chemicals where previous repeated dose 28-day and/or 90-day toxicity tests indicated the potential to cause immunotoxic effects, further investigations of this endpoint may optionally be conducted at termination.

Body weight, food/water consumption and food efficiency

39. All animals should be weighed at the start of treatment, at least once a week for the first 13 weeks, and at least monthly thereafter. Measurements of food consumption and food efficiency should be made at least weekly for the first 13 weeks and at least monthly thereafter. Water consumption should be measured at least weekly for the first 13 weeks and at least monthly thereafter when the chemical is administered in drinking water. Water consumption measurements should also be considered for studies in which drinking activity is altered.

▼ M4**Haematology and clinical biochemistry**

40. In studies involving rodents, haematological examinations should be carried out in at least 10 male and 10 female animals per group, at 3, 6, and 12 months, as well as at study termination (if longer than 12 months), using the same animals throughout. In mice, satellite animals may be needed in order to conduct all required haematological determinations (see paragraph 18). In non-rodent studies, samples will be taken from smaller numbers of animals (e.g. 4 animals per sex and per group in dog studies), at interim sampling times and at termination as described for rodents. Measurements at 3 months, either in rodents or non-rodents, need not be conducted if no effect was seen on haematological parameters in a previous 90 day study carried out at comparable dose levels. Blood samples should be taken from a named site, for example by cardiac puncture or from the retro-orbital sinus, under anaesthesia.
41. The following list of parameters should be investigated (30): Total and differential leukocyte count, erythrocyte count, platelet count, haemoglobin concentration, haematocrit (packed cell volume), mean corpuscular volume (MCV), mean corpuscular haemoglobin (MCH), mean corpuscular haemoglobin concentration (MCHC), prothrombin time, and activated partial thromboplastin time. Other hematology parameters such as Heinz bodies or other atypical erythrocyte morphology or methaemoglobin may be measured as appropriate depending on the toxicity of the test chemical. Overall, a flexible approach should be adopted, depending on the observed and/or expected effect from a given test chemical. If the test chemical has an effect on the haematopoietic system, reticulocyte counts and bone marrow cytology may also be indicated, although these need not be routinely conducted.
42. Clinical biochemistry determinations to investigate major toxic effects in tissues and, specifically, effects on kidney and liver, should be performed on blood samples obtained from at least 10 male and 10 female animals per group at the same time intervals as specified for the haematological investigations, using the same animals throughout. In mice, satellite animals may be needed in order to conduct all required clinical biochemistry determinations. In non-rodent studies, samples will be taken from smaller numbers of animals (e.g. 4 animals per sex and per group in dog studies), at interim sampling times and at termination as described for rodents. Measurements at 3 months, either in rodents or non-rodents, need not be conducted if no effect was seen on clinical biochemistry parameters in a previous 90 day study carried out at comparable dose levels. Overnight fasting of the animals (with the exception of mice) prior to blood sampling is recommended. The following list of parameters should be investigated (30): glucose, urea (urea nitrogen), creatinine, total protein, albumin, calcium, sodium, potassium, total cholesterol, at least two appropriate tests for hepatocellular evaluation (alanine aminotransferase, aspartate aminotransferase, glutamate dehydrogenase, total bile acids) (31), and at least two appropriate tests for hepatobiliary evaluation (alkaline phosphatase, gamma glutamyl transferase, 5'-nucleotidase, total bilirubin, total bile acids) (31). Other clinical chemistry parameters such as fasting triglycerides, specific hormones and cholinesterase may be measured as appropriate, depending on the toxicity of the test chemical. Overall, there is a need for a flexible approach, depending on the observed and/or expected effect from a given test chemical.

▼ **M4**

43. Urinalysis determinations should be performed on at least 10 male and 10 female animals per group on samples collected at the same intervals as for haematology and clinical chemistry. Measurements at 3 months need not be conducted if no effect was seen on urinalysis in a previous 90 day study carried out at comparable dose levels. The following list of parameters was included in an expert recommendation on clinical pathology studies (30): appearance, volume, osmolality or specific gravity, pH, total protein, and glucose. Other determinations include ketone, urobilinogen, bilirubin, and occult blood. Further parameters may be employed where necessary to extend the investigation of observed effect(s).
44. It is generally considered that baseline haematological and clinical biochemistry variables are needed before treatment for dog studies, but need not be determined in rodent studies (30). However, if historical baseline data (see paragraph 50) are inadequate, consideration should be given to generating such data.

Pathology*Gross necropsy*

45. All animals in the study shall normally be subjected to a full, detailed gross necropsy which includes careful examination of the external surface of the body, all orifices, and the cranial, thoracic and abdominal cavities and their contents. However provision may also be made (in the interim kill or satellite groups) for measurements to be restricted to specific, key measures such as neurotoxicity or immunotoxicity (see paragraph 19). These animals need not be subjected to necropsy and the subsequent procedures described in the following paragraphs. Sentinel animals may require necropsy on a case-by-case basis, at the discretion of the study director.
46. Organ weights should be collected from all animals, other than those excluded by the latter part of paragraph 45. The adrenals, brain, epididymides, heart, kidneys, liver, ovaries, spleen, testes, thyroid (weighed post-fixation, with parathyroids), and uterus of all animals (apart from those found moribund and/or intercurrently killed) should be trimmed of any adherent tissue, as appropriate, and their wet weight taken as soon as possible after dissection to prevent drying. In a study using mice, weighing of the adrenal glands is optional.
47. The following tissues should be preserved in the most appropriate fixation medium for both the type of tissue and the intended subsequent histopathological examination (32) (tissues in square brackets are optional):

all gross lesions	heart	pancreas	stomach (forestomach, glandular stomach)
adrenal gland	ileum	parathyroid gland	[teeth]
aorta	jejunum	peripheral nerve	testis
brain (including sections of cerebrum, cerebellum, and medulla/pons)	kidney	pituitary	thymus
caecum	lacrimal gland (exorbital)	prostate	thyroid
cervix	liver	rectum	[tongue]

▼ **M4**

coagulating gland	lung	salivary gland	trachea
colon	lymph nodes (both superficial and deep)	seminal vesicle	urinary bladder
duodenum	mammary gland (obligatory for females and, if visibly dissectable, from males)	skeletal muscle	uterus (including cervix)
epididymis	[upper respiratory tract, including nose, turbinates, and paranasal sinuses]	skin	[ureter]
eye (including retina)	oesophagus	spinal cord (at three levels: cervical, mid-thoracic, and lumbar)	[urethra]
[femur with joint]	[olfactory bulb]	spleen	vagina
gall bladder (for species other than rat)	ovary	[sternum],	section of bone marrow and/or a fresh bone marrow aspirate
Harderian gland			

In the case of paired organs, e.g. kidney, adrenal, both organs should be preserved. The clinical and other findings may suggest the need to examine additional tissues. Also any organs considered likely to be target organs based on the known properties of the test chemical should be preserved. In studies involving the dermal route of administration, the list of organs as set out for the oral route should be preserved, and specific sampling and preservation of the skin from the site of application is essential. In inhalation studies, the list of preserved and examined tissues from the respiratory tract should follow the recommendations of Chapters B.8 of this Annex (8) and Chapter B.29 of this Annex (9). For other organs/tissues (and in addition to the specifically preserved tissues from the respiratory tract) the list of organs as set out for the oral route should be examined.

Histopathology

48. Guidance is available on best practices in the conduct of toxicological pathology studies (32). The minimum histopathological examinations should be:

- all tissues from the high dose and control groups;
- all tissues from animals dying or killed during the study;
- all tissues showing macroscopic abnormalities;
- target tissues, or tissues which showed treatment-related changes in the high dose group, from all animals in all other dose groups;
- in the case of paired organs, e.g. kidney, adrenal, both organs should be examined.

▼ M4

DATA AND REPORTING

Data

49. Individual animal data should be provided for all parameters evaluated. Additionally, all data should be summarised in tabular form showing for each test group the number of animals at the start of the test, the number of animals found dead during the test or killed for humane reasons and the time of any death or humane kill, the number showing signs of toxicity, a description of the signs of toxicity observed, including time of onset, duration, and severity of any toxic effects, the number of animals showing lesions, the type of lesions and the percentage of animals displaying each type of lesion. Summary data tables should provide the means and standard deviations (for continuous test data) of animals showing toxic effects or lesions, in addition to the grading of lesions.
50. Historical control data may be valuable in the interpretation of the results of the study, e.g. in the case when there are indications that the data provided by the concurrent controls are substantially out of line when compared to recent data from control animals from the same test facility/colony. Historical control data, if evaluated, should be submitted from the same laboratory and relate to animals of the same age and strain generated during the five years preceding the study in question.
51. When applicable, numerical results should be evaluated by an appropriate and generally acceptable statistical method. The statistical methods and the data to be analysed should be selected during the design of the study (paragraph 8). Selection should make provision for survival adjustments, if needed.

Test Report

52. The test report should include the following information:

Test chemical:

- physical nature, purity, and physicochemical properties;
- identification data;
- source of chemical;
- batch number;
- certificate of chemical analysis

Vehicle (if appropriate):

- justification for choice of vehicle (if other than water).

Test animals:

- species/strain used and justification for choice made;
- number, age, and sex of animals at start of test;

▼ M4

- source, housing conditions, diet, etc.;
- individual weights of animals at the start of the test.

Test conditions:

- rationale for route of administration and dose selection;
- when applicable, the statistical methods used to analyse the data;
- details of test chemical formulation/diet preparation;
- analytical data on achieved concentration, stability and homogeneity of the preparation;
- route of administration and details of the administration of the test chemical;
- for inhalation studies, whether nose only or whole body;
- actual doses (mg/kg body weight/day), and conversion factor from diet/drinking water test chemical concentration (mg/kg or ppm) to the actual dose, if applicable;
- details of food and water quality.

Results (summary tabulated data and individual animal data should be presented):

- survival data;
- body weight/body weight changes;
- food consumption, calculations of food efficiency, if made, and water consumption if applicable;
- toxic response data by sex and dose level, including signs of toxicity;
- nature, incidence (and, if scored, severity), and duration of clinical observations ((whether transitory or permanent);
- ophthalmological examination;
- haematological tests;
- clinical biochemistry tests;
- urinalysis tests;
- outcome of any investigations of neurotoxicity or immunotoxicity;
- terminal body weight;
- organ weights (and their ratios, if applicable);
- necropsy findings;
- a detailed description of all treatment-related histopathological findings;
- absorption data if available;

▼M4

Statistical treatment of results, as appropriate

Discussion of results including:

- Dose: response relationships
- Consideration of any mode of action information
- Discussion of any modelling approaches
- BMD, NOAEL or LOAEL determination
- Historical control data
- Relevance for humans

Conclusions

LITERATURE:

- (1) OECD (1995). Report of the Consultation Meeting on Sub-chronic and Chronic Toxicity/Carcinogenicity Testing (Rome, 1995), internal working document, Environment Directorate, OECD, Paris.
- (2) Combes RD, Gaunt I, Balls M (2004). A Scientific and Animal Welfare Assessment of the OECD Health Effects Test Guidelines for the Safety Testing of Chemicals under the European Union REACH System. ATLA 32: 163-208.
- (3) Barlow SM, Greig JB, Bridges JW *et al.* (2002). Hazard identification by methods of animal-based toxicology. *Food. Chem. Toxicol.* 40, 145-191.
- (4) Chhabra RS, Bucher JR, Wolfe M, Portier C (2003). Toxicity characterization of environmental chemicals by the US National Toxicology Programme: an overview. *Int. J. Hyg. Environ. Health* 206: 437-445.
- (5) Chapter B.27 of this Annex, Sub-chronic Oral Toxicity Test Repeated Dose 90-day Oral Toxicity Study in Non-Rodents.
- (6) OECD (2012). Guidance Document on the Design and Conduct of Chronic Toxicity and Carcinogenicity Studies, Supporting Test Guidelines 451, 452 and 453 — Second edition. Series on Testing and Assessment No 116, available on the OECD public website for Test Guideline at www.oecd.org/env/testguidelines.
- (7) OECD (2009). Guidance Document on Acute Inhalation Toxicity Testing, Series on Testing and Assessment No 39, ENV/JM/MONO(2009)28, OECD, Paris.
- (8) Chapter B.8 of this Annex, Subacute Inhalation Toxicity: 28-Day Study.
- (9) Chapter B.29 of this Annex, Subchronic Inhalation Toxicity: 90-Day Study.
- (10) Chapter B.9 of this Annex, Repeated Dose (28 Days) Toxicity (Dermal).
- (11) Carmichael NG, Barton HA, Boobis AR *et al.* (2006). Agricultural Chemical Safety Assessment: A Multisector Approach to the Modernization of Human Safety Requirements. *Critical Reviews in Toxicology* 36: 1-7.
- (12) Barton HA, Pastoor TP, Baetcke T *et al.* (2006). The Acquisition and Application of Absorption, Distribution, Metabolism, and Excretion (ADME) Data in Agricultural Chemical Safety Assessments. *Critical Reviews in Toxicology* 36: 9-35.
- (13) Doe JE, Boobis AR, Blacker A *et al.* (2006). A Tiered Approach to Systemic Toxicity Testing for Agricultural Chemical Safety Assessment. *Critical Reviews in Toxicology* 36: 37-68.

▼ **M4**

- (14) Cooper RL, Lamb JS, Barlow SM *et al.* (2006). A Tiered Approach to Life Stages Testing for Agricultural Chemical Safety Assessment. *Critical Reviews in Toxicology* 36: 69-98.
- (15) OECD (2002). Guidance Notes for Analysis and Evaluation of Chronic Toxicity and Carcinogenicity Studies, Series on Testing and Assessment No 35 and Series on Pesticides No 14, ENV/JM/MONO(2002)19, OECD, Paris.
- (16) OECD (2000). Guidance Document on the recognition, assessment, and use of clinical signs as humane endpoints for experimental animals used in safety evaluation, No 19, ENV/JM/MONO(2000)7, OECD, Paris.
- (17) Rhomberg LR, Baetcke K, Blancato J, Bus J, Cohen S, Conolly R, Dixit R, Doe J, Ekelman K, Fenner-Crisp P, Harvey P, Hattis D, Jacobs A, Jacobson-Kram D, Lewandowski T, Liteplo R, Pelkonen O, Rice J, Somers D, Turturro A, West W, Olin S (2007). Issues in the Design and Interpretation of Chronic Toxicity and Carcinogenicity Studies in Rodents: Approaches to Dose Selection *Crit Rev. Toxicol.* 37 (9): 729 - 837.
- (18) ILSI (International Life Sciences Institute) (1997). Principles for the Selection of Doses in Chronic Rodent Bioassays. Foran JA (Ed.). ILSI Press, Washington, DC.
- (19) Directive 2010/63/EU of the European parliament and of the Council of 22 September 2010 on the protection of animals used for scientific purposes (OJ L 276, 20.10.2010, p. 33).
- (20) National Research Council, 1985. Guide for the care and use of laboratory animals. NIH Publication No 86-23. Washington D.C., US. Dept. of Health and Human Services.
- (21) GV-SOLAS (Society for Laboratory Animal Science, Gesellschaft für Versuchstierkunde, 1988). Publication on the Planning and Structure of Animal Facilities for Institutes Performing Animal Experiments. ISBN 3-906255-04-2.
- (22) GV-SOLAS (Society for Laboratory Animal Science, Gesellschaft für Versuchstierkunde, 2006). Microbiological monitoring of laboratory animals in various housing systems.
- (23) Diehl K-H, Hull R, Morton D, Pfister R, Rabemampianina Y, Smith D, Vidal J-M, van de Vorstenbosch C. 2001. A good practice guide to the administration of substances and removal of blood, including routes and volumes. *Journal of Applied Toxicology* 21:15-23.
- (24) IPCS (1986). Principles and Methods for the Assessment of Neurotoxicity Associated with Exposure to Chemicals. Environmental Health Criteria Document No 60.
- (25) Tupper DE, Wallace RB (1980). Utility of the Neurologic Examination in Rats. *Acta Neurobiol. Exp.* 40: 999-1003.
- (26) Gad SC (1982). A Neuromuscular Screen for Use in Industrial Toxicology. *J. Toxicol. Environ. Health* 9: 691-704.
- (27) Moser VC, McDaniel KM, Phillips PM (1991). Rat Strain and Stock Comparisons Using a Functional Observational Battery: Baseline Values and Effects of Amitraz. *Toxicol. Appl. Pharmacol.* 108: 267-283.
- (28) Meyer OA, Tilson HA, Byrd WC, Riley MT (1979). A Method for the Routine Assessment of Fore- and Hind-limb Grip Strength of Rats and Mice. *Neurobehav. Toxicol.* 1: 233-236.
- (29) Crofton KM, Howard JL, Moser VC, Gill MW, Reiter LW, Tilson HA, MacPhail RC (1991). Interlaboratory Comparison of Motor Activity Experiments: Implication for Neurotoxicological Assessments. *Neurotoxicol. Teratol.* 13: 599-609.

▼ **M4**

- (30) Weingand K, Brown G, Hall R *et al.* (1996). Harmonisation of Animal Clinical Pathology Testing in Toxicity and Safety Studies. *Fundam. & Appl. Toxicol.* 29: 198-201.
- (31) EMEA (draft) document 'Non-clinical guideline on drug-induced hepatotoxicity' (Doc. Ref. EMEA/CHMP/SWP/a50115/2006).
- (32) Crissman JW, Goodman DG, Hildebrandt PK *et al.* (2004). Best Practices Guideline: Toxicological Histopathology. *Toxicologic Pathology* 32: 126-131.

▼ M4

Appendix 1

DEFINITION

Test chemical: Any substance or mixture tested using this Test Method.

▼B**B.31. PRENATAL DEVELOPMENTAL TOXICITY STUDY****1. METHOD**

This method is a replicate of OECD TG 414 (2001).

1.1. INTRODUCTION

This method for developmental toxicity testing is designed to provide general information concerning the effects of prenatal exposure on the pregnant test animal and on the developing organism in utero; this may include assessment of maternal effects as well as death, structural abnormalities, or altered growth in the foetus. Functional deficits, although an important part of development, are not an integral part of this test method. They may be tested for in a separate study or as an adjunct to this study using the test method for developmental neurotoxicity. For information on testing for functional deficiencies and other postnatal effects the test method for the two-generation reproductive toxicity study and the developmental neurotoxicity study should be consulted as appropriate.

This test method may require specific adaptation in individual cases on the basis of specific knowledge on e.g. physicochemical or toxicological properties of the test substance. Such adaptation is acceptable, when convincing scientific evidence suggests that the adaptation will lead to a more informative test. In such a case, this scientific evidence should be carefully documented in the study report.

1.2. DEFINITIONS

Developmental toxicology: the study of adverse effects on the developing organism that may result from exposure prior to conception, during prenatal development, or postnatally to the time of sexual maturation. The major manifestations of developmental toxicity include 1) death of the organism, 2) structural abnormality, 3) altered growth, and 4) functional deficiency. Developmental toxicology was formerly often referred to as teratology.

Adverse effect: any treatment-related alteration from baseline that diminishes an organism's ability to survive, reproduce or adapt to the environment. Concerning developmental toxicology, taken in its widest sense it includes any effect which interferes with normal development of the conceptus, both before and after birth.

Altered growth: an alteration in offspring organ or body weight or size.

Alterations (anomalies): structural alterations in development that include both malformations and variations (28).

Malformation/Major abnormality: structural change considered detrimental to the animal (may also be lethal) and is usually rare.

▼ B

Variation/Minor abnormality: structural change considered to have little or no detrimental effect on the animal; may be transient and may occur relatively frequently in the control population.

Conceptus: the sum of derivatives of a fertilised ovum at any stage of development from fertilisation until birth including the extra-embryonic membranes as well as the embryo or foetus.

Implantation (nidation): attachment of the blastocyst to the epithelial lining of the uterus, including its penetration through the uterine epithelium, and its embedding in the endometrium.

Embryo: the early or developing stage of any organism, especially the developing product of fertilisation of an egg after the long axis appears and until all major structures are present.

Embryotoxicity: detrimental to the normal structure, development, growth, and/or viability of an embryo.

Foetus: the unborn offspring in the post-embryonic period.

Foetotoxicity: detrimental to the normal structure, development, growth, and/or viability of a foetus.

Abortion: the premature expulsion from the uterus of the products of conception: of the embryo or of a nonviable foetus.

Resorption: a conceptus which, having implanted in the uterus, subsequently died and is being, or has been resorbed.

Early resorption: evidence of implantation without recognisable embryo/foetus

Late resorption: dead embryo or foetus with external degenerative changes

NOAEL: abbreviation for no-observed-adverse-effect level and is the highest dose or exposure level where no adverse treatment-related findings are observed.

1.3. REFERENCE SUBSTANCE

None.

1.4. PRINCIPLE OF THE TEST METHOD

Normally, the test substance is administered to pregnant animals at least from implantation to one day prior to the day of scheduled kill, which should be as close as possible to the normal day of delivery without risking loss of data resulting from early delivery. The test method is not intended to examine solely the period of organogenesis, (e.g. days 5-15 in the rodent, and days 6-18 in the rabbit) but also effects from preimplantation, when appropriate, through the entire period of gestation to the day before caesarean section. Shortly before caesarean section, the females are killed, the uterine contents are examined, and the foetuses are evaluated for externally visible anomalies and for soft tissue and skeletal changes.

▼B

1.5. DESCRIPTION OF THE TEST METHOD

1.5.1. **Selection of animal species**

It is recommended that testing be performed in the most relevant species, and that laboratory species and strains which are commonly used in prenatal developmental toxicity testing be employed. The preferred rodent species is the rat and the preferred non-rodent species is the rabbit. Justification should be provided if another species is used.

1.5.2. **Housing and feeding conditions**

The temperature in the experimental animal room should be 22 °C ($\pm 3^\circ$) for rodents and 18 °C ($\pm 3^\circ$) for rabbits. Although the relative humidity should be at least 30 % and preferably not exceed 70 % other than during room cleaning, the aim should be 50-60 %. Lighting should be artificial, the sequence being 12 hours light, 12 hours dark. For feeding, conventional laboratory diets may be used with an unlimited supply of drinking water.

Mating procedures should be carried out in cages suitable for the purpose. While individual housing of mated animals is preferred, group housing in small numbers is also acceptable.

1.5.3. **Preparation of the animals**

Healthy animals, which have been acclimated to laboratory conditions for at least five days and have not been subjected to previous experimental procedures, should be used. The test animals should be characterised as to species, strain, source, sex, weight and/or age. The animals of all test groups should, as nearly as practicable, be of uniform weight and age. Young adult nulliparous female animals should be used at each dose level. The females should be mated with males of the same species and strain, and the mating of siblings should be avoided. For rodents day 0 of gestation is the day on which a vaginal plug and/or sperm are observed; for rabbits day 0 is usually the day of coitus or of artificial insemination, if this technique is used. Mated females should be assigned in an unbiased manner to the control and treatment groups. Cages should be arranged in such a way that possible effects due to cage placement are minimised. Each animal should be assigned a unique identification number. Mated females should be assigned in an unbiased manner to the control and treatment groups, and if the females are mated in batches, the animals in each batch should be evenly distributed across the groups. Similarly, females inseminated by the same male should be evenly distributed across the groups.

1.6. PROCEDURE

1.6.1. **Number and sex of animals**

Each test and control group should contain a sufficient number of females to result in approximately 20 female animals with implantation sites at necropsy. Groups with fewer than 16 animals with implantation sites may be inappropriate. Maternal mortality does not necessarily invalidate the study providing it does not exceed approximately 10 %.

▼B**1.6.2. Preparation of doses**

If a vehicle or other additive is used to facilitate dosing, consideration should be given to the following characteristics: effects on the absorption, distribution, metabolism, and retention or excretion of the test substance; effects on the chemical properties of the test substance which may alter its toxic characteristics; and effects on the food or water consumption or the nutritional status of the animals. The vehicle should neither be developmentally toxic nor have effects on reproduction.

1.6.3. Dosage

Normally, the test substance should be administered daily from implantation (e.g. day 5 post mating) to the day prior to scheduled caesarean section. If preliminary studies, when available, do not indicate a high potential for preimplantation loss, treatment may be extended to include the entire period of gestation, from mating to the day prior to scheduled kill. It is well known that inappropriate handling or stress during pregnancy can result in prenatal loss. To guard against prenatal loss from factors which are not treatment related, unnecessary handling of pregnant animals as well as stress from outside factors such as noise should be avoided.

At least three dose levels and a concurrent control should be used. Healthy animals should be assigned in an unbiased manner to the control and treatment groups. The dose levels should be spaced to produce a gradation of toxic effects. Unless limited by the physical/chemical nature or biological properties of the test substance, the highest dose should be chosen with the aim to induce some developmental and/or maternal toxicity (clinical signs or a decrease in body weight) but not death or severe suffering. At least one intermediate dose level should produce minimal observable toxic effects. The lowest dose level should not produce any evidence of either maternal or developmental toxicity. A descending sequence of dose levels should be selected with a view to demonstrating any dosage-related response and no-observed-adverse-effect level (NOAEL). Two- to four-fold intervals are frequently optimal for setting the descending dose levels, and the addition of a fourth test group is often preferable to using very large intervals (e.g. more than a factor of 10) between dosages. Although establishment of a maternal NOAEL is the goal, studies which do not establish such a level may also be acceptable (1).

Dose levels should be selected taking into account any existing toxicity data as well as additional information on metabolism and toxicokinetics of the test substance or related materials. This information will also assist in demonstrating the adequacy of the dosing regimen.

A concurrent control group should be used. This group should be a sham-treated control group or a vehicle-control group if a vehicle is used in administering the test substance. All groups should be administered the same volume of either test substance or vehicle. Animals in the control group(s) should be handled in an identical manner to test group animals. Vehicle control groups should receive the vehicle in the highest amount used (as in the lowest treatment group).

▼B**1.6.4. Limit test**

If a test at one dose level of at least 1 000 mg/kg body weight/day by oral administration, using the procedures described for this study, produces no observable toxicity in either pregnant animals or their progeny and if an effect would not be expected based upon existing data (e.g. from structurally and/or metabolically related compounds), then a full study using three dose levels may not be considered necessary. Expected human exposure may indicate the need for a higher oral dose level to be used in the limit test. For other types of administration, such as inhalation or dermal application, the physico-chemical properties of the test substance often may indicate and limit the maximum attainable level of exposure (for example, dermal application should not cause severe local toxicity).

1.6.5. Administration of doses

The test substance or vehicle is usually administered orally by intubation. If another route of administration is used, the tester should provide justification and reasoning for its selection, and appropriate modifications may be necessary (2)(3)(4). The test substance should be administered at approximately the same time each day.

The dose to individual animals should normally be based on the most recent individual body weight determination. However, caution should be exercised when adjusting the dose during the last trimester of pregnancy. Existing data should be used for dose selection to prevent excess maternal toxicity. However, if excess toxicity is noted in the treated dams, those animals should be humanely killed. If several pregnant animals show signs of excess toxicity, consideration should be given to terminating that dose group. When the substance is administered by gavage, this should preferably be given as a single dose to the animals using a stomach tube or a suitable intubation canula. The maximum volume of liquid that can be administered at one time depends on the size of the test animal. The volume should not exceed 1 ml/100 g body weight, except in the case of aqueous solutions where 2 ml/100 g body weight may be used. When corn oil is used as a vehicle, the volume should not exceed 0.4 ml/100 g body weight. Variability in test volume should be minimised by adjusting the concentrations to ensure a constant volume across all dose levels.

1.6.6. Observations of the dams

Clinical observations should be made and recorded at least once a day, preferably at the same time(s) each day taking into consideration the peak period of anticipated effects after dosing. The condition of the animals should be recorded including mortality, moribundity, pertinent behavioural changes, and all signs of overt toxicity.

1.6.7. Body weight and food consumption

Animals should be weighed on day 0 of gestation or no later than day 3 of gestation if time-mated animals are supplied by an outside breeder, on the first day of dosing, at least every three days during the dosing period and on the day of scheduled kill.

▼B

Food consumption should be recorded at three-day intervals and should coincide with days of body weight determination.

1.6.8. Post-mortem examination

Females should be killed one day prior to the expected day of delivery. Females showing signs of abortion or premature delivery prior to scheduled kill should be killed and subjected to a thorough macroscopic examination.

At the time of termination or death during the study, the dam should be examined macroscopically for any structural abnormalities or pathological changes. Evaluation of the dams during caesarean section and subsequent foetal analyses should be conducted preferably without knowledge of treatment group in order to minimise bias.

1.6.9. Examination of uterine contents

Immediately after termination or as soon as possible after death, the uteri should be removed and the pregnancy status of the animals ascertained. Uteri that appear non gravid should be further examined (e.g. by ammonium sulphide staining for rodents and Salewski staining or a suitable alternative method for rabbits) to confirm the non-pregnant status (5).

Gravid uteri including the cervix should be weighed. Gravid uterine weights should not be obtained from animals found dead during the study.

The number of corpora lutea should be determined for pregnant animals.

The uterine contents should be examined for numbers of embryonic or foetal deaths and viable foetuses. The degree of resorption should be described in order to estimate the relative time of death of the conceptus (see Section 1.2).

1.6.10. Examination of foetuses

The sex and body weight of each foetus should be determined.

Each foetus should be examined for external alterations (6).

Foetuses should be examined for skeletal and soft tissue alterations (e.g. variations and malformations or anomalies) (7)(8)(9)(10)(11)(12)(13)(14)(15)(16)(17)(18)(19)(20)(21)(22)(23)(24). Categorisation of foetal alterations is preferable but not required. When categorisation is done, the criteria for defining each category should be clearly stated. Particular attention should be paid to the reproductive tract which should be examined for signs of altered development.

For rodents, approximately one-half of each litter should be prepared and examined for skeletal alterations. The remainder should be prepared and examined for soft tissue alterations, using accepted or appropriate serial sectioning methods or careful gross dissection techniques.

▼B

For non-rodents, e.g. rabbits, all fetuses should be examined for both soft tissue and skeletal alterations. The bodies of these fetuses are evaluated by careful dissection for soft tissue alterations, which may include procedures to further evaluate internal cardiac structure (25). The heads of one-half of the fetuses examined in this manner should be removed and processed for evaluation of soft tissue alterations (including eyes, brain, nasal passages and tongue), using standard serial sectioning methods (26) or an equally sensitive method. The bodies of these fetuses and the remaining intact fetuses should be processed and examined for skeletal alterations, utilising the same methods as described for rodents.

2. DATA**2.1. TREATMENT OF RESULTS**

Data shall be reported individually for the dams as well as for their offspring and summarised in tabular form, showing for each test group and each generation the number of animals at the start of the test, the number of animals found dead during the test or killed for humane reasons, the time of any death or humane kill, the number of pregnant females, the number of animals showing signs of toxicity, a description of the signs of toxicity observed, including time of onset, duration, and severity of any toxic effects, the types of embryo/foetal observations, and all relevant litter data.

Numerical results should be evaluated by an appropriate statistical method using the litter as the unit for data analysis. A generally accepted statistical method should be used; the statistical methods should be selected as part of the design of the study and should be justified. Data from animals that do not survive to the scheduled kill should also be reported. These data may be included in group means where relevant. Relevance of the data obtained from such animals, and therefore inclusion or exclusion from any group mean(s), should be justified and judged on an individual basis.

2.2. EVALUATION OF RESULTS

The findings of the Prenatal Developmental Toxicity Study should be evaluated in terms of the observed effects. The evaluation will include the following information:

— maternal and embryo/foetal test results, including the evaluation of the relationship, or lack thereof, between the exposure of the animals to the test substance and the incidence and severity of all findings,

— criteria used for categorising foetal external, soft tissue, and skeletal alterations if categorisation has been done,

▼ B

- when appropriate, historical control data to enhance interpretation of study results,
- the numbers used in calculating all percentages or indices,
- adequate statistical analysis of the study findings, when appropriate, which should include sufficient information on the method of analysis, so that an independent reviewer/statistician can re-evaluate and reconstruct the analysis.

In any study which demonstrates the absence of any toxic effects, further investigations to establish absorption and bioavailability of the test substance should be considered.

2.3. INTERPRETATION OF RESULTS

A prenatal developmental toxicity study will provide information on the effects of repeated exposure to a substance during pregnancy on the dams and on the intrauterine development of their progeny. The results of the study should be interpreted in conjunction with the findings from subchronic, reproduction, toxicokinetic and other studies. Since emphasis is placed both on general toxicity in terms of maternal toxicity and on developmental toxicity endpoints, the results of the study will allow to a certain extent for the discrimination between developmental effects occurring in the absence of general toxicity and those which are only induced at levels that are also toxic to the maternal animal (27).

3. REPORTING

3.1. TEST REPORT

The test report must include the following specific information:

Test substance:

- physical nature and, where relevant, physicochemical properties,
- identification including CAS number if known/established,
- purity.

Vehicle (if appropriate):

- justification for choice of vehicle, if other than water.

Test animals:

- species and strain used,
- number and age of animals,
- source, housing conditions, diet, etc.,
- individual weights of animals at the start of the test.

Test conditions:

- rationale for dose level selection,
- details of test substance formulation/diet preparation, achieved concentration, stability and homogeneity of the preparation,

▼ B

- details of the administration of the test substance,
- conversion from diet/drinking water test substance concentration (ppm) to the actual dose (mg/kg body weight/day), if applicable,
- environmental conditions,
- details of food and water quality.

Results:

Maternal toxic response data by dose, including but not limited to:

- the number of animals at the start of the test, the number of animals surviving, the number pregnant, and the number aborting, number of animals delivering early,
- day of death during the study or whether animals survived to termination,
- data from animals that do not survive to the scheduled kill should be reported but not included in the inter-group statistical comparisons,
- day of observation of each abnormal clinical sign and its subsequent course,
- body weight, body weight change and gravid uterine weight, including, optionally, body weight change corrected for gravid uterine weight,
- food consumption and, if measured, water consumption,
- necropsy findings, including uterine weight,
- NOAEL values for maternal and developmental effects should be reported.

Developmental endpoints by dose for litters with implants, including:

- number of corpora lutea,
- number of implantations, number and percent of live and dead foetuses and resorptions,
- number and percent of pre- and post-implantation losses.

Developmental endpoints by dose for litters with live foetuses, including:

- number and percent of live offspring,
- sex ratio,
- foetal body weight, preferably by sex and with sexes combined,
- external, soft tissue, and skeletal malformations and other relevant alterations,
- criteria for categorisation if appropriate,

▼B

— total number and percent of foetuses and litters with any external, soft tissue, or skeletal alteration, as well as the types and incidences of individual anomalies and other relevant alterations.

Discussion of results.

Conclusions.

4.

REFERENCES

- (1) Kavlock R.J. et al., (1996) A Simulation Study of the Influence of Study Design on the Estimation of Benchmark Doses for Developmental Toxicity. *Risk Analysis* 16; p. 399-410.
- (2) Kimmel, C.A. and Francis, E.Z., (1990) Proceedings of the Workshop on the Acceptability and Interpretation of Dermal Developmental Toxicity Studies. *Fundamental and Applied Toxicology* 14; p. 386-398.
- (3) Wong, B.A., et al., (1997) Developing Specialised Inhalation Exposure Systems to Address Toxicological Problems. *CIIT Activities* 17; p. 1-8.
- (4) US Environmental Protection Agency, (1985) Subpart E-Specific Organ/Tissue Toxicity, 40 CFR 798.4350: Inhalation Developmental Toxicity Study.
- (5) Salewski, E., (1964) Faerbermethode zum Makroskopischen Nachweis von Implantations Stellen am Uterus der Ratte. *Naunyn-Schmeidebergs Archiv für Pharmakologie und Experimentelle Pathologie*, 247, 367.
- (6) Edwards, J.A., (1968) The external Development of the Rabbit and Rat Embryo. In *Advances in Teratology*. D.H.M. Woolam (ed.) Vol. 3. Academic Press, NY.
- (7) Inouye, M. (1976) Differential Staining of Cartilage and Bone in Fetal Mouse Skeleton by Alcian Blue and Alizarin Red S. *Congenital Anomalies* 16, p. 171-173.
- (8) Igarashi, E. et al., (1992) Frequency Of Spontaneous Axial Skeletal Variations Detected by the Double Staining Technique for Ossified and Cartilaginous Skeleton in Rat Foetuses. *Congenital Anomalies* 32, p. 381-391.
- (9) Kimmel, C.A. et al. (1993) Skeletal Development Following Heat Exposure in the Rat. *Teratology*, 47 p.229-242.
- (10) Marr, M.C. et al. (1988) Comparison of Single and Double Staining for Evaluation of Skeletal Development: The Effects of Ethylene Glycol (EG) in CD Rats. *Teratology* 37; 476.
- (11) Barrow, M.V. and Taylor, W.J. (1969) A Rapid Method for Detecting Malformations in Rat Foetuses. *Journal of Morphology*, 127, p. 291-306.
- (12) Fritz, H. (1974) Prenatal Ossification in Rabbits as Indicative of Foetal Maturity. *Teratology*, 11 p. 313-320.
- (13) Gibson, J.P. et al. (1966) Use of the Rabbit in Teratogenicity Studies. *Toxicology and Applied Pharmacology*, 9, p. 398-408.
- (14) Kimmel, C.A. and Wilson, J.G. (1973) Skeletal Deviation in Rats: Malformations or Variations? *Teratology*, 8, p. 309-316.
- (15) Marr, M.C. et al. (1992) Developmental Stages of the CD (Sprague-Dawley) Rat Skeleton after Maternal Exposure to Ethylene Glycol. *Teratology*, 46, p. 169-181.

▼B

- (16) Monie, I.W. et al. (1965) Dissection Procedures for Rat Foetuses Permitting Alizarin Red Staining of Skeleton and Histological Study of Viscera. *Supplement to Teratology Workshop Manual*, p. 163-173.
- (17) Spark, C. and Dawson, A.B. (1928) The Order and Time of appearance of Centers of Ossification in the Fore and Hind Limbs of the Albino Rat, with Special Reference to the Possible Influence of the Sex Factor. *American Journal of Anatomy*, 41, p. 411-445.
- (18) Staples, R.E. and Schnell, V.L. (1964) Refinements in Rapid Clearing Technique in the KOH-Alizarin Red S Method for Fetal Bone. *Stain Technology*, 39, p. 61-63.
- (19) Strong, R.M. (1928) The Order Time and Rate of Ossification of the Albino Rat (*Mus Norvegicus Albinus*) Skeleton. *American Journal of Anatomy*, 36, p. 313-355.
- (20) Stuckhardt, J.L. and Poppe, S.M. (1984) Fresh Visceral Examination of Rat and Rabbit Foetuses Used in Teratogenicity Testing. *Teratogenesis, Carcinogenesis, and Mutagenesis*, 4, p. 181-188.
- (21) Walker, D.G. and Wirtschafter, Z.T. (1957) *The Genesis of the Rat Skeleton*. Thomas, Springfield, IL.
- (22) Wilson, J.G. (1965) Embryological Considerations in Teratology. In *Teratology: Principles and Techniques*, Wilson J.G. and Warkany J. (eds). University of Chicago, Chicago, IL, p. 251-277.
- (23) Wilson, J.G. and Fraser, F.C. (eds). (1977) *Handbook of Teratology*, Vol. 4. Plenum, NY.
- (24) Varnagy, L. (1980) Use of Recent Fetal Bone Staining Techniques in the Evaluation of Pesticide Teratogenicity. *Acta Vet. Acad. Sci. Hung*, 28, p. 233-239.
- (25) Staples, R.E. (1974) Detection of visceral Alterations in Mammalian Foetuses. *Teratology*, 9, p. 37-38.
- (26) Van Julsingha, E.B. and C.G. Bennett (1977) A Dissecting Procedure for the Detection of Anomalies in the Rabbit Foetal Head. In: *Methods in Prenatal Toxicology* Neubert, D., Merker, H.J. and Kwasigroch, T.E. (eds.). University of Chicago, Chicago, IL, p. 126-144.
- (27) US Environmental Protection Agency (1991) Guidelines for Developmental Toxicity Risk Assessment. *Federal Register*, 56, p. 63798-63826.
- (28) Wise, D.L. et al. (1997) Terminology of Developmental Abnormalities in Common Laboratory Mammals (Version 1) *Teratology*, 55, p. 249-292.

▼ M4**B.32. CARCINOGENICITY STUDIES**

INTRODUCTION

1. This Test Method is equivalent to OECD Test Guideline (TG) 451 (2009). The original TG 451 on Carcinogenicity Studies was adopted in 1981. Development of this revised Test Method B.32 was considered necessary, in order to reflect recent developments in the field of animal welfare and regulatory requirements (2) (3) (4) (5) (6). The updating of this Test Method B.32 has been carried out in parallel with revisions of Chapter B.30 of this Annex, Chronic Toxicity Studies, and Chapter B.33, of this Annex, Combined Chronic Toxicity\Carcinogenicity Studies, and with the objective of obtaining additional information from the animals used in the study and providing further detail on dose selection. This Test Method B.32 is designed to be used in the testing of a broad range of chemicals, including pesticides and industrial chemicals. It should be noted however that some details and requirements may differ for pharmaceuticals (see International Conference on Harmonisation (ICH) Guidance S1B on Testing for Carcinogenicity of Pharmaceuticals).

2. The majority of carcinogenicity studies are carried out in rodent species, and this Test Method is intended therefore to apply primarily to studies carried out in these species. Should such studies be required in non-rodent species, the principles and procedures outlined in this Test Method together with those outlined in Chapter B.27 of this Annex, Repeated Dose 90-day Oral Toxicity Study in Non-Rodents (6), should be applied, with appropriate modifications. Further guidance is available in the OECD Guidance Document No 116 on the Design and Conduct of Chronic Toxicity and Carcinogenicity Studies (7).

3. The three main routes of administration used in carcinogenicity studies are oral, dermal and inhalation. The choice of the route of administration depends on the physical and chemical characteristics of the test chemical and the predominant route of exposure of humans. Additional information on choice of route of exposure is provided in Guidance Document No 116 (7).

4. This Test Method focuses on exposure via the oral route, the route most commonly used in carcinogenicity studies. While carcinogenicity studies involving exposure via the dermal or inhalation routes may also be necessary for human health risk assessment and/or may be required under certain regulatory regimes, both routes of exposure involve considerable technical complexity. Such studies will need to be designed on a case-by-case basis, although the Test Method outlined here for the assessment and evaluation of carcinogenicity by oral administration could form the basis of a protocol for inhalation and/or dermal studies, with respect to recommendations for treatment periods, clinical and pathology parameters, etc. OECD Guidance is available on the administration of test chemicals by the dermal (7), and inhalation routes (7) (8). Chapter B.8 of this Annex (9) and Chapter B.29 of this Annex (10), together with the OECD Guidance Document on acute inhalation testing (8), should be specifically consulted in the design of longer term studies involving exposure via the inhalation route. Chapter B.9 of this Annex (11) should be consulted in the case of testing carried out by the dermal route.

▼ M4

5. The carcinogenicity study provides information on the possible health hazards likely to arise from repeated exposure for a period lasting up to the entire lifespan of the species used. The study will provide information on the toxic effects of the test chemical including potential carcinogenicity, and may indicate target organs and the possibility of accumulation. It can provide an estimate of the no-observed-adverse effect level for toxic effects and, in the case of non-genotoxic carcinogens, for tumour responses, which can be used for establishing safety criteria for human exposure. The need for careful clinical observations of the animals, so as to obtain as much information as possible, is also stressed.

6. The objectives of carcinogenicity studies covered by this Test Method include:
 - The identification of the carcinogenic properties of a test chemical, resulting in an increased incidence of neoplasms, increased proportion of malignant neoplasms or a reduction in the time to appearance of neoplasms, compared with concurrent control groups;

 - The identification of target organ(s) of carcinogenicity;

 - The identification of the time to appearance of neoplasms;

 - Characterisation of the tumour dose-response relationship;

 - Identification of a no-observed-adverse-effect level (NOAEL) or point of departure for establishment of a Benchmark Dose (BMD);

 - Extrapolation of carcinogenic effects to low dose human exposure levels;

 - Provision of data to test hypotheses regarding mode of action (2) (7) (12) (13) (14) (15).

INITIAL CONSIDERATIONS

7. In the assessment and evaluation of the potential carcinogenicity of a test chemical, all available information on the test chemical should be considered by the testing laboratory prior to conducting the study, in order to focus the design of the study to more efficiently test for carcinogenic potential and to minimise animal usage. Information on, and consideration of, the mode of action of a suspected carcinogen (2) (7) (12) (13) (14) (15) is particularly important, since the optimal design may differ depending on whether the test chemical is a known or suspected genotoxic carcinogen. Further guidance on mode of action considerations can be found in Guidance Document No 116 (7).

8. Information that will assist in the study design includes the identity, chemical structure, and physico-chemical properties of the test chemical; results of any *in vitro* or *in vivo* toxicity tests including genotoxicity tests; anticipated use(s) and potential for human exposure; available (Q)SAR data, mutagenicity/genotoxicity, carcinogenicity and other toxicological data on structurally-related chemicals; available toxicokinetic data (single dose and also repeat dose kinetics where available) and data derived from other repeated exposure studies. Assessment of carcinogenicity should

▼ M4

be carried out after initial information on toxicity has been obtained from repeated dose 28-day and/or 90-day toxicity tests. Short-term cancer initiation-promotion tests could also provide useful information. A phased testing approach to carcinogenicity testing should be considered as part of the overall assessment of the potential adverse health effects of a particular test chemical (16) (17) (18) (19).

9. The statistical methods most appropriate for the analysis of results, given the experimental design and objectives, should be established before commencing the study. Issues to consider include whether the statistics should include adjustment for survival, analysis of cumulative tumour risks relative to survival duration, analysis of the time to tumour and analysis in the event of premature termination of one or more groups. Guidance on the appropriate statistical analyses and key references to internationally accepted statistical methods are given in Guidance Document No 116 (7), and also in Guidance Document No 35 on the analysis and evaluation of chronic toxicity and carcinogenicity studies (20).
10. In conducting a carcinogenicity study, the guiding principles and considerations outlined in the OECD Guidance Document No 19 on the recognition, assessment, and use of clinical signs as humane endpoints for experimental animals used in safety evaluation (21), in particular paragraph 62 thereof, should always be followed. This paragraph states that *'In studies involving repeated dosing, when an animal shows clinical signs that are progressive, leading to further deterioration in condition, an informed decision as to whether or not to humanely kill the animal should be made. The decision should include consideration as to the value of the information to be gained from the continued maintenance of that animal on study relative to its overall condition. If a decision is made to leave the animal on test, the frequency of observations should be increased, as needed. It may also be possible, without adversely affecting the purpose of the test, to temporarily stop dosing if it will relieve the pain or distress, or reduce the test dose.'*
11. Detailed guidance on and discussion of the principles of dose selection for chronic toxicity and carcinogenicity studies can be found in Guidance Document No 116 (7) as well as two International Life Sciences Institute publications (22) (23). The core dose selection strategy is dependent on the primary objective or objectives of the study (paragraph 6). In selecting appropriate dose levels, a balance should be achieved between hazard screening on the one hand and characterisation of low-dose responses and their relevance on the other. This is particularly relevant in the situation where a combined chronic toxicity and carcinogenicity study (Chapter B.33 of this Annex) is to be carried out (paragraph 12).
12. Consideration should be given to carrying out a combined chronic toxicity and carcinogenicity study (Chapter B.33 of this Annex), rather than separate execution of a chronic toxicity study (Chapter B.30 of this Annex) and carcinogenicity study (this Test Method B.32). The combined test provides greater efficiency in terms of time and cost compared to conducting two separate studies, without compromising the quality of the data in either the chronic phase or the carcinogenicity phase. Careful consideration should however be given to the principles of dose selection (paragraphs 11 and 22-25) when undertaking a combined chronic toxicity and carcinogenicity study (Chapter B.33 of this Annex), and it is also recognised that separate studies may be required under certain regulatory frameworks.

▼ M4

13. Definitions used in the context of this Test Method can be found at the end of this chapter and in the Guidance Document No 116 (7).

PRINCIPLE OF THE TEST

14. The test chemical is administered daily in graduated doses to several groups of test animals for the majority of their life span, normally by the oral route. Testing by the inhalation or dermal route may also be appropriate. The animals are observed closely for signs of toxicity and for the development of neoplastic lesions. Animals which die or are killed during the test are necropsied and, at the conclusion of the test, surviving animals are killed and necropsied.

DESCRIPTION OF METHOD**Selection of animal species**

15. This Test Method primarily covers assessment and evaluation of carcinogenicity in rodents (paragraph 2). The use of non-rodent species may be considered when available data suggest that they are more relevant for the prediction of health effects in humans. The choice of species should be justified. The preferred rodent species is the rat, although other rodent species, e.g. the mouse, may be used. Although the use of the mouse in carcinogenicity testing may have limited utility (24) (25) (26), under some current regulatory programmes carcinogenicity testing in the mouse is still required unless it is determined that such a study is not scientifically necessary. Rats and mice have been preferred experimental models because of their relatively short life span, their widespread use in pharmacological and toxicological studies, their susceptibility to tumour induction, and the availability of sufficiently characterised strains. As a consequence of these characteristics, a large amount of information is available on their physiology and pathology. Additional information on choice of species and strain is provided in Guidance Document No 116 (7).
16. Young healthy adult animals of commonly used laboratory strains should be employed. The carcinogenicity study should preferably be carried out in animals from the same strain and source as those used in preliminary toxicity study(ies) of shorter duration although, if animals from this strain and source are known to present problems in achieving the normally accepted criteria of survival for long-term studies [see Guidance Document No 116 (7)], consideration should be given to using a strain of animal that has an acceptable survival rate for the long-term study. The females should be nulliparous and non-pregnant.

Housing and feeding

17. Animals may be housed individually, or be caged in small groups of the same sex; individual housing should be considered only if scientifically justified (27) (28) (29). Cages should be arranged in such a way that possible effects due to cage placement are minimised. The temperature in the experimental animal room should be 22 °C (\pm 3 °C). Although the relative humidity should be at least 30 % and preferably not exceed 70 % other than during room cleaning, the aim should be 50-60 %. Lighting should be artificial, the sequence being 12 hours light, 12 hours dark. For feeding, conventional laboratory diets may be used with an unlimited supply of drinking water. The diet should meet all the nutritional requirements of the species tested and the content of dietary contaminants, including but not limited to pesticide residues, persistent organic pollutants,

▼ M4

phytoestrogens, heavy metals and mycotoxins, that might influence the outcome of the test, should be as low as possible. Analytical information on the nutrient and dietary contaminant levels should be generated periodically, at least at the beginning of the study and when there is a change in the batch used, and should be included in the final report. Analytical information on the drinking water used in the study should similarly be provided. The choice of diet may be influenced by the need to ensure a suitable admixture of a test chemical and to meet the nutritional requirements of the animals when the test chemical is administered by the dietary route.

Preparation of animals

18. Healthy animals, which have been acclimated to laboratory conditions for at least 7 days and have not been subjected to previous experimental procedures, should be used. In the case of rodents, dosing of the animals should begin as soon as possible after weaning and acclimatisation and preferably before the animals are 8 weeks old. The test animals should be characterised as to species, strain, source, sex, weight and age. At the commencement of the study, the weight variation for each sex of animal used should be minimal and not exceed $\pm 20\%$ of the mean weight of all the animals within the study, separately for each sex. Animals should be randomly assigned to the control and treatment groups. After randomisation, there should be no significant differences in mean body weights between groups within each sex. If there are statistically significant differences, then the randomisation step should be repeated, if possible. Each animal should be assigned a unique identification number, and permanently marked with this number by tattooing, microchip implant, or other suitable method.

PROCEDURE**Number and sex of animals**

19. Both sexes should be used. A sufficient number of animals should be used so that a thorough biological and statistical evaluation is possible. Each dose group and concurrent control group should therefore contain at least 50 animals of each sex. Depending on the aim of the study, it may be possible to increase the statistical power of the key estimates by differentially allocating animals unequally to the various dose groups, with more than 50 animals in the low dose groups; e.g. to estimate the carcinogenic potential at low doses. However it should be recognised that a moderate increase in group size will provide relatively little increase in statistical power of the study. Further information on statistical design of the study and choice of dose levels to maximise statistical power is provided in Guidance Document No 116 (7).

Provision for interim kills and satellite (sentinel) groups

20. The study may make provision for interim kills, e.g. at 12 months, to provide information on progression of neoplastic changes and mechanistic information, if scientifically justified. Where such information is already available from previous repeat dose toxicity studies on the test chemical, interim kills may not be scientifically justified. If interim kills are included in the study design, the number of animals in each dose group scheduled for an interim kill will normally be 10 animals per sex, and the total number of animals included in the study design should be increased by the number of animals scheduled to be killed before the completion of the study. An additional group of sentinel animals (typically 5 animals per sex) may be included for monitoring of disease status, if necessary, during the study (30). Further guidance is provided in Guidance Document No 116 (7).

▼ M4**Dose groups and dosage**

21. Guidance on all aspects of dose selection and dose level spacing is provided in Guidance Document No 116 (7). At least three dose levels and a concurrent control should be used. Dose levels will generally be based on the results of shorter-term repeated dose or range finding studies and should take into account any existing toxicological and toxicokinetic data available for the test chemical or related chemicals.

22. Unless limited by the physical-chemical nature or biological effects of the test chemical, the highest dose level should be chosen to identify the principal target organs and toxic effects while avoiding suffering, severe toxicity, morbidity, or death. While taking into account the factors outlined in paragraph 23 below, the highest dose level should normally be chosen to elicit evidence of toxicity, as evidenced by, for example, depression of body weight gain (approximately 10 %). However, dependent on the objectives of the study (see paragraph 6), a top dose lower than the dose providing evidence of toxicity may be chosen, e.g. if a dose elicits an adverse effect of concern that nonetheless has little impact on lifespan or body weight.

23. Dose levels and dose level spacing may be selected to establish a dose-response and, depending on the mode of action of the test chemical, a NOAEL or other intended outcome of the study, e.g. a BMD (see paragraph 25) at the lowest dose level. Factors that should be considered in the placement of lower doses include the expected slope of the dose-response curve, the doses at which important changes may occur in metabolism or mode of toxic action, where a threshold is expected, or where a point of departure for low-dose extrapolation is expected.

24. The dose level spacing selected will depend on the characteristics of the test chemical, and cannot be prescribed in this Test Method, but two to four fold intervals frequently provide good test performance for setting the descending dose levels and addition of a fourth test group is often preferable to using very large intervals (e.g. more than a factor of about 6-10) between dosages. In general, the use of factors greater than 10 should be avoided, and should be justified if used.

25. As discussed further in Guidance Document No 116 (7), points to be considered in dose selection include:
 - Known or suspected nonlinearities or inflection points in the dose-response;

 - Toxicokinetics, and dose ranges where metabolic induction, saturation, or nonlinearity between external and internal doses does or does not occur;

 - Precursor lesions, markers of effect, or indicators of the operation of key underlying biological processes;

 - Key (or suspected) aspects of mode of action, such as doses at which cytotoxicity begins to arise, hormone levels are perturbed, homeostatic mechanisms are overwhelmed, etc.;

▼ M4

- Regions of the dose–response curve where particularly robust estimation is needed, e.g. in the range of the anticipated BMD or a suspected threshold;

 - Consideration of anticipated human exposure levels.
26. The control group shall be an untreated group or a vehicle-control group if a vehicle is used in administering the test chemical. Except for treatment with the test chemical, animals in the control group should be handled in an identical manner to those in the test groups. If a vehicle is used, the control group shall receive the vehicle in the highest volume used among the dose groups. If a test chemical is administered in the diet, and causes significantly reduced dietary intake due to the reduced palatability of the diet, an additional pair-fed control group may be useful, to serve as a more suitable control.

Preparation of doses and administration of test chemical

27. The test chemical is normally administered orally, via the diet or drinking water, or by gavage. Additional information on routes and methods of administration is provided in Guidance Document No 116 (7). The route and method of administration is dependent on the purpose of the study, the physical-chemical properties of the test chemical, its bioavailability and the predominant route and method of exposure of humans. A rationale should be provided for the chosen route and method of administration. In the interest of animal welfare, oral gavage should normally be selected only for those agents, for which this route and method of administration reasonably represent potential human exposure (e.g. pharmaceuticals). For dietary or environmental chemicals including pesticides, administration is typically via the diet or drinking water. However, for some scenarios, e.g. occupational exposure, administration via other routes may be more appropriate.
28. Where necessary, the test chemical is dissolved or suspended in a suitable vehicle. Consideration should be given to the following characteristics of the vehicle and other additives, as appropriate: effects on the absorption, distribution, metabolism, or retention of the test chemical; effects on the chemical properties of the test chemical which may alter its toxic characteristics; and effects on the food or water consumption or the nutritional status of the animals. It is recommended that, wherever possible, the use of an aqueous solution/suspension be considered first, followed by consideration of a solution/emulsion in oil (e.g. corn oil) and then by possible solution in other vehicles. For vehicles other than water, the toxic characteristics of the vehicle should be known. Information should be available on the stability of the test chemical and the homogeneity of dosing solutions or diets (as appropriate) under the conditions of administration (e.g. diet).
29. For chemicals administered via the diet or drinking water it is important to ensure that the quantities of the test chemical involved do not interfere with normal nutrition or water balance. In long-term toxicity studies using dietary administration, the concentration of the test chemical in the feed should not normally exceed an upper limit of 5 % of the total diet, in order to avoid nutritional imbalances. When the test chemical is administered in the diet, either a constant dietary concentration (mg/kg diet or ppm) or a constant dose level in terms of the animal's body weight (mg/kg body weight), calculated on a weekly basis, may be used. The alternative used should be specified.

▼ M4

30. In the case of oral administration, the animals are dosed with the test chemical daily (seven days per week), normally for a period of 24 months for rodents (see also paragraph 32). Any other dosing regime, e.g. five days per week, needs to be justified. In the case of dermal administration, animals are normally treated with the test chemical for at least 6 hours per day, 7 days per week, as specified in Chapter B.9 of this Annex (11), for a period of 24 months. Exposure by the inhalation route is carried out for 6 hours per day, 7 days per week, but exposure for 5 days per week may also be used, if justified. The period of exposure will normally be for a period of 24 months. If rodent species other than rats are exposed nose-only, maximum exposure durations may be adjusted to minimise species-specific distress. A rationale should be provided when using an exposure duration of less than 6 hours per day. See also Chapter B.8 of this Annex (9).
31. When the test chemical is administered by gavage to the animals, this should be done using a stomach tube or a suitable intubation cannula, at similar times each day. Normally a single dose will be administered once daily; where for example a chemical is a local irritant, it may be possible to maintain the daily dose-rate by administering it as a split dose (twice a day). The maximum volume of liquid that can be administered at one time depends on the size of the test animal. The volume should be kept as low as practical, and should not normally exceed 1 ml/100g body weight for rodents (31). Variability in test volume should be minimised by adjusting the concentration to ensure a constant volume at all dose levels. Potentially corrosive or irritant chemicals are the exception, and need to be diluted to avoid severe local effects. Testing at concentrations that are likely to be corrosive or irritant to the gastrointestinal tract should be avoided.

Duration of study

32. The duration of the study will normally be 24 months for rodents, representing the majority of the normal life span of the animals to be used. Shorter or longer study durations may be used, dependent on the lifespan of the strain of the animal species in the study, but should be justified. For specific strains of mice, e.g. AKR/J, C3H/J or C57BL/6J strains a duration of 18 months may be more appropriate. The following provides some guidance on duration, termination of the study and survival; further guidance, including consideration of the acceptability of a negative carcinogenicity relative to survival in the study, is provided in the OECD Guidance Document No 116 on the Design and Conduct of Chronic Toxicity and Carcinogenicity Studies (7).

— Termination of the study should be considered when the number of survivors in the lower dose groups or the control group falls below 25 per cent.

— In the case where only the high dose group dies prematurely due to toxicity, this should not trigger termination of the study.

— Survival of each sex should be considered separately.

— The study should not be extended beyond the point when the data available from the study are no longer sufficient to enable a statistically valid evaluation to be made.

▼ M4

OBSERVATIONS

33. All animals should be checked for morbidity or mortality, usually at the beginning and the end of each day, including at weekends and holidays. Animals should additionally be checked once a day for specific signs of toxicological relevance, taking into consideration the peak period of anticipated effects after dosing in the case of gavage administration. Particular attention should be paid to tumour development; and the time of tumour onset, location, dimensions, appearance, and progression of each grossly visible or palpable tumour should be recorded.

Body weight, food/water consumption and food efficiency

34. All animals should be weighed at the start of treatment, at least once a week for the first 13 weeks and at least monthly thereafter. Measurements of food consumption and food efficiency should be made at least weekly for the first 13 weeks and at least monthly thereafter. Water consumption should be measured at least weekly for the first 13 weeks and at least monthly thereafter when the test chemical is administered in drinking water. Water consumption measurements should also be considered for studies in which drinking activity is altered.

Haematology, clinical biochemistry and other measurements

35. In order to maximise the information obtained from the study, especially for mode of action considerations, blood samples may be taken for haematology and clinical biochemistry, and this at the discretion of the study director. Urinalysis may also be appropriate. Further guidance on the value of taking such samples as part of a carcinogenicity study is provided in Guidance Document No 116 (7). If considered appropriate, blood sampling for haematological and clinical chemistry determinations and urinalysis may be conducted as part of an interim kill (paragraph 20) and at study termination on a minimum of 10 animals per sex per group. Blood samples should be taken from a named site, for example by cardiac puncture or from the retro-orbital sinus under anaesthesia, and stored, if applicable, under appropriate conditions. Blood smears may also be prepared for examination, particularly if bone marrow appears to be the target organ, although the value of such examination for the assessment of carcinogenic/oncogenic potential has been questioned (32).

PATHOLOGY

Gross necropsy

36. All animals in the study except sentinel animals (see paragraph 20) and other satellite animals should be subjected to a full, detailed gross necropsy which includes careful examination of the external surface of the body, all orifices, and the cranial, thoracic and abdominal cavities and their contents. Sentinel animals and other satellite animals may require necropsy on a case-by-case basis, at the discretion of the study director. Organ weights are not normally part of a carcinogenesis study, since geriatric changes and, at later stages, the development of tumours confounds the usefulness of organ weight data. They may, however, be critical to performing a weight of evidence evaluation and especially for mode of action considerations. If they are part of a satellite study, they should be collected at no later than one year after initiation of the study.

▼ **M4**

37. The following tissues should be preserved in the most appropriate fixation medium for both the type of tissue and the intended subsequent histopathological examination (33) (tissues in square brackets are optional):

all gross lesions	heart	pancreas	stomach (forestomach, glandular stomach)
adrenal gland	ileum	parathyroid gland	[teeth]
aorta	jejunum	peripheral nerve	testis
brain (including sections of cerebrum, cerebellum, and medulla/pons)	kidney	pituitary	thymus
caecum	lacrimal gland (exorbital)	prostate	thyroid
cervix	liver	rectum	[tongue]
coagulating gland	lung	salivary gland	trachea
colon	lymph nodes (both superficial and deep)	seminal vesicle	urinary bladder
duodenum	mammary gland (obligatory for females and, if visibly dissectable, from males)	skeletal muscle	uterus (including cervix)
epididymis	[upper respiratory tract, including nose, turbinates, and paranasal sinuses]	skin	[ureter]
eye (including retina)	oesophagus	spinal cord (at three levels: cervical, mid-thoracic, and lumbar)	[urethra]
[femur with joint]	[olfactory bulb]	spleen	vagina
gall bladder (for species other than rat)	ovary	[sternum],	section of bone marrow and/or a fresh bone marrow aspirate
Harderian gland			

In the case of paired organs, e.g. kidney, adrenal, both organs should be preserved. The clinical and other findings may suggest the need to examine additional tissues. Also, any organs considered likely to be target organs based on the known properties of the test chemical should be preserved. In studies involving the dermal route of administration, the list of organs as set out for the oral route should be preserved, and specific sampling and preservation of the skin from the site of application is essential. In inhalation studies, the list of preserved and examined tissues from the respiratory tract should follow the recommendations of Chapters B.8 and B.29 of this Annex. For other organs/tissues (and in addition to the specifically preserved tissues from the respiratory tract) the list of organs as set out for the oral route should be examined.

▼ M4*Histopathology*

38. Guidance is available on best practices in the conduct of toxicological pathology studies (33). The minimum tissues examined should be:
- All tissues from the high dose and control groups;
 - All tissues of animals dying or killed during the study;
 - All tissues showing macroscopic abnormalities including tumours;
 - When treatment-related histopathological changes are observed in the high dose group, those same tissues are to be examined from all animals in all other dose groups;
 - In the case of paired organs, e.g. kidney, adrenal, both organs should be examined.

DATA AND REPORTING

Data

39. Individual animal data should be provided for all parameters evaluated. Additionally, all data should be summarised in tabular form showing for each test group the number of animals at the start of the test, the number of animals found dead during the test or killed for humane reasons and the time of any death or humane kill, the number showing signs of toxicity, a description of the signs of toxicity observed, including time of onset, duration, and severity of any toxic effects, the number of animals showing lesions, the type of lesions and the percentage of animals displaying each type of lesion. Summary data tables should provide the means and standard deviations (for continuous test data) of animals showing toxic effects or lesions, in addition to the grading of lesions.
40. Historical control data may be valuable in the interpretation of the results of the study, e.g. in the case when there are indications that the data provided by the concurrent controls are substantially out of line when compared to recent data from control animals from the same test facility/colony. Historical control data, if evaluated, should be submitted from the same laboratory and relate to animals of the same age and strain generated during the five years preceding the study in question.
41. When applicable, numerical results should be evaluated by an appropriate and generally acceptable statistical method. The statistical methods and the data to be analysed should be selected during the design of the study (paragraph 9). Selection should make provision for survival adjustments, if needed.

Test report

42. The test report should include the following information:

Test chemical:

- physical nature, purity, and physicochemical properties;
- identification data;

▼ M4

- source of chemical;
- batch number;
- certificate of chemical analysis;

Vehicle (if appropriate):

- justification for choice of vehicle (if other than water);

Test animals:

- species/strain used and justification for choice made;
- number, age, and sex of animals at start of test;
- source, housing conditions, diet, etc.;
- individual weights of animals at the start of the test;

Test conditions:

- rationale for route of administration and dose selection;
- when applicable, the statistical methods used to analyse the data;
- details of test chemical formulation/diet preparation.
- analytical data on achieved concentration, stability and homogeneity of the preparation;
- route of administration and details of the administration of the test chemical;
- for inhalation studies, whether nose only or whole body;
- actual doses (mg/kg body weight/day), and conversion factor from diet/drinking water test chemical concentration (mg/kg or ppm) to the actual dose, if applicable;
- details of food and water quality;

*Results (summary tabulated data and individual animal data should be presented)**General*

- survival data;
- body weight/body weight changes;
- food consumption, calculations of food efficiency, if made, and water consumption, if applicable;
- toxicokinetic data (if available);
- ophthalmoscopy (if available);
- haematology (if available);
- clinical chemistry (if available);

▼ M4*Clinical findings*

- Signs of toxicity;
- Incidence (and, if scored, severity) of any abnormality;
- Nature, severity, and duration of clinical observations (whether transitory or permanent);

Necropsy data

- Terminal body weight;
- Organ weights and their ratios, if applicable;
- Necropsy findings; Incidence and severity of abnormalities;

Histopathology

- Non neoplastic histopathological findings,;
- Neoplastic histopathological findings;
- Correlation between gross and microscopic findings;
- Detailed description of all treatment-related histopathological findings including severity gradings;
- Report of any peer review of slides;

*Statistical treatment of results, as appropriate**Discussion of results including*

- Discussion of any modelling approaches;
- Dose-response relationships;
- Historical control data;
- Consideration of any mode of action information;
- BMD, NOAEL or LOAEL determination;
- Relevance for humans;

*Conclusions**LITERATURE:*

- (1) OECD (1995). Report of the Consultation Meeting on Sub-chronic and Chronic Toxicity/Carcinogenicity Testing (Rome, 1995), internal working document, Environment Directorate, OECD, Paris.
- (2) EPA (2005). Guidelines for Carcinogen Risk Assessment Risk Assessment Forum U.S. Environmental Protection Agency Washington, DC.
- (3) Combes RD, Gaunt, I, Balls M (2004). A Scientific and Animal Welfare Assessment of the OECD Health Effects Test Guidelines for the Safety Testing of Chemicals under the European Union REACH System. ATLA 32: 163-208.
- (4) Barlow SM, Greig JB, Bridges JW et al (2002). Hazard identification by methods of animal-based toxicology. Food. Chem. Toxicol. 40: 145-191.
- (5) Chhabra RS, Bucher JR, Wolfe M, Portier C (2003). Toxicity characterization of environmental chemicals by the US National Toxicology Programme: an overview. Int. J. Hyg. Environ. Health 206: 437-445.

▼ M4

- (6) Chapter B.27 of this Annex, Sub-chronic Oral Toxicity Test Repeated Dose 90-day Oral Toxicity Study in Non-Rodents.
- (7) OECD (2012). Guidance Document on the Design and Conduct of Chronic Toxicity and Carcinogenicity Studies, Supporting Test Guidelines 451, 452 and 453 — Second edition. Series on Testing and Assessment No 116, available on the OECD public website for Test Guideline at www.oecd.org/env/testguidelines.
- (8) OECD (2009). Guidance Document on Acute Inhalation Toxicity Testing, Series on Testing and Assessment No 39, ENV/JM/MONO(2009)28, OECD, Paris.
- (9) Chapter B.8 of this Annex, Subacute Inhalation Toxicity: 28-Day Study.
- (10) Chapter B.29 of this Annex, Subchronic Inhalation Toxicity: 90-Day Study.
- (11) Chapter B.9 of this Annex, Repeated Dose (28 Days) Toxicity (Dermal).
- (12) Boobis AR, Cohen SM, Dellarco V, McGregor D, Meek ME, Vickers C, Willcocks D, Farland W (2006). IPCS Framework for analyzing the Relevance of a Cancer Mode of Action for Humans. *Crit. Rev. in Toxicol*, 36: 793-801.
- (13) Cohen SM, Meek ME, Klaunig JE, Patton DE, and Fenner-Crisp PA (2003). The human relevance of information on carcinogenic Modes of Action: An Overview. *Crit. Rev. Toxicol*. 33: 581-589.
- (14) Holsapple MP, Pitot HC, Cohen SN, Boobis AR, Klaunig JE, Pastoor T, Dellarco VL, Dragan YP (2006). Mode of Action in Relevance of Rodent Liver Tumors to Human Cancer Risk. *Toxicol. Sci*. 89: 51-56.
- (15) Meek EM, Bucher JR, Cohen SM, Dellarco V, Hill RN, Lehman-McKemmon LD, Longfellow DG, Pastoor T, Seed J, Patton DE (2003). A Framework for Human Relevance analysis of Information on Carcinogenic Modes of Action. *Crit. Rev. Toxicol*. 33: 591-653.
- (16) Carmichael NG, Barton HA, Boobis AR et al (2006). Agricultural Chemical Safety Assessment: A Multisector Approach to the Modernization of Human Safety Requirements. *Critical Reviews in Toxicology* 36: 1-7.
- (17) Barton HA, Pastoor TP, Baetcke T et al (2006). The Acquisition and Application of Absorption, Distribution, Metabolism, and Excretion (ADME) Data in Agricultural Chemical Safety Assessments. *Critical Reviews in Toxicology* 36: 9-35.
- (18) Doe JE, Boobis AR, Blacker A et al (2006). A Tiered Approach to Systemic Toxicity Testing for Agricultural Chemical Safety Assessment. *Critical Reviews in Toxicology* 36: 37-68.
- (19) Cooper RL, Lamb JS, Barlow SM et al (2006). A Tiered Approach to Life Stages Testing for Agricultural Chemical Safety Assessment. *Critical Reviews in Toxicology* 36: 69-98.
- (20) OECD (2002). Guidance Notes for Analysis and Evaluation of Chronic Toxicity and Carcinogenicity Studies, Series on Testing and Assessment No 35 and Series on Pesticides No 14, ENV/JM/MONO(2002)19, OECD, Paris.
- (21) OECD (2000). Guidance Document on the recognition, assessment, and use of clinical signs as humane endpoints for experimental animals used in safety evaluation, Series on Testing and Assessment No 19, ENV/JM/MONO(2000)7, OECD, Paris.

▼ **M4**

- (22) Rhomberg LR, Baetcke K, Blancato J, Bus J, Cohen S, Conolly R, Dixit R, Doe J, Ekelman K, Fenner-Crisp P, Harvey P, Hattis D, Jacobs A, Jacobson-Kram D, Lewandowski T, Liteplo R, Pelkonen O, Rice J, Somers D, Turturro A, West, W, Olin S(2007). Issues in the Design and Interpretation of Chronic Toxicity and Carcinogenicity Studies in Rodents: Approaches to Dose Selection *Crit Rev. Toxicol.* 37 (9): 729 – 837.
- (23) ILSI (International Life Sciences Institute) (1997). Principles for the Selection of Doses in Chronic Rodent Bioassays. Foran JA (Ed.). ILSI Press, Washington, DC.
- (24) Griffiths SA, Parkinson C, McAuslane JAN and Lumley CE (1994). The utility of the second rodent species in the carcinogenicity testing of pharmaceuticals. *The Toxicologist* 14(1):214.
- (25) Usui T, Griffiths SA and Lumley CE (1996). The utility of the mouse for the assessment of the carcinogenic potential of pharmaceuticals. In D'Arcy POF & Harron DWG (eds). Proceedings of the Third International Conference on Harmonisation. Queen's University Press, Belfast. pp 279-284.
- (26) Carmichael NG, Enzmann H, Pate I, Waechter F (1997). The Significance of Mouse Liver Tumor Formation for Carcinogenic Risk Assessment: Results and Conclusions from a Survey of 10 Years of Testing by the Agrochemical Industry. *Environ Health Perspect.* 105:1196-1203.
- (27) Directive 2010/63/EU of the European Parliament and of the Council of 22 September 2010 on the protection of animals used for scientific purposes (OJ L 276, 20.10.2010, p. 33).
- (28) National Research Council, 1985. Guide for the care and use of laboratory animals. NIH Publication No 86-23. Washington, D.C., US Dept. of Health and Human Services.
- (29) GV-SOLAS (Society for Laboratory Animal Science, Gesellschaft für Versuchstierkunde, 1988). Publication on the Planning and Structure of Animal Facilities for Institutes Performing Animal Experiments. ISBN 3-906255-04-2.
- (30) GV-SOLAS (Society for Laboratory Animal Science, Gesellschaft für Versuchstierkunde, 2006). Microbiological monitoring of laboratory animals in various housing systems.
- (31) Diehl K-H, Hull R, Morton D, Pfister R, Rabemampianina Y, Smith D, Vidal J-M, van de Vorstenbosch C. (2001). A good practice guide to the administration of substances and removal of blood, including routes and volumes. *Journal of Applied Toxicology* 21:15-23.
- (32) Weingand K, *et al.* (1996). Harmonization of Animal Clinical Pathology Testing in Toxicity and Safety Studies. *Fund. Appl. Toxicol.* 29: 198-201.
- (33) Crissman J, Goodman D, Hildebrandt P, *et al.* (2004). Best Practices Guideline: Toxicological Histopathology. *Toxicologic Pathology* 32: 126-131.

▼ M4

Appendix 1

DEFINITION

Test chemical: Any substance or mixture tested using this Test Method.

▼ M4**B.33. COMBINED CHRONIC TOXICITY/CARCINOGENICITY STUDIES**

INTRODUCTION

1. This Test Method is equivalent to OECD Test Guideline (TG) 453 (2009). The original TG 453 was adopted in 1981. Development of this updated Test Method B.33 was considered necessary, in order to reflect recent developments in the field of animal welfare and regulatory requirements (1) (2) (3) (4) (5). The updating of this Test Method B.33 has been carried out in parallel with revisions of Chapter B.32 of this Annex, Carcinogenicity Studies, and Chapter B.30 of this Annex, Chronic Toxicity Studies, with the objective of obtaining additional information from the animals used in the study and providing further detail on dose selection. This Test Method is designed to be used in the testing of a broad range of chemicals, including pesticides and industrial chemicals. It should be noted however that some details and requirements may differ for pharmaceuticals [see International Conference on Harmonisation (ICH) Guidance S1B on Testing for Carcinogenicity of Pharmaceuticals].
2. The majority of chronic toxicity and carcinogenicity studies are carried out in rodent species and this Test Method is intended therefore to apply primarily to studies carried out in these species. Should such studies be required in non-rodent species, the principles and procedures outlined may also be applied, with appropriate modifications, together with those outlined in Chapter B.27 of this Annex, Repeated Dose 90-day Oral Toxicity Study in Non-Rodents (6), as outlined in the OECD Guidance Document No 116 on the Design and Conduct of Chronic Toxicity and Carcinogenicity Studies (7).
3. The three main routes of administration used in chronic toxicity/carcinogenicity studies are oral, dermal and inhalation. The choice of the route of administration depends on the physical and chemical characteristics of the test chemical and the predominant route of exposure of humans. Additional information on choice of route of exposure is provided in Guidance Document No 116 (7).
4. This Test Method focuses on exposure via the oral route, the route most commonly used in chronic toxicity and carcinogenicity studies. While long-term studies involving exposure via the dermal or inhalation routes may also be necessary for human health risk assessment and/or may be required under certain regulatory regimes, both routes of exposure involve considerable technical complexity. Such studies will need to be designed on a case-by-case basis, although the Test Method outlined here for the assessment and evaluation of chronic toxicity and carcinogenicity by oral administration could form the basis of a protocol for inhalation and/or dermal studies, with respect to recommendations for treatment periods, clinical and pathology parameters, etc. OECD Guidance is available on the administration of test chemicals by the inhalation (7) (8) and dermal routes (7). Chapter B.8 of this Annex (9) and Chapter B.29 of this Annex (10), together with the OECD Guidance Document on acute inhalation testing (8), should be specifically consulted in the design of longer term studies involving exposure via the inhalation route. Chapter B.9 of this Annex (11) should be consulted in the case of testing carried out by the dermal route.

▼M4

5. The combined chronic toxicity/carcinogenicity study provides information on the possible health hazards likely to arise from repeated exposure for a period lasting up to the entire lifespan of the species used. The study will provide information on the toxic effects of the test chemical, including potential carcinogenicity, indicate target organs and the possibility of accumulation. It can provide an estimate of the no-observed-adverse effect level for toxic effects and, in the case of non-genotoxic carcinogens, for tumour responses, which can be used for establishing safety criteria for human exposure. The need for careful clinical observations of the animals, so as to obtain as much information as possible, is also stressed.

6. The objectives of chronic toxicity/carcinogenicity studies covered by this Test Method include:
 - The identification of the carcinogenic properties of a test chemical, resulting in an increased incidence of neoplasms, increased proportion of malignant neoplasms or a reduction in the time to appearance of neoplasms, compared with concurrent control groups;
 - The identification of the time to appearance of neoplasms;
 - The identification of the chronic toxicity of the test chemical;
 - The identification of target organ(s) of chronic toxicity and carcinogenicity,
 - Characterisation of the dose:response relationship,
 - Identification of a no-observed-adverse-effect level (NOAEL) or point of departure for establishment of a Benchmark Dose (BMD),
 - Extrapolation of carcinogenic effects to low dose human exposure levels,
 - Prediction of chronic toxicity effects at human exposure levels,
 - Provision of data to test hypotheses regarding mode of action (2) (7) (12) (13) (14) (15).

INITIAL CONSIDERATIONS

7. In the assessment and evaluation of the potential carcinogenicity and chronic toxicity of a test chemical, all available information on the test chemical should be considered by the testing laboratory prior to conducting the study, in order to focus the design of the study to more efficiently test for its toxicological properties and to minimise animal usage. Information on, and consideration of, the mode of action of a suspected carcinogen (2) (7) (12) (13) (14) (15) is particularly important, since the optimal design may differ depending on whether the test chemical is a known or suspected genotoxic carcinogen. Further guidance on mode of action considerations can be found in Guidance Document No 116 (7).

8. Information that will assist in the study design includes the identity, chemical structure, and physico-chemical properties of the test chemical; any information on the mode of action; results of any *in vitro* or *in vivo* toxicity tests including genotoxicity tests; anticipated use(s) and potential for human exposure; available (Q)SAR data, mutagenicity/genotoxicity, carcinogenicity and other toxicological data on structurally-related chemicals; available toxicokinetic data (single dose and also repeat dose kinetics where available) and data derived from other repeated exposure studies. The determination of chronic toxicity/carcinogenicity should only

▼ M4

be carried out after initial information on toxicity has been obtained from repeated dose 28-day and/or 90-day toxicity tests. Short-term cancer initiation-promotion tests could also provide useful information. A phased testing approach to carcinogenicity testing should be considered as part of the overall assessment of the potential adverse health effects of a particular test chemical (16) (17) (18) (19).

9. The statistical methods most appropriate for the analysis of results, given the experimental design and objectives, should be established before commencing the study. Issues to consider include whether the statistics should include adjustment for survival, analysis of cumulative tumour risks relative to survival duration, analysis of the time to tumour and analysis in the event of premature termination of one or more groups. Guidance on the appropriate statistical analyses and key references to internationally accepted statistical methods are given in Guidance Document No 116 (7), and also in Guidance Document No 35 on the analysis and evaluation of chronic toxicity and carcinogenicity studies (20).

10. In conducting a carcinogenicity study, the guiding principles and considerations outlined in the OECD Guidance Document on the recognition, assessment, and use of clinical signs as humane endpoints for experimental animals used in safety evaluation (21), in particular paragraph 62 thereof, should always be followed. This paragraph states that *'In studies involving repeated dosing, when an animal shows clinical signs that are progressive, leading to further deterioration in condition, an informed decision as to whether or not to humanely kill the animal should be made. The decision should include consideration as to the value of the information to be gained from the continued maintenance of that animal on study relative to its overall condition. If a decision is made to leave the animal on test, the frequency of observations should be increased, as needed. It may also be possible, without adversely affecting the purpose of the test, to temporarily stop dosing if it will relieve the pain or distress, or reduce the test dose.'*

11. Detailed guidance on and discussion of the principles of dose selection for chronic toxicity and carcinogenicity studies can be found in Guidance Document No 116 (7), as well as two International Life Sciences Institute publications (22) (23). The core dose selection strategy is dependent on the primary objective or objectives of the study (paragraph 6). In selecting appropriate dose levels, a balance should be achieved between hazard screening on the one hand and characterisation of low-dose responses and their relevance on the other. This is particularly relevant in the case of this combined chronic toxicity and carcinogenicity study.

12. Consideration should be given to carrying out this combined chronic toxicity and carcinogenicity study, rather than separate execution of a chronic toxicity study (Chapter B.30 of this Annex) and carcinogenicity study (Chapter B.32 of this Annex). The combined test provides greater efficiency in terms of time and cost, and some reduction in animal use, compared to conducting two separate studies, without compromising the quality of the data in either the chronic phase or the carcinogenicity phase. Careful consideration should however be given to the principles of dose selection (paragraphs 11 and 22-26) when undertaking a combined chronic toxicity and carcinogenicity study, and it is also recognised that separate studies may be required under certain regulatory frameworks. Further guidance on the design of the combined chronic toxicity and carcinogenicity study in order to achieve maximum efficiency of the study in terms of possibilities for reduction in numbers of animals used as well as via the streamlining of the various experimental procedures can be found in Guidance Document No 116 (7).

▼M4

13. Definitions used in the context of this Test Method can be found at the end of this chapter and in Guidance Document No 116 (7).

PRINCIPLE OF THE TEST

14. The study design consists of two parallel phases, a chronic phase and a carcinogenicity phase (for duration see paragraphs 34 and 35, respectively). The test chemical is normally administered by the oral route although testing by the inhalation or dermal route may also be appropriate. For the chronic phase, the test chemical is administered daily in graduated doses to several groups of test animals, one dose level per group, normally for a period of 12 months, although longer or shorter durations may also be chosen depending on regulatory requirements (see paragraph 34). This duration is chosen to be sufficiently long to allow any effects of cumulative toxicity to become manifest, without the confounding effects of geriatric changes. The study design may also include one or more interim kills, e.g. at 3 and 6 months, and additional groups of animals may be included to accommodate this (see paragraph 20). For the carcinogenicity phase, the test chemical is administered daily to several groups of test animals for a major portion of their life span. The animals in both phases are observed closely for signs of toxicity and for the development of neoplastic lesions. Animals which die or are killed during the test are necropsied and, at the conclusion of the test, surviving animals are killed and necropsied.

DESCRIPTION OF THE METHOD**Selection of animal species**

15. This Test Method primarily covers assessment and evaluation of chronic toxicity and carcinogenicity in rodents (paragraph 2). The use of non-rodent species may be considered when available data suggest that they are more relevant for the prediction of health effects in humans. The choice of species should be justified. The preferred rodent species is the rat, although other rodent species, e.g. the mouse, may be used. Although the use of the mouse in carcinogenicity testing may have limited utility (24) (25) (26), under some current regulatory programmes carcinogenicity testing in the mouse is still required unless it is determined that such a study is not scientifically necessary. Rats and mice have been preferred experimental models because of their relatively short life span, their widespread use in pharmacological and toxicological studies, their susceptibility to tumour induction, and the availability of sufficiently characterised strains. As a consequence of these characteristics, a large amount of information is available on their physiology and pathology. The design and conduct of chronic toxicity/carcinogenicity studies in non-rodent species, when required, should be based on the principles outlined in this Test Method together with those in Chapter B.27 of this Annex, Repeated Dose 90-day Oral Toxicity Study in Non-Rodents (6). Additional information on choice of species and strain is provided in Guidance Document No 116 (7).
16. Young healthy adult animals of commonly used laboratory strains should be employed. The combined chronic toxicity/carcinogenicity study should be carried out in animals from the same strain and source as those used in preliminary toxicity study(ies) of shorter duration, although, if animals from this strain and source are known to present problems in achieving the normally accepted criteria of survival for long-term studies [see Guidance Document No 116 (7)], consideration should be given to using a strain of animal that has a acceptable survival rate for the long-term study. The females should be nulliparous and non-pregnant.

▼M4**Housing and feeding conditions**

17. Animals may be housed individually, or be caged in small groups of the same sex; individual housing should be considered only if scientifically justified (27) (28) (29). Cages should be arranged in such a way that possible effects due to cage placement are minimised. The temperature in the experimental animal room should be 22 °C (\pm 3 °C). Although the relative humidity should be at least 30 % and preferably not exceed 70 % other than during room cleaning, the aim should be 50-60 %. Lighting should be artificial, the sequence being 12 hours light, 12 hours dark. For feeding, conventional laboratory diets may be used with an unlimited supply of drinking water. The diet should meet all the nutritional requirements of the species tested and the content of dietary contaminants, including but not limited to pesticide residues, persistent organic pollutants, phytoestrogens, heavy metals and mycotoxins, that might influence the outcome of the test, should be as low as possible. Analytical information on the nutrient and dietary contaminant levels should be generated periodically, at least at the beginning of the study and when there is a change in the batch used, and should be included in the final report. Analytical information on the drinking water used in the study should similarly be provided. The choice of diet may be influenced by the need to ensure a suitable admixture of a test chemical and to meet the nutritional requirements of the animals when the test chemical is administered by the dietary route.

Preparation of animals

18. Healthy animals, which have been acclimated to laboratory conditions for at least 7 days and have not been subjected to previous experimental procedures, should be used. In the case of rodents, dosing of the animals should begin as soon as possible after weaning and acclimatisation and preferably before the animals are 8 weeks old. The test animals should be characterised as to species, strain, source, sex, weight and age. At the commencement of the study, the weight variation for each sex of animals used should be minimal and not exceed \pm 20 % of the mean weight of all the animals within the study, separately for each sex. Animals should be randomly assigned to the control and treatment groups. After randomisation, there should be no significant differences in mean body weights between groups within each sex. If there are statistically significant differences, then the randomisation step should be repeated, if possible. Each animal should be assigned a unique identification number, and permanently marked with this number by tattooing, microchip implant, or other suitable method.

PROCEDURE**Number and sex of animals**

19. Both sexes should be used. A sufficient number of animals should be used so that a thorough biological and statistical evaluation is possible. For rodents, each dose group (as outlined in paragraph 22) and concurrent control group intended for the carcinogenicity phase of the study should therefore contain at least 50 animals of each sex. Depending on the aim of the study, it may be possible to increase the statistical power of the key estimates by differentially allocating animals unequally to the various dose groups, with more than 50 animals in the low dose groups, e.g. to estimate the carcinogenic potential in low doses. However it should be recognised that a moderate increase in group size will provide relatively little increase in statistical power of the study. Each dose group (as outlined in paragraph 22) and concurrent control group intended for the chronic toxicity phase of the study should contain at least 10 animals of each sex, in the case of rodents. It should be noted that this number is lower than in the chronic

▼ M4

toxicity study (Chapter B.30 of this Annex). The interpretation of the data from the reduced number of animals per group in the chronic toxicity phase of this combined study will however be supported by the data from the larger number of animals in the carcinogenicity phase of the study. In studies involving mice, additional animals may be needed in each dose group of the chronic toxicity phase, to conduct all required haematological determinations. Further information on statistical design of the study and choice of dose levels to maximise statistical power is provided in Guidance Document No 116 (7).

Provision for interim kills, satellite group and sentinel animals

20. The study may make provision for interim kills, e.g. at 6 months for the chronic toxicity phase, to provide information on progression of non-neoplastic changes and mechanistic information, if scientifically justified. Where such information is already available from previous repeat dose toxicity studies on the test chemical, interim kills may not be scientifically justified. The animals used in the chronic toxicity phase of the study, normally of 12 months duration (paragraph 34) provide interim kill data for the carcinogenicity phase of the study, thus achieving a reduction in the number of animals used overall. Satellite groups may also be included in the chronic toxicity phase of the study, to monitor the reversibility of any toxicological changes induced by the test chemical under investigation. These may be restricted to the highest dose level of the study plus control. An additional group of sentinel animals (typically 5 animals per sex) may be included for monitoring of disease status, if necessary, during the study (30). Further guidance on study design to include interim kills, satellite and sentinel animals, while minimising the number of animals used overall is provided in Guidance Document No 116 (7).

21. If satellite animals and/or interim kills are included in the study design, the number of animals in each dose group included for this purpose will normally be 10 animals per sex, and the total number of animals included in the study design should be increased by the number of animals scheduled to be killed before the completion of the study. Interim kill and satellite animals should normally undergo the same observations, including body weight, food/water consumption, haematological and clinical biochemistry measurements and pathological investigations as the animals in the chronic toxicity phase of the main study, although provision may also be made (in the interim kill groups) for measurements to be restricted to specific, key measures such as neurotoxicity or immunotoxicity.

Dose groups and dosage

22. Guidance on all aspects of dose selection and dose level spacing is provided in Guidance Document No 116 (7). At least three dose levels and a concurrent control should be used, for both the chronic and carcinogenicity phases. Dose levels will generally be based on the results of shorter-term repeated dose or range finding studies and should take into account any existing toxicological and toxicokinetic data available for the test chemical or related chemicals.

▼ M4

23. For the chronic toxicity phase of the study, a full study using three dose levels may not be considered necessary, if it can be anticipated that a test at one dose level, equivalent to at least 1 000 mg/kg body weight/day, is unlikely to produce adverse effects. This should be based on information from preliminary studies and a consideration that toxicity would not be expected, based upon data from structurally related chemicals. A limit of 1 000 mg/kg body weight/day may apply except when human exposure indicates the need for a higher dose level to be used.

24. Unless limited by the physical-chemical nature or biological effects of the test chemical, the highest dose level should be chosen to identify the principal target organs and toxic effects while avoiding suffering, severe toxicity, morbidity, or death. The highest dose level should be normally chosen to elicit evidence of toxicity, as evidenced by, for example, depression of body weight gain (approximately 10 %). However, dependent on the objectives of the study (see paragraph 6), a top dose lower than the dose providing evidence of toxicity may be chosen, e.g. if a dose elicits an adverse effect of concern, which nonetheless has little impact on lifespan or body weight.

25. Dose levels and dose level spacing may be selected to establish a dose-response and, depending on the mode of action of the test chemical, a NOAEL or other intended outcome of the study, e.g. a BMD (see paragraph 27). Factors that should be considered in the placement of lower doses include the expected slope of the dose-response curve, the doses at which important changes may occur in metabolism or mode of toxic action, where a threshold is expected, or where a point of departure for low-dose extrapolation is expected. In conducting a combined carcinogenicity/chronic toxicity study, the primary objective will be to obtain information for carcinogenicity risk assessment purposes, and information on chronic toxicity will normally be a subsidiary objective. This should be borne in mind when selecting dose levels and dose level spacing for the study.

26. The dose level spacing selected will depend on the objectives of the study and the characteristics of the test chemical, and cannot be prescribed in detail in this Test Method, but two to four fold intervals frequently provide good test performance when used for setting the descending dose levels and addition of a fourth test group is often preferable to using very large intervals (e.g. more than a factor of about 6-10) between dosages. In general the use of factors greater than 10 should be avoided, and should be justified if used.

27. As outlined further in Guidance Document No 116 (7), points to be considered in dose selection include:
 - Known or suspected nonlinearities or inflection points in the dose-response;

 - Toxicokinetics, and dose ranges where metabolic induction, saturation, or nonlinearity between external and internal doses does or does not occur;

 - Precursor lesions, markers of effect, or indicators of the operation of key underlying biological processes;

▼ M4

- Key (or suspected) aspects of mode of action, such as doses at which cytotoxicity begins to arise, hormone levels are perturbed, homeostatic mechanisms are overwhelmed, etc.;
 - Regions of the dose–response curve where particularly robust estimation is needed, e.g. in the range of the anticipated BMD or a suspected threshold;
 - Consideration of anticipated human exposure levels, especially in the choice of mid and low doses.
28. The control group shall be an untreated group or a vehicle-control group if a vehicle is used in administering the test chemical. Except for treatment with the test chemical, animals in the control group should be handled in an identical manner to those in the test groups. If a vehicle is used, the control group shall receive the vehicle in the highest volume used among the dose groups. If a test chemical is administered in the diet, and causes significantly reduced dietary intake due to the reduced palatability of the diet, an additional pair-fed control group may be useful, to serve as a more suitable control.

Preparation of doses and administration of test chemical

29. The test chemical is normally administered orally, via the diet or drinking water, or by gavage. Additional information on routes and methods of administration is provided in Guidance Document No 116 (7). The route and method of administration is dependent on the purpose of the study, the physical/chemical properties of the test chemical, its bioavailability, and the predominant route and method of exposure of humans. A rationale should be provided for the chosen route and method of administration. In the interests of animal welfare, oral gavage should normally be selected only for those agents for which this route and method of administration reasonably represent potential human exposure (e.g. pharmaceuticals). For dietary or environmental chemicals including pesticides, administration is typically via the diet or drinking water. However, for some scenarios, e.g. occupational exposure, administration via other routes may be more appropriate.
30. Where necessary, the test chemical is dissolved or suspended in a suitable vehicle. Consideration should be given to the following characteristics of the vehicle and other additives, as appropriate: effects on the absorption, distribution, metabolism, or retention of the test chemical; effects on the chemical properties of the test chemical which may alter its toxic characteristics; and effects on the food or water consumption or the nutritional status of the animals. It is recommended that, wherever possible, the use of an aqueous solution/suspension be considered first, followed by consideration of a solution/emulsion in oil (e.g. corn oil) and then by possible solution in other vehicles. For vehicles other than water, the toxic characteristics of the vehicle should be known. Information should be available on the stability of the test chemical and the homogeneity of dosing solutions or diets (as appropriate) under the conditions of administration (e.g. diet).
31. For chemicals administered via the diet or drinking water it is important to ensure that the quantities of the test chemical involved do not interfere with normal nutrition or water balance. In long-term toxicity studies using dietary administration, the concentration of the test chemical in the feed should not normally exceed an upper limit of 5 % of the total diet, in order to avoid nutritional imbalances. When the test chemical is administered in the diet, either a constant dietary concentration (mg/kg diet or ppm), or a constant dose level in terms of the animal's body weight (mg/kg body weight), calculated on a weekly basis, may be used. The alternative used should be specified.

▼ M4

32. In the case of oral administration, the animals are dosed with the test chemical daily (seven days each week) for a period of 12 months (chronic phase) or 24 months (carcinogenicity phase), see also paragraphs 33 and 34. Any other dosing regime, e.g. five days per week, needs to be justified. In the case of dermal administration, animals are normally treated with the test chemical for at least 6 hours per day, 7 days per week, as specified in Chapter B.9 of this Annex (11), for a period of 12 months (chronic phase) or 24 months (carcinogenicity phase). Exposure by the inhalation route is carried out for 6 hours per day, 7 days per week, but exposure for 5 days per week may also be used, if justified. The period of exposure will normally be for a period of 12 months (chronic phase) or 24 months (carcinogenicity phase). If rodent species other than rats are exposed nose-only, maximum exposure durations may be adjusted to minimise species-specific distress. A rationale should be provided when using an exposure duration of less than 6 hours per day. See also Chapter B.8 of this Annex (9).
33. When the test chemical is administered by gavage to the animals this should be done using a stomach tube or a suitable intubation cannula, at similar times each day. Normally a single dose will be administered once daily, where for example a chemical is a local irritant, it may be possible to maintain the daily dose-rate by administering it as a split dose (twice a day). The maximum volume of liquid that can be administered at one time depends on the size of the test animal. The volume should be kept as low as practical, and should not normally exceed 1 ml/100g body weight for rodents (31). Variability in test volume should be minimised by adjusting the concentration to ensure a constant volume at all dose levels. Potentially corrosive or irritant chemicals are the exception, and need to be diluted to avoid severe local effects. Testing at concentrations that are likely to be corrosive or irritant to the gastrointestinal tract should be avoided.

Duration of study

34. The period of dosing and duration of the chronic phase of this study is normally 12 months, although the study design also allows for and can be applied to either shorter (e.g. 6 or 9 months) or longer (e.g. 18 or 24 months) duration studies, depending on the requirements of particular regulatory regimes or for specific mechanistic purposes. Deviations from an exposure duration of 12 months should be justified, particularly in the case of shorter durations. All dose groups allocated to this phase will be terminated at the designated time for evaluation of chronic toxicity and non-neoplastic pathology. Satellite groups included to monitor the reversibility of any toxicological changes induced by the test chemical under investigation should be maintained without dosing for a period not less than 4 weeks and not more than one third of the total study duration after cessation of exposure.
35. The duration of the carcinogenicity phase of this study will normally be 24 months for rodents, representing the majority of the normal life span of the animals to be used. Shorter or longer study durations may be used, dependent on the lifespan of the strain of the animal species in the study, but should be justified. For specific strains of mice, e.g. AKR/J, C3H/J or C57BL/6J strains a duration of 18 months may be more appropriate. The following provides some guidance on duration, termination of the study and survival; further guidance, including consideration of the acceptability of a negative carcinogenicity study relative to survival in the study, is provided in Guidance Document No 116 (7):

▼M4

- Termination of the study should be considered when the number of survivors in the lower dose groups or the control group falls below 25 per cent.

- In the case where only the high dose group dies prematurely due to toxicity, this should not trigger termination of the study.

- Survival of each sex should be considered separately.

- The study should not be extended beyond the point when the data available from the study are no longer sufficient to enable a statistically valid evaluation to be made.

OBSERVATIONS (CHRONIC TOXICITY PHASE)

36. All animals should be checked for morbidity or mortality, usually at the beginning and end of each day, including at weekends and holidays. General clinical observations should be made at least once a day, preferably at the same time(s) each day, taking into consideration the peak period of anticipated effects after dosing in the case of gavage administration.

37. Detailed clinical observations should be made on all animals at least once prior to the first exposure (to allow for within-subject comparisons), at the end of the first week of the study and monthly thereafter. The protocol for observations should be arranged such that variations between individual observers are minimised and independent of test group. These observations should be made outside the home cage, preferably in a standard arena and at similar times on each occasion. They should be carefully recorded, preferably using scoring systems, explicitly defined by the testing laboratory. Efforts should be made to ensure that variations in the observation conditions are minimal. Signs noted should include, but not be limited to, changes in skin, fur, eyes, mucous membranes, occurrence of secretions and excretions and autonomic activity (e.g. lacrimation, piloerection, pupil size, unusual respiratory pattern). Changes in gait, posture and response to handling as well as the presence of clonic or tonic movements, stereotypies (e.g. excessive grooming, repetitive circling) or bizarre behaviour (e.g. self-mutilation, walking backwards) should also be recorded (32).

38. Ophthalmological examination, using an ophthalmoscope or other suitable equipment, should be carried out on all animals prior to the first administration of the test chemical. At the termination of the study, this examination should be preferably conducted in all animals but at least in the high dose and control groups. If treatment-related changes in the eyes are detected, all animals should be examined. If structural analysis or other information suggests ocular toxicity, then the frequency of ocular examination should be increased.

39. For chemicals where previous repeated dose 28-day and/or 90-day toxicity tests indicated the potential to cause neurotoxic effects, sensory reactivity to stimuli of different types (32) (e.g. auditory, visual and proprioceptive stimuli) (33) (34) (35), assessment of grip strength (36) and motor activity assessment (37) may optionally be conducted before commencement of the study and at 3 month periods after study initiation up to and including 12 months, as well as at study termination (if longer than 12 months). Further details of the procedures that could be followed are given in the respective references. However, alternative procedures than those referenced could also be used.

▼ M4

40. For chemicals where previous repeated dose 28-day and/or 90-day toxicity tests indicated the potential to cause immunotoxic effects, further investigations of this endpoint may optionally be conducted at termination.

Body weight, food/water consumption and food efficiency

41. All animals should be weighed at the start of treatment, at least once a week for the first 13 weeks and at least monthly thereafter. Measurements of food consumption and food efficiency should be made at least weekly for the first 13 weeks and at least monthly thereafter. Water consumption should be measured at least weekly for the first 13 weeks and at least monthly thereafter when the test chemical is administered in drinking water. Water consumption measurements should also be considered for studies in which drinking activity is altered.

Haematology and clinical biochemistry

42. In studies involving rodents, haematological examinations should be carried out on all study animals (10 male and 10 female animals per group) at 3, 6, and 12 months, as well as at study termination (if longer than 12 months). In mice, satellite animals may be needed in order to conduct all required haematological determinations (see paragraph 19). In non-rodent studies, samples will be taken from smaller numbers of animals (e.g. 4 animals per sex and per group in dog studies), at interim sampling times and at termination as described for rodents. Measurements at 3 months, either in rodents or non-rodents, need not be conducted if no effect was seen on haematological parameters in a previous 90 day study carried out at comparable dose levels. Blood samples should be taken from a named site, for example by cardiac puncture or from the retro-orbital sinus, under anaesthesia.
43. The following list of parameters should be investigated (38): total and differential leukocyte count, erythrocyte count, platelet count, haemoglobin concentration, haematocrit (packed cell volume), mean corpuscular volume (MCV), mean corpuscular haemoglobin (MCH), mean corpuscular haemoglobin concentration (MCHC), prothrombin time, and activated partial thromboplastin time. Other hematology parameters such as Heinz bodies or other atypical erythrocyte morphology or methaemoglobin may be measured as appropriate depending on the toxicity of the test chemical. Overall, a flexible approach should be adopted, depending on the observed and/or expected effect from a given test chemical. If the test chemical has an effect on the haematopoietic system, reticulocyte counts and bone marrow cytology may also be indicated, although these need not be routinely conducted.
44. Clinical biochemistry determinations to investigate major toxic effects in tissues and, specifically, effects on kidney and liver, should be performed on blood samples obtained from all study animals (10 male and 10 female animals per group), at the same time intervals as specified for the haematological investigations. In mice, satellite animals may be needed in order to conduct all required clinical biochemistry determinations. In non-rodent studies, samples will be taken from smaller numbers of animals (e.g. 4 animals per sex and per group in dog studies), at interim sampling times and at termination as described for rodents. Measurements at 3 months, either in rodents or non-rodents, need not be conducted if no effect was seen on clinical biochemistry parameters in a previous 90 day study carried

▼ M4

out at comparable dose levels. Overnight fasting of the animals (with the exception of mice) prior to blood sampling is recommended⁽¹⁾. The following list of parameters should be investigated (38): glucose, urea (urea nitrogen), creatinine, total protein, albumin, calcium, sodium, potassium, total cholesterol, at least two appropriate tests for hepatocellular evaluation (alanine aminotransferase, aspartate aminotransferase, glutamate dehydrogenase, total bile acids) (39), and at least two appropriate tests for hepatobiliary evaluation (alkaline phosphatase, gamma glutamyl transferase, 5'-nucleotidase, total bilirubin, total bile acids) (39). Other clinical chemistry parameters such as fasting triglycerides, specific hormones and cholinesterase may be measured as appropriate, depending on the toxicity of the test chemical. Overall, there is a need for a flexible approach, depending on the observed and/or expected effect from a given test chemical.

45. Urinalysis determinations should be performed on all study animals (10 male and 10 female animals per group), on samples collected at the same intervals as for haematology and clinical chemistry. Measurements at 3 months need not be conducted if no effect was seen on urinalysis in a previous 90 day study carried out at comparable dose levels. The following list of parameters was included in an expert recommendation on clinical pathology studies (38): appearance, volume, osmolality or specific gravity, pH, total protein, and glucose. Other determinations include ketone, urobilinogen, bilirubin, and occult blood. Further parameters may be employed where necessary to extend the investigation of observed effect(s).

46. It is generally considered that baseline haematological and clinical biochemistry variables need be determined before treatment for dog studies, but need not be determined in rodent studies (38). However, if historical baseline data (see paragraph 58) are inadequate, consideration should be given to generating such data.

PATHOLOGY*Gross necropsy*

47. All animals in the study shall be normally subjected to a full, detailed gross necropsy which includes careful examination of the external surface of the body, all orifices, and the cranial, thoracic and abdominal cavities and their contents. However provision may also be made (in the interim kill or satellite groups) for measurements to be restricted to specific, key measures such as neurotoxicity or immunotoxicity (see paragraph 21). These animals need not be subjected to necropsy and the subsequent procedures described in the following paragraphs. Sentinel animals may require necropsy on a case-by-case basis, at the discretion of the study director.

⁽¹⁾ For a number of measurements in serum and plasma, most notably for glucose, overnight fasting is preferable. The major reason for this preference is that the increased variability which would inevitably result from non-fasting, would tend to mask more subtle effects and make interpretation difficult. However it should be noted that overnight fasting may interfere with the general metabolism of the animals and, particularly in feeding studies, may disrupt the daily exposure to the test chemical. All animals should be assessed in the same physiological condition and preferably detailed or neurological assessments should therefore be scheduled for a different day than clinical biochemistry sampling.

▼ **M4**

48. Organ weights should be collected from all animals, other than those excluded by the latter part of paragraph 47. The adrenals, brain, epididymides, heart, kidneys, liver, ovaries, spleen, testes, thyroid (weighed post-fixation, with parathyroids), and uterus of all animals (apart from those found moribund and/or intercurrently killed) should be trimmed of any adherent tissue, as appropriate, and their wet weight taken as soon as possible after dissection to prevent drying.
49. The following tissues should be preserved in the most appropriate fixation medium for both the type of tissue and the intended subsequent histopathological examination (40) (tissues in square brackets are optional):

all gross lesions	heart	pancreas	stomach (forestomach, glandular stomach)
adrenal gland	ileum	parathyroid gland	[teeth]
aorta	jejunum	peripheral nerve	testis
brain (including sections of cerebrum, cerebellum, and medulla/pons)	kidney	pituitary	thymus
caecum	lacrimal gland (exorbital)	prostate	thyroid
cervix	liver	rectum	[tongue]
coagulating gland	lung	salivary gland	trachea
colon	lymph nodes (both superficial and deep)	seminal vesicle	urinary bladder
duodenum	mammary gland (obligatory for females and, if visibly dissectable, from males)	skeletal muscle	uterus (including cervix)
epididymis	[upper respiratory tract, including nose, turbinates, and paranasal sinuses]	skin	[ureter]
eye (including retina)	oesophagus	spinal cord (at three levels: cervical, mid-thoracic, and lumbar)	[urethra]
[femur with joint]	[olfactory bulb]	spleen	vagina
gall bladder (for species other than rat)	ovary	[sternum],	section of bone marrow and/or a fresh bone marrow aspirate
Harderian gland			

▼ M4

In the case of paired organs, e.g. kidney, adrenal, both organs should be preserved. The clinical and other findings may suggest the need to examine additional tissues. Also any organs considered likely to be target organs based on the known properties of the test chemical should be preserved. In studies involving the dermal route of administration, the list of organs as set out for the oral route should be examined, and specific sampling and preservation of the skin from the site of application is necessary. In inhalation studies, the list of preserved and examined tissues from the respiratory tract should follow the recommendations of Chapters B.8 of this Annex (9) and Chapter B.29 of this Annex (10). For other organs/tissues (and in addition to the specifically preserved tissues from the respiratory tract) the list of organs as set out for the oral route should be examined.

Histopathology

50. Guidance is available on best practices in the conduct of toxicological pathology studies (40). The minimum histopathological examinations should be:

- all tissues from the high dose and control groups;
- all tissues from animals dying or killed during the study;
- all tissues showing macroscopic abnormalities;
- target tissues, or tissues which showed treatment-related changes in the high dose group, from all animals in all other dose groups,
- in the case of paired organs, e.g. kidney, adrenal, both organs should be examined.

OBSERVATIONS (CARCINOGENICITY PHASE)

51. All animals should be checked for morbidity or mortality, usually at the beginning and the end of each day, including at weekends and holidays. Animals should additionally be checked once a day for specific signs of toxicological relevance. In the case of gavage studies, animals should be checked in the period immediately following dosing. Particular attention should be paid to tumour development; and the time of tumour onset, location, dimensions, appearance, and progression of each grossly visible or palpable tumour should be recorded.
52. All animals should be weighed at the start of treatment, at least once a week for the first 13 weeks and at least monthly thereafter. Measurements of food consumption and food efficiency should be made at least weekly for the first 13 weeks and at least monthly thereafter. Water consumption should be measured at least weekly for the first 13 weeks and at least monthly thereafter when the test chemical is administered in drinking water. Water consumption measurements should also be considered for studies in which drinking activity is altered.

▼ **M4***Haematology, clinical biochemistry and other measurements*

53. In order to maximise the information obtained from the study, especially for mode of action considerations, blood samples may be taken for haematology and clinical biochemistry, although this is at the discretion of the study director. Urinalysis may also be appropriate. Data on the animals used in the chronic toxicity phase of the study, normally of 12 months duration (paragraph 34) will provide information on these parameters. Further guidance on the value of taking such samples as part of a carcinogenicity study is provided in Guidance Document No 116 (7). If blood samples are taken, these should be collected at the end of the test period, just prior to or as part of the procedure for killing the animals. They should be taken from a named site, for example by cardiac puncture or from the retro-orbital sinus, under anaesthesia. Blood smears may also be prepared for examination, particularly if bone marrow appears to be the target organ, although the value of such examination of blood smears in the carcinogenicity phase for the assessment of carcinogenic/oncogenic potential has been questioned (38).

PATHOLOGY

Gross necropsy

54. All animals in the study except sentinel animals and other satellite animals (see paragraph 20) shall be subjected to a full, detailed gross necropsy which includes careful examination of the external surface of the body, all orifices, and the cranial, thoracic and abdominal cavities and their contents. Sentinel animals and other satellite animals may require necropsy on a case-by-case basis, at the discretion of the study director. Organ weights are not normally part of a carcinogenesis study, since geriatric changes and, at later stages, the development of tumours confounds the usefulness of organ weight data. They may, however, be critical to performing a weight of evidence evaluation and especially for mode of action considerations. If they are part of a satellite study, they should be collected at no later than one year after initiation of the study.
55. The following tissues should be preserved in the most appropriate fixation medium for both the type of tissue and the intended subsequent histopathological examination (40) (tissues in square brackets are optional):

all gross lesions	heart	pancreas	stomach (forestomach, glandular stomach)
adrenal gland	ileum	parathyroid gland	[teeth]
aorta	jejunum	peripheral nerve	testis
brain (including sections of cerebrum, cerebellum, and medulla/pons)	kidney	pituitary	thymus
caecum	lacrimal gland (exorbital)	prostate	thyroid
cervix	liver	rectum	[tongue]
coagulating gland	lung	salivary gland	trachea
colon	lymph nodes (both superficial and deep)	seminal vesicle	urinary bladder

▼ **M4**

duodenum	mammary gland (obligatory for females and, if visibly dissectable, from males)	skeletal muscle	uterus (including cervix)
epididymis	[upper respiratory tract, including nose, turbinates, and paranasal sinuses]	skin	[ureter]
eye (including retina)	oesophagus	spinal cord (at three levels: cervical, mid-thoracic, and lumbar)	[urethra]
[femur with joint]	[olfactory bulb]	spleen	vagina
gall bladder (for species other than rat)	ovary	[sternum],	section of bone marrow and/or a fresh bone marrow aspirate
Harderian gland			

In the case of paired organs, e.g. kidney, adrenal, both organs should be preserved. The clinical and other findings may suggest the need to examine additional tissues. Also, any organs considered likely to be target organs based on the known properties of the test chemical should be preserved. In studies involving the dermal route of administration, the list of organs as set out for the oral route should be examined, and specific sampling and preservation of the skin from the site of application is necessary. In inhalation studies, the list of preserved and examined tissues from the respiratory tract should follow the recommendations of Chapters B.8 of this Annex (8) and Chapter B.29 of this Annex (9). For other organs/tissues (and in addition to the specifically preserved tissues from the respiratory tract) the list of organs as set out for the oral route should be examined.

Histopathology

56. Guidance is available on best practices in the conduct of toxicological pathology studies (40). The minimum tissues examined should be:

- All tissues from the high dose and control groups;
- All tissues of animals dying or killed during the study;
- All tissues showing macroscopic abnormalities including tumours;
- When treatment-related histopathological changes are observed in the high dose group, those same tissues are to be examined from all animals in all other dose groups,
- In the case of paired organs, e.g. kidney, adrenal, both organs should be examined.

▼ M4**DATA AND REPORTING (CARCINOGENICITY AND CHRONIC TOXICITY)****Data**

57. Individual animal data should be provided for all parameters evaluated. Additionally, all data should be summarised in tabular form showing for each test group the number of animals at the start of the test, the number of animals found dead during the test or killed for humane reasons and the time of any death or humane kill, the number showing signs of toxicity, a description of the signs of toxicity observed, including time of onset, duration, and severity of any toxic effects, the number of animals showing lesions, the type of lesions and the percentage of animals displaying each type of lesion. Summary data tables should provide the means and standard deviations (for continuous test data) of animals showing toxic effects or lesions, in addition to the grading of lesions.
58. Historical control data may be valuable in the interpretation of the results of the study, e.g. in the case when there are indications that the data provided by the concurrent controls are substantially out of line when compared to recent data from control animals from the same test facility/colony. Historical control data, if evaluated, should be submitted from the same laboratory, relate to animals of the same age and strain, generated during the five years preceding the study in question.
59. When applicable, numerical results should be evaluated by an appropriate and generally acceptable statistical method. The statistical methods and the data to be analysed should be selected during the design of the study (paragraph 9). Selection should make provision for survival adjustments, if needed.
60. The test report should include the following information:

Test chemical:

- physical nature, purity, and physicochemical properties;
- identification data;
- source of chemical;
- batch number;
- certificate of chemical analysis.

Vehicle (if appropriate):

- justification for choice of vehicle (if other than water).

Test animals:

- species/strain used and justification for choice made;
- number, age, and sex of animals at start of test;
- source, housing conditions, diet, etc.;
- individual weights of animals at the start of the test.

▼ M4*Test conditions:*

- rationale for route of administration and dose selection;
- when applicable, the statistical methods used to analyse the data;
- details of test chemical formulation/diet preparation;
- analytical data on achieved concentration, stability and homogeneity of the preparation;
- route of administration and details of the administration of the test chemical;
- for inhalation studies, whether nose only or whole body;
- actual doses (mg/kg body weight/day), and conversion factor from diet/drinking water test chemical concentration (mg/kg or ppm) to the actual dose, if applicable;
- details of food and water quality.

*Results (summary tabulated data and individual animal data should be presented):**General*

- Survival data;
- Body weight/body weight changes;
- Food consumption, calculations of food efficiency, if made, and water consumption if applicable;
- Toxicokinetic data if available;
- Ophthalmoscopy (if available)
- Haematology (if available)
- Clinical chemistry (if available)

Clinical findings

- Signs of toxicity;
- Incidence (and, if scored, severity) of any abnormality;
- Nature, severity, and duration of clinical observations (whether transitory or permanent);

Necropsy data

- Terminal body weight;
- Organ weights and their ratios, if applicable;
- Necropsy findings; Incidence and severity of abnormalities.

Histopathology

- Non neoplastic histopathological findings,
- Neoplastic histopathological findings,

▼M4

- Correlation between gross and microscopic findings
- Detailed description of all treatment-related histopathological findings including severity gradings;
- Report of any peer review of slides

Statistical treatment of results, as appropriate

Discussion of results including:

- Discussion of any modelling approaches
- Dose:response relationships
- Historical control data
- Consideration of any mode of action information
- BMD, NOAEL or LOAEL determination
- Relevance for humans

Conclusions

LITERATURE:

- (1) OECD (1995). Report of the Consultation Meeting on Sub-chronic and Chronic Toxicity/Carcinogenicity Testing (Rome, 1995), internal working document, Environment Directorate, OECD, Paris.
- (2) EPA (2005). Guidelines for Carcinogen Risk Assessment Risk Assessment Forum U.S. Environmental Protection Agency Washington, DC.
- (3) Combes RD, Gaunt I, Balls M (2004). A Scientific and Animal Welfare Assessment of the OECD Health Effects Test Guidelines for the Safety Testing of Chemicals under the European Union REACH System. ATLA 32: 163-208
- (4) Barlow SM, Greig JB, Bridges JW et al (2002). Hazard identification by methods of animal-based toxicology. Food. Chem. Toxicol. 40: 145-191
- (5) Chhabra RS, Bucher JR, Wolfe M, Portier C (2003). Toxicity characterization of environmental chemicals by the US National Toxicology Programme: an overview. Int. J. Hyg. Environ. Health 206: 437-445
- (6) Chapter B.27 of this Annex, Sub-Chronic Oral Toxicity Test Repeated Dose 90 — Day Oral Toxicity Study In Non-Rodents.
- (7) OECD (2012). Guidance Document on the Design and Conduct of Chronic Toxicity and Carcinogenicity Studies, Supporting Test Guidelines 451, 452 and 453 — Second edition. Series on Testing and Assessment No 116, available on the OECD public website for Test Guideline at www.oecd.org/env/testguidelines.
- (8) OECD (2009). Guidance Document on Acute Inhalation Toxicity Testing. Series on Testing and Assessment No 39, ENV/JM/MONO(2009)28, OECD, Paris.
- (9) Chapter B.8 of this Annex. Subacute Inhalation Toxicity: 28-Day Study.
- (10) Chapter B.29 of this Annex, Subchronic Inhalation Toxicity: 90-Day Study.
- (11) Chapter B.9 of this Annex, Repeated Dose (28 Days) Toxicity (Dermal).

▼M4

- (12) Boobis AR, Cohen SM, Dellarco V, McGregor D, Meek ME, Vickers C, Willcocks D, Farland W (2006). IPCS Framework for analyzing the Relevance of a Cancer Mode of Action for Humans. *Crit. Rev. in Toxicol*, 36: 793-801.
- (13) Cohen SM, Meek ME, Klaunig JE, Patton DE, Fenner-Crisp PA (2003). The human relevance of information on carcinogenic Modes of Action: An Overview. *Crit. Rev. Toxicol*. 33: 581-589.
- (14) Holsapple MP, Pitot HC, Cohen SN, Boobis AR, Klaunig JE, Pastoor T, Dellarco VL, Dragan YP (2006). Mode of Action in Relevance of Rodent Liver Tumors to Human Cancer Risk. *Toxicol. Sci*. 89: 51-56.
- (15) Meek EM, Bucher JR, Cohen SM, Dellarco V, Hill RN, Lehman-McKemmon LD, Longfellow DG, Pastoor T, Seed J, Patton DE (2003). A Framework for Human Relevance analysis of Information on Carcinogenic Modes of Action. *Crit. Rev. Toxicol*. 33: 591-653.
- (16) Carmichael NG, Barton HA, Boobis AR *et al.* (2006). Agricultural Chemical Safety Assessment: A Multisector Approach to the Modernization of Human Safety Requirements. *Crit. Rev. Toxicol*. 36, 1-7.
- (17) Barton HA, Pastoor TP, Baetcke T *et al.* (2006). The Acquisition and Application of Absorption, Distribution, Metabolism, and Excretion (ADME) Data in Agricultural Chemical Safety Assessments. *Crit. Rev. Toxicol*. 36: 9-35.
- (18) Doe JE, Boobis AR, Blacker A *et al.* (2006). A Tiered Approach to Systemic Toxicity Testing for Agricultural Chemical Safety Assessment. *Crit. Rev. Toxicol*. 36: 37-68.
- (19) Cooper RL, Lamb JS, Barlow SM *et al.* (2006). A Tiered Approach to Life Stages Testing for Agricultural Chemical Safety Assessment. *Crit. Rev. Toxicol*. 36: 69-98.
- (20) OECD (2002). Guidance Notes for Analysis and Evaluation of Chronic Toxicity and Carcinogenicity Studies, Series on Testing and Assessment No 35 and Series on Pesticides No 14, ENV/JM/MONO(2002)19, OECD, Paris.
- (21) OECD (2000). Guidance Document on the recognition, assessment, and use of clinical signs as humane endpoints for experimental animals used in safety evaluation, Series on Testing and Assessment No 19, ENV/JM/MONO(2000)7, OECD, Paris.
- (22) Rhomberg LR, Baetcke K, Blancato J, Bus J, Cohen S, Conolly R, Dixit R, Doe J, Ekelman K, Fenner-Crisp P, Harvey P, Hattis D, Jacobs A, Jacobson-Kram D, Lewandowski T, Liteplo R, Pelkonen O, Rice J, Somers D, Turturro A, West W, Olin S (2007). Issues in the Design and Interpretation of Chronic Toxicity and Carcinogenicity Studies in Rodents: Approaches to Dose Selection *Crit Rev. Toxicol*. 37 (9): 729 – 837.
- (23) ILSI (International Life Sciences Institute) (1997). Principles for the Selection of Doses in Chronic Rodent Bioassays. Foran JA (Ed.). ILSI Press, Washington, DC.
- (24) Griffiths SA, Parkinson C, McAuslane JAN and Lumley CE (1994). The utility of the second rodent species in the carcinogenicity testing of pharmaceuticals. *The Toxicologist* 14(1):214.
- (25) Usui T, Griffiths SA and Lumley CE (1996). The utility of the mouse for the assessment of the carcinogenic potential of pharmaceuticals. In D'Arcy POF & Harron DWG (eds). Proceedings of the Third International Conference on Harmonisation. Queen's University Press, Belfast. pp 279-284.
- (26) Carmichael NG, Enzmann H, Pate I, Waechter F (1997). The Significance of Mouse Liver Tumor Formation for Carcinogenic Risk Assessment: Results and Conclusions from a Survey of 10 Years of Testing by the Agrochemical Industry. *Environ Health Perspect* 105:1196-1203.

▼ **M4**

- (27) Directive 2010/63/EU of the European parliament and of the Council of 22 September 2010 on the protection of animals used for scientific purposes (OJ L 276, 20.10.2010, p. 33).
- (28) National Research Council, 1985. Guide for the care and use of laboratory animals. NIH Publication No 86-23. Washington D.C., US. Dept. of Health and Human Services.
- (29) GV-SOLAS (Society for Laboratory Animal Science, Gesellschaft für Versuchstierkunde, December, 1989). Publication on the Planning and Structure of Animal Facilities for Institutes Performing Animal Experiments. ISBN 3-906255-06-9.
- (30) GV-SOLAS (Society for Laboratory Animal Science, Gesellschaft für Versuchstierkunde, 2006). Microbiological monitoring of laboratory animals in various housing systems.
- (31) Diehl K-H, Hull R, Morton D, Pfister R, Rabemampianina Y, Smith D, Vidal J-M, van de Vorstenbosch C. (2001). A good practice guide to the administration of substances and removal of blood, including routes and volumes. *Journal of Applied Toxicology*, 21: 15-23.
- (32) IPCS (1986). Principles and Methods for the Assessment of Neurotoxicity Associated with Exposure to Chemicals. Environmental Health Criteria Document No 60.
- (33) Tupper DE, Wallace RB (1980). Utility of the Neurologic Examination in Rats. *Acta Neurobiol. Exp.* 40: 999-1003.
- (34) Gad SC (1982). A Neuromuscular Screen for Use in Industrial Toxicology. *J. Toxicol. Environ. Health* 9: 691-704.
- (35) Moser VC, McDaniel KM, Phillips PM (1991). Rat Strain and Stock Comparisons Using a Functional Observational Battery: Baseline Values and Effects of Amitraz. *Toxicol. Appl. Pharmacol.* 108: 267-283.
- (36) Meyer OA, Tilson HA, Byrd WC, Riley MT (1979). A Method for the Routine Assessment of Fore- and Hind-limb Grip Strength of Rats and Mice. *Neurobehav. Toxicol.* 1: 233-236.
- (37) Crofton KM, Howard JL, Moser VC, Gill MW, Reiter LW, Tilson HA, MacPhail RC (1991). Interlaboratory Comparison of Motor Activity Experiments: Implication for Neurotoxicological Assessments. *Neurotoxicol. Teratol.* 13: 599-609.
- (38) Weingand K, Brown G, Hall R *et al.* (1996). Harmonisation of Animal Clinical Pathology Testing in Toxicity and Safety Studies. *Fundam. & Appl. Toxicol.* 29: 198-201.
- (39) EMEA (draft) document 'Non-clinical guideline on drug-induced hepatotoxicity' (Doc. Ref. EMEA/CHMP/SWP/a50115/2006).
- (40) Crissman JW, Goodman DG, Hildebrandt PK *et al.* (2004). Best Practices Guideline: Toxicological Histopathology. *Toxicologic Pathology* 32: 126-131.

▼ M4

Appendix 1

DEFINITION

Test chemical: Any substance or mixture tested using this Test Method.

▼ B**B.34. ONE-GENERATION REPRODUCTION TOXICITY TEST****1. METHOD****1.1. INTRODUCTION**

See General introduction Part B.

1.2. DEFINITIONS

See General introduction Part B.

1.3. REFERENCE SUBSTANCES

None.

1.4. PRINCIPLE OF THE TEST METHOD

The test substance is administered in graduated doses to several groups of males and females. Males should be dosed during growth and for at least one complete spermatogenic cycle (approximately 56 days in the mouse and 70 days in the rat) in order to elicit any adverse effects on spermatogenesis by the test substance.

Females of the parental (P) generation should be dosed for at least two complete oestrous cycles in order to elicit any adverse effects on oestrus by the test substance. The animals are then mated. The test substance is administered to both sexes during the mating period and thereafter only to females during pregnancy and for the duration of the nursing period. For administration by inhalation the method will require modification.

1.5. QUALITY CRITERIA

None.

1.6. DESCRIPTION OF THE TEST METHOD**1.6.1. Preparations**

Before the test, healthy young adult animals are randomised and assigned to the treated and control groups. The animals are kept under the experimental housing and feeding conditions for at least five days prior to the test. It is recommended that the test substance be administered in the diet or drinking water. Other routes of administration are also acceptable. All animals should be dosed by the same method during the appropriate experimental period. If a vehicle or other additives are used to facilitate dosing, they should be known not to produce toxic effects. Dosing should be on a seven-day per week basis.

▼B1.6.2. *Experimental animals*

Selection of species

The rat or mouse are the preferred species. Healthy animals, not subjected to previous experimental procedures, should be used. Strains with low fecundity should not be used. The test animals should be characterized as to species, strain, sex, weight and/or age.

For an adequate assessment of fertility, both males and females should be studied. All test and control animals should be weaned before dosing begins.

Number and sex

Each treated and control group should contain a sufficient number of animals to yield about 20 pregnant females at or near term.

The objective is to produce enough pregnancies and offspring to assure a meaningful evaluation of the potential of the substance to affect fertility, pregnancy and maternal behaviour in P generation animals and suckling, growth and development of the F₁ offspring from conception to weaning.

1.6.3. *Test conditions*

Food and water should be provided ad libitum. Near parturition, pregnant females should be caged separately in delivery or maternity cages and may be provided with nesting materials.

1.6.3.1. *Dose levels*

At least three treated groups and a control group should be used. If a vehicle is used in administering the test substance, the control group should receive the vehicle in the highest volume used. If a test substance causes reduced dietary intake or utilisation, then the use of a paired fed control group may be considered necessary. Ideally, unless limited by the physical/chemical nature or biological effects of the test substance, the highest dose level should induce toxicity but not mortality in the parental (P) animals. The intermediate dose(s) should induce minimal toxic effects attributable to the test substance, and the low dose should not induce any observable adverse effects on the parents or offspring. When administered by gavage or capsule the dosage given to each animal should be based on the individual animal's body weight and adjusted weekly for changes in body weight. For females during pregnancy, dosages may be based on the body weight at day 0 or 6 of the pregnancy, if desired.

1.6.3.2. *Limit test*

In the case of substances of low toxicity, if a dose level of at least 1 000 mg/kilogram produces no evidence of interference with reproductive performance, studies at other dose levels may not be considered necessary. If a preliminary study at the high-dose level, with definite evidence of maternal toxicity, shows no adverse effects on fertility, studies at other dose levels may not be considered necessary.

▼B1.6.3.3. *Performance of the test**Experimental schedules*

Daily dosing of the parental (P) males should begin when they are about five to nine weeks of age, after they have been weaned and acclimatised for at least five days. In rats, dosing is continued for 10 weeks prior to the mating period (for mice, eight weeks). Males should be killed and examined either at the end of the mating period or, alternatively, males may be retained on the test diet for the possible production of a second litter and should be killed and examined at some time before the end of the study. For parental (P) females dosing should begin after at least five days of acclimatisation and continue for at least two weeks prior to mating. Daily dosing of the p females should continue throughout the three-week mating period, pregnancy and up to the weaning of the F₁ offspring. Consideration should be given to modification of the dosing schedule based on other available information on the test substance, such as induction of metabolism or bioaccumulation.

Mating procedure

Either 1:1 (one male to one female) or 1:2 (one male to two females) mating may be used in reproduction toxicity studies.

Based on 1:1 mating, one female should be placed with the same male until pregnancy occurs or three weeks have elapsed. Each morning the females should be examined for presence of sperm or vaginal plugs. Day 0 of pregnancy is defined as the day a vaginal plug or sperm is found.

Those pairs that fail to mate should be evaluated to determine the cause of the apparent infertility.

This may involve such procedures as providing additional opportunities to mate with other proven sires or dams, microscopic examination of the reproductive organs, and examination of the oestrous cycle or spermatogenesis.

Litter sizes

Animals dosed during the fertility study are allowed to litter normally and rear their progeny to the stage of weaning without standardisation of litters.

Where standardisation is done, the following procedure is suggested. Between day 1 and day 4 after birth, the size of each litter may be adjusted by eliminating extra pups by selection to yield, as nearly as possible, four males and four females per litter.

Whenever the number of male or female pups prevents having four of each sex per litter, partial adjustment (for example, five males and three females) is acceptable. Adjustments are not applicable for litters of less than eight pups.

▼ B

1.6.4. Observations

Throughout the test period, each animal should be observed at least once daily. Pertinent behavioural changes, signs of difficult or prolonged parturition, and all signs of toxicity, including mortality, should be recorded. During pre-mating and mating periods, food consumption may be measured daily. After parturition and during lactation, food consumption measurements (and water consumption measurements when the test substance is administered in the drinking water) should be made on the same day as the weighing of the litter. P males and females should be weighed on the first day of dosing and weekly thereafter. These observations should be reported individually for each adult animal.

The duration of gestation should be calculated from day 0 of pregnancy. Each litter should be examined as soon as possible after delivery to establish the number and sex of pups, still births, live births and the presence of gross anomalies.

Dead pups and pups sacrificed at day 4 should be preserved and studied for possible defects. Live pups should be counted and litters weighed on the morning after birth and on days 4 and 7 and weekly thereafter until the termination of the study, when animals should be weighed individually.

Physical or behavioural abnormalities observed in the dams or offspring should be recorded.

1.6.5. Pathology

1.6.5.1. Necropsy

At the time of sacrifice or death during the study the animals of the P generation should be examined macroscopically for any structural abnormalities or pathological changes, with special attention being paid to the organs of the reproductive system. Dead or moribund pups should be examined for defects.

1.6.5.2. Histopathology

The ovaries, uterus, cervix, vagina, testes, epididymes, seminal vesicles, prostate, coagulating gland, pituitary gland and target organ(s) of all P animals should be preserved for microscopic examination. In the event that these organs have not been examined in other multiple-dose studies, they should be microscopically examined in all high-dose and control animals and animals which die during the study where practicable.

Organs showing abnormalities in these animals should then be examined in all other P animals. In these instances, microscopic examination should be made of all tissues showing gross pathological changes. As suggested under mating procedures, reproductive organs of animals suspected of infertility may be subjected to microscopic examination.

▼ B**2. DATA**

Data may be summarised in tabular form, showing for each test group the number of animals at the start of the test, the number of fertile males, the number of pregnant females, the types of changes and the percentage of animals displaying each type of change.

When possible, numerical results should be evaluated by an appropriate statistical method. Any generally accepted statistical method may be used.

3. REPORTING**TEST REPORT**

The test report shall, if possible, contain the following information:

- species/strain used,
- toxic response data by sex and dose, including fertility, gestation and viability,
- time of death during the study or whether animals survived to time of scheduled sacrifice or to termination of the study,
- table presenting the weights of each litter, the mean: pup weights and the individual weights of the pups at termination,
- toxic or other effects on reproduction, offspring and postnatal growth,
- the day of observation of each abnormal sign and its subsequent course,
- bodyweight data for P animals,
- necropsy findings,
- a detailed description of all microscopic findings,
- statistical treatment of results, where appropriate,
- discussion of the results,
- interpretation of the results.

3.2. EVALUATION AND INTERPRETATION

See General introduction Part B.

4. REFERENCES

See General introduction Part B.

▼B**B.35. TWO-GENERATION REPRODUCTION TOXICITY STUDY****1. METHOD**

This method is a replicate of the OECD TG 416 (2001).

1.1. INTRODUCTION

This method for two-generation reproduction testing is designed to provide general information concerning the effects of a test substance on the integrity and performance of the male and female reproductive systems, including gonadal function, the oestrus cycle, mating behaviour, conception, gestation, parturition, lactation, and weaning, and the growth and development of the offspring. The study may also provide information about the effects of the test substance on neonatal morbidity, mortality, and preliminary data on prenatal and postnatal developmental toxicity and serve as a guide for subsequent tests. In addition to studying growth and development of the F1 generation, this test method is also intended to assess the integrity and performance of the male and female reproductive systems as well as growth and development of the F2 generation. For further information on developmental toxicity and functional deficiencies, either additional study segments can be incorporated into this protocol, consulting the methods for developmental toxicity and/or developmental neurotoxicity as appropriate, or these endpoints could be studied in separate studies, using the appropriate test methods.

1.2. PRINCIPLE OF THE TEST METHOD

The test substance is administered in graduated doses to several groups of males and females. Males of the P generation should be dosed during growth and for at least one complete spermatogenic cycle (approximately 56 days in the mouse and 70 days in the rat) in order to elicit any adverse effects on spermatogenesis. Effects on sperm are determined by a number of sperm parameters (e.g. sperm morphology and motility) and in tissue preparation and detailed histopathology. If data on spermatogenesis are available from a previous repeated dose study of sufficient duration, e.g. a 90-day study, males of the P generation need not be included in the evaluation. It is recommended, however, that samples or digital recordings of sperm of the P generation are saved, to enable later evaluation. Females of the P generation should be dosed during growth and for several complete oestrus cycles in order to detect any adverse effects on oestrus cycle normality by the test substance. The test substance is administered to parental (P) animals during their mating, during the resulting pregnancies, and through the weaning of their F1 offspring. At weaning the administration of the substance is continued to F1 offspring during their growth into adulthood, mating and production of an F2 generation, until the F2 generation is weaned.

Clinical observations and pathological examinations are performed on all animals for signs of toxicity with special emphasis on effects on the integrity and performance of the male and female reproductive systems and on the growth and development of the offspring.

▼B

1.3. DESCRIPTION OF THE TEST METHOD

1.3.1. **Selection of animal species**

The rat is the preferred species for testing. If other species are used, justification should be given and appropriate modifications will be necessary. Strains with low fecundity or well-known high incidence of developmental defects should not be used. At the commencement of the study, the weight variation of animals used should be minimal and not exceed 20 % of the mean weight of each sex.

1.3.2. **Housing and feeding conditions**

The temperature in the experimental animal room should be 22 °C ($\pm 3^\circ$). Although the relative humidity should be at least 30 % and preferably not exceed 70 % other than during room cleaning, the aim should be 50-60 %. Lighting should be artificial, the sequence being 12 hours light, 12 hours dark. For feeding, conventional laboratory diets may be used with an unlimited supply of drinking water. The choice of diet may be influenced by the need to ensure a suitable admixture of a test substance when administered by this method.

Animals may be housed individually or be caged in small groups of the same sex. Mating procedures should be carried out in cages suitable for the purpose. After evidence of copulation, mated females shall be single-caged in delivery or maternity cages. Mated rats may also be kept in small groups and separated one or two days prior to parturition. Mated animals shall be provided with appropriate and defined nesting materials when parturition is near.

1.3.3. **Preparation of animals**

Healthy young animals, which have been acclimated to laboratory conditions for at least five days and have not been subjected to previous experimental procedures, should be used. The test animals should be characterised as to species, strain, source, sex, weight and/or age. Any sibling relationships among the animals should be known so that mating of siblings is avoided. The animals should be randomly assigned to the control and treated groups (stratification by body weight is recommended). Cages should be arranged in such a way that possible effects due to cage placement are minimised. Each animal should be assigned a unique identification number. For the P generation, this should be done before dosing starts. For the F1 generation, this should be done at weaning for animals selected for mating. Records indicating the litter of origin should be maintained for all selected F1 animals. In addition, individual identification of pups as soon after birth as possible is recommended when individual weighing of pups or any functional tests are considered.

Parental (P) animals shall be about five to nine weeks old at the start of dosing. The animals of all test groups shall, as nearly as practicable, be of uniform weight and age.

▼B

1.4. PROCEDURE

1.4.1. **Number and sex of animals**

Each test and control group should contain a sufficient number of animals to yield preferably not less than 20 pregnant females at or near parturition. For substances that cause undesirable treatment related effects (e.g. sterility, excessive toxicity at the high dose) this may not be possible. The objective is to produce enough pregnancies to assure a meaningful evaluation of the potential of the substance to affect fertility, pregnancy and maternal behaviour and suckling, growth and development of the F1 offspring from conception to maturity, and the development of their offspring (F2) to weaning. Therefore, failure to achieve the desired number of pregnant animals (i.e. 20) does not necessarily invalidate the study and should be evaluated on a case-by-case basis.

1.4.2. **Preparation of doses**

It is recommended that the test substance be administered orally (by diet, drinking water or gavage) unless another route of administration (e.g. dermal or inhalation) is considered more appropriate.

Where necessary, the test substance is dissolved or suspended in a suitable vehicle. It is recommended that, wherever possible, the use of an aqueous solution/suspension be considered first, followed by consideration of a solution/emulsion in oil (e.g. corn oil) and then by possible solution in other vehicles. For vehicles other than water, the toxic characteristics of the vehicle must be known. The stability of the test substance in the vehicle should be determined.

1.4.3. **Dosage**

At least three dose levels and a concurrent control shall be used. Unless limited by the physical-chemical nature or biological effects of the test substance, the highest dose level should be chosen with the aim to induce toxicity but not death or severe suffering. In case of unexpected mortality, studies with a mortality rate of less than approximately 10 % in the parental (P) animals would normally still be acceptable. A descending sequence of dose levels should be selected with a view to demonstrating any dosage related effect and no-observed-adverse-effects levels (NOAEL). Two to four fold intervals are frequently optimal for setting the descending dose levels and addition of a fourth test group is often preferable to using very large intervals (e.g. more than a factor of 10) between dosages. For the dietary studies the dose interval should be not more than three fold. Dose levels should be selected taking into account any existing toxicity data, especially results from repeated dose studies. Any available information on metabolism and kinetics of the test compound or related materials should also be considered. In addition, this information will also assist in demonstrating the adequacy of the dosing regimen.

▼B

The control group shall be an untreated group or a vehicle-control group if a vehicle is used in administering the test substance. Except for treatment with the test substance, animals in the control group should be handled in an identical manner to the test group subjects. If a vehicle is used, the control group shall receive the vehicle in the highest volume used. If a test substance is administered in the diet, and causes reduced dietary intake or utilisation, then the use of a pair-fed control group may be considered necessary. Alternatively data from controlled studies designed to evaluate the effects of decreased food consumption on reproductive parameters may be used in lieu of a concurrent pair-fed control group.

Consideration should be given to the following characteristics of vehicle and other additives: effects on the absorption, distribution, metabolism, or retention of the test substance; effects on the chemical properties of the test substance which may alter its toxic characteristics; and effects on the food or water consumption or the nutritional status of the animals.

1.4.4. Limit test

If an oral study at one dose level of at least 1 000 mg/kg body weight/day or, for dietary or drinking water administration, an equivalent percentage in the diet or drinking water using the procedures described for this study, produces no observable toxic effects in either parental animals or their offspring and if toxicity would not be expected based upon data from structurally and/or metabolically related compounds, then a full study using several dose levels may not be considered necessary. The limit test applies except when human exposure indicates the need for a higher oral dose level to be used. For other types of administration, such as inhalation or dermal application, the physical-chemical properties of the test substance, such as solubility, often may indicate and limit the maximum attainable level of exposure.

1.4.5. Administration of doses

The animals should be dosed with the test substance on a 7-days per week basis. The oral route of administration (diet, drinking water, or gavage) is preferred. If another route of administration is used, justification shall be provided, and appropriate modifications may be necessary. All animals shall be dosed by the same method during the appropriate experimental period. When the test substance is administered by gavage, this should be done using a stomach tube. The volume of liquid administered at one time should not exceed 1 ml/100 g body weight (0,4 ml/100 g body weight is the maximum for corn oil), except in the case of aqueous solutions where 2 ml/100 g body weight may be used. Except for irritant or corrosive substances, which will normally reveal exacerbated effects with higher concentrations, variability in test volume should be minimised by adjusting the concentration to ensure a constant volume at all dose levels. In gavage studies, the pups will normally only receive test substance indirectly through the milk, until direct dosing commences for them at weaning. In diet or drinking water studies, the pups will additionally receive test substance directly when they commence eating for themselves during the last week of the lactation period.

▼ B

For substances administered via the diet or drinking water, it is important to ensure that the quantities of the test substance involved do not interfere with normal nutrition or water balance. When the test substance is administered in the diet either a constant dietary concentration (ppm) or a constant dose level in terms of the body weight of the animal may be used; the alternative used must be specified. For a substance administered by gavage, the dose should be given at similar times each day, and adjusted at least weekly to maintain a constant dose level in terms of animal body weight. Information regarding placental distribution should be considered when adjusting the gavage dose based on weight.

1.4.6. Experimental schedules

Daily dosing of the parental (P) males and females shall begin when they are five to nine weeks old. Daily dosing of the F1 males and females shall begin at weaning; it should be kept in mind that in cases of test substance administration via diet or drinking water, direct exposure of the F1 pups to the test substance may already occur during the lactation period. For both sexes (P and F1), dosing shall be continued for at least 10 weeks before the mating period. Dosing is continued in both sexes during the two week mating period. Males should be humanely killed and examined when they are no longer needed for assessment of reproductive effects. For parental (P) females, dosing should continue throughout pregnancy and up to the weaning of the F1 offspring. Consideration should be given to modifications in the dosing schedule based on available information on the test substance, including existing toxicity data, induction of metabolism or bioaccumulation. The dose to each animal should normally be based on the most recent individual body weight determination. However, caution should be exercised when adjusting the dose during the last trimester of pregnancy.

Treatment of the P and F1 males and females shall continue until termination. All P and F1 adult males and females should be humanely killed when they are no longer needed for assessment of reproductive effects. F1 offspring not selected for mating and all F2 offspring should be humanely killed after weaning.

1.4.7. Mating procedure**1.4.7.1. Parental (P) mating**

For each mating, each female shall be placed with a single male from the same dose level (1:1 mating) until copulation occurs or two weeks have elapsed. Each day, the females shall be examined for presence of sperm or vaginal plugs. Day 0 of pregnancy is defined as the day a vaginal plug or sperm are found. In case pairing is unsuccessful, re-mating of females with proven males of the same group could be considered. Mating pairs should be clearly identified in the data. Mating of siblings should be avoided.

▼ B1.4.7.2. *F1 mating*

For mating the F1 offspring, at least one male and one female should be selected at weaning from each litter for mating with other pups of the same dose level but different litter, to produce the F2 generation. Selection of pups from each litter should be random when no significant differences are observed in body weight or appearance between the litter mates. In case these differences are observed, the best representatives of each litter should be selected. Pragmatically, this is best done on a body weight basis but it may be more appropriate on the basis of appearance. The F1 offspring should not be mated until they have attained full sexual maturity.

Pairs without progeny should be evaluated to determine the apparent cause of the infertility. This may involve such procedures as additional opportunities to mate with other proven sires or dams, microscopic examination of the reproductive organs, and examination of the oestrous cycles or spermatogenesis.

1.4.7.3. *Second mating*

In certain instances, such as treatment-related alterations in litter size or the observation of an equivocal effect in the first mating, it is recommended that the P or F1 adults be remated to produce a second litter. It is recommended to remate females or males, which have not produced a litter with proven breeders of the opposite sex. If production of a second litter is deemed necessary in either generation, animals should be remated approximately one week after weaning of the last litter.

1.4.7.4. *Litter size*

Animals shall be allowed to litter normally and rear their offspring to weaning. Standardisation of litter sizes is optional. When standardisation is done, the method used should be described in detail.

1.5. OBSERVATIONS

1.5.1. **Clinical observations**

A general clinical observation should be made each day and, and in the case of gavage dosing its timing should take into account the anticipated peak period of effects after dosing. Behavioural changes, signs of difficult or prolonged parturition and all signs of toxicity should be recorded. An additional, more detailed examination of each animal should be conducted on at least a weekly basis and could conveniently be performed on an occasion when the animal is weighed. Twice daily, during the weekend once daily when appropriate, all animals should be observed for morbidity and mortality.

▼B**1.5.2. Body weight and food/water consumption of parent animals**

Parental animals (P and F1) shall be weighed on the first day of dosing and at least weekly thereafter. Parental females (P and F1) shall be weighed at a minimum on gestation days 0, 7, 14, and 20 or 21, and during lactation on the same days as the weighing of litters and on the day the animals are killed. These observations should be reported individually for each adult animal. During the pre-mating and gestation periods food consumption shall be measured weekly at a minimum. Water consumption shall be measured weekly at a minimum if the test substance is administered in the water.

1.5.3. Oestrus cycle

Estrous cycle length and normality are evaluated in P and F1 females by vaginal smears prior to mating, and optionally during mating, until evidence of mating is found. When obtaining vaginal/cervical cells, care should be taken to avoid disturbance of mucosa and subsequently, the induction of pseudopregnancy (1).

1.5.4. Sperm parameters

For all P and F1 males at termination, testis and epididymis weight shall be recorded and one of each organ reserved for histopathological examination (see Section 1.5.7, 1.5.8.1). Of a subset of at least 10 males of each group of P and F1 males, the remaining testes and epididymides should be used for enumeration of homogenisation-resistant spermatids and cauda epididymal sperm reserves, respectively. For this same subset of males, sperm from the cauda epididymides or vas deferens should be collected for evaluation of sperm motility and sperm morphology. If treatment-related effects are observed or when there is evidence from other studies of possible effects on spermatogenesis, sperm evaluation should be conducted in all males in each dose group; otherwise enumeration may be restricted to control and high-dose P and F1 males.

The total number of homogenisation-resistant testicular spermatids and cauda epididymal sperm should be enumerated (2)(3). Cauda sperm reserves can be derived from the concentration and volume of sperm in the suspension used to complete the qualitative evaluations, and the number of sperm recovered by subsequent mincing and/or homogenising of the remaining cauda tissue. Enumeration should be performed on the selected subset of males of all dose groups immediately after killing the animals unless video or digital recordings are made, or unless the specimens are frozen and analysed later. In these instances, the controls and high dose group may be analysed first. If no treatment-related effects (e.g. effects on sperm count, motility, or morphology) are seen the other dose groups need not be analysed. When treatment-related effects are noted in the high-dose group, then the lower dose groups should also be evaluated.

▼ B

Epididymal (or ductus deferens) sperm motility should be evaluated or video taped immediately after sacrifice. Sperm should be recovered while minimising damage, and diluted for motility analysis using acceptable methods (4). The percentage of progressively motile sperm should be determined either subjectively or objectively. When computer-assisted motion analysis is performed (5)(6)(7)(8)(9)(10) the derivation of progressive motility relies on user-defined thresholds for average path velocity and straightness or linear index. If samples are videotaped (11) or the images are otherwise recorded at the time of necropsy, subsequent analysis of only control and high-dose P and F1 males may be performed unless treatment-related effects are observed; in that case, the lower dose groups should also be evaluated. In the absence of a video or digital image, all samples in all treatment groups should be analysed at necropsy.

A morphological evaluation of an epididymal (or *vas deferens*) sperm sample should be performed. Sperm (at least 200 per sample) should be examined as fixed, wet preparations (12) and classified as either normal or abnormal. Examples of morphologic sperm abnormalities would include fusion, isolated heads, and misshapen heads and/or tails. Evaluation should be performed on the selected subset of males of all dose groups either immediately after killing the animals, or, based on the video or digital recordings, at a later time. Smears, once fixed, can also be read at a later time. In these instances, the controls and high dose group may be analysed first. If no treatment-related effects (e.g. effects on sperm morphology) are seen the other dose groups need not be analysed. When treatment-related effects are noted in the high-dose group, then the lower dose groups should also be evaluated.

If any of the above sperm evaluation parameters have already been examined as part of a systemic toxicity study of at least 90 days, they need not necessarily be repeated in the two-generation study. It is recommended, however, that samples or digital recordings of sperm of the P generation are saved, to enable later evaluation, if necessary.

1.5.5. Offspring

Each litter should be examined as soon as possible after delivery (lactation day 0) to establish the number and sex of pups, stillbirths, live births, and the presence of gross anomalies. Pups found dead on day 0, if not macerated, should preferably be examined for possible defects and cause of death and preserved. Live pups should be counted and weighed individually at birth (lactation day 0) or on day 1, and on regular weigh days thereafter, e.g. on days 4, 7, 14, and 21 of lactation. Physical or behavioural abnormalities observed in the dams or offspring should be recorded.

▼B

Physical development of the offspring should be recorded mainly by body weight gain. Other physical parameters (e.g. ear and eye opening, tooth eruption, hair growth) may give supplementary information, but these data should preferably be evaluated in the context of data on sexual maturation (e.g. age and body weight at vaginal opening or balano-preputial separation) (13). Functional investigations (e.g. motor activity, sensory function, reflex ontogeny) of the F1 offspring before and/or after weaning, particularly those related to sexual maturation, are recommended if such investigations are not included in separate studies. The age of vaginal opening and preputial separation should be determined for F1 weanlings selected for mating. Anogenital distance should be measured at postnatal day 0 in F2 pups if triggered by alterations in F1 sex ratio or timing of sexual maturation.

Functional observations may be omitted in groups that otherwise reveal clear signs of adverse effects (e.g. significant decrease in weight gain, etc.). If functional investigations are made, they should not be done on pups selected for mating.

1.5.6. Gross necropsy

At the time of termination or death during the study, all parental animals (P and F1), all pups with external abnormalities or clinical signs, as well as one randomly selected pup/sex/litter from both the F1 and F2 generation, shall be examined macroscopically for any structural abnormalities or pathological changes. Special attention should be paid to the organs of the reproductive system. Pups that are humanely killed in a moribund condition and dead pups, when not macerated, should be examined for possible defects and/or cause of death and preserved.

The uteri of all primiparous females should be examined, in a manner which does not compromise histopathological evaluation, for the presence and number of implantation sites.

1.5.7. Organ weights

At the time of termination, body weight and the weight of the following organs of all P and F1 parental animals shall be determined (paired organs should be weighed individually):

- uterus, ovaries,

- testes, epididymides (total and cauda),

- prostate,

- seminal vesicles with coagulating glands and their fluids and prostate (as one unit),

- brain, liver, kidneys, spleen, pituitary, thyroid and adrenal glands and known target organs.

Terminal body weights should be determined for F1 and F2 pups that are selected for necropsy. The following organs from the one randomly selected pup/sex/litter (see Section 1.5.6) shall be weighed: Brain, spleen and thymus.

▼ B

Gross necropsy and organ weight results should be assessed in context with observations made in other repeated dose studies, when feasible.

1.5.8. **Histopathology**

1.5.8.1. *Parental animals*

The following organs and tissues of parental (P and F1) animals, or representative samples thereof, shall be fixed and stored in a suitable medium for histopathological examination.

- Vagina, uterus with cervix, and ovaries (preserved in appropriate fixative),
- one testis (preserved in Bouin's or comparable fixative), one epididymis, seminal vesicles, prostate, and coagulating gland,
- previously identified target organ(s) from all P and F1 animals selected for mating.

Full histopathology of the preserved organs and tissues listed above should be performed for all high dose and control P and F1 animals selected for mating. Examination of the ovaries of the P animals is optional. Organs demonstrating treatment-related changes should also be examined in the low- and mid-dose groups to aid in the elucidation of the NOAEL. Additionally, reproductive organs of the low- and mid-dose animals suspected of reduced fertility, e.g. those that failed to mate, conceive, sire, or deliver healthy offspring, or for which oestrus cyclicity or sperm number, motility, or morphology were affected, should be subjected to histopathological evaluation. All gross lesions such as atrophy or tumours shall be examined.

Detailed testicular histopathological examination (e.g. using Bouin's fixative, paraffin embedding and transverse sections of 4-5 µm thickness) should be conducted in order to identify treatment-related effects such as retained spermatids, missing germ cell layers or types, multinucleated giant cells or sloughing of spermatogenic cells into the lumen (14). Examination of the intact epididymis should include the caput, corpus, and cauda, which can be accomplished by evaluation of a longitudinal section. The epididymis should be evaluated for leukocyte infiltration, change in prevalence of cell types, aberrant cell types, and phagocytosis of sperm. PAS and haematoxylin staining may be used for examination of the male reproductive organs.

The postlactational ovary should contain primordial and growing follicles as well as the large corpora lutea of lactation. Histopathological examination should detect qualitative depletion of the primordial follicle population. A quantitative evaluation of primordial follicles should be conducted for F1 females; the number of animals, ovarian section selection, and section sample size should be statistically appropriate for the evaluation procedure used. Examination should include enumeration of the number of primordial follicles, which can be combined with small growing follicles, for comparison of treated and control ovaries (15)(16)(17)(18)(19).

▼ B1.5.8.2. *Weanlings*

Grossly abnormal tissue and target organs from all pups with external abnormalities or clinical signs, as well as from the one randomly selected pup/sex/litter from both the F1 and F2 generation which have not been selected for mating, shall be fixed and stored in a suitable medium for histopathological examination. Full histopathological characterisation of preserved tissue should be performed with special emphasis on the organs of the reproductive system.

2. **DATA**

2.1. TREATMENT OF RESULTS

Data shall be reported individually and summarised in tabular form, showing for each test group and each generation the number of animals at the start of the test, the number of animals found dead during the test or killed for humane reasons, the time of any death or humane kill, the number of fertile animals, the number of pregnant females, the number of animals showing signs of toxicity, a description of the signs of toxicity observed, including time of onset, duration, and severity of any toxic effects, the types of parental and offspring observations, the types of histopathological changes, and all relevant litter data.

Numerical results should be evaluated by an appropriate, generally accepted statistical method; the statistical methods should be selected as part of the design of the study and should be justified. Dose-response statistical models may be useful for analysing data. The report should include sufficient information on the method of analysis and the computer program employed, so that an independent reviewer/statistician can re-evaluate and reconstruct the analysis.

2.2. EVALUATION OF RESULTS

The findings of this two-generation reproduction toxicity study should be evaluated in terms of the observed effects including necropsy and microscopic findings. The evaluation will include the relationship, or lack thereof, between the dose of the test substance and the presence or absence, incidence and severity of abnormalities, including gross lesions, identified target organs, affected fertility, clinical abnormalities, affected reproductive and litter performance, body weight changes, effects on mortality and any other toxic effects. The physico-chemical properties of the test substance, and when available, toxicokinetics data should be taken into consideration when evaluating test results.

A properly conducted reproduction toxicity test should provide a satisfactory estimation of a no-effect level and an understanding of adverse effects on reproduction, parturition, lactation, postnatal development including growth and sexual development.

▼B

2.3. INTERPRETATION OF RESULTS

A two-generation reproduction toxicity study will provide information on the effects of repeated exposure to a substance during all phases of the reproductive cycle. In particular, the study provides information on the reproductive parameters, and on development, growth, maturation and survival of offspring. The results of the study should be interpreted in conjunction with the findings from subchronic, prenatal developmental and toxicokinetic and other available studies. The results of this study can be used in assessing the need for further testing of a chemical. Extrapolation of the results of the study to man is valid to a limited degree. They are best used to provide information on no-effect-levels and permissible human exposure (20)(21)(22)(23).

3. **REPORTING**

3.1. TEST REPORT

The test report must include the following information:

Test substance:

- physical nature and, where relevant, physicochemical properties,
- identification data,
- purity.

Vehicle (if appropriate):

- justification for choice of vehicle if other than water.

Test animals:

- species/strain used,
- number, age and sex of animals,
- source, housing conditions, diet, nesting materials, etc.,
- individual weights of animals at the start of the test.

Test conditions:

- rationale for dose level selection,
- details of test substance formulation/diet preparation, achieved concentrations,
- stability and homogeneity of the preparation,
- details of the administration of the test substance,
- conversion from diet/drinking water test substance concentration (ppm) to the achieved dose (mg/kg body weight/day), if applicable,
- details of food and water quality.

▼ B

Results:

- food consumption, and water consumption if available, food efficiency (body weight gain per gram of food consumed), and test material consumption for P and F1 animals, except for the period of cohabitation and for at least the last third of lactation,
- absorption data (if available),
- body weight data for P and F1 animals selected for mating,
- litter and pup weight data,
- body weight at sacrifice and absolute and relative organ weight data for the parental animals,
- nature, severity and duration of clinical observations (whether reversible or not),
- time of death during the study or whether animals survived to termination,
- toxic response data by sex and dose, including indices of mating, fertility, gestation, birth, viability, and lactation; the report should indicate the numbers used in calculating these indices,
- toxic or other effects on reproduction, offspring, post-natal growth, etc.,
- necropsy findings,
- detailed description of all histopathological findings,
- number of P and F1 females cycling normally and cycle length,
- total cauda epididymal sperm number, percent progressively motile sperm, percent morphologically normal sperm, and percent of sperm with each identified abnormality,
- time-to-mating, including the number of days until mating,
- gestation length,
- number of implantations, corpora lutea, litter size,
- number of live births and post-implantation loss,
- number of pups with grossly visible abnormalities, if determined the number of runts should be reported,
- data on physical landmarks in pups and other post natal developmental data, physical landmarks evaluated should be justified,
- data on functional observations in pups and adults, as applicable,
- statistical treatment of results, where appropriate.

▼B

Discussion of results.

Conclusions, including NOAEL values for maternal and offspring effects.

4.

REFERENCES

- (1) Sadleir, R.M.F.S., (1979) Cycles and Seasons, In: *Reproduction in Mammals: I. Germ Cells and Fertilisation*, C.R. Auston and R.V. Short (eds.), Cambridge, New York.
- (2) Gray, L.E. et al., (1989) A Dose-Response Analysis of Methoxychlor-Induced Alterations of Reproductive Development and Function in the Rat. *Fundamental and Applied Toxicology*, 12, p. 92-108.
- (3) Robb, G.W. et al., (1978). Daily Sperm Production and Epididymal Sperm Reserves of Pubertal and Adult Rats. *Journal of Reproduction and Fertility* 54:103-107.
- (4) Klinefelter, G.R. et al., (1991) The Method of Sperm Collection Significantly Influences Sperm Motion Parameters Following Ethane Dimethanesulfonate Administration in the Rat. *Reproductive Toxicology*, 5, p. 39-44.
- (5) Seed, J. et al., (1996). Methods for Assessing Sperm Motility, Morphology, and Counts in the Rat, Rabbit, and Dog: a Consensus Report. *Reproductive Toxicology*, 10(3), p. 237-244.
- (6) Chapin, R.E. et al., (1992) Methods for Assessing Rat Sperm Motility. *Reproductive Toxicology*, 6, p. 267-273
- (7) Klinefelter, G.R. et al., (1992) Direct Effects of Ethane Dimethanesulphonate on Epididymal Function in Adult Rats: an *In Vitro* Demonstration. *Journal of Andrology*, 13, p. 409-421.
- (8) Slott, V.L. et al., (1991) Rat Sperm Motility Analysis: Methodologic Considerations. *Reproductive Toxicology*, 5, p. 449-458.
- (9) Slott, V.L. and Perreault, S.D., (1993) Computer-Assisted Sperm Analysis of Rodent Epididymal Sperm Motility Using the Hamilton-Thorn Motility Analyzer. In: *Methods in Toxicology*, Part A., Academic, Orlando, Florida, p. 319-333.
- (10) Toth, G.P. et al., (1989) The Automated Analysis of Rat Sperm Motility Following Subchronic Epichlorhydrin Administration: Methodologic and Statistical Considerations. *Journal of Andrology*, 10, p. 401-415.
- (11) Working, P.K. and M. Hurtt, (1987) Computerised Videomicrographic Analysis of Rat Sperm Motility. *Journal of Andrology*, 8, p. 330-337.
- (12) Linder, R.E. et al., (1992) Endpoints of Spermatotoxicity in the Rat After Short Duration Exposures to Fourteen Reproductive Toxicants. *Reproductive Toxicology*, 6, p. 491-505.
- (13) Korenbrot, C.C. et al., (1977) Preputial Separation as an External Sign of Pubertal Development in the Male Rat. *Biological Reproduction*, 17, p. 298-303.
- (14) Russell, L.D. et al., (1990) Histological and Histopathological Evaluation of the Testis, Cache River Press, Clearwater, Florida.
- (15) Heindel, J.J. and R.E. Chapin, (eds.) (1993) Part B. Female Reproductive Systems, *Methods in Toxicology*, Academic, Orlando, Florida.
- (16) Heindel, J.J. et al., (1989) Histological Assessment of Ovarian Follicle Number in Mice As a Screen of Ovarian Toxicity. In: *Growth Factors and the Ovary*, A.N. Hirshfield (ed.), Plenum, New York, p. 421-426.
- (17) Manson, J.M. and Y.J. Kang, (1989) Test Methods for Assessing Female Reproductive and Developmental Toxicology. In: *Principles and Methods of Toxicology*, A.W. Hayes (ed.), Raven, New York.

▼B

- (18) Smith, B.J. et al., (1991) Comparison of Random and Serial Sections in Assessment of Ovarian Toxicity. *Reproductive Toxicology*, 5, p. 379-383.
- (19) Heindel, J.J., (1999) Oocyte Quantitation and Ovarian Histology. In: *An Evaluation and Interpretation of Reproductive Endpoints for Human Health Risk Assessment*, G. Daston, and C.A. Kimmel, (eds.), ILSI Press, Washington, DC.
- (20) Thomas, J. A., (1991) Toxic Responses of the Reproductive System. In: *Casarett and Doull's Toxicology*, M.O. Amdur, J. Doull, and C.D. Klaassen (eds.), Pergamon, New York.
- (21) Zenick, H. and E.D. Clegg, (1989) Assessment of Male Reproductive Toxicity: A Risk Assessment Approach. In: *Principles and Methods of Toxicology*, A.W. Hayes (ed.), Raven Press, New York.
- (22) Palmer, A.K., (1981) In: *Developmental Toxicology*, Kimmel, C.A. and J. Buelke-Sam (eds.), Raven Press, New York.
- (23) Palmer, A.K., (1978) In *Handbook of Teratology*, Vol. 4, J.G. Wilson and F.C. Fraser (eds.), Plenum Press, New York.

▼M4**B.36. TOXICOKINETICS**

INTRODUCTION

1. This Test Method is equivalent to OECD TG 417 (2010). Studies examining the toxicokinetics (TK) of a test chemical are conducted to obtain adequate information on its absorption, distribution, biotransformation (i.e. metabolism) and excretion, to aid in relating concentration or dose to the observed toxicity, and to aid in understanding its mechanism of toxicity. TK may help to understand the toxicology studies by demonstrating that the test animals are systemically exposed to the test chemical and by revealing which are the circulating moieties (parent chemical/metabolites). Basic TK parameters determined from these studies will also provide information on the potential for accumulation of the test chemical in tissues and/or organs and the potential for induction of biotransformation as a result of exposure to the test chemical.
2. TK data can contribute to the assessment of the adequacy and relevance of animal toxicity data for extrapolation to human hazard and/or risk assessment. Additionally, toxicokinetic studies may provide useful information for determining dose levels for toxicity studies (linear vs. non-linear kinetics), route of administration effects, bioavailability, and issues related to study design. Certain types of TK data can be used in physiologically based toxicokinetic (PBTK) model development.
3. There are important uses for metabolite/TK data such as suggesting possible toxicities and modes of action and their relation to dose level and route of exposure. In addition, metabolism data can provide information useful for assessing the toxicological significance of exposures to exogenously produced metabolites of the test chemical.
4. Adequate toxicokinetic data will be helpful to support the further acceptability and applicability of quantitative structure-activity relationships, read-across or grouping approaches in the safety evaluation of chemicals. Kinetics data may also be used to evaluate the toxicological relevance of other studies (e.g. *in vivo/in vitro*).
5. Unless another route of administration is mentioned (see in particular paragraphs 74-78), this Test Method is applicable to oral administration of the test chemical.

INITIAL CONSIDERATIONS

6. Regulatory systems have different requirements and needs regarding the measurement of endpoints and parameters related to toxicokinetics for different classes of chemicals (e.g. pesticides, biocides, industrial chemicals). Unlike most Test Methods this Test Method describes toxicokinetics testing, which involves multiple measurements and endpoints. In the future, several new Test Methods, and/or guidance document(s), may be developed to describe each endpoint separately and in more detail. In the case of this Test Method, which tests or assessments are conducted is specified by the requirements and/or needs of each regulatory system.

▼ M4

7. There are numerous studies that might be performed to evaluate the TK behaviour of a test chemical for regulatory purposes. However, depending on particular regulatory needs or situations, not all of these possible studies may be necessary for the evaluation of a test chemical. Flexibility, taking into consideration the characteristics of the test chemical being investigated, is needed in the design of toxicokinetic studies. In some cases, only a certain set of questions may need to be explored in order to address test chemical-associated hazard and risk concerns. In some situations, TK data can be collected as part of the evaluation in other toxicology studies. For other situations, additional and/or more extensive TK studies may be necessary, depending on regulatory needs and/or if new questions arise as part of test chemical evaluation.

8. All available information on the test chemical and relevant metabolites and analogues should be considered by the testing laboratory prior to conducting the study in order to enhance study quality and avoid unnecessary animal use. This could include data from other relevant Test Methods (*in vivo* studies, *in vitro* studies, and/or *in silico* evaluations). Physicochemical properties, such as octanol-water partition coefficient (expressed as log P_{OW}), pKa, water solubility, vapour pressure, and molecular weight of a chemical may be useful for study planning and interpretation of results. They can be determined using appropriate methods as described in the relevant Test Methods.

LIMITATIONS

9. This Test Method is not designed to address special circumstances, such as the pregnant or lactating animal and offspring, or to evaluate potential residues in exposed food-producing animals. However, the data obtained from a B.36 study can provide background information to guide the design of specific studies for these investigations. This Test Method is not intended for the testing of nanomaterials. A report on preliminary review of OECD Test Guidelines for their applicability to nanomaterials indicates that TG 417 (equivalent to this Test Method B.36) may not apply to nanomaterials (1).

DEFINITIONS

10. Definitions used for the purpose of this Test Method are provided in Appendix.

ANIMAL WELFARE CONSIDERATIONS

11. Guidance on humane treatment of animals is available in OECD Guidance Document (GD) 19 (2). It is recommended that OECD GD 19 be consulted for all *in vivo* and *in vitro* studies described in this Test Method.

DESCRIPTION OF THE METHODS**Pilot Studies**

12. The use of pilot studies is recommended and encouraged for the selection of experimental parameters for the toxicokinetics studies (e.g. metabolism, mass balance, analytical procedures, dose-finding, exhalation of CO₂, etc.). Characterisation of some of these parameters may not necessitate the use of radiolabelled chemicals.

▼ M4**Animal Selection***Species*

13. The animal species (and strain) used for TK testing should preferably be the same as that used in other toxicological studies performed with the test chemical of interest. Normally, the rat should be used as it has been used extensively for toxicological studies. The use of other or additional species may be warranted if critical toxicology studies demonstrate evidence of significant toxicity in these species or if their toxicity/toxicokinetics is shown to be more relevant to humans. Justification should be provided for the selection of the animal species and its strain.

14. Unless mentioned otherwise, this Test Method refers to the rat as the test species. Certain aspects of the method might have to be modified for the use of other test species.

Age and Strain

15. Young healthy adult animals (normally 6-12 weeks at the time of dosing) should be used (see also paragraphs 13 and 14). Justification should be provided for the use of animals that are not young adults. All animals should be of similar age at the outset of the study. The weight variation of individual animals should not exceed $\pm 20\%$ of the mean weight of the test group. Ideally, the strain used should be the same as that used in deriving the toxicological database for the test chemical.

Number and Sex of Animals

16. A minimum of four animals of one sex should be used for each dose tested. Justification should be provided for the sex of the animals used. The use of both sexes (four males and four females) should be considered if there is evidence to support significant sex-related differences in toxicity.

Housing and feeding conditions

17. Animals should generally be housed individually during the testing period. Group housing might be justified in special circumstances. Lighting should be artificial, the sequence being 12 h light/12 h dark. The temperature of the experimental animal room should be 22 °C (± 3 °C) and the relative humidity 30-70 %. For feeding, conventional laboratory diets may be used with an unlimited supply of drinking water.

Test Chemical

18. A radiolabelled test chemical using ^{14}C should be used for all mass balance and metabolite identification aspects of the study; however, if it can be demonstrated that:

— mass balance and metabolite identification can be adequately evaluated using the unlabelled test chemical,

— the analytical specificity and sensitivity of the method used with non-radioactive test chemical is equal to or greater than that which could be obtained with the radiolabelled test chemical,

▼ M4

then a radiolabelled test chemical does not need to be used. Furthermore, other radioactive and stable isotopes may be used, particularly if the element is responsible for or is a part of the toxic portion of the test chemical. If possible, the radiolabel should be located in a core portion of the molecule which is metabolically stable (it is not exchangeable, is not removed metabolically as CO₂, and does not become part of the one-carbon pool of the organism). Labelling of multiple sites or specific regions of the molecule may be necessary to follow the metabolic fate of the test chemical.

19. The radiolabelled and non-radiolabelled test chemicals should be analysed using appropriate methods to establish purity and identity. The radio-purity of the radioactive test chemical should be the highest attainable for a particular test chemical (ideally it should be greater than 95 %) and reasonable effort should be made to identify impurities present at or above 2 %. The purity, along with the identity and proportion of any impurities which have been identified, should be reported. Individual regulatory programmes may choose to provide additional guidance to assist in the definition and specifications of test chemicals composed of mixtures and methods for determination of purity.

Dose Selection*Pilot Study*

20. Usually a single oral dose is sufficient for the pilot study. The dose should be non-toxic, but high enough to allow for metabolite identification in excreta (and plasma, if appropriate) as well as to meet the stated purpose of the pilot study as noted in paragraph 12 of this Test Method.

Main Studies

21. For the main studies, a minimum of two doses is preferred since information gathered from at least two dose groups may aid in dose setting in other toxicity studies, and help in the dose-response assessment of already available toxicity tests.
22. Where two doses are administered, both doses should be high enough to allow for metabolite identification in excreta (and plasma, if appropriate). Information from available toxicity data should be considered for dose selection. If information is not available (e.g. from acute oral toxicity studies recording clinical signs of toxicity, or from repeated dose toxicity studies) a value for the higher dose that is below the LD₅₀ (oral and dermal routes) or LC₅₀ (inhalation route) estimate or below the lower value of the acute toxicity range estimate may be considered. The lower dose should be some fraction of the higher dose.
23. If only one dose level is investigated, ideally the dose should be high enough to allow for metabolite identification in excreta (and plasma, if appropriate), while not producing apparent toxicity. A rationale should be provided as to why no second dose level has been included.
24. If the effect of dose on kinetic processes needs to be established, two doses may not be sufficient and at least one dose should be high enough so as to saturate these processes. If the area under the plasma concentration-time curve (AUC) is not linear between two dose levels used in the main study, this is a strong indication that saturation of one or more of the kinetic processes is occurring somewhere between the two dose levels.

▼M4

25. For test chemicals of low toxicity, a maximum dose of 1 000 mg/kg body weight (oral and dermal routes) should be used (if administration is by the inhalation route, refer to Chapter B.2 of this Annex for guidance; typically this dose would not exceed 2 mg/l). Chemical-specific considerations may necessitate a higher dose depending on regulatory needs. Dose selection should always be justified.
26. Single dose toxicokinetic and tissue distribution data may be adequate to determine the potential for accumulation and/or persistence. However in some circumstances repeated dose administration may be needed (i) to address more fully the potential for accumulation and/or persistence or changes in TK (i.e. for instance, enzyme induction and inhibition), or (ii) as required by the applicable regulatory system. In studies involving repeated dosing, while repeated low dose administration is usually sufficient, under certain circumstances repeated high dose administration may also be necessary (see also paragraph 57).

Administration of Test Chemical

27. The test chemical should be dissolved or suspended homogeneously in the same vehicle employed for the other oral gavage toxicity studies performed with the test chemical, if such vehicle information is available. Rationale for the choice of vehicle should be provided. The choice of the vehicle and the volume of dosing should be considered in the design of the study. The customary method of administration is by gavage; however, administration by gelatine capsule or as a dietary mixture may be advantageous in specific situations (in both cases, justification should be given). Verification of the actual dose administered to each animal should be provided.
28. The maximum volume of liquid to be administered by oral gavage at one time depends on the size of the test animals, the type of dose vehicle, and whether or not feed is withheld prior to administration of the test chemical. The rationale for administering or restricting food prior to dosing should be provided. Normally the volume should be kept as low as practical for either aqueous or non-aqueous vehicles. Dose volumes should not normally exceed 10 ml/kg body weight for rodents. Volumes of vehicles used for more lipophilic test chemicals might start at 4 ml/kg body weight. For repeated dosing, when daily fasting would be contraindicated, lower dose volumes (e.g. 2-4 ml/kg body weight) should be considered. Where possible, consideration may be given to the use of a dose volume consistent with that administered in other oral gavage studies for a test chemical.
29. Intravenous (IV) administration of the test chemical and measurement of the test chemical in blood and/or excreta may be used to establish bioavailability or relative oral absorption. For the IV study, a single dose (usually equivalent to but not to exceed the lower oral dose – see dose selection) of test chemical is administered using an appropriate vehicle. This material should be administered in a suitable volume (e.g. 1 ml/kg bw) at the chosen site of administration to at least four animals of the appropriate sex (both sexes might be used, if warranted, see paragraph 16). A fully dissolved or suspended dose preparation is necessary for IV administration of the test chemical. The vehicle for IV administration should not interfere

▼ **M4**

with blood integrity or blood flow. If the test chemical is infused, the infusion rate should be reported and standardised between animals, provided an infusion pump is used. Anaesthesia should be used if one cannulates the jugular vein (for administration of test chemical and/or collection of blood) or if one uses the femoral artery for administration. Due consideration should be given to the type of anaesthesia as it may have effects on toxicokinetics. Animals should be allowed to recover adequately before administration of the test chemical plus the vehicle.

30. Other routes of administration, such as dermal and inhalation, (see paragraphs 74-78) may be applicable for certain test chemicals, considering their physico-chemical properties and the expected human use or exposure.

Measurements*Mass Balance*

31. Mass balance is determined by summation of the percent of the administered (radioactive) dose excreted in urine, faeces, and expired air, and the percent present in tissues, residual carcass, and cage wash (see paragraph 46). Generally, total recoveries of administered test chemical (radioactivity) in the order of > 90 % are considered to be adequate.

Absorption

32. An initial estimation of absorption can be achieved by excluding the percentage of dose in the gastro-intestinal (GI) tract and/or faeces from the mass balance determination. For the calculation of percent absorption, see paragraph 33. For investigation of excreta, see paragraphs 44-49. If the exact extent of absorption following oral dosing cannot be established from mass balance studies (e.g. where greater than 20 % of the administered dose is present in faeces), further investigations might be necessary. These studies could comprise either 1) oral administration of test chemical and measurement of test chemical in bile or 2) oral and IV administration of test chemical and measurement of net test chemical present in urine plus expired air plus carcass by each of the two routes. In either study design, measurement of radioactivity is conducted as a surrogate method for chemical-specific analysis of test chemical plus metabolites.
33. If a biliary excretion study is undertaken, the oral route of administration is typically used. In this study, the bile ducts of at least four animals of the appropriate sex (or of both sexes, if warranted) should be cannulated and a single dose of the test chemical should be administered. Following administration of the test chemical, excretion of radioactivity/test chemical in bile should be monitored as long as necessary to estimate the percentage of the administered dose that is excreted via this route, which can be used to directly calculate the extent of oral absorption, as follows:

$$\text{Percent absorption} = \frac{(\text{amount in bile} + \text{urine} + \text{expired air} + \text{carcass without GI tract contents})}{\text{amount administered}} \times 100$$

34. With some classes of test chemical, direct secretion of the absorbed dose can occur across intestinal membranes. In such cases the measurement of % dose in faeces following an oral dose in the bile duct cannulated rat is not considered to be representative of the unabsorbed dose. It is recommended that where intestinal secretion is thought to occur then the % dose absorbed be based on the absorption calculated from a comparison of the excretion following the oral versus IV route (intact or bile duct cannulated rat) (see paragraph 35). It is also recommended that where quantification of the intestinal secretion is considered necessary, excretion in the bile duct cannulated rat following IV dose administration be measured.

▼ **M4***Bioavailability*

35. Bioavailability can be determined from plasma/blood kinetics of the oral and IV groups, as described in paragraphs 50-52, by specific chemical analysis of the test chemical and/or relevant metabolite(s), therefore not requiring radiolabelled test chemical. The calculation of bioavailability (F) of the test chemical or relevant metabolite(s) can then be made as follows:

$$F = (AUC_{\text{exp}}/AUC_{\text{IV}}) \times (\text{Dose}_{\text{IV}}/\text{Dose}_{\text{exp}})$$

where AUC is the area under the plasma concentration-time curve, and exp is the experimental route (oral, dermal or via inhalation).

36. For use in risk assessment of systemic effects, bioavailability of the toxic component is in general preferred over the percent absorption when comparing systemic concentrations from animal studies with analogous biomonitoring data from worker exposure studies. The situation may become more complex if doses are in the non-linear range so it is important that toxicokinetic screening determines doses in the linear range.

Tissue Distribution

37. Knowledge of tissue distribution of a test chemical and/or its metabolites is important for the identification of target tissues, and understanding of the underlying mechanisms of toxicity, and in order to get information on the potential for test chemical and metabolite accumulation and persistence. The percent of the total (radioactive) dose in tissues as well as residual carcass should at a minimum be measured at the termination of the excretion experiment (e.g. typically up to 7 days post dose or less depending on test chemical specific behaviour). When no test chemical is detected in tissues at study termination (e.g. because the test chemical might have been eliminated before study termination due to a short half-life), care should be taken in order to prevent misinterpretation of the data. In this type of situation, tissue distribution should be investigated at the time of test chemical (and/or metabolite) peak plasma/blood concentration (T_{max}) or peak rate of urinary excretion, as appropriate (see paragraph 38). Furthermore, tissue collection at additional time points may be needed to determine tissue distribution of the test chemical and/or its metabolites, to evaluate time dependency (if appropriate), to aid in establishing mass balance, and/or as required by a competent authority. Tissues that should be collected include liver, fat, GI tract, kidney, spleen, whole blood, residual carcass, target organ tissues and any other tissues (e.g. thyroid, erythrocytes, reproductive organs, skin, eye (particularly in pigmented animals) of potential significance in the toxicological evaluation of the test chemical. Analysis of additional tissues at the same time points should be considered to maximise utilisation of animals and in the event that target organ toxicity is observed in sub-chronic or chronic toxicity studies. The (radioactive) residue concentration and tissue-to-plasma (blood) ratios should also be reported.
38. The evaluation of tissue distribution at additional time points such as the time of peak plasma/blood concentration (e.g. T_{max}) or the peak rate of urinary excretion, obtained from the respective plasma/blood kinetic or excretion experiments, may also be needed or required by a competent authority. This information can be useful for understanding toxicity and the potential for test chemical and metabolite accumulation and persistence. Justification for sample selection should be provided; samples for analysis generally should be the same as those above (see paragraph 37).

▼ M4

39. Quantification of radioactivity for tissue distribution studies can be performed using organ dissection, homogenisation, combustion and/or solubilisation, followed by liquid scintillation counting (LSC) of trapped residues. Certain techniques, currently at various stages of development, e.g. Quantitative whole-body autoradiography and receptor microscopic autoradiography, may prove useful in determining the distribution of a test chemical in organs and/or tissues (3) (4).
40. For routes of exposure other than oral, specific tissues should be collected and analysed, such as lungs in inhalation studies and skin in dermal studies. See paragraphs 74-78.

Metabolism

41. Excreta (and plasma, if appropriate) should be collected for identification and quantitation of unchanged test chemical and metabolites as described under paragraphs 44-49. Pooling of excreta to facilitate metabolite identification within a given dose group is acceptable. Profiling of metabolites from each time period is recommended. However, if lack of sample and/or radioactivity precludes this, pooling of urine and faeces across several time points is acceptable but pooling across sexes or doses is not acceptable. Appropriate qualitative and quantitative methods should be used to assay urine, faeces, expired radioactivity from treated animals, and bile if appropriate.
42. Reasonable efforts should be made to identify all metabolites present at 5 % or greater of the administered dose and to provide a metabolic scheme for the test chemical. Test chemicals which have been characterised in excreta as comprising 5 % or greater of the administered dose should be identified. Identification refers to the exact structural determination of components. Typically, identification is accomplished either by co-chromatography of the metabolite with known standards using two dissimilar systems or by techniques capable of positive structural identification such as mass spectrometry, nuclear magnetic resonance (NMR), etc. In the case of co-chromatography, chromatographic techniques utilising the same stationary phase with two different solvent systems are not considered to be an adequate two-method verification of metabolite identity, since the methods are not independent. Identification by co-chromatography should be obtained using two dissimilar, analytically independent systems such as reverse and normal phase thin layer chromatography (TLC) and high performance liquid chromatography (HPLC). Provided that the chromatographic separation is of suitable quality, then additional confirmation by spectroscopic means is not necessary. Alternatively, unambiguous identification can also be obtained using methods providing structural information such as: liquid chromatography/mass spectrometry (LC-MS), or liquid chromatography/tandem mass spectrometry (LC-MS/MS), gas chromatography/mass spectrometry (GC-MS), and NMR spectrometry.
43. If identification of metabolites at 5 % or greater of the administered dose is not possible, a justification/explanation should be provided in the final report. It might be appropriate to identify metabolites representing less than 5 % of the administered dose to gain a better understanding of the metabolic pathway for hazard and/or risk assessment of the test chemical. Structural confirmation should be provided whenever possible. This may include profiling in plasma or blood or other tissues.

▼ M4*Excretion*

44. The rate and extent of excretion of the administered dose should be determined by measuring the percent recovered (radioactive) dose from urine, faeces and expired air. These data will also assist in establishing mass balance. The quantities of test chemical (radioactivity) eliminated in the urine, faeces, and expired air should be determined at appropriate time intervals (see paragraphs 47-49). Repeated dose experiments should be properly designed to allow for collection of excretion data to meet the objectives described in the paragraph 26. This will allow for comparison to single dose experiments.
45. If a pilot study has shown that no significant amount of test chemical (radioactivity) (according to paragraph 49) is excreted in expired air, then expired air does not need to be collected in the definitive study.
46. Each animal is to be placed in a separate metabolic unit for collection of excreta (urine, faeces and expired air). At the end of each collection period (see paragraphs 47-49), the metabolic units should be rinsed with appropriate solvent (this is known as the 'cage wash') to ensure maximum recovery of the test chemical (radioactivity). Collection of excreta should be terminated at 7 days, or after at least 90 % of the administered dose has been recovered, whichever occurs first.
47. The total quantities of test chemical (radioactivity) in urine are to be determined for at least two time points on day 1 of collection, one of which should be at 24 h post dosing, and daily thereafter until study termination. The selection of more than two sampling points on day one (e.g. at 6, 12 and 24 h) is encouraged. The results of pilot studies should be analysed for information on alternate or additional time points for collection. A rationale should be provided for the collection schedules.
48. The total quantities of test chemical (radioactivity) in faeces should be determined on a daily basis beginning at 24 h post-dosing until study termination, unless pilot studies suggest alternate or additional time points for collection. A rationale should be provided for alternative collection schedules.
49. The collection of expired CO₂ and other volatile materials may be discontinued in a given study experiment when less than 1 % of the administered dose is found in the exhaled air during a 24-h collection period.

Time Course Studies*Plasma/Blood Kinetics*

50. The purpose of these studies is to obtain estimates of basic TK parameters [e.g. C_{max}, T_{max}, half-life (t_{1/2}), AUC] for the test chemical. These studies may be conducted at one dose or, more likely, at two or more doses. Dose setting should be determined by the nature of the experiment and/or the issue being addressed. Kinetic data may be needed to resolve issues such as test chemical bioavailability and/or to clarify the effect of dose on clearance (e.g. to clarify whether clearance is saturated in a dose-dependent fashion).
51. For these studies a minimum of four animals of one sex per dose group should be used. Justification should be provided for the sex of the animals used. The use of both sexes (four males and four females) should be considered if there is evidence to support significant sex-related differences in toxicity.

▼ M4

52. Following administration of the test chemical (radiolabelled), blood samples should be obtained from each animal at suitable time points using appropriate sampling methodology. The volume and number of blood samples which can be obtained per animal might be limited by potential effects of repeated sampling on animal health/physiology and/or the sensitivity of the analytical method. Samples should be analysed for each individual animal. In some circumstances (e.g. metabolite characterisation), it might be necessary to pool samples from more than one animal. Pooled samples should be clearly identified and an explanation for pooling provided. If a radiolabelled test chemical is used, analysis of total radioactivity present might be adequate. If so, total radioactivity should be analyzed in whole blood and plasma or plasma and red blood cells to allow calculation of the blood/plasma ratio. In other circumstances, more specific investigations requiring the identification of parent compound and/or metabolites, or to assess protein binding might be necessary.

Other Tissue Kinetics

53. The purpose of these studies is to obtain time course information to address questions related to issues such as toxic mode of action, bioaccumulation and bio-persistence via determination of levels of test chemical in various tissues. The selection of tissues and the number of time points evaluated will depend on the issue to be addressed and the toxicological database for the test chemical. The design of these additional tissue kinetics studies should take into account information gathered as described in paragraphs 37-40. These studies might involve single or repeated dosing. A detailed rationale for the approach used should be provided.

54. Reasons for performing other tissue kinetic studies might include:

— Evidence of extended blood half-life, suggesting possible accumulation of test chemical in various tissues, or

— interest in seeing if a steady state level has been achieved in specific tissues (e.g. in repeated dosing studies, even though an apparent blood steady state level of test chemical may have been achieved, there may be interest in ascertaining that a steady state level has also been attained in target tissues).

55. For these types of time-course studies, an appropriate oral dose of test chemical should be administered to a minimum of four animals per dose per time point and the time course of distribution monitored in selected tissues. Only one sex may be used, unless gender specific toxicity is observed. Whether total radioactivity or parent chemical and/or metabolites are analysed will also depend on the issue being addressed. Assessment of tissue distribution should be made using appropriate techniques.

Enzyme Induction/Inhibition

56. Studies addressing the possible effects of enzyme induction/inhibition or biotransformation of test chemical under study may be needed under one or more of the following cases:

(1) Available evidence indicates a relationship between biotransformation of test chemical and enhanced toxicity;

(2) The available toxicity data indicate a non-linear relationship between dose and metabolism;

▼ M4

- (3) The results of metabolite identification studies show identification of a potentially toxic metabolite that might have been produced by an enzyme pathway induced by the test chemical;
 - (4) In explaining effects which are postulated to be linked to enzyme induction phenomena;
 - (5) If toxicologically significant alterations in the metabolic profile of the test chemical are observed through either *in vitro* or *in vivo* experiments with different species or conditions, characterisation of the enzyme(s) involved may be needed (e.g. Phase I enzymes such as isoenzymes of the Cytochrome P450-dependent mono-oxygenase system, Phase II enzymes such as isoenzymes of sulfotransferase or uridine diphosphate glucuronosyl transferase, or any other relevant enzymes). This information might be used to evaluate the pertinence of species to species extrapolations.
57. Appropriate study protocols to evaluate test chemical related changes in TK, suitably validated and justified should be used. Example study designs consist of repeated dosing with unlabelled test chemical, followed by a single radiolabelled dose on day 14, or repeated dosing with radiolabelled test chemical and sampling at days 1, 7 and 14 for determination of metabolite profiles. Repeated dosing with radiolabelled test chemical may also provide information on bioaccumulation (see paragraph 26).

SUPPLEMENTAL APPROACHES

58. Supplemental approaches beyond the *in vivo* experiments described in this Test Method may provide useful information on the absorption, distribution, metabolism or elimination of a test chemical in certain species.

Use of *in vitro* information

59. Several questions concerning the metabolism of the test chemical may be addressed in *in vitro* studies using appropriate test systems. Freshly isolated or cultured hepatocytes and subcellular fractions (e.g. microsomes and cytosol or S9 fraction) from liver may be used to study possible metabolites. Local metabolism in the target organ, e.g. lung, may be of interest for risk assessment. For these purposes, microsomal fractions of target tissues may be useful. Studies with microsomes may be useful to address potential gender and life-stage differences and characterise enzyme parameters (K_m and V_{max}) which can aid in the assessment of dose dependency of metabolism in relation to exposure levels. In addition microsomes may be useful to identify the specific microsomal enzymes involved in the metabolism of the test chemical which can be relevant in species extrapolation (see also paragraph 56). The potential for induction of biotransformation can also be examined by using liver subcellular fractions (e.g. microsomes and cytosol) of animals pre-treated with the test chemical of interest, *in vitro* via hepatocyte induction studies or from specific cell lines expressing relevant enzymes. In certain circumstances and under appropriate conditions, subcellular fractions coming from human tissues might be considered for use in determining potential species differences in biotransformation. The results from *in vitro* investigations may also have utility in the development of PBTK models (5).

▼ M4

60. *In vitro* dermal absorption studies may provide supplemental information to characterise absorption (6).

61. Primary cell cultures from liver cells and fresh tissue slices may be used to address similar questions as with liver microsomes. In certain cases, it may be possible to answer specific questions using cell lines with defined expression of the relevant enzyme or engineered cell lines. In certain cases, it may be useful to study the inhibition and induction of specific cytochrome P450 isozymes (e.g. CYP1A1, 2E1, 1A2, and others) and/or phase II enzymes by the parent compound using *in vitro* studies. Information obtained may have utility for similarly structured compounds.

Use of Toxicokinetic Data from Toxicity Studies as Complementary Information

62. Analysis of blood, tissue and/or excreta samples obtained during the conduct of any other toxicity studies can provide data on bioavailability, changes in plasma concentration in time (AUC, C_{max}), bioaccumulation potential, clearance rates, and gender or life-stage changes in metabolism and kinetics.

63. Consideration of the study design can be used to answer questions relating to: saturation of absorption, biotransformation or excretion pathways at higher dose levels; the operation of new metabolic pathways at higher doses and the limitation of toxic metabolites to higher doses.

64. Other hazard assessment considerations could include issues such as:
 - Age-related sensitivity due to differences in the status of the blood-brain barrier, the kidney and/or detoxification capacities;

 - Sub-population sensitivity due to differences in biotransformation capacities or other TK differences;

 - Extent of exposure of the foetus by transplacental transfer of chemicals or of the newborn through lactation.

Use of Toxicokinetic Modelling

65. Toxicokinetic models may have utility for various aspects of hazard and risk assessment as for example in the prediction of systemic exposure and internal tissue dose. Furthermore specific questions on mode of action may be addressed, and these models can provide a basis for extrapolation across species, routes of exposure, dosing patterns, and for human risk assessment. Data useful for developing PBTK models for a test chemical in any given species include (1) partition coefficients, (2) biochemical constants and physiological parameters, (3) route-specific absorption parameters and 4) *in vivo* kinetic data for model evaluation [e.g. clearance parameters for relevant (> 10 %) excretion pathways, K_m and V_{max} for metabolism]. The experimental data used in model development should be generated with scientifically sound methods and the model results validated. Test chemical- and species-specific parameters such as absorption rates, blood-tissue partitioning and metabolic rate constants are often determined to facilitate development of non-compartmental or physiologically-based models (7).

▼M4

DATA AND REPORTING

66. It is recommended that the study report include a table of contents.

Body of the Report

67. The body of the report should include information covered by this Test Method organised into sections and paragraphs as follows:

Summary

68. This section of the study report should include a summary of the study design and a description of methods used. It should also highlight the key findings regarding mass balance, the nature and magnitude of metabolites, tissue residue, rate of clearance, bioaccumulation potential, sex differences, etc. The summary should be presented in sufficient detail to permit evaluation of the findings.

Introduction

69. This section of the report should include the study objectives, rationale and design, as well as, appropriate references and any background history.

Materials and Methods

70. This section of the report should include detailed descriptions of all pertinent information including:

(a) Test Chemical

This subsection should include identification of the test chemical: chemical name, molecular structure, qualitative and quantitative determination of its chemical composition, chemical purity and whenever possible, type and quantities of any impurities. It should also include information on physical/chemical properties including physical state, colour, gross solubility and/or partition coefficient, stability, and if appropriate, corrosivity. If applicable, information on isomers should be provided. If the test chemical is radiolabelled, information on the following should be included in this subsection: the type of radio-nuclide, position of label, specific activity, and radiochemical purity.

The type or description of any vehicle, diluents, suspending agents, and emulsifiers or other materials used in administering the test chemical should be stated.

(b) Test Animals

This subsection should include information on the test animals, including selection and justification for species, strain, and age at study initiation, sex as well as body weight, health status, and animal husbandry.

(c) Methods

This subsection should include details of the study design and methodology used. It should include a description of:

- (1) Justification for any modification of route of exposure and exposure conditions, if applicable;

▼ M4

- (2) Justification for selection of dose levels;
 - (3) Description of pilot studies used in the experimental design of the follow-up studies, if applicable. Pilot study supporting data should be submitted;
 - (4) How the dosing solution was prepared and the type of solvent or vehicle, if any, used;
 - (5) Number of treatment groups and number of animals per group;
 - (6) Dosage levels and volume (and specific activity of the dose when radioactivity is used);
 - (7) Route(s) and methods of administration;
 - (8) Frequency of dosing;
 - (9) Fasting period (if used);
 - (10) Total radioactivity per animal;
 - (11) Animal handling;
 - (12) Sample collection and handling;
 - (13) Analytical methods used for separation, quantitation and identification of metabolites;
 - (14) Limit of detection for the employed methods;
 - (15) Other experimental measurements and procedures employed (including validation of methods for metabolite analysis).
- (d) Statistical Analysis

If statistical analysis is used to analyse the study findings, then sufficient information on the method of analysis and the computer program employed should be included, so that an independent reviewer/statistician can re-evaluate and reconstruct the analysis.

In the case of systems modelling studies such as PBTK, presentation of models should include a full description of the model to allow independent reconstruction and validation of the model (see paragraph 65 and Appendix: Definitions).

Results

71. All data should be summarised and tabulated with appropriate statistical evaluation and described in the text of this section. Radioactivity counting data should be summarised and presented as appropriate for the study, typically as microgram or milligram equivalents per mass of sample, although other units may be used. This section should include graphic illustrations of the findings, reproduction of representative chromatographic and spectrometric data, metabolite identification/quantification and proposed metabolic pathways including molecular structure of metabolites. In addition the following information is to be included in this section, if applicable:

- (1) Quantity and percent recovery of radioactivity in urine, faeces, expired air, and urine and faeces cage wash.
 - For dermal studies, also include data on test chemical recovery from treated skin, skin washes, and residual radioactivity in the skin covering apparatus and metabolic unit as well as results of the dermal washing study. For further discussion, see paragraphs 74-77.

▼ M4

- For inhalation studies, also include data on recovery of test chemical from lungs and nasal tissues (8). For further discussion, see paragraph 78.
- (2) Tissue distribution reported as percent of administered dose and concentration (microgram equivalents per gram of tissue), and tissue-to-blood or tissue-to-plasma ratios;
- (3) Material balance developed from each study involving the assay of body tissues and excreta;
- (4) Plasma concentrations and toxicokinetic parameters (bioavailability, AUC, C_{max}, T_{max}, clearance, half-life) after administration by the relevant route(s) of exposure;
- (5) Rate and extent of absorption of the test chemical after administration by the relevant route(s) of exposure;
- (6) Quantities of the test chemical and metabolites (reported as percent of the administered dose) collected in excreta;
- (7) Reference to appendix data which contain individual animal data for all measurement endpoints (e.g. dose administration, percent recovery, concentrations, TK parameters, etc.);
- (8) A figure with the proposed metabolic pathways and the molecular structures of the metabolites.

Discussion and Conclusions

72. In this section the author(s) should:

- (1) Provide a proposed metabolic pathway based on the results of the metabolism and disposition of the test chemical;
- (2) Discuss any potential species and sex differences regarding the disposition and/or biotransformation of the test chemical;
- (3) Tabulate and discuss the identification and magnitude of metabolites, rates of clearance, bioaccumulation potential, and level of tissue residues of parent, and/or metabolite(s), as well as possible dose-dependent changes in TK parameters, as appropriate;
- (4) Integrate into this section any relevant TK data obtained in the course of conducting toxicity studies;
- (5) Provide a concise conclusion that can be supported by the findings of the study;
- (6) Add Sections (as needed or appropriate).

73. Additional sections should be used to include supporting bibliographic information, tables, figures, appendices, etc.

▼ M4

ALTERNATIVE ROUTES OF EXPOSURE

Dermal*Dermal Treatment*

74. This section provides specific information on the investigation of the toxicokinetics of the test chemical by the dermal route. For dermal absorption, chapter B.44 of this Annex [Skin absorption: *in vivo* method (9)] should be consulted. For other endpoints such as distribution and metabolism, this Test Method B.36 can be used. One or more dose levels for the test chemical should be used in the dermal treatment. The test chemical (e.g. neat, diluted or formulated material containing the test chemical which is applied to the skin) should be the same (or a realistic surrogate) as that to which humans or other potential target species might be exposed. The dose level(s) should be selected in accordance with paragraphs 20-26 of this Test Method. Factors that could be taken into consideration in dermal dose selection include expected human exposure and/or doses at which toxicity was observed in other dermal toxicity studies. The dermal dose(s) should be dissolved, if necessary, in a suitable vehicle and applied in a volume adequate to deliver the doses. Shortly before testing, fur should be clipped from the dorsal area of the trunk of the test animals. Shaving may be employed, but it should be carried out approximately 24 h before the test. When clipping or shaving the fur, care should be taken to avoid abrading the skin, which could alter its permeability. Approximately 10 % of the body surface should be cleared for application of the test chemical. With highly toxic chemicals, the surface area covered may be less than approximately 10 %, but as much of the area as possible is to be covered with a thin and uniform film. The same treatment surface area should be used for all dermal test groups. The dosed areas are to be protected with a suitable covering which is secured in place. The animals should be housed separately.
75. A dermal washing study should be conducted to assess the amount of the applied dose of the test chemical that may be removed from the skin by washing the treated skin area with a mild soap and water. This study can also aid in establishing mass balance when the test chemical is administered by the dermal route. For this dermal washing study, a single dose of the test chemical should be applied to two animals. Dose level selection is in accordance with paragraph 23 of this Test Method (also see paragraph 76 for discussion of skin contact time). The amounts of test chemical recovered in the washes should be determined to assess the effectiveness of removal of the test chemical by the washing procedure.
76. Unless precluded by corrosiveness, the test chemical should be applied and kept on the skin for a minimum of 6 h. At the time of removal of the covering, the treated area should be washed following the procedure as outlined in the dermal washing study (see paragraph 75). Both covering and the washes should be analysed for residual test chemical. At the termination of the studies, each animal should be humanely killed in accordance with (2), and the treated skin removed. An appropriate section of treated skin should be analysed to determine residual test chemical (radioactivity).
77. For the toxicokinetic assessment of pharmaceuticals, different procedures, in accordance with the appropriate regulatory system, may be needed.

▼ M4**Inhalation**

78. A single concentration (or more if needed) of test chemical should be used. The concentration(s) should be selected in accordance with paragraphs 20-26 of this Test Method. Inhalation treatments are to be conducted using a 'nose-cone' or 'head-only' apparatus to prevent absorption by alternate routes of exposure (8). If other inhalation exposure conditions are used, justification for the modification should be documented. The duration of exposure by inhalation should be defined; a typical exposure is 4-6 h.

LITERATURE:

- (1) OECD (2009). Preliminary Review of OECD Test Guidelines for their Applicability to Manufactured Nanomaterials, Series on the Safety of Manufactured Nanomaterials No 15, ENV/JM/MONO(2009)21, OECD, Paris.
- (2) OECD (2000). Guidance Document on Recognition, Assessment and Use of Clinical Signs as Humane Endpoints for Experimental Animals Used in Safety Evaluation; Environmental Health and Safety Publications, Series on Testing and Assessment No 19, ENV/JM/MONO(2000), OECD, Paris.
- (3) Solon E G, Kraus L (2002). Quantitative whole-body autoradiography in the pharmaceutical industry; Survey results on study design, methods, and regulatory compliance, *J Pharm and Tox Methods* 46: 73-81.
- (4) Stumpf WE (2005). Drug localization and targeting with receptor microscopic autoradiography. *J. Pharmacological and Toxicological Methods* 51: 25-40.
- (5) Loizou G, Spendiff M, Barton HA, Bessems J, Bois FY, d'Yvoire MB, Buist H, Clewell HJ 3rd, Meek B, Gundert-Remy U, Goerlitz G, Schmitt W. (2008). Development of good modelling practice for physiologically based pharmacokinetic models for use in risk assessment: The first steps. *Regulatory Toxicology and Pharmacology* 50: 400 – 411.
- (6) Chapter B.45 of this Annex, Skin Absorption: In Vitro Method.
- (7) IPCS (2010). Characterization and application of Physiologically-Based Pharmacokinetic Models in Risk Assessment. IPCS Harmonization Project Document No 9. Geneva, World Health Organization, International Programme on Chemical Safety.
- (8) OECD (2009). Guidance Document on Acute Inhalation Toxicity Testing, Series on Testing and Assessment No 39, ENV/JM/MONO(2009)28, OECD, Paris.
- (9) Chapter B.44 of this Annex, Skin Absorption: In Vivo Method.
- (10) Barton HA, *et al.* (2006). The Acquisition and Application of Absorption, Distribution, Metabolism, and Excretion (ADME) Data in Agricultural Chemical Safety Assessments, *Critical Reviews in Toxicology* 36: 9-35.
- (11) Gibaldi M and Perrier D, (1982), *Pharmacokinetics*, 2nd edition, Marcel Dekker, Inc., New York.

▼ **M4***Appendix*

DEFINITIONS

Absorption: Process(es) of uptake of chemicals into or across tissues. Absorption refers to parent compound and all its metabolites. Not to be confused with 'bioavailability'.

Accumulation (Bioaccumulation): Increase of the amount of a test chemical over time within tissues (usually fatty tissues, following repeated exposure); if the input of a test chemical into the body is greater than the rate at which it is eliminated, the organism accumulates the test chemical and toxic concentrations of a test chemical might be achieved.

ADME: Acronym for 'Absorption, Distribution, Metabolism, and Excretion'.

AUC: (Area under the plasma concentration-time curve): Area under the curve in a plot of concentration of test chemical in plasma over time. It represents the total amount of test chemical absorbed by the body within a predetermined period of time. Under linear conditions, the AUC (from time zero to infinity) is proportional to the total amount of a test chemical absorbed by the body, irrespective of the rate of absorption.

Autoradiography: (Whole-body autoradiography): Used to determine qualitatively and/or quantitatively the tissue localisation of a radioactive test chemical, this technique uses X-ray film or more recently digital phosphor-imaging to visualize radioactively labelled molecules or fragments of molecules by recording the radiation emitted within the object under study. Quantitative whole-body autoradiography, compared to organ dissection, may have some advantages for the evaluation of test chemical distribution and the assessment of overall recovery and resolution of radioactive material in tissues. One significant advantage, for example, is it can be used in a pigmented animal model to assess possible association of the test chemical with melanin, which can bind certain molecules. However, while it may provide convenient whole body overviews of the high-capacity-low-affinity binding sites, this technique might be limited in recognising specific target sites such as receptor-binding sites where relatively high-resolution and high-sensitivity are needed for detection. When autoradiography is used, experiments intended to determine mass balance of administered compound should be conducted as a separate group or in a separate study from the tissue distribution experiment, where all excreta (which may also include expired air) and whole carcasses are homogenised and assayed by liquid scintillation counting.

Biliary excretion: Excretion via the bile ducts.

Bioaccumulation: See 'Accumulation'.

Bioavailability: Fraction of an administered dose that reaches the systemic circulation or is made available at the site of physiological activity. Usually, bioavailability of a test chemical refers to the parent compound, but it could refer to its metabolite. It considers only one chemical form. *Nota Bene:* bioavailability and absorption are not the same. The difference between e.g. oral absorption (i.e. presence in gut wall and portal circulation) and bioavailability (i.e. presence in systemic blood and in tissues) can arise from chemical degradation due to gut wall metabolism or efflux transport back to the intestinal lumen or presystemic metabolism in the liver, among other factors (10). Bioavailability of the toxic component (parent compound or a metabolite) is a critical parameter in human risk assessment (high-to-low dose extrapolation, route-to-route extrapolation) for derivation of an internal value from the external NOAEL or BMD (applied dose). For liver effects upon oral administration, it is the oral absorption that suffices. However, for every effect other than at the portal of entry, it is the bioavailability that is in general a more reliable parameter for further use in risk assessment, not the absorption.

▼ M4

Biopersistence: See 'Persistence'.

Biotransformation: (Usually enzymatic) chemical conversion of a test chemical of interest into a different chemical within the body. Synonymous with 'metabolism'.

C_{max}: Either maximal (peak) concentration in blood (plasma/serum) after administration or maximal (peak) excretion (in urine or faeces) after administration.

Clearance rate: Quantitative measure of the rate at which a test chemical is removed from the blood, plasma or a certain tissue per unit time.

Compartment: Structural or biochemical portion (or unit) of a body, tissue or cell, that is separate from the rest.

Detoxification pathways: Series of steps leading to the elimination of toxic chemicals from the body, either by metabolic change or excretion.

Distribution: Dispersal of a test chemical and its derivatives throughout an organism.

Enzymes/Isozymes: Proteins that catalyse chemical reactions. Isozymes are enzymes that catalyse similar chemical reactions but differ in their amino acid sequence.

Enzymatic Parameters: K_m: Michaelis constant and V_{max}: maximum velocity.

Excretion: Process(es) by which an administered test chemical and/or its metabolites are removed from the body.

Exogenously: Introduced from or produced outside the organism or system.

Extrapolation: Inference of one or more unknown values on the basis of that which is known or has been observed.

Half-life (t_{1/2}): The time taken for the concentration of the test chemical to decrease by one-half in a compartment. It typically refers to plasma concentration or the amount of the test chemical in the whole body.

Induction/Enzyme induction: Enzyme synthesis in response to an environmental stimulus or inducer molecule.

Linearity/linear kinetics: A process is linear in terms of kinetics when all transfer rates between compartments are proportional to the amounts or concentrations present, i.e. first order. Consequently, clearance and distribution volumes are constant, as well as half-lives. The concentrations achieved are proportional to the dosing rate (exposure), and accumulation is more easily predictable. Linearity/Non-linearity can be assessed by comparing the relevant parameters, e.g. AUC, after different doses or after single and repeated exposure. Lack of dose dependency may be indicative of saturation of enzymes involved in the metabolism of the compound, an increase of AUC after repeated exposure as compared to single exposure may be an indication for inhibition of metabolism and a decrease in AUC may be an indication for induction of metabolism [see also (11)].

Mass balance: Accounting of test chemical entering and leaving the system.

▼ M4

Material balance: See ‘mass balance’.

Mechanism (Mode) of toxicity/Mechanism (Mode) of action: Mechanism of action refers to specific biochemical interactions through which a test chemical produces its effect. Mode of action refers to more general pathways leading to the toxicity of a test chemical.

Metabolism: Synonymous with ‘biotransformation’.

Metabolites: Products of metabolism or metabolic processes.

Oral Absorption: The percentage of the dose of test chemical absorbed from the site of administration (i.e. GI tract). This critical parameter can be used to understand the fraction of the administered test chemical that reaches the portal vein, and subsequently the liver.

Partition coefficient: Also known as the distribution coefficient, it is a measure of the differential solubility of a chemical in two solvents.

Peak blood (plasma/serum) levels: Maximal (peak) blood (plasma/serum) concentration after administration (see also ‘C_{max}’).

Persistence (biopersistence): Long-term presence of a chemical (in a biological system) due to resistance to degradation/elimination.

Read-across: The endpoint information for one or more chemicals is used to make a prediction of the endpoint for the target chemical.

Receptor Microscopic Autoradiography (or Receptor Microautoradiography): This technique may be used to probe xenobiotic interaction with specific tissue sites or cell populations as for instance in receptor binding or specific mode of action studies that may require high-resolution and high sensitivity which may not be feasible with other techniques such as whole-body autoradiography.

Route of administration (oral, IV, dermal, inhalation, etc.): Refers to the means by which chemicals are administered to the body (e.g. orally by gavage, orally by diet, dermal, by inhalation, intravenously, etc.).

Saturation: State whereby one or more of the kinetic (e.g. absorption, metabolism or clearance) process(es) are at a maximum (read ‘saturated’).

Sensitivity: Capability of a method or instrument to discriminate between measurement responses representing different levels of a variable of interest.

Steady-state blood (plasma) levels: Non-equilibrium state of an open system in which all forces acting on the system are exactly counter-balanced by opposing forces, in such a manner that all its components are stationary in concentration although matter is flowing through the system.

Systems Modelling (Physiologically-based Toxicokinetic, Pharmacokinetic-based, Physiologically-based Pharmacokinetic, Biologically-based, etc.): Abstract model that uses mathematical language to describe the behaviour of a system.

Target tissue: Tissue in which a principal adverse effect of a toxicant is manifested.

▼ M4

Test chemical: Any chemical or mixture tested using this Test Method.

Tissue distribution: Reversible movement of a test chemical from one location in the body to another. Tissue distribution can be studied by organ dissection, homogenisation, combustion and liquid scintillation counting or by qualitative and/or quantitative whole body autoradiography. The former is useful to obtain concentration and percent of recovery from tissues and remaining carcass of the same animals, but may lack resolution for all tissues and may have less than ideal overall recovery (< 90 %). See definition for the latter above.

T_{max}: Time to reach C_{max}.

Toxicokinetics (Pharmacokinetics): Study of the absorption, distribution, metabolism, and excretion of chemicals over time.

Validation of models: Process of assessing the adequacy of a model to consistently describe the available toxicokinetic data. Models may be evaluated via statistical and visual comparison of model predictions with experimental values against a common independent variable (e.g. time). The extent of evaluation should be justified in relation to the intended use of the model.

▼B**B.37. DELAYED NEUROTOXICITY OF ORGANOPHOSPHORUS SUBSTANCES FOLLOWING ACUTE EXPOSURE****1. METHOD****1.1. INTRODUCTION**

In the assessment and evaluation of the toxic effects of substances, it is important to consider the potential of certain classes of substances to cause specific types of neurotoxicity that might not be detected in other toxicity studies. Certain organophosphorus substances have been observed to cause delayed neurotoxicity and should be considered as candidates for evaluation.

In vitro screening tests could be employed to identify those substances which may cause delayed polyneuropathy; however, negative findings from *in vitro* studies do not provide evidence that the test substance is not a neurotoxicant.

See General introduction Part B.

1.2. DEFINITIONS

Organophosphorus substances include uncharged organophosphorus esters, thioesters or anhydrides of organophosphoric, organophosphonic or organophosphoramidic acids or of related phosphorothioic, phosphonothioic or phosphorothioamidic acids, or other substances that may cause the delayed neurotoxicity sometimes seen in this class of substances.

Delayed neurotoxicity is a syndrome associated with prolonged delayed onset of ataxia, distal axonopathies in spinal cord and peripheral nerve, and inhibition and aging of neuropathy target esterase (NTE) in neural tissue.

1.3. REFERENCE SUBSTANCES

A reference substance may be tested with a positive control group as a means of demonstrating that under the laboratory test conditions, the response of the tested species has not changed significantly.

An example of a widely used neurotoxicant is tri-*o*-tolyl phosphate (CAS 78-30-8, EINECS 201-103-5, CAS nomenclature: phosphoric acid, tris(2-methylphenyl)ester), also known as tris-*o*-cresyl-phosphate.

1.4. PRINCIPLE OF THE TEST METHOD

The test substance is administered orally in a single dose to domestic hens which have been protected from acute cholinergic effects, when appropriate. The animals are observed for 21 days for behavioural abnormalities, ataxia, and paralysis. Biochemical measurements, in particular neuropathy target esterase inhibition (NTE), are undertaken on hens randomly selected from each group, normally 24 and 48 hours after dosing. Twenty-one days after exposure, the remainder of the hens are killed and histopathological examination of selected neural tissues is undertaken.

▼ B

1.5. DESCRIPTION OF THE TEST METHOD

1.5.1. **Preparations**

Healthy young adult hens free from interfering viral diseases and medication and without abnormalities of gait should be randomised and assigned to treatment and control groups and acclimatised to the laboratory conditions for at least five days prior to the start of the study.

Cages or enclosures which are large enough to permit free mobility of the hens, and easy observation of gait should be used.

Dosing with the test substance should normally be by the oral route using gavage, gelatine capsules, or a comparable method. Liquids may be given undiluted or dissolved in an appropriate vehicle such as corn oil; solids should be dissolved if possible since large doses of solids in gelatine capsules may not be absorbed efficiently. For non-aqueous vehicles the toxic characteristics of the vehicle should be known, and if not known should be determined before the test.

1.5.2. **Test conditions**1.5.2.1. *Test animals*

The young adult domestic laying hen (*Gallus gallus domesticus*), aged eight to 12 months, is recommended. Standard size breeds and strains should be employed and the hens normally should have been reared under conditions which permitted free mobility.

1.5.2.2. *Number and sex*

In addition to the treatment group, both a vehicle control group and a positive control group should be used. The vehicle control group should be treated in a manner identical to the treatment group, except that administration of the test substance is omitted.

Sufficient number of hens should be utilised in each group of birds so that at least six birds can be killed for biochemical determination (three at each of two time points) and six can survive the 21-day observation period for pathology.

The positive control group may be run concurrently or be a recent historical control group. It should contain at least six hens, treated with a known delayed neurotoxicant, three hens for biochemistry and three hens for pathology. Periodic updating of historical data is recommended. New positive control data should be developed when some essential element (e.g. strain, feed, housing conditions) of the conduct of the test has been changed by the performing laboratory.

▼B1.5.2.3. *Dose levels*

A preliminary study using an appropriate number of hens and dose levels groups should be performed to establish the level to be used in the main study. Some lethality is typically necessary in this preliminary study to define an adequate main study dose. However, to prevent death due to acute cholinergic effects, atropine or another protective agent, known to not interfere with delayed neurotoxic responses, may be used. A variety of test methods may be used to estimate the maximum non-lethal dose of test substances (See method B.1*bis*). Historical data in the hen or other toxicological information may also be helpful in dose selection.

The dose level of the test substance in the main study should be as high as possible taking into account the results of the preliminary dose selection study and the upper limit dose of 2 000 mg/kg body weight. Any mortality which might occur should not interfere with the survival of sufficient animals for biochemistry (six) and histology (six) at 21 days. Atropine or another protective agent, known to not interfere with delayed neurotoxic responses, should be used to prevent death due to acute cholinergic effects.

1.5.2.4. *Limit test*

If a test at a dose level of at least 2 000 mg/kg body weight/day, using the procedures described for this study, produces no observable toxic effects and if toxicity would not be expected based upon data from structurally related substances, then a study using a higher dose may not be considered necessary. The limit test applies except when human exposure indicates the need for a higher dose level to be used.

1.5.3. **Observation period**

Observation period should be 21 days.

1.5.4. **Procedure**

After administration of a protective agent to prevent death due to acute cholinergic effect, the test substance is administered in a single dose.

General observation

Observations should start immediately after exposure. All hens should be carefully observed several times during the first two days and thereafter at least once daily for a period of 21 days or until scheduled kill. All signs of toxicity should be recorded, including the time of onset, type, severity and duration of behavioural abnormalities. Ataxia should be measured on an ordinal grading scale consisting of at least four levels, and paralysis should be noted. At least twice a week the hens selected for pathology should be taken outside the cages and subjected to a period of forced motor activity, such as ladder climbing, in order to facilitate the observation of minimal toxic effects. Moribund animals and animals in severe distress or pain should be removed when noticed, humanely killed and necropsied.

▼ B**Body weight**

All hens should be weighed just prior to administration of the test substance and at least once a week thereafter.

Biochemistry

Six hens randomly selected from each of the treatment and vehicle control groups, and three hens from the positive control group (when this group is run concurrently), should be killed within a few days after dosing, and the brain and lumbar spinal cord prepared and assayed for neuropathy target esterase inhibition activity. In addition, it may also be useful to prepare and assay sciatic nerve tissue for neuropathy target esterase inhibition activity. Normally, three birds of the control and each treatment group are killed after 24 hours and three at 48 hours, whereas the three hens of the positive controls should be killed at 24 hours. If observation of clinical signs of intoxication (this can often be assessed by observation of the time of onset of cholinergic signs) indicates that the toxic agent may be disposed of very slowly then it may be preferable to sample tissue from three birds at each of two times between 24 and as late as 72 hours after dosing.

Analyses of acetylcholinesterase (AChE) may also be performed on these samples, if deemed appropriate. However, spontaneous reactivation of AChE may occur *in vivo*, and so lead to underestimation of the potency of the substance as an AChE inhibitor.

Gross necropsy

Gross necropsy of all animals (scheduled killed and killed when moribund) should include observation of the appearance of the brain and spinal cord.

Histopathological examination

Neural tissue from animals surviving the observation period and not used for biochemical studies should be subjected to microscopic examination. Tissues should be fixed *in situ*, using perfusion techniques. Sections should include cerebellum (mid-longitudinal level), medulla oblongata, spinal cord, and peripheral nerves. The spinal cord sections should be taken from the upper cervical segment, the mid-thoracic and the lumbo-sacral regions. Sections of the distal region of the tibial nerve and its branches to the gastrocnemial muscle and of the sciatic nerve should be taken. Sections should be stained with appropriate myelin and axon-specific stains.

2.**DATA**

Negative results on the endpoints selected in this method (biochemistry, histopathology and behavioural observation) would not normally require further testing for delayed neurotoxicity. Equivocal or inconclusive results for these endpoints may require further evaluation.

Individual data should be provided. Additionally, all data should be summarised in tabular form, showing for each test group the number of animals at the start of the test, the number of animals showing lesions, behavioural or biochemical effects, the types and severity of these lesions or effects, and the percentage of animals displaying each type and severity of lesion or effect.

▼B

The findings of this study should be evaluated in terms of the incidence, severity, and correlation of behavioural, biochemical and histopathological effects and any other observed effects in the treated and control groups.

Numerical results should be evaluated by appropriate and generally acceptable statistical methods. The statistical methods used should be selected during the design of the study.

3. REPORTING**TEST REPORT**

The test report shall, if possible, include the following information:

3.1. Test animals:

- strain used,
- number and age of animals,
- source, housing conditions, etc.,
- individual weights of animals at the start of the test.

3.2. Test conditions:

- details of test substance preparation, stability and homogeneity, where appropriate,
- justification for choice of vehicle,
- details of the administration of the test substance,
- details of food and water quality,
- rationale for dose selection,
- specification of doses administered, including details of the vehicle, volume and physical form of the material administered,
- identity and details of the administration of any protective agent.

3.3. Results:

- body weight data,
- toxic response data by group, including mortality,
- nature, severity and duration of clinic observations (whether reversible or not),
- a detailed description of biochemical methods and findings,
- necropsy findings,
- a detailed description of all histopathological findings,
- statistical treatment of results, where appropriate.

Discussion of results.

Conclusions.

4. REFERENCES

This method is analogous to OECD TG 418.

▼B**B.38. DELAYED NEUROTOXICITY OF ORGANOPHOSPHORUS SUBSTANCES 28-DAY REPEATED DOSE STUDY****1. METHOD****1.1. INTRODUCTION**

In the assessment and evaluation of the toxic effects of substances, it is important to consider the potential of certain classes of substances to cause specific types of neurotoxicity that might not be detected in other toxicity studies. Certain organophosphorus substances have been observed to cause delayed neurotoxicity and should be considered as candidates for evaluation.

In vitro screening tests could be employed to identify those substances which may cause delayed polyneuropathy; however, negative findings from *in vitro* studies do not provide evidence that the test substance is not a neurotoxicant.

This 28-day delayed neurotoxicity test provides information on possible health hazards likely to arise from repeated exposures over a limited period of time. It will provide information on dose response and can provide an estimate of a no-observed-adverse effect level, which can be of use for establishing safety criteria for exposure.

See also General introduction Part B.

1.2. DEFINITIONS

Organophosphorus substances include uncharged organophosphorus esters, thioesters or anhydrides of organophosphoric, organophosphonic or organophosphoramidic acids or of related phosphorothioic, phosphonothioic or phosphorothioamidic acids or other substances that may cause the delayed neurotoxicity sometimes seen in this class of substances.

Delayed neurotoxicity is a syndrome associated with prolonged delayed onset of ataxia, distal axonopathies in spinal cord and peripheral nerve, and inhibition and ageing of neuropathy target esterase (NTE) in neural tissue.

1.3. PRINCIPLE OF THE TEST METHOD

Daily doses of the test substance are administered orally to domestic hens for 28 days. The animals are observed at least daily for behavioural abnormalities, ataxia and paralysis until 14 days after the last dose. Biochemical measurements, in particular neuropathy target esterase inhibition (NTE), are undertaken, on hens randomly selected from each group, normally 24 and 48 hours after the last dose. Two weeks after the last dose, the remainder of the hens are killed and histopathological examination of selected neural tissues is undertaken.

▼ B

1.4. DESCRIPTION OF THE TEST METHOD

1.4.1. **Preparations**

Healthy young adult hens free from interfering viral diseases and medication, and without abnormalities of gait should be randomised and assigned to treatment and control groups and acclimatised to the laboratory conditions for at least five days prior to the start of the study.

Cages or enclosures which are large enough to permit free mobility of the hens and easy observation of gait should be used.

Oral dosing each day, seven days per week, should be carried out, preferably by gavage or administration of gelatine capsules. Liquids may be given undiluted or dissolved in an appropriate vehicle such as corn oil; solids should be dissolved if possible since large doses of solids in gelatine capsules may not be absorbed efficiently. For non-aqueous vehicles the toxic characteristics of the vehicle should be known, and if not known should be determined before the test.

1.4.2. **Test conditions**1.4.2.1. *Test animals*

The young adult domestic laying hen (*Gallus gallus domesticus*), aged eight to 12 months, is recommended. Standard size, breeds and strains should be employed and the hens normally should have been reared under conditions which permitted free mobility.

1.4.2.2. *Number and sex*

Generally at least three treatment groups and a vehicle control group should be used. The vehicle control group should be treated in a manner identical to the treatment group, except that administration of the test substance is omitted.

Sufficient number of hens should be utilised in each group of birds so that at least six birds can be killed for biochemical determinations (three at each of two timepoints) and six birds can survive the 14-day post-treatment observation period for pathology.

1.4.2.3. *Dose levels*

Dose levels should be selected taking into account the results from an acute test on delayed neurotoxicity and any other existing toxicity or kinetic data available for the test compound. The highest dose level should be chosen with the aim of inducing toxic effects, preferably delayed neurotoxicity, but not death nor obvious suffering. Thereafter, a descending sequence of dose levels should be selected with a view to demonstrate any dose-related response and no-observed-adverse effects at the lowest dose level.

▼ B1.4.2.4. *Limit test*

If a test at a dose level of at least 1 000 mg/kg body weight/day, using the procedures described for this study, produces no observable toxic effects and if toxicity would not be expected based upon data from structurally related substances, then a study using a higher dose may not be considered necessary. The limit test applies except when expected human exposure indicates the need for a higher dose level to be used.

1.4.2.5. *Observation period*

All the animals should be observed at least daily during the exposure period and 14 days after, unless scheduled necropsy.

1.4.3. **Procedure**

Animals are dosed with the test substance on seven days per week for a period of 28 days.

General observations

Observations should start immediately after treatment begins. All hens should be carefully observed at least once daily on each of the 28 days of treatment, and for 14 days after dosing or until scheduled kill. All signs of toxicity should be recorded including their time of onset, type, severity and duration. Observations should include, but not be limited to, behavioural abnormalities. Ataxia should be measured on an ordinal grading scale consisting of at least four levels, and paralysis should be noted. At least twice a week the hens should be taken outside the cages and subjected to a period of forced motor activity, such as ladder climbing, in order to facilitate the observation of minimal toxic effects. Moribund animals in severe distress or pain should be removed when noticed, humanely killed and necropsied.

Body weight

All hens should be weighed just prior to the first administration of the test substance and at least once a week thereafter.

Biochemistry

Six hens randomly selected from each of the treatment and vehicle control groups should be killed within a few days after the last dose, and the brain and lumbar spinal cord prepared and assayed for neuropathy target esterase (NTE) inhibition activity. In addition, it may also be useful to prepare and assay sciatic nerve tissue for neuropathy target esterase (NTE) inhibition activity. Normally, three birds of the control and each treatment group are killed after 24 hours and three at 48 hours after the last dose. If data from the acute study or other studies (e.g. toxicokinetics) indicate that other times of killing after final dosing are preferable then these times should be used and the rationale documented.

Analyses of acetylcholinesterase (AChE) may also be performed on these samples, if deemed appropriate. However, spontaneous reactivation of AChE may occur *in vivo*, and so lead to underestimation of the potency of the substance as an AChE inhibitor.

▼B*Gross necropsy*

Gross necropsy of all animals (scheduled killed and killed when moribund) should include observation of the appearance of the brain and spinal cord.

Histopathological examination

Neural tissue from animals surviving the observation period and not used for biochemical studies should be subjected to microscopic examination. Tissues should be fixed *in situ*, using perfusion techniques. Sections should include cerebellum (mid longitudinal level), medulla oblongata, spinal cord and peripheral nerves. The spinal cord sections should be taken from the upper cervical segment, the mid-thoracic and the lumbo-sacral regions. Sections of the distal region of the tibial nerve and its branches to the gastrocnemial muscle and of the sciatic nerve should be taken. Sections should be stained with appropriate myelin and axon-specific stains. Initially, microscopic examination should be carried out on the preserved tissues of all animals in the control and high dose group. When there is evidence of effects in the high dose group, microscopic examination should also be carried out in hens from the intermediate and low dose groups.

2. DATA

Negative results on the endpoints selected in this method (biochemistry, histopathology and behavioural observation) would not normally require further testing for delayed neurotoxicity. Equivocal or inconclusive results for these endpoints may require further evaluation.

Individual data should be provided. Additionally, all data should be summarised in tabular form, showing for each test group the number of animals at the start of the test, the number of animals showing lesions, behavioural or biochemical effects, the types and severity of these lesions or effects, and the percentage of animals displaying each type and severity of lesion or effect.

The findings of this study should be evaluated in terms of the incidence, severity, and correlation of behavioural, biochemical and histopathological effects and any other observed effects in each of the treated and control groups.

Numerical results should be evaluated by appropriate and generally acceptable statistical methods. The statistical methods should be selected during the design of the study.

3. REPORTING**TEST REPORT**

The test report shall, if possible, include the following information:

3.1. Test animals:

- strain used,
- number and age of animals,
- source, housing conditions, etc.,
- individual weights of animals at the start of the test.

▼ B

- 3.2. Test conditions:
- details of test substance preparation, stability and homogeneity, where appropriate,
 - justification for choice of vehicle,
 - details of the administration of the test substance,
 - details of food and water quality,
 - rationale for dose selection,
 - specification of doses administered, including details of the vehicle, volume and physical form of the material administered,
 - rationale for choosing other times for biochemical determination, if other than 24 and 48 h.

- 3.3. Results:
- body weight data,
 - toxic response data by dose level, including mortality,
 - no-observed adverse effect level,
 - nature, severity and duration of clinic observations (whether reversible or not),
 - a detailed description of biochemical methods and findings,
 - necropsy findings,
 - a detailed description of all histopathological findings,
 - statistical treatment of results, where appropriate.

Discussion of results.

Conclusions.

4. **REFERENCES**

This method is analogous to OECD TG 419.

▼B**B.39. UNSCHEDULED DNA SYNTHESIS (UDS) TEST WITH MAMMALIAN LIVER CELLS IN VIVO****1. METHOD**

This method is a replicate of the OECD TG 486, Unscheduled DNA Synthesis (UDS) Test with Mammalian Liver Cells *In Vivo* (1997).

1.1. INTRODUCTION

The purpose of the unscheduled DNA Synthesis (UDS) test with mammalian liver cells *in vivo* is to identify test substances that induce DNA repair in liver cells of treated animals (see 1,2,3,4).

This *in vivo* test provides a method for investigating genotoxic effects of chemicals in the liver. The end-point measured is indicative of DNA damage and subsequent repair in liver cells. The liver is usually the major site of metabolism of absorbed compounds. It is thus an appropriate site to measure DNA damage *in vivo*.

If there is evidence that the test substance will not reach the target tissue, it is not appropriate to use this test.

The end-point of unscheduled DNA synthesis (UDS) is measured by determining the uptake of labelled nucleosides in cells that are not undergoing scheduled (S-phase) DNA synthesis. The most widely used technique is the determination of the uptake of tritium-labelled thymidine (³H-TdR) by autoradiography. Rat livers are preferably used for *in vivo* UDS tests. Tissues other than the livers may be used, but are not the subject of this method.

The detection of a UDS response is dependent on the number of DNA bases excised and replaced at the site of the damage. Therefore, the UDS test is particularly valuable to detect substance-induced 'longpatch repair' (20-30 bases). In contrast, 'shortpatch repair' (1-3 bases) is detected with much lower sensitivity. Furthermore, mutagenic events may result because of non-repair, misrepair or misreplication of DNA lesions. The extent of the UDS response gives no indication of the fidelity of the repair process. In addition, it is possible that a mutagen reacts with DNA but the DNA damage is not repaired via an excision repair process. The lack of specific information on mutagenic activity provided by the UDS test is compensated for by the potential sensitivity of this endpoint because it is measured in the whole genome.

See also General introduction Part B.

1.2. DEFINITIONS

Cells in repair: a net nuclear grain (NNG) higher than a preset value, to be justified at the laboratory conducting the test.

Net nuclear grains (NNG): quantitative measure for UDS activity of cells in autoradiographic UDS tests, calculated by subtracting the average number of cytoplasmic grains in nucleus-equivalent cytoplasmic areas (CG) from the number of nuclear grains (NG): $NNG = NG - CG$. NNG counts are calculated for individual cells and then pooled for cells in a culture, in parallel cultures, etc.

▼B

Unscheduled DNA Synthesis (UDS): DNA repair synthesis after excision and removal of a stretch of DNA containing a region of damage induced by chemical substances or physical agents.

1.3. PRINCIPLE OF THE TEST METHOD

The UDS test with mammalian liver cells *in vivo* indicates DNA repair synthesis after excision and removal of a stretch of DNA containing a region of damage induced by chemical substances or physical agents. The test is usually based on the incorporation of ³H-TdR into the DNA of liver cells which have a low frequency of cells in the S-phase of the cell cycle. The uptake of ³H-TdR is usually determined by autoradiography, since this technique is not as susceptible to interference from S-phase cells as, for example, liquid scintillation counting.

1.4. DESCRIPTION OF THE METHOD

1.4.1. **Preparations**

1.4.1.1. *Selection of animal species*

Rats are commonly used, although any appropriate mammalian species may be used. Commonly used laboratory strains of young healthy adult animals should be employed. At the commencement of the study the weight variation of animals should be minimal and not exceed $\pm 20\%$ of the mean weight for each sex.

1.4.1.2. *Housing and feeding conditions*

General conditions referred in the General introduction to Part B are applied although the aim for humidity should be 50-60 %.

1.4.1.3. *Preparation of the animals*

Healthy young adult animals are randomly assigned to the control and treatment groups. Cages should be arranged in such a way that possible effects due to cage placement are minimised. The animals are identified uniquely and kept in their cages for at least five days prior to the start of the study to allow for acclimatisation to the laboratory conditions.

1.4.1.4. *Test substance/Preparation*

Solid test substances should be dissolved or suspended in appropriate solvents or vehicles and diluted, if appropriate, prior to dosing of the animals. Liquid test substances may be dosed directly or diluted prior to dosing. Fresh preparations of the test substance should be employed unless stability data demonstrate the acceptability of storage.

1.4.2. **Test conditions**

1.4.2.1. *Solvent/Vehicle*

The solvent/vehicle should not produce toxic effects at the dose levels used, and should not be suspected of chemical reaction with the test substance. If other than well-known solvents/vehicles are used, their inclusion should be supported with data indicating their compatibility. It is recommended that wherever possible, the use of an aqueous solvent/vehicle should be considered first.

▼B1.4.2.2. *Controls*

Concurrent positive and negative controls (solvent/vehicle) should be included in each independently performed part of the experiment. Except for treatment with the test substance, animals in the control group should be handled in an identical manner to the animals in the treated groups.

Positive controls should be substances known to produce UDS when administered at exposure levels expected to give a detectable increase over background. Positive controls needing metabolic activation should be used at doses eliciting a moderate response (4). The doses may be chosen so that the effects are clear but do not immediately reveal the identity of the coded slides to the reader. Examples of positive control substances include:

Sampling Times	Substance	CAS No	EINECS No
Early sampling times (2-4 hours)	N-Nitrosodimethylamine	62-75-9	200-249-8
Late sampling times (12-16 hours)	N-2-Fluorenylacetamide (2-AAF)	53-96-3	200-188-6

Other appropriate positive control substances may be used. It is acceptable that the positive control should be administered by a route different from the test substance.

1.5. PROCEDURE

1.5.1. **Number and sex of animals**

An adequate number of animals should be used, to take account of natural biological variation in test response. The number of animals should be at least three analysable animals per group. Where a significant historical database has been accumulated, only one or two animals are required for the concurrent negative and positive control groups.

If at the time of the study there are data available from studies in the same species and using the same route of exposure that demonstrate that there are no substantial differences in toxicity between sexes, then testing in a single sex, preferably males, will be sufficient. Where human exposure to chemicals may be sex-specific, as for example with some pharmaceutical agents, the test should be performed with animals of the appropriate sex.

1.5.2. **Treatment schedule**

Test substances are generally administered as a single treatment.

1.5.3. **Dose levels**

Normally, at least two dose levels are used. The highest dose is defined as the dose producing signs of toxicity such that higher dose levels, based on the same dosing regimen, would be expected to produce lethality. In general, the lower dose should be 50 % to 25 % of the high dose.

▼B

Substances with specific biological activities at low non-toxic doses (such as hormones and mitogens) may be exceptions to the dose-setting criteria and should be evaluated on a case-by-case basis. If a range finding study is performed because there are no suitable data available, it should be performed in the same laboratory, using the same species, strain, sex, and treatment regimen to be used in the main study.

The highest dose may also be defined as a dose that produces some indication of toxicity in the liver (e.g. pyknotic nuclei).

1.5.4. Limit test

If a test at one dose level of at least 2 000 mg/kg body weight, applied in a single treatment, or in two treatments on the same day, produces no observable toxic effects, and if genotoxicity would not be expected, based upon data from structurally related substances, then a full study may not be necessary. Expected human exposure may indicate the need for a higher dose level to be used in the limit test.

1.5.5. Administration of doses

The test substance is usually administered by gavage using a stomach tube or a suitable intubation cannula. Other routes of exposure may be acceptable where they can be justified. However, the intraperitoneal route is not recommended as it could expose the liver directly to the test substance rather than via the circulatory system. The maximum volume of liquid that can be administered by gavage or injection at one time depends on the size of the test animal. The volume should not exceed 2 ml/100 g body weight. The use of volumes higher than these must be justified. Except for irritating or corrosive substances, which will normally reveal exacerbated effects with higher concentrations, variability in test volume should be minimised by adjusting the concentration to ensure a constant volume at all dose levels.

1.5.6. Preparation of liver cells

Liver cells are prepared from treated animals normally 12-16 hours after dosing. An additional earlier sampling time (normally two to four hours post-treatment) is generally necessary unless there is a clear positive response at 12-16 hours. However, alternative sampling times may be used when justified on the basis of toxicokinetic data.

Short-term cultures of mammalian liver cells are usually established by perfusing the liver *in situ* with collagenase and allowing freshly dissociated liver cells to attach themselves to a suitable surface. Liver cells from negative control animals should have a viability (5) of at least 50 %.

1.5.7. Determination of UDS

Freshly isolated mammalian liver cells are incubated usually with medium containing ³H-TdR for an appropriate length of time, e.g. 3-8 hours. At the end of the incubation period, medium should be removed from the cells, which may then be incubated with medium containing excess unlabelled thymidine to diminish unincorporated radioactivity ('cold chase'). The cells are then rinsed, fixed and dried. For more prolonged incubation times, cold chase may not be necessary. Slides are dipped in autoradiographic emulsion, exposed in the dark (e.g. refrigerated for 7-14 days), developed, stained, and exposed silver grains are counted. Two to three slides are prepared from each animal.

▼ B1.5.8. **Analysis**

The slide preparations should contain sufficient cells of normal morphology to permit a meaningful assessment of UDS. Preparations are examined microscopically for signs of overt cytotoxicity (e.g. pyknosis, reduced levels of radiolabelling).

Slides should be coded before grain counting. Normally 100 cells are scored from each animal from at least two slides; the scoring of less than 100 cells/animal should be justified. Grain counts are not scored for S-phase nuclei, but the proportion of S-phase cells may be recorded.

The amount of $^3\text{H-TdR}$ incorporation in the nuclei and the cytoplasm of morphologically normal cells, as evidenced by the deposition of silver grains, should be determined by suitable methods.

Grain counts are determined over the nuclei (nuclear grains, NG) and nucleus equivalent areas over the cytoplasm (cytoplasmic grains, CG). CG counts are measured by either taking the most heavily labelled area of cytoplasm, or by taking an average of two to three random cytoplasmic grain counts adjacent to the nucleus. Other counting methods (e.g. whole cell counting) may be used if they can be justified (6).

2. **DATA**

2.1. TREATMENT OF RESULTS

Individual slide and animal data should be provided. Additionally, all data should be summarised in tabular form. Net nuclear grain (NNG) counts should be calculated for each cell, for each animal and for each dose and time by subtracting CG counts from NG counts. If 'cells in repair' are counted, the criteria for defining 'cells in repair' should be justified and based on historical or concurrent negative control data. Numerical results may be evaluated by statistical methods. If used, statistical tests should be selected and justified prior to conducting the study.

2.2. EVALUATION AND INTERPRETATION OF RESULTS

Examples of criteria for positive/negative responses include:

- | | |
|----------|--|
| positive | (i) NNG values above a pre-set threshold which is justified on the basis of laboratory historical data; or |
| | (ii) NNG values significantly greater than concurrent control; |
| negative | (i) NNG values within/below historical control threshold; or |
| | (ii) NNG values not significantly greater than concurrent control. |

▼ B

The biological relevance of data should be considered: i.e. parameters such as inter-animal variation, dose-response relationship and cytotoxicity should be taken into account. Statistical methods may be used as an aid in evaluating the test results. However, statistical significance should not be the only determining factor for a positive response.

Although most experiments will give clearly positive or negative results, in rare cases the data set will preclude making a definite judgement about the activity of the test substance. Results may remain equivocal or questionable regardless of the number of times the experiment is repeated.

A positive result from the UDS test with mammalian liver cells *in vivo* indicate that a test substance induces DNA damage in mammalian liver cells *in vivo* that can be repaired by unscheduled DNA synthesis *in vitro*. A negative result indicates that, under the test conditions, the test substance does not induce DNA damage that is detectable by this test.

The likelihood that the test substance reaches the general circulation or specifically the target tissue (e.g. systemic toxicity) should be discussed.

3. REPORTING**TEST REPORT**

The test report must include the following information:

Solvent/Vehicle:

- justification for choice of vehicle,
- solubility and stability of the test substance in solvent/vehicle, if known.

Test animals:

- species/strain used,
- number, age and sex of animals,
- source, housing conditions, diet, etc.,
- individual weight of the animals at the start of the test, including body weight range, mean and standard deviation for each group,

Test conditions:

- positive and negative vehicle/solvent controls,
- data from range-finding study, if conducted,
- rationale for dose level selection,
- details of test substance preparation,
- details of the administration of the test substance,
- rationale for route of administration,
- methods for verifying that test agent reached the general circulation or target tissue, if applicable,

▼ B

- conversion from diet/drinking water test substance concentration (ppm) to the actual dose (mg/kg body weight/day), if applicable,
- details of food and water quality,
- detailed description of treatment and sampling schedules,
- methods for measurement of toxicity,
- method of liver cell preparation and culture,
- autoradiographic technique used,
- number of slides prepared and numbers of cells scored,
- evaluation criteria,
- criteria for considering studies as positive, negative or equivocal,

Results:

- individual slide, animal and group mean values for nuclear grains, cytoplasmic grains, and net nuclear grains,
- dose-response relationship, if available,
- statistical evaluation if any,
- signs of toxicity,
- concurrent negative (solvent/vehicle) and positive control data,
- historical negative (solvent/vehicle) and positive control data with range, means and standard deviations,
- number of 'cells in repair' if determined,
- number of S-phase cells if determined,
- viability of the cells.

Discussion of results.

Conclusions.

4. **REFERENCES**

- (1) Ashby, J., Lefevre, P.A., Burlinson, B. and Penman, M.G., (1985) An Assessment of the *In Vivo* Rat Hepatocyte DNA Repair Assay. *Mutation Res.*, 156, p. 1-18.
- (2) Butterworth, B.E., Ashby, J., Bermudez, E., Casciano, D., Mirsalis, J., Probst, G. and Williams, G., (1987) A Protocol and Guide for the *In Vivo* Rat Hepatocyte DNA-Repair Assay. *Mutation Res.*, 189, p. 123-133.
- (3) Kennelly, J.C., Waters, R., Ashby, J., Lefevre, P.A., Burlinson, B., Benford, D.J., Dean, S.W. and Mitchell, I. de G., (1993) *In Vivo* Rat Liver UDS Assay. In: Kirkland D.J. and Fox M., (Eds) *Supplementary Mutagenicity Tests: UKEM Recommended Procedures*. UKEMS Subcommittee on Guidelines for Mutagenicity Testing. Report. Part II revised. Cambridge University Press, Cambridge, New York, Port Chester, Melbourne, Sydney, p. 52-77.

▼B

- (4) Madle, S., Dean, S.W., Andrae, U., Brambilla, G., Burlinson, B., Doolittle, D.J., Furihata, C., Hertner, T., McQueen, C.A. and Mori, H., (1993) Recommendations for the Performance of UDS Tests *In Vitro* and *In Vivo*. *Mutation Res.*, 312, p. 263-285.
- (5) Fautz, R., Hussain, B., Efstathiou, E. and Hechenberger-Freudl, C., (1993) Assessment of the Relation Between the Initial Viability and the Attachment of Freshly Isolated Rat Hepatocytes Used for the *In Vivo/In Vitro* DNA Repair Assay (UDS). *Mutation Res.*, 291, p. 21-27.
- (6) Mirsalis, J.C., Tyson, C.K. and Butterworth, B.E., (1982) Detection of Genotoxic Carcinogens in the *In Vivo/In Vitro* Hepatocyte DNA Repair Assay. *Environ. Mutagen*, 4, p. 553-562.

▼M8**B.40. IN VITRO SKIN CORROSION: TRANSCUTANEOUS ELECTRICAL RESISTANCE TEST METHOD (TER)**

INTRODUCTION

1. This test method (TM) is equivalent to OECD test guideline (TG) 430 (2015). Skin corrosion refers to the production of irreversible damage to the skin manifested as visible necrosis through the epidermis and into the dermis, following the application of a test chemical [as defined by the United Nations (UN) Globally Harmonized System of Classification and Labelling of Chemicals (GHS) (1) and the European Union (EU) Regulation 1272/2008 on Classification, Labelling and Packaging of Substances and Mixtures (CLP)⁽¹⁾]. This updated test method B.40 provides an *in vitro* procedure allowing the identification of non-corrosive and corrosive substances and mixtures in accordance with UN GHS (1) and CLP

2. The assessment of skin corrosivity has typically involved the use of laboratory animals (TM B.4, equivalent to OECD TG 404 originally adopted in 1981, and revised in 1992, 2002 and 2015) (2). In addition to the present TM B.40, other *in vitro* test methods for testing of skin corrosion potential of chemicals have been validated and adopted as TM B.40bis (equivalent to OECD TG 431) (3) and TM B.65 (equivalent to OECD TG 435) (4), that are also able to identify sub-categories of corrosive chemicals when required. Several validated *in vitro* test methods have been adopted as TM B.46 (equivalent to OECD TG 439 (5), to be used for the testing of skin irritation. An OECD guidance document on Integrated Approaches to Testing and Assessment (IATA) for Skin Corrosion and Irritation describes several modules which group various information sources and analysis tools and provides guidance on (i) how to integrate and use existing testing and non-testing data for the assessment of skin irritation and skin corrosion potentials of chemicals and (ii) proposes an approach when further testing is needed (6).

3. This test method addresses the human health endpoint skin corrosion. It is based on the rat skin transcutaneous electrical resistance (TER) test method, which utilises skin discs to identify corrosives by their ability to produce a loss of normal *stratum corneum* integrity and barrier function. The corresponding OECD test guideline was originally adopted in 2004 and updated in 2015 to refer to the IATA guidance document.

4. In order to evaluate *in vitro* skin corrosion testing for regulatory purposes, pre-validation studies (7) followed by a formal validation study of the rat skin TER test method for assessing skin corrosion were conducted (8) (9) (10) (11). The outcome of these studies led to the recommendation that the

⁽¹⁾ Regulation (EC) No 1272/2008 of the European Parliament and of the Council of 16 December 2008 on classification, labelling and packaging of substances and mixtures, amending and repealing Directives 67/548/EEC and 1999/45/EC, and amending Regulation (EC) No 1907/2006, OJ L 353/1, 31.12.2008

▼ M8

TER test method (designated the Validated Reference Method – VRM) could be used for regulatory purposes for the assessment of *in vivo* skin corrosivity (12) (13) (14).

5. Before a proposed similar or modified *in vitro* TER test method for skin corrosion other than the VRM can be used for regulatory purposes, its reliability, relevance (accuracy), and limitations for its proposed use should be determined to ensure its similarity to the VRM, in accordance with the requirements of the Performance Standards (PS) (15). OECD Mutual Acceptance of Data will only be guaranteed after any proposed new or updated test method following the PS have been reviewed and included in the corresponding OECD test guideline.

DEFINITIONS

6. Definitions used are provided in the Appendix.

INITIAL CONSIDERATIONS

7. A validation study (10) and other published studies (16) (17) have reported that the rat skin TER test method is able to discriminate between known skin corrosives and non-corrosives with an overall sensitivity of 94 % (51/54) and specificity of 71 % (48/68) for a database of 122 substances.
8. This test method addresses *in vitro* skin corrosion. It allows the identification of non-corrosive and corrosive test chemicals in accordance with the UN GHS/CLP. A limitation of this test method, as demonstrated by the validation studies (8) (9) (10) (11), is that it does not allow the sub-categorisation of corrosive substances and mixtures in accordance with the UN GHS/CLP. The applicable regulatory framework will determine how this test method will be used. While this test method does not provide adequate information on skin irritation, it should be noted that TM B.46 specifically addresses the health effect skin irritation *in vitro* (5). For a full evaluation of local skin effects after a single dermal exposure, the OECD Guidance Document on IATA should be consulted (6).
9. A wide range of chemicals representing mainly substances has been tested in the validation underlying this test method and the empirical database of the validation study amounted to 60 substances covering a wide range of chemical classes (8) (9). On the basis of the overall data available, the test method is applicable to a wide range of chemical classes and physical states including liquids, semi-solids, solids and waxes. However, since for specific physical states test items with suitable reference data are not readily available, it should be noted that a comparably small number of waxes and corrosive solids were assessed during validation. The liquids may be aqueous or non-aqueous; solids may be soluble or insoluble in water. In cases where evidence can be demonstrated on the non-applicability of the test method to a specific category of substances, the test method should not be used for that specific category of substances. In addition, this test method is assumed to be applicable to mixtures as an extension of its applicability to substances. However, due to the fact that mixtures cover a wide spectrum of categories and composition, and that only limited information is currently available on the testing of mixtures, in cases where evidence can be demonstrated on the non-applicability of the test method to a specific category of mixtures (e.g. following a strategy as proposed by Eskes *et al.*, 2012) (18), the test method should not be used for that specific category of mixtures. Before use of the test method on a mixture for generating data for an intended regulatory purpose, it should be considered whether, and if so

▼ **M8**

why, it may provide adequate results for that purpose. Such considerations are not needed, when there is a regulatory requirement for testing of the mixture. Gases and aerosols have not been assessed yet in validation studies (8) (9). While it is conceivable that these can be tested using the TER test method, the current test method does not allow testing of gases and aerosols.

PRINCIPLE OF THE TEST

10. The test chemical is applied for up to 24 hours to the epidermal surfaces of skin discs in a two-compartment test system in which the skin discs function as the separation between the compartments. The skin discs are taken from humanely killed rats aged 28-30 days. Corrosive chemicals are identified by their ability to produce a loss of normal *stratum corneum* integrity and barrier function, which is measured as a reduction in the TER below a threshold level (16) (see paragraph 32). For rat skin TER, a cut-off value of 5k has been selected based on extensive data for a wide range of substances where the vast majority of values were either clearly well above (often > 10 k), or well below (often < 3 k) this value (16). Generally, test chemicals that are non-corrosive in animals but are irritant or non-irritant do not reduce the TER below this cut-off value. Furthermore, use of other skin preparations or other equipment may alter the cut-off value, necessitating further validation.
11. A dye-binding step is incorporated into the test procedure for confirmation testing of positive results in the TER including values around 5 k. The dye-binding step determines if the increase in ionic permeability is due to physical destruction of the *stratum corneum*. The TER method utilising rat skin has shown to be predictive of *in vivo* corrosivity in the rabbit assessed under TM B.4 (2).

DEMONSTRATION OF PROFICIENCY

12. Prior to routine use of the rat skin TER test method that adheres to this test method, laboratories should demonstrate technical proficiency by correctly classifying the twelve Proficiency Substances recommended in Table 1. In situations where a listed substance is unavailable or where justifiable, another substance for which adequate *in vivo* and *in vitro* reference data are available may be used (e.g. from the list of reference chemicals (16)) provided that the same selection criteria as described in Table 1 is applied.

Table 1

List of Proficiency Substances ⁽¹⁾

Substance	CASRN	Chemical Class ⁽²⁾	UN GHS/CLP Cat. Based on <i>In Vivo</i> Results ⁽³⁾	VRM Cat. Based on <i>In Vitro</i> Results	Physical State	pH ⁽⁴⁾
<i>In Vivo</i> Corrosives						
N,N'-Dimethyldipropylenetriamine	10563-29-8	organic base	1A	6 × C	L	8,3
1,2-Diaminopropane	78-90-0	organic base	1A	6 × C	L	8,3

▼M8

Substance	CASRN	Chemical Class ⁽²⁾	UN GHS/CLP Cat. Based on <i>In Vivo</i> Results ⁽³⁾	VRM Cat. Based on <i>In Vitro</i> Results	Physical State	pH ⁽⁴⁾
<i>In Vivo</i> Corrosives						
Sulfuric acid (10 %)	7664-93-9	inorganic acid	(1A/1B/1C	5 × C 1 × NC	L	1,2
Potassium hydroxide (10 % aq.)	1310-58-3	inorganic base	(1A/1B/1C	6 × C	L	13,2
Octanoic (Caprylic) acid	124-07-2	organic acid	1B/1C	4 × C 2 × NC	L	3,6
2-tert-Butylphenol	88-18-6	phenol	1B/1C	4 × C 2 × NC	L	3,9
<i>In Vivo</i> Non-corrosives						
Isostearic acid	2724-58-5	organic acid	NC	6 × NC	L	3,6
4-Amino-1,2,4-triazole	584-13-4	organic base	NC	6 × NC	S	5,5
Phenethyl bromide	103-63-9	electrophile	NC	6 × NC	L	3,6
4-(Methylthio)-benzaldehyde	3446-89-7	electrophile	NC	6 × NC	L	6,8
1,9-Decadiene	1647-16-1	neutral organic	NC	6 × NC	L	3,9
Tetrachloroethylene	127-18-4	neutral organic	NC	6 × NC	L	4,5

Abbreviations: aq = aqueous; CASRN = Chemical Abstracts Service Registry Number; VRM = Validated Reference Method; C = corrosive; NC = not corrosive.

⁽¹⁾ The proficiency substances, sorted first by corrosives versus non-corrosives, then by corrosive subcategory and then by chemical class, were selected from the substances used in the ECVAM validation study of the rat skin TER test method (8) (9). Unless otherwise indicated, the substances were tested at the purity level obtained when purchased from a commercial source (8). The selection included, to the extent possible, substances that: (i) are representative of the range of corrosivity responses (e.g. non-corrosives; weak to strong corrosives) that the VRM is capable of measuring or predicting; (ii) are representative of the chemical classes used in the validation study; (iii) reflect the performance characteristics of the VRM; (iv) have chemical structures that are well-defined; (v) induce definitive results in the *in vivo* reference test method; (vi) are commercially available; and (vii) are not associated with prohibitive disposal costs.

⁽²⁾ Chemical class assigned by Barratt *et al.* (8).

⁽³⁾ The corresponding UN Packing groups are I, II and III, respectively, for the UN GHS/CLP categories 1A, 1B and 1C.

⁽⁴⁾ The pH values were obtained from Fentem *et al.* (9) and Barratt *et al.* (8).

▼M8**PROCEDURE**

- Standard Operating Procedures (SOP) for the rat skin TER skin corrosion test method are available (19). The rat skin TER test methods covered by this test method should comply with the following conditions:

Animals

- Rats should be used because the sensitivity of their skin to substances in this test method has been previously demonstrated (12) and is the only skin source that has been formally validated (8) (9). The age (when the skin is collected) and strain of the rat is particularly important to ensure that the hair follicles are in the dormant phase before adult hair growth begins.
- The dorsal and flank hair from young, approximately 22 day-old, male or female rats (Wistar-derived or a comparable strain), is carefully removed with small clippers. Then, the animals are washed by careful wiping, whilst submerging the clipped area in antibiotic solution (containing, for example, streptomycin, penicillin, chloramphenicol, and amphotericin, at concentrations effective in inhibiting bacterial growth). Animals are washed with antibiotics again on the third or fourth day after the first wash and are used within 3 days of the second wash, when the *stratum corneum* has recovered from the hair removal.

Preparation of the skin discs

- Animals are humanely killed when 28-30 days old; this age is critical. The dorso-lateral skin of each animal is then removed and stripped of excess subcutaneous fat by carefully peeling it away from the skin. Skin discs, with a diameter of approximately 20-mm each, are removed. The skin may be stored before discs are used where it is shown that positive and negative control data are equivalent to that obtained with fresh skin.
- Each skin disc is placed over one of the ends of a PTFE (polytetrafluoroethylene) tube, ensuring that the epidermal surface is in contact with the tube. A rubber 'O' ring is press-fitted over the end of the tube to hold the skin in place and excess tissue is trimmed away. The rubber 'O' ring is then carefully sealed to the end of the PTFE tube with petroleum jelly. The tube is supported by a spring clip inside a receptor chamber containing MgSO₄ solution (154 mM) (Figure 1). The skin disc should be fully submerged in the MgSO₄ solution. As many as 10-15 skin discs can be obtained from a single rat skin. Tube and 'O' ring dimensions are shown in Figure 2.
- Before testing begins, the TER of two skin discs are measured as a quality control procedure for each animal skin. Both discs should give electrical resistance values greater than 10 k for the remainder of the discs to be used for the test method. If the resistance value is less than 10 k, the remaining discs from that skin should be discarded.

Application of the test chemical and control substances

- Concurrent positive and negative controls should be used for each run (experiment) to ensure adequate performance of the experimental model. Skin discs from a single animal should be used in each run (experiment). The suggested positive and negative control test chemicals are 10 M hydrochloric acid and distilled water, respectively.

▼M8

20. Liquid test chemicals (150 µl) are applied uniformly to the epidermal surface inside the tube. When testing solid materials, a sufficient amount of the solid is applied evenly to the disc to ensure that the whole surface of the epidermis is covered. Deionised water (150 µl) is added on top of the solid and the tube is gently agitated. In order to achieve maximum contact with the skin, solids may need to be warmed to 30° C to melt or soften the test chemical, or ground to produce a granular material or powder.

21. Three skin discs are used for each test and control chemical in each testing run (experiment). Test chemicals are applied for 24 hours at 20-23° C. The test chemical is removed by washing with a jet of tap water at up to room temperature until no further material can be removed.

TER measurements

22. The skin impedance is measured as TER by using a low-voltage, alternating current Wheatstone bridge (18). General specifications of the bridge are 1-3 Volt operating voltage, a sinus or rectangular shaped alternating current of 50 - 1 000 Hz, and a measuring range of at least 0,1-30 k. The databridge used in the validation study measured inductance, capacitance and resistance up to values of 2 000H, 2 000 F, and 2 M, respectively at frequencies of 100Hz or 1kHz, using series or parallel values. For the purposes of the TER corrosivity assay measurements are recorded in resistance, at a frequency of 100 Hz and using series values. Prior to measuring the electrical resistance, the surface tension of the skin is reduced by adding a sufficient volume of 70 % ethanol to cover the epidermis. After a few seconds, the ethanol is removed from the tube and the tissue is then hydrated by the addition of 3 ml MgSO₄ solution (154mM). The databridge electrodes are placed on either side of the skin disc to measure the resistance in kΩ/skin disc (Figure 1). Electrode dimensions and the length of the electrode exposed below the crocodile clips are shown in Figure 2. The clip attached to the inner electrode is rested on the top of the PTFE tube during resistance measurement to ensure that a consistent length of electrode is submerged in the MgSO₄ solution. The outer electrode is positioned inside the receptor chamber so that it rests on the bottom of the chamber. The distance between the spring clip and the bottom of the PTFE tube is maintained as a constant (Figure 2), because this distance affects the resistance value obtained. Consequently, the distance between the inner electrode and the skin disc should be constant and minimal (1-2 mm).

23. If the measured resistance value is greater than 20 k, this may be due to the remains of the test chemical coating the epidermal surface of the skin disc. Further removal of this coating can be attempted, for example, by sealing the PTFE tube with a gloved thumb and shaking it for approximately 10 seconds; the MgSO₄ solution is discarded and the resistance measurement is repeated with fresh MgSO₄.

24. The properties and dimensions of the test apparatus and the experimental procedure used may influence the TER values obtained. The 5 k corrosive threshold was developed from data obtained with the specific apparatus and procedure described in this test method. Different threshold and control values may apply if the test conditions are altered or a different apparatus is used. Therefore, it is necessary to calibrate the methodology and resistance threshold values by testing a series of Proficiency Substances chosen from the substances used in the validation study (8) (9), or from similar chemical classes to the substances being investigated. A set of suitable Proficiency Substances is identified in Table 1.

▼ M8**Dye Binding Methods**

25. Exposure of certain non-corrosive materials can result in a reduction of resistance below the cut-off of 5 k Ω allowing the passage of ions through the *stratum corneum*, thereby reducing the electrical resistance (9). For example, neutral organics and substances that have surface-active properties (including detergents, emulsifiers and other surfactants) can remove skin lipids making the barrier more permeable to ions. Thus, if TER values produced by such chemicals are less than or around 5 k Ω in the absence of visually perceptible damage of the skin discs, an assessment of dye penetration should be carried out on the control and treated tissues to determine if the TER values obtained were the result of increased skin permeability, or skin corrosion (7) (9). In case of the latter where the *stratum corneum* is disrupted, the dye sulforhodamine B, when applied to the skin surface rapidly penetrates and stains the underlying tissue. This particular dye is stable to a wide range of substances and is not affected by the extraction procedure described below.

Sulforhodamine B dye application and removal

26. Following TER assessment, the magnesium sulphate is discarded from the tube and the skin is carefully examined for obvious damage. If there is no obvious major damage (*e.g.* perforation), 150 l of a 10 % (w/v) dilution in distilled water of the dye sulforhodamine B (Acid Red 52; C.I. 45100; CAS number 3520-42-1), is applied to the epidermal surface of each skin disc for 2 hours. These skin discs are then washed with tap water at up to room temperature for approximately 10 seconds to remove any excess/unbound dye. Each skin disc is carefully removed from the PTFE tube and placed in a vial (*e.g.* a 20-ml glass scintillation vial) containing deionised water (8 ml). The vials are agitated gently for 5 minutes to remove any additional unbound dye. This rinsing procedure is then repeated, after which the skin discs are removed and placed into vials containing 5ml of 30 % (w/v) sodium dodecyl sulphate (SDS) in distilled water and are incubated overnight at 60° C.
27. After incubation, each skin disc is removed and discarded and the remaining solution is centrifuged for 8 minutes at 21° C (relative centrifugal force $\sim 175 \times g$). A 1ml sample of the supernatant is diluted 1 in 5 (v/v) [*i.e.* 1ml + 4ml] with 30 % (w/v) SDS in distilled water. The optical density (OD) of the solution is measured at 565 nm.

Calculation of dye content

28. The sulforhodamine B dye content per disc is calculated from the OD values (9) (sulforhodamine B dye molar extinction coefficient at 565nm = $8,7 \times 10^4$; molecular weight = 580). The dye content is determined for each skin disc by the use of an appropriate calibration curve and mean dye content is then calculated for the replicates.

Acceptability Criteria

29. The mean TER results are accepted if the concurrent positive and negative control values fall within the acceptable ranges for the method in the testing laboratory. The acceptable resistance ranges for the methodology and apparatus described above are given in the following table:

▼M8

Control	Substance	Resistance range (k)
Positive	10 M Hydrochloric acid	0,5 – 1,0
Negative	Distilled water	10 – 25

30. The mean dye binding results are accepted on condition that concurrent control values fall within the acceptable ranges for the method. Suggested acceptable dye content ranges for the control substances for the methodology and apparatus described above are given in the following table:

Control	Substance	Dye content range (g/disc)
Positive	10 M Hydrochloric acid	40 – 100
Negative	Distilled water	15 – 35

Interpretation of results

31. The cut-off TER value distinguishing corrosive from non-corrosive test chemicals was established during test method optimisation, tested during a pre-validation phase, and confirmed in a formal validation study.
32. The prediction model for rat skin TER skin corrosion test method (9) (19), associated with the UN GHS/CLP classification system, is given below:

The test chemical is considered to be non-corrosive to skin:

- i) if the mean TER value obtained for the test chemical is greater than ($>$) 5 k Ω , or
- ii) the mean TER value obtained for the test chemical is less than or equal to (\leq) 5 k Ω , and
 - the skin discs show no obvious damage(e.g. perforation), and
 - the mean disc dye content is less than ($<$) the mean disc dye content of the 10 M HCl positive control obtained concurrently (see paragraph 30 for positive control values).

The test chemical is considered to be corrosive to skin:

- i) if the mean TER value obtained for the test chemical is less than or equal to (\leq) 5 k Ω and the skin discs are obviously damaged(e.g. perforated), or
- ii) the mean TER value obtained for the test chemical is less than or equal to (\leq) 5 k Ω , and
 - the skin discs show no obvious damage(e.g. perforation), but

▼M8

- the mean disc dye content is greater than or equal to (\geq) the mean disc dye content of the 10 M HCl positive control obtained concurrently (see paragraph 30 for positive control values).

33. A testing run (experiment) composed of at least three replicate skin discs should be sufficient for a test chemical when the classification is unequivocal. However, in cases of borderline results, such as non-concordant replicate measurements and/or mean TER equal to 5 ± 0.5 k Ω , a second independent testing run (experiment) should be considered, as well as a third one in case of discordant results between the first two testing runs (experiments).

DATA AND REPORTING**Data**

34. Resistance values (k Ω) and dye content values ($\mu\text{g}/\text{disc}$), where appropriate, for the test chemical, as well as for positive and negative controls should be reported in tabular form, including data for each individual replicate disc in each testing run (experiment) and mean values \pm SD. All repeat experiments should be reported. Observed damage in the skin discs should be reported for each test chemical.

Test report

35. The test report should include the following information:

Test Chemical and Control Substances:

- Mono-constituent substance: chemical identification, such as IUPAC or CAS name, CAS number, SMILES or InChI code, structural formula, purity, chemical identity of impurities as appropriate and practically feasible, etc;
- Multi-constituent substance, UVCB and mixture: characterised as far as possible by chemical identity (see above), quantitative occurrence and relevant physico-chemical properties of the constituents;
- Physical appearance, water solubility, and additional relevant physico-chemical properties;
- Source, lot number if available;
- Treatment of the test chemical/control substance prior to testing, if applicable (e.g. warming, grinding);
- Stability of the test chemical, limit date for use, or date for re-analysis if known;
- Storage conditions.

Test Animals:

- Strain and sex used;
- Age of the animals when used as donor animals;
- Source, housing condition, diet, etc.;
- Details of the skin preparation.

▼M8*Test Conditions:*

- Calibration curves for test apparatus;
- Calibration curves for dye binding test performance, band pass used for measuring OD values, and OD linearity range of measuring device (*e.g.* spectrophotometer), if appropriate;
- Details of the test procedure used for TER measurements;
- Details of the test procedure used for the dye binding assessment, if appropriate;
- Test doses used, duration of exposure period(s) and temperature(s) of exposure;
- Details on washing procedure used after the exposure period;
- Number of replicate skin discs used per test chemical and controls (positive and negative control);
- Description of any modification of the test procedure;
- Reference to historical data of the model. This should include, but is not limited to:
 - i) Acceptability of the positive and negative control TER values (in $k\Omega$) with reference to positive and negative control resistance ranges
 - ii) Acceptability of the positive and negative control dye content values (in $\mu\text{g}/\text{disc}$) with reference to positive and negative control dye content ranges
 - iii) Acceptability of the test results with reference to historical variability between skin disc replicates
- Description of decision criteria/prediction model applied.

Results:

- Tabulation of data from the TER and dye binding assays (if appropriate) for individual test chemicals and controls, for each testing run (experiment) and each skin disc replicate (individual animals and individual skin samples), means, SDs and CVs;
- Description of any effects observed;
- The derived classification with reference to the prediction model/decision criteria used.

*Discussion of the results**Conclusions***LITERATURE**

- (1) United Nations (UN) (2013). Globally Harmonized System of Classification and Labelling of Chemicals (GHS), Second Revised Edition, UN New York and Geneva, 2013. Available at: [http://www.unece.org/trans/danger/publi/ghs/ghs_rev05/05files_e.html].

▼ **M8**

- (2) Chapter B.4 of this Annex, Acute Dermal Irritation, Corrosion.
- (3) Chapter B.40bis of this Annex, *In Vitro* Skin Model.
- (4) Chapter B.65 of this Annex, *In Vitro* Membrane Barrier Test Method.
- (5) Chapter B.46 of this Annex, *In Vitro* Skin Irritation: Reconstructed Human Epidermis Test Method.
- (6) OECD (2014). Guidance document on Integrated Approaches to Testing and Assessment for Skin Irritation/Corrosion. Environment, Health and Safety Publications, Series on Testing and Assessment, (No 203), Organisation for Economic Cooperation and Development, Paris.
- (7) Botham P.A., Chamberlain M., Barratt M.D., Curren R.D., Esdaile D.J., Gardner J.R., Gordon V.C., Hildebrand B., Lewis R.W., Liebsch M., Logemann P., Osborne R., Ponc M., Regnier J.F., Steiling W., Walker A.P., and Balls M. (1995). A Prevalidation Study on *In Vitro* Skin Corrosivity Testing. The Report and Recommendations of ECVAM Workshop 6. *ATLA* 23, 219-255.
- (8) Barratt M.D., Brantom P.G., Fentem J.H., Gerner I., Walker A.P., and Worth A.P. (1998). The ECVAM International Validation Study on *In Vitro* Tests for Skin Corrosivity. 1. Selection and Distribution of the Test Chemicals. *Toxic.In Vitro* 12, 471-482.
- (9) Fentem J.H., Archer G.E.B., Balls M., Botham P.A., Curren R.D., Earl L.K., Esdaile D.J., Holzhütter H.-G., and Liebsch M. (1998). The ECVAM International Validation Study on *In Vitro* Tests For Skin Corrosivity. 2. Results and Evaluation by the Management Team. *Toxic.In Vitro* 12, 483- 524.
- (10) Balls M., Blaauboer B.J., Fentem J.H., Bruner L., Combes R.D., Ekwall B., Fielder R.J., Guillouzo A., Lewis R.W., Lovell D.P., Reinhardt C.A., Repetto G., Sladowski D., Spielmann H., and Zucco F. (1995). Practical Aspects of the Validation of Toxicity Test Procedures. The Report and Recommendations of ECVAM Workshops. *ATLA* 23, 129-147.
- (11) ICCVAM (Interagency Coordinating Committee on the Validation of Alternative Methods). (1997). Validation and Regulatory Acceptance of Toxicological Test Methods. NIH Publication No 97-3981. National Institute of Environmental Health Sciences, Research Triangle Park, NC, USA.
- (12) EC-ECVAM (1998). Statement on the Scientific Validity of the Rat Skin Transcutaneous Electrical Resistance (TER) Test (an *In Vitro* Test for Skin Corrosivity), Issued by the ECVAM Scientific Advisory Committee (ESAC10), 3 April 1998.
- (13) ECVAM (1998). ECVAM News & Views. *ATLA* 26, 275-280.
- (14) ICCVAM (Interagency Coordinating Committee on the Validation of Alternative Methods) (2002). ICCVAM Evaluation of EpiDermTM (EPI-200), EpiSkinTM (SM), and the Rat Skin Transcutaneous Electrical Resistance (TER) Assay: *In Vitro* Test Methods for Assessing Dermal Corrosivity Potential of Chemicals. NIH Publication No 02-4502. National Toxicology Program Interagency Center for the Evaluation of Alternative Toxicological Methods, National Institute of Environmental Health Sciences, Research Triangle Park, NC, USA.
- (15) OECD (2015). Performance Standards for the Assessment of Proposed Similar or Modified *In Vitro* Transcutaneous Electrical Resistance (TER) Test Method for Skin Corrosion in Relation to TG 430. Environment Health and Safety Publications, Series on Testing and Assessment No 218. Organisation for Economic Cooperation and Development, Paris.

▼M8

- (16) Oliver G.J.A., Pemberton M.A., and Rhodes C. (1986). An *In Vitro* Skin Corrosivity Test -Modifications and Validation. *Fd. Chem. Toxicol.*24, 507-512.
- (17) Botham P.A., Hall T.J., Dennett R., McCall J.C., Basketter D.A., Whittle E., Cheeseman M., Esdaile D.J., and Gardner J. (1992). The Skin Corrosivity Test *In Vitro*: Results of an Interlaboratory Trial. *Toxicol. In Vitro* 6,191-194.
- (18) Eskes C., Detappe V., Koëter H., Kreysa J., Liebsch M., Zuang V., Amcoff P., Barroso J., Cotovio J., Guest R., Hermann M., Hoffmann S., Masson P., Alépée N., Arce L.A., Brüschweiler B., Catone T., Cihak R., Clouzeau J., D'Abrosca F., Delveaux C., Derouette J.P., Engelking O., Facchini D., Fröhlicher M., Hofmann M., Hopf N., Molinari J., Oberli A., Ott M., Peter R., Sá-Rocha V.M., Schenk D., Tomicic C., Vanparys P., Verdon B., Wallenhorst T., Winkler G.C. and Depallens O. (2012). Regulatory Assessment of *In Vitro* Skin Corrosion and Irritation Data Within the European Framework: Workshop Recommendations. *Regul.Toxicol.Pharmacol.* 62, 393-403.
- (19) TER SOP (December 2008). *INVITTOX* Protocol (No 115) Rat Skin Transcutaneous Electrical Resistance (TER) Test.
- (20) OECD (2005). Guidance Document on the Validation and International Acceptance of New or Updated Test Methods for Hazard Assessment. Environment, Health and Safety Publications, Series on Testing and Assessment (No 34), Organisation for Economic Cooperation and Development, Paris.

Figure 1

Apparatus for the Rat Skin Ter Assay

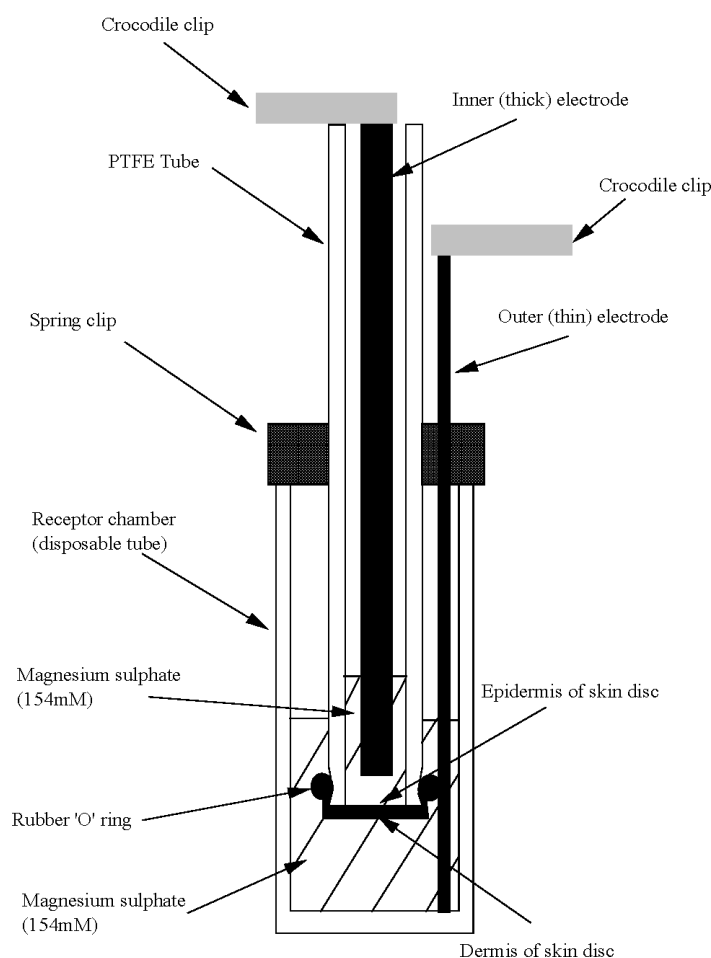

▼ **M8**

Figure 2

Dimensions Of The Polytetrafluoroethylene (PtfE) And Receptor Tubes And Electrodes Used

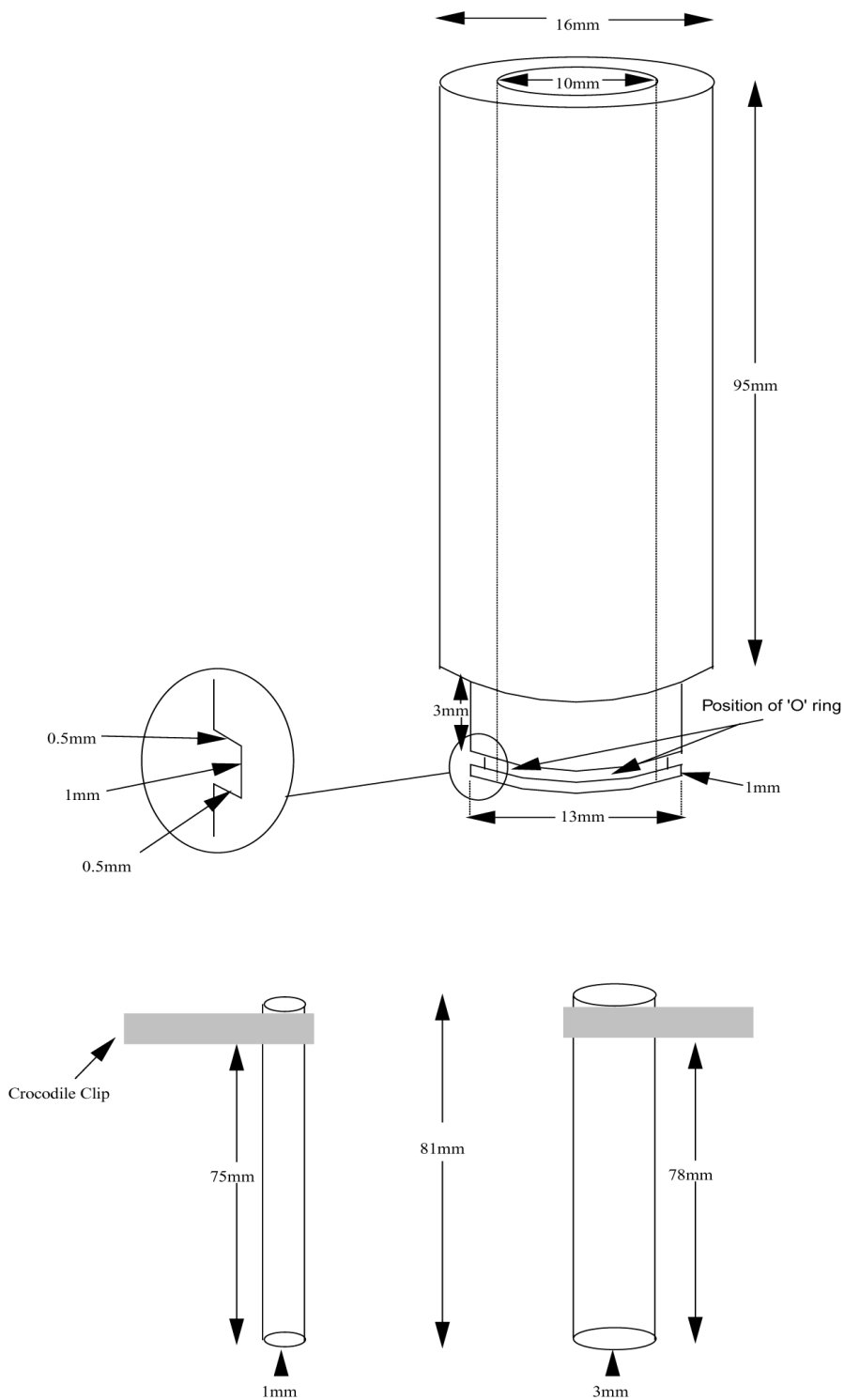

Critical factors of the apparatus shown above:

- The inner diameter of the PTFE tube,
- The length of the electrodes relative to the PTFE tube and receptor tube, such that the skin disc should not be touched by the electrodes and that a standard length of electrode is in contact with the $MgSO_4$ solution,

▼M8

- The amount of MgSO_4 solution in the receptor tube should give a depth of liquid, relative to the level in the PTFE tube, as shown in Figure 1,
- The skin disc should be fixed well enough to the PTFE tube, such that the electrical resistance is a true measure of the skin properties.

▼M8*Appendix*

DEFINITIONS

Accuracy: The closeness of agreement between test method results and accepted reference values. It is a measure of test method performance and one aspect of relevance. The term is often used interchangeably with 'concordance' to mean the proportion of correct outcomes of a test method (20).

C: Corrosive.

Chemical: A substance or a mixture.

Concordance: A measure of test method performance for test methods that give a categorical result, and is one aspect of relevance. The term is sometimes used interchangeably with accuracy, and is defined as the proportion of all chemicals tested that are correctly classified as positive or negative. Concordance is highly dependent on the prevalence of positives in the types of test chemical being examined (20).

GHS (Globally Harmonized System of Classification and Labelling of Chemicals (UN)): A system proposing the classification of chemicals (substances and mixtures) according to standardised types and levels of physical, health and environmental hazards, and addressing corresponding communication elements, such as pictograms, signal words, hazard statements, precautionary statements and safety data sheets, so that to convey information on their adverse effects with a view to protect people (including employers, workers, transporters, consumers and emergency responders) and the environment (1).

IATA: Integrated Approach on Testing and Assessment.

Mixture: A mixture or solution composed of two or more substances.

Mono-constituent substance: A substance, defined by its quantitative composition, in which one main constituent is present to at least 80 % (w/w).

Multi-constituent substance: A substance, defined by its quantitative composition, in which more than one main constituent is present in a concentration ≥ 10 % (w/w) and < 80 % (w/w). A multi-constituent substance is the result of a manufacturing process. The difference between mixture and multi-constituent substance is that a mixture is obtained by blending of two or more substances without chemical reaction. A multi-constituent substance is the result of a chemical reaction.

NC: Non corrosive.

OD: Optical Density.

PC: Positive Control, a replicate containing all components of a test system and treated with a substance known to induce a positive response. To ensure that variability in the positive control response across time can be assessed, the magnitude of the positive response should not be excessive.

▼ M8

Performance standards (PS): Standards, based on a validated test method, that provide a basis for evaluating the comparability of a proposed test method that is mechanistically and functionally similar. Included are; (i) essential test method components; (ii) a minimum list of Reference Chemicals selected from among the chemicals used to demonstrate the acceptable performance of the validated test method; and (iii) the similar levels of reliability and accuracy, based on what was obtained for the validated test method, that the proposed test method should demonstrate when evaluated using the minimum list of Reference Chemicals.

Relevance: Description of relationship of the test method to the effect of interest and whether it is meaningful and useful for a particular purpose. It is the extent to which the test method correctly measures or predicts the biological effect of interest. Relevance incorporates consideration of the accuracy (concordance) of a test method (20).

Reliability: Measures of the extent that a test method can be performed reproducibly within and between laboratories over time, when performed using the same protocol. It is assessed by calculating intra- and inter-laboratory reproducibility (20).

Sensitivity: The proportion of all positive/active chemicals that are correctly classified by the test method. It is a measure of accuracy for a test method that produces categorical results, and is an important consideration in assessing the relevance of a test method (20).

Skin corrosion in vivo: The production of irreversible damage of the skin; namely, visible necrosis through the epidermis and into the dermis, following the application of a test chemical for up to four hours. Corrosive reactions are typified by ulcers, bleeding, bloody scabs, and, by the end of observation at 14 days, by discoloration due to blanching of the skin, complete areas of alopecia, and scars. Histopathology should be considered to evaluate questionable lesions.

Specificity: The proportion of all negative/inactive chemicals that are correctly classified by the test method. It is a measure of accuracy for a test method that produces categorical results and is an important consideration in assessing the relevance of a test method (20).

Substance: A chemical element and its compounds in the natural state or obtained by any production process, including any additive necessary to preserve its stability and any impurities deriving from the process used, but excluding any solvent which may be separated without affecting the stability of the substance or changing its composition.

(Testing) run: A single test chemical concurrently tested in a minimum of three replicate skin discs.

Test chemical: Any substance or mixture tested using this test method.

Transcutaneous Electrical Resistance (TER): is a measure of the electrical impedance of the skin, as a resistance value in kilo Ohms. A simple and robust method of assessing barrier function by recording the passage of ions through the skin using a Wheatstone bridge apparatus.

UVCB: Substances of unknown or variable composition, complex reaction products or biological materials.

▼ M8**B.40bis. IN VITRO SKIN CORROSION: RECONSTRUCTED HUMAN EPIDERMIS (RhE) TEST METHOD**

INTRODUCTION

1. This test method (TM) is equivalent to OECD test guideline (TG) 431 (2016). Skin corrosion refers to the production of irreversible damage to the skin manifested as visible necrosis through the *epidermis* and into the *dermis*, following the application of a test chemical [as defined by the United Nations (UN) Globally Harmonized System of Classification and Labelling of Chemicals (GHS) (1) and the European Union (EU) Regulation 1272/2008 on Classification, Labelling and Packaging of Substances and Mixtures (CLP) (1)]. This updated test method B.40bis provides an *in vitro* procedure allowing the identification of non-corrosive and corrosive substances and mixtures in accordance with UN GHS and CLP. It also allows a partial sub-categorisation of corrosives.
2. The assessment of skin corrosion potential of chemicals has typically involved the use of laboratory animals (TM B.4, equivalent to OECD TG 404; originally adopted in 1981 and revised in 1992, 2002 and 2015) (2). In addition to the present test method B.40bis, two other *in vitro* test methods for testing corrosion potential of chemicals have been validated and adopted as TM B.40 (equivalent to OECD TG 430) (3) and TM B.65 (equivalent to OECD TG 435) (4). Furthermore the *in vitro* TM B.46 (equivalent to OECD TG 439) (5) has been adopted for testing skin irritation potential. A OECD guidance document on Integrated Approaches to Testing and Assessment (IATA) for Skin Corrosion and Irritation describes several modules which group information sources and analysis tools, and provides guidance on (i) how to integrate and use existing testing and non-testing data for the assessment of skin irritation and skin corrosion potentials of chemicals and (ii) proposes an approach when further testing is needed (6).
3. This test method addresses the human health endpoint skin corrosion. It makes use of reconstructed human *epidermis* (RhE) (obtained from human derived non-transformed epidermal keratinocytes) which closely mimics the histological, morphological, biochemical and physiological properties of the upper parts of the human skin, *i.e.* the *epidermis*. The corresponding OECD test guideline was originally adopted in 2004 and updated in 2013 to include additional test methods using the RhE models and the possibility to use the methods to support the sub-categorisation of corrosive chemicals, and updated in 2015 to refer to the IATA guidance document and introduce the use of an alternative procedure to measure viability.
4. Four validated commercially available RhE models are included in this test method. Prevalidation studies (7), followed by a formal validation study for assessing skin corrosion (8)(9)(10) have been conducted (11) (12) for two of these commercially available test models, EpiSkin™ Standard Model (SM) and EpiDerm™ Skin Corrosivity Test (SCT) (EPI-200) (referred to in the following text as the Validated Reference Methods - VRMs). The outcome of these studies led to the recommendation that the two VRMs mentioned

(1) Regulation (EC) No 1272/2008 of the European Parliament and of the Council of 16 December 2008 on classification, labelling and packaging of substances and mixtures, amending and repealing Directives 67/548/EEC and 1999/45/EC, and amending Regulation (EC) No 1907/2006, OJ L 353/1, 31.12.2008

▼ **M8**

above could be used for regulatory purposes for distinguishing corrosive (C) from non-corrosive (NC) substances, and that the EpiSkin™ could moreover be used to support sub-categorisation of corrosive substances (13)(14)(15). Two other commercially available *in vitro* skin corrosion RhE test models have shown similar results to the EpiDerm™ VRM according to PS-based validation (16)(17)(18). These are the SkinEthic™ RHE⁽¹⁾ and epiCS® (previously named EST-1000) that can also be used for regulatory purposes for distinguishing corrosive from noncorrosive substances (19)(20). Post validation studies performed by the RhE model producers in the years 2012 to 2014 with a refined protocol correcting interferences of unspecific MTT reduction by the test chemicals improved the performance of both discrimination of C/NC as well as supporting subcategorisation of corrosives (21)(22). Further statistical analyses of the post-validation data generated with EpiDerm™ SCT, SkinEthic™ RHE and EpiCS® have been performed to identify alternative predictions models that improved the predictive capacity for sub-categorisation (23).

5. Before a proposed similar or modified *in vitro* RhE test method for skin corrosion other than the VRMs can be used for regulatory purposes, its reliability, relevance (accuracy), and limitations for its proposed use should be determined to ensure its similarity to the VRMs, in accordance with the requirements of the Performance Standards (PS) (24) set out in accordance with the principles of OECD guidance document No 34 (25). The Mutual Acceptance of Data will only be guaranteed after any proposed new or updated test method following the PS have been reviewed and included in the corresponding test guideline. The test models included in that test guideline can be used to address countries' requirements for test results on *in vitro* test method for skin corrosion, while benefiting from the Mutual Acceptance of Data.

DEFINITIONS

6. Definitions used are provided in Appendix 1.

INITIAL CONSIDERATIONS

7. This test method allows the identification of non-corrosive and corrosive substances and mixtures in accordance with the UN GHS and CLP. This test method further supports the sub-categorisation of corrosive substances and mixtures into optional sub-category 1A, in accordance with the UN GHS (1), as well as a combination of sub-categories 1B and 1C (21)(22)(23). A limitation of this test method is that it does not allow discriminating between skin corrosive sub-category 1B and sub-category 1C in accordance with the UN GHS and CLP due to the limited set of well-known *in vivo* corrosive sub-category 1C chemicals. EpiSkin™, EpiDerm™ SCT, SkinEthic™ RHE and epiCS® test models are able to sub-categorise (i.e. 1A versus 1B-and-1C versus NC)
8. A wide range of chemicals representing mainly individual substances has been tested in the validation supporting the test models included in this test method when they are used for identification of non-corrosives and corrosives; the empirical database of the validation study amounted to 60 chemicals covering a wide range of chemical classes (8)(9)(10). Testing to demonstrate sensitivity, specificity, accuracy and within-laboratory-reproducibility of the assay for sub-categorisation was performed by the test

⁽¹⁾ The abbreviation RhE (=Reconstructed human Epidermis) is used for all models based on RhE technology. The abbreviation RHE as used in conjunction with the SkinEthic™ model means the same, but, as part of the name of this specific test method as marketed, is spelled all in capitals.

▼ M8

method developers and results were reviewed by the OECD (21) (22) (23). On the basis of the overall data available, the test method is applicable to a wide range of chemical classes and physical states including liquids, semi-solids, solids and waxes. The liquids may be aqueous or non-aqueous; solids may be soluble or insoluble in water. Whenever possible, solids should be ground to a fine powder before application; no other prior treatment of the sample is required. In cases where evidence can be demonstrated on the non-applicability of test models included in this test method to a specific category of test chemicals, they should not be used for that specific category of test chemicals. In addition, this test method is assumed to be applicable to mixtures as an extension of its applicability to substances. However, due to the fact that mixtures cover a wide spectrum of categories and composition, and that only limited information is currently available on the testing of mixtures, in cases where evidence can be demonstrated on the non-applicability of the test method to a specific category of mixtures (*e.g.* following a strategy as proposed in (26)), the test method should not be used for that specific category of mixtures. Before use of the test method on a mixture for generating data for an intended regulatory purpose, it should be considered whether, and if so why, it may provide adequate results for that purpose. Such considerations are not needed, when there is a regulatory requirement for testing of the mixture. Gases and aerosols have not been assessed yet in validation studies (8)(9)(10). While it is conceivable that these can be tested using RhE technology, the current test method does not allow testing of gases and aerosols.

9. Test chemicals absorbing light in the same range as MTT formazan and test chemicals able to directly reduce the vital dye MTT (to MTT formazan) may interfere with the tissue viability measurements and need the use of adapted controls for corrections. The type of adapted controls that may be required will vary depending on the type of interference produced by the test chemical and the procedure used to measure MTT formazan (see paragraphs 25-31).

10. While this test method does not provide adequate information on skin irritation, it should be noted that TM B.46 specifically addresses the health effect skin irritation *in vitro* and is based on the same RhE test system, though using another protocol (5). For a full evaluation of local skin effects after a single dermal exposure, the OECD Guidance Document on Integrated Approaches for Testing and Assessment should be consulted (6). This IATA approach includes the conduct of *in vitro* tests for skin corrosion (such as described in this test method) and skin irritation before considering testing in living animals. It is recognised that the use of human skin is subject to national and international ethical considerations and conditions.

PRINCIPLE OF THE TEST

11. The test chemical is applied topically to a three-dimensional RhE model, comprised of non-transformed, human-derived epidermal keratinocytes, which have been cultured to form a multi-layered, highly differentiated model of the human *epidermis*. It consists of organised basal, spinous and granular layers, and a multi-layered *stratum corneum* containing intercellular lamellar lipid layers representing main lipid classes analogous to those found *in vivo*.

▼M8

12. The RhE test method is based on the premise that corrosive chemicals are able to penetrate the *stratum corneum* by diffusion or erosion, and are cytotoxic to the cells in the underlying layers. Cell viability is measured by enzymatic conversion of the vital dye MTT [3-(4,5-Dimethylthiazol-2-yl)-2,5-diphenyltetrazolium bromide, Thiazolyl blue tetrazolium bromide; CAS number 298-93-1], into a blue formazan salt that is quantitatively measured after extraction from tissues (27). Corrosive chemicals are identified by their ability to decrease cell viability below defined threshold levels (see paragraphs 35 and 36). The RhE-based skin corrosion test method has shown to be predictive of *in vivo* skin corrosion effects assessed in rabbits according to the TM B.4 (2).

DEMONSTRATION OF PROFICIENCY

13. Prior to routine use of any of the four validated RhE test models that adhere to this test method, laboratories should demonstrate technical proficiency by correctly classifying the twelve Proficiency Substances listed in Table 1. In case of the use of a method for sub-classification, also the correct sub-categorisation should be demonstrated. In situations where a listed substance is unavailable or where justifiable, another substance for which adequate *in vivo* and *in vitro* reference data are available may be used (e.g. from the list of reference chemicals (24)) provided that the same selection criteria as described in Table 1 is applied.

Table 1

List of Proficiency Substances (1)

Substance	CASRN	Chemical Class (2)	UN GHS/ CLP Cat. Based on <i>In Vivo</i> results (3)	VRM Cat. Based on <i>In Vitro</i> results (4)	MTT Reducer (5)	Physical State
Sub-category 1A <i>In Vivo</i> Corrosivesg						
Bromoacetic acid	79-08-3	Organic acid	1A	(3) 1A	—	S
Boron trifluoride dihydrate	13319-75-0	Inorganic acid	1A	(3) 1A	—	L
Phenol	108-95-2	Phenol	1A	(3) 1A	—	S
Dichloroacetylchloride	79-36-7	Electrophile	1A	(3) 1A	—	L
Combination of sub-categories 1B-and-1C <i>In Vivo</i> Corrosives						
Glyoxylic acid monohydrate	563-96-2	Organic acid	1B-and-1C	(3) 1B-and-1C	—	S
Lactic acid	598-82-3	Organic acid	1B-and-1C	(3) 1B-and-1C	—	L
Ethanolamine	141-43-5	Organic base	1B	(3) 1B-and-1C	Y	Viscous

▼M8

Substance	CASRN	Chemical Class ⁽²⁾	UN GHS/CLP Cat. Based on <i>In Vivo</i> results ⁽³⁾	VRM Cat. Based on <i>In Vitro</i> results ⁽⁴⁾	MTT Reducer ⁽⁵⁾	Physical State
Sub-category 1A <i>In Vivo</i> Corrosivesg						
Hydrochloric acid (14,4 %)	7647-01-0	Inorganic acid	1B-and-1C	(3) 1B-and-1C	—	L
<i>In Vivo</i> Non Corrosives						
Phenethyl bromide	103-63-9	Electrophile	NC	(3) NC	Y	L
4-Amino-1,2,4-triazole	584-13-4	Organic base	NC	(3) NC	—	S
4-(methylthio)-benzaldehyde	3446-89-7	Electrophile	NC	(3) NC	Y	L
Lauric acid	143-07-7	Organic acid	NC	(3) NC	—	S

Abbreviations: CASRN = Chemical Abstracts Service Registry Number; VRM = Validated Reference Method; NC = Not Corrosive; Y = yes; S = solid; L = liquid

(1) The proficiency substances, sorted first by corrosives versus non-corrosives, then by corrosive sub-category and then by chemical class, were selected from the substances used in the ECVAM validation studies of EpiSkin™ and EpiDerm™ (8) (9) (10) and from post-validation studies based on data provided by EpiSkin™ (22), EpiDerm™, SkinEthic™ and epiCS® developers (23). Unless otherwise indicated, the substances were tested at the purity level obtained when purchased from a commercial source (8) (10). The selection includes, to the extent possible, substances that: (i) are representative of the range of corrosivity responses (e.g. noncorrosives; weak to strong corrosives) that the VRMs are capable of measuring or predicting; (ii) are representative of the chemical classes used in the validation studies; (iii) have chemical structures that are well-defined; (iv) induce reproducible results in the VRM; (v) induce definitive results in the *in vivo* reference test method; (vi) are commercially available; and (vii) are not associated with prohibitive disposal costs.

(2) Chemical class assigned by Barratt *et al.* (8).

(3) The corresponding UN Packing groups are I, II and III, respectively, for the UN GHS/CLP 1A, 1B and 1C.

(4) The VRM *in vitro* predictions reported in this table were obtained with the EpiSkin™ and the EpiDerm™ test models (VRMs) during post-validation testing performed by the test method developers.

(5) The viability values obtained in the ECVAM Skin Corrosion Validation Studies were not corrected for direct MTT reduction (killed controls were not performed in the validation studies). However, the post-validation data generated by the test method developers that are presented in this table were acquired with adapted controls (23).

14. As part of the proficiency exercise, it is recommended that the user verifies the barrier properties of the tissues after receipt as specified by the RhE model manufacturer. This is particularly important if tissues are shipped over long distance/time periods. Once a test method has been successfully established and proficiency in its use has been demonstrated, such verification will not be necessary on a routine basis. However, when using a test method routinely, it is recommended to continue to assess the barrier properties in regular intervals.

PROCEDURE

15. The following is a generic description of the components and procedures of the RhE test models for skin corrosion assessment covered by this test method. The RhE models endorsed as scientifically valid for use within this test method, *i.e.* the EpiSkin™ (SM), EpiDerm™ (EPI-200), SkinEthic™ RHE and epiCS® models (16)(17)(19)(28)(29)(30)(31)(32)(33), can be obtained from commercial sources. Standard Operating Procedures (SOPs) for these four RhE models are available (34)(35)(36)(37), and their

▼ **M8**

main test method components are summarised in Appendix 2. It is recommended that the relevant SOP be consulted when implementing and using one of these models in the laboratory. Testing with the four RhE test models covered by this test method should comply with the following:

RHE TEST METHOD COMPONENTS**General Conditions**

16. Non-transformed human keratinocytes should be used to reconstruct the epithelium. Multiple layers of viable epithelial cells (basal layer, *stratum spinosum*, *stratum granulosum*) should be present under a functional *stratum corneum*. The *stratum corneum* should be multi-layered containing the essential lipid profile to produce a functional barrier with robustness to resist rapid penetration of cytotoxic benchmark chemicals, e.g. sodium dodecyl sulphate (SDS) or Triton X-100. The barrier function should be demonstrated and may be assessed either by determination of the concentration at which a benchmark chemical reduces the viability of the tissues by 50 % (IC₅₀) after a fixed exposure time, or by determination of the exposure time required to reduce cell viability by 50 % (ET₅₀) upon application of the benchmark chemical at a specified, fixed concentration (see paragraph 18). The containment properties of the RhE model should prevent the passage of material around the *stratum corneum* to the viable tissue, which would lead to poor modelling of skin exposure. The RhE model should be free of contamination by bacteria, viruses, mycoplasma, or fungi.

Functional Conditions*Viability*

17. The assay used for quantifying tissue viability is the MTT-assay (27). The viable cells of the RhE tissue construct reduce the vital dye MTT into a blue MTT formazan precipitate, which is then extracted from the tissue using isopropanol (or a similar solvent). The OD of the extraction solvent alone should be sufficiently small, i.e., OD < 0,1. The extracted MTT formazan may be quantified using either a standard absorbance (OD) measurement or an HPLC/UPLC-spectrophotometry procedure (38). The RhE model users should ensure that each batch of the RhE model used meets defined criteria for the negative control. An acceptability range (upper and lower limit) for the negative control OD values should be established by the RhE model developer/supplier. Acceptability ranges for the negative control OD values for the four validated RhE test models included in this test method are given in Table 2. An HPLC/UPLC- Spectrophotometry user should use the negative control OD ranges provided in Table 2 as the acceptance criterion for the negative control. It should be documented that the tissues treated with negative control are stable in culture (provide similar OD measurements) for the duration of the exposure period.

Table 2

Acceptability ranges for negative control OD values to control batch quality

	Lower acceptance limit	Upper acceptance limit
EpiSkin™ (SM)	> 0,6	< 1,5
EpiDerm™ SCT (EPI-200)	> 0,8	< 2,8
SkinEthic™ RHE	> 0,8	< 3,0
epiCS®	> 0,8	< 2,8

▼ **M8***Barrier function*

18. The *stratum corneum* and its lipid composition should be sufficient to resist the rapid penetration of certain cytotoxic benchmark chemicals (*e.g.* SDS or Triton X-100), as estimated by IC_{50} or ET_{50} (Table 3). The barrier function of each batch of the RhE model used should be demonstrated by the RhE model developer/vendor upon supply of the tissues to the end user (see paragraph 21).

Morphology

19. Histological examination of the RhE model should be performed demonstrating multi-layered human *epidermis*-like structure containing *stratum basale*, *stratum spinosum*, *stratum granulosum* and *stratum corneum* and exhibits lipid profile similar to lipid profile of human epidermis. Histological examination of each batch of the RhE model used demonstrating appropriate morphology of the tissues should be provided by the RhE model developer/vendor upon supply of the tissues to the end user (see paragraph 21).

Reproducibility

20. Test method users should demonstrate reproducibility of the test methods over time with the positive and negative controls. Furthermore, the test method should only be used if the RhE model developer/supplier provides data demonstrating reproducibility over time with corrosive and non-corrosive chemicals from *e.g.* the list of Proficiency Substances (Table 1). In case of the use of a test method for subcategorisation, the reproducibility with respect to sub-categorisation should also be demonstrated.

Quality control (QC)

21. The RhE model should only be used if the developer/supplier demonstrates that each batch of the RhE model used meets defined production release criteria, among which those for *viability* (paragraph 17), *barrier function* (paragraph 18) and *morphology* (paragraph 19) are the most relevant. These data are provided to the test method users, so that they are able to include this information in the test report. Only results produced with QC accepted tissue batches can be accepted for reliable prediction of corrosive classification. An acceptability range (upper and lower limit) for the IC_{50} or the ET_{50} is established by the RhE model developer/supplier. The acceptability ranges for the four validated test models are given in Table 3.

Table 3
QC batch release criteria

	Lower acceptance limit	Upper acceptance limit
EpiSkin™ (SM) (18 hours treatment with SDS) (33)	$IC_{50} = 1,0$ mg/ml	$IC_{50} = 3,0$ mg/ml
EpiDerm™ SCT (EPI-200) (1 % Triton X-100) (34)	$ET_{50} = 4,0$ hours	$ET_{50} = 8,7$ hours
SkinEthic™ RHE (1 % Triton X-100) (35)	$ET_{50} = 4,0$ hours	$ET_{50} = 10,0$ hours
epiCS® (1 % Triton X-100) (36)	$ET_{50} = 2,0$ hours	$ET_{50} = 7,0$ hours

▼M8**Application of the Test Chemical and Control Chemicals**

22. At least two tissue replicates should be used for each test chemical and controls for each exposure time. For liquid as well as solid chemicals, sufficient amount of test chemical should be applied to uniformly cover the epidermis surface while avoiding an infinite dose, *i.e.* a minimum of 70 $\mu\text{l}/\text{cm}^2$ or 30 mg/cm^2 should be used. Depending on the models, the epidermis surface should be moistened with deionised or distilled water-before application of solid chemicals, to improve contact between the test chemical and the epidermis surface (34)(35)(36)(37). Whenever possible, solids should be tested as a fine powder. The application method should be appropriate for the test chemical (see *e.g.* references (34-37)). At the end of the exposure period, the test chemical should be carefully washed from the *epidermis* with an aqueous buffer, or 0,9 % NaCl. Depending on which of the four validated RhE test model is used, two or three exposure periods are used per test chemical (for all four valid RhE models: 3 min and 1 hour; for EpiSkin™ an additional exposure time of 4 hours). Depending on the RhE test model used and the exposure period assessed, the incubation temperature during exposure may vary between room temperature and 37°C.
23. Concurrent negative and positive controls (PC) should be used in each run to demonstrate that viability (with negative controls), barrier function and resulting tissue sensitivity (with the PC) of the tissues are within a defined historical acceptance range. The suggested PC chemicals are glacial acetic acid or 8N KOH depending upon the RhE model used. It should be noted that 8N KOH is a direct MTT reducer that might require adapted controls as described in paragraphs 25 and 26. The suggested negative controls are 0,9 % (w/v) NaCl or water.

Cell Viability Measurements

24. The MTT assay, which is a quantitative assay, should be used to measure cell viability under this test method (27). The tissue sample is placed in MTT solution of appropriate concentration (0.3 or 1 mg/ml) for 3 hours. The precipitated blue formazan product is then extracted from the tissue using a solvent (e.g. isopropanol, acidic isopropanol), and the concentration of formazan is measured by determining the OD at 570 nm using a filter band pass of maximum ± 30 nm, or by an HPLC/UPLC- spectrophotometry procedure (see paragraphs 30 and 31)(38).
25. Test chemicals may interfere with the MTT assay, either by direct reduction of the MTT into blue formazan, and/or by colour interference if the test chemical absorbs, naturally or due to treatment procedures, in the same OD range of formazan (570 \pm 30 nm, mainly blue and purple chemicals). Additional controls should be used to detect and correct for a potential interference from these test chemicals such as the non-specific MTT reduction (NSMTT) control and the non-specific colour (NSC) control (see paragraphs 26 to 30). This is especially important when a specific test chemical is not completely removed from the tissue by rinsing or when it penetrates the *epidermis*, and is therefore present in the tissues when the MTT viability test is performed. Detailed description of how to correct direct MTT reduction and interferences by colouring agents is available in the SOPs for the test models (34)(35)(36)(37).

▼ M8

26. To identify direct MTT reducers, each test chemical should be added to freshly prepared MTT medium (34) (35) (36) (37). If the MTT mixture containing the test chemical turns blue/purple, the test chemical is presumed to directly reduce the MTT, and further functional check on non-viable epidermis should be performed, independently of using the standard absorbance (OD) measurement or an HPLC/UPLC-spectrophotometry procedure. This additional functional check employs killed tissues that possess only residual metabolic activity but absorb the test chemical in similar amount as viable tissues. Each MTT reducing chemical is applied on at least two killed tissue replicates per exposure time, which undergo the whole skin corrosion test. The true tissue viability is then calculated as the percent tissue viability obtained with living tissues exposed to the MTT reducer minus the percent non-specific MTT reduction obtained with the killed tissues exposed to the same MTT reducer, calculated relative to the negative control run concurrently to the test being corrected (%NSMTT).
27. To identify potential interference by coloured test chemicals or test chemicals that become coloured when in contact with water or isopropanol and decide on the need for additional controls, spectral analysis of the test chemical in water (environment during exposure) and/or isopropanol (extracting solution) should be performed. If the test chemical in water and/or isopropanol absorbs light in the range of 570 ± 30 nm, further colorant controls should be performed or, alternatively, an HPLC/UPLC-spectrophotometry procedure should be used in which case these controls are not required (see paragraphs 30 and 31). When performing the standard absorbance (OD) measurement, each interfering coloured test chemical is applied on at least two viable tissue replicates per exposure time, which undergo the entire skin corrosion test but are incubated with medium instead of MTT solution during the MTT incubation step to generate a non-specific colour (NSC_{living}) control. The NSC_{living} control needs to be performed concurrently per exposure time per coloured test chemical (in each run) due to the inherent biological variability of living tissues. The true tissue viability is then calculated as the percent tissue viability obtained with living tissues exposed to the interfering test chemical and incubated with MTT solution minus the percent nonspecific colour obtained with living tissues exposed to the interfering test chemical and incubated with medium without MTT, run concurrently to the test being corrected (%NSC_{living}).
28. Test chemicals that are identified as producing both direct MTT reduction (see paragraph 26) and colour interference (see paragraph 27) will also require a third set of controls, apart from the NSMTT and NSC_{living} controls described in the previous paragraphs, when performing the standard absorbance (OD) measurement. This is usually the case with darkly coloured test chemicals interfering with the MTT assay (e.g., blue, purple, black) because their intrinsic colour impedes the assessment of their capacity to directly reduce MTT as described in paragraph 26. These test chemicals may bind to both living and killed tissues and therefore the NSMTT control may not only correct for potential direct MTT reduction by the test chemical, but also for colour interference arising from the binding of the test chemical to killed tissues. This could lead to a double correction for colour interference since the NSC_{living} control already corrects for colour interference arising from the binding of the test chemical to living tissues. To avoid a possible double correction for colour interference, a third control for non-specific colour in killed tissues (NSC_{killed}) needs to be performed. In this additional control, the test chemical is applied on at least two killed tissue replicates per exposure time, which undergo the entire testing procedure but are incubated with medium instead of MTT solution during the MTT incubation step. A single NSC_{killed} control is sufficient per test chemical regardless of the number of independent tests/runs performed, but

▼ M8

should be performed concurrently to the NSMTT control and, where possible, with the same tissue batch. The true tissue viability is then calculated as the percent tissue viability obtained with living tissues exposed to the test chemical minus %NSMTT minus %NSC_{living} plus the percent non-specific colour obtained with killed tissues exposed to the interfering test chemical and incubated with medium without MTT, calculated relative to the negative control run concurrently to the test being corrected (%NSC_{killed}).

29. It is important to note that non-specific MTT reduction and non-specific colour interferences may increase the readouts of the tissue extract above the linearity range of the spectrophotometer. On this basis, each laboratory should determine the linearity range of their spectrophotometer with MTT formazan (CAS # 57360-69-7) from a commercial source before initiating the testing of test chemicals for regulatory purposes. In particular, the standard absorbance (OD) measurement using a spectrophotometer is appropriate to assess direct MTT-reducers and colour interfering test chemicals when the ODs of the tissue extracts obtained with the test chemical without any correction for direct MTT reduction and/or colour interference are within the linear range of the spectrophotometer or when the uncorrected percent viability obtained with the test chemical already defined it as a corrosive (see paragraphs 35 and 36). Nevertheless, results for test chemicals producing %NSMTT and/or %NSC_{living} > 50 % of the negative control should be taken with caution.
30. For coloured test chemicals which are not compatible with the standard absorbance (OD) measurement due to too strong interference with the MTT assay, the alternative HPLC/UPLC- spectrophotometry procedure to measure MTT formazan may be employed (see paragraph 31) (37). The HPLC/UPLC-spectrophotometry system allows for the separation of the MTT formazan from the test chemical before its quantification (38). For this reason, NSC_{living} or NSC_{killed} controls are never required when using HPLC/UPLC-spectrophotometry, independently of the chemical being tested. NSMTT controls should nevertheless be used if the test chemical is suspected to directly reduce MTT or has a colour that impedes the assessment of the capacity to directly reduce MTT (as described in paragraph 26). When using HPLC/UPLC-spectrophotometry to measure MTT formazan, the percent tissue viability is calculated as percent MTT formazan peak area obtained with living tissues exposed to the test chemical relative to the MTT formazan peak obtained with the concurrent negative control. For test chemicals able to directly reduce MTT, true tissue viability is calculated as the percent tissue viability obtained with living tissues exposed to the test chemical minus %NSMTT. Finally, it should be noted that direct MTT-reducers that may also be colour interfering, which are retained in the tissues after treatment and reduce MTT so strongly that they lead to ODs (using standard OD measurement) or peak areas (using UPLC/HPLC- spectrophotometry) of the tested tissue extracts that fall outside of the linearity range of the spectrophotometer cannot be assessed, although these are expected to occur in only very rare situations.

▼ M8

31. HPLC/UPLC-spectrophotometry may be used also with all types of test chemicals (coloured, non-coloured, MTT-reducers and non-MTT reducers) for measurement of MTT formazan (38). Due to the diversity of HPLC/UPLC-spectrophotometry systems, qualification of the HPLC/UPLC-spectrophotometry system should be demonstrated before its use to quantify MTT formazan from tissue extracts by meeting the acceptance criteria for a set of standard qualification parameters based on those described in the U.S. Food and Drug Administration guidance for industry on bio-analytical method validation (38)(39). These key parameters and their acceptance criteria are shown in Appendix 4. Once the acceptance criteria defined in Appendix 4 have been met, the HPLC/UPLC-spectrophotometry system is considered qualified and ready to measure MTT formazan under the experimental conditions described in this test method.

Acceptability Criteria

32. For each test method using valid RhE models, tissues treated with the negative control should exhibit OD reflecting the quality of the tissues as described in table 2 and should not be below historically established boundaries. Tissues treated with the PC, *i.e.* glacial acetic acid or 8N KOH, should reflect the ability of the tissues to respond to a corrosive chemical under the conditions of the test model (see Appendix 2). The variability between tissue replicates of test chemical and/or control chemicals should fall within the accepted limits for each valid RhE model requirements (see Appendix 2) (*e.g.* the difference of viability between the two tissue replicates should not exceed 30 %). If either the negative control or PC included in a run fall out of the accepted ranges, the run is considered as not qualified and should be repeated. If the variability of test chemicals falls outside of the defined range, its testing should be repeated.

Interpretation of Results and Prediction Model

33. The OD values obtained for each test chemical should be used to calculate percentage of viability relative to the negative control, which is set at 100 %. In case HPLC/UPLC-spectrophotometry is used, the percent tissue viability is calculated as percent MTT formazan peak area obtained with living tissues exposed to the test chemical relative to the MTT formazan peak obtained with the concurrent negative control. The cut-off percentage cell viability values distinguishing corrosive from non-corrosive test chemical (or discriminating between different corrosive sub-categories) are defined below in paragraphs 35 and 36 for each of the test models covered by this test method and should be used for interpreting the results.
34. A single testing run composed of at least two tissue replicates should be sufficient for a test chemical when the resulting classification is unequivocal. However, in cases of borderline results, such as non-concordant replicate measurements, a second run may be considered, as well as a third one in case of discordant results between the first two runs.
35. The prediction model for the EpiSkin™ skin corrosion test model (9)(34)(22), associated with the UN GHS/CLP classification system, is shown in Table 4:

▼ **M8**

Table 4

EpiSkin™ prediction model

Viability measured after exposure time points (t=3, 60 and 240 minutes)	Prediction to be considered
< 35 % after 3 min exposure	Corrosive: • Optional sub-category 1A (*)
≥ 35 % after 3 min exposure AND < 35 % after 60 min exposure OR ≥ 35 % after 60 min exposure AND < 35 % after 240 min exposure	Corrosive: • A combination of optional sub-categories 1B- and-1C
≥ 35 % after 240 min exposure	Non-corrosive

(*) According to the data generated in view of assessing the usefulness of the RhE test models for supporting subcategorisation, it was shown that around 22 % of the sub-category 1A results of the EpiSkin™ test model may actually constitute sub-category 1B or sub-category 1C substances/mixtures (i.e. overclassifications) (see Appendix 3).

36. The prediction models for the EpiDerm™ SCT (10)(23)(35), the SkinEthic™ RHE (17)(18) (23) (36), and the epiCS® (16)(23)(37) skin corrosion test models, associated with the UN GHS/CLP classification system, are shown in Table 5:

Table 5

EpiDerm™ SCT, SkinEthic™ RHE and epiCS®

Viability measured after exposure time points (t=3 and 60 minutes)	Prediction to be considered
STEP 1 for EpiDerm™ SCT, for SkinEthic™ RHE and epiCS®	
< 50 % after 3 min exposure	Corrosive
≥ 50 % after 3 min exposure AND < 15 % after 60 min exposure	Corrosive
≥ 50 % after 3 min exposure AND ≥ 15 % after 60 min exposure	Non-corrosive
STEP 2 for EpiDerm™ SCT - for substances/mixtures identified as Corrosive in step 1	
< 25 % after 3 min exposure	Optional sub-category 1A *
≥ 25 % after 3 min exposure	A combination of optional sub-categories 1B and 1C
STEP 2 for SkinEthic™ RHE - for substances/mixtures identified as Corrosive in step 1	
< 18 % after 3 min exposure	Optional sub-category 1A *

▼ **M8**

Viability measured after exposure time points (t=3 and 60 minutes)	Prediction to be considered
STEP 1 for EpiDerm™ SCT, for SkinEthic™ RHE and epiCS®	
≥ 18 % after 3 min exposure	A combination of optional sub-categories 1B and 1C
STEP 2 for epiCS® - for substances/mixtures identified as Corrosive in step 1	
< 15 % after 3 min exposure	Optional sub-category 1A *
≥ 15 % after 3 min exposure	A combination of optional sub-categories 1B and 1C

DATA AND REPORTING**Data**

37. For each test, data from individual tissue replicates (*e.g.* OD values and calculated percentage cell viability for each test chemical, including classification) should be reported in tabular form, including data from repeat experiments as appropriate. In addition, means and ranges of viability and CVs between tissue replicates for each test should be reported. Observed interactions with MTT reagent by direct MTT reducers or coloured test chemicals should be reported for each tested chemical.

Test report

38. The test report should include the following information:

Test Chemical and Control Chemicals:

- Mono-constituent substance: chemical identification, such as IUPAC or CAS name, CAS number, SMILES or InChI code, structural formula, purity, chemical identity of impurities as appropriate and practically feasible, etc;
- Multi-constituent substance, UVCB and mixture: characterised as far as possible by chemical identity (see above), quantitative occurrence and relevant physicochemical properties of the constituents;
- Physical appearance, water solubility, and any additional relevant physicochemical properties;
- Source, lot number if available;
- Treatment of the test chemical/control substance prior to testing, if applicable (*e.g.* warming, grinding);
- Stability of the test chemical, limit date for use, or date for re-analysis if known;
- Storage conditions.

*RhE model and protocol used and rationale for it (if applicable)**Test Conditions:*

- RhE model used (including batch number);

▼ M8

- Calibration information for measuring device (*e.g.* spectrophotometer), wavelength and band pass (if applicable) used for quantifying MTT formazan, and linearity range of measuring device;
- Description of the method used to quantify MTT formazan;
- Description of the qualification of the HPLC/UPLC-spectrophotometry system, if applicable;
- Complete supporting information for the specific RhE model used including its performance. This should include, but is not limited to:
 - i) Viability;
 - ii) Barrier function;
 - iii) Morphology;
 - iv) Reproducibility and predictive capacity;
 - v) Quality controls (QC) of the model;
- Reference to historical data of the model. This should include, but is not limited to acceptability of the QC data with reference to historical batch data;
- Demonstration of proficiency in performing the test method before routine use by testing of the proficiency substances.

Test Procedure:

- Details of the test procedure used (including washing procedures used after exposure period);
- Doses of test chemical and control chemicals used;
- Duration of exposure period(s) and temperature(s) of exposure;
- Indication of controls used for direct MTT-reducers and/or colouring test chemicals, if applicable;
- Number of tissue replicates used per test chemical and controls (PC, negative control, and NSMTT, NSCliving and NSKilled, if applicable), per exposure time;
- Description of decision criteria/prediction model applied based on the RhE model used;
- Description of any modifications of the test procedure (including washing procedures).

Run and Test Acceptance Criteria:

- Positive and negative control mean values and acceptance ranges based on historical data;
- Acceptable variability between tissue replicates for positive and negative controls;

▼M8

- Acceptable variability between tissue replicates for test chemical.

Results:

- Tabulation of data for individual test chemicals and controls, for each exposure period, each run and each replicate measurement including OD or MTT formazan peak area, percent tissue viability, mean percent tissue viability, differences between replicates, SDs and/or CVs if applicable;
- If applicable, results of controls used for direct MTT-reducers and/or colouring test chemicals including OD or MTT formazan peak area, %NSMTT, %NSCliving, %NSCKilled, differences between tissue replicates, SDs and/or CVs (if applicable), and final correct percent tissue viability;
- Results obtained with the test chemical(s) and control chemicals in relation to the defined run and test acceptance criteria;
- Description of other effects observed;
- The derived classification with reference to the prediction model/decision criteria used.

*Discussion of the results**Conclusions***LITERATURE**

- (1) UN (2013). United Nations Globally Harmonized System of Classification and Labelling of Chemicals (GHS). Fifth Revised Edition, UN New York and Geneva. Available at: http://www.unece.org/trans/danger/publi/ghs/ghs_rev05/05files_e.html
- (2) Chapter B.4 of this Annex, Acute Dermal Irritation, Corrosion.
- (3) Chapter B.40 of this Annex, *In Vitro* Skin Corrosion.
- (4) Chapter B.65 of this Annex, *In Vitro* Membrane Barrier Test Method.
- (5) Chapter B.46 of this Annex, *In Vitro* Skin Irritation: Reconstructed Human Epidermis Test Method.
- (6) OECD (2014). Guidance Document on Integrated Approaches to Testing and Assessment of Skin Irritation/Corrosion. Environment, Health and Safety Publications, Series on Testing and Assessment, (No 203) Organisation for Economic Cooperation and Development, Paris.
- (7) Botham P.A., Chamberlain M., Barratt M.D., Curren R.D., Esdaile D.J., Gardner J.R., Gordon V.C., Hildebrand B., Lewis R.W., Liebsch M., Logemann P., Osborne R., Ponc M., Regnier J.F., Steiling W., Walker A.P., and Balls M. (1995). A Prevalidation Study on *In Vitro* Skin Corrosivity Testing. The report and Recommendations of ECVAM Workshop 6. *ATLA* 23:219-255.
- (8) Barratt M.D., Brantom P.G., Fentem J.H., Gerner I., Walker A.P., and Worth A.P. (1998). The ECVAM International Validation Study on *In Vitro* Tests for Skin Corrosivity. 1. Selection and distribution of the Test Chemicals. *Toxicol.In Vitro* 12:471-482.

▼M8

- (9) Fentem J.H., Archer G.E.B., Balls M., Botham P.A., Curren R.D., Earl L.K., Esdaile D.J., Holzhütter H.-G., and Liebsch M. (1998). The ECVAM International Validation Study on *In Vitro* Tests for Skin Corrosivity. 2. Results and Evaluation by the Management Team. *Toxicol.in Vitro* 12:483-524.
- (10) Liebsch M., Traue D., Barrabas C., Spielmann H., Uphill, P., Wilkins S., Wiemann C., Kaufmann T., Remmele M. and Holzhütter H. G. (2000). The ECVAM Prevalidation Study on the Use of EpiDerm for Skin Corrosivity Testing, *ATLA* 28: 371-401.
- (11) Balls M., Blaauboer B.J., Fentem J.H., Bruner L., Combes R.D., Ekwall B., Fielder R.J., Guillouzo A., Lewis R.W., Lovell D.P., Reinhardt C.A., Repetto G., Sladowski D., Spielmann H. et Zucco F. (1995). Practical Aspects of the Validation of Toxicity Test Procedures. The Report and Recommendations of ECVAM Workshops, *ATLA* 23:129-147.
- (12) ICCVAM (Interagency Coordinating Committee on the Validation of Alternative Methods) (1997). Validation and Regulatory Acceptance of Toxicological Test Methods. NIH Publication No 97-3981. National Institute of Environmental Health Sciences, Research Triangle Park, NC, USA.
- (13) ICCVAM (Interagency Coordinating Committee on the Validation of Alternative Methods) (2002). ICCVAM evaluation of EpiDerm™ (EPI-200), EPISKIN™ (SM), and the Rat Skin Transcutaneous Electrical Resistance (TER) Assay: *In Vitro* Test Methods for Assessing Dermal Corrosivity Potential of Chemicals. NIH Publication No 02-4502. National Toxicology Program Interagency Center for the Evaluation of Alternative Toxicological Methods, National Institute of Environmental Health Sciences, Research Triangle Park, NC, USA.
- (14) EC-ECVAM (1998). Statement on the Scientific Validity of the EpiSkin™ Test (an *In Vitro* Test for Skin Corrosivity), Issued by the ECVAM Scientific Advisory Committee (ESAC10), 3 April 1998.
- (15) EC-ECVAM (2000). Statement on the Application of the EpiDerm™ Human Skin Model for Skin Corrosivity Testing, Issued by the ECVAM Scientific Advisory Committee (ESAC14), 21 March 2000.
- (16) Hoffmann J., Heisler E., Karpinski S., Losse J., Thomas D., Siefken W., Ahr H.J., Vohr H.W. and Fuchs H.W. (2005). Epidermal-Skin-Test 1000 (EST-1000)-A New Reconstructed Epidermis for *In Vitro* Skin Corrosivity Testing. *Toxicol.In Vitro* 19: 925-929.
- (17) Kandárová H., Liebsch M., Spielmann,H., Genschow E., Schmidt E., Traue D., Guest R., Whittingham A., Warren N, Gamer A.O., Remmele M., Kaufmann T., Wittmer E., De Wever B., and Rosdy M. (2006). Assessment of the Human Epidermis Model SkinEthic RHE for *In Vitro* Skin Corrosion Testing of Chemicals According to New OECD TG 431. *Toxicol.In Vitro* 20: 547-559.
- (18) Tornier C., Roquet M. and Fraissinette A.B. (2010). Adaptation of the Validated SkinEthic™ Reconstructed Human Epidermis (RHE) Skin Corrosion Test Method to 0,5 cm² Tissue Sample. *Toxicol. In Vitro* 24: 1379-1385.
- (19) EC-ECVAM (2006). Statement on the Application of the SkinEthic™ Human Skin Model for Skin Corrosivity Testing, Issued by the ECVAM Scientific Advisory Committee (ESAC25), 17 November 2006.
- (20) EC-ECVAM (2009). ESAC Statement on the Scientific Validity of an *In-Vitro* Test Method for Skin Corrosivity Testing: the EST-1000, Issued by the ECVAM Scientific Advisory Committee (ESAC30), 12 June 2009.

▼M8

- (21) OECD (2013). Summary Document on the Statistical Performance of Methods in OECD Test Guideline 431 for Sub-categorisation. Environment, Health, and Safety Publications, Series on Testing and Assessment (No 190). Organisation for Economic Cooperation and Development, Paris.
- (22) Alépée N., Grandidier M.H., and Cotovio J. (2014). Sub-Categorisation of Skin Corrosive Chemicals by the EpiSkin™ Reconstructed Human Epidermis Skin Corrosion Test Method According to UN GHS: Revision of OECD Test Guideline 431. *Toxicol. In Vitro* 28:131-145.
- (23) Desprez B., Barroso J., Griesinger C., Kandárová H., Alépée N., and Fuchs, H. (2015). Two Novel Prediction Models Improve Predictions of Skin Corrosive Sub-categories by Test Methods of OECD Test Guideline No 431. *Toxicol. In Vitro* 29:2055-2080.
- (24) OECD (2015). Performance Standards for the Assessment of Proposed Similar or Modified *In Vitro* Reconstructed Human Epidermis (RHE) Test Methods For Skin Corrosion in Relation to OECD TG 431. Environmental Health and Safety Publications, Series on Testing and Assessment (No 219). Organisation for Economic Cooperation and Development, Paris
- (25) OECD (2005). Guidance Document on the Validation and International Acceptance of New or Updated Test Methods for Hazard Assessment. Environment, Health and Safety Publications, Series on Testing and Assessment (No 34), Organisation for Economic Cooperation and Development, Paris.
- (26) Eskes C. *et al.* (2012). Regulatory Assessment of *In Vitro* Skin Corrosion and Irritation Data Within the European Framework: Workshop Recommendations. *Regul.Toxicol.Pharmacol.* 62:393-403.
- (27) Mosmann T. (1983). Rapid Colorimetric Assay for Cellular Growth and Survival: Application to Proliferation and Cytotoxicity Assays. *J. Immunol. Methods* 65:55-63.
- (28) Tinois E., *et al.* (1994). The Episkin Model: Successful Reconstruction of Human *Epidermis In Vitro*. In: *In Vitro Skin Toxicology*. Rougier A., Goldberg A.M and Maibach H.I. (Eds): 133-140.
- (29) Cannon C. L., Neal P.J., Southee J.A., Kubilus J. and Klausner M. (1994). New Epidermal Model for Dermal Irritancy Testing. *Toxicol.in Vitro* 8:889 - 891.
- (30) Ponec M., Boelsma E, Weerheim A, Mulder A, Bouwstra J and Mommaas M. (2000). Lipid and Ultrastructural Characterization of Reconstructed Skin Models. *Inter. J. Pharmaceu.* 203:211 - 225.
- (31) Tinois E., Tillier, J., Gaucherand, M., Dumas, H., Tardy, M. and Thivolet J. (1991). *In Vitro* and Post - Transplantation Differentiation of Human Keratinocytes Grown on the Human Type IV Collagen Film of a Bilayered Dermal Substitute. *Exp. Cell Res.* 193:310-319.
- (32) Parenteau N.L., Bilbo P, Nolte CJ, Mason VS and Rosenberg M. (1992). The Organotypic Culture of Human Skin Keratinocytes and Fibroblasts to Achieve Form and Function. *Cytotech.* 9:163-171.
- (33) Wilkins L.M., Watson SR, Prosky SJ, Meunier SF and Parenteau N.L. (1994). Development of a Bilayered Living Skin Construct for Clinical Applications. *Biotech. Bioeng.* 43/8:747-756.
- (34) EpiSkin™ SOP (December 2011). *INVITTOX* Protocol (No 118). EpiSkin™ Skin Corrosivity Test.
- (35) EpiDerm™ SOP (February 2012). Version MK-24-007-0024 Protocol for: *In Vitro* EpiDerm™ Skin Corrosion Test (EPI-200-SCT), for Use with MatTek Corporation's Reconstructed Human Epidermal Model EpiDerm.

▼M8

- (36) SkinEthic™ RHE SOP (January 2012). *INVITTOX* Protocol SkinEthic™ Skin Corrosivity Test.
- (37) EpiCS® SOP (January 2012). Version 4.1 *In Vitro* Skin Corrosion: Human Skin Model Test Epidermal Skin Test 1000 (epiCS®) Cell-Systems.
- (38) Alépée N., Barroso J., De Smedt A., De Wever B., Hibatallah J., Klaric M., Mewes K.R., Millet M., Pfannenbecker U., Tailhardat M., Templier M., and McNamee P. Use of HPLC/UPLC- spectrophotometry for Detection of MTT Formazan in In Vitro Reconstructed Human Tissue (RhT)- based Test Methods Employing the MTT Assay to Expand their Applicability to Strongly Coloured Test Chemicals. *Toxicol. In Vitro* 29: 741-761.
- (39) US FDA (2001). Guidance for Industry: Bioanalytical Method Validation. U.S. Department of Health and Human Services, Food and Drug Administration. (May 2001). Available at: [<http://www.fda.gov/downloads/Drugs/Guidances/ucm070107.pdf>].

▼ M8*Appendix 1*

DEFINITIONS

Accuracy: The closeness of agreement between test method results and accepted reference values. It is a measure of test method performance and one aspect of relevance. The term is often used interchangeably with 'concordance' to mean the proportion of correct outcomes of a test method (25).

Cell viability: Parameter measuring total activity of a cell population *e.g.* as ability of cellular mitochondrial dehydrogenases to reduce the vital dye MTT (3-(4,5-Dimethylthiazol-2-yl)-2,5- diphenyltetrazolium bromide, Thiazolyl blue), which depending on the endpoint measured and the test design used, correlates with the total number and/or vitality of living cells.

Chemical: A substance or a mixture.

Concordance: This is a measure of test method performance for test methods that give a categorical result, and is one aspect of relevance. The term is sometimes used interchangeably with accuracy, and is defined as the proportion of all chemicals tested that are correctly classified as positive or negative. Concordance is highly dependent on the prevalence of positives in the types of test chemical being examined (25).

ET₅₀: Can be estimated by determination of the exposure time required to reduce cell viability by 50 % upon application of the benchmark chemical at a specified, fixed concentration, see also IC₅₀.

GHS (Globally Harmonized System of Classification and Labelling of Chemicals): A system proposing the classification of chemicals (substances and mixtures) according to standardized types and levels of physical, health and environmental hazards, and addressing corresponding communication elements, such as pictograms, signal words, hazard statements, precautionary statements and safety data sheets, so that to convey information on their adverse effects with a view to protect people (including employers, workers, transporters, consumers and emergency responders) and the environment (1).

HPLC: High Performance Liquid Chromatography.

IATA: Integrated Approach on Testing and Assessment.

IC₅₀: Can be estimated by determination of the concentration at which a benchmark chemical reduces the viability of the tissues by 50 % (IC₅₀) after a fixed exposure time, see also ET₅₀.

Infinite dose: Amount of test chemical applied to the *epidermis* exceeding the amount required to completely and uniformly cover the *epidermis* surface.

Mixture: A mixture or solution composed of two or more substances in which they do not react.

Mono-constituent substance: A substance, defined by its quantitative composition, in which one main constituent is present to at least 80 % (w/w).

▼ M8

MTT: 3-(4,5-Dimethylthiazol-2-yl)-2,5-diphenyltetrazolium bromide; Thiazolyl blue tetrazolium bromide.

Multi-constituent substance: A substance, defined by its quantitative composition, in which more than one main constituent is present in a concentration > 10 % (w/w) and < 80 % (w/w). A multi-constituent substance is the result of a manufacturing process. The difference between mixture and multi-constituent substance is that a mixture is obtained by blending of two or more substances without chemical reaction. A multi-constituent substance is the result of a chemical reaction.

NC: Non corrosive.

NSC_{killed} control: Non-Specific Colour control in killed tissues.

NSC_{living} control: Non-Specific Colour control in living tissues.

NSMTT: Non-Specific MTT reduction.

OD: Optical Density

PC: Positive Control, a replicate containing all components of a test system and treated with a chemical known to induce a positive response. To ensure that variability in the positive control response across time can be assessed, the magnitude of the positive response should not be excessive.

Performance standards (PS): Standards, based on a validated test method, that provide a basis for evaluating the comparability of a proposed test method that is mechanistically and functionally similar. Included are; (i) essential test method components; (ii) a minimum list of Reference Chemicals selected from among the chemicals used to demonstrate the acceptable performance of the validated test method; and (iii) the similar levels of reliability and accuracy, based on what was obtained for the validated test method, that the proposed test method should demonstrate when evaluated using the minimum list of Reference Chemicals (25).

Relevance: Description of relationship of the test method to the effect of interest and whether it is meaningful and useful for a particular purpose. It is the extent to which the test method correctly measures or predicts the biological effect of interest. Relevance incorporates consideration of the accuracy (concordance) of a test method (25).

Reliability: Measures of the extent that a test method can be performed reproducibly within and between laboratories over time, when performed using the same protocol. It is assessed by calculating intra- and inter-laboratory reproducibility (25).

Run: A run consists of one or more test chemicals tested concurrently with a negative control and with a PC.

Sensitivity: The proportion of all positive/active chemicals that are correctly classified by the test method. It is a measure of accuracy for a test method that produces categorical results, and is an important consideration in assessing the relevance of a test method (25).

▼M8

Skin corrosion in vivo: The production of irreversible damage of the skin; namely, visible necrosis through the *epidermis* and into the dermis, following the application of a test chemical for up to four hours. Corrosive reactions are typified by ulcers, bleeding, bloody scabs, and, by the end of observation at 14 days, by discoloration due to blanching of the skin, complete areas of alopecia, and scars. Histopathology should be considered to evaluate questionable lesions.

Specificity: The proportion of all negative/inactive chemicals that are correctly classified by the test method. It is a measure of accuracy for a test method that produces categorical results and is an important consideration in assessing the relevance of a test method (25).

Substance: A chemical element and its compounds in the natural state or obtained by any production process, including any additive necessary to preserve its stability and any impurities deriving from the process used, but excluding any solvent which may be separated without affecting the stability of the substance or changing its composition.

Test chemical: Any substance or mixture tested using this test method.

UPLC: Ultra-High Performance Liquid Chromatography.

UVCB: substances of unknown or variable composition, complex reaction products or biological materials.

MAIN COMPONENTS OF THE RHE TEST MODELS VALIDATED FOR SKIN CORROSION TESTING

Test Model Components	EpiSkin™	EpiDerm™ SCT	SkinEthic™ RHE	epiCS®
Model surface	0,38 cm ²	0,63 cm ²	0,5 cm ²	0,6 cm ²
Number of tissue replicates	At least 2 per exposure time	2-3 per exposure time	At least 2 per exposure time	At least 2 per exposure time
Treatment doses and application	<p>Liquids and viscous: 50 µl ± 3 µl (131.6 µl/cm²)</p> <p>Solids: 20 ± 2 mg (52.6 mg/cm²) + 100 µl ± 5µl NaCl solution (9 g/l)</p> <p>Waxy/sticky: 50 ± 2 mg (131.6 mg/cm²) with a nylon mesh</p>	<p>Liquids: 50 µl (79.4 µl/cm²) with or without a nylon mesh</p> <p><i>Pre-test compatibility of test chemical with nylon mesh</i></p> <p>Semisolids: 50 µl (79.4 µl/cm²)</p> <p>Solids: 25 µl H₂O (or more if necessary) + 25 mg (39.7 mg/cm²)</p> <p>Waxes: flat 'disc like' piece of ca. 8 mm diameter placed atop the tissue wetted with 15 µl H₂O.</p>	<p>Liquids and viscous: 40 µl ± 3µl (80 µl/cm²) using nylon mesh</p> <p><i>Pre-test compatibility of test chemical with nylon mesh</i></p> <p>Solids: 20 µl ± 2µl H₂O + 20 ± 3 mg (40 mg/cm²)</p> <p>Waxy/sticky: 20 ± 3 mg (40 mg/cm²) using nylon mesh</p>	<p>Liquids: 50 µl (83.3 µl/cm²) using nylon mesh</p> <p><i>Pre-test compatibility of test chemical with nylon mesh</i></p> <p>Semisolids: 50 µl (83.3 µl/cm²)</p> <p>Solids: 25 mg (41.7 mg/cm²) + 25 µl H₂O (or more if necessary)</p> <p>Waxy: flat 'cookie like' piece of ca. 8 mm diameter placed atop the tissue wetted with 15 µl H₂O</p>
Pre-check for direct MTT reduction	<p>50 µl (liquid) or 20 mg (solid)+ 2 ml MTT</p> <p>0.3 mg/ml solution for 180 ± 5 min at 37°C, 5 % CO₂, 95 % RH</p> <p>→ if solution turns blue/purple, water-killed adapted controls should be performed</p>	<p>50 µl (liquid) or 25 mg (solid)+ 1 ml MTT</p> <p>1 mg/ml solution for 60 min at 37°C, 5 % CO₂, 95 % RH</p> <p>→ if solution turns blue/purple, freeze-killed adapted controls should be performed</p>	<p>40 µl (liquid) or 20 mg (solid)+ 1 ml MTT</p> <p>1 mg/ml solution for 180± 15 min at 37°C, 5 % CO₂, 95 % RH</p> <p>→ if solution turns blue/purple, freeze-killed adapted controls should be performed</p>	<p>50 µl (liquid) or 25 mg (solid)+ 1 ml MTT</p> <p>1 mg/ml solution for 60 min at 37°C, 5 % CO₂, 95 % RH</p> <p>→ if solution turns blue/purple, freeze-killed adapted controls should be performed</p>

▼ M8

Test Model Components	EpiSkin™	EpiDerm™ SCT	SkinEthic™ RHE	epiCS®
Pre-check for colour interference	10 µl (liquid) or 10 mg (solid) + 90 µl H ₂ O mixed for 15 min at RT → if solution becomes coloured, living adapted controls should be performed	50 µl (liquid) or 25 mg (solid) + 300 µl H ₂ O for 60 min at 37°C, 5 % CO ₂ , 95 % RH → if solution becomes coloured, living adapted controls should be performed	40 µl (liquid) or 20mg (solid) + 300 µl H ₂ O mixed for 60 min at RT → if test chemical is coloured, living adapted controls should be performed	50 µl (liquid) or 25 mg (solid) + 300 µl H ₂ O for 60 min at 37°C, 5 % CO ₂ , 95 % RH → if solution becomes coloured, living adapted controls should be performed
Exposure time and temperature	3 min, 60 min (± 5 min) and 240 min (± 10 min) In ventilated cabinet Room Temperature (RT, 18-28 °C)	3 min at RT, and 60 min at 37 °C, 5 % CO ₂ , 95 % RH	3 min at RT, and 60 min at 37 °C, 5 % CO ₂ , 95 % RH	3 min at RT, and 60 min at 37 °C, 5 % CO ₂ , 95 % RH
Rinsing	25 ml 1x PBS (2 ml/throwing)	20 times with a constant soft stream of 1x PBS	20 times with a constant soft stream of 1x PBS	20 times with a constant soft stream of 1x PBS
Negative control	50 µl NaCl solution (9 g/l) Tested with every exposure time	50 µl H ₂ O Tested with every exposure time	40 µl H ₂ O Tested with every exposure time	50 µl H ₂ O Tested with every exposure time
Positive control	50 µl Glacial acetic acid Tested only for 4 hours	50 µl 8N KOH Tested with every exposure time	40 µl 8N KOH Tested only for 1 hour	50 µl 8N KOH Tested with every exposure time
MTT solution	2 ml 0,3 mg/ml	300 µl 1 mg/ml	300 µl 1 mg/ml	300 µl 1 mg/ml
MTT incubation time and temperature	180 min (± 15 min) at 37°C, 5 % CO ₂ , 95 % RH	180 min at 37°C, 5 % CO ₂ , 95 % RH	180 min (± 15 min) at 37°C, 5 % CO ₂ , 95 % RH	180 min at 37°C, 5 % CO ₂ , 95 % RH

▼ M8

Test Model Components	EpiSkin™	EpiDerm™ SCT	SkinEthic™ RHE	epiCS®
Extraction solvent	500 µl acidified isopropanol (0.04 N HCl in isopropanol) (isolated tissue fully immersed)	2 ml isopropanol (extraction from top and bottom of insert)	1.5 ml isopropanol (extraction from top and bottom of insert)	2 ml isopropanol (extraction from top and bottom of insert)
Extraction time and temperature	Overnight at RT, protected from light	Overnight without shaking at RT or for 120 min with shaking (~120 rpm) at RT	Overnight without shaking at RT or for 120 min with shaking (~120 rpm) at RT	Overnight without shaking at RT or for 120 min with shaking (~120 rpm) at RT
OD reading	570 nm (545 - 595 nm) without reference filter	570 nm (or 540 nm) without reference filter	570 nm (540 - 600 nm) without reference filter	540 - 570 nm without reference filter
Tissue Quality Control	18 hours treatment with SDS 1.0 mg/ml ≤ IC ₅₀ ≤ 3.0 mg/ml	Treatment with 1 % Triton X-100 4.08 hours ≤ ET ₅₀ ≤ 8.7 hours	Treatment with 1 % Triton X-100 4.0 hours ≤ ET ₅₀ ≤ 10.0 hours	Treatment with 1 % Triton X-100 2.0 hours ≤ ET ₅₀ ≤ 7.0 hours
Acceptability Criteria	<ol style="list-style-type: none"> Mean OD of the tissue replicates treated with the negative control (NaCl) should be ≥ 0.6 and ≤ 1.5 for every exposure time Mean viability of the tissue replicates exposed for 4 hours with the positive control (glacial acetic acid), expressed as % of the negative control, should be ≤ 20 % In the range 20-100 % viability and for ODs ≥ 0.3, difference of viability between the two tissue replicates should not exceed 30 %. 	<ol style="list-style-type: none"> Mean OD of the tissue replicates treated with the negative control (H₂O) should be ≥ 0.8 and ≤ 2.8 for every exposure time Mean viability of the tissue replicates exposed for 1 hour with the positive control (8N KOH), expressed as % of the negative control, should be < 15 % In the range 20 - 100 % viability, the Coefficient of Variation (CV) between tissue replicates should be 30 % 	<ol style="list-style-type: none"> Mean OD of the tissue replicates treated with the negative control (H₂O) should be ≥ 0.8 and ≤ 3.0 for every exposure time Mean viability of the tissue replicates exposed for 1 hour (and 4 hours, if applicable) with the positive control (8N KOH), expressed as % of the negative control, should be 15 % In the range 20-100 % viability, and for ODs ≥ 0.3, difference of viability between the two tissue replicates should not exceed 30 % 	<ol style="list-style-type: none"> Mean OD of the tissue replicates treated with the negative control (H₂O) should be ≥ 0.8 and ≤ 2.8 for every exposure time Mean viability of the tissue replicates exposed for 1 hour with the positive control (8N KOH), expressed as % of the negative control, should be 20 % In the range 20-100 % viability, and for ODs ≥ 0.3, difference of viability between the two tissue replicates should not exceed 30 %

▼ **M8***Appendix 3*

PERFORMANCE OF TEST MODELS FOR SUB-CATEGORISATION

The table below provides the performances of the four test models calculated based on a set of 80 chemicals tested by the four test developers. Calculations were performed by the OECD Secretariat, reviewed and agreed by an expert subgroup (21) (23).

EpiSkin™, EpiDerm™, SkinEthic™ and epiCS® test models are able to sub-categorise (i.e. 1A versus 1B-and-1C versus NC)

Performances, overclassification rates, underclassification rates, and accuracy (Predictive capacity) of the four test models based on a set of 80 chemicals all tested over 2 or 3 runs in each test model:

STATISTICS ON PREDICTIONS OBTAINED ON THE ENTIRE SET OF CHEMICALS				
(n= 80 chemicals tested over 2 independent runs for epiCS® or 3 independent runs for EpiDerm™ SCT, EpiSkin™ and SkinEthic™ RHE, i.e. respectively 159 (*) or 240 classifications)				
	EpiSkin™	EpiDerm™	SkinEthic™	epiCS®
Overclassifications:				
1B-and-1C overclassified 1A	21,50 %	29,0 %	31,2 %	32,8 %
NC overclassified 1B-and-1C	20,7 %	23,4 %	27,0 %	28,4 %
NC overclassified 1A	0,00 %	2,7 %	0,0 %	0,00 %
overclassified Corr.	20,7 %	26,1 %	27,0 %	28,4 %
Global overclassification rate (all categories)	17,9 %	23,3 %	24,5 %	25,8 %
Underclassifications:				
1A underclassified 1B-and-1C	16,7 %	16,7 %	16,7 %	12,5 %
1A underclassified NC	0,00 %	0,00 %	0,00 %	0,00 %
1B-and-1C underclassified NC	2,2 %	0,00 %	7,5 %	6,6 %
Global underclassification rate (all categories)	3,3 %	2,5 %	5,4 %	4,4 %
Correct Classifications:				
1A correctly classified	83,3 %	83,3 %	83,3 %	87,5 %
1B-and-/1C correctly classified	76,3 %	71,0 %	61,3 %	60,7 %
NC correctly classified	79,3 %	73,9 %	73,0 %	71,62 %
Overall Accuracy	78,8 %	74,2 %	70 %	69,8 %

NC: Non-corrosive

(*) one chemical was tested once in epiCS® because of no availability (23)

▼ **M8***Appendix 4*

Key parameters and acceptance criteria for qualification of an HPLC/UPLC-spectrophotometry system for measurement of MTT formazan extracted from RhE tissue

Parameter	Protocol Derived from FDA Guidance (37)(38)	Acceptance Criteria
Selectivity	Analysis of isopropanol, living blank (isopropanol extract from living RhE tissues without any treatment), dead blank (isopropanol extract from killed RhE tissues without any treatment)	$\text{Area}_{\text{interference}} \leq 20 \% \text{ of } \text{Area}_{\text{LLOQ}}^{(1)}$
Precision	Quality Controls (i.e., MTT formazan at 1,6 µg/ml, 16 µg/ml and 160 µg/ml) in isopropanol (n=5)	$\text{CV} \leq 15 \% \text{ or } \leq 20 \% \text{ for the LLOQ}$
Accuracy	Quality Controls in isopropanol (n=5)	$\% \text{Dev} \leq 15 \% \text{ or } \leq 20 \% \text{ for LLOQ}$
Matrix Effect	Quality Controls in living blank (n=5)	$85 \% \leq \text{Matrix Effect } \% \leq 115 \%$
Carryover	Analysis of isopropanol after an ULOQ ⁽²⁾ standard	$\text{Area}_{\text{interference}} \leq 20 \% \text{ of } \text{Area}_{\text{LLOQ}}$
Reproducibility (intra-day)	3 independent calibration curves (based on 6 consecutive 1/3 dilutions of MTT formazan in isopropanol starting at ULOQ, i.e., 200 µg/ml); Quality Controls in isopropanol (n=5)	Calibration Curves: $\% \text{Dev} \leq 15 \% \text{ or } \leq 20 \% \text{ for LLOQ}$ Quality Controls: $\% \text{Dev} \leq 15 \% \text{ and } \text{CV} \leq 15 \%$
Reproducibility (inter-day)	Day 1: 1 calibration curve and Quality Controls in isopropanol (n=3) Day 2: 1 calibration curve and Quality Controls in isopropanol (n=3) Day 3: 1 calibration curve and Quality Controls in isopropanol (n=3)	
Short Term Stability of MTT Formazan in RhE Tissue Extract	Quality Controls in living blank (n=3) analysed the day of the preparation and after 24 hours of storage at room temperature	$\% \text{Dev} \leq 15 \%$
Long Term Stability of MTT Formazan in RhE Tissue Extract, if required	Quality Controls in living blank (n=3) analysed the day of the preparation and after several days of storage at a specified temperature (e.g., 4 °C, -20 °C, -80 °C)	$\% \text{Dev} \leq 15 \%$

⁽¹⁾ LLOQ: Lower Limit of Quantification, defined to cover 1-2 % tissue viability, i.e., 0,8 µg/ml.

⁽²⁾ ULOQ: Upper Limit of Quantification, defined to be at least two times higher than the highest expected MTT formazan concentration in isopropanol extracts from negative controls i.e., 200 µg/ml.

▼ B**B.41. IN VITRO 3T3 NRU PHOTOTOXICITY TEST****1. METHOD**

This method is equivalent to OECD TG 432 (2004).

1.1. INTRODUCTION

Phototoxicity is defined as a toxic response from a substance applied to the body which is either elicited or increased (apparent at lower dose levels) after subsequent exposure to light, or that is induced by skin irradiation after systemic administration of a substance.

The *in vitro* 3T3 NRU phototoxicity test is used to identify the phototoxic potential of a test substance induced by the excited chemical after exposure to light. The test evaluates photo-cytotoxicity by the relative reduction in viability of cells exposed to the chemical in the presence versus absence of light. Substances identified by this test are likely to be phototoxic *in vivo* following systemic application and distribution to the skin, or after topical application.

Many types of chemicals have been reported to induce phototoxic effects (1)(2)(3)(4). Their common feature is their ability to absorb light energy within the sunlight range. According to the first law of photochemistry (Grotthaus-Draper Law), photoreaction requires sufficient absorption of light quanta. Thus, before biological testing is considered, a UV/vis absorption spectrum of the test chemical must be determined according to OECD Test Guideline 101. It has been suggested that if the molar extinction/absorption coefficient is less than $10 \text{ litre} \times \text{mol}^{-1} \times \text{cm}^{-1}$ the chemical is unlikely to be photoreactive. Such chemical may not need to be tested in the *in vitro* 3T3 NRU phototoxicity test or any other biological test for adverse photochemical effects (1)(5). See also Appendix 1.

The reliability and relevance of the *in vitro* 3T3 NRU phototoxicity test was recently evaluated (6)(7)(8) (9). The *in vitro* 3T3 NRU phototoxicity test was shown to be predictive of acute phototoxicity effects in animals and humans *in vivo*. The test is not designed to predict other adverse effects that may arise from combined action of a chemical and light, e.g. it does not address photogenotoxicity, photoallergy, or photocarcinogenicity, nor does it allow an assessment of phototoxic potency. In addition, the test has not been designed to address indirect mechanisms of phototoxicity, effects of metabolites of the test substance, or effects of mixtures.

Whereas the use of metabolising systems is a general requirement for all *in vitro* tests for the prediction of genotoxic and carcinogenic potential, up to now, in the case of phototoxicology, there are only rare examples where metabolic transformation is needed for the chemical to act as a phototoxin *in vivo* or *in vitro*. Thus, it is neither considered necessary nor scientifically justified for the present test to be performed with a metabolic activation system.

▼ B

1.2. DEFINITIONS

Irradiance: the intensity of ultraviolet (UV) or visible light incident on a surface, measured in W/m^2 or mW/cm^2 .

Dose of light: the quantity (= intensity \times time) of ultraviolet (UV) or visible radiation incident on a surface, expressed in Joules (= $W \times s$) per surface area, e.g. J/m^2 or J/cm^2 .

UV light wavebands: the designations recommended by the CIE (Commission Internationale de L'Eclairage) are: UVA (315-400 nm), UVB (280-315 nm) and UVC (100-280 nm). Other designations are also used; the division between UVB and UVA is often placed at 320 nm, and the UVA may be divided into UV-A1 and UV-A2 with a division made at about 340 nm.

Cell viability: parameter measuring total activity of a cell population (e.g. uptake of the vital dye Neutral Red into cellular lysosomes), which, depending on the endpoint measured and the test design used, correlates with the total number and/or vitality of the cells.

Relative cell viability: cell viability expressed in relation of solvent (negative) controls which have been taken through the whole test procedure (either +Irr or -Irr) but not treated with test chemical.

PIF (Photo-Irritation-Factor): factor generated by comparing two equally effective cytotoxic concentrations (IC_{50}) of the test chemical obtained in the absence (-Irr) and in the presence (+Irr) of a non-cytotoxic irradiation with UVA/vis light.

IC_{50} : the concentration of the test chemical by which the cell viability is reduced by 50 %.

MPE (Mean-Photo-Effect): measurement derived from mathematical analysis of the concentration response curves obtained in the absence (-Irr) and in the presence (+Irr) of a non-cytotoxic irradiation with UVA/vis light.

Phototoxicity: acute toxic response that is elicited after the first exposure of skin to certain chemicals and subsequent exposure to light, or that is induced similarly by skin irradiation after systemic administration of a chemical.

1.3. PRINCIPLE OF THE TEST METHOD

The *in vitro* 3T3 NRU phototoxicity test is based on a comparison of the cytotoxicity of a chemical when tested in the presence and in the absence of exposure to a non-cytotoxic dose of simulated solar light. Cytotoxicity in this test is expressed as a concentration-dependent reduction of the uptake of the vital dye Neutral Red when measured 24 hours after treatment with the test chemical and irradiation (10). NR is a weak cationic dye that readily penetrates cell membranes by non-diffusion, accumulating intracellularly in lysosomes. Alterations of the surface of the sensitive lysosomal membrane lead to lysosomal fragility and other changes that gradually become irreversible. Such changes brought about by the action of xenobiotics result in a decreased uptake and binding of NR. It is thus possible to distinguish between viable, damaged or dead cells, which is the basis of this test.

▼ B

Balb/c 3T3 cells are maintained in culture for 24 h for formation of monolayers. Two 96-well plates per test chemical are pre-incubated with eight different concentrations of the test substance for 1 h. Thereafter one of the two plates is exposed to the highest non-cytotoxic irradiation dose whereas the other plate is kept in the dark. In both plates the treatment medium is then replaced by culture medium and after another 24 h of incubation cell viability is determined by Neutral Red uptake. Cell viability is expressed as percentage of untreated solvent controls and is calculated for each test concentration. To predict the phototoxic potential, the concentration responses obtained in the presence and in the absence of irradiation are compared, usually at the IC₅₀ level, i.e., the concentration reducing cell viability to 50 % compared to the untreated controls.

1.4. DESCRIPTION OF THE TEST METHOD

1.4.1. Preparations

1.4.1.1. Cells

A permanent mouse fibroblast cell line, Balb/c 3T3, clone 31, either from the American Type Culture Collection (ATCC), Manassas, VA, USA, or from the European Collection of Cell Cultures (ECACC), Salisbury, Wiltshire, UK, was used in the validation study, and therefore is recommended to obtain from a well qualified cell depository. Other cells or cell lines may be used with the same test procedure if culture conditions are adapted to the specific needs of the cells, but equivalency must be demonstrated.

Cells should be checked regularly for the absence of mycoplasma contamination and only used if none is found (11).

It is important that UV sensitivity of the cells is checked regularly according to the quality control procedure described in this method. Because the UVA sensitivity of cells may increase with the number of passages, Balb/c 3T3 cells of the lowest obtainable passage number, preferably less than 100, should be used. (See Section 1.4.2.2.2 and Appendix 2).

1.4.1.2. Media and culture conditions

Appropriate culture media and incubation conditions should be used for routine cell passage and during the test procedure, e.g. for Balb/c 3T3 cells these are DMEM (Dulbecco's Modified Eagle's Medium) supplemented with 10 % new-born calf serum, 4 mM glutamine, penicillin (100 IU), and streptomycin (100 µg/mL), and humidified incubation at 37 °C, 5-7,5 % CO₂ depending on the buffer (See Section 1.4.1.4, second paragraph.). It is particularly important that cell culture conditions assure a cell cycle time within the normal historical range of the cells or cell line used.

1.4.1.3. Preparation of cultures

Cells from frozen stock cultures are seeded in culture medium at an appropriate density and subcultured at least once before they are used in the *in vitro* 3T3 NRU phototoxicity test.

▼ B

Cells used for the phototoxicity test are seeded in culture medium at the appropriate density so that cultures will not reach confluence by the end of the test, i.e., when cell viability is determined 48 h after seeding of the cells. For Balb/c 3T3 cells grown in 96-well plates, the recommended cell seeding density is 1×10^4 cells per well.

For each test chemical cells are seeded identically in two separate 96-well plates, which are then taken concurrently through the entire test procedure under identical culture conditions except for the time period where one of the plates is irradiated (+Irr) and the other one is kept in the dark (-Irr).

1.4.1.4. Preparation of test substance

Test substances must be prepared fresh, immediately prior to use unless data demonstrate their stability in storage. It is recommended that all chemical handling and the initial treatment of cells be performed under light conditions that would avoid photoactivation or degradation of the test substance prior to irradiation.

Test chemicals shall be dissolved in buffered salt solutions, e.g. Earle's Balanced Salt Solution (EBSS), or other physiologically balanced buffer solutions, which must be free from protein components, light absorbing components (e.g. pH-indicator colours and vitamins) to avoid interference during irradiation. Since during irradiation cells are kept for about 50 minutes outside of the CO₂ incubator, care has to be taken to avoid alkalinisation. If weak buffers like EBSS are used this can be achieved by incubating the cells at 7,5 % CO₂. If the cells are incubated at 5 % CO₂ only, a stronger buffer should be selected.

Test chemicals of limited solubility in water should be dissolved in an appropriate solvent. If a solvent is used it must be present at a constant volume in all cultures, i.e. in the negative (solvent) controls as well as in all concentrations of the test chemical, and be noncytotoxic at that concentration. Test chemical concentrations should be selected so as to avoid precipitate or cloudy solutions.

Dimethylsulphoxide (DMSO) and ethanol (ETOH) are the recommended solvents. Other solvents of low cytotoxicity may be appropriate. Prior to use, all solvents should be assessed for specific properties, e.g. reaction with the test chemical, quenching of the phototoxic effect, radical scavenging properties and/or chemical stability in the solvent.

Vortex mixing and/or sonication and/or warming to appropriate temperatures may be used to aid solubilisation unless this would affect the stability of the test chemical.

▼ B1.4.1.5. *Irradiation conditions*

1.4.1.5.1. Light source

The choice of an appropriate light source and filters is a crucial factor in phototoxicity testing. Light of the UVA and visible regions is usually associated with phototoxic reactions *in vivo* (3)(12), whereas generally UVB is of less relevance but is highly cytotoxic; the cytotoxicity increases 1 000-fold as the wavelength goes from 313 to 280 nm (13). Criteria for the choice of an appropriate light source must include the requirement that the light source emits wavelengths absorbed by the test chemical (absorption spectrum) and that the dose of light (achievable in a reasonable exposure time) should be sufficient for the detection of known photocytotoxic chemicals. Furthermore, the wavelengths and doses employed should not be unduly deleterious to the test system, e.g. the emission of heat (infrared region).

Simulation of sunlight with solar simulators is considered the optimal artificial light source. The irradiation power distribution of the filtered solar simulator should be close to that of outdoor daylight given in (14). Both, Xenon arcs and (doped) mercury-metal halide arcs are used as solar simulators (15). The latter has the advantage of emitting less heat and being cheaper, but the match to sunlight is less perfect compared to that of xenon arcs. Because all solar simulators emit significant quantities of UVB they should be suitably filtered to attenuate the highly cytotoxic UVB wavelengths. Because cell culture plastic materials contain UV stabilisers the spectrum should be measured through the same type of 96-well plate lid as will be used in the assay. Irrespective of measures taken to attenuate parts of the spectrum by filtering or by unavoidable filter effects of the equipment the spectrum recorded below these filters should not deviate from standardised outdoor daylight (14). An example of the spectral irradiance distribution of the filtered solar simulator used in the validation study of the *in vitro* 3T3 NRU phototoxicity test is given in (8)(16). See also Appendix 2 Figure 1.

1.4.1.5.2. Dosimetry

The intensity of light (irradiance) should be regularly checked before each phototoxicity test using a suitable broadband UV-meter. The intensity should be measured through the same type of 96-well plate lid as will be used in the assay. The UV-meter must have been calibrated to the source. The performance of the UV-meter should be checked, and for this purpose the use of a second, reference UV-meter of the same type and identical calibration is recommended. Ideally, at greater intervals, a spectroradiometer should be used to measure the spectral irradiance of the filtered light source and to check the calibration of the broadband UV-meter.

A dose of 5 J/cm² (as measured in the UVA range) was determined to be non-cytotoxic to Balb/c 3T3 cells and sufficiently potent to excite chemicals to elicit phototoxic reactions, (6) (17) e.g. to achieve 5 J/cm² within a time period of 50 min, irradiance was adjusted to 1,7 mW/cm². See Appendix 2 Figure 2. If another cell line or a different light source are used, the irradiation dose may have to be calibrated so that a dose regimen can be selected that is not deleterious to the cells but sufficient to excite standard phototoxins. The time of light exposure is calculated in the following way:

▼ B

$$t(\text{min}) = \frac{\text{irradiation dose } (J/cm^2) \times 1000}{\text{irradiance } (mW/cm^2) \times 60} \quad (1 \text{ J} = 1 \text{ Wsec})$$

1.4.2. **Test conditions**1.4.2.1. *Test substance concentrations*

The ranges of concentrations of a chemical tested in the presence (+Irr) and in the absence (-Irr) of light should be adequately determined in dose range-finding experiments. It may be useful to assess solubility initially and at 60 min (or whatever treatment time is to be used), as solubility can change during time or during the course of exposure. To avoid toxicity induced by improper culture conditions or by highly acidic or alkaline chemicals, the pH of the cell cultures with added test chemical should be in the range 6,5 - 7,8.

The highest concentration of the test substance should be within physiological test conditions, e.g. osmotic and pH stress should be avoided. Depending on the test chemical, it may be necessary to consider other physico-chemical properties as factors limiting the highest test concentration. For relatively insoluble substances that are not toxic at concentrations up to the saturation point the highest achievable concentration should be tested. In general, precipitation of the test chemical at any of the test concentrations should be avoided. The maximum concentration of a test substance should not exceed 1 000 µg/mL; osmolarity should not exceed 10 mmolar. A geometric dilution series of eight test substance concentrations with a constant dilution factor should be used (See Section 2.1, second paragraph).

If there is information (from a range finding experiment) that the test chemical is not cytotoxic up to the limit concentration in the dark experiment (-Irr), but is highly cytotoxic when irradiated (+Irr), the concentration ranges to be selected for the (+Irr) experiment may differ from those selected for the (-Irr) experiment to fulfill the requirement of adequate data quality.

1.4.2.2. *Controls*

1.4.2.2.1. Radiation sensitivity of the cells, establishing of historical data:

Cells should be checked regularly (about every fifth passage) for sensitivity to the light source by assessing their viability following exposure to increasing doses of irradiation. Several doses of irradiation, including levels substantially greater than those used for the 3T3 NRU Phototoxicity test should be used in this assessment. These doses are easiest quantitated by measurements of UV parts of the light source. Cells are seeded at the density used in the *in vitro* 3T3 NRU phototoxicity test and irradiated the next day. Cell viability is then determined one day later using Neutral Red uptake. It should be demonstrated that the resulting highest non-cytotoxic dose (e.g. in the validation study: 5 J/cm² [UVA]) was sufficient to classify the reference chemicals (Table 1) correctly.

▼B

1.4.2.2.2. Radiation sensitivity, check of current test:

The test meets the quality criteria if the irradiated negative/solvent controls show a viability of more than 80 % when compared with non-irradiated negative/solvent.

1.4.2.2.3. Viability of solvent controls:

The absolute optical density ($OD_{540 \text{ NRU}}$) of the Neutral Red extracted from the solvent controls indicates whether the 1×10^4 cells seeded per well have grown with a normal doubling time during the two days of the assay. A test meets the acceptance criteria if the mean $OD_{540 \text{ NRU}}$ of the untreated controls is $\geq 0,4$ (i.e. approximately 20 times the background solvent absorbance).

1.4.2.2.4. Positive control:

A known phototoxic chemical shall be tested concurrently with each *in vitro* 3T3 NRU phototoxicity test. Chlorpromazine (CPZ) is recommended. For CPZ tested with the standard protocol in the *in vitro* 3T3 NRU phototoxicity test, the following test acceptance criteria were defined: CPZ irradiated (+Irr): $IC_{50} = 0,1$ to $2,0 \mu\text{g/ml}$, CPZ non-irradiated (-Irr): $IC_{50} = 7,0$ to $90,0 \mu\text{g/mL}$. The Photo Irritation Factor (PIF), should be > 6 . The historical performance of the positive control should be monitored.

Other phototoxic chemicals, suitable for the chemical class or solubility characteristics of the chemical being evaluated, may be used as the concurrent positive controls in place of chlorpromazine.

1.4.3. **Test procedure (6)(7)(8)(16)(17):**1.4.3.1. *1st day:*

Dispense $100 \mu\text{L}$ culture medium into the peripheral wells of a 96-well tissue culture microtiter plate (= blanks). In the remaining wells, dispense $100 \mu\text{L}$ of a cell suspension of 1×10^5 cells/mL in culture medium (= 1×10^4 cells/well). Two plates should be prepared for each series of individual test substance concentrations, and for the solvent and positive controls.

Incubate cells for 24 h (See Section 1.4.1.2) until they form a half confluent monolayer. This incubation period allows for cell recovery, adherence, and exponential growth.

1.4.3.2. *2nd day:*

After incubation, decant culture medium from the cells and wash carefully with $150 \mu\text{L}$ of the buffered solution used for incubation. Add $100 \mu\text{L}$ of the buffer containing the appropriate concentration of test chemical or solvent (solvent control). Apply eight different concentrations of the test chemical. Incubate cells with the test substance in the dark for 60 minutes (See Section 1.4.1.2 and 1.4.1.4 second paragraph).

From the two plates prepared for each series of test substance concentrations and the controls, one is selected, generally at random, for the determination of cytotoxicity (-Irr) (i.e., the control plate), and one (the treatment plate) for the determination of photocytotoxicity (+Irr).

▼ B

To perform the +Irr exposure, irradiate the cells at room temperature for 50 minutes through the lid of the 96-well plate with the highest dose of radiation that is non-cytotoxic (see also Appendix 2). Keep non-irradiated plates (-Irr) at room temperature in a dark box for 50 min (= light exposure time).

Decant test solution and carefully wash twice with 150 µL of the buffered solution used for incubation, but not containing the test material. Replace the buffer with culture medium and incubate (See Section 1.4.1.2.) overnight (18-22 h).

1.4.3.3. *3rd day:*

1.4.3.3.1. **Microscopic evaluation**

Cells should be examined for growth, morphology, and integrity of the monolayer using a phase contrast microscope. Changes in cell morphology and effects on cell growth should be recorded.

1.4.3.3.2. **Neutral Red uptake test**

Wash the cells with 150 µL of the pre-warmed buffer. Remove the washing solution by gentle tapping. Add 100 µL of a 50 µg/mL Neutral Red (NR) (3-amino-7-dimethylamino-2-methylphenazine hydrochloride, EINECS number 209-035-8; CAS number 553-24-2; C.I. 50040) in medium without serum (16) and incubate as described in paragraph 1.4.1.2., for 3 h. After incubation, remove the NR medium, and wash cells with 150 µL of the buffer. Decant and remove excess buffer by blotting or centrifugation.

Add exactly 150 µL NR desorb solution (freshly prepared 49 parts water + 50 parts ethanol + 1 part acetic acid).

Shake the microtiter plate gently on a microtiter plate shaker for 10 min until NR has been extracted from the cells and has formed a homogeneous solution.

Measure the optical density of the NR extract at 540 nm in a spectrophotometer, using blanks as a reference. Save data in an appropriate electronic file format for subsequent analysis.

2. **DATA**

2.1. **QUALITY AND QUANTITY OF DATA**

The test data should allow a meaningful analysis of the concentration-response obtained in the presence and in the absence of irradiation, and if possible the concentration of test chemical by which cell viability is reduced to 50 % (IC₅₀). If cytotoxicity is found, both the concentration range and the intercept of individual concentrations shall be set in a way to allow the fit of a curve to the experimental data.

For both clearly positive and clearly negative results (See Section 2.3, first paragraph), the primary experiment, supported by one or more preliminary dose range-finding experiment(s), may be sufficient.

▼ B

Equivocal, borderline, or unclear results should be clarified by further testing (see also section 2.4, second paragraph). In such cases, modification of experimental conditions should be considered. Experimental conditions that might be modified include the concentration range or spacing, the pre-incubation time, and the irradiation-exposure time. A shorter exposure time may be appropriate for water-unstable chemicals.

2.2. EVALUATION OF RESULTS

To enable evaluation of the data, a Photo-Irritation-Factor (PIF) or Mean Photo Effect (MPE) may be calculated.

For the calculation of the measures of photocytotoxicity (see below) the set of discrete concentration-response values has to be approximated by an appropriate continuous concentration-response curve (model). Fitting of the curve to the data is commonly performed by a non-linear regression method (18). To assess the influence of data variability on the fitted curve a bootstrap procedure is recommended.

A Photo-Irritation-Factor (PIF) is calculated using the following formula:

$$\text{PIF} = \frac{\text{IC}_{50}(-\text{Irr})}{\text{IC}_{50}(+\text{Irr})}$$

If an IC_{50} in the presence or absence of light cannot be calculated, a PIF cannot be determined for the test material. The mean photo effect (MPE) is based on comparison of the complete concentration-response curves (19). It is defined as the weighted average across a representative set of photo effect values

$$\text{MPE} = \frac{\sum_{i=1}^n w_i \text{PE}_{C_i}}{\sum_{i=1}^n w_i}$$

The photo effect PE_C at any concentration C is defined as the product of the response effect RE_C and the dose effect DE_C i.e. $\text{PE}_C = \text{RE}_C \times \text{DE}_C$. The response effect RE_C is the difference between the responses observed in the absence and presence of light, i.e. $\text{RE}_C = R_C(-\text{Irr}) - R_C(+\text{Irr})$. The dose-effect is given by

$$\text{DE}_C = \left| \frac{C/C^* - 1}{C/C^* + 1} \right|$$

where C^* represents the equivalence concentration, i.e. the concentration at which the +Irr response equals the -Irr response at concentration C . If C^* cannot be determined because the response values of the +Irr curve are systematically higher or lower than $R_C(-\text{Irr})$ the dose effect is set to 1. The weighting factors w_i are given by the highest response value, i.e. $w_i = \text{MAX} \{R_i(+\text{Irr}), R_i(-\text{Irr})\}$. The concentration grid C_i is chosen such that the same number of points falls into each of the concentration intervals defined by the concentration values used in the experiment. The calculation of MPE is restricted to the maximum concentration value at which at least one of the two curves still exhibits a response value of at least 10 %. If this maximum concentration is higher than the highest concentration used in the +Irr experiment the residual part of the +Irr curve is set to the response value '0'. Depending on whether the MPE value is larger than a properly chosen cut-off value ($\text{MPE}_C = 0,15$) or not, the chemical is classified as phototoxic.

▼B

A software package for the calculation of the PIF and MPE is available from (20).

2.3. INTERPRETATION OF RESULTS

Based on the validation study (8), a test substance with a PIF < 2 or an MPE < 0,1 predicts: 'no phototoxicity'. A PIF > 2 and < 5 or an MPE > 0,1 and < 0,15 predicts: 'probable phototoxicity'; and a PIF > 5 or an MPE > 0,15 predicts: 'phototoxicity'.

For any laboratory initially establishing this assay, the reference materials listed in Table 1 should be tested prior to the testing of test substances for phototoxic assessment. PIF or MPE values should be close to the values mentioned in Table 1.

Table 1

Chemical name	EINECS No	CAS No	PIF	MPE	Absorption peak	Solvent ⁽¹⁾
Amiodarone HCL	243-293-2	[19774-82-4]	> 3,25	0,2-0,54	242 nm 300 nm (shoulder)	ethanol
Choloropromazine HCL	200-701-3	[69-09-0]	> 14,4	0,33-0,63	309 nm	ethanol
Norfloxacin	274-614-4	[70458-96-7]	> 71,6	0,34-0,90	316 nm	acetonitrile
Anthracene	204-371-1	[120-12-7]	> 18,5	0,19-0,81	356 nm	acetonitrile
Protoporphyrin IX, Disodium	256-815-9	[50865-01-5]	> 45,3	0,54-0,74	402 nm	ethanol
L-Histidine		[7006-35-1]	no PIF	0,05-0,10	211 nm	water
Hexacholophene	200-733-8	[70-30-4]	1,1-1,7	0,00-0,05	299 nm 317 nm (shoulder)	ethanol
Sodium lauryl sulphate	205-788-1	[151-21-3]	1,0-1,9	0,00-0,05	no absorption	water

⁽¹⁾ Solvent used for measuring absorption.

2.4. INTERPRETATION OF DATA

If phototoxic effects are observed only at the highest test concentration, (especially for water soluble test chemicals) additional considerations may be necessary for assessment of hazard. These may include data on skin absorption, and accumulation of the chemical in the skin and/or data from other tests, e.g. testing of the chemical in *in vitro* animal or human skin, or skin models.

▼ B

If no toxicity is demonstrated (+Irr and -Irr), and if poor solubility limited the concentrations that could be tested, then the compatibility of the test substance with the assay may be questioned and confirmatory testing should be considered using, e.g. another model.

3. REPORTING**TEST REPORT**

The test report must include at least the following information:

Test substance:

- identification data, common generic names and IUPAC and CAS number, if known,
- physical nature and purity,
- physicochemical properties relevant to conduct of the study,
- UV/vis absorption spectrum,
- stability and photostability, if known.

Solvent:

- justification for choice of solvent,
- solubility of the test chemical in solvent,
- percentage of solvent present in treatment medium.

Cells:

- type and source of cells,
- absence of mycoplasma,
- cell passage number, if known,
- Radiation sensitivity of cells, determined with the irradiation equipment used in the *in vitro* 3T3 NRU phototoxicity test.

Test conditions (1); *incubation before and after treatment*:

- type and composition of culture medium,
- incubation conditions (CO₂ concentration; temperature; humidity),
- duration of incubation (pre-treatment; post-treatment).

Test conditions (2); *treatment with the chemical*:

- rationale for selection of concentrations of the test chemical used in the presence and in the absence of irradiation,
- in case of limited solubility of the test chemical and absence of cytotoxicity: rationale for the highest concentration tested,
- type and composition of treatment medium (buffered salt solution),
- duration of the chemical treatment.

Test conditions (3); *irradiation*:

- rationale for selection of the light source used,

▼ B

- manufacturer and type of light source and radiometer,
- spectral irradiance characteristics of the light source,
- transmission and absorption characteristics of the filter(s) used,
- characteristics of the radiometer and details on its calibration,
- distance of the light source from the test system,
- UVA irradiance at this distance, expressed in mW/cm^2 ,
- duration of the UV/vis light exposure,
- UVA dose (irradiance \times time), expressed in J/cm^2 ,
- temperature of cell cultures during irradiation and cell cultures concurrently kept in the dark.

Test conditions (4); *Neutral Red viability test*:

- composition of Neutral Red treatment medium,
- duration of Neutral Red incubation,
- incubation conditions (CO_2 concentration; temperature; humidity),
- Neutral Red extraction conditions (extractant; duration),
- wavelength used for spectrophotometric reading of Neutral Red optical density,
- second wavelength (reference), if used,
- content of spectrophotometer blank, if used.

Results:

- cell viability obtained at each concentration of the test chemical, expressed in percent viability of mean, concurrent solvent controls,
- concentration response curves (test chemical concentration vs. relative cell viability) obtained in concurrent +Irr and -Irr experiments,
- analysis of the concentration-response curves: if possible, computation/calculation of IC_{50} (+Irr) and IC_{50} (-Irr),
- comparison of the two concentration response curves obtained in the presence and in the absence of irradiation, either by calculation of the Photo-Irritation-Factor (PIF), or by calculation of the Mean-Photo-Effect (MPE),
- test acceptance criteria; concurrent solvent control:
- absolute viability (optical density of Neutral Red extract) of irradiated and non-irradiated cells,
- historic negative and solvent control data; means and standard deviations,
- test acceptance criteria; concurrent positive control,

▼B

— IC₅₀ (+Irr) and IC₅₀ (-Irr) and PIF/MPE of positive control chemical,

— historic positive control chemical data: IC₅₀ (+Irr) and IC₅₀ (-Irr) and PIF/MPE; means and standard deviations.

Discussion of the results.

Conclusions.

4.

REFERENCES

- (1) Lovell W.W., (1993) A scheme for *in vitro* screening of substances for photoallergenic potential. *Toxicology In Vitro* 7, p. 95-102.
- (2) Santamaria, L. and Prino, G., (1972) List of the photodynamic substances. In 'Research Progress in Organic, Biological and Medicinal Chemistry' Vol. 3 part 1. North Holland Publishing Co. Amsterdam. p. XI-XXXV.
- (3) Spielmann, H., Lovell, W.W., Hölzle, E., Johnson, B.E., Maurer, T., Miranda, M.A., Pape, W.J.W., Saporá, O., and Sladowski, D., (1994) *In vitro* phototoxicity testing: The report and recommendations of ECVAM Workshop 2. *ATLA*, 22, p. 314-348.
- (4) Spikes, J.D., (1989) Photosensitisation. In 'The science of Photobiology' Edited by K.C. Smith. Plenum Press, New York. 2nd edition, p. 79-110.
- (5) OECD, (1997) Environmental Health and Safety Publications, Series on Testing and Assessment No 7 'Guidance Document On Direct Phototransformation Of Chemicals In Water' Environment Directorate, OECD, Paris.
- (6) Spielmann, H., Balls, M., Döring, B., Holzhütter, H.G., Kalweit, S., Klecak, G., L'Eplattenier, H., Liebsch, M., Lovell, W.W., Maurer, T., Moldenhauer, F. Moore, L., Pape, W., Pfannbecker, U., Potthast, J., De Silva, O., Steiling, W., and Willshaw, A., (1994) EEC/COLIPA project on *in vitro* phototoxicity testing: First results obtained with a Balb/c 3T3 cell phototoxicity assay. *Toxic. In Vitro* 8, p. 793-796.
- (7) Anon, (1998) Statement on the scientific validity of the 3T3 NRU PT test (an *in vitro* test for phototoxicity), European Commission, Joint Research Centre: ECVAM and DGXI/E/2, 3 November 1997, *ATLA*, 26, p. 7-8.
- (8) Spielmann, H., Balls, M., Dupuis, J., Pape, W.J.W., Pechovitch, G. De Silva, O., Holzhütter, H.G., Clothier, R., Desolle, P., Gerberick, F., Liebsch, M., Lovell, W.W., Maurer, T., Pfannenbecker, U., Potthast, J. M., Csato, M., Sladowski, D., Steiling, W., and Brantom, P., (1998) The international EU/COLIPA *In vitro* phototoxicity validation study: results of phase II (blind trial), part 1: the 3T3 NRU phototoxicity test. *Toxicology In Vitro* 12, p. 305-327.
- (9) OECD, (2002) Extended Expert Consultation Meeting on The In Vitro 3T3 NRU Phototoxicity Test Guideline Proposal, Berlin, 30th-31th October 2001, Secretariat's Final Summary Report, 15th March 2002, OECD ENV/EHS, available upon request from the Secretariat.
- (10) Borenfreund, E., and Puerner, J.A., (1985) Toxicity determination *in vitro* by morphological alterations and neutral red absorption. *Toxicology Lett.*, 24, p. 119-124.
- (11) Hay, R.J., (1988) The seed stock concept and quality control for cell lines. *Analytical Biochemistry* 171, p. 225-237.

▼B

- (12) Lambert L.A, Warner W.G., and Kornhauser A., (1996) Animal models for phototoxicity testing. In 'Dermatotoxicology', edited by F.N. Marzulli and H.I. Maibach. Taylor & Francis, Washington DC. 5th Edition, p. 515-530.
- (13) Tyrrell R.M., Pidoux M., (1987) Action spectra for human skin cells: estimates of the relative cytotoxicity of the middle ultraviolet, near ultraviolet and violet regions of sunlight on epidermal keratinocytes. *Cancer Res.*, 47, p. 1825-1829.
- (14) ISO 10977., (1993) Photography — Processed photographic colour films and paper prints — Methods for measuring image stability.
- (15) Sunscreen Testing (UV.B) TECHNICALREPORT, CIE, International Commission on Illumination, Publication No 90, Vienna, 1993, ISBN 3 900 734 275
- (16) ZEBET/ECVAM/COLIPA — Standard Operating Procedure: *In Vitro* 3T3 NRU Phototoxicity Test. Final Version, 7 September, 1998. p. 18.
- (17) Spielmann, H., Balls, M., Dupuis, J., Pape, W.J.W., De Silva, O., Holzhütter, H.G., Gerberick, F., Liebsch, M., Lovell, W.W., and Pfannenbecker, U., (1998) A study on UV filter chemicals from Annex VII of the European Union *Directive 76/768/EEC*, in the *in vitro* 3T3 NRU phototoxicity test. *ATLA* 26, p. 679-708.
- (18) Holzhütter, H.G., and Quedenau, J., (1995) Mathematical modeling of cellular responses to external signals. *J. Biol. Systems* 3, p. 127-138.
- (19) Holzhütter, H.G., (1997) A general measure of *in vitro* phototoxicity derived from pairs of dose-response curves and its use for predicting the *in vivo* phototoxicity of chemicals. *ATLA*, 25, p. 445-462.
- (20) http://www.oecd.org/document/55/0,2340,en_2649_34377_2349687_1_1_1_1,00.html

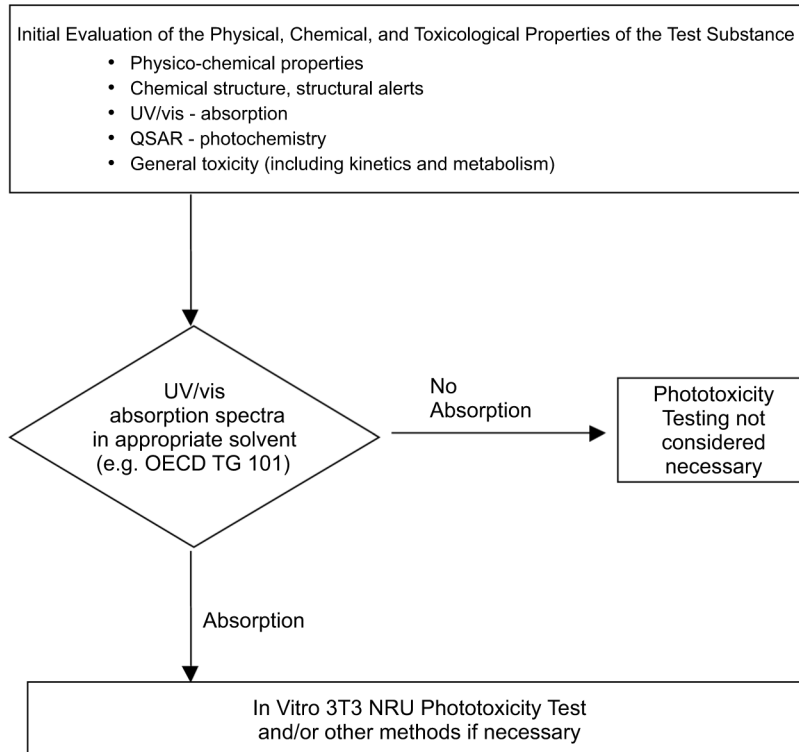
▼ B*Appendix 1***Role of the 3T3 NRU PT in a sequential approach to the phototoxicity testing of chemicals**

▼B

Appendix 2

Figure 1

Spectral power distribution of a filtered solar simulator

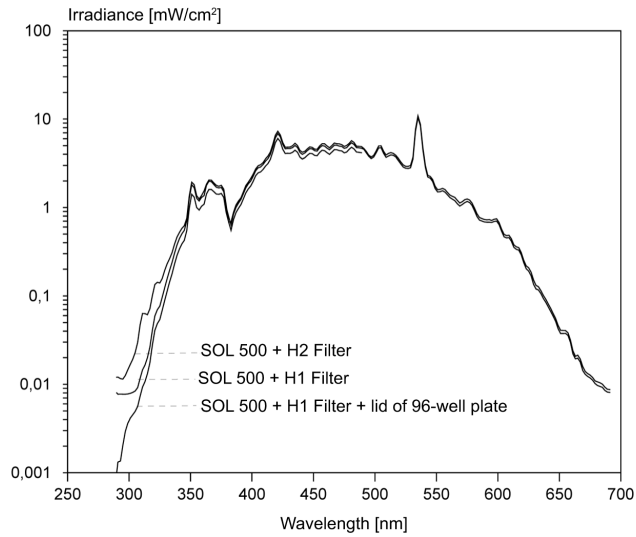

(see Section 1.4.1.5, second paragraph)

Figure 1 gives an example of an acceptable spectral irradiance distribution of a filtered solar simulator. It is from the doped metal halide source used in the validation trial of the 3T3 NRU PT (6)(8)(17). The effect of two different filters and the additional filtering effect of the lid of a 96-well cell culture plate are shown. The H2 filter was only used with test systems that can tolerate a higher amount of UVB (skin model test and red blood cell photo-haemolysis test). In the 3T3 NRU-PT the H1 filter was used. The figure shows that additional filtering effect of the plate lid is mainly observed in the UVB range, still leaving enough UVB in the irradiation spectrum to excite chemicals typically absorbing in the UVB range, like Amiodarone (see Table 1).

▼B**Figure 2****Irradiation sensitivity of Balb/c 3T3 cells (as measured in the UVA range)**

Cell viability (% Neutral Red uptake of dark controls)

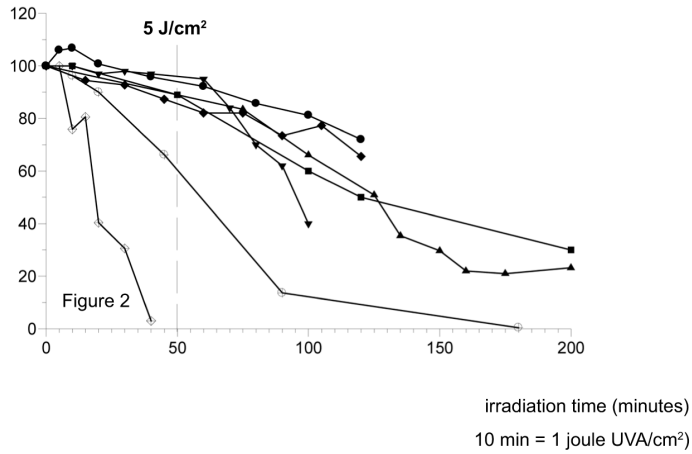

(see Sections 1.4.1.5.2 second paragraph; 1.4.2.2.1, 1.4.2.2.2)

Sensitivity of Balb/c 3T3 cells to irradiation with the solar simulator used in the validation trial of the 3T3NRU-phototoxicity test, as measured in the UVA range. Figure shows the results obtained in seven different laboratories in the pre-validation study (1). While the two curves with open symbols were obtained with aged cells (high number of passages), that had to be replaced by new cell stocks the curves with bold symbols show cells with acceptable irradiation tolerance.

From these data the highest non-cytotoxic irradiation dose of 5 J/cm² was derived (vertical dashed line). The horizontal dashed line shows in addition the maximum acceptable irradiation effect given in paragraph 1.4.2.2.

▼ M3**B.42. SKIN SENSITISATION: LOCAL LYMPH NODE ASSAY**

INTRODUCTION

1. OECD Guidelines for the Testing of Chemicals and EU Test Methods based on them are periodically reviewed in light of scientific progress, changing regulatory needs, and animal welfare considerations. The original Test Method (TM) for the determination of skin sensitisation in the mouse, the Local Lymph Node Assay (LLNA; OECD Test Guideline 429; Chapter B.42 of this Annex) was adopted previously (1). The details of the validation of the LLNA and a review of the associated work have been published (2) (3) (4) (5) (6) (7) (8) (9) (10) (11). The updated LLNA is based on the evaluation of experience and scientific data (12). This is the second TM to be designed for assessing skin sensitisation potential of chemicals (substances and mixtures) in animals. The other TM (*i.e.* OECD Test Guideline 406; Chapter B.6 of this Annex) utilises guinea pig tests, notably the guinea pig maximisation test and the Buehler test (13). The LLNA provides advantages over B.6 and OECD Test Guideline 406 (13) with regard to animal welfare. This updated LLNA TM includes a set of Performance Standards (PS) (Appendix 1) that can be used to evaluate the validation status of new and/or modified test methods that are functionally and mechanistically similar to the LLNA, in accordance with the principles of OECD Guidance Document No 34 (14).

2. The LLNA studies the induction phase of skin sensitisation and provides quantitative data suitable for dose-response assessment. It should be noted that the mild/moderate sensitisers which are recommended as suitable positive control chemicals (PC) for guinea pig test methods (*i.e.* B.6; OECD Test Guideline 406) (13) are also appropriate for use with the LLNA (6) (8) (15). A reduced LLNA (rLLNA) approach, which could use up to 40 % fewer animals is also described as an option in this TM (16) (17) (18). The rLLNA may be used when there is a regulatory need to confirm a negative prediction of skin sensitising potential, provided there is adherence to all other LLNA protocol specifications, as described in this TM. Prediction of a negative outcome should be made based on all available information as described in paragraph 4. Before applying the rLLNA approach, clear justifications and scientific rationale for its use should be provided. If, against expectations, a positive or equivocal result is obtained in the rLLNA, additional testing may be needed in order to interpret or clarify the finding. The rLLNA should not be used for the hazard identification of skin sensitising test substances when dose-response information is needed such as sub-categorisation for Regulation (EC) No 1272/2008 on classification, labelling and packaging of substances and mixtures and UN Globally Harmonised System of Classification and Labelling of Chemicals.

DEFINITIONS

3. Definitions used are provided in Appendix 2.

INITIAL CONSIDERATIONS AND LIMITATIONS

4. The LLNA provides an alternative method for identifying potential skin sensitising chemicals. This does not necessarily imply that in all instances the LLNA should be used in place of guinea pig tests (*i.e.* B.6; OECD Test Guideline 406) (13), but rather that the assay is of equal merit and may be employed as an alternative in which positive and negative results generally no longer require further confirmation. The testing laboratory should consider all available information on the test substance prior to conducting the study. Such information will include the identity and chemical structure

▼ M3

of the test substance; its physicochemical properties; the results of any other *in vitro* or *in vivo* toxicity tests on the test substance; and toxicological data on structurally related chemicals. This information should be considered in order to determine whether the LLNA is appropriate for the substance (given the incompatibility of limited types of chemicals with the LLNA — see paragraph 5) and to aid in dose selection.

5. The LLNA is an *in vivo* method and, as a consequence, will not eliminate the use of animals in the assessment of allergic contact sensitising activity. It has, however, the potential to reduce the number of animals required for this purpose. Moreover, the LLNA offers a substantial refinement (less pain and distress) of the way in which animals are used for allergic contact sensitisation testing. The LLNA is based upon consideration of immunological events stimulated by chemicals during the induction phase of sensitisation. Unlike guinea pig tests (*i.e.* B.6; OECD Test Guideline 406) (13) the LLNA does not require that challenge-induced dermal hypersensitivity reactions be elicited. Furthermore, the LLNA does not require the use of an adjuvant, as is the case for the guinea pig maximisation test (13). Thus, the LLNA reduces animal pain and distress. Despite the advantages of the LLNA over B.6 and OECD Test Guideline 406, it should be recognised that there are certain limitations that may necessitate the use of B.6 or OECD Test Guideline 406 (13) (*e.g.* false negative findings in the LLNA with certain metals, false positive findings with certain skin irritants (such as some surfactant type chemicals) (19) (20), or solubility of the test substance). In addition, chemical classes or substances containing functional groups shown to act as potential confounders (21) may necessitate the use of guinea pig tests (*i.e.* B.6; OECD Test Guideline 406) (13). Further, based on the limited validation database, which consisted primarily of pesticide formulations, the LLNA is more likely than the guinea pig test to yield a positive result for these types of test substances (22). However, when testing formulations, one could consider including similar substances with known results as benchmark substances to demonstrate that the LLNA is functioning properly (see paragraph 16). Other than such identified limitations, the LLNA should be applicable for testing any substances unless there are properties associated with these substances that may interfere with the accuracy of the LLNA.

PRINCIPLE OF THE TEST

6. The basic principle underlying the LLNA is that sensitisers induce proliferation of lymphocytes in the lymph nodes draining the site of test substance application. This proliferation is proportional to the dose and to the potency of the applied allergen and provides a simple means of obtaining a quantitative measurement of sensitisation. Proliferation is measured by comparing the mean proliferation in each test group to the mean proliferation in the vehicle treated control (VC) group. The ratio of the mean proliferation in each treated group to that in the concurrent VC group, termed the Stimulation Index (SI), is determined, and should be ≥ 3 before classification of the test substance as a potential skin sensitiser is warranted. The procedures described here are based on the use of *in vivo* radioactive labelling to measure an increased number of proliferating cells in the draining auricular lymph nodes. However, other endpoints for assessment of the number of proliferating cells may be employed provided the PS requirements are fully met (Appendix 1).

▼ M3**DESCRIPTION OF THE ASSAY****Selection of animal species**

7. The mouse is the species of choice for this test. Young adult female mice of CBA/Ca or CBA/J strain, which are nulliparous and non-pregnant, are used. At the start of the study, animals should be between 8-12 weeks old, and the weight variation of the animals should be minimal and not exceed 20 % of the mean weight. Alternatively, other strains and males may be used when sufficient data are generated to demonstrate that significant strain and/or gender-specific differences in the LLNA response do not exist.

Housing and feeding conditions

8. Mice should be group-housed (23), unless adequate scientific rationale for housing mice individually is provided. The temperature of the experimental animal room should be 22 ± 3 °C. Although the relative humidity should be at least 30 % and preferably not exceed 70 %, other than during room cleaning, the aim should be 50-60 %. Lighting should be artificial, the sequence being 12 hours light, 12 hours dark. For feeding, conventional laboratory diets may be used with an unlimited supply of drinking water.

Preparation of animals

9. The animals are randomly selected, marked to permit individual identification (but not by any form of ear marking), and kept in their cages for at least five days prior to the start of dosing to allow for acclimatisation to the laboratory conditions. Prior to the start of treatment all animals are examined to ensure that they have no observable skin lesions.

Preparation of dosing solutions

10. Solid chemicals should be dissolved or suspended in solvents/vehicles and diluted, if appropriate, prior to application to an ear of the mice. Liquid chemicals may be applied neat or diluted prior to dosing. Insoluble chemicals, such as those generally seen in medical devices, should be subjected to an exaggerated extraction in an appropriate solvent to reveal all extractable constituents for testing prior to application to an ear of the mice. Test substances should be prepared daily unless stability data demonstrate the acceptability of storage.

Reliability check

11. Positive control chemicals (PC) are used to demonstrate appropriate performance of the assay by responding with adequate and reproducible sensitivity as a sensitising test substance for which the magnitude of the response is well characterised. Inclusion of a concurrent PC is recommended because it demonstrates competency of the laboratory to successfully conduct each assay and allows for an assessment of intra- and inter-laboratory reproducibility and comparability. A PC for each study is also required by some regulatory authorities and therefore users are encouraged to consult the relevant authorities prior to conducting the LLNA. Accordingly, the routine use of a concurrent PC is encouraged to avoid the need for additional animal testing to meet such requirements that might arise from the use of a periodic PC (see paragraph 12). The PC should produce a positive LLNA response at an exposure level expected to give an increase in the SI > 3 over the negative control (NC) group. The PC dose should be chosen such that it does not cause excessive skin irritation or systemic toxicity and the induction is reproducible but not

▼ M3

excessive (*i.e.* a SI > 20 would be excessive). Preferred PC are 25 % hexyl cinnamic aldehyde (Chemical Abstracts Service (CAS) No 101-86-0) in acetone: olive oil (4:1, v/v) and 5 % mercaptobenzothiazole (CAS No 149-30-4) in *N,N*-dimethylformamide (see Appendix 1, Table 1). There may be circumstances in which, given adequate justification, other PC, meeting the above criteria, may be used.

12. While inclusion of a concurrent PC group is recommended, there may be situations in which periodic testing (*i.e.* at intervals ≤ 6 months) of the PC may be adequate for laboratories that conduct the LLNA regularly (*i.e.* conduct the LLNA at a frequency of no less than once per month) and have an established historical PC database that demonstrates the laboratory's ability to obtain reproducible and accurate results with PCs. Adequate proficiency with the LLNA can be successfully demonstrated by generating consistent positive results with the PC in at least 10 independent tests conducted within a reasonable period of time (*i.e.* less than one year).
13. A concurrent PC group should always be included when there is a procedural change to the LLNA (*e.g.* change in trained personnel, change in test method materials and/or reagents, change in test method equipment, change in source of test animals), and such changes should be documented in laboratory reports. Consideration should be given to the impact of these changes on the adequacy of the previously established historical database in determining the necessity for establishing a new historical database to document consistency in the PC results.
14. Investigators should be aware that the decision to conduct a PC study on a periodic basis instead of concurrently has ramifications on the adequacy and acceptability of negative study results generated without a concurrent PC during the interval between each periodic PC study. For example, if a false negative result is obtained in the periodic PC study, negative test substance results obtained in the interval between the last acceptable periodic PC study and the unacceptable periodic PC study may be questioned. Implications of these outcomes should be carefully considered when determining whether to include concurrent PCs or to only conduct periodic PCs. Consideration should also be given to using fewer animals in the concurrent PC group when this is scientifically justified and if the laboratory demonstrates, based on laboratory-specific historical data, that fewer mice can be used (12).
15. Although the PC should be tested in the vehicle that is known to elicit a consistent response (*e.g.* acetone: olive oil; 4:1, v/v), there may be certain regulatory situations in which testing in a non-standard vehicle (clinically/chemically relevant formulation) will also be necessary (24). If the concurrent PC is tested in a different vehicle than the test substance, then a separate VC for the concurrent PC should be included.
16. In instances where test substances of a specific chemical class or range of responses are being evaluated, benchmark substances may also be useful to demonstrate that the test method is functioning properly for detecting the skin sensitisation potential of these types of test substances. Appropriate benchmark substances should have the following properties:
 - structural and functional similarity to the class of the test substance being tested;
 - known physical/chemical characteristics;
 - supporting data from the LLNA;
 - supporting data from other animal models and/or from humans.

▼ M3**TEST PROCEDURE****Number of animals and dose levels**

17. A minimum of four animals is used per dose group, with a minimum of three concentrations of the test substance, plus a concurrent NC group treated only with the vehicle for the test substance, and a PC (concurrent or recent, based on laboratory policy in considering paragraphs 11-15). Testing multiple doses of the PC should be considered, especially when testing the PC on an intermittent basis. Except for absence of treatment with the test substance, animals in the control groups should be handled and treated in a manner identical to that of animals in the treatment groups.

18. Dose and vehicle selection should be based on the recommendations given in references (3) and (5). Consecutive doses are normally selected from an appropriate concentration series such as 100 %, 50 %, 25 %, 10 %, 5 %, 2,5 %, 1 %, 0,5 %, etc. Adequate scientific rationale should accompany the selection of the concentration series used. All existing toxicological information (*e.g.* acute toxicity and dermal irritation) and structural and physicochemical information on the test substance of interest (and/or structurally related substances) should be considered where available, in selecting the three consecutive concentrations so that the highest concentration maximises exposure while avoiding systemic toxicity and/or excessive local skin irritation (3) (25). In the absence of such information, an initial pre-screen test may be necessary (see paragraphs 21-24).

19. The vehicle should not interfere with or bias the test result and should be selected on the basis of maximising the solubility in order to obtain the highest concentration achievable while producing a solution/suspension suitable for application of the test substance. Recommended vehicles are acetone: olive oil (4:1, v/v), *N,N*-dimethylformamide, methyl ethyl ketone, propylene glycol, and dimethyl sulphoxide (19) but others may be used if sufficient scientific rationale is provided. In certain situations it may be necessary to use a clinically relevant solvent or the commercial formulation in which the test substance is marketed as an additional control. Particular care should be taken to ensure that hydrophilic test substances are incorporated into a vehicle system, which wets the skin and does not immediately run off, by incorporation of appropriate solubilisers (*e.g.* 1 % Pluronic® L92). Thus, wholly aqueous vehicles are to be avoided.

20. The processing of lymph nodes from individual mice allows for the assessment of inter-animal variability and a statistical comparison of the difference between test substance and VC group measurements (see paragraph 35). In addition, evaluating the possibility of reducing the number of mice in the PC group is feasible when individual animal data are collected (12). Further, some regulatory authorities require the collection of individual animal data. Nonetheless, pooled animal data may be considered acceptable by some regulatory authorities and in such situations, users may have the option of collecting either individual or pooled animal data.

Pre-screen test

21. In the absence of information to determine the highest dose to be tested (see paragraph 18), a pre-screen test should be performed in order to define the appropriate dose level to test in the LLNA. The purpose of the pre-screen test is to provide guidance for selecting the maximum dose level to use in the main LLNA study, where information on the concentration that induces systemic toxicity (see paragraph 24) and/or excessive local skin irritation (see paragraph 23) is not available. The maximum dose level tested should be 100 % of the test substance for liquids or the maximum possible concentration for solids or suspensions.

▼ **M3**

22. The pre-screen test is conducted under conditions identical to the main LLNA study, except there is no assessment of lymph node proliferation and fewer animals per dose group can be used. One or two animals per dose group are suggested. All mice will be observed daily for any clinical signs of systemic toxicity or local irritation at the application site. Body weights are recorded pre-test and prior to termination (Day 6). Both ears of each mouse are observed for erythema and scored using Table 1 (25). Ear thickness measurements are taken using a thickness gauge (*e.g.* digital micrometer or Peacock Dial thickness gauge) on Day 1 (pre-dose), Day 3 (approximately 48 hours after the first dose), and Day 6. Additionally, on Day 6, ear thickness could be determined by ear punch weight determinations, which should be performed after the animals are humanely killed. Excessive local skin irritation is indicated by an erythema score ≥ 3 and/or an increase in ear thickness of $\geq 25\%$ on any day of measurement (26) (27). The highest dose selected for the main LLNA study will be the next lower dose in the pre-screen concentration series (see paragraph 18) that does not induce systemic toxicity and/or excessive local skin irritation.

Table 1
Erythema Scores

Observation	Score
No erythema	0
Very slight erythema (barely perceptible)	1
Well-defined erythema	2
Moderate to severe erythema	3
Severe erythema (beet redness) to eschar formation preventing grading of erythema	4

23. In addition to a 25 % increase in ear thickness (26) (27), a statistically significant increase in ear thickness in the treated mice compared to control mice has also been used to identify irritants in the LLNA (28) (29) (30) (31) (32) (33) (34). However, while statistically significant increases can occur when ear thickness is less than 25 % they have not been associated specifically with excessive irritation (30) (32) (33) (34).
24. The following clinical observations may indicate systemic toxicity (35) (36) when used as part of an integrated assessment and therefore may indicate the maximum dose level to use in the main LLNA: changes in nervous system function (*e.g.* pilo-erection, ataxia, tremors, and convulsions); changes in behaviour (*e.g.* aggressiveness, change in grooming activity, marked change in activity level); changes in respiratory patterns (*i.e.* changes in frequency and intensity of breathing such as dyspnea, gasping, and rales), and changes in food and water consumption. In addition, signs of lethargy and/or unresponsiveness and any clinical signs of more than slight or momentary pain and distress, or a $> 5\%$ reduction in body weight from Day 1 to Day 6, and mortality should be considered in the evaluation. Moribund animals or animals obviously in pain or showing signs of severe and enduring distress should be humanely killed (37).

▼ M3**Main study experimental schedule**

25. The experimental schedule of the assay is as follows:
- *Day 1*: Individually identify and record the weight of each animal and any clinical observation. Apply 25 µL of the appropriate dilution of the test substance, the vehicle alone, or the PC (concurrent or recent, based on laboratory policy in considering paragraphs 11-15), to the dorsum of each ear.
 - *Days 2 and 3*: Repeat the application procedure carried out on Day 1.
 - *Days 4 and 5*: No treatment.
 - *Day 6*: Record the weight of each animal. Inject 250 µL of sterile phosphate-buffered saline (PBS) containing 20 µCi ($7,4 \times 10^5$ Bq) of tritiated (^3H)-methyl thymidine into all test and control mice via the tail vein. Alternatively, inject 250 µL sterile PBS containing 2 µCi ($7,4 \times 10^4$ Bq) of ^{125}I -iododeoxyuridine and 10^{-5}M fluorodeoxyuridine into all mice via the tail vein. Five hours (5 h) later, humanely kill the animals. Excise the draining auricular lymph nodes from each mouse ear and process together in PBS for each animal (individual animal approach); alternatively excise and pool the lymph nodes from each ear in PBS for each treatment group (pooled treatment group approach). Details and diagrams of the lymph node identification and dissection can be found in reference (12). To further monitor the local skin response in the main study, additional parameters such as scoring of ear erythema or ear thickness measurements (obtained either by using a thickness gauge, or ear punch weight determinations at necropsy) may be included in the study protocol.

Preparation of cell suspensions

26. A single-cell suspension of lymph node cells (LNC) excised bilaterally using the individual animal approach or alternatively, the pooled treatment group approach is prepared by gentle mechanical disaggregation through 200 micron-mesh stainless steel gauze or another acceptable technique for generating a single-cell suspension. The LNC are washed twice with an excess of PBS and the DNA is precipitated with 5 % trichloroacetic acid (TCA) at 4 °C for 18h (3). Pellets are either resuspended in 1 mL TCA and transferred to scintillation vials containing 10 mL of scintillation fluid for ^3H -counting, or transferred directly to gamma counting tubes for ^{125}I -counting.

Determination of cellular proliferation (incorporated radioactivity)

27. Incorporation of ^3H -methyl thymidine is measured by β -scintillation counting as disintegrations per minute (DPM). Incorporation of ^{125}I -iododeoxyuridine is measured by ^{125}I -counting and also is expressed as DPM. Depending on the approach used, the incorporation is expressed as DPM/mouse (individual animal approach) or DPM/treatment group (pooled treatment group approach).

Reduced LLNA

28. In certain situations, when there is a regulatory need to confirm a negative prediction of skin sensitising potential, an optional rLLNA protocol (16) (17) (18) using fewer animals may be used, provided there is adherence to all other LLNA protocol specifications in this TM. Before applying the rLLNA approach, clear justifications and scientific rationale for its use should be provided. If a positive or equivocal result is obtained, additional testing may be needed in order to interpret or clarify the finding.

▼ M3

29. The reduction in number of dose groups is the only difference between the LLNA and the rLLNA test method protocols and for this reason the rLLNA does not provide dose-response information. Therefore, the rLLNA should not be used when dose-response information is needed. Like the multi-dose LLNA, the test substance concentration evaluated in the rLLNA should be the maximum concentration that does not induce overt systemic toxicity and/or excessive local skin irritation in the mouse (see paragraph 18).

OBSERVATIONS**Clinical observations**

30. Each mouse should be carefully observed at least once daily for any clinical signs, either of local irritation at the application site or of systemic toxicity. All observations are systematically recorded with records being maintained for each mouse. Monitoring plans should include criteria to promptly identify those mice exhibiting systemic toxicity, excessive local skin irritation, or corrosion of skin for euthanasia (37).

Body weights

31. As stated in paragraph 25, individual animal body weights should be measured at the start of the test and at the scheduled humane kill.

CALCULATION OF RESULTS

32. Results for each treatment group are expressed as the SI. When using the individual animal approach, the SI is derived by dividing the mean DPM/mouse within each test substance group, and the PC group, by the mean DPM/mouse for the solvent/VC group. The average SI for the VCs is then one. When using the pooled treatment group approach, the SI is obtained by dividing the pooled radioactive incorporation for each treatment group by the incorporation of the pooled VC group; this yields a mean SI.
33. The decision process regards a result as positive when $SI \geq 3$. However, the strength of the dose-response, the statistical significance and the consistency of the solvent/vehicle and PC responses may also be used when determining whether a borderline result is declared positive (4) (5) (6).
34. If it is necessary to clarify the results obtained, consideration should be given to various properties of the test substance, including whether it has a structural relationship to known skin sensitizers, whether it causes excessive local skin irritation in the mouse, and the nature of the dose-response relationship seen. These and other considerations are discussed in detail elsewhere (7).
35. Collecting radioactivity data at the level of the individual mouse will enable a statistical analysis for presence and degree of dose-response relationship in the data. Any statistical assessment could include an evaluation of the dose-response relationship as well as suitably adjusted comparisons of test groups (e.g. pair-wise dosed group versus concurrent VC comparisons). Statistical analyses may include, e.g. linear regression or William's test to assess dose-response trends, and Dunnett's test for pair-wise comparisons. In choosing an appropriate method of statistical analysis, the investigator should maintain an awareness of possible inequalities of variances and other related problems that may necessitate a data transformation or a non-parametric statistical analysis. In any case the investigator may need to carry out SI calculations and statistical analyses with and without certain data points (sometimes called 'outliers').

▼ M3**DATA AND REPORTING****Data**

36. Data should be summarised in tabular form. When using the individual animal approach, show the individual animal DPM values, the group mean DPM/animal, its associated error term (*e.g.* SD, SEM), and the mean SI for each dose group compared against the concurrent VC group. When using the pooled treatment group approach, show the mean/median DPM and the mean SI for each dose group compared against the concurrent VC group.

Test report

37. The test report should contain the following information:

Test and control substances:

- identification data (*e.g.* CAS and EC numbers, if available; source; purity; known impurities; lot number);
- physical nature and physicochemical properties (*e.g.* volatility, stability, solubility);
- if mixture, composition and relative percentages of components;

Solvent/vehicle:

- identification data (purity; concentration, where appropriate; volume used);
- justification for choice of vehicle;

Test animals:

- source of CBA mice;
- microbiological status of the animals, when known;
- number and age of animals;
- source of animals, housing conditions, diet, etc.;

Test conditions:

- details of test substance preparation and application;
- justification for dose selection (including results from pre-screen test, if conducted);
- vehicle and test substance concentrations used, and total amount of test substance applied;
- details of food and water quality (including diet type/source, water source);
- details of treatment and sampling schedules;
- methods for measurement of toxicity;
- criteria for considering studies as positive or negative;
- details of any protocol deviations and an explanation on how the deviation affects the study design and results;

Reliability check:

- summary of results of latest reliability check, including information on test substance, concentration and vehicle used;
- concurrent and/or historical PC and concurrent NC data for testing laboratory;

▼ **M3**

- if a concurrent PC was not included, the date and laboratory report for the most recent periodic PC and a report detailing the historical PC data for the laboratory justifying the basis for not conducting a concurrent PC;

Results:

- individual weights of mice at start of dosing and at scheduled kill; as well as mean and associated error term (*e.g.* SD, SEM) for each treatment group;
- time course of onset and signs of toxicity, including dermal irritation at site of administration, if any, for each animal;
- a table of individual mouse (individual animal approach) or mean/median (pooled treatment group approach) DPM values and SI values for each treatment group;
- mean and associated error term (*e.g.* SD, SEM) for DPM/mouse for each treatment group and the results of outlier analysis for each treatment group when using the individual animal approach;
- calculated SI and an appropriate measure of variability that takes into account the inter-animal variability in both the test substance and control groups when using the individual animal approach;
- dose-response relationship;
- statistical analyses, where appropriate;

Discussion of results:

- a brief commentary on the results, the dose-response analysis, and statistical analyses, where appropriate, with a conclusion as to whether the test substance should be considered a skin sensitiser.

LITERATURE

- (1) OECD (2002), Skin Sensitisation: Local Lymph Node Assay. OECD Guideline for the Testing of Chemicals No 429, Paris. Available at: [<http://www.oecd.org/env/testguidelines>]
- (2) Kimber, I. and Basketter, D.A. (1992), The murine local lymph node assay; collaborative studies and new directions: A commentary, *Food Chem. Toxicol.*, 30, 165-169.
- (3) Kimber, I., Dearman, R.J., Scholes, E.W. and Basketter, D.A. (1994), The local lymph node assay: developments and applications, *Toxicol.*, 93, 13-31.
- (4) Kimber, I., Hilton, J., Dearman, R.J., Gerberick, G.F., Ryan, C.A., Basketter, D.A., Lea, L., House, R.V., Ladies, G.S., Loveless, S.E. and Hastings, K.L. (1998), Assessment of the skin sensitisation potential of topical medicaments using the local lymph node assay: An interlaboratory exercise, *J. Toxicol. Environ. Health*, 53, 563-79.
- (5) Chamberlain, M. and Basketter, D.A. (1996), The local lymph node assay: status of validation, *Food Chem. Toxicol.*, 34, 999-1002.
- (6) Basketter, D.A., Gerberick, G.F., Kimber, I. and Loveless, S.E. (1996), The local lymph node assay: A viable alternative to currently accepted skin sensitisation tests, *Food Chem. Toxicol.*, 34, 985-997.
- (7) Basketter, D.A., Gerberick, G.F. and Kimber, I. (1998), Strategies for identifying false positive responses in predictive sensitisation tests, *Food Chem. Toxicol.*, 36, 327-33.

▼ M3

- (8) Van Och, F.M.M., Slob, W., De Jong, W.H., Vandebriel, R.J. and Van Loveren, H. (2000), A quantitative method for assessing the sensitising potency of low molecular weight chemicals using a local lymph node assay: employment of a regression method that includes determination of uncertainty margins, *Toxicol.*, 146, 49-59.
- (9) Dean, J.H., Twerdok, L.E., Tice, R.R., Sailstad, D.M., Hattan, D.G., Stokes, W.S. (2001), ICCVAM evaluation of the murine local lymph node assay: II. Conclusions and recommendations of an independent scientific peer review panel, *Reg. Toxicol. Pharmacol.*, 34: 258-273.
- (10) Haneke, K.E., Tice, R.R., Carson, B.L., Margolin, B.H., Stokes, W.S. (2001), ICCVAM evaluation of the murine local lymph node assay: III. Data analyses completed by the national toxicology program interagency center for the evaluation of alternative toxicological methods, *Reg. Toxicol. Pharmacol.*, 34, 274-286.
- (11) Sailstad, D.M., Hattan, D., Hill, R.N., Stokes, W.S. (2001), ICCVAM evaluation of the murine local lymph node assay: I. The ICCVAM review process, *Reg. Toxicol. Pharmacol.*, 34: 249-257.
- (12) ICCVAM (2009), Recommended Performance Standards: Murine Local Lymph Node Assay, NIH Publication Number 09-7357, Research Triangle Park, NC: National Institute of Environmental Health Sciences. Available at: [http://iccvam.niehs.nih.gov/docs/immunotox_docs/llna-ps/LLNAPerfStds.pdf]
- (13) OECD (1992), *Skin Sensitisation*. OECD Guideline for Testing of Chemicals No 406, OECD, Paris. Available at: [<http://www.oecd.org/env/testguidelines>]
- (14) OECD (2005), *Guidance Document on the Validation and International Acceptance of New or Updated Test Methods for Hazard Assessment*, Environment, Health and Safety Monograph, Series on Testing and Assessment No 34, ENV/JM/MONO(2005)14, OECD, Paris. Available at: [<http://www.oecd.org/env/testguidelines>]
- (15) Dearman, R.J., Hilton, J., Evans, P., Harvey, P., Basketter, D.A. and Kimber, I. (1998), Temporal stability of local lymph node assay responses to hexyl cinnamic aldehyde, *J. Appl. Toxicol.*, 18, 281-284.
- (16) Kimber, I., Dearman, R.J., Betts, C.J., Gerberick, G.F., Ryan, C.A., Kern, P.S., Patlewicz, G.Y. and Basketter, D.A. (2006), The local lymph node assay and skin sensitisation: a cut-down screen to reduce animal requirements? *Contact Dermatitis*, 54, 181-185.
- (17) ESAC (2007), Statement on the Reduced Local Lymph Node Assay (rLLNA), European Commission Directorate-General, Joint Research Centre, Institute for Health and Consumer Protection, European Centre for the Validation of Alternative Methods, April 2007. Available at: [http://ecvam.jrc.it/ft_doc/ESAC26_statement_rLLNA_20070525-1.pdf]
- (18) ICCVAM (2009), The Interagency Coordinating Committee on the Validation of Alternative Methods (ICCVAM) Test Method Evaluation Report. The Reduced Murine Local Lymph Node Assay: An Alternative Test Method Using Fewer Animals to Assess the Allergic Contact Dermatitis Potential of Chemicals and Products, NIH Publication Number 09-6439, Research Triangle Park, NC: National Institute of Environmental Health Sciences. Available at: [<http://iccvam.niehs.nih.gov/>]
- (19) ICCVAM (1999), The Murine Local Lymph Node Assay: A Test Method for Assessing the Allergic Contact Dermatitis Potential of Chemicals/Compounds, The Results of an Independent Peer Review Evaluation Coordinated by the Interagency Coordinating Committee on the Validation of Alternative Methods (ICCVAM) and the National Toxicology Program Interagency Center for the Evaluation of Alternative Toxicological Methods (NICEATM), NIH Publication No 99-4494, Research Triangle Park, NC: National Institute of Environmental Health Sciences. Available at: [http://iccvam.niehs.nih.gov/docs/immunotox_docs/llna/llnarep.pdf]

▼ M3

- (20) Kreiling, R., Hollnagel, H.M., Hareng, L., Eigler, L., Lee, M.S., Griem, P., Dreesen, B., Kleber, M., Albrecht, A., Garcia, C. and Wendel, A. (2008), Comparison of the skin sensitising potential of unsaturated compounds as assessed by the murine local lymph node assay (LLNA) and the guinea pig maximization test (GPMT), *Food Chem. Toxicol.*, 46, 1896-1904.
- (21) Basketter, D., Ball, N., Cagen, S., Carrilo, J.C., Certa, H., Eigler, D., Garcia, C., Esch, H., Graham, C., Haux, C., Kreiling, R. and Mehling, A. (2009), Application of a weight of evidence approach to assessing discordant sensitisation datasets: implications for REACH, *Reg. Toxicol. Pharmacol.*, 55, 90-96.
- (22) ICCVAM (2009), ICCVAM Test Method Evaluation Report. Assessment of the Validity of the LLNA for Testing Pesticide Formulations and Other Products, Metals, and Substances in Aqueous Solutions, NIH Publication Number 10-7512, Research Triangle Park, NC: National Institute of Environmental Health Sciences, Available at: [<http://iccvam.niehs.nih.gov/>]
- (23) ILAR (1996), Institute of Laboratory Animal Research (ILAR) Guide for the Care and Use of Laboratory Animals, 7th ed. Washington, DC: National Academies Press.
- (24) McGarry, H.F. (2007), The murine local lymph node assay: regulatory and potency considerations under REACH, *Toxicol.*, 238, 71-89.
- (25) OECD (2002), Acute Dermal Irritation/Corrosion. OECD Guideline for Testing of Chemicals No 404, Paris, France. Available at: [http://www.oecd.org/document/40/0,3343,en_2649_34377_37051368_1_1_1_1,00.html]
- (26) Reeder, M.K., Broomhead, Y.L., DiDonato, L. and DeGeorge, G.L. (2007), Use of an enhanced local lymph node assay to correctly classify irritants and false positive substances, *Toxicologist*, 96, 235.
- (27) ICCVAM (2009), Non-radioactive Murine Local Lymph Node Assay: Flow Cytometry Test Method Protocol (LLNA: BrdU-FC) Revised Draft Background Review Document, Research Triangle Park, NC: National Institute of Environmental Health Sciences. Available at: [<http://iccvam.niehs.nih.gov/methods/immunotox/fcLLNA/BRDcomplete.pdf>]
- (28) Hayes, B.B., Gerber, P.C., Griffey, S.S. and Meade, B.J. (1998), Contact hypersensitivity to dicyclohexylcarbodiimide and diisopropylcarbodiimide in female B6C3F1 mice, *Drug. Chem. Toxicol.*, 21, 195-206.
- (29) Homey, B., von Schilling, C., Blumel, J., Schuppe, H.C., Ruzicka, T., Ahr, H.J., Lehmann, P. and Vohr, V.W. (1998), An integrated model for the differentiation of chemical-induced allergic and irritant skin reactions, *Toxicol. Appl. Pharmacol.*, 153, 83-94.
- (30) Woolhiser, M.R., Hayes, B.B. and Meade, B.J. (1998), A combined murine local lymph node and irritancy assay to predict sensitisation and irritancy potential of chemicals, *Toxicol. Meth.*, 8, 245-256.
- (31) Hayes, B.B. and Meade, B.J. (1999), Contact sensitivity to selected acrylate compounds in B6C3F1 mice: relative potency, cross reactivity, and comparison of test methods, *Drug. Chem. Toxicol.*, 22, 491-506.
- (32) Ehling, G., Hecht, M., Heusener, A., Huesler, J., Gamer, A.O., van Loveren, H., Maurer, T., Riecke, K., Ullmann, L., Ulrich, P., Vandebriel, R. and Vohr, H.W. (2005), A European inter-laboratory validation of alternative endpoints of the murine local lymph node assay: first round. *Toxicol.*, 212, 60-68.
- (33) Vohr, H.W. and Ahr, H.J. (2005), The local lymph node assay being too sensitive? *Arch. Toxicol.*, 79, 721-728.
- (34) Patterson, R.M., Noga, E. and Germolec, D. (2007), Lack of evidence for contact sensitisation by Pfisteria extract, *Environ. Health Perspect.*, 115, 1023-1028.
- (35) OECD (1987), *Acute Dermal Toxicity*, OECD Guideline for Testing of Chemicals No 402, Paris, France. Available at: [<http://www.oecd.org/env/testguidelines>]

▼ M3

- (36) ICCVAM (2009), Report on the ICCVAM-NICEATM/ECVAM/JaCVAM Scientific Workshop on Acute Chemical Safety Testing: Advancing In Vitro Approaches and Humane Endpoints for Systemic Toxicity Evaluations. Research Triangle Park, NC: National Institute of Environmental Health Sciences, Available at: [http://iccvam.niehs.nih.gov/methods/acutetox/Tox_workshop.htm]
- (37) OECD (2000), *Guidance Document on the Recognition, Assessment and Use of Clinical Signs as Humane Endpoints for Experimental Animals Used in Safety Evaluation*, Environmental Health and Safety Monograph, Series on Testing and Assessment No 19, ENV/JM/MONO(2000)7, OECD, Paris. Available at: [<http://www.oecd.org/env/testguidelines>]

▼ **M3***Appendix 1***Performance standards for assessment of proposed similar or modified llna test methods for skin sensitisation**

INTRODUCTION

1. The purpose of Performance Standards (PS) is to communicate the basis by which new test methods, both proprietary (*i.e.* copyrighted, trademarked, registered) and non-proprietary can be determined to have sufficient accuracy and reliability for specific testing purposes. These PS, based on validated and accepted test methods, can be used to evaluate the reliability and accuracy of other similar methods (colloquially referred to as ‘me-too’ tests) that are based on similar scientific principles and measure or predict the same biological or toxic effect (14).

2. Prior to adoption of modified methods (*i.e.* proposed potential improvements to an approved test method), there should be an evaluation to determine the effect of the proposed changes on the test’s performance and the extent to which such changes affect the information available for the other components of the validation process. Depending on the number and nature of the proposed changes, the generated data and supporting documentation for those changes, they should either be subjected to the same validation process as described for a new test, or, if appropriate, to a limited assessment of reliability and relevance using established PS (14).

3. Similar or modified methods proposed for use under this TM should be evaluated to determine their reliability and accuracy using chemicals representing the full range of the LLNA scores. To avoid unwarranted animal use, it is strongly recommended that model developers consult the appropriate authorities before starting validation studies in accordance with the PS and guidance provided in this TM.

4. These PS are based on the US-ICCVAM, EC-ECVAM and Japanese-JaCVAM harmonised PS (12), for evaluating the validity of similar or modified versions of the LLNA. The PS consists of essential test method components, recommended reference chemicals and standards for accuracy and reliability that the proposed method should meet or exceed.

I. Essential test method components

5. To ensure that a similar or modified LLNA method is functionally and mechanistically analogous to the LLNA and measures the same biological effect, the following components should be included in the test method protocol:

— The test substance should be applied topically to both ears of the mouse;

— Lymphocyte proliferation should be measured in the lymph nodes draining from the site of test substance application;

— Lymphocyte proliferation should be measured during the induction phase of skin sensitisation;

▼ M3

- For test substances, the highest dose selected should be the maximum concentration that does not induce systemic toxicity and/or excessive local skin irritation in the mouse. For positive reference chemicals, the highest dose should be at least as high as the LLNA EC3 values of the corresponding reference chemicals (see Table 1) without producing systemic toxicity and/or excessive local skin irritation in the mouse;
- A concurrent VC should be included in each study and, where appropriate, a concurrent PC should also be used;
- A minimum of four animals per dose group should be used;
- Either individual or pooled animal data may be collected.

If any of these criteria are not met, then these PS cannot be used for validation of the similar or modified method.

II. Minimum list of reference chemicals

6. The US-ICCVAM, EC-ECVAM and Japanese-JaCVAM harmonised PS (12) identified 18 minimum reference chemicals that should be used and four optional reference chemicals (*i.e.* substances that produced either false positive or false negative results in the LLNA, when compared to human and guinea pig results (B.6, or OECD Test Guideline 406) (13), and therefore provide the opportunity to demonstrate equal to or better performance than the LLNA) that are included in the LLNA PS. The selection criteria for identifying these chemicals were:
 - The list of reference chemicals represented the types of substances typically tested for skin sensitisation potential and the range of responses that the LLNA is capable of measuring or predicting;
 - The substances had well-defined chemical structures;
 - LLNA data from guinea pig tests (*i.e.* B.6; OECD Test Guideline 406) (13) and (where possible) data from humans were available for each substance; and
 - The substances were readily available from a commercial source.

The recommended reference chemicals are listed in Table 1. Studies using the proposed reference chemicals should be evaluated in the vehicle with which they are listed in Table 1. In situations where a listed substance may not be available, other substances that meet the selection criteria mentioned may be used, with adequate justification.

Table 1

Recommended Reference chemicals for the LLNA PS.

Number	Chemicals ⁽¹⁾	CAS No	Form	Veh ⁽²⁾	EC3 % ⁽³⁾	N ⁽⁴⁾	0,5x-2,0x EC3	Actual EC3 Range	LLNA vs GP	LLNA vs Human
1	5-Chloro-2-methyl-4-isothiazolin-3-one (CMI)/2-methyl-4-isothiazolin-3-one (MI) ⁽⁵⁾	26172-55-4/ 2682-20-4	Liq	DMF	0,009	1	0,0045-0,018	NC	+/+	+/+
2	DNCB	97-00-7	Sol	AOO	0,049	15	0,025-0,099	0,02-0,094	+/+	+/+
3	4-Phenylenediamine	106-50-3	Sol	AOO	0,11	6	0,055-0,22	0,07-0,16	+/+	+/+
4	Cobalt chloride	7646-79-9	Sol	DMSO	0,6	2	0,3-1,2	0,4-0,8	+/+	+/+
5	Isoeugenol	97-54-1	Liq	AOO	1,5	47	0,77-3,1	0,5-3,3	+/+	+/+
6	2-Mercaptobenzothiazole	149-30-4	Sol	DMF	1,7	1	0,85-3,4	NC	+/+	+/+
7	Citral	5392-40-5	Liq	AOO	9,2	6	4,6-18,3	5,1-13	+/+	+/+
8	HCA	101-86-0	Liq	AOO	9,7	21	4,8-19,5	4,4-14,7	+/+	+/+
9	Eugenol	97-53-0	Liq	AOO	10,1	11	5,05-20,2	4,9-15	+/+	+/+
10	Phenyl benzoate	93-99-2	Sol	AOO	13,6	3	6,8-27,2	1,2-20	+/+	+/+
11	Cinnamic alcohol	104-54-1	Sol	AOO	21	1	10,5-42	NC	+/+	+/+
12	Imidazolidinyl urea	39236-46-9	Sol	DMF	24	1	12-48	NC	+/+	+/+
13	Methyl methacrylate	80-62-6	Liq	AOO	90	1	45-100	NC	+/+	+/+
14	Chlorobenzene	108-90-7	Liq	AOO	25	1	NA	NA	-/-	-/ (*)
15	Isopropanol	67-63-0	Liq	AOO	50	1	NA	NA	-/-	-/+

▼ M3

Number	Chemicals ⁽¹⁾	CAS No	Form	Veh ⁽²⁾	EC3 % ⁽³⁾	N ⁽⁴⁾	0,5x-2,0x EC3	Actual EC3 Range	LLNA vs GP	LLNA vs Human
16	Lactic acid	50-21-5	Liq	DMSO	25	1	NA	NA	-/-	-/ (*)
17	Methyl salicylate	119-36-8	Liq	AOO	20	9	NA	NA	-/-	-/-
18	Salicylic acid	69-72-7	Sol	AOO	25	1	NA	NA	-/-	-/-
Optional Substances to Demonstrate Improved Performance Relative to the LLNA										
19	Sodium lauryl sulphate	151-21-3	Sol	DMF	8,1	5	4,05-16,2	1,5-17,1	+/-	+/-
20	Ethylene glycol dimethacrylate	97-90-5	Liq	MEK	28	1	14-56	NC	+/-	+/+
21	Xylene	1330-20-7	Liq	AOO	95,8	1	47,9-100	NC	+/(**)	+/-
22	Nickel chloride	7718-54-9	Sol	DMSO	5	2	NA	NA	-/+	-/+

Abbreviations: AOO = acetone: olive oil (4:1, v/v); CAS No = Chemical Abstracts Service Number; DMF = *N,N*-dimethylformamide; DMSO = dimethyl sulfoxide; DNCB = 2,4-dinitrochlorobenzene; EC3 = estimated concentration needed to produce a stimulation index of 3; GP = guinea pig test result (*i.e.* B.6 or OECD Test Guideline 406) (13); HCA = hexyl cinnamic aldehyde; Liq = liquid; LLNA = murine local lymph node assay result (*i.e.* B.42 or OECD Test Guideline 429) (1); MEK = methyl ethyl ketone; NA = not applicable since stimulation index < 3; NC = not calculated since data was obtained from a single study; Sol = solid; Veh = test vehicle.

(*) Presumed to be a non-sensitiser in humans based on the fact that no clinical patch test results were located, it is not included as a patch test kit allergen, and no case reports of human sensitisation were located.

(**) GP data not available.

⁽¹⁾ Chemicals should be prepared daily unless stability data demonstrate the acceptability of storage.

⁽²⁾ Because of the potential impact of different vehicles on the performance of the LLNA, the recommended vehicle for each reference chemical should be used (24) (32).

⁽³⁾ Mean value where more than one EC3 value was available. For negative substances (*i.e.* with stimulation index < 3, the highest concentration tested is provided).

⁽⁴⁾ Number of LLNA studies from which data were obtained.

⁽⁵⁾ Commercially available as Kathon CG (CAS No 55965-84-9), which is a 3:1 mixture of CMI and MI. The relative concentrations of each component range from 1,1 % to 1,25 % (CMI) and 0,3 % to 0,45 % (MI). The inactive components are magnesium salts (21,5 % to 24 %) and copper nitrate (0,15 % to 0,17 %), with the remaining formulation 74 % to 77 % water. Kathon CG is readily available through Sigma-Aldrich and Rohm and Haas (now Dow Chemical Corporation).

▼ M3**III. Defined reliability and accuracy standards**

7. The accuracy of a similar or modified LLNA method should meet or exceed that of the LLNA PS when it is evaluated using the 18 minimum reference chemicals that should be used. The new or modified method should result in the correct classification based on a 'yes/no' decision. However, the new or modified method might not correctly classify all of the minimum reference chemicals that should be used. If, for example, one of the weak sensitizers were misclassified, a rationale for the misclassification and appropriate additional data (e.g. test results that provide correct classifications for other substances with physical, chemical, and sensitising properties similar to those of the misclassified reference chemical) could be considered to demonstrate equivalent performance. Under such circumstances, the validation status of the new or modified LLNA test method would be evaluated on a case-by-case basis.

Intra-laboratory reproducibility

8. To determine intra-laboratory reproducibility, a new or modified LLNA method should be assessed using a sensitising substance that is well characterised in the LLNA. Therefore, the LLNA PS are based on the variability of results from repeated tests of hexyl cinnamic aldehyde (HCA). To assess intra-laboratory reliability, threshold estimated concentration (EC_t) values for HCA should be derived on four separate occasions with at least one week between tests. Acceptable intra-laboratory reproducibility is indicated by a laboratory's ability to obtain, in each HCA test, EC_t values between 5 % and 20 %, which represents the range of 0,5-2,0 times the mean EC₃ specified for HCA (10 %) in the LLNA (see Table 1).

Inter-laboratory reproducibility

9. Inter-laboratory reproducibility of a new or modified LLNA method should be assessed using two sensitising substances that are well characterised in the LLNA. The LLNA PS are based on the variability of results from tests of HCA and 2,4-dinitrochlorobenzene (DNCB) in different laboratories. EC_t values should be derived independently from a single study conducted in at least three separate laboratories. To demonstrate acceptable inter-laboratory reproducibility, each laboratory should obtain EC_t values of 5 % to 20 % for HCA and 0,025 % to 0,1 % for DNCB, which represents the range of 0,5-2,0 times the mean EC₃ concentrations specified for HCA (10 %) and DNCB (0,05 %), respectively, in the LLNA (see Table 1).

▼ **M3***Appendix 2***Definitions**

Accuracy: The closeness of agreement between test method results and accepted reference values. It is a measure of test method performance and one aspect of relevance. The term is often used interchangeably with ‘concordance’ to mean the proportion of correct outcomes of a test method (14).

Benchmark substance: A sensitising or non-sensitising substance used as a standard for comparison to a test substance. A benchmark substance should have the following properties: (i) consistent and reliable source(s); (ii) structural and functional similarity to the class of substances being tested; (iii) known physicochemical characteristics; (iv) supporting data on known effects; and (v) known potency in the range of the desired response.

Estimated concentration threshold (EC_t): Estimated concentration of a test substance needed to produce a stimulation index that is indicative of a positive response.

Estimated concentration three (EC₃): Estimated concentration of a test substance needed to produce a stimulation index of three.

False negative: A test substance incorrectly identified as negative or non-active by a test method, when in fact it is positive or active.

False positive: A test substance incorrectly identified as positive or active by a test, when in fact it is negative or non-active.

Hazard: The potential for an adverse health or ecological effect. The adverse effect is manifested only if there is an exposure of sufficient level.

Inter-laboratory reproducibility: A measure of the extent to which different qualified laboratories, using the same protocol and testing the same test substances, can produce qualitatively and quantitatively similar results. Inter-laboratory reproducibility is determined during the pre-validation and validation processes, and indicates the extent to which a test can be successfully transferred between laboratories, also referred to as between-laboratory reproducibility (14).

Intra-laboratory reproducibility: A determination of the extent that qualified people within the same laboratory can successfully replicate results using a specific protocol at different times. Also referred to as within-laboratory reproducibility (14).

Me-too test: A colloquial expression for a test method that is structurally and functionally similar to a validated and accepted reference test method. Such a test method would be a candidate for catch-up validation. Interchangeably used with similar test method (14).

Outlier: An outlier is an observation that is markedly different from other values in a random sample from a population.

Performance standards (PS): Standards, based on a validated test method, that provide a basis for evaluating the comparability of a proposed test method that is functionally and mechanistically similar. Included are: (i) essential test method components; (ii) a minimum list of Reference Chemicals selected from among the chemicals used to demonstrate the acceptable performance of the validated test method; and (iii) the similar levels of accuracy and reliability, based on what was obtained for the validated test method, that the proposed test method should demonstrate when evaluated using the minimum list of Reference Chemicals (14).

Proprietary test method: A test method for which manufacture and distribution is restricted by patents, copyrights, trademarks, etc.

▼ M3

Quality assurance: A management process by which adherence to laboratory testing standards, requirements, and record keeping procedures, and the accuracy of data transfer, are assessed by individuals who are independent from those performing the testing.

Reference chemicals: Chemicals selected for use in the validation process, for which responses in the *in vitro* or *in vivo* reference test system or the species of interest are already known. These chemicals should be representative of the classes of chemicals for which the test method is expected to be used, and should represent the full range of responses that may be expected from the chemicals for which it may be used, from strong, to weak, to negative. Different sets of reference chemicals may be required for the different stages of the validation process, and for different test methods and test uses (14).

Relevance: Description of relationship of the test to the effect of interest and whether it is meaningful and useful for a particular purpose. It is the extent to which the test correctly measures or predicts the biological effect of interest. Relevance incorporates consideration of the accuracy (concordance) of a test method (14).

Reliability: Measures of the extent that a test method can be performed reproducibly within and between laboratories over time, when performed using the same protocol. It is assessed by calculating intra- and inter-laboratory reproducibility (14).

Skin sensitisation: An immunological process that results when a susceptible individual is exposed topically to an inducing chemical allergen, which provokes a cutaneous immune response that can lead to the development of contact sensitisation.

Stimulation Index (SI): A value calculated to assess the skin sensitisation potential of a test substance that is the ratio of the proliferation in treated groups to that in the concurrent vehicle control group.

Test substance (also referred to as test chemical): Any substance or mixture tested using this TM.

Validated test method: A test method for which validation studies have been completed to determine the relevance (including accuracy) and reliability for a specific purpose. It is important to note that a validated test method may not have sufficient performance in terms of accuracy and reliability to be found acceptable for the proposed purpose (14).

▼B**B.43. NEUROTOXICITY STUDY IN RODENTS****1. METHOD**

This method is equivalent of OECD TG 424 (1997).

This test method has been designed to obtain the information necessary to confirm or to further characterise the potential neurotoxicity of chemicals in adult animals. It can either be combined with existing test methods for repeated dose toxicity studies or to be carried out as a separate study. It is recommended that the OECD Guidance Document on Neurotoxicity Testing Strategies and Methods (1) be consulted to assist in the design of studies based on this test method. This is particularly important when modifications of the observations and test procedures as recommended for routine use of this method are considered. The guidance document has been prepared to facilitate the selection of other test procedures for use in specific circumstances.

The assessment of developmental neurotoxicity is not the subject of this method.

1.1. INTRODUCTION

In the assessment and evaluation of the toxic characteristics of chemicals, it is important to consider the potential for neurotoxic effects. Already the test method for repeated dose systemic toxicity includes observations that screen for potential neurotoxicity. This test method can be used to design a study to obtain further information on, or to confirm, the neurotoxic effects observed in the repeated dose systemic toxicity studies. However, consideration of the potential neurotoxicity of certain classes of chemicals may suggest that they may be more appropriately evaluated using this Method without prior indications of the potential neurotoxicity from repeated dose systemic toxicity studies. Such considerations include, for example:

- observation of neurological signs or neuropathological lesions in toxicity studies other than repeated dose systemic toxicity studies, or

- structural relationship or other information linking them to known neurotoxicants.

In addition there may be other instances when use of this test method is appropriate; for further details see (1).

This method has been developed so that it can be tailored to meet particular needs to confirm the specific histopathological and behavioural neurotoxicity of a chemical as well as provide a characterisation and quantification of the neurotoxic responses.

▼ B

In the past, neurotoxicity was equated with neuropathy involving neuropathological lesions or neurological dysfunctions, such as seizure, paralysis or tremor. Although neuropathy is an important manifestation of neurotoxicity, it is now clear that there are many other signs of nervous system toxicity (e.g. loss of motor co-ordination, sensory deficits, learning and memory dysfunctions) that may not be reflected in neuropathy or other types of studies.

This neurotoxicity test method is designed to detect major neurobehavioural and neuropathological effects in adult rodents. While behavioural effects, even in the absence of morphological changes, can reflect an adverse impact on the organism, not all behavioural changes are specific to the nervous system. Therefore, any changes observed should be evaluated in conjunction with correlative histopathological, haematological or biochemical data as well as data on other types of systemic toxicity. The testing called for in this method to provide a characterisation and quantification of the neurotoxic responses includes specific histopathological and behavioural procedures that may be further supported by electrophysiological and/or biochemical investigations (1)(2)(3)(4).

Neurotoxicants may act on a number of targets within the nervous system and by a variety of mechanisms. Since no single array of tests is capable of thoroughly assessing the neurotoxic potential of all substances, it may be necessary to utilise other *in vivo* or *in vitro* tests specific to the type of neurotoxicity observed or anticipated.

This test method can also be used, in conjunction with the guidance set out in the OECD Guidance Document on Neurotoxicity Testing Strategies and Methods (1) to design studies intended to further characterise or increase the sensitivity of the dose-response quantification in order to better estimate a no-observed-adverse effect level or to substantiate known or suspected hazards of the chemical. For example, studies may be designed to identify and evaluate the neurotoxic mechanism(s) or supplement the data already available from the use of basic neurobehavioural and neuropathological observation procedures. Such studies need not replicate data that would be generated from the use of the standard procedures recommended in this Method, if such data are already available and are not considered necessary for the interpretation of the results of the study.

This neurotoxicity study, when used alone or in combination, provides information that can:

- identify whether the nervous system is permanently or reversibly affected by the chemical tested;
- contribute to the characterisation of the nervous system alterations associated with exposure to the chemical, and to understanding the underlying mechanism.

▼ B

— determine dose-and time-response relationships in order to estimate a no-observed-adverse-effect level (which can be used to establish safety criteria for the chemical).

This test method uses oral administration of the test substance. Other routes of administration (e.g. dermal or inhalation) may be more appropriate, and may require modification of the procedures recommended. Considerations of the choice of the route of administration depend on the human exposure profile and available toxicological or kinetic information.

1.2. DEFINITIONS

Adverse effect: is any treatment-related alteration from baseline that diminishes an organism's ability to survive, reproduce or adapt to the environment.

Dose: is the amount of test substance administered. Dose is expressed as weight (g, mg) or as weight of test substance per unit weight of the test animal (e.g. mg/Kg), or as constant dietary concentrations (ppm).

Dosage: is a general term comprising of dose, its frequency and the duration of dosing.

Neurotoxicity: is an adverse change in the structure or function of the nervous system that results from exposure to a chemical, biological or physical agent.

Neurotoxicant: is any chemical, biological or physical agent having the potential to cause neurotoxicity.

NOAEL: is the abbreviation for no-observed-adverse effect level and is the highest dose level where no adverse treatment-related findings are observed.

1.3. PRINCIPLE OF THE TEST METHOD

The test chemical is administered by the oral route across a range of doses to several groups of laboratory rodents. Repeated doses are normally required, and the dosing regimen may be 28 days, subchronic (90 days) or chronic (1 year or longer). The procedures set out in this test method may also be used for an acute neurotoxicity study. The animals are tested to allow the detection or the characterisation of behavioural and/or neurological abnormalities. A range of behaviours that could be affected by neurotoxicants is assessed during each observation period. At the end of the test, a subset of animals of each sex from each group are perfused *in situ* and sections of the brain, spinal cord, and peripheral nerves are prepared and examined.

When the study is conducted as a stand-alone study to screen for neurotoxicity or to characterise neurotoxic effects, the animals in each group not used for perfusion and subsequent histopathology (see Table 1) can be used for specific neurobehavioural, neuropathological, neurochemical or electrophysiological procedures that may supplement the data obtained from the standard examinations required by this method (1). These supplemental procedures can be particularly useful when empirical observations or anticipated effects indicate a specific type or target of a chemical's neurotoxicity. Alternatively, the remaining animals can be used for evaluations such as those called for in test methods for repeated dose toxicity studies in rodents.

▼ B

When the procedures of this test method are combined with those of other test methods, a sufficient number of animals is needed to satisfy the requirements for the observations of both studies.

1.4. DESCRIPTION OF THE TEST METHOD**1.4.1. Selection of animal species**

The preferred rodent species is the rat, although other rodent species, with justification, may be used. Commonly used laboratory strains of young adult healthy animals should be employed. The females should be nulliparous and non-pregnant. Dosing should normally begin as soon as possible after weaning, preferably not later than when animals are six weeks, and, in any case, before the animals are nine weeks age. However, when this study is combined with other studies this age requirement may need adjustment. At the commencement of the study the weight variation of animals used should not exceed $\pm 20\%$ of the mean weight of each sex. Where a repeated dose study of short duration is conducted as a preliminary to a long term study, animals from the same strain and source should be used in both studies.

1.4.2. Housing and feeding conditions

The temperature in the experimental animal room should be 22 °C (± 3 °C). Although the relative humidity should be at least 30 % and preferably not exceed 70 % other than during room cleaning, the aim should be 50-60 %. Lighting should be artificial, the sequence being 12 hours light, 12 hours dark. Loud intermittent noise should be kept to a minimum. For feeding, conventional laboratory diets may be used with an unlimited supply of drinking water. The choice of diet may be influenced by the need to ensure a suitable admixture of a test substance when administered by this method. Animals may be housed individually, or be caged in small groups of the same sex.

1.4.3. Preparation of animals

Healthy young animals are randomly assigned to the treatment and control groups. Cages should be arranged in such a way that possible effects due to cage placement are minimised. The animals are identified uniquely and kept in their cages for at least (5) five days prior the start of the study to allow for acclimatisation to the laboratory conditions.

1.4.4. Route of administration and preparation of doses

This test method specifically addresses the oral administration of the test substance. Oral administration may be by gavage, in the diet, in drinking water or by capsules. Other routes of administration (e.g. dermal or inhalation) can be used but may require modification of the procedures recommended. Considerations of the choice of the route of administration depend on the human exposure profile and available toxicological or kinetic information. The rationale for choosing the route of administration as well as resulting modifications to the procedures of this test method should be indicated.

▼ B

Where necessary, the test substance may be dissolved or suspended in a suitable vehicle. It is recommended that the use of an aqueous solution/suspension be considered first, followed by consideration of a solution/suspension in oil (e.g. corn oil) and then by possible solution/suspension in other vehicle. The toxic characteristics of the vehicle must be known. In addition, consideration should be given to the following characteristics of the vehicle: effects of the vehicle on absorption, distribution, metabolism, or retention of the test substance which may alter its toxic characteristics; and effects on the food or water consumption or the nutritional status of the animals.

1.5. PROCEDURES**1.5.1. Number and sex animals**

When the study is conducted as a separate study, at least 20 animals (10 females and 10 males) should be used in each dose and control group for the evaluation of detailed clinical and functional observations. At least five males and five females, selected from these 10 males and 10 females, should be perfused *in situ* and used for detailed neurohistopathology at the end of the study. In cases where only a limited number of animals in a given dose group are observed for signs of neurotoxic effects, consideration should be given to the inclusion of these animals in those selected for perfusion. When the study is conducted in combination with a repeated dose toxicity study, adequate numbers of animals should be used to meet the objectives of both studies. The minimum numbers of animals per group for various combinations of studies are given in Table 1. If interim kills or recovery groups for observation of reversibility, persistence or delayed occurrence of toxic effects post treatment are planned or when supplemental observations are considered, then the number of animals should be increased to ensure that the number of animals required for observation and histopathology are available.

1.5.2. Treatment and control group

At least three dose groups and a control group should generally be used, but if from the assessment of other data, no effects would be expected at a repeated dose of 1 000 mg/kg body weight/day, a limit test may be performed. If there are no suitable data available, a range finding study may be performed to aid in the determination of the doses to be used. Except for treatment with the test substance, animals in the control group should be handled in an identical manner to the test group subjects. If a vehicle is used in administering the test substance, the control group should receive the vehicle at the highest volume used.

1.5.3. Reliability check

The laboratory performing the study should present data demonstrating its capability to carry out the study and the sensitivity of the procedures used. Such data should provide evidence of the ability to detect and quantify, as appropriate, changes in the different end points recommended for observation, such as autonomic signs, sensory reactivity, limb grip strength and motor activity. Information on chemicals that cause different types of neurotoxic responses and could be used as positive control substances can be found in references 2 to 9. Historical data may be used if the essential aspects of the experimental procedures remain the same. Periodic updating of historical data is recommended. New data that demonstrate the continuing sensitivity of the procedures should be developed when some essential element of the conduct of the test or procedures has been changed by the performing laboratory.

▼ B**1.5.4. Dose selection**

Dose levels should be selected by taking into account any previously observed toxicity and kinetic data available for the test compound or related materials. The highest dose level should be chosen with the aim of inducing neurotoxic effects or clear systemic toxic effects. Thereafter, a descending sequence of dose levels should be selected with a view to demonstrating any dose-related response and no-observed-adverse effect (NOAEL) at the lowest dose level. In principle, dose levels should be set so that primary toxic effects on the nervous system can be distinguished from effects related to systemic toxicity. Two to three intervals are frequently optimum and addition of a fourth test group is often preferable to using very large intervals (e.g. more than a factor of 10) between dosages. Where there is a reasonable estimation of human exposure this should also be taken into account.

1.5.5. Limit test

If a study at one dose level of at least 1 000 mg/kg body weight/day, using the procedures described, produces no observable neurotoxic effects and if toxicity would not be expected based upon data from structurally related compounds, then a full study using three dose levels may not be considered necessary. Expected human exposure may indicate the need for a higher oral dose level to be used in the limit test. For other types of administration, such as inhalation or dermal application, the physical chemical properties of the test substance often may dictate the maximum attainable level of exposure. For the conduct of an oral acute study, the dose for a limit test should be at least 2 000 mg/kg.

1.5.6. Administration of doses

The animals are dosed with the test substance daily, seven days each week, for a period at least 28 days; use of a five-day dosing regime or a shorter exposure period needs to be justified. When the test substance is administered by gavage, this should be done in a single dose using a stomach tube or a suitable intubation cannula. The maximum volume of a liquid that can be administered at one time depends on the size of the test animals. The volume should not exceed 1 ml/100 g body weight. However in the case of aqueous solutions, the use of up to 2 ml/100 g body weight can be considered. Except for irritating or corrosive substances, which will normally reveal exacerbated effects with higher concentrations, variability in test volume should be minimised by adjusting the concentration to ensure a constant volume at all dose levels.

For substances administered via the diet or drinking water, it is important to ensure that the quantities of the test substance involved do not interfere with normal nutrition or water balance. When the test substance is administered in the diet either a constant dietary concentration (ppm) or a constant dose level in terms of the animals' body weight may be used; the alternative used must be specified. For a substance administered by gavage, the dose should be given at similar times each day, and adjusted as necessary to maintain a constant dose level in terms of animal body weight. Where a repeat dose study is used as a preliminary to a long term study, a similar diet should be used in both studies. For acute studies, if a single dose is not possible, the dose may be given in smaller fractions over a period not exceeding 24 hours.

▼B

1.6. OBSERVATION

1.6.1. **Frequency of observations and tests**

In repeated dose studies, the observation period should cover the dosage period. In acute studies, 14-day post-treatment period should be observed. For animals in satellite groups which are kept without exposure during a post-treatment period, observations should cover this period as well.

Observations should be made with sufficient frequency to maximise the probability of detection of any behavioural and/or neurological abnormalities. Observations should be made preferably at the same times each day with consideration given to the peak period of anticipated effects after dosing. The frequency of clinical observations and functional tests is summarised in Table 2. If kinetic or other data generated from previous studies indicates the need to use different time points for observations, tests or post-observation periods, an alternative schedule should be adopted in order to achieve maximum information. The rationale for changes to the schedule should be provided.

1.6.1.1. *Observations of general health condition and mortality/morbidity*

All animals should be carefully observed at least once daily with respect to their health condition as well as at least twice daily for morbidity and mortality.

1.6.1.2. *Detailed clinical observations*

Detailed clinical observations should be made on all animals selected for this purpose (see Table 1) once before the first exposure (to allow for within-subject comparisons) and at different intervals thereafter, dependant on the duration of the study (see Table 2). Detailed clinical observations on satellite recovery groups should be made at the end of the recovery period. Detailed clinical observations should be made outside the home cage in a standard arena. They should be carefully recorded using scoring systems that include criteria or scoring scales for each measurement in the observations. The criteria or scales used should be explicitly defined by the testing laboratory. Effort should be made to ensure that variations in the test conditions are minimal (not systematically related to treatment) and that observations are conducted by trained observers unaware of the actual treatment.

It is recommended that the observations be carried out in a structured fashion in which well-defined criteria (including the definition of the normal 'range') are systematically applied to each animal at each observation time. The 'normal range' should be adequately documented. All observed signs should be recorded. Whenever feasible, the magnitude of the observed signs should also be recorded. Clinical observations should include, but not be limited to, changes in skin, fur, eyes, mucous membranes, occurrence of secretions and excretions and autonomic activity (e.g. lacrimation, piloerection, pupil size, unusual respiratory pattern and/or mouth breathing, any unusual signs of urination or defecation, and discoloured urine).

▼B

Any unusual responses with respect to body position, activity level (e.g. decreased or increased exploration of the standard arena) and co-ordination of movement should also be noted. Changes in gait (e.g. waddling, ataxia), posture (e.g. hunched-back) and reactivity to handling, placing or other environmental stimuli, as well as the presence of clonic or tonic movements, convulsions or tremors, stereotypes (e.g. excessive grooming, unusual head movements, repetitive circling) or bizarre behaviour (e.g. biting or excessive licking, self mutilation, walking backwards, vocalisation) or aggression should be recorded.

1.6.1.3. *Functional tests*

Similar to the detailed clinical observations, functional tests should also be conducted once prior to exposure and frequently thereafter in all animals selected for this purpose (see Table 1). The frequency of functional testing is also dependent on the study duration (see Table 2). In addition to the observation periods as set out in Table 2, functional observations on satellite recovery groups should also be made as close as possible to the terminal kill. Functional tests should include sensory reactivity to stimuli of different modalities (e.g. auditory, visual and proprioceptive stimuli (5)(6)(7)), assessment of limb grip strength (8) and assessment of motor activity (9). Motor activity should be measured with an automated device capable of detecting both decreases and increases in activity. If another defined system is used it should be quantitative and its sensitivity and reliability should be demonstrated. Each device should be tested to ensure reliability across time and consistency between devices. Further details of the procedures that can be followed are given in the respective references. If there are no data (e.g. structure-activity, epidemiological data, other toxicology studies) to indicate the potential neurotoxic effects, the inclusion of more specialised tests of sensory and motor function or learning and memory to examine these possible effects in greater details should be considered. More information on more specialised tests and their use is provided in (1).

Exceptionally, animals that reveal signs of toxicity to an extent that would significantly interfere with the functional test may be omitted from that test. Justification for the elimination of animals from a functional test should be provided.

1.6.2. *Body weight and food/water consumption*

For studies up to 90 days duration, all animals should be weighed at least once a week and measurements should be made of food consumption (water consumption, when the test substance is administered by that medium) at least weekly. For long term studies, all animals should be weighed at least once at week for the first 13 weeks and at least once every four weeks thereafter. Measurements should be made of food consumption (water consumption, when the test substance is administered by that medium) at least weekly for the first 13 weeks and then at approximately three-month intervals unless the health status or body weight changes dictate otherwise.

▼ B**1.6.3. Ophthalmology**

For studies longer than 28 days duration, ophthalmologic examination, using an ophthalmoscope or an equivalent suitable instrument, should be made prior to the administration of the test substance and at the termination of the study, preferably on all animals, but at least on animals in the high dose and control groups. If changes in the eyes are detected or, if clinical signs indicate the need, all animals should be examined. For long term studies, an ophthalmologic examination should also be carried out at 13 weeks. Ophthalmologic examinations need not to be conducted if this data is already available from others studies of similar duration and at similar dose levels.

1.6.4. Haematology and clinical biochemistry

When the neurotoxicity study is carried out in combination with a repeated dose systemic toxicity study, haematological examinations and clinical biochemistry determinations should be carried out as set out in the respective method of the systemic toxicity study. Collection of samples should be carried out in such a way that any potential effects on neurobehaviour are minimised.

1.6.5. Histopathology

The neuropathological examination should be designed to complement and extend the observations made during the *in vivo* phase of the study. Tissues from at least five animals/sex/group (see Table 1 and next paragraph) should be fixed *in situ*, using generally recognised perfusion and fixation techniques (see reference 3, chapter 5 and reference 4, chapter 50). Any observable gross changes should be recorded. When the study is conducted as a stand-alone study screen for neurotoxicity or to characterise neurotoxic effects, the remainder of the animals may be used either for specific neurobehavioural (10)(11), neuropathological (10)(11)(12)(13), neurochemical (10)(11)(14)(15) or electrophysiological (10)(11)(16)(17) procedures that may supplement the procedures and examinations described here, or to increase the number of subjects examined for histopathology. These supplementary procedures are of particular use when empirical observations or anticipated effects indicate a specific type or target of neurotoxicity (2)(3). Alternatively, the remainder of the animals can also be used for routine pathological evaluations as described in Method for repeated dose studies.

A general staining procedure, such as haematoxylin and eosin (H&E), should be performed on all tissue specimens embedded in paraffin and microscopic examination should be carried out. If signs of peripheral neuropathy are observed or suspected, plastic-embedded samples of peripheral nerve tissue should be examined. Clinical signs may also suggest additional sites for examination or the use of special staining procedures. Guidance on additional sites to be examined can be found in (3)(4). Appropriate special stains to demonstrate specific types of pathological change may also be helpful (18).

▼ B

Representative sections of the central and peripheral nervous system should be examined histologically (see reference 3, chapter 5 and reference 4, chapter 50). The areas examined should normally include: the forebrain, the centre of the cerebrum, including a section through the hippocampus, the midbrain, the cerebellum, the pons, the medulla oblongata, the eye with optic nerve and retina, the spinal cord at the cervical and lumbar swellings, the dorsal root ganglia, the dorsal and ventral root fibres, the proximal sciatic nerve, the proximal tibial nerve (at the knee) and the tibial nerve calf muscle branches. The spinal cord and peripheral nerve sections should include both cross or transverse and longitudinal sections. Attention should be given to the vasculature of the nervous system. A sample of skeletal muscle, particularly calf muscle, should also be examined. Special attention should be paid to sites with cellular and fibre structure and pattern in the CNS and PNS known to be particularly affected by neurotoxicants.

Guidance on neuropathological alterations that typically result from toxicant exposure can be found in the references (3)(4). A stepwise examination of tissue samples is recommended in which sections from the high dose group are first compared with those of the control group. If no neuropathological alterations are observed in the samples from these groups, subsequent analysis is not required. If neuropathological alterations are observed in the high dose group, sample from each of the potentially affected tissues from the intermediate and low dose groups should then be coded and examined sequentially.

If any evidence of neuropathological alterations is found in the qualitative examination, then a second examination should be performed on all regions of the nervous system showing these alterations. Sections from all dose groups from each of the potentially affected regions should be coded and examined at random without knowledge of the code. The frequency and severity of each lesion should be recorded. After all regions from all dose groups have been rated, the code can be broken and statistical analysis performed to evaluate dose-response relationships. Examples of different degrees of severity of each lesion should be described.

The neuropathological findings should be evaluated in the context of behavioural observations and measurements, as well as other data from preceding and concurrent systemic toxicity studies of the test substance.

2. DATA**2.1. TREATMENT OF RESULTS**

Individual data should be provided. Additionally, all data should be summarised in tabular form showing for each test or control group the number of animals at the start of the test, the number of animals found dead during the test or killed for humane reasons and the time of any death or humane kill, the number showing signs of toxicity, a description of the signs of toxicity observed, including time of onset, duration, type and severity of any toxic effects, the number of animals showing lesions, including the type and severity of the lesion(s).

▼ B

2.2. EVALUATION AND INTERPRETATION OF RESULTS

The findings of the study should be evaluated in terms of the incidence, severity and correlation of neurobehavioural and neuropathological effects (neurochemical or electrophysiological effects as well if supplementary examinations are included) and any other adverse effects observed. When possible, numerical results should be evaluated by an appropriate and generally acceptable statistical method. The statistical methods should be selected during the design of the study.

3. **REPORTING**

3.1. TEST REPORT

the test report must include the following information:

Test substance:

— physical nature (including isomerism, purity and physico-chemical properties),

— identification data.

Vehicle (if appropriate):

— justification for choice of vehicle.

Test animals:

— species/strain used,

— number, age and sex of animals,

— source, housing conditions, acclimatisation, diet, etc,

— individual weights of animals at the start of the test.

Test conditions:

— details of test substance formulation/diet preparation, achieved concentration, stability and homogeneity of the preparation,

— specification of the doses administered, including details of the vehicle, volume and physical form of the material administered,

— details of the administration of the test substance,

— rationale for dose levels selected,

— rationale for the route and duration of the exposure,

— conversion from diet/drinking water test substance concentration (ppm) to the actual dose (mg/kg body weight/day), if applicable,

— details of the food and water quality.

Observation and test procedures:

— details of the assignment of animals in each group to the perfusion subgroups,

— details of scoring systems, including criteria and scoring scales for each measurement in the detailed clinical observations,

▼ B

- details on the functional tests for sensory reactivity to stimuli of different modalities (e.g. auditory, visual and proprioceptive), for assessment of limb grip strength, for motor activity assessment (including details of automated devices for detecting activity), and other procedures used,
- details of ophthalmologic examinations and, if appropriate, haematological examinations and clinical biochemistry tests with relevant base-line values,
- details for specific neurobehavioural, neuropathological, neurochemical or electrophysiological procedures.

Results:

- body weight/body weight changes including body weight at kill,
- food consumption and water consumption, as appropriate,
- toxic response data by sex and dose level, including signs of toxicity or mortality,
- nature, severity and duration (time of onset and subsequent course) of the detailed clinical observations (whether reversible or not),
- a detailed description of all functional test results,
- necropsy findings,
- a detailed description of all neurobehavioural, neuropathological, and neurochemical or electrophysiological findings, if available,
- absorption and metabolism data, if available,
- statistical treatment of results, where appropriate.

Discussion of results:

- dose response information;
- relationship of any other toxic effects to a conclusion about the neurotoxic potential of the test chemical;
- no-observed-adverse effect level.

Conclusions:

- a specific statement of the overall neurotoxicity of the test chemical is encouraged.

4.

REFERENCES

- (1) OECD Guidance Document on Neurotoxicity Testing Strategies and Test Methods. OECD, Paris, In Preparation.
- (2) Test Guideline for a Developmental Neurotoxicity Study, OECD Guidelines for the Testing of Chemicals. In preparation.
- (3) World Health Organisation (WHO) (1986) Environmental Health Criteria document 60: Principles and Methods for the Assessment of Neurotoxicity associated with Exposure to Chemicals.
- (4) Spencer, P.S. and Schaumburg, H.H. (1980) Experimental and Clinical Neurotoxicology. Eds. Spencer, P.S. and Schaumburg, H.H. eds. Williams and Wilkins, Baltimore/London.

▼B

- (5) Tupper, D.E. and Wallace, R.B., (1980) Utility of the Neurological Examination in Rats. *Acta Neurobiol. Exp.*, 40, p. 999-1003.
- (6) Gad, S.C., (1982) A Neuromuscular Screen for Use in Industrial Toxicology. *J. Toxicol. Environ. Health*, 9, p. 691-704.
- (7) Moser, V.C., McDaniel, K.M. and Phillips, P.M., (1991) Rat Strain and Stock Comparisons Using a Functional Observational Battery: Baseline Values and Effects of amitraz. *Toxic. Appl. Pharmacol.*, 108, p. 267-283.
- (8) Meyer, O.A., Tilson, H.A., Byrd, W.C. and Riley, M.T., (1979) A Method for the Routine Assessment of Fore- and Hind- limb Grip Strength of Rats and Mice. *Neurobehav. Toxicol.*, 1, p. 233-236.
- (9) Crofton, K.M., Haward, J.L., Moser, V.C., Gill, M.W., Reirer, L.W., Tilson, H.A. and MacPhail, R.C. (1991) Interlaboratory Comparison of Motor Activity Experiments: Implication for Neurotoxicological Assessments. *Neurotoxicol. Teratol.*, 13, p. 599-609.
- (10) Tilson, H.A., and Mitchell, C.L. eds., (1992) *Neurotoxicology Target Organ Toxicology Series*. Raven Press, New York.
- (11) Chang, L.W., ed., (1995) *Principles of Neurotoxicology*. Marcel Dekker, New York.
- (12) Broxup, B., (1991) Neuopathology as a screen for Neurotoxicity Assessment. *J. Amer. Coll. Toxicol.*, 10, p. 689-695.
- (13) Moser, V.C., Anthony, D.C., Sette, W.F. and MacPhail, R.C., (1992) Comparison of Subchronic Neurotoxicity of 2-Hydroxyethyl Acrylate and Acrylamide in Rats. *Fund. Appl. Toxicol.*, 18, p. 343-352.
- (14) O'Callaghan, J.P. (1988). Neurotypic and Gliotypic Proteins as Biochemical Markers of Neurotoxicity. *Eurotoxicol. Teratol.*, 10, p. 445-452.
- (15) O'Callaghan J.P. and Miller, D.B., (1988) Acute Exposure of the Neonatal Rat to Triethyltin Results in Persistent Changes in Neurotypic and Gliotypic Proteins. *J. Pharmacol. Exp. Ther.*, 244, p. 368-378.
- (16) Fox, D.A., Lowndes, H.E. and Birkamper, G.G., (1982) Electrophysiological Techniques in Neurotoxicology. In: *Nervous System Toxicology*. Mitchell, C.L. ed. Raven Press, New York, p. 299-335.
- (17) Johnson, B.L., (1980) Electrophysiological Methods in neurotoxicity Testing. In: *Experimental and Clinical Neurotoxicology*. Spencer, P.S. and Schaumburg, H.H. eds., Williams and Wilkins Co., Baltimore/London, p. 726-742.
- (18) Bancroft, J.D. and Steven A., (1990) *Theory and Practice of Histological Techniques*. Chapter 17, *Neuropathological Techniques*. Lowe, James and Cox, Gordon eds. Churchill Livingstone.

▼B

Table 1

Minimum numbers of animals needed per group when the neurotoxicity study is conducted separately or in combination with studies

	NEUROTOXICITY STUDY CONDUCTED AS:			
	Separate study	Combined study with the 28-day study	Combined study with the 90-day study	Combined study with the chronic toxicity study
Total number of animals per group	10 males and 10 females	10 males and 10 females	15 males and 15 females	25 males and 25 females
Number of animals selected for functional testing including detailed clinical observations	10 males and 10 females	10 males and 10 females	10 males and 10 females	10 males and 10 females
Number of animals selected per perfusion <i>in situ</i> and neurohistopathology	5 males and 5 females	5 males and 5 females	5 males and 5 females	5 males and 5 females
Number of animals selected for repeated dose/subchronic/chronic toxicity observations, haematology, clinical biochemistry, histopathology, etc. as indicate in the respective <i>Guidelines</i>		5 males and 5 females	10 males † and 10 females †	20 males † and 20 females †
Supplemental observations, as appropriate	5 males and 5 females			

† Includes five animals selected for functional testing and detailed clinical observations as part of the neurotoxicity study.

▼B

Table 2

Frequency of clinical observation and functional tests

Type of observations		Study duration			
		Acute	28-day	90-day	Chronic
In all animals	General health condition	daily	daily	daily	daily
	Mortality/morbidity	Twice daily	Twice daily	Twice daily	Twice daily
In animals selected for functional observations	Detailed clinical observations	— prior to first exposure — within 8 hours of dosing at estimate time of peak effect — at day 7 and 14 after dosing	— prior to first exposure — once weekly thereafter	— prior to first exposure — once during the first or second week of exposure — monthly thereafter	— prior to first exposure — once at the end of the first month of exposure — every three months thereafter
	Functional tests	— prior to first exposure — within 8 hours of dosing at estimate time of peak effect — at day 7 and 14 after dosing	— prior to first exposure — during the fourth week of treatment as close as possible to the end of the exposure period	— prior to first exposure — once during the first or second week of exposure — monthly thereafter	— prior to first exposure — once at the end of the first month of exposure — every three months thereafter

▼B**B.44. SKIN ABSORPTION: *IN VIVO* METHOD****1. METHOD**

This testing method is equivalent to the OECD TG 427 (2004).

1.1. INTRODUCTION

Exposure to many chemicals occurs mainly *via* the skin whilst the majority of toxicological studies performed in laboratory animals use the oral route of administration. The *in vivo* percutaneous absorption study set out in this guideline provides the linkage necessary to extrapolate from oral studies when making safety assessments following dermal exposure.

A substance must cross a large number of cell layers of the skin before it can reach the circulation. The rate-determining layer for most substances is the *stratum corneum* consisting of dead cells. Permeability through the skin depends both on the lipophilicity of the chemical and the thickness of the outer layer of epidermis, as well on factors such as molecular weight and concentration of the substance. In general, the skin of rats and rabbits is more permeable than that of humans, whereas the skin permeability of guinea pigs and monkeys is more similar to that of humans.

The methods for measuring percutaneous absorption can be divided into two categories; *in vivo* and *in vitro*. The *in vivo* method is capable of providing good information, in various laboratory species, on skin absorption. More recently *in vitro* methods have been developed. These utilise transport across full or partial thickness animal or human skin to a fluid reservoir. The *in vitro* method is described in a separate testing method (1). It is recommended that the OECD Guidance Document for the Conduct of Skin Absorption Studies (2) be consulted to assist in the selection of the most appropriate method in the given situation, as it provides more details on the suitability of both *in vivo* and *in vitro* methods.

The *in vivo* method, described in this method, allows the determination of the penetration of the test substance through the skin into the systemic compartment. The technique has been widely used for many years (3)(4)(5)(6)(7). Although *in vitro* percutaneous absorption studies may in many cases be appropriate there may be situations in which only an *in vivo* study can provide the necessary data.

Advantages of the *in vivo* method are that it uses a physiologically and metabolically intact system, uses a species common to many toxicity studies and can be modified for use with other species. The disadvantages are the use of live animals, the need for radiolabelled material to facilitate reliable results, difficulties in determining the early absorption phase and the differences in permeability of the preferred species (rat) and human skin. Animal skin is generally more permeable and therefore may overestimate human percutaneous absorption (6)(8)(9). Caustic/corrosive substances should not be tested in live animals.

▼ B

1.2. DEFINITIONS

Unabsorbed dose: represents that washed from the skin surface after exposure and any present on the non-occlusive cover, including any dose shown to volatilise from the skin during exposure.

Absorbed dose (*in vivo*): comprises that present in urine, cage wash, faeces, expired air (if measured), blood, tissues (if collected) and the remaining carcass, following removal of application site skin.

Absorbable dose: represents that present on or in the skin following washing.

1.3. PRINCIPLE OF THE TEST METHOD

The test substance, preferably radiolabelled, is applied to the clipped skin of animals at one or more appropriate dose levels in the form of a representative in-use preparation. The test preparation is allowed to remain in contact with the skin for a fixed period of time under a suitable cover (non-occlusive, semi-occlusive, or occlusive) to prevent ingestion of the test preparation. At the end of the exposure time the cover is removed and the skin is cleaned with an appropriate cleansing agent, the cover and the cleansing materials are retained for analysis and a fresh cover applied. The animals are housed prior to, during and after the exposure period in individual metabolism cages and the excreta and expired air over these periods are collected for analysis. The collection of expired air can be omitted when there is sufficient information that little or no volatile radioactive metabolite is formed. Each study will normally involve several groups of animals that will be exposed to the test preparation. One group will be killed at the end of the exposure period. Other groups will be killed at scheduled time intervals thereafter (2). At the end of the sampling time the remaining animals are killed, blood is collected for analysis, the application site removed for analysis and the carcass is analysed for any unexcreted material. The samples are assayed by appropriate means and the degree of percutaneous absorption is estimated (6)(8)(9).

1.4. DESCRIPTION OF THE METHOD

1.4.1. Selection of animal species

The rat is the most commonly used species, but hairless strains and species having skin absorption rates more similar to those of human, can also be used (3)(6)(7)(8)(9). Young adult healthy animals of a single sex (with males as the default sex) of commonly used laboratory strains should be employed. At the commencement of the study, the weight variation of animals used should not exceed $\pm 20\%$ of the mean weight. As an example, male rats of 200 g – 250 g are suitable, particularly in the upper half of this range.

▼B**1.4.2. Number and sex of animals**

A group of at least four animals of one sex should be used for each test preparation and each scheduled termination time. Each group of animals will be killed after different time intervals, for example at the end of the exposure period (typically 6 or 24 hours) and subsequent occasions (e.g. 48 and 72 hours). If there are data available that demonstrate substantial differences in dermal toxicity between males and females, the more sensitive sex should be chosen. If there are no such data, then either gender can be used.

1.4.3. Housing and feeding conditions

The temperature in the experimental animal room should be 22 °C (± 3 °C). Although the relative humidity should be at least 30 % and preferably not exceed 70 % other than during room cleaning, the aim should be 50-60 %. Lighting should be artificial, the sequence being 12 hours light, 12 hours dark. For feeding, conventional laboratory diets may be used and should be freely available together with an unlimited supply of drinking water. During the study, and preferably also during the acclimatisation, the animals are individually housed in metabolism cages. Since food and water spillage would compromise the results, the probability of such events should be minimised.

1.4.4. Preparation of animals

The animals are marked to permit individual identification and kept in their cages for at least five days prior to the start of the study to allow for acclimatisation to the laboratory conditions.

Following the acclimatisation period, and approximately 24 hours prior to dosing, each animal will have an area of skin in the region of the shoulders and the back clipped. The permeation properties of damaged skin are different from intact skin and care should be taken to avoid abrading the skin. Following the clipping and approximately 24 hours before the test substance is applied to the skin, (See Section 1.4.7) the skin surface should be wiped with acetone to remove sebum. An additional soap and water wash is not recommended because any soap residue might promote test substance absorption. The area must be large enough to allow reliable calculation of the absorbed amount of test chemical per cm² skin, preferably at least 10 cm². This area is practicable with rats of 200-250 g bodyweight. After preparation, the animals are returned to metabolism cages.

1.4.5. Test substance

The test substance is the entity whose penetration characteristics are to be studied. Ideally, the test substance should be radiolabelled.

1.4.6. Test preparation

The test substance preparation (e.g. neat, diluted, or formulated material containing the test chemical which is applied to the skin) should be the same (or realistic surrogate) as that to which humans or other potential target species may be exposed. Any variations from the 'in-use' preparation must be justified. Where necessary, the test substance is dissolved or suspended in a suitable vehicle. For vehicles other than water the absorption characteristics and potential interaction with the test substance should be known.

▼ B**1.4.7. Application to the skin**

An application site of a specific surface area is defined on the skin surface. A known amount of the test preparation is then evenly applied to the site. This amount should normally mimic potential human exposure, typically 1-5 mg/cm² for a solid or up to 10 µl/cm² for liquids. Any other quantities should be justified by the expected use conditions, the study objectives or physical characteristics of the test preparation. Following application, the treated site must be protected from grooming. An example of a typical device is shown in Figure 1. Normally, the application site will be protected by a non-occlusive cover (e.g. a permeable nylon gauze cover). However, for infinite applications the application site should be occluded. In case of evaporation of semivolatile test substances reduces the recovery rate of the test substance to an unacceptable extend (see also section 1.4.10, first paragraph), it is necessary to trap the evaporated substance in a charcoal filter covering the application device (see Figure 1). It is important that any device does not damage the skin, nor absorb or react with the test preparation. The animals are returned to individual metabolism cages in order to collect excreta.

1.4.8. Duration of exposure and sampling

The duration of exposure is the time interval between application and removal of test preparation by skin washing. A relevant exposure period (typically 6 or 24 hours) should be used, based on the expected human exposure duration. Following the exposure period, the animals are maintained in the metabolism cages until the scheduled termination. The animals should be observed for signs of toxicity/abnormal reactions at regular intervals for the entire duration of the study. At the end of the exposure period the treated skin should be observed for visible signs of irritation.

The metabolism cages should permit separate collection of urine and faeces throughout the study. They should also allow collection of ¹⁴C-carbon dioxide and volatile ¹⁴C-carbon compounds, which should be analysed when produced in quantity (> 5 %). The urine, faeces and trap fluids (e.g. ¹⁴C-carbon dioxide and volatile ¹⁴C-compounds) should be individually collected from each group at each sampling time. If there is sufficient information that little or no volatile radioactive metabolite is formed, open cages can be used.

Excreta are collected during the exposure period, up to 24 hours after the initial skin contact and then daily until the end of the experiment. Whilst three excreta collection intervals will normally be sufficient, the envisaged purpose of the test preparation or existing kinetic data may suggest more appropriate or additional time points for study.

At the end of the exposure period the protective device is removed from each animal and retained separately for analysis. The treated skin of all animals should be washed at least three times with cleansing agent using suitable swabs. Care must be taken to avoid contaminating other parts of the body. The cleansing agent should be representative of normal hygiene practice, e.g. aqueous soap solution. Finally, the skin should be dried. All swabs and washings must be retained for analysis. A fresh cover should be applied to protect the treated site of those animals forming later time point groups prior to their return to individual cages.

▼ B**1.4.9. Terminal procedures**

For each group, the individual animals should be killed at the scheduled time and blood collected for analysis. The protective device or cover should be removed for analysis. The skin from the application site and a similar area of non-dosed, clipped skin should be removed from each animal for separate analysis. The application site may be fractionated to separate the *stratum corneum* from the underlying epidermis to provide more information on the test chemical disposition. The determination of this disposition over a time course after the exposure period should provide some indication of the fate of any test chemical in the *stratum corneum*. To facilitate skin fractionation (following the final skin wash and killing the animal) each protective cover is removed. The application site skin, with annular ring of surrounding skin, is excised from the rat and pinned on a board. A strip of adhesive tape is applied to the skin surface using gentle pressure and the tape removed together with part of the *stratum corneum*. Successive strips of tape are applied until the tape no longer adheres to the skin surface, when all of the *stratum corneum* has been removed. For each animal, all the tape strips may be combined in a single container to which a tissue digestant is added to solubilise the *stratum corneum*. Any potential target tissues may be removed for separate measurement before the residual carcass is analysed for absorbed carcass dose. The carcasses of the individual animals should be retained for analysis. Usually analysis of the total content will be sufficient. Target organs may be removed for separate analysis (if indicated by other studies). Urine present in the bladder at scheduled kill should be added to the previous urine collection. After collection of the excreta from metabolism cages at the time scheduled kill, the cages and their traps should be washed with an appropriate solvent. Other potentially contaminated equipment should likewise be analysed.

1.4.10. Analysis

In all studies adequate recovery (i.e. mean of $100 \pm 10\%$ of the radioactivity) should be achieved. Recoveries outside this range must be justified. The amount of the administered dose in each sample should be analysed by suitably validated procedures.

Statistical considerations should include a measure of variance for the replicates for each application.

2. DATA

The following measurements should be made for each animal, at each sampling time for the test chemical and/or metabolites. In addition to individual data, data grouped according to sampling times should be reported as means.

— quantity associated with the protective appliances,

— quantity that can be dislodged from the skin,

— quantity in/on skin that cannot be washed from the skin,

▼B

- quantity in the sampled blood,
- quantity in the excreta and expired air (if appropriate),
- quantity remaining in the carcass and any organs removed for separate analysis.

The quantity of test substance and/or metabolites in the excreta, expired air, blood and in the carcass will allow determination of the total amount absorbed at each time point. A calculation of the amount of test chemical absorbed per cm² of skin exposed to the test substance over the exposure period can also be obtained.

3. REPORTING

3.1. TEST REPORT

The test report must include the requirements stipulated in the protocol, including a justification for the test system used and should comprise the following:

test substance:

- identification data (e.g. CAS number, if available, source, purity (radiochemical purity), known impurities, lot number),
- physical nature, physicochemical properties (e.g. pH, volatility, solubility, stability, molecular weight and log P_{ow}).

Test preparation:

- formulation and justification of use,
- details of the test preparation, amount applied, achieved concentration, vehicle, stability and homogeneity.

Test animal:

- species/strain used,
- number, age and sex of animals,
- source of animals, housing conditions, diets, etc.,
- individual animal weights at start of test.

Test conditions:

- details of the administration of the test preparation (site of application, assay methods, occlusion/non-occlusion, volume, extraction, detection),
- details of food and water quality.

Results:

- any signs of toxicity,
- tabulated absorption data (expressed as rate, amount or percentage),

▼ B

- overall recoveries of the experiment,
- interpretation of the results, comparison with any available data on percutaneous absorption of the test compound.

Discussion of the results.

Conclusions.

4.

REFERENCES

- (1) Testing Method B.45. Skin Absorption: *In vitro* Method.
- (2) OECD (2002). Guidance Document for the Conduct of Skin Absorption Studies. OECD, Paris.
- (3) ECETOC, (1993) Percutaneous Absorption. European Centre for Ecotoxicology and Toxicology of Chemicals, Monograph No 20.
- (4) Zendzian R.P. (1989) Skin Penetration Method suggested for Environmental Protection Agency Requirements. *J. Am. Coll. Toxicol.* 8(5), p. 829-835.
- (5) Kempainen, B.W., Reifenrath WG (1990) Methods for skin absorption. CRC Press Boca Raton, FL, USA.
- (6) EPA, (1992) Dermal Exposure Assessment: Principles and Applications. Exposure Assessment Group, Office of Health and Environmental Assessment.
- (7) EPA, (1998) Health Effects Test Guidelines, OPPTS 870-7600, Dermal Penetration. Office of Prevention, Pesticides and Toxic Substances.
- (8) Bronaugh, R.L., Wester, R.C., Bucks, D., Maibach H.I. and Sarason, R., (1990) *In vivo* percutaneous absorption of fragrance ingredients in rhesus monkeys and humans. *Fd. Chem. Toxic.* 28, p. 369-373.
- (9) Feldman, R.J. and Maibach, H.I., (1970) Absorption of some organic compounds through the skin in man. *J. Invest Dermatol.* 54, p. 399-404.

▼B

Figure 1

An example of a design of a typical device used to define and protect dermal application site during *in vivo* percutaneous absorption studies

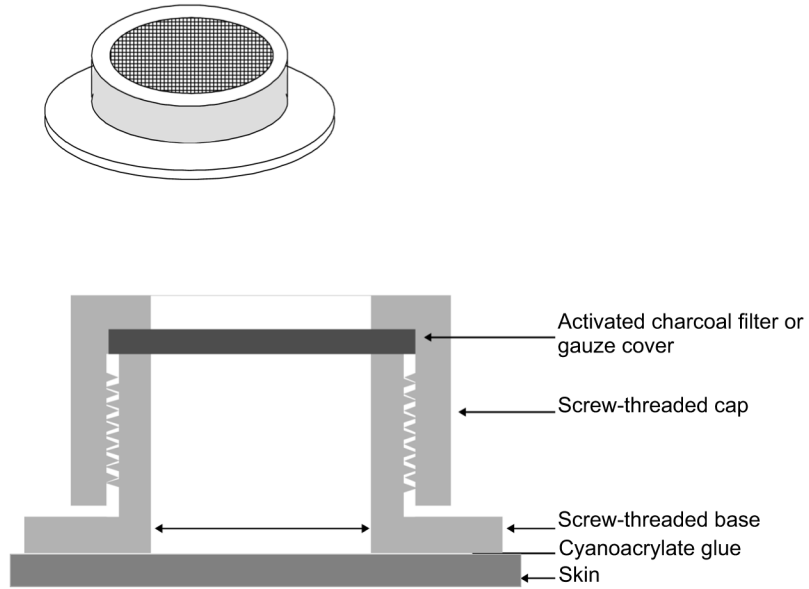

▼B**B.45. SKIN ABSORPTION: *IN VITRO* METHOD****1. METHOD**

This testing method is equivalent to the OECD TG 428 (2004).

1.1. INTRODUCTION

This method has been designed to provide information on absorption of a test substance applied to excised skin. It can either be combined with the method for skin absorption: *in vivo* method (1), or be conducted separately. It is recommended that the OECD Guidance Document for the Conduct of Skin Absorption Studies (2) be consulted to assist in the design of studies based on this method. The Guidance Document has been prepared to facilitate the selection of appropriate *in vitro* procedures for use in specific circumstances, to ensure the reliability of results obtained by this method.

The methods for measuring skin absorption and dermal delivery can be divided into two categories: *in vivo* and *in vitro*. *In vivo* methods on skin absorption are well established and provide pharmacokinetic information in a range of animal species. An *in vivo* method is separately described in another testing method (1). *In vitro* methods have also been used for many years to measure skin absorption. Although formal validation studies of the *in vitro* methods covered by this testing method have not been performed, OECD experts agreed in 1999 that there was sufficient data evaluated to support the *in vitro* method (3). Further details that substantiate this support, including a significant number of direct comparisons of *in vitro* and *in vivo* methods, are provided with the Guidance Document (2). There are a number of monographs that review this topic and provide detailed background on the use of an *in vitro* method (4)(5)(6)(7)(8)(9)(10)(11)(12). *In vitro* methods measure the diffusion of chemicals into and across skin to a fluid reservoir and can utilise non-viable skin to measure diffusion only, or fresh, metabolically active skin to simultaneously measure diffusion and skin metabolism. Such methods have found particular use as a screen for comparing delivery of chemicals into and through skin from different formulations and can also provide useful models for the assessment of percutaneous absorption in humans.

The *in vitro* method may not be applicable for all situations and classes of chemicals. It may be possible to use the *in vitro* test method for an initial qualitative evaluation of skin penetration. In certain cases, it may be necessary to follow this up with *in vivo* data. The guidance document (2) should be consulted for further elaboration of situations where the *in vitro* method would be suitable. Additional detailed information to support the decision is provided in (3).

This method presents general principles for measuring dermal absorption and delivery of a test substance using excised skin. Skin from many mammalian species, including humans, can be used. The permeability properties of skin are maintained after excision from the body because the principal diffusion barrier is the non-viable *stratum corneum*; active transport of chemicals through the skin has not been identified. The skin has been shown to have the capability to metabolise some chemicals during percutaneous absorption (6), but this process is not rate limiting in terms of actual absorbed dose, although it may affect the nature of the material entering the bloodstream.

▼ B

1.2. DEFINITIONS

Unabsorbed dose: represents that washed from the skin surface after exposure and any present on the non-occlusive cover, including any dose shown to volatilise from the skin during exposure.

Absorbed dose (*in vitro*): mass of test substance reaching the receptor fluid or systemic circulation within a specified period of time.

Absorbable dose (*in vitro*): represents that present on or in the skin following washing.

1.3. PRINCIPLE OF THE TEST METHOD

The test substance, which may be radiolabelled, is applied to the surface of a skin sample separating the two chambers of a diffusion cell. The chemical remains on the skin for a specified time under specified conditions, before removal by an appropriate cleansing procedure. The receptor fluid is sampled at time points throughout the experiment and analysed for the test chemical and/or metabolites.

When metabolically active systems are used, metabolites of the test chemical may be analysed by appropriate methods. At the end of the experiment the distribution of the test chemical and its metabolites are quantified, when appropriate.

Using appropriate conditions, which are described in this method and the guidance document (2), absorption of a test substance during a given time period is measured by analysis of the receptor fluid and the treated skin. The test substance remaining in the skin should be considered as absorbed unless it can be demonstrated that absorption can be determined from receptor fluid values alone. Analysis of the other components (material washed off the skin and remaining within the skin layers) allows for further data evaluation, including total test substance disposition and percentage recovery.

To demonstrate the performance and reliability of the test system in the performing laboratory, the results for relevant reference chemicals should be available and in agreement with published literature for the method used. This requirement could be met by testing an appropriate reference substance (preferably of a lipophilicity close to the test substance) concurrently with the test substance or by providing adequate historical data for a number of reference substances of different lipophilicity (e.g. caffeine, benzoic acid, and testosterone).

1.4. DESCRIPTION OF THE TEST METHOD

1.4.1. **Diffusion cell**

A diffusion cell consists of a donor chamber and a receptor chamber between which the skin is positioned (an example of a typical design is provided in Figure 1). The cell should provide a good seal around the skin, enable easy sampling and good mixing of the receptor solution in contact with the underside of the skin, and good temperature control of the cell and its contents. Static and flow-through diffusion cells are both acceptable. Normally, donor chambers are left unoccluded during exposure to a finite dose of a test preparation. However, for infinite applications and certain scenarios for finite doses, the donor chambers may be occluded.

▼ B**1.4.2. Receptor fluid**

The use of a physiologically conducive receptor fluid is preferred although others may also be used provided that they are justified. The precise composition of the receptor fluid should be provided. Adequate solubility of the test chemical in the receptor fluid should be demonstrated so that it does not act as a barrier to absorption. In addition, the receptor fluid should not affect skin preparation integrity. In a flow-through system, the rate of flow must not hinder diffusion of a test substance into the receptor fluid. In a static cell system, the fluid should be continuously stirred and sampled regularly. If metabolism is being studied, the receptor fluid must support skin viability throughout the experiment.

1.4.3. Skin preparations

Skin from human or animal sources can be used. It is recognised that the use of human skin is subject to national and international ethical considerations and conditions. Although viable skin is preferred, non-viable skin can also be used provided that the integrity of the skin can be demonstrated. Either epidermal membranes (enzymically, heat or chemically separated) or split thickness skin (typically 200-400 µm thick) prepared with a dermatome, are acceptable. Full thickness skin may be used but excessive thickness (approximately > 1 mm) should be avoided unless specifically required for determination of the test chemical in layers of the skin. The selection of species, anatomical site and preparative technique must be justified. Acceptable data from a minimum of four replicates per test preparation are required.

1.4.4. Skin preparation integrity

It is essential that the skin is properly prepared. Inappropriate handling may result in damage to the *stratum corneum*, hence the integrity of the prepared skin must be checked. When skin metabolism is being investigated, freshly excised skin should be used as soon as possible, and under conditions known to support metabolic activity. As a general guidance, freshly excised skin should be used within 24 hours, but the acceptable storage period may vary depending on the enzyme system involved in metabolism and storage temperatures (13). When skin preparations have been stored prior to use, evidence should be presented to show that barrier function is maintained.

1.4.5. Test substance

The test substance is the entity whose penetration characteristics are to be studied. Ideally, the test substance should be radiolabelled.

1.4.6. Test preparation

The test substance preparation (e.g. neat, diluted or formulated material containing the test substance which is applied to the skin) should be the same (or a realistic surrogate) as that to which humans or other potential target species may be exposed. Any variation from the 'in-use' preparation must be justified.

▼ B**1.4.7. Test substances concentrations and formulations**

Normally more than one concentration of the test substance is used spanning the upper of potential human exposures. Likewise, testing a range of typical formulations should be considered.

1.4.8. Application to the skin

Under normal conditions of human exposure to chemicals, finite doses are usually encountered. Therefore, an application that mimics human exposure, normally 1-5 mg/cm² of skin for a solid and up to 10 µl/cm² for liquids, should be used. The quantity should be justified by the expected use conditions, the study objectives or physical characteristics of the test preparation. For example, applications to the skin surface may be infinite, where large volumes per unit area are applied.

1.4.9. Temperature

The passive diffusion of chemicals (and therefore their skin absorption) is affected by temperature. The diffusion chamber and skin should be maintained at a constant temperature close to normal skin temperature of 32 ± 1 °C. Different cell designs will require different water bath or heated block temperatures to ensure that the receptor/skin is at its physiological norm. Humidity should preferably be between 30 and 70 %.

1.4.10. Duration of exposure and sampling

Skin exposure to the test preparation may be for the entire duration of the experiment or for shorter times (i.e., to mimic a specific type of human exposure). The skin should be washed of excess test preparation with a relevant cleansing agent, and the rinses collected for analysis. The removal procedure of the test preparation will depend on the expected use condition, and should be justified. A period of sampling of 24 hours is normally required to allow for adequate characterisation of the absorption profile. Since skin integrity may start to deteriorate beyond 24 hours, sampling times should not normally exceed 24 hours. For test substances that penetrate the skin rapidly this may not be necessary but, for test substances that penetrate slowly, longer times may be required. Sampling frequency of the receptor fluid should allow the absorption profile of the test substance to be presented graphically.

1.4.11. Terminal procedures

All components of the test system should be analysed and recovery is to be determined. This includes the donor chamber, the skin surface rinsing, the skin preparation and the receptor fluid/chamber. In some cases, the skin may be fractionated into the exposed area of skin and area of skin under the cell flange, and into *stratum corneum*, epidermis and dermis fractions, for separate analysis.

1.4.12. Analysis

In all studies adequate recovery should be achieved (the aim should be a mean of 100±10 % of the radioactivity and any deviation should be justified). The amount of test substance in the receptor fluid, skin preparation, skin surface washings and apparatus rinse should be analysed, using a suitable technique.

▼ B**2. DATA**

The analysis of receptor fluid, the distribution of the test substance chemical in the test system and the absorption profile with time, should be presented. When finite dose conditions of exposure are used, the quantity washed from the skin, the quantity associated with the skin (and in the different skin layers if analysed) and the amount present in the receptor fluid (rate, and amount or percentage of applied dose) should be calculated. Skin absorption may sometimes be expressed using receptor fluid data alone. However, when the test substance remains in the skin at the end of the study, it may need to be included in the total amount absorbed (see paragraph 66 in reference (3)). When infinite dose conditions of exposure are used the data may permit the calculation of a permeability constant (K_p). Under the latter conditions, the percentage absorbed is not relevant.

3. REPORTING**3.1. TEST REPORT**

The test report must include the requirements stipulated in the protocol, including a justification for the test system used and should, comprise the following:

test substance:

- physical nature, physicochemical properties (at least molecular weight and $\log P_{ow}$), purity (radiochemical purity),
- identification information (e.g. batch number),
- solubility in receptor fluid.

Test preparation:

- formulation and justification of use,
- homogeneity.

Test conditions:

- sources and site of skin, method of preparation, storage conditions prior to use, any pre-treatment (cleaning, antibiotic treatments, etc.), skin integrity measurements, metabolic status, justification of use,
- cell design, receptor fluid composition, receptor fluid flow rate or sampling times and procedures,
- details of application of test preparation and quantification of dose applied,
- duration of exposure,
- details of removal of test preparation from the skin, e.g. skin rinsing,
- details of analysis of skin and any fractionation techniques employed to demonstrate skin distribution,

▼ B

- cell and equipment washing procedures,
- assay methods, extraction techniques, limits of detection and analytical method validation.

Results:

- overall recoveries of the experiment (Applied dose \equiv Skin washings + Skin + Receptor fluid + Cell washings),
- tabulation of individual cell recoveries in each compartment,
- absorption profile,
- tabulated absorption data (expressed as rate, amount or percentage).

Discussion of results.

Conclusions.

4. REFERENCES

- (1) Testing Method B.44. Skin Absorption: *In Vivo* Method.
- (2) OECD, (2002) Guidance Document for the Conduct of Skin Absorption Studies. OECD, Paris.
- (3) OECD, (2000) Report of the Meeting of the OECD Extended Steering Committee for Percutaneous Absorption Testing, Annex 1 to ENV/JM/TG(2000)5. OECD, Paris.
- (4) Kemppainen B.W. and Reifenrath W.G., (1990) Methods for skin absorption. CRC Press, Boca Raton.
- (5) Bronaugh R.L. and Collier, S.W., (1991) Protocol for *In vitro* Percutaneous Absorption Studies, in *In vitro Percutaneous Absorption: Principles, Fundamentals and Applications*, RL Bronaugh and HI Maibach, Eds., CRC Press, Boca Raton, p. 237-241.
- (6) Bronaugh R.L. and Maibach H.I., (1991) *In vitro Percutaneous Absorption: Principles, Fundamentals and Applications*. CRC Press, Boca Raton.
- (7) European Centre for Ecotoxicology and Toxicology of Chemicals, (1993) Monograph No 20, Percutaneous Absorption, ECETOC, Brussels.
- (8) Diembeck W, Beck H, Benech-Kieffer F, Courtellemont P, Dupuis J, Lovell W, Paye M, Spengler J, Steiling W., (1999) Test Guidelines for *In Vitro* Assessment of Dermal Absorption and Percutaneous Penetration of Cosmetic Ingredients, *Fd Chem Tox*, 37, p. 191-205.
- (9) Recommended Protocol for *In vitro* Percutaneous Absorption Rate Studies (1996). US Federal Register, Vol. 61, No 65.
- (10) Howes, D., Guy, R., Hadgraft, J., Heylings, J.R. *et al.* (1996). Methods for assessing Percutaneous absorption. ECVAM Workshop Report ATLA 24, 81 R10.

▼B

- (11) Schaefer, H. and Redelmeier, T.E., (1996). Skin barrier: principles of percutaneous absorption. Karger, Basel.
- (12) Roberts, M.S. and Walters, K.A., (1998). Dermal absorption and toxicity assessment. Marcel Dekker, New York.
- (13) Jewell, C., Heylings, J.R., Clowes, H.M. and Williams, F.M. (2000). Percutaneous absorption and metabolism of dinitrochlorobenzene in vitro. Arch Toxicol 74, p. 356-365.

Figure 1

An example of a typical design of a static diffusion cell for *in vitro* percutaneous absorption studies

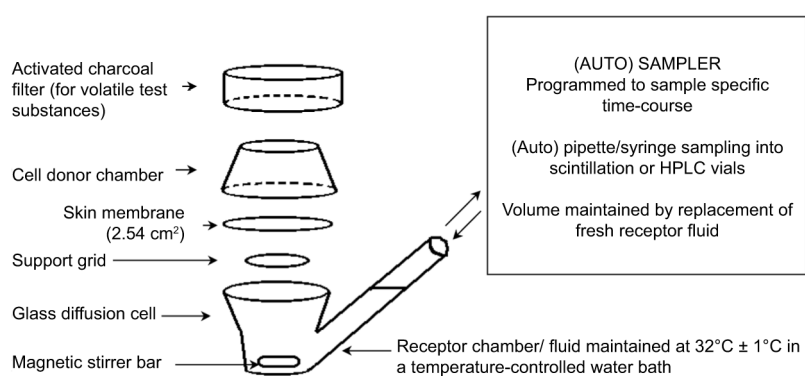

▼ **M8****B.46. IN VITRO SKIN IRRITATION: RECONSTRUCTED HUMAN EPIDERMIS TEST METHOD**

INTRODUCTION

1. This test method (TM) is equivalent to OECD test guideline (TG) 439 (2015). Skin irritation refers to the production of reversible damage to the skin following the application of a test chemical for up to 4 hours [as defined by the United Nations (UN) Globally Harmonized System of Classification and Labelling of Chemicals (GHS)]⁽¹⁾ and the European Union (EU) Regulation 1272/2008 on Classification, Labelling and Packaging of Substances and Mixtures (CLP)⁽¹⁾. This test method provides an *in vitro* procedure that may be used for the hazard identification of irritant chemicals (substances and mixtures) in accordance with UN GHS/CLP Category 2 (2). In regions that do not adopt the optional UN GHS Category 3 (mild irritants), this test method can also be used to identify non-classified chemicals. Therefore, depending on the regulatory framework and the classification system in use, this test method may be used to determine the skin irritancy of chemicals either as a stand-alone replacement test for *in vivo* skin irritation testing or as a partial replacement test within a testing strategy (3).
2. The assessment of skin irritation has typically involved the use of laboratory animals [TM B.4, equivalent to OECD TG 404 originally adopted in 1981 and revised in 1992, 2002 and 2015] (4). For the testing of corrosivity, three validated *in vitro* test methods have been adopted as EU TM B.40 (equivalent to OECD TG 430), TM B.40bis (equivalent to OECD TG 431) and TM B.65 (equivalent to OECD TG 435) (5) (6) (7). An OECD guidance document on Integrated Approaches to Testing and Assessment (IATA) for Skin Corrosion and Irritation describes several modules which group information sources and analysis tools, and provides guidance on (i) how to integrate and use existing test and non-test data for the assessment of skin irritation and skin corrosion potentials of chemicals and (ii) proposes an approach when further testing is needed (3).
3. This test method addresses the human health endpoint skin irritation. It is based on the *in vitro* test system of reconstructed human *epidermis* (RhE), which closely mimics the biochemical and physiological properties of the upper parts of the human skin, *i.e.* the *epidermis*. The RhE test system uses human derived non-transformed keratinocytes as cell source to reconstruct an epidermal model with representative histology and cytoarchitecture. Performance Standards (PS) are available to facilitate the validation and assessment of similar and modified RhE-based test methods, in accordance with the principles of the OECD guidance document No 34 (8) (9). The corresponding test guideline was originally adopted in 2010, updated in 2013 to include additional RhE models, and updated in 2015 to refer to the IATA guidance document and introduce the use of an alternative procedure to measure viability.
4. Pre-validation, optimisation and validation studies have been completed for four commercially available *in vitro* test models (10) (11) (12) (13) (14) (15) (16) (17) (18) (19) (20) (21) (22) (23) (24) (25) (26) (27) (28) based on the RhE test system (sensitivity 80 %, specificity 70 %, and accuracy 75 %). These four test models are included in this TM and are listed in Appendix 2, which also provides information on the type of validation study used to

⁽¹⁾ Regulation (EC) No 1272/2008 of the European Parliament and of the Council of 16 December 2008 on classification, labelling and packaging of substances and mixtures, amending and repealing Directives 67/548/EEC and 1999/45/EC, and amending Regulation (EC) No 1907/2006, OJ L 353/1, 31.12.2008

▼M8

validate the respective test methods. As noted in Appendix 2, the Validated Reference Method (VRM) have been used to develop the present test method and the Performance Standards (8).

5. OECD Mutual Acceptance of Data will only be guaranteed for test models validated according to the Performance Standards (8), if these test models have been reviewed and adopted by OECD. The test models included in this test method and the corresponding OECD TG can be used indiscriminately to address countries' requirements for test results from *in vitro* test methods for skin irritation, while benefiting from the Mutual Acceptance of Data.

6. Definitions of terms used in this document are provided in Appendix 1.

INITIAL CONSIDERATIONS AND LIMITATIONS

7. A limitation of the test method, as demonstrated by the full prospective validation study assessing and characterising RhE test methods (16), is that it does not allow the classification of chemicals to the optional UN GHS Category 3 (mild irritants) (1). Thus, the regulatory framework in member countries will decide how this test method will be used. For the EU, Category 3 has not been taken up in CLP. For a full evaluation of local skin effects after a single dermal exposure, the OECD Guidance Document on Integrated Approaches for Testing and Assessment should be consulted (3). It is recognised that the use of human skin is subject to national and international ethical considerations and conditions.

8. This test method addresses the human health endpoint skin irritation. While this test method does not provide adequate information on skin corrosion, it should be noted that TM B.40bis (equivalent to OECD TG 431) on skin corrosion is based on the same RhE test system, though using another protocol (6). This test method is based on RhE-models using human keratinocytes, which therefore represent *in vitro* the target organ of the species of interest. It moreover directly covers the initial step of the inflammatory cascade/mechanism of action (cell and tissue damage resulting in localised trauma) that occurs during irritation *in vivo*. A wide range of chemicals has been tested in the validation underlying this test method and the database of the validation study amounted to 58 chemicals in total (16) (18) (23). The test method is applicable to solids, liquids, semi-solids and waxes. The liquids may be aqueous or non-aqueous; solids may be soluble or insoluble in water. Whenever possible, solids should be ground to a fine powder before application; no other pre-treatment of the sample is required. Gases and aerosols have not been assessed yet in a validation study (29). While it is conceivable that these can be tested using RhE technology, the current test method does not allow testing of gases and aerosols.

9. Before use of the test method on a mixture for generating data for an intended regulatory purpose, it should be considered whether, and if so why, it may provide adequate results for that purpose. Such considerations are not needed, when there is a regulatory requirement for testing of the mixture. However, due to the fact that mixtures cover a wide spectrum of categories and composition, and that only limited information is currently available on the testing of mixtures, in cases where evidence can be demonstrated on the non-applicability of the test method to a specific category of

▼M8

mixtures (e.g. following a strategy as proposed in Eskes *et al.* 2012 (30)), the test method should not be used for that specific category of mixtures. Similar care should be taken in case specific chemical classes or physico-chemical properties are found not to be applicable to the current test method.

10. Test chemicals absorbing light in the same range as MTT formazan and test chemicals able to directly reduce the vital dye MTT (to MTT formazan) may interfere with the cell viability measurements and need the use of adapted controls for corrections (see paragraphs 28-34).

11. A single testing run composed of three replicate tissues should be sufficient for a test chemical when the classification is unequivocal. However, in cases of borderline results, such as non-concordant replicate measurements and/or mean percent viability equal to 50 ± 5 %, a second run should be considered, as well as a third one in case of discordant results between the first two runs.

PRINCIPLE OF THE TEST

12. The test chemical is applied topically to a three-dimensional RhE model, comprised of non-transformed human-derived epidermal keratinocytes, which have been cultured to form a multilayered, highly differentiated model of the human *epidermis*. It consists of organised basal, spinous and granular layers, and a multilayered *stratum corneum* containing intercellular lamellar lipid layers representing main lipid classes analogous to those found *in vivo*.

13. Chemical-induced skin irritation, manifested mainly by erythema and oedema, is the result of a cascade of events beginning with penetration of the chemicals through the *stratum corneum* where they may damage the underlying layers of keratinocytes and other skin cells. The damaged cells may either release inflammatory mediators or induce an inflammatory cascade which also acts on the cells in the *dermis*, particularly the stromal and endothelial cells of the blood vessels. It is the dilation and increased permeability of the endothelial cells that produce the observed erythema and oedema (29). Notably, the RhE-based test methods, in the absence of any vascularisation in the *in vitro* test system, measure the initiating events in the cascade, e.g. cell / tissue damage (16) (17), using cell viability as readout.

14. Cell viability in RhE models is measured by enzymatic conversion of the vital dye MTT [3-(4,5-Dimethylthiazol-2-yl)-2,5-diphenyltetrazolium bromide, Thiazolyl blue; CAS number 298-93-1], into a blue formazan salt that is quantitatively measured after extraction from tissues (31). Irritant chemicals are identified by their ability to decrease cell viability below defined threshold levels (*i.e.* ≤ 50 %, for UN GHS/CLP Category 2). Depending on the regulatory framework and applicability of the test method, test chemicals that produce cell viabilities above the defined threshold level, may be considered non-irritants (*i.e.* > 50 %, No Category).

▼ **M8**

DEMONSTRATION OF PROFICIENCY

15. Prior to routine use of any of the four validated test models that adhere to this test method (Appendix 2), laboratories should demonstrate technical proficiency, using the ten Proficiency Substances listed in Table 1. In situations where, for instance, a listed substance is unavailable, another substance for which adequate *in vivo* and *in vitro* reference data are available may be used (e.g. from the list of reference chemicals (8)) provided that the same selection criteria as described in Table 1 are applied. Using an alternative proficiency substance should be justified.
16. As part of the proficiency testing, it is recommended that users verify the barrier properties of the tissues after receipt as specified by the RhE model producer. This is particularly important if tissues are shipped over long distance/time periods. Once a test method has been successfully established and proficiency in its use has been acquired and demonstrated, such verification will not be necessary on a routine basis. However, when using a test method routinely, it is recommended to continue to assess the barrier properties at regular intervals.

Table 1

Proficiency Substances ⁽¹⁾

Substance	CAS NR	<i>In vivo</i> score ⁽²⁾	Physical state	UN GHS Category
NON-CLASSIFIED SUBSTANCES (UN GHS No Category)				
naphthalene acetic acid	86-87-3	0	Solid	No Cat.
isopropanol	67-63-0	0,3	Liquid	No Cat.
methyl stearate	112-61-8	1	Solid	No Cat.
heptyl butyrate	5870-93-9	1,7	Liquid	No Cat. (Optional Cat. 3) ⁽³⁾
hexyl salicylate	6259-76-3	2	Liquid	No Cat. (Optional Cat. 3) ⁽³⁾
CLASSIFIED SUBSTANCES (UN GHS Category 2)				
cyclamen aldehyde	103-95-7	2,3	Liquid	Cat. 2
1-bromohexane	111-25-1	2,7	Liquid	Cat. 2
potassium hydroxide (5 % aq.)	1310-58-3	3	Liquid	Cat. 2
1-methyl-3-phenyl-1-piperazine	5271-27-2	3,3	Solid	Cat. 2
heptanal	111-71-7	3,4	Liquid	Cat. 2

⁽¹⁾ The Proficiency Substances are a subset of the substances used in the validation study and the selection is based on the following criteria; (i), the chemicals substances are commercially available; (ii), they are representative of the full range of Draize irritancy scores (from non-irritant to strong irritant); (iii), they have a well-defined chemical structure; (iv), they are representative of the chemical functionality used in the validation process; (v) they provided reproducible *in vitro* results across multiple testing and multiple laboratories; (vi) they were correctly predicted *in vitro*, and (vii) they are not associated with an extremely toxic profile (e.g. carcinogenic or toxic to the reproductive system) and they are not associated with prohibitive disposal costs.

⁽²⁾ *In vivo* score in accordance with TM B.4 (4).

⁽³⁾ Under this test method, the UN GHS optional Category 3 (mild irritants) (1) is considered as No Category.

▼ **M8**

PROCEDURE

17. The following is a description of the components and procedures of a RhE test method for skin irritation assessment (See also Appendix 3 for parameters related to each test model). Standard Operating Procedures (SOPs) for the four models complying with this test method are available (32) (33) (34) (35).

RHE TEST METHOD COMPONENTS

General conditions

18. Non -transformed human keratinocytes should be used to reconstruct the epithelium. Multiple layers of viable epithelial cells (basal layer, *stratum spinosum*, *stratum granulosum*) should be present under a functional *stratum corneum*. *Stratum corneum* should be multilayered containing the essential lipid profile to produce a functional barrier with robustness to resist rapid penetration of cytotoxic benchmark chemicals, e.g. sodium dodecyl sulphate (SDS) or Triton X-100. The barrier function should be demonstrated and may be assessed either by determination of the concentration at which a benchmark chemical reduces the viability of the tissues by 50 % (IC₅₀) after a fixed exposure time, or by determination of the exposure time required to reduce cell viability by 50 % (ET₅₀) upon application of the benchmark chemical at a specified, fixed concentration. The containment properties of the RhE model should prevent the passage of material around the *stratum corneum* to the viable tissue, which would lead to poor modelling of skin exposure. The RhE model should be free of contamination by bacteria, viruses, mycoplasma, or fungi.

Functional conditions*Viability*

19. The assay used for quantifying viability is the MTT-assay (31). The viable cells of the RhE tissue construct can reduce the vital dye MTT into a blue MTT formazan precipitate which is then extracted from the tissue using isopropanol (or a similar solvent). The optical density (OD) of the extraction solvent alone should be sufficiently small, i.e. OD < 0.1. The extracted MTT formazan may be quantified using either a standard absorbance (OD) measurement or an HPLC/UPLC-spectrophotometry procedure (36). The RhE model users should ensure that each batch of the RhE model used meets defined criteria for the negative control. An acceptability range (upper and lower limit) for the negative control OD values (in the Skin Irritation test method conditions) are established by the RhE model developer/supplier. Acceptability ranges for the four validated RhE models included in this test method are given in Table 2. An HPLC/UPLC-Spectrophotometry user should use the negative control OD ranges provided in Table 2 as the acceptance criterion for the negative control. It should be documented that the tissues treated with the negative control are stable in culture (provide similar viability measurements) for the duration of the test exposure period.

Table 2

Acceptability ranges for negative control OD values of the test models included in this TM

	Lower acceptance limit	Upper acceptance limit
EpiSkin™ (SM)	≥ 0,6	≤ 1,5
EpiDerm™ SIT (EPI-200)	≥ 0,8	≤ 2,8

▼ M8

	Lower acceptance limit	Upper acceptance limit
SkinEthic™ RHE	$\geq 0,8$	$\leq 3,0$
LabCyte EPI-MODEL24 SIT	$\geq 0,7$	$\leq 2,5$

Barrier function

20. The *stratum corneum* and its lipid composition should be sufficient to resist the rapid penetration of cytotoxic benchmark chemicals, e.g. SDS or Triton X-100, as estimated by IC₅₀ or ET₅₀ (Table 3).

Morphology

21. Histological examination of the RhE model should be provided demonstrating human *epidermis*-like structure (including multilayered *stratum corneum*).

Reproducibility

22. The results of the positive and negative controls of the test method should demonstrate reproducibility over time.

Quality control (QC)

23. The RhE model should only be used if the developer/supplier demonstrates that each batch of the RhE model used meets defined production release criteria, among which those for *viability* (paragraph 19), *barrier function* (paragraph 20) and *morphology* (paragraph 21) are the most relevant. These data should be provided to the test method users, so that they are able to include this information in the test report. An acceptability range (upper and lower limit) for the IC₅₀ or the ET₅₀ should be established by the RhE model developer/supplier. Only results produced with qualified tissues can be accepted for reliable prediction of irritation classification. The acceptability ranges for the four test models included in this TM are given in Table 3.

Table 3

QC batch release criteria of the test models included in this TM

	Lower acceptance limit	Upper acceptance limit
EpiSkin™ (SM) (18 hours treatment with SDS) (32)	IC ₅₀ = 1,0 mg/ml	IC ₅₀ = 3,0 mg/ml
EpiDerm™ SIT (EPI-200) (1 % Triton X-100) (33)	ET ₅₀ = 4,0 hr	ET ₅₀ = 8,7 hr
SkinEthic™ RHE (1 % Triton X-100) (34)	ET ₅₀ = 4,0 hr	ET ₅₀ = 10,0 hr
LabCyte EPI-MODEL24 SIT (18 hours treatment with SDS) (35)	IC ₅₀ = 1,4 mg/ml	IC ₅₀ = 4,0 mg/ml

▼M8**Application of the Test Chemical and Control Chemicals**

24. At least three replicates should be used for each test chemical and for the controls in each run. For liquid as well as solid chemicals, sufficient amount of test chemical should be applied to uniformly cover the *epidermis* surface while avoiding an infinite dose, *i.e.* ranging from 26 to 83 l/cm² or mg/cm² (see Appendix 3). For solid chemicals, the *epidermis* surface should be moistened with deionised or distilled water before application, to improve contact between the test chemical and the *epidermis* surface. Whenever possible, solids should be tested as a fine powder. A nylon mesh may be used as a spreading aid in some cases (see Appendix 3). At the end of the exposure period, the test chemical should be carefully washed from the *epidermis* surface with aqueous buffer, or 0,9 % NaCl. Depending on the RhE test models used, the exposure period ranges between 15 and 60 minutes, and the incubation temperature between 20 and 37 °C. These exposure periods and temperatures are optimised for each individual RhE test method and represent the different intrinsic properties of the test models (*e.g.* barrier function) (see Appendix 3).
25. Concurrent negative control (NC) and positive control (PC) should be used in each run to demonstrate that viability (using the NC), barrier function and resulting tissue sensitivity (using the PC) of the tissues are within a defined historical acceptance range. The suggested PC is 5 % aqueous SDS. The suggested NCs is either water or phosphate buffered saline (PBS).

Cell Viability Measurements

26. According to the test procedure, it is essential that the viability measurement is not performed immediately after exposure to the test chemical, but after a sufficiently long post-treatment incubation period of the rinsed tissue in fresh medium. This period allows both for recovery from weak cytotoxic effects and for appearance of clear cytotoxic effects. A 42 hours post-treatment incubation period was found optimal during test optimisation of two of the RhE-based test models underlying this test method (11) (12) (13) (14) (15).
27. The MTT assay is a standardised quantitative method which should be used to measure cell viability under this test method. It is compatible with use in a three-dimensional tissue construct. The tissue sample is placed in MTT solution of appropriate concentration (*e.g.* 0,3 - 1 mg/ml) for 3 hours. The MTT is converted into blue formazan by the viable cells. The precipitated blue formazan product is then extracted from the tissue using a solvent (*e.g.* isopropanol, acidic isopropanol), and the concentration of formazan is measured by determining the OD at 570 nm using a filter band pass of maximum \pm 30 nm or, by using an HPLC/UPLC-spectrophotometry procedure (see paragraph 34) (36).
28. Optical properties of the test chemical or its chemical action on MTT (*e.g.* chemicals may prevent or reverse the colour generation as well as cause it) may interfere with the assay leading to a false estimate of viability. This may occur when a specific test chemical is not completely removed from the tissue by rinsing or when it penetrates the *epidermis*. If a test chemical acts directly on the MTT (*e.g.* MTT-reducer), is naturally coloured, or becomes coloured during tissue treatment, additional controls should be

▼M8

used to detect and correct for test chemical interference with the viability measurement technique (see paragraphs 29 and 33). Detailed description of how to correct direct MTT reduction and interferences by colouring agents is available in the SOPs for the four validated models included in this test method (32) (33) (34) (35).

29. To identify direct MTT reducers, each test chemical should be added to freshly prepared MTT solution. If the MTT mixture containing the test chemical turns blue/purple, the test chemical is presumed to directly reduce MTT and a further functional check on non-viable RhE tissues should be performed, independently of using the standard absorbance (OD) measurement or an HPLC/UPLC-spectrophotometry procedure. This additional functional check employs killed tissues that possess only residual metabolic activity but absorb the test chemical in a similar way as viable tissues. Each MTT reducing test chemical is applied on at least two killed tissue replicates which undergo the entire testing procedure to generate a non-specific MTT reduction (NSMTT) (32) (33) (34) (35). A single NSMTT control is sufficient per test chemical regardless of the number of independent tests/runs performed. The true tissue viability is then calculated as the percent tissue viability obtained with living tissues exposed to the MTT reducer minus the percent non-specific MTT reduction obtained with the killed tissues exposed to the same MTT reducer, calculated relative to the negative control run concurrently to the test being corrected (%NSMTT).

30. To identify potential interference by coloured test chemicals or test chemicals that become coloured when in contact with water or isopropanol and decide on the need for additional controls, spectral analysis of the test chemical in water (environment during exposure) and/or isopropanol (extracting solution) should be performed. If the test chemical in water and/or isopropanol absorbs light in the range of 570 ± 30 nm, further colorant controls should be performed or, alternatively, an HPLC/UPLC-spectrophotometry procedure should be used in which case these controls are not required (see paragraphs 33 and 34). When performing the standard absorbance (OD) measurement, each interfering coloured test chemical is applied on at least two viable tissue replicates, which undergo the entire testing procedure but are incubated with medium instead of MTT solution during the MTT incubation step to generate a non-specific colour (NSC_{living}) control. The NSC_{living} control needs to be performed concurrently to the testing of the coloured test chemical and in case of multiple testing, an independent NSC_{living} control needs to be conducted with each test performed (in each run) due to the inherent biological variability of living tissues. The true tissue viability is then calculated as the percent tissue viability obtained with living tissues exposed to the interfering test chemical and incubated with MTT solution minus the percent non-specific colour obtained with living tissues exposed to the interfering test chemical and incubated with medium without MTT, run concurrently to the test being corrected (%NSC_{living}).

31. Test chemicals that are identified as producing both direct MTT reduction (see paragraph 29) and colour interference (see paragraph 30) will also require a third set of controls, apart from the NSMTT and NSC_{living} controls described in the previous paragraphs, when performing the standard absorbance (OD) measurement. This is usually the case with darkly coloured test chemicals interfering with the MTT assay (e.g. blue, purple, black) because their intrinsic colour impedes the assessment of their capacity to directly reduce MTT as described in paragraph 29. These test

▼ M8

chemicals may bind to both living and killed tissues and therefore the NSMTT control may not only correct for potential direct MTT reduction by the test chemical, but also for colour interference arising from the binding of the test chemical to killed tissues. This could lead to a double correction for colour interference since the NSC_{living} control already corrects for colour interference arising from the binding of the test chemical to living tissues. To avoid a possible double correction for colour interference, a third control for non-specific colour in killed tissues (NSC_{killed}) needs to be performed. In this additional control, the test chemical is applied on at least two killed tissue replicates, which undergo the entire testing procedure but are incubated with medium instead of MTT solution during the MTT incubation step. A single NSC_{killed} control is sufficient per test chemical regardless of the number of independent tests/runs performed, but should be performed concurrently to the NSMTT control and, where possible, with the same tissue batch. The true tissue viability is then calculated as the percent tissue viability obtained with living tissues exposed to the test chemical minus %NSMTT minus %NSC_{living} plus the percent non-specific colour obtained with killed tissues exposed to the interfering test chemical and incubated with medium without MTT, calculated relative to the negative control run concurrently to the test being corrected (%NSC_{killed}).

32. It is important to note that non-specific MTT reduction and non-specific colour interferences may increase the readouts of the tissue extract above the linearity range of the spectrophotometer. On this basis, each laboratory should determine the linearity range of their spectrophotometer with MTT formazan (CAS # 57360-69-7) from a commercial source before initiating the testing of test chemicals for regulatory purposes. The standard absorbance (OD) measurement using a spectrophotometer is appropriate to assess direct MTT-reducers and colour interfering test chemicals when the ODs of the tissue extracts obtained with the test chemical without any correction for direct MTT reduction and/or colour interference are within the linear range of the spectrophotometer or when the uncorrected percent viability obtained with the test chemical is already $\leq 50\%$. Nevertheless, results for test chemicals producing %NSMTT and/or %NSC_{living} $\geq 50\%$ of the negative control should be taken with caution as this is the cut-off used to distinguish classified from not classified chemicals (see paragraph 36).

33. For coloured test chemicals which are not compatible with the standard absorbance (OD) measurement due to too strong interference with the MTT assay, the alternative HPLC/UPLC-spectrophotometry procedure to measure MTT formazan may be employed (see paragraph 34) (36). The HPLC/UPLC-spectrophotometry system allows for the separation of the MTT formazan from the test chemical before its quantification (36). For this reason, NSC_{living} or NSC_{killed} controls are never required when using HPLC/UPLC-spectrophotometry, independently of the chemical being tested. NSMTT controls should nevertheless be used if the test chemical is suspected to directly reduce MTT or has a colour that impedes the assessment of the capacity to directly reduce MTT (as described in paragraph 29). When using HPLC/UPLC-spectrophotometry to measure MTT formazan, the percent tissue viability is calculated as percent MTT formazan peak area obtained with living tissues exposed to the test chemical relative to the MTT formazan peak obtained with the concurrent negative control. For test chemicals able to directly reduce MTT, true tissue viability is calculated as the percent tissue viability obtained with living

▼ M8

tissues exposed to the test chemical minus %NSMTT. Finally, it should be noted that direct MTT-reducers that may also be colour interfering, which are retained in the tissues after treatment and reduce MTT so strongly that they lead to ODs (using standard OD measurement) or peak areas (using UPLC/HPLC-spectrophotometry) of the tested tissue extracts that fall outside of the linearity range of the spectrophotometer cannot be assessed, although these are expected to occur in only very rare situations.

34. HPLC/UPLC-spectrophotometry may be used also with all types of test chemicals (coloured, non-coloured, MTT-reducers and non-MTT reducers) for measurement of MTT formazan (36). Due to the diversity of HPLC/UPLC-spectrophotometry systems, qualification of the HPLC/UPLC-spectrophotometry system should be demonstrated before its use to quantify MTT formazan from tissue extracts by meeting the acceptance criteria for a set of standard qualification parameters based on those described in the U.S. Food and Drug Administration guidance for industry on bio-analytical method validation (36) (37). These key parameters and their acceptance criteria are shown in Appendix 4. Once the acceptance criteria defined in Appendix 4 have been met, the HPLC/UPLC-spectrophotometry system is considered qualified and ready to measure MTT formazan under the experimental conditions described in this test method.

Acceptability Criteria

35. For each test method using valid RhE model batches (see paragraph 23), tissues treated with the negative control should exhibit OD reflecting the quality of the tissues that followed shipment, receipt steps and all protocol processes. Control OD values should not be below historically established boundaries. Similarly, tissues treated with the PC, *i.e.* 5 % aqueous SDS, should reflect their ability to respond to an irritant chemical under the conditions of the test method (see Appendix 3 and for further information SOPs of the four test models included in this TG (32) (33) (34) (35)). Associated and appropriate measures of variability between tissue replicates, *i.e.* standard deviations (SD) should fall within the acceptance limits established for the test model used (see Appendix 3).

Interpretation of Results and Prediction Model

36. The OD values obtained with each test chemical can be used to calculate the percentage of viability normalised to the negative control, which is set to 100 %. In case HPLC/UPLC-spectrophotometry is used, the percent tissue viability is calculated as percent MTT formazan peak area obtained with living tissues exposed to the test chemical relative to the MTT formazan peak obtained with the concurrent negative control. The cut-off value of percentage cell viability distinguishing irritant from non-classified test chemicals and the statistical procedure(s) used to evaluate the results and identify irritant chemicals should be clearly defined, documented, and proven to be appropriate (see SOPs of the test models for information). The cut-off values for the prediction of irritation are given below:

▼M8

- The test chemical is identified as requiring classification and labelling according to UN GHS/CLP (Category 2 or Category 1) if the mean percent tissue viability after exposure and post-treatment incubation is less than or equal (\leq) to 50 %. Since the RhE test models covered by this test method cannot resolve between UN GHS/CLP Categories 1 and 2, further information on skin corrosion will be required to decide on its final classification [see also the OECD Guidance Document on IATA (3)]. In case the test chemical is found to be non-corrosive (e.g. based on TM.40, B.40bis or B.65), and shows tissue viability after exposure and post-treatment incubation is less than or equal (\leq) to 50 %, the test chemical is considered to be irritant to skin in accordance with UN GHS/CLP Category 2.
- Depending on the regulatory framework in member countries, the test chemical may be considered as non-irritant to skin in accordance with UN GHS/CLP No Category if the tissue viability after exposure and post-treatment incubation is more than ($>$) 50 %.

DATA AND REPORTING**Data**

37. For each run, data from individual replicate tissues (e.g. OD values and calculated percentage cell viability data for each test chemical, including classification) should be reported in tabular form, including data from repeat experiments as appropriate. In addition means \pm SD for each run should be reported. Observed interactions with MTT reagent and coloured test chemicals should be reported for each tested chemical.

Test Report

38. The test report should include the following information:

Test Chemical and Control Chemicals:

- Mono-constituent substance: chemical identification, such as IUPAC or CAS name, CAS number, SMILES or InChI code, structural formula, purity, chemical identity of impurities as appropriate and practically feasible, etc;
- Multi-constituent substance, UVCB and mixture: characterised as far as possible by chemical identity (see above), quantitative occurrence and relevant physicochemical properties of the constituents;
- Physical appearance, water solubility, and any additional relevant physicochemical properties;
- Source, lot number if available;
- Treatment of the test chemical/control chemicals prior to testing, if applicable (e.g. warming, grinding);
- Stability of the test chemical, limit date for use, or date for re-analysis if known;
- Storage conditions.

RhE model and protocol used (and rationale for the choice, if applicable)

▼ M8*Test Conditions:*

- RhE model used (including batch number);
- Calibration information for measuring device (*e.g.* spectrophotometer), wavelength and band pass (if applicable) used for quantifying MTT formazan, and linearity range of measuring device; Description of the method used to quantify MTT formazan;
- Description of the qualification of the HPLC/UPLC-spectrophotometry system, if applicable; Complete supporting information for the specific RhE model used including its performance. This should include, but is not limited to;
 - i) Viability;
 - ii) Barrier function;
 - iii) Morphology;
 - iv) Reproducibility and predictivity;
 - v) Quality controls (QC) of the model;
- Reference to historical data of the model. This should include, but is not limited to acceptability of the QC data with reference to historical batch data.
- Demonstration of proficiency in performing the test method before routine use by testing of the proficiency substances.

Test Procedure:

- Details of the test procedure used (including washing procedures used after exposure period); Dose of test chemical and controls used;
- Duration and temperature of exposure and post-exposure incubation period;
- Indication of controls used for direct MTT-reducers and/or colouring test chemicals, if applicable;
- Number of tissue replicates used per test chemical and controls (PC, negative control, and NSMTT, NSC_{living} and NSC_{killed}, if applicable);
- Description of decision criteria/prediction model applied based on the RhE model used;
- Description of any modifications to the test procedure (including washing procedures).

Run and Test Acceptance Criteria:

- Positive and negative control mean values and acceptance ranges based on historical data; Acceptable variability between tissue replicates for positive and negative controls;

▼M8

- Acceptable variability between tissue replicates for test chemical.

Results:

- Tabulation of data for individual test chemical for each run and each replicate measurement including OD or MTT formazan peak area, percent tissue viability, mean percent tissue viability and SD;
- If applicable, results of controls used for direct MTT-reducers and/or colouring test chemicals including OD or MTT formazan peak area, %NSMTT, %NSC_{living}, %NSC_{killed}, SD, final correct percent tissue viability;
- Results obtained with the test chemical(s) and controls in relation to the defined run and test acceptance criteria;
- Description of other effects observed;
- The derived classification with reference to the prediction model/decision criteria used.

*Discussion of the results**Conclusions***LITERATURE**

- (1) United Nations (UN) (2013). Globally Harmonized System of Classification and Labelling of Chemicals (GHS), Second Revised Edition, UN New York and Geneva, 2013. Available at: http://www.unece.org/trans/danger/publi/ghs/ghs_rev05/05files_e.html.
- (2) EURL-ECVAM (2009). Statement on the 'Performance Under UN GHS of Three *In Vitro* Assays for Skin Irritation Testing and the Adaptation of the Reference Chemicals and Defined Accuracy Values of the ECVAM Skin Irritation Performance Standards', Issued by the ECVAM Scientific Advisory Committee (ESAC31), 9 April 2009. Available at: https://eurl-ecvam.jrc.ec.europa.eu/about-ecvam/archive-publications/publication/ESAC31_skin-irritation-statement_20090922.pdf
- (3) OECD (2014). Guidance Document on Integrated Approaches to Testing and Assessment for Skin Irritation/Corrosion. Environment, Health and Safety Publications, Series on Testing and Assessment (No 203), Organisation for Economic Cooperation and Development, Paris.
- (4) Chapter B.4 of this Annex, Acute Dermal Irritation, Corrosion.
- (5) Chapter B.40 of this Annex, *In Vitro* Skin Corrosion: Transcutaneous Electrical Resistance (TER).
- (6) Chapter B.40bis of this Annex, *In Vitro* Skin Corrosion: Reconstructed Human Epidermis (RHE) test method.
- (7) Chapter B.65 of this Annex, *In Vitro* Membrane Barrier Test Method.

▼M8

- (8) OECD (2015). Performance Standards for the Assessment of Proposed Similar or Modified *In Vitro* Reconstructed Human *Epidermis* (RhE) Test Methods for Skin Irritation in Relation to TG 439. Environment, health and Safety Publications, Series on Testing and Assessment (No 220). Organisation for Economic Cooperation and Development, Paris.
- (9) OECD (2005). Guidance Document on the Validation and International Acceptance of New or Updated Test Methods for Hazard Assessment. Environment, Health and Safety Publications, Series on Testing and Assessment (No 34) Organisation for Economic Cooperation and Development, Paris.
- (10) Fentem, J.H., Briggs, D., Chesné, C., Elliot, G.R., Harbell, J.W., Heylings, J.R., Portes, P., Roguet, R., van de Sandt, J.J. M. and Botham, P. (2001). A Prevalidation Study on *In Vitro* Tests for Acute Skin Irritation, Results and Evaluation by the Management Team, *Toxicol. in Vitro* 15, 57-93.
- (11) Portes, P., Grandidier, M.-H., Cohen, C. and Roguet, R. (2002). Refinement of the EPISKIN Protocol for the Assessment of Acute Skin Irritation of Chemicals: Follow-Up to the ECVAM Prevalidation Study, *Toxicol. in Vitro* 16, 765–770.
- (12) Kandárová, H., Liebsch, M., Genschow, E., Gerner, I., Traue, D., Slawik, B. and Spielmann, H. (2004). Optimisation of the EpiDerm Test Protocol for the Upcoming ECVAM Validation Study on *In Vitro* Skin Irritation Tests, *ALTEX* 21, 107–114.
- (13) Kandárová, H., Liebsch, M., Gerner, I., Schmidt, E., Genschow, E., Traue, D. and Spielmann, H. (2005). The EpiDerm Test Protocol for the Upcoming ECVAM Validation Study on *In Vitro* Skin Irritation Tests – An Assessment of the Performance of the Optimised Test, *ATLA* 33, 351-367.
- (14) Cotovio, J., Grandidier, M.-H., Portes, P., Roguet, R. and Rubinsteen, G. (2005). The *In Vitro* Acute Skin Irritation of Chemicals: Optimisation of the EPISKIN Prediction Model Within the Framework of the ECVAM Validation Process, *ATLA* 33, 329-349.
- (15) Zuang, V., Balls, M., Botham, P.A., Coquette, A., Corsini, E., Curren, R.D., Elliot, G.R., Fentem, J.H., Heylings, J.R., Liebsch, M., Medina, J., Roguet, R., van De Sandt, J.J.M., Wiemann, C. and Worth, A. (2002). Follow-Up to the ECVAM Prevalidation Study on *In Vitro* Tests for Acute Skin Irritation, The European Centre for the Validation of Alternative Methods Skin Irritation Task Force report 2, *ATLA* 30, 109-129.
- (16) Spielmann, H., Hoffmann, S., Liebsch, M., Botham, P., Fentem, J., Eskes, C., Roguet, R., Cotovio, J., Cole, T., Worth, A., Heylings, J., Jones, P., Robles, C., Kandárová, H., Gamer, A., Remmele, M., Curren, R., Raabe, H., Cockshott, A., Gerner, I. and Zuang, V. (2007). The ECVAM International Validation Study on *In Vitro* Tests for Acute Skin Irritation: Report on the Validity of the EPISKIN and EpiDerm Assays and on the Skin Integrity Function Test, *ATLA* 35, 559-601.
- (17) Hoffmann S. (2006). ECVAM Skin Irritation Validation Study Phase II: Analysis of the Primary Endpoint MTT and the Secondary Endpoint IL1- α .
- (18) Eskes C., Cole, T., Hoffmann, S., Worth, A., Cockshott, A., Gerner, I. and Zuang, V. (2007). The ECVAM International Validation Study on *In Vitro* Tests for Acute Skin Irritation: Selection of Test Chemicals, *ATLA* 35, 603-619.
- (19) Cotovio, J., Grandidier, M.-H., Lelièvre, D., Roguet, R., Tinois-Tessonnaud, E. and Leclaire, J. (2007). *In Vitro* Acute Skin Irritancy of Chemicals Using the Validated EPISKIN Model in a Tiered Strategy - Results and Performances with 184 Cosmetic Ingredients, *ALTEX*, 14, 351-358.

▼ **M8**

- (20) EURL-ECVAM (2007). Statement on the Validity of *In Vitro* Tests for Skin Irritation, Issued by the ECVAM Scientific Advisory Committee (ESAC26), 27 April 2007. Available at: https://eurl-ecvam.jrc.ec.europa.eu/about-ecvam/archive-publications/publication//ESAC26_statement_SkinIrritation_20070525_C.pdf
- (21) EURL-ECVAM. (2007). Performance Standards for Applying Human Skin Models to *In Vitro* Skin Irritation Testing. *N.B. These are the original PS used for the validation of two test methods. These PS should not be used any longer as an updated version (8) is now available.*
- (22) EURL-ECVAM. (2008). Statement on the Scientific Validity of *In Vitro* Tests for Skin Irritation Testing, Issued by the ECVAM Scientific Advisory Committee (ESAC29), 5 November 2008. https://eurl-ecvam.jrc.ec.europa.eu/about-ecvam/archive-publications/publication/ESAC_Statement_SkinEthic-EpiDerm-FINAL-0812-01.pdf
- (23) OECD (2010). Explanatory Background Document to the OECD Draft Test Guideline on *In Vitro* Skin Irritation Testing. Environment, Health and Safety Publications. Series on Testing and Assessment, (No 137), Organisation for Economic Cooperation and Development, Paris.
- (24) Katoh, M., Hamajima, F., Ogasawara, T. and Hata K. (2009). Assessment of Human Epidermal Model LabCyte EPI-MODEL for *In Vitro* Skin Irritation Testing According to European Centre for the Validation of Alternative Methods (ECVAM)-Validated Protocol, *J Toxicol Sci*, 34, 327-334
- (25) Katoh, M. and Hata K. (2011). Refinement of LabCyte EPI-MODEL24 Skin Irritation Test Method for Adaptation to the Requirements of OECD Test Guideline 439, *AATEX*, 16, 111-122
- (26) OECD (2011). Validation Report for the Skin Irritation Test Method Using LabCyte EPI-MODEL24. Environment, Health and Safety Publications, Series on Testing and Assessment (No 159), Organisation for Economic Cooperation and Development, Paris.
- (27) OECD (2011). Peer Review Report of Validation of the Skin Irritation Test Using LabCyte EPI-MODEL24. Environment, Health and Safety Publications, Series on Testing and Assessment (No 155), Organisation for Economic Cooperation and Development, Paris.
- (28) Kojima, H., Ando, Y., Idehara, K., Katoh, M., Kosaka, T., Miyaoka, E., Shinoda, S., Suzuki, T., Yamaguchi, Y., Yoshimura, I., Yuasa, A., Watanabe, Y. and Omori, T. (2012). Validation Study of the *In Vitro* Skin Irritation Test with the LabCyte EPI-MODEL24, *Altern Lab Anim*, 40, 33-50.
- (29) Welss, T., Basketter, D.A. and Schröder, K.R. (2004). *In Vitro* Skin Irritation: Fact and Future. State of the Art Review of Mechanisms and Models, *Toxicol. In Vitro* 18, 231-243.
- (30) Eskes, C. *et al.* (2012). Regulatory Assessment of *In Vitro* Skin Corrosion and Irritation Data within the European Framework: Workshop Recommendations. *Regul.Toxicol.Pharmacol.* 62, 393-403).
- (31) Mosmann, T. (1983). Rapid Colorimetric Assay for Cellular Growth and Survival: Application to Proliferation and Cytotoxicity Assays, *J. Immunol. Methods* 65, 55-63.

▼M8

- (32) EpiSkin™ (February 2009). SOP, Version 1,8ECVAM Skin Irritation Validation Study: Validation of the EpiSkin™ Test Method 15 min - 42 hours for the Prediction of acute Skin Irritation of Chemicals
- (33) EpiDerm™ (Revised March 2009). SOP, Version 7.0, Protocol for: *In Vitro* EpiDerm™ Skin Irritation Test (EPI-200-SIT), for Use with MatTek Corporation's Reconstructed Human Epidermal Model EpiDerm (EPI-200).
- (34) SkinEthic™ RHE (February 2009) SOP, Version 2.0, SkinEthic Skin Irritation Test-42bis Test Method for the Prediction of Acute Skin Irritation of Chemicals: 42 Minutes Application + 42 Hours Post-Incubation.
- (35) LabCyte (June 2011). EPI-MODEL24 SIT SOP, Version 8.3, Skin Irritation Test Using the Reconstructed Human Model 'LabCyte EPI-MODEL24'
- (36) Alépée, N., Barroso, J., De Smedt, A., De Wever, B., Hibatallah, J., Klaric, M., Mewes, K.R., Millet, M., Pfannenbecker, U., Tailhardat, M., Templier, M., and McNamee, P. Use of HPLC/UPLC-Spectrophotometry for Detection of MTT Formazan in *In Vitro* Reconstructed Human Tissue (RhT)-Based Test Methods Employing the MTT Assay to Expand their Applicability to Strongly Coloured Test Chemicals. Manuscript in preparation.
- (37) US FDA (2001). Guidance for Industry: Bioanalytical Method Validation. U.S. Department of Health and Human Services, Food and Drug Administration. May 2001. Available at: [<http://www.fda.gov/downloads/Drugs/Guidances/ucm070107.pdf>].
- (38) Harvell, J.D., Lamminstausta, K., and Maibach, H.I. (1995). Irritant Contact Dermatitis, in: Practical Contact Dermatitis, pp 7-18, (Ed. Guin J. D.). Mc Graw-Hill, New York.
- (39) EURL-ECVAM (2009). Performance Standards for *In Vitro* Skin Irritation Test Methods Based on Reconstructed Human Epidermis (RhE). *N.B. This is the current version of the ECVAM PS, updated in 2009 in view of the implementation of UN GHS. These PS should not be used any longer as an updated version (8) is now available related to the present TG.*
- (40) EURL-ECVAM. (2009). ESAC Statement on the Performance Standards (PS) for *In Vitro* Skin Irritation Testing Using Reconstructed Human Epidermis, Issued by the ECVAM Scientific Advisory Committee (ESAC31), 8 July 2009.
- (41) EC (2001). Commission Directive 2001/59/EC of 6 August 2001 Adapting to Technical Progress for the 28th Time Council Directive 67/548/EEC on the Approximation of Laws, Regulations and Administrative Provisions Relating to the Classification, Packaging and Labelling of Dangerous Substances, *Official Journal of the European Union* L225, 1-333.

▼M8*Appendix 1*

DEFINITIONS

Accuracy: The closeness of agreement between test method results and accepted reference values. It is a measure of test method performance and one aspect of relevance. The term is often used interchangeably with 'concordance' to mean the proportion of correct outcomes of a test method (9).

Cell viability: Parameter measuring total activity of a cell population *e.g.* as ability of cellular mitochondrial dehydrogenases to reduce the vital dye MTT (3-(4,5-Dimethylthiazol-2-yl)-2,5-diphenyltetrazolium bromide, Thiazolyl blue), which depending on the endpoint measured and the test design used, correlates with the total number and/or vitality of living cells.

Chemical: means a substance or a mixture.

Concordance: This is a measure of performance for test models that give a categorical result, and is one aspect of relevance. The term is sometimes used interchangeably with accuracy, and is defined as the proportion of all chemicals tested that are correctly classified as positive or negative. Concordance is highly dependent on the prevalence of positives in the types of test chemical being examined (9).

ET₅₀: Can be estimated by determination of the exposure time required to reduce cell viability by 50 % upon application of the benchmark chemical at a specified, fixed concentration, see also IC₅₀.

GHS (Globally Harmonized System of Classification and Labelling of Chemicals by the United Nations (UN)): A system proposing the classification of chemicals (substances and mixtures) according to standardised types and levels of physical, health and environmental hazards, and addressing corresponding communication elements, such as pictograms, signal words, hazard statements, precautionary statements and safety data sheets, so that to convey information on their adverse effects with a view to protect people (including employers, workers, transporters, consumers and emergency responders) and the environment (1).

HPLC: High Performance Liquid Chromatography.

IATA: Integrated Approach on Testing and Assessment

IC₅₀: Can be estimated by determination of the concentration at which a benchmark chemical reduces the viability of the tissues by 50 % (IC₅₀) after a fixed exposure time, see also ET₅₀.

Infinite dose: Amount of test chemical applied to the *epidermis* exceeding the amount required to completely and uniformly cover the *epidermis* surface.

Mixture: A mixture or a solution composed of two or more substances.

Mono-constituent substance: A substance, defined by its quantitative composition, in which one main constituent is present to at least 80 % (w/w).

▼ M8

MTT: 3-(4,5-Dimethylthiazol-2-yl)-2,5-diphenyltetrazolium bromide; Thiazolyl blue tetrazolium bromide.

Multi-constituent substance: A substance, defined by its quantitative composition, in which more than one main constituent is present in a concentration $\geq 10\%$ (w/w) and $< 80\%$ (w/w). A multi-constituent substance is the result of a manufacturing process. The difference between mixture and multi-constituent substance is that a mixture is obtained by blending of two or more substances without chemical reaction. A multi-constituent substance is the result of a chemical reaction.

NSC_{killed}: Non-Specific Colour in killed tissues.

NSC_{living}: Non-Specific Colour in living tissues.

NSMTT: Non-Specific MTT reduction.

Performance standards (PS): Standards, based on a validated test method, that provide a basis for evaluating the comparability of a proposed test method that is mechanistically and functionally similar. Included are; (i) essential test method components; (ii) a minimum list of Reference Chemicals selected from among the chemicals used to demonstrate the acceptable performance of the validated test method; and (iii) the comparable levels of accuracy and reliability, based on what was obtained for the validated test method, that the proposed test method should demonstrate when evaluated using the minimum list of Reference Chemicals (9).

PC: Positive Control, a replicate containing all components of a test system and treated with a chemical known to induce a positive response. To ensure that variability in the positive control response across time can be assessed, the magnitude of the positive response should not be excessive.

Relevance: Description of relationship of the test to the effect of interest and whether it is meaningful and useful for a particular purpose. It is the extent to which the test correctly measures or predicts the biological effect of interest. Relevance incorporates consideration of the accuracy (concordance) of a test method (9).

Reliability: Measures of the extent that a test method can be performed reproducibly within and between laboratories over time, when performed using the same protocol. It is assessed by calculating intra- and inter-laboratory reproducibility (9).

Replacement test: A test which is designed to substitute for a test that is in routine use and accepted for hazard identification and/or risk assessment, and which has been determined to provide equivalent or improved protection of human or animal health or the environment, as applicable, compared to the accepted test, for all possible testing situations and chemicals (9).

Run: A run consists of one or more test chemicals tested concurrently with a negative control and with a PC.

Sensitivity: The proportion of all positive/active test chemicals that are correctly classified by the test. It is a measure of accuracy for a test method that produces categorical results, and is an important consideration in assessing the relevance of a test method (9).

▼M8

Skin irritation *in vivo*: The production of reversible damage to the skin following the application of a test chemical for up to 4 hours. Skin irritation is a locally arising reaction of the affected skin tissue and appears shortly after stimulation (38). It is caused by a local inflammatory reaction involving the innate (non-specific) immune system of the skin tissue. Its main characteristic is its reversible process involving inflammatory reactions and most of the clinical characteristic signs of irritation (erythema, oedema, itching and pain) related to an inflammatory process.

Specificity: The proportion of all negative/inactive test chemicals that are correctly classified by the test. It is a measure of accuracy for a test method that produces categorical results and is an important consideration in assessing the relevance of a test method (9).

Substance: A chemical element and its compounds in the natural state or obtained by any production process, including any additive necessary to preserve its stability and any impurities deriving from the process used, but excluding any solvent which may be separated without affecting the stability of the substance or changing its composition.

Test chemical: Any substance or mixture tested using this test method.

UPLC: Ultra-High Performance Liquid Chromatography.

UVCB: substances of unknown or variable composition, complex reaction products or biological materials.

▼ M8

Appendix 2

TEST MODELS INCLUDED IN THIS TEST METHOD

Nr.	Test model name	Validation study type	References
1	EpiSkin™	Full prospective validation study (2003-2007). The components of this model were used to define the essential test method components of the original and updated ECVAM PS (39) (40) (21) (*). Moreover, the method's data relating to identification of non-classified vs classified substances formed the main basis for defining the specificity and sensitivity values of the original PS (*).	(2) (10) (11) (14) (15) (16) (17) (18) (19) (20) (21) (23) (32) (39) (40)
2	EpiDerm™ SIT (EPI-200)	EpiDerm™ (original): Initially the test model underwent full prospective validation together with Nr. 1. from 2003-2007. The components of this model were used to define the essential test methods components of the original and updated ECVAM PS (39) (40) (21) (*). EpiDerm™ SIT (EPI-200): A modification of the original EpiDerm™ was validated using the original ECVAM PS (21) in 2008 (*).	(2) (10) (12) (13) (15) (16) (17) (18) (20) (21) (23) (33) (39) (40) (2) (21) (22) (23) (33)
3	SkinEthic™ RHE	Validation study based on the original ECVAM Performance Standards (21) in 2008 (*).	(2) (21) (22) (23) (31)
4	LabCyte EPI-MODEL24 SIT	Validation study (2011-2012) based on the Performance Standards (PS) of OECD TG 439 (8) which are based on the updated ECVAM PS (*) (39) (40).	(24) (25) (26) (27) (28) (35) (39) (40) and PS of this TG (8) (*)

(*) The original ECVAM Performance Standards (PS) (21) were developed in 2007 upon completion of the prospective validation study (16) which had assessed the performance of test models Nr 1 and 2 in reference to the classification system as described in the 28th amendment to the EU Dangerous Substances Directive (41). In 2008 the UN GHS (1) and EU CLP were introduced, effectively shifting the cut-off value for distinguishing non-classified from classified substances from an *in vivo* score of 2.0 to 2.3. To adapt to this changed regulatory requirement, the accuracy values and reference chemical list of the ECVAM PS were updated in 2009 (2) (39) (40). As the original PS, also the updated PS were largely based on data from models Nr. 1 and 2 (16), but additionally used data on reference chemicals from model Nr. 3. In 2010, the updated ECVAM PS were used for stipulating the PS related to this TG (8). For the purpose of this test method, EpiSkin™ is considered the VRM, due to the fact that it was used to develop all the criteria of the PS. Detailed information on the validation studies, a compilation of the data generated as well as background to the necessary adaptations of the PS as a consequence of the UN GHS/CLP implementation can be found in the ECVAM/BfR explanatory background document to the corresponding OECD TG 439 (23).

SIT: Skin Irritation Test

RHE: Reconstructed Human Epidermis

▼ **M8***Appendix 3*

PROTOCOL PARAMETERS SPECIFIC TO EACH OF THE TEST MODELS
INCLUDED IN THIS TEST METHOD

The RhE models do show very similar protocols and notably all use a post-incubation period of 42 hours (32) (33) (34) (35). Variations concern mainly three parameters relating to the different barrier functions of the test models and listed here: A) pre-incubation time and volume, B) Application of test chemicals and C) Post-incubation volume.

	EpiSkin™ (SM)	EpiDerm™ SIT (EPI-200)	SkinEthic RHE™	LabCyte EPI-MODEL24 SIT
--	---------------	------------------------	----------------	-------------------------

A) Pre-incubation

Incubation time	18-24 hours	18-24 hours	< 2 hours	15-30 hours
Medium volume	2ml	0,9ml	0,3 or 1ml	0,5ml

B) Test chemical application

For liquids	10µl (26µl/cm ²)	30µl (47µl/cm ²)	16µl (32µl/cm ²)	25µl (83µl/cm ²)
For solids	10mg (26mg/cm ²)+ DW (5µl)	25mg (39mg/cm ²)+ DPBS (25µl)	16mg (32mg/cm ²)+ DW (10µl)	25mg (83mg/cm ²)+ DW (25µl)
Use of nylon mesh	Not used	If necessary	Applied	Not used
Total application time	15 minutes	60 minutes	42 minutes	15 minutes
Application temperature	RT	a) at RT for 25 minutes b) at 37°C for 35 minutes	RT	RT

C) Post-incubation volume

Medium volume	2 ml	0,9ml x 2	2 ml	1 ml
---------------	------	-----------	------	------

D) Maximum acceptable variability

Standard deviation between tissue replicates	SD≤18	SD≤18	SD≤18	SD≤18
--	-------	-------	-------	-------

RT: Room temperature

DW: distilled water

DPBS: Dulbecco's Phosphate Buffer Saline

▼ M8

Appendix 4

KEY PARAMETERS AND ACCEPTANCE CRITERIA FOR QUALIFICATION OF AN HPLC/UPLC-SPECTROPHOTOMETRY SYSTEM FOR MEASUREMENT OF MTT FORMAZAN EXTRACTED FROM RHE TISSUES

Parameter	Protocol Derived from FDA Guidance (36) (37)	Acceptance Criteria
Selectivity	Analysis of isopropanol, living blank (isopropanol extract from living RhE tissues without any treatment), dead blank (isopropanol extract from killed RhE tissues without any treatment)	$Area_{interference} \leq 20 \% \text{ of } Area_{LLOQ}^{(1)}$
Precision	Quality Controls (i.e. MTT formazan at 1,6 µg/ml, 16 µg/ml and 160 µg/ml) in isopropanol (n=5)	$CV \leq 15 \% \text{ or } \leq 20 \% \text{ for the LLOQ}$
Accuracy	Quality Controls in isopropanol (n=5)	$\%Dev \leq 15 \% \text{ or } \leq 20 \% \text{ for LLOQ}$
Matrix Effect	Quality Controls in living blank (n=5)	$85 \% \leq \text{Matrix Effect } \% \leq 115 \%$
Carryover	Analysis of isopropanol after an ULOQ ⁽²⁾ standard	$Area_{interference} \leq 20 \% \text{ of } Area_{LLOQ}$
Reproducibility (intra-day)	3 independent calibration curves (based on 6 consecutive 1/3 dilutions of MTT formazan in isopropanol starting at ULOQ, i.e. 200 µg/ml); Quality Controls in isopropanol (n=5)	$Calibration \text{ Curves: } \%Dev \leq 15 \% \text{ or } \leq 20 \% \text{ for LLOQ}$ $Quality \text{ Controls: } \%Dev \leq 15 \% \text{ and } CV \leq 15 \%$
Reproducibility (inter-day)	Day 1: 1 calibration curve and Quality Controls in isopropanol (n=3) Day 2: 1 calibration curve and Quality Controls in isopropanol (n=3) Day 3: 1 calibration curve and Quality Controls in isopropanol (n=3)	
Short Term Stability of MTT Formazan in RhE Tissue Extract	Quality Controls in living blank (n=3) analysed the day of the preparation and after 24 hours of storage at room temperature	$\%Dev \leq 15 \%$
Long Term Stability of MTT Formazan in RhE Tissue Extract, if required	Quality Controls in living blank (n=3) analysed the day of the preparation and after several days of storage at a specified temperature (e.g. 4°C, -20°C, -80°C)	$\%Dev \leq 15 \%$

⁽¹⁾ LLOQ: Lower Limit of Quantification, defined to cover 1-2 % tissue viability, i.e. 0,8 µg/ml.⁽²⁾ ULOQ: Upper Limit of Quantification, defined to be at least two times higher than the highest expected MTT formazan concentration in isopropanol extracts from negative controls i.e. 200 µg/ml.

▼M7**B.47. BOVINE CORNEAL OPACITY AND PERMEABILITY TEST METHOD FOR IDENTIFYING (I) CHEMICALS INDUCING SERIOUS EYE DAMAGE AND (II) CHEMICALS NOT REQUIRING CLASSIFICATION FOR EYE IRRITATION OR SERIOUS EYE DAMAGE**

INTRODUCTION

This test method is equivalent to OECD test guideline (TG) 437 (2013). The Bovine Corneal Opacity and Permeability (BCOP) test method was evaluated by the Interagency Coordinating Committee on the Validation of Alternative Methods (ICCVAM), in conjunction with the European Centre for the Validation of Alternative Methods (ECVAM) and the Japanese Center for the Validation of Alternative Methods (JaCVAM), in 2006 and 2010 (1)(2). In the first evaluation, the BCOP test method was evaluated for its usefulness to identify chemicals (substances and mixtures) inducing serious eye damage (1). In the second evaluation, the BCOP test method was evaluated for its usefulness to identify chemicals (substances and mixtures) not classified for eye irritation or serious eye damage (2). The BCOP validation database contained 113 substances and 100 mixtures in total (2)(3). From these evaluations and their peer review it was concluded that the test method can correctly identify chemicals (both substances and mixtures) inducing serious eye damage (Category 1) as well as those not requiring classification for eye irritation or serious eye damage, as defined by the United Nations (UN) Globally Harmonized System of Classification and Labelling of Chemicals (GHS) (4) and Regulation (EC) No 1272/2008 on Classification, Labelling and Packaging of Substances and Mixtures (CLP) (1) and it was therefore endorsed as scientifically valid for both purposes. Serious eye damage is the production of tissue damage in the eye, or serious physical decay of vision, following application of a test chemical to the anterior surface of the eye, which is not fully reversible within 21 days of application. Test chemicals inducing serious eye damage are classified as UN GHS Category 1. Chemicals not classified for eye irritation or serious eye damage are defined as those that do not meet the requirements for classification as UN GHS Category 1 or 2 (2A or 2B), i.e. they are referred to as UN GHS No Category. This test method includes the recommended use and limitations of the BCOP test method based on its evaluations. The main differences between the original 2009 version and the updated 2013 version of the OECD test guideline concern, but are not limited to: the use of the BCOP test method to identify chemicals not requiring classification according to UN GHS (paragraphs 2 and 7); clarifications on the applicability of the BCOP test method to the testing of alcohols, ketones and solids (paragraphs 6 and 7) and of substances and mixtures (paragraph 8); clarifications on how surfactant substances and surfactant-containing mixtures should be tested (paragraph 28); updates and clarifications regarding the positive controls (paragraphs 39 and 40); an update of the BCOP test method decision criteria (paragraph 47); an update of the study acceptance criteria (paragraph 48); an update to the test report elements (paragraph 49); an update of Appendix 1 on definitions; the addition of Appendix 2 for the predictive capacity of the BCOP test method under various classification systems; an update of Appendix 3 on the list of proficiency chemicals; and an update of Appendix 4 on the BCOP corneal holder (paragraph 1) and on the opacitometer (paragraphs 2 and 3).

(1) Regulation (EC) No 1272/2008 of the European Parliament and of the Council of 16 December 2008 on classification, labelling and packaging of substances and mixtures, amending and repealing Directives 67/548/EEC and 1999/45/EC, and amending Regulation (EC) No 1907/2006 (OJ L 353, 31.12.2008, p. 1).

▼ M7

It is currently generally accepted that, in the foreseeable future, no single *in vitro* eye irritation test will be able to replace the *in vivo* Draize eye test to predict across the full range of irritation for different chemical classes. However, strategic combinations of several alternative test methods within a (tiered) testing strategy may be able to replace the Draize eye test (5). The Top-Down approach (5) is designed to be used when, based on existing information, a chemical is expected to have high irritancy potential, while the Bottom-Up approach (5) is designed to be used when, based on existing information, a chemical is expected not to cause sufficient eye irritation to require a classification. The BCOP test method is an *in vitro* test method that can be used under certain circumstances and with specific limitations for eye hazard classification and labeling of chemicals. While it is not considered valid as a stand-alone replacement for the *in vivo* rabbit eye test, the BCOP test method is recommended as an initial step within a testing strategy such as the Top-Down approach suggested by Scott *et al.* (5) to identify chemicals inducing serious eye damage, i.e. chemicals to be classified as UN GHS Category 1, without further testing (4). The BCOP test method is also recommended to identify chemicals that do not require classification for eye irritation or serious eye damage, as defined by the UN GHS (UN GHS No Category) (4) within a testing strategy such as the Bottom-up approach (5). However, a chemical that is not predicted as causing serious eye damage or as not classified for eye irritation/serious eye damage with the BCOP test method would require additional testing (*in vitro* and/or *in vivo*) to establish a definitive classification.

The purpose of this test method is to describe the procedures used to evaluate the eye hazard potential of a test chemical as measured by its ability to induce opacity and increased permeability in an isolated bovine cornea. Toxic effects to the cornea are measured by: (i) decreased light transmission (opacity), and (ii) increased passage of sodium fluorescein dye (permeability). The opacity and permeability assessments of the cornea following exposure to a test chemical are combined to derive an *In Vitro* Irritancy Score (IVIS), which is used to classify the irritancy level of the test chemical.

Definitions are provided in Appendix 1.

INITIAL CONSIDERATIONS AND LIMITATIONS

This test method is based on the ICCVAM BCOP test method protocol (6)(7), which was originally developed from information obtained from the Institute for *in vitro* Sciences (IIVS) protocol and INVITTOX Protocol 124 (8). The latter represents the protocol used for the European Community-sponsored prevalidation study conducted in 1997-1998. Both of these protocols were based on the BCOP test method first reported by Gautheron *et al.* (9).

The BCOP test method can be used to identify chemicals inducing serious eye damage as defined by UN GHS, i.e. chemicals to be classified as UN GHS Category 1 (4). When used for this purpose, the BCOP test method has an

▼ M7

overall accuracy of 79 % (150/191), a false positive rate of 25 % (32/126), and a false negative rate of 14 % (9/65), when compared to *in vivo* rabbit eye test method data classified according to the UN GHS classification system (3) (see Appendix 2, Table 1). When test chemicals within certain chemical (i.e., alcohols, ketones) or physical (i.e., solids) classes are excluded from the database, the BCOP test method has an overall accuracy of 85 % (111/131), a false positive rate of 20 % (16/81), and a false negative rate of 8 % (4/50) for the UN GHS classification system (3). The potential shortcomings of the BCOP test method when used to identify chemicals inducing serious eye damage (UN GHS Category 1) are based on the high false positive rates for alcohols and ketones and the high false negative rate for solids observed in the validation database (1)(2)(3). However, since not all alcohols and ketones are over-predicted by the BCOP test method and some are correctly predicted as UN GHS Category 1, these two organic functional groups are not considered to be out of the applicability domain of the test method. It is up to the user of this test method to decide if a possible over-prediction of an alcohol or ketone can be accepted or if further testing should be performed in a weight-of-evidence approach. Regarding the false negative rates for solids, it should be noted that solids may lead to variable and extreme exposure conditions in the *in vivo* Draize eye irritation test, which may result in irrelevant predictions of their true irritation potential (10). It should also be noted that none of the false negatives identified in the ICCVAM validation database (2)(3), in the context of identifying chemicals inducing serious eye damage (UN GHS Category 1), resulted in $IVIS \leq 3$, which is the criterion used to identify a test chemical as a UN GHS No Category. Moreover, BCOP false negatives in this context are not critical since all test chemicals that produce an $3 < IVIS \leq 55$ would be subsequently tested with other adequately validated *in vitro* tests, or as a last option in rabbits, depending on regulatory requirements, using a sequential testing strategy in a weight-of-evidence approach. Given the fact that some solid chemicals are correctly predicted by the BCOP test method as UN GHS Category 1, this physical state is also not considered to be out of the applicability domain of the test method. Investigators could consider using this test method for all types of chemicals, whereby an $IVIS > 55$ should be accepted as indicative of a response inducing serious eye damage that should be classified as UN GHS Category 1 without further testing. However, as already mentioned, positive results obtained with alcohols or ketones should be interpreted cautiously due to potential over-prediction.

The BCOP test method can also be used to identify chemicals that do not require classification for eye irritation or serious eye damage under the UN GHS classification system (4). When used for this purpose, the BCOP test method has an overall accuracy of 69 % (135/196), a false positive rate of 69 % (61/89), and a false negative rate of 0 % (0/107), when compared to *in vivo* rabbit eye test method data classified according to the UN GHS classification system (3) (see Appendix 2, Table 2). The false positive rate obtained (*in vivo* UN GHS No Category chemicals producing an $IVIS > 3$, see paragraph 47) is considerably high, but not critical in this context since all test chemicals that produce an $3 < IVIS \leq 55$ would be subsequently tested with other adequately validated *in vitro* tests, or as a last option in rabbits, depending on regulatory requirements, using a sequential testing strategy in a weight-of-evidence approach. The BCOP test method shows no specific shortcomings for the testing of alcohols, ketones and solids when the purpose is to identify chemicals that do not require classification for eye irritation or serious eye damage (UN GHS No Category) (3). Investigators could consider using this test method for all types of chemicals, whereby a negative result ($IVIS \leq 3$) should be accepted as indicative that no classification is required (UN GHS No Category). Since the BCOP test method can only identify correctly 31 % of the chemicals that do not require classification for eye irritation or serious eye damage, this test method should not be the first choice to initiate a Bottom-Up approach (5), if other validated and accepted *in vitro* methods with similar high sensitivity but higher specificity are available.

▼M7

The BCOP validation database contained 113 substances and 100 mixtures in total (2)(3). The BCOP test method is therefore considered applicable to the testing of both substances and mixtures.

The BCOP test method is not recommended for the identification of test chemicals that should be classified as irritating to eyes (UN GHS Category 2 or Category 2A) or test chemicals that should be classified as mildly irritating to eyes (UN GHS Category 2B) due to the considerable number of UN GHS Category 1 chemicals underclassified as UN GHS Category 2, 2A or 2B and UN GHS No Category chemicals overclassified as UN GHS Category 2, 2A or 2B (2)(3). For this purpose, further testing with another suitable method may be required.

All procedures with bovine eyes and bovine corneas should follow the testing facility's applicable regulations and procedures for handling animal-derived materials, which include, but are not limited to, tissues and tissue fluids. Universal laboratory precautions are recommended (11).

Whilst the BCOP test method does not consider conjunctival and iridal injuries, it addresses corneal effects, which are the major driver of classification *in vivo* when considering the UN GHS classification. The reversibility of corneal lesions cannot be evaluated *per se* in the BCOP test method. It has been proposed, based on rabbit eye studies, that an assessment of the initial depth of corneal injury may be used to identify some types of irreversible effects (12). However, further scientific knowledge is required to understand how irreversible effects not linked with initial high level injury occur. Finally, the BCOP test method does not allow for an assessment of the potential for systemic toxicity associated with ocular exposure.

This test method will be updated periodically as new information and data are considered. For example, histopathology may be potentially useful when a more complete characterisation of corneal damage is needed. As outlined in OECD Guidance Document No. 160 (13), users are encouraged to preserve corneas and prepare histopathology specimens that can be used to develop a database and decision criteria that may further improve the accuracy of this test method.

For any laboratory initially establishing this test method, the proficiency chemicals provided in Appendix 3 should be used. A laboratory can use these chemicals to demonstrate their technical competence in performing the BCOP test method prior to submitting BCOP test method data for regulatory hazard classification purposes.

PRINCIPLE OF THE TEST

The BCOP test method is an organotypic model that provides short-term maintenance of normal physiological and biochemical function of the bovine cornea *in vitro*. In this test method, damage by the test chemical is assessed by quantitative measurements of changes in corneal opacity and permeability with an opacimeter and a visible light spectrophotometer, respectively. Both measurements are used to calculate an IVIS, which is used to assign an *in vitro* irritancy hazard classification category for prediction of the *in vivo* ocular irritation potential of a test chemical (see Decision Criteria in paragraph 48).

The BCOP test method uses isolated corneas from the eyes of freshly slaughtered cattle. Corneal opacity is measured quantitatively as the amount of light transmission through the cornea. Permeability is measured quantitatively as the amount of sodium fluorescein dye that passes across the full thickness of the cornea, as detected in the medium in the posterior chamber. Test chemicals are

▼ M7

applied to the epithelial surface of the cornea by addition to the anterior chamber of the corneal holder. Appendix 4 provides a description and a diagram of a corneal holder used in the BCOP test method. Corneal holders can be obtained commercially from different sources or can be constructed.

Source and Age of Bovine Eyes and Selection of Animal Species

Cattle sent to slaughterhouses are typically killed either for human consumption or for other commercial uses. Only healthy animals considered suitable for entry into the human food chain are used as a source of corneas for use in the BCOP test method. Because cattle have a wide range of weights, depending on breed, age, and sex, there is no recommended weight for the animal at the time of slaughter.

Variations in corneal dimensions can result when using eyes from animals of different ages. Corneas with a horizontal diameter $> 30,5$ mm and central corneal thickness (CCT) values $\geq 1\ 100$ μm are generally obtained from cattle older than eight years, while those with a horizontal diameter $< 28,5$ mm and CCT < 900 μm are generally obtained from cattle less than five years old (14). For this reason, eyes from cattle greater than 60 months old are not typically used. Eyes from cattle less than 12 months of age have not traditionally been used since the eyes are still developing and the corneal thickness and corneal diameter are considerably smaller than that reported for eyes from adult cattle. However, the use of corneas from young animals (*i.e.*, 6 to 12 months old) is permissible since there are some advantages, such as increased availability, a narrow age range, and decreased hazards related to potential worker exposure to Bovine Spongiform Encephalopathy (15). As further evaluation of the effect of corneal size or thickness on responsiveness to corrosive and irritant chemicals would be useful, users are encouraged to report the estimated age and/or weight of the animals providing the corneas used in a study.

Collection and Transport of Eyes to the Laboratory

Eyes are collected by slaughterhouse employees. To minimise mechanical and other types of damage to the eyes, the eyes should be enucleated as soon as possible after death and cooled immediately after enucleation and during transport. To prevent exposure of the eyes to potentially irritant chemicals, the slaughterhouse employees should not use detergent when rinsing the head of the animal.

Eyes should be immersed completely in cooled Hanks' Balanced Salt Solution (HBSS) in a suitably sized container, and transported to the laboratory in such a manner as to minimise deterioration and/or bacterial contamination. Because the eyes are collected during the slaughter process, they might be exposed to blood and other biological materials, including bacteria and other microorganisms. Therefore, it is important to ensure that the risk of contamination is minimised (e.g., by keeping the container containing the eyes on wet ice during collection and transportation and by adding antibiotics to the HBSS used to store the eyes during transport [e.g. penicillin at 100 IU/ml and streptomycin at 100 $\mu\text{g}/\text{ml}$]).

The time interval between collection of the eyes and use of corneas in the BCOP test method should be minimised (typically collected and used on the same day) and should be demonstrated to not compromise the assay results. These results are based on the selection criteria for the eyes, as well as the positive and negative control responses. All eyes used in the assay should be from the same group of eyes collected on a specific day.

Selection Criteria for Eyes Used in the BCOP Test Method

The eyes, once they arrive at the laboratory, are carefully examined for defects including increased opacity, scratches, and neovascularisation. Only corneas from eyes free of such defects are to be used.

▼ M7

The quality of each cornea is also evaluated at later steps in the assay. Corneas that have opacity greater than seven opacity units or equivalent for the opacitometer and cornea holders used after an initial one hour equilibration period are to be discarded (*NOTE*: the opacitometer should be calibrated with opacity standards that are used to establish the opacity units, see Appendix 4).

Each treatment group (test chemical, concurrent negative and positive controls) consists of a minimum of three eyes. Three corneas should be used for the negative control corneas in the BCOP test method. Since all corneas are excised from the whole globe, and mounted in the corneal chambers, there is potential for artifacts from handling upon individual corneal opacity and permeability values (including negative control). Furthermore, the opacity and permeability values from the negative control corneas are used to correct the test chemical-treated and positive control-treated corneal opacity and permeability values in the IVIS calculations.

PROCEDURE**Preparation of the Eyes**

Corneas, free of defects, are dissected with a 2 to 3 mm rim of sclera remaining to assist in subsequent handling, with care taken to avoid damage to the corneal epithelium and endothelium. Isolated corneas are mounted in specially designed corneal holders that consist of anterior and posterior compartments, which interface with the epithelial and endothelial sides of the cornea, respectively. Both chambers are filled to excess with pre-warmed phenol red free Eagle's Minimum Essential Medium (EMEM) (posterior chamber first), ensuring that no bubbles are formed. The device is then equilibrated at 32 ± 1 °C for at least one hour to allow the corneas to equilibrate with the medium and to achieve normal metabolic activity, to the extent possible (the approximate temperature of the corneal surface *in vivo* is 32 °C).

Following the equilibration period, fresh pre-warmed phenol red free EMEM is added to both chambers and baseline opacity readings are taken for each cornea. Any corneas that show macroscopic tissue damage (e.g. scratches, pigmentation, neovascularisation) or an opacity greater than seven opacity units or equivalent for the opacitometer and cornea holders used are discarded. A minimum of three corneas are selected as negative (or solvent) control corneas. The remaining corneas are then distributed into treatment and positive control groups.

Because the heat capacity of water is higher than that of air, water provides more stable temperature conditions for incubation. Therefore, the use of a water bath for maintaining the corneal holder and its contents at 32 ± 1 °C is recommended. However, air incubators might also be used, assuming precaution to maintain temperature stability (e.g. by pre-warming of holders and media).

Application of the Test Chemical

Two different treatment protocols are used, one for liquids and surfactants (solids or liquids), and one for non-surfactant solids.

Liquids are tested undiluted. Semi-solids, creams, and waxes are typically tested as liquids. Neat surfactant substances are tested at a concentration of 10 % w/v in a 0.9 % sodium chloride solution, distilled water, or other solvent that has been demonstrated to have no adverse effects on the test system. Appropriate justification should be provided for alternative dilution concentrations. Mixtures

▼ M7

containing surfactants may be tested undiluted or diluted to an appropriate concentration depending on the relevant exposure scenario *in vivo*. Appropriate justification should be provided for the concentration tested. Corneas are exposed to liquids and surfactants for 10 minutes. Use of other exposure times should be accompanied by adequate scientific rationale. Please see Appendix 1 for a definition of surfactant and surfactant-containing mixture.

Non-surfactant solids are typically tested as solutions or suspensions at 20 % w/v concentration in a 0,9 % sodium chloride solution, distilled water, or other solvent that has been demonstrated to have no adverse effects on the test system. In certain circumstances and with proper scientific justification, solids may also be tested neat by direct application onto the corneal surface using the open chamber method (see paragraph 32). Corneas are exposed to solids for four hours, but as with liquids and surfactants, alternative exposure times may be used with appropriate scientific rationale.

Different treatment methods can be used, depending on the physical nature and chemical characteristics (e.g. solids, liquids, viscous vs. non-viscous liquids) of the test chemical. The critical factor is ensuring that the test chemical adequately covers the epithelial surface and that it is adequately removed during the rinsing steps. A closed-chamber method is typically used for non-viscous to slightly viscous liquid test chemicals, while an open-chamber method is typically used for semi-viscous and viscous liquid test chemicals and for neat solids.

In the closed-chamber method, sufficient test chemical (750 µl) to cover the epithelial side of the cornea is introduced into the anterior chamber through the dosing holes on the top surface of the chamber, and the holes are subsequently sealed with the chamber plugs during the exposure. It is important to ensure that each cornea is exposed to a test chemical for the appropriate time interval.

In the open-chamber method, the window-locking ring and glass window from the anterior chamber are removed prior to treatment. The control or test chemical (750 µl, or enough test chemical to completely cover the cornea) is applied directly to the epithelial surface of the cornea using a micro-pipet. If a test chemical is difficult to pipet, the test chemical can be pressure-loaded into a positive displacement pipet to aid in dosing. The pipet tip of the positive displacement pipet is inserted into the dispensing tip of the syringe so that the material can be loaded into the displacement tip under pressure. Simultaneously, the syringe plunger is depressed as the pipet piston is drawn upwards. If air bubbles appear in the pipet tip, the test chemical is removed (expelled) and the process repeated until the tip is filled without air bubbles. If necessary, a normal syringe (without a needle) can be used since it permits measuring an accurate volume of test chemical and an easier application to the epithelial surface of the cornea. After dosing, the glass window is replaced on the anterior chamber to recreate a closed system.

Post-Exposure Incubation

After the exposure period, the test chemical, the negative control, or the positive control chemical is removed from the anterior chamber and the epithelium washed at least three times (or until no visual evidence of test chemical can be observed) with EMEM (containing phenol red). Phenol red- containing medium is used for rinsing since a colour change in the phenol red may be monitored to determine the effectiveness of rinsing acidic or alkaline test chemicals. The corneas are washed more than three times if the phenol red is still discoloured (yellow or purple), or the test chemical is still visible. Once the medium is free of test chemical, the corneas are given a final rinse with EMEM (without phenol red). The EMEM (without phenol red) is used as a final rinse to

▼M7

ensure removal of the phenol red from the anterior chamber prior to the opacity measurement. The anterior chamber is then refilled with fresh EMEM without phenol red.

For liquids or surfactants, after rinsing, the corneas are incubated for an additional two hours at 32 ± 1 °C. Longer post-exposure time may be useful in certain circumstances and could be considered on a case-by-case basis. Corneas treated with solids are rinsed thoroughly at the end of the four-hour exposure period, but do not require further incubation.

At the end of the post-exposure incubation period for liquids and surfactants and at the end of the four-hour exposure period for non-surfactant solids, the opacity and permeability of each cornea are recorded. Also, each cornea is observed visually and pertinent observations recorded (e.g., tissue peeling, residual test chemical, non-uniform opacity patterns). These observations could be important as they may be reflected by variations in the opacitometer readings.

Control Chemicals

Concurrent negative or solvent/vehicle controls and positive controls are included in each experiment.

When testing a liquid substance at 100 %, a concurrent negative control (e.g. 0,9 % sodium chloride solution or distilled water) is included in the BCOP test method so that nonspecific changes in the test system can be detected and to provide a baseline for the assay endpoints. It also ensures that the assay conditions do not inappropriately result in an irritant response.

When testing a diluted liquid, surfactant, or solid, a concurrent solvent/vehicle control group is included in the BCOP test method so that nonspecific changes in the test system can be detected and to provide a baseline for the assay endpoints. Only a solvent/vehicle that has been demonstrated to have no adverse effects on the test system can be used.

A chemical known to induce a positive response is included as a concurrent positive control in each experiment to verify the integrity of the test system and its correct conduct. However, to ensure that variability in the positive control response across time can be assessed, the magnitude of irritant response should not be excessive.

Examples of positive controls for liquid test chemicals are 100 % ethanol or 100 % dimethylformamide. An example of a positive control for solid test chemicals is 20 % w/v imidazole in 0,9 % sodium chloride solution.

Benchmark chemicals are useful for evaluating the ocular irritancy potential of unknown chemicals of a specific chemical or product class, or for evaluating the relative irritancy potential of an ocular irritant within a specific range of irritant responses.

Endpoints Measured

Opacity is determined by the amount of light transmission through the cornea. Corneal opacity is measured quantitatively with the aid of an opacitometer, resulting in opacity values measured on a continuous scale.

Permeability is determined by the amount of sodium fluorescein dye that penetrates all corneal cell layers (*i.e.*, the epithelium on the outer cornea surface through the endothelium on the inner cornea surface). One ml sodium

▼M7

fluorescein solution (4 or 5 mg/ml when testing liquids and surfactants or non-surfactant solids, respectively) is added to the anterior chamber of the corneal holder, which interfaces with the epithelial side of the cornea, while the posterior chamber, which interfaces with the endothelial side of the cornea, is filled with fresh EMEM. The holder is then incubated in a horizontal position for 90 ± 5 min at 32 ± 1 °C. The amount of sodium fluorescein that crosses into the posterior chamber is quantitatively measured with the aid of UV/VIS spectrophotometry. Spectrophotometric measurements evaluated at 490 nm are recorded as optical density (OD₄₉₀) or absorbance values, which are measured on a continuous scale. The fluorescein permeability values are determined using OD₄₉₀ values based upon a visible light spectrophotometer using a standard 1 cm path length.

Alternatively, a 96-well microtiter plate reader may be used provided that; (i) the linear range of the plate reader for determining fluorescein OD₄₉₀ values can be established; and (ii), the correct volume of fluorescein samples are used in the 96-well plate to result in OD₄₉₀ values equivalent to the standard 1 cm path length (this could require a completely full well [usually 360 µl]).

DATA AND REPORTING**Data Evaluation**

Once the opacity and mean permeability (OD₄₉₀) values have been corrected for background opacity and the negative control permeability OD₄₉₀ values, the mean opacity and permeability OD₄₉₀ values for each treatment group should be combined in an empirically-derived formula to calculate an *in vitro* irritancy score (IVIS) for each treatment group as follows:

$$\text{IVIS} = \text{mean opacity value} + (15 \times \text{mean permeability OD}_{490} \text{ value})$$

Sina *et al.* (16) reported that this formula was derived during in-house and inter-laboratory studies. The data generated for a series of 36 compounds in a multi-laboratory study were subjected to a multivariate analysis to determine the equation of best fit between *in vivo* and *in vitro* data. Scientists at two separate companies performed this analysis and derived nearly identical equations.

The opacity and permeability values should also be evaluated independently to determine whether a test chemical induced corrosivity or severe irritation through only one of the two endpoints (see Decision Criteria).

Decision Criteria

The IVIS cut-off values for identifying test chemicals as inducing serious eye damage (UN GHS Category 1) and test chemicals not requiring classification for eye irritation or serious eye damage (UN GHS No Category) are given hereafter:

IVIS	UN GHS
≤ 3	No Category
> 3; ≤ 55	No prediction can be made
> 55	Category 1

Study Acceptance Criteria

A test is considered acceptable if the positive control gives an IVIS that falls within two standard deviations of the current historical mean, which is to be updated at least every three months, or each time an acceptable test is conducted in laboratories where tests are conducted infrequently (*i.e.*, less than once a month). The negative or solvent/vehicle control responses should result in opacity and permeability values that are less than the established upper limits for background opacity and permeability values for bovine corneas treated with the respective negative or solvent/vehicle control. A single testing run composed of at least three corneas should be sufficient for a test chemical when the resulting classification is unequivocal. However, in cases of borderline results

▼M7

in the first testing run, a second testing run should be considered (but not necessarily required), as well as a third one in case of discordant mean IVIS results between the first two testing runs. In this context, a result in the first testing run is considered borderline if the predictions from the 3 corneas were non-concordant, such that:

- 2 of the 3 corneas gave discordant predictions from the mean of all 3 corneas, OR,
- 1 of the 3 corneas gave a discordant prediction from the mean of all 3 corneas, AND the discordant result was > 10 IVIS units from the cut-off threshold of 55.
- If the repeat testing run corroborates the prediction of the initial testing run (based upon the mean IVIS value), then a final decision can be taken without further testing. If the repeat testing run results in a non-concordant prediction from the initial testing run (based upon the mean IVIS value), then a third and final testing run should be conducted to resolve equivocal predictions, and to classify the test chemical. It may be permissible to waive further testing for classification and labeling in the event any testing run results in a UN GHS Category 1 prediction.

Test Report

The test report should include the following information, if relevant to the conduct of the study:

Test and Control Chemicals

- Chemical name(s) such as the structural name used by the Chemical Abstracts Service (CAS), followed by other names, if known; the CAS Registry Number (RN), if known;
- Purity and composition of the test/control chemical (in percentage(s) by weight), to the extent this information is available;
- Physicochemical properties such as physical state, volatility, pH, stability, chemical class, water solubility relevant to the conduct of the study;
- Treatment of the test/control chemicals prior to testing, if applicable (e.g. warming, grinding);
- Stability, if known.

Information Concerning the Sponsor and the Test Facility

- Name and address of the sponsor, test facility and study director.

Test Method Conditions

- Opacitometer used (e.g. model and specifications) and instrument settings;
- Calibration information for devices used for measuring opacity and permeability (e.g. opacitometer and spectrophotometer) to ensure linearity of measurements;
- Type of corneal holders used (e.g. model and specifications);

▼ M7

- Description of other equipment used;
- The procedure used to ensure the integrity (*i.e.*, accuracy and reliability) of the test method over time (e.g. periodic testing of proficiency chemicals).

Criteria for an Acceptable Test

- Acceptable concurrent positive and negative control ranges based on historical data;
- If applicable, acceptable concurrent benchmark control ranges based on historical data.

Eyes Collection and Preparation

- Identification of the source of the eyes (*i.e.*, the facility from which they were collected);
- Corneal diameter as a measure of age of the source animal and suitability for the assay;
- Storage and transport conditions of eyes (e.g. date and time of eye collection, time interval prior to initiating testing, transport media and temperature conditions, any antibiotics used);
- Preparation & mounting of the bovine corneas including statements regarding their quality, temperature of corneal holders, and criteria for selection of corneas used for testing.

Test Procedure

- Number of replicates used;
- Identity of the negative and positive controls used (if applicable, also the solvent and benchmark controls);
- Test chemical concentration(s), application, exposure time and post-exposure incubation time used;
- Description of evaluation and decision criteria used;
- Description of study acceptance criteria used;
- Description of any modifications of the test procedure;
- Description of decision criteria used.

Results

- Tabulation of data from individual test samples (e.g. opacity and OD490 values and calculated IVIS for the test chemical and the positive, negative, and benchmark controls [if included], reported in tabular form, including data from replicate repeat experiments as appropriate, and means \pm the standard deviation for each experiment);
- Description of other effects observed;
- The derived *in vitro* UN GHS classification, if applicable.

*Discussion of the Results**Conclusion*

▼ M7

LITERATURE:

- (1) ICCVAM (2006). Test Method Evaluation Report — *In Vitro* Ocular Toxicity Test Methods for Identifying Ocular Severe Irritants and Corrosives. Interagency Coordinating Committee on the Validation of Alternative Methods (ICCVAM) and the National Toxicology Program (NTP) Interagency Center for the Evaluation of Alternative Toxicological Methods (NICEATM). NIH Publication No.: 07-4517. Available: http://iccvam.niehs.nih.gov/methods/ocutox/ivocutox/ocu_tmter.htm.
- (2) ICCVAM (2010). ICCVAM Test Method Evaluation Report: Current Validation Status of *In Vitro* Test Methods Proposed for Identifying Eye Injury Hazard Potential of Chemicals and Products. NIH Publication No.10-7553. Research Triangle Park, NC: National Institute of Environmental Health Sciences. Available: <http://iccvam.niehs.nih.gov/methods/ocutox/MildMod-TMER.htm>.
- (3) OECD (2013). Streamlined Summary Document supporting the Test Guideline 437 for eye irritation/corrosion. Series on Testing and Assessment, No.189, OECD, Paris.
- (4) UN (2011). United Nations Globally Harmonized System of Classification and Labelling of Chemicals (GHS), ST/SG/AC.10/30 Rev 4, New York and Geneva: United Nations. Available: http://www.unece.org/trans/danger/publi/ghs/ghs_rev04/04files_e.html.
- (5) Scott, L., Eskes, C., Hoffmann, S., Adriaens, E., Alépée, N., Bufo, M., Clothier, R., Facchini, D., Faller, C., Guest, R., Harbell, J., Hartung, T., Kamp, H., Le Varlet, B., Meloni, M., McNamee, P., Osborne, R., Pape, W., Pfannenbecker, U., Prinsen, M., Seaman, C., Spielman, H., Stokes, W., Trouba, K., Van den Berghe, C., Van Goethem, F., Vassallo, M., Vinardell, P., and Zuang, V. (2010). A proposed eye irritation testing strategy to reduce and replace *in vivo* studies using Bottom-Up and Top-Down approaches. *Toxicol. in Vitro* 24:1-9.
- (6) ICCVAM (2006). ICCVAM Recommended BCOP Test Method Protocol. In: ICCVAM Test Method Evaluation Report — *in vitro* Ocular Toxicity Test Methods for Identifying Ocular Severe Irritants and Corrosives. Interagency Coordinating Committee on the Validation of Alternative Methods (ICCVAM) and the National Toxicology Program (NTP) Interagency Center for the Evaluation of Alternative Toxicological Methods (NICEATM). NIH Publication No.: 07-4517. Available: http://iccvam.niehs.nih.gov/methods/ocutox/ivocutox/ocu_tmter.htm.
- (7) ICCVAM (2010). ICCVAM Recommended BCOP Test Method Protocol. In: ICCVAM Test Method Evaluation Report — Current Validation Status of *In Vitro* Test Methods Proposed for Identifying Eye Injury Hazard Potential of Chemicals and Products. Interagency Coordinating Committee on the Validation of Alternative Methods (ICCVAM) and the National Toxicology Program (NTP) Interagency Center for the Evaluation of Alternative Toxicological Methods (NICEATM). NIH Publication No.: 10-7553A. Available: <http://iccvam.niehs.nih.gov/methods/ocutox/MildMod-TMER.htm>.
- (8) INVITTOX (1999). Protocol 124: Bovine Corneal Opacity and Permeability Assay — SOP of Microbiological Associates Ltd. Ispra, Italy: European Centre for the Validation of Alternative Methods (ECVAM).
- (9) Gautheron, P., Dukic, M., Alix, D. and Sina, J.F. (1992). Bovine corneal opacity and permeability test: An *in vitro* assay of ocular irritancy. *Fundam. Appl. Toxicol.* 18:442-449.
- (10) Prinsen, M.K. (2006). The Draize Eye Test and *in vitro* alternatives; a left-handed marriage? *Toxicol. in Vitro* 20:78-81.
- (11) Siegel, J.D., Rhinehart, E., Jackson, M., Chiarello, L., and the Healthcare Infection Control Practices Advisory Committee (2007). Guideline for Isolation Precautions: Preventing Transmission of Infectious Agents in Healthcare Settings. Available: [<http://www.cdc.gov/ncidod/dhqp/pdf>].

▼ M7

- (12) Maurer, J.K., Parker, R.D. and Jester, J.V. (2002). Extent of corneal injury as the mechanistic basis for ocular irritation: key findings and recommendations for the development of alternative assays. *Reg. Tox. Pharmacol.* 36:106-117.
- (13) OECD (2011). Guidance Document on The Bovine Corneal Opacity and Permeability (BCOP) and Isolated Chicken Eye (ICE) Test Methods: Collection of Tissues for Histological Evaluation and Collection of Data on Non-severe Irritants. Series on Testing and Assessment, No. 160. Adopted October 25, 2011. Paris: Organisation for Economic Co-operation and Development.
- (14) Doughty, M.J., Petrou, S. and Macmillan, H. (1995). Anatomy and morphology of the cornea of bovine eyes from a slaughterhouse. *Can. J. Zool.* 73:2159-2165.
- (15) Collee, J. and Bradley, R. (1997). BSE: A decade on — Part I. *The Lancet* 349: 636-641.
- (16) Sina, J.F., Galer, D.M., Sussman, R.S., Gautheron, P.D., Sargent, E.V., Leong, B., Shah, P.V., Curren, R.D., and Miller, K. (1995). A collaborative evaluation of seven alternatives to the Draize eye irritation test using pharmaceutical intermediates. *Fundam. Appl. Toxicol.* 26:20-31.
- (17) Chapter B.5 of this Annex, Acute eye irritation/corrosion.
- (18) ICCVAM (2006). Current Status of *In Vitro* Test Methods for Identifying Ocular Corrosives and Severe Irritants: Bovine Corneal Opacity and Permeability Test Method. NIH Publication No.: 06-4512. Research Triangle Park: National Toxicology Program. Available: [http://iccvam.niehs.nih.gov/methods/ocutox/ivocutox/ocu_brd_bcop.htm].
- (19) OECD (1998). Series on Good Laboratory Practice and Compliance Monitoring. No. 1: OECD Principles on Good Laboratory Practice (revised in 1997).

Available: at: http://www.oecd.org/document/63/0,3343,en_2649_34381_2346175_1_1_1_1,00.html

▼ M7*Appendix 1*

DEFINITIONS

Accuracy: The closeness of agreement between test method results and accepted reference values. It is a measure of test method performance and one aspect of 'relevance'. The term is often used interchangeably with 'concordance', to mean the proportion of correct outcomes of a test method.

Benchmark chemical: A chemical used as a standard for comparison to a test chemical. A benchmark chemical should have the following properties; (i) a consistent and reliable source(s); (ii) structural and functional similarity to the class of chemicals being tested; (iii) known physical/chemical characteristics; (iv) supporting data on known effects, and (v) known potency in the range of the desired response.

Bottom-Up Approach: step-wise approach used for a chemical suspected of not requiring classification for eye irritation or serious eye damage, which starts with the determination of chemicals not requiring classification (negative outcome) from other chemicals (positive outcome).

Chemical: A substance or a mixture.

Cornea: The transparent part of the front of the eyeball that covers the iris and pupil and admits light to the interior.

Corneal opacity: Measurement of the extent of opaqueness of the cornea following exposure to a test chemical. Increased corneal opacity is indicative of damage to the cornea. Opacity can be evaluated subjectively as done in the Draize rabbit eye test, or objectively with an instrument such as an 'opacitometer'.

Corneal permeability: Quantitative measurement of damage to the corneal epithelium by a determination of the amount of sodium fluorescein dye that passes through all corneal cell layers.

Eye irritation: Production of changes in the eye following the application of a test chemical to the anterior surface of the eye, which are fully reversible within 21 days of application. Interchangeable with 'Reversible effects on the eye' and with 'UN GHS Category 2' (4).

False negative rate: The proportion of all positive chemicals falsely identified by a test method as negative. It is one indicator of test method performance.

False positive rate: The proportion of all negative chemicals that are falsely identified by a test method as positive. It is one indicator of test method performance.

Hazard: Inherent property of an agent or situation having the potential to cause adverse effects when an organism, system or (sub) population is exposed to that agent.

In Vitro Irritancy Score (IVIS): An empirically-derived formula used in the BCOP test method whereby the mean opacity and mean permeability values for each treatment group are combined into a single *in vitro* score for each treatment group. The *IVIS* = mean opacity value + (15 × mean permeability value).

Irreversible effects on the eye: See 'Serious eye damage'.

▼ M7

Mixture: A mixture or a solution composed of two or more substances in which they do not react (4)

Negative control: An untreated replicate containing all components of a test system. This sample is processed with test chemical-treated samples and other control samples to determine whether the solvent interacts with the test system.

Not Classified: Chemicals that are not classified for Eye irritation (UN GHS Category 2, 2A, or 2B) or Serious eye damage (UN GHS Category 1). Interchangeable with 'UN GHS No Category'.

Opacitometer: An instrument used to measure 'corneal opacity' by quantitatively evaluating light transmission through the cornea. The typical instrument has two compartments, each with its own light source and photocell. One compartment is used for the treated cornea, while the other is used to calibrate and zero the instrument. Light from a halogen lamp is sent through a control compartment (empty chamber without windows or liquid) to a photocell and compared to the light sent through the experimental compartment, which houses the chamber containing the cornea, to a photocell. The difference in light transmission from the photocells is compared and a numeric opacity value is presented on a digital display.

Positive control: A replicate containing all components of a test system and treated with a chemical known to induce a positive response. To ensure that variability in the positive control response across time can be assessed, the magnitude of the positive response should not be excessive.

Reversible effects on the eye: See 'Eye irritation'.

Reliability: Measures of the extent that a test method can be performed reproducibly within and between laboratories over time, when performed using the same protocol. It is assessed by calculating intra- and inter-laboratory reproducibility and intra-laboratory repeatability.

Serious eye damage: Production of tissue damage in the eye, or serious physical decay of vision, following application of a test chemical to the anterior surface of the eye, which is not fully reversible within 21 days of application. Interchangeable with 'Irreversible effects on the eye' and with 'UN GHS Category 1' (4).

Solvent/vehicle control: An untreated sample containing all components of a test system, including the solvent or vehicle that is processed with the test chemical-treated samples and other control samples to establish the baseline response for the samples treated with the test chemical dissolved in the same solvent or vehicle. When tested with a concurrent negative control, this sample also demonstrates whether the solvent or vehicle interacts with the test system.

Substance: Chemical elements and their compounds in the natural state or obtained by any production process, including any additive necessary to preserve the stability of the product and any impurities deriving from the process used, but excluding any solvent which may be separated without affecting the stability of the substance or changing its composition (4).

▼ M7

Surfactant: Also called surface-active agent, this is a substance, such as a detergent, that can reduce the surface tension of a liquid and thus allow it to foam or penetrate solids; it is also known as a wetting agent.

Surfactant-containing mixture: In the context of this test method, it is a mixture containing one or more surfactants at a final concentration of > 5 %.

Top-Down Approach: step-wise approach used for a chemical suspected of causing serious eye damage, which starts with the determination of chemicals inducing serious eye damage (positive outcome) from other chemicals (negative outcome).

Test chemical: Any substance or mixture tested using this test method.

Tiered testing strategy: A stepwise testing strategy where all existing information on a test chemical is reviewed, in a specified order, using a weight-of-evidence process at each tier to determine if sufficient information is available for a hazard classification decision, prior to progression to the next tier. If the irritancy potential of a test chemical can be assigned based on the existing information, no additional testing is required. If the irritancy potential of a test chemical cannot be assigned based on the existing information, a step-wise sequential animal testing procedure is performed until an unequivocal classification can be made.

United Nations Globally Harmonized System of Classification and Labelling of Chemicals (UN GHS): A system proposing the classification of chemicals (substances and mixtures) according to standardised types and levels of physical, health and environmental hazards, and addressing corresponding communication elements, such as pictograms, signal words, hazard statements, precautionary statements and safety data sheets, so that to convey information on their adverse effects with a view to protect people (including employers, workers, transporters, consumers and emergency responders) and the environment (4).

UN GHS Category 1: See 'Serious eye damage'.

UN GHS Category 2: See 'Eye irritation'.

UN GHS No Category: Chemicals that do not meet the requirements for classification as UN GHS Category 1 or 2 (2A or 2B). Interchangeable with 'Not Classified'.

Validated test method: A test method for which validation studies have been completed to determine the relevance (including accuracy) and reliability for a specific purpose. It is important to note that a validated test method may not have sufficient performance in terms of accuracy and reliability to be found acceptable for the proposed purpose.

Weight-of-evidence: The process of considering the strengths and weaknesses of various pieces of information in reaching and supporting a conclusion concerning the hazard potential of a test chemical.

▼ **M7***Appendix 2***PREDICTIVE CAPACITY OF THE BCOP TEST METHOD***Table 1*

Predictive Capacity of BCOP for identifying chemicals inducing serious eye damage [UN GHS/EU CLP Cat 1 vs Not Cat 1 (Cat 2 + No Cat); US EPA Cat I vs Not Cat I (Cat II + Cat III + Cat IV)]

Classification System	No.	Accuracy		Sensitivity		False Negatives		Specificity		False Positives	
		%	No.	%	No.	%	No.	%	No.	%	No.
UN GHS EU CLP	191	78,53	150/191	86,15	56/65	13,85	9/65	74,60	94/126	25,40	32/126
US EPA	190	78,95	150/190	85,71	54/63	14,29	9/63	75,59	96/127	24,41	31/127

Table 2

Predictive Capacity of BCOP for identifying chemicals not requiring classification for eye irritation or serious eye damage ('non-irritants') [UN GHS/EU CLP No Cat vs Not No Cat (Cat 1 + Cat 2); US EPA Cat IV vs Not Cat IV (Cat I + Cat II + Cat III)]

Classification System	No.	Accuracy		Sensitivity		False Negatives		Specificity		False Positives	
		%	No.	%	No.	%	No.	%	No.	%	No.
UN GHS EU CLP	196	68,88	135/196	100	107/107	0	0/107	31,46	28/89	68,54	61/89
US EPA	190	82,11	156/190	93,15	136/146	6,85	10/146	45,45	20/44	54,55	24/44

▼M7

Appendix 3

PROFICIENCY CHEMICALS FOR THE BCOP TEST METHOD

Prior to routine use of this test method, laboratories should demonstrate technical proficiency by correctly identifying the eye hazard classification of the 13 chemicals recommended in Table 1. These chemicals were selected to represent the range of responses for eye hazards based on results in the *in vivo* rabbit eye test (TG 405) (17) and the UN GHS classification system (*i.e.*, Categories 1, 2A, 2B, or Not Classified) (4). Other selection criteria were that chemicals are commercially available, that there are high quality *in vivo* reference data available, and that there are high quality *in vitro* data available from the BCOP test method. Reference data are available in the Streamlined Summary Document (3) and in the ICCVAM Background Review Document for the BCOP test method (2)(18).

Table 1

Recommended chemicals for demonstrating technical proficiency with the BCOP test method

Chemical	CASRN	Chemical Class (1)	Physical Form	<i>In Vivo</i> Classification (2)	BCOP Classification
Benzalkonium chloride (5 %)	8001-54-5	Onium compound	Liquid	Category 1	Category 1
Chlorhexidine	55-56-1	Amine, Amidine	Solid	Category 1	Category 1
Dibenzoyl-L- tartaric acid	2743-38-6	Carboxylic acid, Ester	Solid	Category 1	Category 1
Imidazole	288-32-4	Heterocyclic	Solid	Category 1	Category 1
Trichloroacetic acid (30 %)	76-03-9	Carboxylic acid	Liquid	Category 1	Category 1
2,6-Dichlorobenzoyl chloride	4659-45-4	Acyl halide	Liquid	Category 2A	No accurate/reliable prediction can be made
Ethyl-2-methylacetate	609-14-3	Ketone, Ester	Liquid	Category 2B	No accurate/reliable prediction can be made
Ammonium nitrate	6484-52-2	Inorganic salt	Solid	Category 2 (3)	No accurate/reliable prediction can be made
EDTA, di-potassium salt	25102-12-9	Amine, Carboxylic acid (salt)	Solid	Not Classified	Not Classified
Tween 20	9005-64-5	Ester, Polyether	Liquid	Not Classified	Not Classified
2-Mercaptopyrimidine	1450-85-7	Acyl halide	Solid	Not Classified	Not Classified
Phenylbutazone	50-33-9	Heterocyclic	Solid	Not Classified	Not Classified

▼ **M7**

Chemical	CASRN	Chemical Class ⁽¹⁾	Physical Form	<i>In Vivo</i> Classification ⁽²⁾	BCOP Classification
Polyoxyethylene 23 lauryl ether (BRIJ-35) (10 %)	9002-92-0	Alcohol	Liquid	Not Classified	Not Classified

Abbreviations: CASRN = Chemical Abstracts Service Registry Number.

⁽¹⁾ Chemical classes were assigned to each test chemical using a standard classification scheme, based on the National Library of Medicine Medical Subject Headings (MeSH) classification system (available at <http://www.nlm.nih.gov/mesh>).

⁽²⁾ Based on results from the *in vivo* rabbit eye test (OECD TG 405) (17) and using the UN GHS (4).

⁽³⁾ Classification as 2A or 2B depends on the interpretation of the UN GHS criterion for distinguishing between these two categories, i.e. 1 out of 3 vs. 2 out of 3 animals with effects at day 7 necessary to generate a Category 2A classification. The *in vivo* study included 3 animals. All endpoints apart from conjunctiva redness in one animal recovered to a score of zero by day 7 or earlier. The one animal that did not fully recover by day 7 had a conjunctiva redness score of 1 (at day 7) that fully recovered at day 10.

▼ M7*Appendix 4***THE BCOP CORNEAL HOLDER**

The BCOP corneal holders are made of an inert material (e.g. polypropylene). The holders are comprised of two halves (an anterior and posterior chamber), and have two similar cylindrical internal chambers. Each chamber is designed to hold a volume of about 5 ml and terminates in a glass window, through which opacity measurements are recorded. Each of the inner chambers is 1,7 cm in diameter and 2,2 cm in depth⁽¹⁾. An o-ring located on the posterior chamber is used to prevent leaks. The corneas are placed endothelial side down on the o-ring of the posterior chambers and the anterior chambers are placed on the epithelial side of the corneas. The chambers are maintained in place by three stainless steel screws located on the outer edges of the chamber. The end of each chamber houses a glass window, which can be removed for easy access to the cornea. An o-ring is also located between the glass window and the chamber to prevent leaks. Two holes on the top of each chamber permit introduction and removal of medium and test chemicals. They are closed with rubber caps during the treatment and incubation periods. The light transmission through corneal holders can potentially change as the effects of wear and tear or accumulation of specific chemical residues on the internal chamber bores or on the glass windows may affect light scatter or reflectance. The consequence could be increases or decreases in baseline light transmission (and conversely the baseline opacity readings) through the corneal holders, and may be evident as notable changes in the expected baseline initial corneal opacity measurements in individual chambers (i.e., the initial corneal opacity values in specific individual corneal holders may routinely differ by more than 2 or 3 opacity units from the expected baseline values). Each laboratory should consider establishing a program for evaluating for changes in the light transmission through the corneal holders, depending upon the nature of the chemistries tested and the frequency of use of the chambers. To establish baseline values, corneal holders may be checked before routine use by measuring the baseline opacity values (or light transmission) of chambers filled with complete medium, without corneas. The corneal holders are then periodically checked for changes in light transmission during periods of use. Each laboratory can establish the frequency for checking the corneal holders, based upon the chemicals tested, the frequency of use, and observations of changes in the baseline corneal opacity values. If notable changes in the light transmission through the corneal holders are observed, appropriate cleaning and/or polishing procedures of the interior surface of the cornea holders or replacement have to be considered.

⁽¹⁾ The dimensions provided are based on a corneal holder that is used for cows ranging in age from 12 to 60 months old. In the event that animals 6 to 12 months are being used, the holder would instead need to be designed such that each chamber holds a volume of 4 mL, and each of the inner chambers is 1,5 cm in diameter and 2,2 cm in depth. With any newly designed corneal holder, it is very important that the ratio of exposed corneal surface area to posterior chamber volume should be the same as the ratio in the traditional corneal holder. This is necessary to assure that permeability values are correctly determined for the calculation of the IVIS by the proposed formula

▼ M7

Corneal holder: exploded diagramme

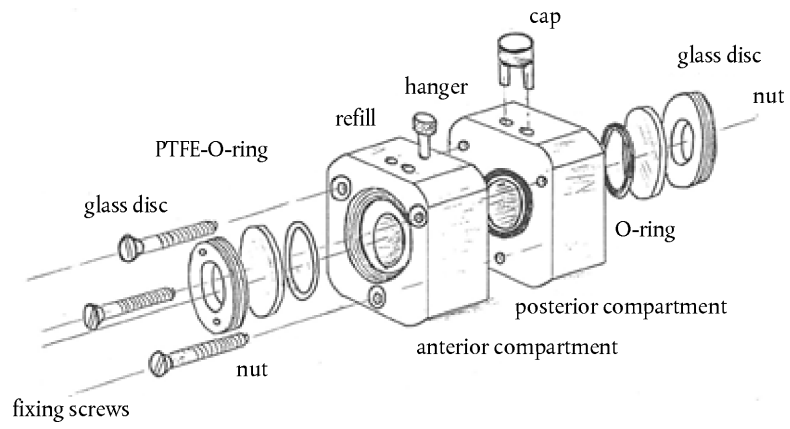

▼ M7*Appendix 5***THE OPACITOMETER**

The opacitometer is a light transmission measuring device. For example, for the OP-KIT equipment from Electro Design (Riom, France) used in the validation of the BCOP test method, light from a halogen lamp is sent through a control compartment (empty chamber without windows or liquid) to a photocell and compared to the light sent through the experimental compartment, which houses the chamber containing the cornea, to a photocell. The difference in light transmission from the photocells is compared and a numeric opacity value is presented on a digital display. The opacity units are established. Other types of opacitometers with a different setup (e.g., not requiring the parallel measurements of the control and experimental compartments) may be used if proven to give similar results to the validated equipment.

The opacitometer should provide a linear response through a range of opacity readings covering the cut-offs used for the different classifications described by the Prediction Model (i.e., up to the cut-off determining corrosiveness/severe irritancy). To ensure linear and accurate readings up to 75-80 opacity units, it is necessary to calibrate the opacitometer using a series of calibrators. Calibrators are placed into the calibration chamber (a corneal chamber designed to hold the calibrators) and read on the opacitometer. The calibration chamber is designed to hold the calibrators at approximately the same distance between the light and photocell that the corneas would be placed during the opacity measurements. Reference values and initial set point depend on the type of equipment used. Linearity of opacity measurements should be ensured by appropriate (instrument specific) procedures. For example, for the OP-KIT equipment from Electro Design (Riom, France), the opacitometer is first calibrated to 0 opacity units using the calibration chamber without a calibrator. Three different calibrators are then placed into the calibration chamber one by one and the opacities are measured. Calibrators 1, 2 and 3 should result in opacity readings equal to their set values of 75, 150, and 225 opacity units, respectively, $\pm 5\%$.

▼ M7**B.48. ISOLATED CHICKEN EYE TEST METHOD FOR IDENTIFYING
I) CHEMICALS INDUCING SERIOUS EYE DAMAGE AND
II) CHEMICALS NOT REQUIRING CLASSIFICATION FOR
EYE IRRITATION OR SERIOUS EYE DAMAGE**

INTRODUCTION

This test method is equivalent to OECD test guideline (TG) 438 (2013). The Isolated Chicken Eye (ICE) test method was evaluated by the Interagency Coordinating Committee on the Validation of Alternative Methods (ICCVAM), in conjunction with the European Centre for the Validation of Alternative Methods (ECVAM) and the Japanese Centre for the Validation of Alternative Methods (JaCVAM), in 2006 and 2010 (1) (2) (3). In the first evaluation, the ICE was endorsed as a scientifically valid test method for use as a screening test to identify chemicals (substances and mixtures) inducing serious eye damage (Category 1) as defined by the United Nations (UN) Globally Harmonized System of Classification and Labelling of Chemicals (GHS) (1) (2) (4) and Regulation (EC) No 1272/2008 on Classification, Labelling and Packaging of Substances and Mixtures (CLP) (1). In the second evaluation, the ICE test method was evaluated for use as a screening test to identify chemicals not classified for eye irritation or serious eye damage as defined by UN GHS (3) (4). The results from the validation study and the peer review panel recommendations maintained the original recommendation for using the ICE for classification of chemicals inducing serious eye damage (UN GHS Category 1), as the available database remained unchanged since the original ICCVAM validation. At that stage, no further recommendations for an expansion of the ICE applicability domain to also include other categories were suggested. A re-evaluation of the *in vitro* and *in vivo* dataset used in the validation study was made with the focus of evaluating the usefulness of the ICE to identify chemicals not requiring classification for eye irritation or serious eye damage (5). This re-evaluation concluded that the ICE test method can also be used to identify chemicals not requiring classification for eye irritation and serious eye damage as defined by the UN GHS (4) (5). This test method includes the recommended uses and limitations of the ICE test method based on these evaluations. The main differences between the original 2009 version and the updated 2013 version of the OECD test guideline include, but are not limited to, the use of the ICE test method to identify chemicals not requiring classification according to the UN GHS Classification System, an update to the test report elements, an update of Appendix 1 on definitions, and an update to Appendix 2 on the proficiency chemicals.

It is currently generally accepted that, in the foreseeable future, no single *in vitro* eye irritation test will be able to replace the *in vivo* Draize eye test to predict across the full range of irritation for different chemical classes. However, strategic combinations of several alternative test methods within a (tiered) testing strategy may be able to replace the Draize eye test (6). The Top-Down approach (7) is designed to be used when, based on existing information, a chemical is expected to have high irritancy potential, while the Bottom-Up approach (7) is designed to be used when, based on existing information, a chemical is expected not to cause sufficient eye irritation to require a classification. The ICE test method is an *in vitro* test method that can be used, under certain circumstances and with specific limitations as described in paragraphs 8 to 10 for eye hazard classification and labelling of chemicals. While it is not considered valid as a stand-alone replacement for the *in vivo* rabbit eye test, the ICE test method is recommended as an initial step within a testing strategy such as the Top-Down approach suggested by Scott *et al.* (7) to identify chemicals inducing serious eye damage, i.e., chemicals to be classified as UN GHS Category 1 without further testing (4). The ICE test method is also recommended to identify chemicals that do not require classification for eye irritation or serious eye damage as defined by the UN GHS (No Category, NC) (4), and may therefore be used as an initial step within a Bottom-Up testing strategy approach (7). However, a chemical that is not predicted as causing serious eye

(1) Regulation (EC) No 1272/2008 of the European Parliament and of the Council of 16 December 2008 on classification, labelling and packaging of substances and mixtures, amending and repealing Directives 67/548/EEC and 1999/45/EC, and amending Regulation (EC) No 1907/2006 (OJ L 353, 31.12.2008, p. 1).

▼ M7

damage or as not classified for eye irritation/serious eye damage with the ICE test method would require additional testing (*in vitro* and/or *in vivo*) to establish a definitive classification. Furthermore, the appropriate regulatory authorities should be consulted before using the ICE in a bottom up approach under other classification schemes than the UN GHS.

The purpose of this test method is to describe the procedures used to evaluate the eye hazard potential of a test chemical as measured by its ability to induce or not toxicity in an enucleated chicken eye. Toxic effects to the cornea are measured by (i) a qualitative assessment of opacity, (ii) a qualitative assessment of damage to epithelium based on application of fluorescein to the eye (fluorescein retention), (iii) a quantitative measurement of increased thickness (swelling), and (iv) a qualitative evaluation of macroscopic morphological damage to the surface. The corneal opacity, swelling, and damage assessments following exposure to a test chemical are assessed individually and then combined to derive an Eye Irritancy Classification.

Definitions are provided in Appendix 1.

INITIAL CONSIDERATIONS AND LIMITATIONS

This test method is based on the protocol suggested in the OECD Guidance Document 160 (8), which was developed following the ICCVAM international validation study (1) (3) (9), with contributions from the European Centre for the Validation of Alternative Methods, the Japanese Center for the Validation of Alternative Methods, and TNO Quality of Life Department of Toxicology and Applied Pharmacology (Netherlands). The protocol is based on information obtained from published protocols, as well as the current protocol used by TNO (10) (11) (12) (13) (14).

A wide range of chemicals has been tested in the validation underlying this test method and the empirical database of the validation study amounted to 152 chemicals including 72 substances and 80 mixtures (5). The test method is applicable to solids, liquids, emulsions and gels. The liquids may be aqueous or non-aqueous; solids may be soluble or insoluble in water. Gases and aerosols have not been assessed yet in a validation study.

The ICE test method can be used to identify chemicals inducing serious eye damage, i.e., chemicals to be classified as UN GHS Category 1 (4). When used for this purpose, the identified limitations for the ICE test method are based on the high false positive rates for alcohols and the high false negative rates for solids and surfactants (1) (3) (9). However, false negative rates in this context (UN GHS Category 1 identified as not being UN GHS Category 1) are not critical since all test chemicals that come out negative would be subsequently tested with other adequately validated *in vitro* test(s), or as a last option in rabbits, depending on regulatory requirements, using a sequential testing strategy in a weight-of-evidence approach. It should be noted that solids may lead to variable and extreme exposure conditions in the *in vivo* Draize eye irritation test, which may result in irrelevant predictions of their true irritation potential (15). Investigators could consider using this test method for all types of

▼ M7

chemicals, whereby a positive result should be accepted as indicative of serious eye damage, i.e., UN GHS Category 1 classification without further testing. However, positive results obtained with alcohols should be interpreted cautiously due to risk of over-prediction.

When used to identify chemicals inducing serious eye damage (UN GHS Category 1), the ICE test method has an overall accuracy of 86 % (120/140), a false positive rate of 6 % (7/113) and a false negative rate of 48 % (13/27) when compared to *in vivo* rabbit eye test method data classified according to the UN GHS classification system (4) (5).

The ICE test method can also be used to identify chemicals that do not require classification for eye irritation or serious eye damage under the UN GHS classification system (4). The appropriate regulatory authorities should be consulted before using the ICE in a bottom up approach under other classification schemes. This test method can be used for all types of chemicals, whereby a negative result could be accepted for not classifying a chemical for eye irritation and serious eye damage. However, on the basis of one result from the validation database, anti-fouling organic solvent-containing paints may be under-predicted (5).

When used to identify chemicals that do not require classification for eye irritation and serious eye damage, the ICE test method has an overall accuracy of 82 % (125/152), a false positive rate of 33 % (26/79), and a false negative rate of 1 % (1/73), when compared to *in vivo* rabbit eye test method data classified according to the UN GHS (4) (5). When test chemicals within certain classes (i.e., anti-fouling organic solvent containing paints) are excluded from the database, the accuracy of the ICE test method is 83 % (123/149), the false positive rate 33 % (26/78), and the false negative rate of 0 % (0/71) for the UN GHS classification system (4) (5).

The ICE test method is not recommended for the identification of test chemicals that should be classified as irritating to eyes (i.e., UN GHS Category 2 or Category 2A) or test chemicals that should be classified as mildly irritating to eyes (UN GHS Category 2B) due to the considerable number of UN GHS Category 1 chemicals underclassified as UN GHS Category 2, 2A or 2B and UN GHS No Category chemicals overclassified as UN GHS Category 2, 2A or 2B. For this purpose, further testing with another suitable method may be required.

All procedures with chicken eyes should follow the test facility's applicable regulations and procedures for handling of human or animal-derived materials, which include, but are not limited to, tissues and tissue fluids. Universal laboratory precautions are recommended (16).

Whilst the ICE test method does not consider conjunctival and iridal injuries as evaluated in the rabbit ocular irritancy test method, it addresses corneal effects which are the major driver of classification *in vivo* when considering the UN GHS Classification. Also, although the reversibility of corneal lesions cannot be evaluated *per se* in the ICE test method, it has been proposed, based on rabbit eye studies, that an assessment of the initial depth of corneal injury may be used to identify some types of irreversible effects (17). In particular, further scientific knowledge is required to understand how irreversible effects not linked with

▼ M7

initial high level injury occur. Finally, the ICE test method does not allow for an assessment of the potential for systemic toxicity associated with ocular exposure.

This test method will be updated periodically as new information and data are considered. For example, histopathology may be potentially useful when a more complete characterisation of corneal damage is needed. To evaluate this possibility, users are encouraged to preserve eyes and prepare histopathology specimens that can be used to develop a database and decision criteria that may further improve the accuracy of this test method. The OECD has developed a Guidance Document on the use of *in vitro* ocular toxicity test methods, which includes detailed procedures on the collection of histopathology specimens and information on where to submit specimens and/or histopathology data (8).

For any laboratory initially establishing this assay, the proficiency chemicals provided in Appendix 2 should be used. A laboratory can use these chemicals to demonstrate their technical competence in performing the ICE test method prior to submitting ICE data for regulatory hazard classification purposes.

PRINCIPLE OF THE TEST

The ICE test method is an organotypic model that provides short-term maintenance of the chicken eye *in vitro*. In this test method, damage by the test chemical is assessed by determination of corneal swelling, opacity, and fluorescein retention. While the latter two parameters involve a qualitative assessment, analysis of corneal swelling provides for a quantitative assessment. Each measurement is either converted into a quantitative score used to calculate an overall Irritation Index, or assigned a qualitative categorisation that is used to assign an *in vitro* ocular hazard classification, either as UN GHS Category 1 or as UN GHS non-classified. Either of these outcomes can then be used to predict the potential *in vivo* serious eye damage or no requirement for eye hazard classification of a test chemical (see Decision Criteria). However, no classification can be given for chemicals not predicted as causing serious eye damage or as not classified with the ICE test method (see paragraph 11).

Source and Age of Chicken Eyes

Historically, eyes collected from chickens obtained from a slaughterhouse where they are killed for human consumption have been used for this assay, eliminating the need for laboratory animals. Only the eyes of healthy animals considered suitable for entry into the human food chain are used.

Although a controlled study to evaluate the optimum chicken age has not been conducted, the age and weight of the chickens used historically in this test method are that of spring chickens traditionally processed by a poultry slaughterhouse (*i.e.*, approximately 7 weeks old, 1,5 - 2,5 kg).

Collection and Transport of Eyes to the Laboratory

Heads should be removed immediately after sedation of the chickens, usually by electric shock, and incision of the neck for bleeding. A local source of chickens close to the laboratory should be located so that their heads can be transferred from the slaughterhouse to the laboratory quickly enough to minimise deterioration and/or bacterial contamination. The time interval between collection of the chicken heads and placing the eyes in the superfusion chamber following enucleation should be minimised (typically within two hours) to assure meeting assay acceptance criteria. All eyes used in the assay should be from the same group of eyes collected on a specific day.

▼ M7

Because eyes are dissected in the laboratory, the intact heads are transported from the slaughterhouse at ambient temperature (typically between 18 °C and 25 °C) in plastic boxes humidified with tissues moistened with isotonic saline.

Selection Criteria and Number of Eyes Used in the ICE

Eyes that have high baseline fluorescein staining (*i.e.*, > 0,5) or corneal opacity score (*i.e.*, > 0,5) after they are enucleated are rejected.

Each treatment group and concurrent positive control consists of at least three eyes. The negative control group or the solvent control (if using a solvent other than saline) consists of at least one eye.

In the case of solid materials leading to a GHS NC outcome, a second run of three eyes is recommended to confirm or discard the negative outcome.

PROCEDURE**Preparation of the Eyes**

The eyelids are carefully excised, taking care not to damage the cornea. Corneal integrity is quickly assessed with a drop of 2 % (w/v) sodium fluorescein applied to the corneal surface for a few seconds, and then rinsed with isotonic saline. Fluorescein-treated eyes are then examined with a slit-lamp microscope to ensure that the cornea is undamaged (*i.e.*, fluorescein retention and corneal opacity scores $\leq 0,5$).

If undamaged, the eye is further dissected from the skull, taking care not to damage the cornea. The eyeball is pulled from the orbit by holding the nictitating membrane firmly with surgical forceps, and the eye muscles are cut with a bent, blunt-tipped scissor. It is important to avoid causing corneal damage due to excessive pressure (*i.e.*, compression artifacts).

When the eye is removed from the orbit, a visible portion of the optic nerve should be left attached. Once removed from the orbit, the eye is placed on an absorbent pad and the nictitating membrane and other connective tissue are cut away.

The enucleated eye is mounted in a stainless steel clamp with the cornea positioned vertically. The clamp is then transferred to a chamber of the superfusion apparatus (18). The clamps should be positioned in the superfusion apparatus such that the entire cornea is supplied with the isotonic saline drip (3-4 drops per minute or 0,1 to 0,15 ml/min). The chambers of the superfusion apparatus should be temperature controlled at $32 \pm 1,5$ °C. Appendix 3 provides a diagram of a typical superfusion apparatus and the eye clamps, which can be obtained commercially or constructed. The apparatus can be modified to meet the needs of an individual laboratory (e.g. to accommodate a different number of eyes).

After being placed in the superfusion apparatus, the eyes are again examined with a slit-lamp microscope to ensure that they have not been damaged during the dissection procedure. Corneal thickness should also be measured at this time at the corneal apex using the depth measuring device on the slit-lamp microscope. Eyes with; (i), a fluorescein retention score of > 0,5; (ii) corneal opacity > 0,5; or, (iii), any additional signs of damage should be replaced. For eyes that are not rejected based on any of these criteria, individual eyes with a corneal thickness deviating more than 10 % from the mean value for all eyes are to be rejected. Users should be aware that slit-lamp microscopes could yield different corneal thickness measurements if the slit-width setting is different. The slit-width should be set at 0,095 mm.

▼ M7

Once all eyes have been examined and approved, the eyes are incubated for approximately 45 to 60 minutes to equilibrate them to the test system prior to dosing. Following the equilibration period, a zero reference measurement is recorded for corneal thickness and opacity to serve as a baseline (*i.e.*, time = 0). The fluorescein score determined at dissection is used as the baseline measurement for that endpoint.

Application of the Test Chemical

Immediately following the zero reference measurements, the eye (in its holder) is removed from the superfusion apparatus, placed in a horizontal position, and the test chemical is applied to the cornea.

Liquid test chemicals are typically tested undiluted, but may be diluted if deemed necessary (e.g. as part of the study design). The preferred solvent for diluted test chemicals is physiological saline. However, alternative solvents may also be used under controlled conditions, but the appropriateness of solvents other than physiological saline should be demonstrated.

Liquid test chemicals are applied to the cornea such that the entire surface of the cornea is evenly covered with the test chemical; the standard volume is 0,03 ml.

If possible, solid test chemicals should be ground as finely as possible in a mortar and pestle, or comparable grinding tool. The powder is applied to the cornea such that the surface is uniformly covered with the test chemical; the standard amount is 0,03 g.

The test chemical (liquid or solid) is applied for 10 seconds and then rinsed from the eye with isotonic saline (approximately 20 ml) at ambient temperature. The eye (in its holder) is subsequently returned to the superfusion apparatus in the original upright position. In case of need, additional rinsing may be used after the 10-sec application and at subsequent time points (e.g. upon discovery of residues of test chemical on the cornea). In general the amount of saline additionally used for rinsing is not critical, but the observation of adherence of chemical to the cornea is important.

Control Chemicals

Concurrent negative or solvent/vehicle controls and positive controls should be included in each experiment.

When testing liquids at 100 % or solids, physiological saline is used as the concurrent negative control in the ICE test method to detect non-specific changes in the test system, and to ensure that the assay conditions do not inappropriately result in an irritant response.

When testing diluted liquids, a concurrent solvent/vehicle control group is included in the test method to detect non-specific changes in the test system, and to ensure that the assay conditions do not inappropriately result in an irritant response. As stated in paragraph 31, only a solvent/vehicle that has been demonstrated to have no adverse effects on the test system can be used.

A known ocular irritant is included as a concurrent positive control in each experiment to verify that an appropriate response is induced. As the ICE assay is being used in this test method to identify corrosive or severe irritants, the positive control should be a reference chemical that induces a severe response in this test method. However, to ensure that variability in the positive control response across time can be assessed, the magnitude of the severe response

▼ M7

should not be excessive. Sufficient *in vitro* data for the positive control should be generated such that a statistically defined acceptable range for the positive control can be calculated. If adequate historical ICE test method data are not available for a particular positive control, studies may need to be conducted to provide this information.

Examples of positive controls for liquid test chemicals are 10 % acetic acid or 5 % benzalkonium chloride, while examples of positive controls for solid test chemicals are sodium hydroxide or imidazole.

Benchmark chemicals are useful for evaluating the ocular irritancy potential of unknown chemicals of a specific chemical or product class, or for evaluating the relative irritancy potential of an ocular irritant within a specific range of irritant responses.

Endpoints Measured

Treated corneas are evaluated prior to treatment and at 30, 75, 120, 180, and 240 minutes (± 5 minutes) after the post-treatment rinse. These time points provide an adequate number of measurements over the four-hour treatment period, while leaving sufficient time between measurements for the requisite observations to be made for all eyes.

The endpoints evaluated are corneal opacity, swelling, fluorescein retention, and morphological effects (e.g. pitting or loosening of the epithelium). All of the endpoints, with the exception of fluorescein retention (which is determined only prior to treatment and 30 minutes after test chemical exposure) are determined at each of the above time points.

Photographs are advisable to document corneal opacity, fluorescein retention, morphological effects and, if conducted, histopathology.

After the final examination at four hours, users are encouraged to preserve eyes in an appropriate fixative (e.g. neutral buffered formalin) for possible histopathological examination (see paragraph 14 and reference (8) for details).

Corneal swelling is determined from corneal thickness measurements made with an optical pachymeter on a slit-lamp microscope. It is expressed as a percentage and is calculated from corneal thickness measurements according to the following formula:

$$\left(\frac{\text{corneal thickness at time } t - \text{corneal thickness at time } = 0}{\text{corneal thickness at time } = 0} \right) \times 100$$

The mean percentage of corneal swelling for all test eyes is calculated for all observation time points. Based on the highest mean score for corneal swelling, as observed at any time point, an overall category score is then given for each test chemical (see paragraph 51).

Corneal opacity is evaluated by using the area of the cornea that is most densely opacified for scoring as shown in Table 1. The mean corneal opacity value for all test eyes is calculated for all observation time points. Based on the highest mean score for corneal opacity, as observed at any time point, an overall category score is then given for each test chemical (see paragraph 51).

▼ **M7***Table 1***Corneal opacity scores**

Score	Observation
0	No opacity
0,5	Very faint opacity
1	Scattered or diffuse areas; details of the iris are clearly visible
2	Easily discernible translucent area; details of the iris are slightly obscured
3	Severe corneal opacity; no specific details of the iris are visible; size of the pupil is barely discernible
4	Complete corneal opacity; iris invisible

Fluorescein retention is evaluated at the 30 minute observation time point only as shown in Table 2. The mean fluorescein retention value of all test eyes is then calculated for the 30-minute observation time point, and used for the overall category score given for each test chemical (see paragraph 51).

*Table 2***Fluorescein retention scores**

Score	Observation
0	No fluorescein retention
0,5	Very minor single cell staining
1	Single cell staining scattered throughout the treated area of the cornea
2	Focal or confluent dense single cell staining
3	Confluent large areas of the cornea retaining fluorescein

Morphological effects include ‘pitting’ of corneal epithelial cells, ‘loosening’ of epithelium, ‘roughening’ of the corneal surface and ‘sticking’ of the test chemical to the cornea. These findings can vary in severity and may occur simultaneously. The classification of these findings is subjective according to the interpretation of the investigator.

DATA AND REPORTING**Data Evaluation**

Results from corneal opacity, swelling, and fluorescein retention should be evaluated separately to generate an ICE class for each endpoint. The ICE classes for each endpoint are then combined to generate an Irritancy Classification for each test chemical.

Decision Criteria

Once each endpoint has been evaluated, ICE classes can be assigned based on a predetermined range. Interpretation of corneal swelling (Table 3), opacity (Table 4), and fluorescein retention (Table 5) using four ICE classes is done according to the scales shown below. It is important to note that the corneal swelling scores shown in Table 3 are only applicable if thickness is measured with a slit-lamp microscope (for example Haag-Streit BP900) with depth-measuring device no. 1

▼ **M7**

and slit-width setting at $9\frac{1}{2}$, equalling 0,095 mm. Users should be aware that slit-lamp microscopes could yield different corneal thickness measurements if the slit-width setting is different.

Table 3

ICE classification criteria for corneal swelling

Mean Corneal Swelling (%) (*)	ICE Class
0 to 5	I
> 5 to 12	II
> 12 to 18 (> 75 min after treatment)	II
> 12 to 18 (\leq 75 min after treatment)	III
> 18 to 26	III
> 26 to 32 (> 75 min after treatment)	III
> 26 to 32 (\leq 75 min after treatment)	IV
> 32	IV

(*) Highest mean score observed at any time point.

Table 4

ICE classification criteria for opacity

Maximum Mean Opacity Score (*)	ICE Class
0,0-0,5	I
0,6-1,5	II
1,6-2,5	III
2,6-4,0	IV

(*) Maximum mean score observed at any time point (based on opacity scores as defined in Table 1).

Table 5

ICE classification criteria for mean fluorescein retention

Mean Fluorescein Retention Score at 30 minutes post-treatment (*)	ICE Class
0,0-0,5	I
0,6-1,5	II
1,6-2,5	III
2,6-3,0	IV

(*) Based on scores as defined in Table 2.

The *in vitro* classification for a test chemical is assessed by reading the GHS classification that corresponds to the combination of categories obtained for corneal swelling, corneal opacity, and fluorescein retention as described in Table 6.

▼ **M7**

Table 6

Overall *in vitro* classifications

UN GHS Classification	Combinations of the 3 Endpoints
No Category	3 × I 2 × I, 1 × II
No prediction can be made	Other combinations
Category 1	3 × IV 2 × IV, 1 × III 2 × IV, 1 × II (*) 2 × IV, 1 × I (*) Corneal opacity ≥ 3 at 30 min (in at least 2 eyes) Corneal opacity = 4 at any time point (in at least 2 eyes) Severe loosening of the epithelium (in at least 1 eye)

(*) Combinations less likely to occur.

Study Acceptance Criteria

A test is considered acceptable if the concurrent negative or vehicle/solvent controls and the concurrent positive controls are identified as GHS Non-Classified and GHS Category 1, respectively.

Test Report

The test report should include the following information, if relevant to the conduct of the study:

Test Chemical and Control Chemicals

- Chemical name(s) such as the structural name used by the Chemical Abstracts Service (CAS), followed by other names, if known;
- The CAS Registry Number (RN), if known;
- Purity and composition of the test /control chemicals (in percentage(s) by weight), to the extent this information is available;
- Physicochemical properties such as physical state, volatility, pH, stability, chemical class water solubility relevant to the conduct of the study;
- Treatment of the test /control chemicals prior to testing, if applicable (e.g. warming, grinding);
- Stability, if known;

Information Concerning the Sponsor and the Test Facility

- Name and address of the sponsor, test facility and study director;
- Identification on the source of the eyes (e.g. the facility from which they were collected);

Test Method Conditions

- Description of test system used;

▼ M7

- Slit-lamp microscope used (e.g. model) and instrument settings for the slit-lamp microscope used;
- Reference to historical negative and positive control results and, if applicable, historical data demonstrating acceptable concurrent benchmark control ranges;
- The procedure used to ensure the integrity (*i.e.*, accuracy and reliability) of the test method over time (e.g. periodic testing of proficiency chemicals)).

Eyes Collection and Preparation

- Age and weight of the donor animal and if available, other specific characteristics of the animals from which the eyes were collected (e.g. sex, strain);
- Storage and transport conditions of eyes (e.g. date and time of eye collection, time interval between collection of chicken heads and placing the enucleated eyes in superfusion chamber);
- Preparation & mounting of the eyes including statements regarding their quality, temperature of eye chambers, and criteria for selection of eyes used for testing.

Test Procedure

- Number of replicates used;
- Identity of the negative and positive controls used (if applicable, also the solvent and benchmark controls);
- Test chemical dose, application and exposure time used;
- Observation time points (pre- and post- treatment);
- Description of evaluation and decision criteria used;
- Description of study acceptance criteria used;
- Description of any modifications of the test procedure.

Results

- Tabulation of corneal swelling, opacity and fluorescein retention scores obtained for each individual eye and at each observation time point, including the mean scores at each observation time of all tested eyes;
- The highest mean corneal swelling, opacity and fluorescein retention scores observed (from any time point), and its relating ICE class.
- Description of any other effects observed;
- The derived *in vitro* GHS classification;
- If appropriate, photographs of the eye;

*Discussion of the Results**Conclusion*

▼ M7

LITERATURE:

- (1) ICCVAM (2007). Test Method Evaluation Report — *In Vitro Ocular Toxicity* Test Methods for Identifying Ocular Severe Irritants and Corrosives. Interagency Coordinating Committee on the Validation of Alternative Methods (ICCVAM) and the National Toxicology Program (NTP) Interagency Center for the Evaluation of Alternative Toxicological Methods (NICEATM). NIH Publication No.: 07-4517. Available: http://iccvam.niehs.nih.gov/methods/ocutox/ivocutox/ocu_tmer.htm.
- (2) ESAC (2007). Statement on the conclusion of the ICCVAM retrospective study on organotypic *in vitro* assays as screening tests to identify potential ocular corrosives and severe eye irritants. Available: <http://ecvam.jrc.it/index.htm>.
- (3) ICCVAM (2010). ICCVAM Test Method Evaluation Report — Current Status of *in vitro* Test Methods for Identifying Mild/Moderate Ocular Irritants: The Isolated Chicken Eye (ICE) Test Method. Interagency Coordinating Committee on the Validation of Alternative Methods (ICCVAM) and the National Toxicology Program (NTP) Interagency Center for the Evaluation of Alternative Toxicological Methods (NICEATM). NIH Publication No.: 10-7553A. Available: <http://iccvam.niehs.nih.gov/methods/ocutox/MildMod-TMER.htm>.
- (4) United Nations (UN) (2011). Globally Harmonized System of Classification and Labelling of Chemicals (GHS), Fourth revised edition, UN New York and Geneva, 2011. Available at: http://www.unece.org/trans/danger/publi/ghs/ghs_rev04/04files_e.html.
- (5) Streamlined Summary Document Supporting OECD Test Guideline 438 on the Isolated Chicken Eye for Eye Irritation/Corrosion. Series on Testing and Assessment no. 188 (Part 1 and Part 2), OECD, Paris.
- (6) Chapter B.5 of this Annex, Acute eye irritation/corrosion.
- (7) Scott L, Eskes C, Hoffman S, Adriaens E, Alepee N, Bufo M, Clothier R, Facchini D, Faller C, Guest R, Hamernik K, Harbell J, Hartung T, Kamp H, Le Varlet B, Meloni M, Mcnamee P, Osborn R, Pape W, Pfannenbecker U, Prinsen M, Seaman C, Spielmann H, Stokes W, Trouba K, Vassallo M, Van den Berghe C, Van Goethem F, Vinardell P, Zuang V (2010). A proposed Eye Irritation Testing Strategy to Reduce and Replace *in vivo* Studies Using Bottom-up and Top-down Approaches. *Toxicology In Vitro* 24, 1-9.
- (8) OECD (2011) Guidance Document on ‘The Bovine Corneal Opacity and Permeability (BCOP) and Isolated Chicken Eye (ICE) Test Methods: Collection of Tissues for Histological Evaluation and Collection of Data on Non-Severe Irritants’. Series on Testing and Assessment no. 160, OECD, Paris.
- (9) ICCVAM. (2006). Background review document: Current Status of *In Vitro* Test Methods for Identifying Ocular Corrosives and Severe Irritants: Isolated Chicken Eye Test Method. NIH Publication No.: 06-4513. Research Triangle Park: National Toxicology Program. Available at: http://iccvam.niehs.nih.gov/methods/ocutox/ivocutox/ocu_brd_ice.htm.
- (10) Prinsen, M.K. and Koëter, B.W.M. (1993). Justification of the enucleated eye test with eyes of slaughterhouse animals as an alternative to the Draize eye irritation test with rabbits. *Fd. Chem. Toxicol.* 31:69-76.
- (11) DB-ALM (INVTTOX) (2009). Protocol 80: Chicken enucleated eye test (CEET) / Isolated Chicken Eye Test, 13pp. Available: <http://ecvam-dbalm.jrc.ec.europa.eu/>.
- (12) Balls, M., Botham, P.A., Bruner, L.H. and Spielmann H. (1995). The EC/HO international validation study on alternatives to the Draize eye irritation test. *Toxicol. In Vitro* 9:871-929.
- (13) Prinsen, M.K. (1996). The chicken enucleated eye test (CEET): A practical (pre)screen for the assessment of eye irritation/corrosion potential of test materials. *Food Chem. Toxicol.* 34:291-296.

▼M7

- (14) Chamberlain, M., Gad, S.C., Gautheron, P. and Prinsen, M.K. (1997). IRAG Working Group I: Organotypic models for the assessment/prediction of ocular irritation. *Food Chem. Toxicol.* 35:23-37.
- (15) Prinsen, M.K. (2006). The Draize Eye Test and *in vitro* alternatives; a left-handed marriage? *Toxicology in Vitro* 20,78-81.
- (16) Siegel, J.D., Rhinehart, E., Jackson, M., Chiarello, L., and the Healthcare Infection Control Practices Advisory Committee (2007). Guideline for Isolation Precautions: Preventing Transmission of Infectious Agents in Healthcare Settings. Available: <http://www.cdc.gov/ncidod/dhqp/pdf/isolation2007.pdf>.
- (17) Maurer, J.K., Parker, R.D. and Jester J.V. (2002). Extent of corneal injury as the mechanistic basis for ocular irritation: key findings and recommendations for the development of alternative assays. *Reg. Tox. Pharmacol.* 36:106-117.
- (18) Burton, A.B.G., M. York and R.S. Lawrence (1981). The *in vitro* assessment of severe irritants. *Fd. Cosmet.- Toxicol.*- 19, 471-480.

▼ M7*Appendix 1*

DEFINITIONS

Accuracy: The closeness of agreement between test method results and accepted reference values. It is a measure of test method performance and one aspect of 'relevance'. The term is often used interchangeably with 'concordance', to mean the proportion of correct outcomes of a test method.

Benchmark chemical: A chemical used as a standard for comparison to a test chemical. A benchmark chemical should have the following properties; (i), a consistent and reliable source(s); (ii), structural and functional similarity to the class of chemicals being tested; (iii), known physical/chemical characteristics; (iv) supporting data on known effects; and (v), known potency in the range of the desired response

Bottom-Up Approach: step-wise approach used for a chemical suspected of not requiring classification for eye irritation or serious eye damage, which starts with the determination of chemicals not requiring classification (negative outcome) from other chemicals (positive outcome).

Chemical: A substance or a mixture.

Cornea: The transparent part of the front of the eyeball that covers the iris and pupil and admits light to the interior.

Corneal opacity: Measurement of the extent of opaqueness of the cornea following exposure to a test chemical. Increased corneal opacity is indicative of damage to the cornea.

Corneal swelling: An objective measurement in the ICE test of the extent of distension of the cornea following exposure to a test chemical. It is expressed as a percentage and is calculated from baseline (pre-dose) corneal thickness measurements and the thickness recorded at regular intervals after exposure to the test chemical in the ICE test. The degree of corneal swelling is indicative of damage to the cornea.

Eye Irritation: Production of changes in the eye following the application of test chemical to the anterior surface of the eye, which are fully reversible within 21 days of application. Interchangeable with 'Reversible effects on the Eye' and with 'UN GHS Category 2' (4).

False negative rate: The proportion of all positive chemicals falsely identified by a test method as negative. It is one indicator of test method performance.

False positive rate: The proportion of all negative chemicals that are falsely identified by a test method as positive. It is one indicator of test method performance.

Fluorescein retention: A subjective measurement in the ICE test of the extent of fluorescein sodium that is retained by epithelial cells in the cornea following exposure to a test substance. The degree of fluorescein retention is indicative of damage to the corneal epithelium.

Hazard: Inherent property of an agent or situation having the potential to cause adverse effects when an organism, system or (sub) population is exposed to that agent.

Irreversible effects on the eye: see 'Serious eye damage' and 'UN GHS Category 1'.

▼ M7

Mixture: A mixture or a solution composed of two or more substances in which they do not react (4)

Negative control: An untreated replicate containing all components of a test system. This sample is processed with test chemical-treated samples and other control samples to determine whether the solvent interacts with the test system.

Not Classified: Substances that are not classified for eye irritation (UN GHS Category 2) or serious damage to eye (UN GHS Category 1). Interchangeable with 'UN GHS No Category'.

Positive control: A replicate containing all components of a test system and treated with a chemical known to induce a positive response. To ensure that variability in the positive control response across time can be assessed, the magnitude of the severe response should not be excessive.

Reliability: Measures of the extent that a test method can be performed reproducibly within and between laboratories over time, when performed using the same protocol. It is assessed by calculating intra- and inter-laboratory reproducibility and intra-laboratory repeatability.

Reversible effects on the Eye: see 'Eye Irritation' and 'UN GHS Category 2'.

Serious eye damage: Production of tissue damage in the eye, or serious physical decay of vision, following application of a test chemical to the anterior surface of the eye, which is not fully reversible within 21 days of application. Interchangeable with 'Irreversible effects on the eye' and with 'UN GHS Category 1' (4).

Slit-lamp microscope: An instrument used to directly examine the eye under the magnification of a binocular microscope by creating a stereoscopic, erect image. In the ICE test method, this instrument is used to view the anterior structures of the chicken eye as well as to objectively measure corneal thickness with a depth-measuring device attachment.

Solvent/vehicle control: An untreated sample containing all components of a test system, including the solvent or vehicle that is processed with the test chemical-treated samples and other control samples to establish the baseline response for the samples treated with the test chemical dissolved in the same solvent or vehicle. When tested with a concurrent negative control, this sample also demonstrates whether the solvent or vehicle interacts with the test system.

Substance: Chemical elements and their compounds in the natural state or obtained by any production process, including any additive necessary to preserve the stability of the product and any impurities deriving from the process used, but excluding any solvent which may be separated without affecting the stability of the substance or changing its composition (4).

Surfactant: Also called surface-active agent, this is a substance, such as a detergent, that can reduce the surface tension of a liquid and thus allow it to foam or penetrate solids; it is also known as a wetting agent.

▼ M7

Top-Down Approach: step-wise approach used for a chemical suspected of causing serious eye damage, which starts with the determination of chemicals inducing serious eye damage (positive outcome) from other chemicals (negative outcome).

Test chemical: Any substance or mixture tested using this Test Method.

Tiered testing strategy: A stepwise testing strategy where all existing information on a test chemical is reviewed, in a specified order, using a weight-of-evidence process at each tier to determine if sufficient information is available for a hazard classification decision, prior to progression to the next tier. If the irritancy potential of a test chemical can be assigned based on the existing information, no additional testing is required. If the irritancy potential of a test chemical cannot be assigned based on the existing information, a step-wise sequential animal testing procedure is performed until an unequivocal classification can be made.

United Nations Globally Harmonized System of Classification and Labelling of Chemicals (UN GHS): A system proposing the classification of chemicals (substances and mixtures) according to standardised types and levels of physical, health and environmental hazards, and addressing corresponding communication elements, such as pictograms, signal words, hazard statements, precautionary statements and safety data sheets, so that to convey information on their adverse effects with a view to protect people (including employers, workers, transporters, consumers and emergency responders) and the environment (4).

UN GHS Category 1: see ‘Serious damage to eyes’ and/or ‘Irreversible effects on the eye’.

UN GHS Category 2: see ‘Eye Irritation’ and/or ‘Reversible effects to the eye’.

UN GHS No Category: Substances that do not meet the requirements for classification as UN GHS Category 1 or 2 (2A or 2B). Interchangeable with ‘Not classified’.

Validated test method: A test method for which validation studies have been completed to determine the relevance (including accuracy) and reliability for a specific purpose. It is important to note that a validated test method may not have sufficient performance in terms of accuracy and reliability to be found acceptable for the proposed purpose.

Weight-of-evidence: The process of considering the strengths and weaknesses of various pieces of information in reaching and supporting a conclusion concerning the hazard potential of a chemical.

▼M7

Appendix 2

PROFICIENCY CHEMICALS FOR THE ICE TEST METHOD

Prior to routine use of a test method that adheres to this test method, laboratories should demonstrate technical proficiency by correctly identifying the eye hazard classification of the 13 chemicals recommended in Table 1. These chemicals were selected to represent the range of responses for eye hazards based on results from the *in vivo* rabbit eye test (TG 405) and the UN GHS classification system (*i.e.*, UN GHS Categories 1, 2A, 2B, or No Category) (4)(6). Other selection criteria were that chemicals are commercially available, there are high quality *in vivo* reference data available, and there are high quality data from the ICE *in vitro* method. Reference data are available in the SSD (5) and in the ICCVAM Background Review Documents for the ICE test method (9).

Table 1

Recommended chemicals for demonstrating technical proficiency with ICE

Chemical	CASRN	Chemical Class (1)	Physical Form	<i>In Vivo</i> Classification (2)	<i>In Vitro</i> Classification (3)
Benzalkonium chloride (5 %)	8001-54-5	Onium compound	Liquid	Category 1	Category 1
Chlorhexidine	55-56-1	Amine, Amidine	Solid	Category 1	Category 1
Dibenzoyl-L-tartaric acid	2743-38-6	Carboxylic acid, Ester	Solid	Category 1	Category 1
Imidazole	288-32-4	Heterocyclic	Solid	Category 1	Category 1
Trichloroacetic acid (30 %)	76-03-9	Carboxylic Acid	Liquid	Category 1	Category 1
2,6-Dichlorobenzoyl chloride	4659-45-4	Acyl halide	Liquid	Category 2A	No predictions can be made (4)
Ammonium nitrate	6484-52-2	Inorganic salt	Solid	Category 2A (5)	No predictions can be made (4)
Ethyl-2-methylacetoacetate	609-14-3	Ketone, Ester	Liquid	Category 2B	No predictions can be made (4)
Dimethyl sulfoxide	67-68-5	Organic sulphur compound	Liquid	No Category	No Category
Glycerol	56-81-5	Alcohol	Liquid	No Category	No Category (borderline)
Methylcyclopentane	96-37-7	Hydrocarbon (cyclic)	Liquid	No Category	No Category
n-Hexane	110-54-3	Hydrocarbon (acyclic)	Liquid	No Category	No Category

▼ **M7**

Chemical	CASRN	Chemical Class ⁽¹⁾	Physical Form	<i>In Vivo</i> Classification ⁽²⁾	<i>In Vitro</i> Classification ⁽³⁾
Triacetin	102-76-1	Lipid	Liquid	Not classified	No Category

Abbreviations: CASRN = Chemical Abstracts Service Registry Number.

⁽¹⁾ Chemical classes were assigned to each test chemical using a standard classification scheme, based on the National Library of Medicine Medical Subject Headings (MeSH) classification system (available at <http://www.nlm.nih.gov/mesh>)

⁽²⁾ Based on results from the *in vivo* rabbit eye test (OECD TG 405) and using the UN GHS (4)(6).

⁽³⁾ Based on results in ICE as described in table 6.

⁽⁴⁾ Combination of ICE scores other than the ones described in table 6 for the identification of GHS no-category and GHS Category 1 (see table 6)

⁽⁵⁾ Classification as 2A or 2B depends on the interpretation of the UN GHS criterion for distinguishing between these two categories, *i.e.* 1 out of 3 vs 2 out of 3 animals with effects at day 7 necessary to generate a Category 2A classification. The *in vivo* study included 3 animals. All endpoints apart from conjunctiva redness in one animal recovered to a score of zero by day 7 or earlier. The one animal that did not fully recover by day 7 had a conjunctiva redness score of 1 (at day 7) that fully recovered at day 10.

▼ M7

Appendix 3

DIAGRAMS OF THE ICE SUPERFUSION APPARATUS AND EYE CLAMPS

(See Burton et al. (18) for additional generic descriptions of the superfusion apparatus and eye clamp)

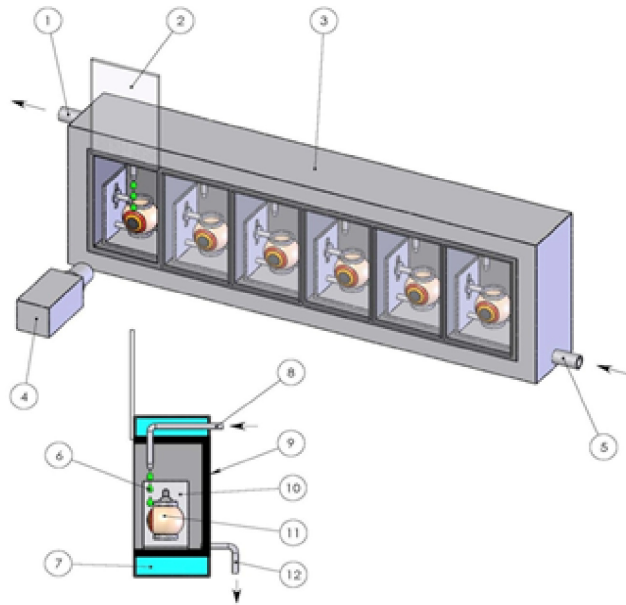

CROSS SECTION COMPARTMENT

EYE HOLDER

Item No.	Description	Item No.	Description
1	Outlet warm water	9	Compartment
2	Sliding door	10	Eye holder
3	Superfusion apparatus	11	Chicken eye
4	Optical measuring instrument	12	Outlet saline solution
5	Inlet warm water	13	Setscrew
6	Saline solution	14	Adjustable upper arm
7	Warm water	15	Fixed lower arm
8	Inlet saline solution		

▼M7**B.49. IN VITRO MAMMALIAN CELL MICRONUCLEUS TEST****INTRODUCTION**

This test method is equivalent to OECD test guideline 487 (2016). It is part of a series of test methods on genetic toxicology. An OECD document that provides succinct information on genetic toxicology testing and an overview of the recent changes that were made to these Test Guidelines has been developed (1).

The *in vitro* micronucleus (MNvit) test is a genotoxicity test for the detection of micronuclei (MN) in the cytoplasm of interphase cells. Micronuclei may originate from acentric chromosome fragments (*i.e.* lacking a centromere), or whole chromosomes that are unable to migrate to the poles during the anaphase stage of cell division. Therefore the MNvit test is an *in vitro* method that provides a comprehensive basis for investigating chromosome damaging potential *in vitro* because both aneugens and clastogens can be detected (2) (3) in cells that have undergone cell division during or after exposure to the test chemical (see paragraph 13 for more details). Micronuclei represent damage that has been transmitted to daughter cells, whereas chromosome aberrations scored in metaphase cells may not be transmitted. In either case, the changes may not be compatible with cell survival.

This test method allows the use of protocols with and without the actin polymerisation inhibitor cytochalasin B (cytoB). The addition of cytoB prior to mitosis results in cells that are binucleate and therefore allows for the identification and analysis of micronuclei in only those cells that have completed one mitosis (4) (5). This test method also allows for the use of protocols without cytokinesis block, provided there is evidence that the cell population analysed has undergone mitosis.

In addition to using the MNvit test to identify chemicals that induce micronuclei, the use of immunochemical labelling of kinetochores, or hybridisation with centromeric/telomeric probes (fluorescence *in situ* hybridisation (FISH)), also can provide additional information on the mechanisms of chromosome damage and micronucleus formation (6) (7) (8) (9) (10) (11) (12) (13) (14) (15) (16) (17). Those labelling and hybridisation procedures can be used when there is an increase in micronucleus formation and the investigator wishes to determine if the increase was the result of clastogenic and/or aneugenic events.

Because micronuclei in interphase cells can be assessed relatively objectively, laboratory personnel need only determine the number of binucleate cells when cytoB is used and the incidence of micronucleate cells in all cases. As a result, the slides can be scored relatively quickly and analysis can be automated. This makes it practical to score thousands instead of hundreds of cells per treatment, increasing the power of the test. Finally, as micronuclei may arise from lagging chromosomes, there is the potential to detect aneuploidy-inducing agents that are difficult to study in conventional chromosomal aberration tests, e.g. Chapter B.10 of this annex (18). However, the MNvit test as described in this test method does not allow for the differentiation of chemicals inducing changes in chromosome number and/or ploidy from those inducing clastogenicity without special techniques such as FISH mentioned under paragraph 4.

The MNvit test is robust and can be conducted in a variety of cell types, and in the presence or absence of cytoB. There are extensive data to support the validity of the MNvit test using various cell types (cultures of cell lines or primary cell cultures) (19) (20) (21) (22) (23) (24) (25) (26) (27) (28) (29) (30) (31) (32) (33) (34) (35) (36). These include, in particular, the international validation studies co-ordinated by the Société Française de Toxicologie Génétique (SFTG) (19) (20) (21) (22) (23) and the reports of the International Workshop on Genotoxicity Testing (5) (17). The available data have also been re-evaluated in a weight-of-evidence retrospective validation study by the European Centre for the Validation

▼ M7

of Alternative Methods (ECVAM) of the European Commission (EC), and the test method has been endorsed as scientifically valid by the ECVAM Scientific Advisory Committee (ESAC) (37) (38) (39).

The mammalian cell MNvit test may employ cultures of cell lines or primary cell cultures, of human or rodent origin. Because the background frequency of micronuclei will influence the sensitivity of the test, it is recommended that cell types with a stable and defined background frequency of micronucleus formation be used. The cells used are selected on the basis of their ability to grow well in culture, stability of their karyotype (including chromosome number) and spontaneous frequency of micronuclei (40). At the present time, the available data do not allow firm recommendations to be made but suggest it is important, when evaluating chemical hazards to consider the *p53* status, genetic (karyotype) stability, DNA repair capacity and origin (rodent *versus* human) of the cells chosen for testing. The users of this test method are thus encouraged to consider the influence of these and other cell characteristics on the performance of a cell line in detecting the induction of micronuclei, as knowledge evolves in this area.

Definitions used are provided in Appendix 1.

INITIAL CONSIDERATIONS AND LIMITATIONS

Tests conducted *in vitro* generally require the use of an exogenous source of metabolic activation unless the cells are metabolically competent with respect to the test chemicals. The exogenous metabolic activation system does not entirely mimic *in vivo* conditions. Care should be taken to avoid conditions that could lead to artifactual positive results which do not reflect the genotoxicity of the test chemicals. Such conditions include changes in pH (41) (42) (43) or osmolality, interaction with the cell culture medium (44) (45) or excessive levels of cytotoxicity (see paragraph 29).

To analyse the induction of micronuclei, it is essential that mitosis has occurred in both treated and untreated cultures. The most informative stage for scoring micronuclei is in cells that have completed one mitosis during or after treatment with the test chemical. For Manufactured Nanomaterials, specific adaptations of this test method are needed but they are not described in this test method.

Before use of the test method on a mixture for generating data for an intended regulatory purpose, it should be considered whether, and if so why, it may provide adequate results for that purpose. Such considerations are not needed, when there is a regulatory requirement for testing of the mixture.

PRINCIPLE OF THE TEST

Cell cultures of human or other mammalian origin are exposed to the test chemical both with and without an exogenous source of metabolic activation unless cells with an adequate metabolising capability are used (see paragraph 19).

During or after exposure to the test chemical, the cells are grown for a period sufficient to allow chromosome damage or other effects on cell cycle/cell division to lead to the formation of micronuclei in interphase cells. For induction of

▼ M7

aneuploidy, the test chemical should ordinarily be present during mitosis. Harvested and stained interphase cells are analysed for the presence of micronuclei. Ideally, micronuclei should only be scored in those cells that have completed mitosis during exposure to the test chemical or during the post-treatment period, if one is used. In cultures that have been treated with a cytokinesis blocker, this is easily achieved by scoring only binucleate cells. In the absence of a cytokinesis blocker, it is important to demonstrate that the cells analysed are likely to have undergone cell division, based on an increase in the cell population, during or after exposure to the test chemical. For all protocols, it is important to demonstrate that cell proliferation has occurred in both the control and treated cultures, and the extent of test chemical-induced cytotoxicity or cytostasis should be assessed in all of the cultures that are scored for micronuclei.

DESCRIPTION OF THE METHOD**Cells**

Cultured primary human or other mammalian peripheral blood lymphocytes (7) (20) (46) (47) and a number of rodent cell lines such as CHO, V79, CHL/IU, and L5178Y cells or human cell lines such as TK6 can be used (19) (20) (21) (22) (23) (26) (27) (28) (29) (31) (33) (34) (35) (36) (see paragraph 6). Other cell lines such as HT29 (48), Caco-2 (49), HepaRG (50) (51), HepG2 cells (52) (53), A549 and primary Syrian Hamster Embryo cells (54) have been used for micronucleus testing but at this time have not been extensively validated. Therefore the use of those cell lines and types should be justified based on their demonstrated performance in the test, as described in the Acceptability Criteria section. Cyto B was reported to potentially impact L5178Y cell growth and therefore is not recommended with this cell line (23). When primary cells are used, for animal welfare reasons, the use of cells from human origin should be considered where feasible and sampled in accordance with the human ethical principles and regulations.

Human peripheral blood lymphocytes should be obtained from young (approximately 18-35 years of age), non-smoking individuals with no known illness or recent exposures to genotoxic agents (e.g. chemicals, ionising radiation) at levels that would increase the background incidence of micronucleate cells. This would ensure the background incidence of micronucleate cells to be low and consistent. The baseline incidence of micronucleate cells increases with age and this trend is more marked in females than in males (55). If cells from more than one donor are pooled for use, the number of donors should be specified. It is necessary to demonstrate that the cells have divided from the beginning of treatment with the test chemical to cell sampling. Cell cultures are maintained in an exponential growth phase (cell lines) or stimulated to divide (primary cultures of lymphocytes) to expose the cells at different stages of the cell cycle, since the sensitivity of cell stages to the test chemicals may not be known. The primary cells that need to be stimulated with mitogenic agents in order to divide are generally no longer synchronised during exposure to the test chemical (e.g. human lymphocytes after a 48-hour mitogenic stimulation). The use of synchronised cells during treatment with the test chemical is not recommended, but can be acceptable if justified.

Media and culture conditions

Appropriate culture medium and incubation conditions (culture vessels, humidified atmosphere of 5 % CO₂ if appropriate, temperature of 37 °C) should be used for maintaining cultures. Cell lines should be checked routinely for the stability of the modal chromosome number and the absence of *Mycoplasma* contamination, and cells should not be used if contaminated or if the modal chromosome number has changed. The normal cell cycle time of cell lines or primary cultures used in the testing laboratory should be established and should be consistent with the published cell characteristics.

▼ M7*Preparation of cultures*

Cell lines: cells are propagated from stock cultures, seeded in culture medium at a density such that the cells in suspensions or in monolayers will continue to grow exponentially until harvest time (e.g. confluence should be avoided for cells growing in monolayers).

Lymphocytes: whole blood treated with an anti-coagulant (e.g. heparin), or separated lymphocytes, are cultured (e.g. for 48 hours for human lymphocytes) in the presence of a mitogen (e.g. phytohaemagglutinin (PHA) for human lymphocytes) in order to induce cell division prior to exposure to the test chemical and cytoB.

Metabolic activation

Exogenous metabolising systems should be used when employing cells with inadequate endogenous metabolic capacity. The most commonly used system that is recommended by default, unless another system is justified is a co-factor-supplemented post-mitochondrial fraction (S9) prepared from the livers of rodents (generally rats) treated with enzyme-inducing agents such as Aroclor 1254 (56) (57) or a combination of phenobarbital and b-naphthoflavone (58) (59) (60). The latter combination does not conflict with the Stockholm Convention on Persistent Organic Pollutants (61) and has been shown to be as effective as Aroclor 1254 for inducing mixed-function oxidases (58) (59) (60). The S9 fraction typically is used at concentrations ranging from 1 to 2 % (v/v) but may be increased to 10 % (v/v) in the final test medium. The use of products that reduce the mitotic index, especially calcium complexing products (62), should be avoided during treatment. The choice of type and concentration of exogenous metabolic activation system or metabolic inducer employed may be influenced by the class of chemicals being tested.

Test chemical preparation

Solid test chemicals should be prepared in appropriate solvents and diluted, if appropriate, prior to treatment of the cells. Liquid test chemicals may be added directly to the test system and/or diluted prior to treatment of the test system. Gaseous or volatile test chemicals should be tested by appropriate modifications to the standard protocols, such as treatment in sealed vessels (63) (64) (65). Preparations of the test chemical should be made just prior to treatment unless stability data demonstrate the acceptability of storage.

Test Conditions*Solvents*

The solvent should be chosen to optimise the solubility of the test chemicals without adversely impacting the conduct of the assay, *i.e.* changing cell growth, affecting integrity of the test chemical, reacting with culture vessels, impairing the metabolic activation system. It is recommended that, wherever possible, the use of an aqueous solvent (or culture medium) should be considered first. Well established solvents are water or dimethyl sulfoxide (DMSO). Generally organic solvents should not exceed 1 % (v/v). If cytoB is dissolved in DMSO, the total amount of organic solvent used for both the test chemical and cytoB should not exceed 1 % (v/v); otherwise, untreated controls should be used to ensure that the percentage of organic solvent has no adverse effect. Aqueous solvents (saline or water) should not exceed 10 % (v/v) in the final treatment medium. If other than

▼ M7

well-established solvents are used (e.g. ethanol or acetone), their use should be supported by data indicating their compatibility with the test chemical, the test system and their lack of genetic toxicity at the concentration used. In the absence of that supporting data, it is important to include untreated controls (see Appendix 1), as well as solvent controls to demonstrate that no deleterious or chromosomal effects (e.g. aneuploidy or clastogenicity) are induced by the chosen solvent.

Use of cytoB as a cytokinesis blocker

One of the most important considerations in the performance of the MNvit test is ensuring that the cells being scored have completed mitosis during the treatment or the post-treatment incubation period, if one is used. Micronucleus scoring, therefore, should be limited to cells that have gone through mitosis during or after treatment. CytoB is the agent that has been most widely used to block cytokinesis because it inhibits actin assembly, and thus prevents separation of daughter cells after mitosis, leading to the formation of binucleate cells (6) (66) (67). The effect of the test chemical on cell proliferation kinetics can be measured simultaneously, when cytoB is used. CytoB should be used as a cytokinesis blocker when human lymphocytes are used because cell cycle times will be variable among donors and because not all lymphocytes will respond to PHA stimulation. CytoB is not mandatory for other cell types if it can be established they have undergone division as described in paragraph 27. Moreover CytoB is not generally used when samples are evaluated for micronuclei using flow cytometric methods.

The appropriate concentration of cytoB should be determined by the laboratory for each cell type to achieve the optimal frequency of binucleate cells in the solvent control cultures and should be shown to produce a good yield of binucleate cells for scoring. The appropriate concentration of cytoB is usually between 3 and 6 µg/ml (19).

Measuring cell proliferation and cytotoxicity and choosing treatment concentrations

When determining the highest test chemical concentration, concentrations that have the capability of producing artifactual positive responses, such as those producing excessive cytotoxicity (see paragraph 29), precipitation in the culture medium (see paragraph 30), or marked changes in pH or osmolality (see paragraph 9), should be avoided. If the test chemical causes a marked change in the pH of the medium at the time of addition, the pH might be adjusted by buffering the final treatment medium so as to avoid artifactual positive results and to maintain appropriate culture conditions.

Measurements of cell proliferation are made to assure that sufficient treated cells have undergone mitosis during the test and that the treatments are conducted at appropriate levels of cytotoxicity (see paragraph 29). Cytotoxicity should be determined in the main experiment with and without metabolic activation using an appropriate indication of cell death and growth (see paragraphs 26 and 27). While the evaluation of cytotoxicity in an initial preliminary test may be useful to better define the concentrations to be used in the main experiment, an initial test is not mandatory. If performed, it should not replace the measurement of cytotoxicity in the main experiment.

Treatment of cultures with cytoB and measurement of the relative frequencies of mononucleate, binucleate, and multi-nucleate cells in the culture provides an

▼ M7

accurate method of quantifying the effect on cell proliferation and the cytotoxic or cytostatic activity of a treatment (6), and ensures that only cells that divided during or after treatment are microscopically scored. The cytokinesis-block proliferation index (CBPI) (6) (27) (68) or the Replication Index (RI) from at least 500 cells per culture (see Appendix 2 for formulas) are recommended to estimate the cytotoxic and cytostatic activity of a treatment by comparing values in the treated and control cultures. Assessment of other indicators of cytotoxicity (e.g. cell integrity, apoptosis, necrosis, metaphase counting, cell cycle) could provide useful information, but should not be used in place of CBPI or RI.

In studies without cytoB, it is necessary to demonstrate that the cells in culture have divided, so that a substantial proportion of the cells scored have undergone division during or following treatment with the test chemical, otherwise false negative responses may be produced. The measurement of Relative Population Doubling (RPD) or Relative Increase in Cell Count (RICC) is recommended to estimate the cytotoxic and cytostatic activity of a treatment (17) (68) (69) (70) (71) (see Appendix 2 for formulas). At extended sampling times (e.g. treatment for 1,5-2 normal cell cycle lengths and harvest after an additional 1,5-2 normal cell cycle lengths, leading to sampling times longer than 3-4 normal cell cycle lengths in total as described in paragraphs 38 and 39), RPD might underestimate cytotoxicity (71). Under these circumstances RICC might be a better measure or the evaluation of cytotoxicity after a 1,5-2 normal cell cycle lengths would be a helpful estimate. Assessment of other markers for cytotoxicity or cytostasis (e.g. cell integrity, apoptosis, necrosis, metaphase counting, Proliferation index (PI), cell cycle, nucleoplasmic bridges or nuclear buds) could provide useful additional information, but should not be used in place of either the RPD or RICC.

At least three test concentrations (not including the solvent and positive controls) that meet the acceptability criteria (appropriate cytotoxicity, number of cells, etc) should be evaluated. Whatever the types of cells (cell lines or primary cultures of lymphocytes), either replicate or single treated cultures may be used at each concentration tested. While the use of duplicate cultures is advisable, single cultures are also acceptable provided that the same total number of cells are scored for either single or duplicate cultures. The use of single cultures is particularly relevant when more than 3 concentrations are assessed (see paragraphs 44-45). The results obtained from the independent replicate cultures at a given concentration can be pooled for the data analysis. For test chemicals demonstrating little or no cytotoxicity, concentration intervals of approximately 2 to 3 fold will usually be appropriate. Where cytotoxicity occurs, the test concentrations selected should cover a range from that producing cytotoxicity as described in paragraph 29 and including concentrations at which there is moderate and little or no cytotoxicity. Many test chemicals exhibit steep concentration response curves and in order to obtain data at low and moderate cytotoxicity or to study the dose response relationship in detail, it will be necessary to use more closely spaced concentrations and/or more than three concentrations (single cultures or replicates) in particular in situations where a repeat experiment is required (see paragraph 60).

If the maximum concentration is based on cytotoxicity, the highest concentration should aim to achieve 55 ± 5 % cytotoxicity using the recommended cytotoxicity parameters (*i.e.* reduction in RICC and RPD for cell lines when cytoB is not used, and reduction in CBPI or RI when cytoB is used to 45 ± 5 % of the concurrent negative control) (72). Care should be taken in interpreting positive results only found in the higher end of this 55 ± 5 % cytotoxicity range (71).

▼ M7

For poorly soluble test chemicals that are not cytotoxic at concentrations lower than the lowest insoluble concentration, the highest concentration analysed should produce turbidity or a precipitate visible by eye or with the aid of an inverted microscope at the end of the treatment with the test chemical. Even if cytotoxicity occurs above the lowest insoluble concentration, it is advisable to test at only one concentration inducing turbidity or with visible precipitate because artifactual effects may result from the precipitate. At the concentration producing a precipitate, care should be taken to assure that the precipitate does not interfere with the conduct of the test (e.g. staining or scoring). The determination of solubility in the culture medium prior to the experiment may be useful.

If no precipitate or limiting cytotoxicity is observed, the highest test concentration should correspond to 10 mM, 2 mg/ml or 2 µl/ml, whichever is the lowest (73) (74) (75). When the test chemical is not of defined composition, e.g. a substance of unknown or variable composition, complex reaction products or biological materials (UVCB) (76), environmental extract, etc., the top concentration may need to be higher (e.g. 5 mg/ml) in the absence of sufficient cytotoxicity, to increase the concentration of each of the components. It should be noted however that these requirements may differ for human pharmaceuticals (93).

Controls

Concurrent negative controls (see paragraph 21), consisting of solvent alone in the treatment medium and processed in the same way as the treatment cultures, should be included for every harvest time.

Concurrent positive controls are needed to demonstrate the ability of the laboratory to identify clastogens and aneugens under the conditions of the test protocol used and the effectiveness of the exogenous metabolic activation system (when applicable). Examples of positive controls are given in Table 1 below. Alternative positive control chemicals can be used, if justified.

At the present time, no aneugens are known that require metabolic activation for their genotoxic activity (17). Because *in vitro* mammalian cell tests for genetic toxicity are sufficiently standardised for the short-term treatments done concurrently with and without metabolic activation using the same treatment duration, the use of positive controls may be confined to a clastogen requiring metabolic activation. In this case a single clastogenic positive control response will demonstrate both the activity of the metabolic activation system and the responsiveness of the test system. However, long term treatment (without S9) should have its own positive control, as the treatment duration will differ from the test using metabolic activation. If a clastogen is selected as the single positive control for short-term treatment with and without metabolic activation, an aneugen should be selected for the long-term treatment without metabolic activation. Positive controls for both clastogenicity and aneugenicity should be used in metabolically competent cells that do not require S9.

Each positive control should be used at one or more concentrations expected to give reproducible and detectable increases over background in order to demonstrate the sensitivity of the test system (*i.e.* the effects are clear but do not immediately reveal the identity of the coded slides to the reader), and the response should not be compromised by cytotoxicity exceeding the limits specified in this test method.

▼ **M7**

Table 1

Reference chemicals recommended for assessing laboratory proficiency and for the selection of positive controls

Category	Chemical	CASRN
1. Clastogens active without metabolic activation		
	Methyl methanesulphonate	66-27-3
	Mitomycin C	50-07-7
	4-Nitroquinoline-N-Oxide	56-57-5
	Cytosine arabinoside	147-94-4
2. Clastogens requiring metabolic activation		
	Benzo(a)pyrene	50-32-8
	Cyclophosphamide	50-18-0
3. Aneugens		
	Colchicine	64-86-8
	Vinblastine	143-67-9

PROCEDURE

Treatment Schedule

In order to maximise the probability of detecting an aneugen or clastogen acting at a specific stage in the cell cycle, it is important that sufficient numbers of cells representing all of the various stages of their cell cycles are treated with the test chemical. All treatments should commence and end while the cells are growing exponentially and the cells should continue to grow up to the time of sampling. The treatment schedule for cell lines and primary cell cultures may, therefore, differ somewhat from that for lymphocytes which require mitogenic stimulation to begin their cell cycle (17). For lymphocytes, the most efficient approach is to start the treatment with the test chemical at 44-48 hours after PHA stimulation, when cells will be dividing asynchronously (6).

Published data (19) indicate that most aneugens and clastogens will be detected by a short term treatment period of 3 to 6 hours in the presence and absence of S9, followed by removal of the test chemical and sampling at a time equivalent to about 1,5 - 2,0 normal cell cycle lengths after the beginning of treatment (7).

However, for thorough evaluation, which would be needed to conclude a negative outcome, all three following experimental conditions should be conducted using a short term treatment with and without metabolic activation and long term treatment without metabolic activation (see paragraphs 56, 57 and 58):

- Cells should be exposed to the test chemical without metabolic activation for 3-6 hours, and sampled at a time equivalent to about 1,5 - 2,0 normal cell cycle lengths after the beginning of treatment (19),
- Cells should be exposed to the test chemical with metabolic activation for 3-6 hours, and sampled at a time equivalent to about 1,5 - 2,0 normal cell cycle lengths after the beginning of treatment (19),

▼ **M7**

- Cells should be continuously exposed without metabolic activation until sampling at a time equivalent to about 1,5 - 2,0 normal cell cycle lengths.

In the event that any of the above experimental conditions lead to a positive response, it may not be necessary to investigate any of the other treatment regimens.

If it is known or suspected that the test chemical affects the cell cycling time (e.g. when testing nucleoside analogues), especially for p53 competent cells (35) (36) (77), sampling or recovery times may be extended by up to a further 1,5 - 2,0 normal cell cycle lengths (*i.e.* total 3,0 to 4,0 cell cycle lengths after the beginning of short-term and long-term treatments). These options address situations where there may be concern regarding possible interactions between the test chemical and cytoB. When using extended sampling times (*i.e.* total 3,0 to 4,0 cell cycle lengths culture time), care should be taken to ensure that the cells are still actively dividing. For example, for lymphocytes exponential growth may be declining at 96 hours following stimulation and monolayer cultures of cells may become confluent.

The suggested cell treatment schedules are summarised in Table 2. These general treatment schedules may be modified (and should be justified) depending on the stability or reactivity of the test chemical or the particular growth characteristics of the cells being used.

Table 2

Cell treatment and harvest times for the MNvit test

Lymphocytes, primary cells and cell lines treated <u>with</u> cytoB	+ S9 Short treatment	Treat for 3-6 hours in the presence of S9; remove the S9 and treatment medium; add fresh medium and cytoB; harvest 1,5 - 2,0 normal cell cycle lengths after the beginning of treatment.
	- S9 Short treatment	Treat for 3-6 hours; remove the treatment medium; add fresh medium and cytoB; harvest 1,5 - 2,0 normal cell cycle lengths after the beginning of treatment.
	- S9 Extended treatment	Treat for 1,5 - 2 normal cell cycle lengths in the presence of cytoB; harvest at the end of the treatment period.

Cell lines treated without cytoB
(Identical to the treatment schedules outlined above with the exception that no cytoB is added)

For monolayer cultures, mitotic cells (identifiable as being round and detaching from the surface) may be present at the end of the 3-6 hour treatment. Because these mitotic cells are easily detached, they can be lost when the medium containing the test chemical is removed. If there is evidence for a substantial increase in the number of mitotic cells compared with controls, indicating likely mitotic arrest, then the cells should be collected by centrifugation and added back to the culture, to avoid losing cells that are in mitosis, and at risk for micro-nuclei/chromosome aberration, at the time of harvest.

▼ M7**Cell harvest and slide preparation**

Each culture should be harvested and processed separately. Cell preparation may involve hypotonic treatment, but this step is not necessary if adequate cell spreading is otherwise achieved. Different techniques can be used in slide preparation provided that high-quality cell preparations for scoring are obtained. Cells with intact cell membrane and intact cytoplasm should be retained to allow the detection of micronuclei and (in the cytokinesis-block method) reliable identification of binucleate cells.

The slides can be stained using various methods, such as Giemsa or fluorescent DNA specific dyes. The use of appropriate fluorescent stains (e.g. acridine orange (78) or Hoechst 33258 plus pyronin-Y (79)) can eliminate some of the artifacts associated with using a non-DNA specific stain. Anti-kinetochore antibodies, FISH with pancentromeric DNA probes, or primed *in situ* labelling with pancentromere-specific primers, together with appropriate DNA counter-staining, can be used to identify the contents (whole chromosomes will be stained while acentric chromosome fragments will not) of micronuclei if mechanistic information of their formation is of interest (16) (17). Other methods for differentiation between clastogens and aneugens may be used if they have been shown to be effective and validated. For example, for certain cell lines the measurements of sub-2N nuclei as hypodiploid events using techniques such as image analysis, laser scanning cytometry or flow cytometry could also provide useful information (80) (81) (82). Morphological observations of nuclei could also give indications of possible aneuploidy. Moreover, a test for metaphase chromosome aberrations, preferably in the same cell type and protocol with comparable sensitivity, could also be a useful way to determine whether micronuclei are due to chromosome breakage (knowing that chromosome loss would not be detected in the chromosome aberration test).

Analysis

All slides, including those of the solvent and the untreated (if used) and positive controls, should be independently coded before the microscopic analysis of micronucleus frequencies. Appropriate techniques should be used to control any bias or drift when using an automated scoring system, for instance, flow cytometry, laser scanning cytometry or image analysis. Regardless of the automated platform is used to enumerate micronuclei, CBPI, RI, RPD, or RICC should be assessed concurrently.

In cytoB-treated cultures, micronucleus frequencies should be analysed in at least 2 000 binucleate cells per concentration and control (83), equally divided among the replicates, if replicates are used. In the case of single cultures per dose (see paragraph 28), at least 2 000 binucleate cells per culture (83) should be scored in this single culture. If substantially fewer than 1 000 binucleate cells per culture (for duplicate cultures), or 2 000 (for single culture), are available for scoring at each concentration, and if a significant increase in micronuclei is not detected, the test should be repeated using more cells, or at less cytotoxic concentrations, whichever is appropriate. Care should be taken not to score binucleate cells with irregular shapes or where the two nuclei differ greatly in size. In addition, binucleate cells should not be confused with poorly spread multi-nucleate cells. Cells containing more than two main nuclei should not be analysed for micronuclei, as the baseline micronucleus frequency may be higher in these cells (84). Scoring of mononucleate cells is acceptable if the test chemical is shown to interfere with cytoB activity. A repeat test without CytoB might be useful in

▼ M7

such cases. Scoring mononucleate cells in addition to binucleate cells could provide useful information (85) (86), but is not mandatory.

In cell lines tested without cytoB treatment, micronuclei should be scored in at least 2 000 cells per test concentration and control (83), equally divided among the replicates, if replicates are used. When single cultures per concentration are used (see paragraph 28), at least 2 000 cells per culture should be scored in this single culture. If substantially fewer than 1 000 cells per culture (for duplicate cultures), or 2 000 (for single culture), are available for scoring at each concentration, and if a significant increase in micronuclei is not detected, the test should be repeated using more cells, or at less cytotoxic concentrations, whichever is appropriate.

When cytoB is used, a CBPI or an RI should be determined to assess cell proliferation (see Appendix 2) using at least 500 cells per culture. When treatments are performed in the absence of cytoB, it is essential to provide evidence that the cells in culture have divided, as discussed in paragraphs 24-28.

Proficiency of the laboratory

In order to establish sufficient experience with the assay prior to using it for routine testing, the laboratory should have performed a series of experiments with reference positive chemicals acting via different mechanisms (at least one with and one without metabolic activation, and one acting via an aneugenic mechanism, and selected from the chemicals listed in Table 1) and various negative controls (including untreated cultures and various solvents/vehicle). These positive and negative control responses should be consistent with the literature. This is not applicable to laboratories that have experience, *i.e.* that have an historical data base available as defined in paragraphs 49 to 52.

A selection of positive control chemicals (see Table 1) should be investigated with short and long treatments in the absence of metabolic activation, and also with short treatment in the presence of metabolic activation, in order to demonstrate proficiency to detect clastogenic and aneugenic chemicals, determine the effectiveness of the metabolic activation system and demonstrate the appropriateness of the scoring procedures (microscopic visual analysis, flow cytometry, laser scanning cytometry or image analysis). A range of concentrations of the selected chemicals should be chosen so as to give reproducible and concentration-related increases above the background in order to demonstrate the sensitivity and dynamic range of the test system.

Historical control data

The laboratory should establish:

- A historical positive control range and distribution,

- A historical negative (untreated, solvent) control range and distribution.

When first acquiring data for an historical negative control distribution, concurrent negative controls should be consistent with published negative control data where they exist. As more experimental data are added to the control distribution, concurrent negative controls should ideally be within the 95 % control limits of that distribution (87) (88). The laboratory's historical negative control database, should initially be built with a minimum of 10 experiments but would preferably consist of at least 20 experiments conducted under comparable experimental conditions. Laboratories should use quality control methods, such as control charts (e.g. C-charts or X-bar charts (88)), to

▼ M7

identify how variable their positive and negative control data are, and to show that the methodology is 'under control' in their laboratory (83). Further recommendations on how to build and use the historical data (*i.e.* criteria for inclusion and exclusion of data in historical data and the acceptability criteria for a given experiment) can be found in the literature (87).

Any changes to the experimental protocol should be considered in terms of the consistency of the data with the laboratory's existing historical control databases. Any major inconsistencies should result in the establishment of a new historical control database.

Negative control data should consist of the incidence of micronucleated cells from a single culture or the sum of replicate cultures as described in paragraph 28. Concurrent negative controls should ideally be within the 95 % control limits of the distribution of the laboratory's historical negative control database (87) (88). Where concurrent negative control data fall outside the 95 % control limits, they may be acceptable for inclusion in the historical control distribution as long as these data are not extreme outliers and there is evidence that the test system is 'under control' (see paragraph 50) and there is evidence of absence of technical or human failure.

DATA AND REPORTING**Presentation of the results**

If the cytokinesis-block technique is used, only the frequencies of binucleate cells with micronuclei (independent of the number of micronuclei per cell) are used in the evaluation of micronucleus induction. The scoring of the numbers of cells with one, two, or more micronuclei can be reported separately and could provide useful information, but is not mandatory.

Concurrent measures of cytotoxicity and/or cytostasis for all treated, negative and positive control cultures should be determined (16). The CBPI or the RI should be calculated for all treated and control cultures as measurements of cell cycle delay when the cytokinesis-block method is used. In the absence of cytoB, the RPD or the RICC should be used (see Appendix 2).

Individual culture data should be provided. Additionally, all data should be summarised in tabular form.

Acceptability Criteria

Acceptance of a test is based on the following criteria:

- The concurrent negative control is considered acceptable for addition to the laboratory historical negative control database as described in paragraph 50.
- Concurrent positive controls (see paragraph 50) should induce responses that are compatible with those generated in the laboratory's historical positive control data base and produce a statistically significant increase compared with the concurrent negative control.
- Cell proliferation criteria in the solvent control should be fulfilled (paragraph 25-27).
- All experimental conditions were tested unless one resulted in positive results (paragraphs 36-40).
- Adequate number of cells and concentrations are analysable (paragraphs 28 and 44-46).

▼ M7

- The criteria for the selection of top concentration are consistent with those described in paragraphs 24-31.

Evaluation and interpretation of results

Providing that all acceptability criteria are fulfilled, a test chemical is considered to be clearly positive if, in any of the experimental conditions examined (see paragraphs 36-39):

- at least one of the test concentrations exhibits a statistically significant increase compared with the concurrent negative control (89)
- the increase is dose-related in at least one experimental condition when evaluated with an appropriate trend test (see paragraph 28)
- any of the results are outside the distribution of the historical negative control data (e.g. Poisson-based 95 % control limits; see paragraph 52).

When all of these criteria are met, the test chemical is then considered able to induce chromosome breaks and/or gain or loss in this test system. Recommendations for the most appropriate statistical methods can also be found in the literature (90) (91) (92).

Providing that all acceptability criteria are fulfilled, a test chemical is considered clearly negative if, in all experimental conditions examined (see paragraphs 36-39):

- none of the test concentrations exhibits a statistically significant increase compared with the concurrent negative control,
- there is no concentration-related increase when evaluated with an appropriate trend test,
- all results are inside the distribution of the historical negative control data (e.g. Poisson-based 95 % control limits; see paragraph 52).

The test chemical is then considered unable to induce chromosome breaks and/or gain or loss in this test system. Recommendations for the most appropriate statistical methods can also be found in the literature (90) (91) (92).

There is no requirement for verification of a clear positive or negative response.

In case the response is neither clearly negative nor clearly positive as described above and/or in order to assist in establishing the biological relevance of a result, the data should be evaluated by expert judgement and/or further investigations. Scoring additional cells (where appropriate) or performing a repeat experiment possibly using modified experimental conditions (e.g. concentration spacing, other metabolic activation conditions [*i.e.* S9 concentration or S9 origin]) could be useful.

In rare cases, even after further investigations, the data set will not allow a conclusion of positive or negative, and will therefore be concluded as equivocal.

Test chemicals that induce micronuclei in the MNvit test may do so because they induce chromosome breakage, chromosome loss, or a combination of the two. Further analysis using anti-kinetochore antibodies, centromere specific *in situ* probes, or other methods may be used to determine whether the mechanism of micronucleus induction is due to clastogenic and/or aneugenic activity.

▼ M7**Test Report**

The test report should include the following information:

Test chemical:

- source, lot number, limit date for use, if available;
- stability of the test chemical itself, if known;
- reactivity of the test chemicals with the solvent/vehicle or cell culture media;
- solubility and stability of the test chemical in solvent, if known;
- measurement of pH, osmolality, and precipitate in the culture medium to which the test chemical was added, as appropriate.

Mono-constituent substance:

- physical appearance, water solubility, and additional relevant physico-chemical properties;
- chemical identification, such as IUPAC or CAS name, CAS number, SMILES or InChI code, structural formula, purity, chemical identity of impurities as appropriate and practically feasible, etc.

Multi-constituent substance, UVCBs and mixtures:

- characterised as far as possible by chemical identity (see above), quantitative occurrence and relevant physicochemical properties of the constituents.

Solvent:

- justification for choice of solvent;
- percentage of solvent in the final culture medium

Cells:

- type and source of cells used;
- suitability of the cell type used;
- absence of mycoplasma, in case of cell lines;
- for cell lines, information on cell cycle length or proliferation index;
- where lymphocytes are used, sex of blood donors, age and any relevant information on the donor, whole blood or separated lymphocytes, mitogen used;
- normal (negative control) cell cycle time;
- number of passages, if available, for cell lines;
- methods for the maintenance of cell cultures, for cell lines;
- modal number of chromosomes, for cell lines;

▼ M7*Test Conditions:*

- identity of the cytokinesis blocking substance (e.g. cytoB), if used, and its concentration and duration of cell exposure;
- concentration of the test chemical expressed as a final concentration in the culture medium (e.g. µg or mg/mL, or mM of culture medium);
- rationale for the selection of concentrations and the number of cultures, including cytotoxicity data and solubility limitations;
- composition of media, CO₂ concentration, if applicable, humidity level;
- concentration (and/or volume) of the solvent and test chemical added in the culture medium;
- incubation temperature and time;
- duration of treatment;
- harvest time after treatment;
- cell density at seeding, if applicable;
- type and composition of metabolic activation system, (source of S9, method of preparation of the S9 mix, the concentration or volume of S9 mix and S9 in the final culture medium, quality controls of S9 (e.g. enzymatic activity, sterility, metabolic capability));
- positive and negative control chemicals, final concentrations, conditions and durations of treatment and recovery periods;
- methods of slide preparation and the staining technique used;
- criteria for scoring micronucleate cells (selection of analysable cells and identification of micronucleus);
- numbers of cells analysed;
- methods for the measurements of cytotoxicity;
- any supplementary information relevant to cytotoxicity and method used;
- criteria for considering studies as positive, negative, or equivocal;
- method(s) of statistical analysis used;
- methods, such as use of anti-kinetochore antibody or pan-centromeric specific probes, to characterise whether micronuclei contain whole or fragmented chromosomes, if applicable;
- methods used to determine pH, osmolality and precipitation.

Results:

- definition of acceptable cells for analysis;
- in the absence of cyto B, the number of cells treated and the number of cells harvested for each culture in case of cell lines;

▼M7

- measurement of cytotoxicity used, e.g. CBPI or RI in the case of cytokinesis-block method; RICC or RPD when cytokinesis-block methods are not used; other observations if any (e.g. cell confluency, apoptosis, necrosis, metaphase counting, frequency of binucleated cells);
- signs of precipitation and time of the determination;
- data on pH and osmolality of the treatment medium, if determined;
- distribution of mono-, bi-, and multi-nucleate cells if a cytokinesis block method is used;
- number of cells with micronuclei given separately for each treated and control culture, and defining whether from binucleate or mononucleate cells, where appropriate;
- concentration-response relationship, where possible;
- concurrent negative (solvent) and positive control data (concentrations and solvents);
- historical negative (solvent) and positive control data, with ranges, means and standard deviation and 95 % control limits for the distribution, as well as the number of data;
- statistical analysis; p-values if any.

Discussion of the results.

Conclusions.

LITERATURE:

- (1) OECD (2016). Overview of the set of OECD Genetic Toxicology Test Guidelines and updates performed in 2014-2015. ENV Publications. Series on Testing and Assessment, No. 234, OECD, Paris.
- (2) Kirsch-Volders, M. (1997). Towards a validation of the micronucleus test. *Mutation Research*, Vol. 392/1-2, pp. 1-4.
- (3) Parry, J.M., A. Sors (1993). The detection and assessment of the aneugenic potential of environmental chemicals: the European Community aneuploidy project. *Mutation Research*, Vol. 287/1, pp. 3-15.
- (4) Fenech, M., A.A. Morley (1985). Solutions to the kinetic problem in the micronucleus assay. *Cytobios*, Vol. 43/172-173, pp. 233-246.
- (5) Kirsch-Volders, M. *et al.* (2000). Report from the *In Vitro* Micronucleus Assay Working Group. *Environmental and Molecular Mutagenesis*, Vol. 35/3, pp. 167-172.
- (6) Fenech, M. (2007). Cytokinesis-block micronucleus cytome assay. *Nature Protocols*, Vol. 2/5, pp. 1084-1104.
- (7) Fenech, M., A.A. Morley (1986). Cytokinesis-block micronucleus method in human lymphocytes: effect of *in-vivo* ageing and low dose X-irradiation. *Mutation Research*, Vol. 161/2, pp. 193-198.
- (8) Eastmond, D.A., J.D. Tucker (1989). Identification of aneuploidy-inducing agents using cytokinesis-blocked human lymphocytes and an antikinetochore antibody. *Environmental and Molecular Mutagenesis*, Vol. 13/1, pp. 34-43.

▼ **M7**

- (9) Eastmond, D.A., D. Pinkel (1990). Detection of aneuploidy and aneuploidy-inducing agents in human lymphocytes using fluorescence *in-situ* hybridisation with chromosome-specific DNA probe. *Mutation Research*, Vol. 234/5, pp. 9-20.
- (10) Miller, B.M. *et al.* (1991). Classification of micronuclei in murine erythrocytes: immunofluorescent staining using CREST antibodies compared to *in situ* hybridization with biotinylated gamma satellite DNA. *Mutagenesis*, Vol. 6/4, pp. 297-302.
- (11) Farooqi, Z., F. Darroudi, A. T. Natarajan (1993). The use of fluorescence *in-situ* hybridisation for the detection of aneugens in cytokinesis-blocked mouse splenocytes. *Mutagenesis*, Vol. 8/4, pp. 329-334.
- (12) Migliore, L. *et al.* (1993). Cytogenetic damage induced in human lymphocytes by four vanadium compounds and micronucleus analysis by fluorescence *in situ* hybridization with a centromeric probe. *Mutation Research*, Vol. 319/3, pp. 205-213.
- (13) Norppa, H., L. Renzi, C. Lindholm (1993). Detection of whole chromosomes in micronuclei of cytokinesis-blocked human lymphocytes by antikinetochore staining and *in situ* hybridization. *Mutagenesis*, Vol. 8/6, pp. 519-525.
- (14) Eastmond, D.A., D.S. Rupa, L.S. Hasegawa (1994). Detection of hyperdiploidy and chromosome breakage in interphase human lymphocytes following exposure to the benzene metabolite hydroquinone using multicolor fluorescence *in situ* hybridization with DNA probes. *Mutation Research*, Vol. 322/1, pp. 9-20.
- (15) Marshall, R.R. *et al.* (1996). Fluorescence *in situ* hybridisation (FISH) with chromosome-specific centromeric probes: a sensitive method to detect aneuploidy. *Mutation Research*, Vol. 372/2, pp. 233-245.
- (16) Zijno, P. *et al.* (1996). Analysis of chromosome segregation by means of fluorescence *in situ* hybridization: application to cytokinesis-blocked human lymphocytes. *Mutation Research*, Vol. 372/2, pp. 211-219.
- (17) Kirsch-Volders *et al.* (2003). Report from the *in vitro* micronucleus assay working group. *Mutation Research*, Vol. 540/2, pp. 153-163.
- (18) Chapter B.10 of this Annex: *In Vitro Mammalian Chromosome Aberration Test*.
- (19) Lorge, E. *et al.* (2006). SFTG International collaborative Study on *in vitro* micronucleus test. I. General conditions and overall conclusions of the study. *Mutation Research*, Vol. 607/1, pp. 13-36.
- (20) Clare, G. *et al.* (2006). SFTG International collaborative study on the *in vitro* micronucleus test. II. Using human lymphocytes. *Mutation Research*, Vol. 607/1, pp. 37-60.
- (21) Aardema, M.J. *et al.* (2006). SFTG International collaborative study on the *in vitro* micronucleus test, III. Using CHO cells. *Mutation Research*, Vol. 607/1, pp. 61-87.
- (22) Wakata, A. *et al.* (2006). SFTG International collaborative study on the *in vitro* micronucleus test, IV. Using CHO/IU cells. *Mutation Research*, Vol. 607/1, pp. 88-124.
- (23) Oliver, J. *et al.* (2006). SFTG International collaborative study on the *in vitro* micronucleus test, V. Using L5178Y cells. *Mutation Research*, Vol. 607/1, pp. 125-152.
- (24) Albertini, S. *et al.* (1997). Detailed data on *in vitro* MNT and *in vitro* CA: industrial experience. *Mutation Research*, Vol. 392/1-2, pp. 187-208.
- (25) Miller, B. *et al.* (1997). Comparative evaluation of the *in vitro* micronucleus test and the *in vitro* chromosome aberration test: industrial experience. *Mutation Research*, Vol. 392/1-2, pp. 45-59.

▼ M7

- (26) Miller, B. *et al.* (1998). Evaluation of the *in vitro* micronucleus test as an alternative to the *in vitro* chromosomal aberration assay: position of the GUM Working Group on the *in vitro* micronucleus test. Gesellschaft für Umwelt-Mutations-forschung, *Mutation Research*, Vol. 410, pp. 81-116.
- (27) Kalweit, S. *et al.* (1999). Chemically induced micronucleus formation in V79 cells — comparison of three different test approaches. *Mutation Research*, Vol. 439/2, pp. 183-190.
- (28) Kersten, B. *et al.* (1999). The application of the micronucleus test in Chinese hamster V79 cells to detect drug-induced photogenotoxicity. *Mutation Research*, Vol. 445/1, pp. 55-71.
- (29) von der Hude, W. *et al.* (2000). *In vitro* micronucleus assay with Chinese hamster V79 cells — results of a collaborative study with *in situ* exposure to 26 chemical substances. *Mutation Research*, Vol. 468/2, pp. 137-163.
- (30) Garriott, M.L., J.B. Phelps, W.P. Hoffman (2002). A protocol for the *in vitro* micronucleus test, I. Contributions to the development of a protocol suitable for regulatory submissions from an examination of 16 chemicals with different mechanisms of action and different levels of activity. *Mutation Research*, Vol. 517/1-2, pp. 123-134.
- (31) Matsushima, T. *et al.* (1999). Validation study of the *in vitro* micronucleus test in a Chinese hamster lung cell line (CHL/IU). *Mutagenesis*, Vol. 14/6, pp. 569-580.
- (32) Elhajouji, A., E. Lorge (2006). Special Issue: SFTG International collaborative study on *in vitro* micronucleus test. *Mutation Research*, Vol. 607/1, pp. 1-152.
- (33) Kirkland, D. (2010). Evaluation of different cytotoxic and cytostatic measures for the *in vitro* micronucleus test (MNVit): Introduction to the collaborative trial. *Mutation Research*, Vol. 702/2, pp. 139-147.
- (34) Hashimoto K. *et al.* (2011). Comparison of four different treatment conditions of extended exposure in the *in vitro* micronucleus assay using TK6 lymphoblastoid cells. *Regulatory Toxicology and Pharmacology*, Vol. 59/1, pp. 28-36.
- (35) Honma, M., M. Hayashi (2011). Comparison of *in vitro* micronucleus and gene mutation assay results for p53-competent versus p53-deficient human lymphoblastoid cells. *Environmental and Molecular Mutagenesis*, Vol. 52/5, pp. 373-384.
- (36) Zhang, L.S. *et al.* (1995). A comparative study of TK6 human lymphoblastoid and L5178Y mouse lymphoma cell lines in the *in vitro* micronucleus test. *Mutation Research Letters*, Vol. 347/3-4, pp. 105-115.
- (37) ECVAM (2006). Statement by the European Centre for the Validation of Alternative Methods (ECVAM) Scientific Advisory Committee (ESAC) on the scientific validity of the *in vitro* micronucleus test as an alternative to the *in vitro* chromosome aberration assay for genotoxicity testing. ESAC 25th meeting, 16-17 November 2006, Available at: <http://ecvam.jrc.it/index.htm>.
- (38) ESAC (2006). ECVAM Scientific Advisory Committee (ESAC) Peer Review, Retrospective Validation of the *In Vitro* Micronucleus Test, Summary and Conclusions of the Peer Review Panel. Available at: <http://ecvam.jrc.it/index.htm>.
- (39) Corvi, R. *et al.* (2008). ECVAM Retrospective Validation of *in vitro* Micronucleus Test (MNT). *Mutagenesis*, Vol 23/4, pp. 271-283.
- (40) ILSI paper (draft). Lorge, E., M.M. Moore, J. Clements, M. O'Donovan, M. Honma, A. Kohara, J. van Benthem, S. Galloway, M.J. Armstrong, A. Sutter, V. Thybaud, B. Gollapudi, M. Aardema, J. Young-Tannir. Standardized Cell Sources and Recommendations for Good Cell Culture Practices in Genotoxicity Testing. *Mutation Research*.

▼ M7

- (41) Scott, D. *et al.* (1991). International Commission for Protection Against Environmental Mutagens and Carcinogens, Genotoxicity under extreme culture conditions. A report from ICPEMC Task Group 9. *Mutation Research*, Vol. 257/2, pp. 147-205.
- (42) Morita, T. *et al.* (1992). Clastogenicity of low pH to various cultured mammalian cells. *Mutation Research*, Vol. 268/2, pp. 297-305.
- (43) Brusick, D. (1986). Genotoxic effects in cultured mammalian cells produced by low pH treatment conditions and increased ion concentrations. *Environmental Mutagenesis*, Vol. 8/6, pp. 789-886.
- (44) Long, L.H. *et al.* (2007). Different cytotoxic and clastogenic effects of epigallocatechin gallate in various cell-culture media due to variable rates of its oxidation in the culture medium. *Mutation Research*, Vol. 634/1-2, pp. 177-183.
- (45) Nesslany, F. *et al.* (2008). Characterization of the Genotoxicity of Nitriro-triacetic Acid. *Environmental and Molecular Mutation.*, Vol. 49, pp. 439-452.
- (46) Fenech, M., A.A. Morley (1985). Measurement of micronuclei in lymphocytes. *Mutation Research*, Vol. 147/1-2, pp. 29-36.
- (47) Fenech, M. (1997). The advantages and disadvantages of cytokinesis-blood micronucleus method. *Mutation Research*, Vol. 392, pp. 11-18.
- (48) Payne, C.M. *et al.* (2010). Hydrophobic bile acid-induced micronuclei formation, mitotic perturbations, and decreases in spindle checkpoint proteins: relevance to genomic instability in colon carcinogenesis. *Nutrition and Cancer*, Vol. 62/6, pp. 825-840.
- (49) Bazin, E. *et al.* (2010). Genotoxicity of a Freshwater Cyanotoxin, Cyindrospermopsin, in Two Human Cell Lines: Caco-2 and HepaRG. *Environmental and Molecular Mutagenesis*, Vol. 51/3, pp. 251-259.
- (50) Le Hagarat, L. *et al.* (2010). Assessment of the genotoxic potential of indirect chemical mutagens in HepaRG cells by the comet and the cytokinesis-block micronucleus assays. *Mutagenesis*, Vol. 25/6, pp. 555-560.
- (51) Josse, R. *et al.* (2012). An adaptation of the human HepaRG cells to the *in vitro* micronucleus assay. *Mutagenesis*, Vol. 27/3, pp. 295-304.
- (52) Ehrlich, V. *et al.* (2002). Fumonisin B₁ is genotoxic in human derived hepatoma (HepG2) cells. *Mutagenesis*, Vol. 17/3, pp. 257-260.
- (53) Knasmüller, S. *et al.* (2004). Use of human-derived liver cell lines for the detection of environmental and dietary genotoxicants; current state of knowledge. *Toxicology*, Vol. 198/1-3, pp. 315-328.
- (54) Gibson, D.P. *et al.* (1997). Induction of micronuclei in Syrian hamster embryo cells: comparison to results in the SHE cell transformation assay for National Toxicology Program test chemicals. *Mutation Research*, Vol. 392/1-2, pp. 61-70.
- (55) Bonassi, S. *et al.* (2001). HUMAN MicroNucleus Project: international database comparison for results with the cytokinesis-block micronucleus assay in human lymphocytes, I. Effect of laboratory protocol, scoring criteria and host factors on the frequency of micronuclei. *Environmental and Molecular Mutagenesis*, Vol. 37/1, pp. 31-45.
- (56) Maron, D.M., B.N. Ames (1983). Revised methods for the Salmonella mutagenicity test. *Mutation Research*, Vol. 113/3-4, pp. 173-215.
- (57) Ong, T.-m. *et al.* (1980). Differential effects of cytochrome P450-inducers on promutagen activation capabilities and enzymatic activities of S-9 from rat liver. *Journal of Environmental Pathology and Toxicology*, Vol. 4/1, pp. 55-65.

▼ M7

- (58) Elliott, B.M. *et al.* (1992). Alternatives to Aroclor 1254-induced S9 in *in vitro* genotoxicity assays. *Mutagenesis*, Vol. 7, pp. 175-177.
- (59) Matsushima, T. *et al.* (1976). 'A safe substitute for Polychlorinated Biphenyls as an Inducer of Metabolic Activation Systems', in *In Vitro Metabolic Activation in Mutagenesis Testing*. de Serres, F.J. *et al.* (eds), Elsevier, North-Holland, pp. 85-88.
- (60) Johnson, T.E., D. R. Umbenhauer, S.M. Galloway (1996). Human liver S-9 metabolic activation: proficiency in cytogenetic assays and comparison with phenobarbital/beta-naphthoflavone or Aroclor 1254 induced rat S-9. *Environmental and Molecular Mutagenesis*, Vol. 28, pp. 51-59.
- (61) UNEP (2001). Stockholm Convention on Persistent Organic Pollutants, United Nations Environment Programme (UNEP). Available at: <http://www.pops.int/>
- (62) Tucker, J.D., M.L. Christensen (1987). Effects of anticoagulants upon sister-chromatid exchanges, cell-cycle kinetics, and mitotic index in human peripheral lymphocytes. *Mutation Research*, Vol.190/3, pp. 225-8.
- (63) Krahn, D.F., F.C. Barsky, K.T. McCooey (1982). 'CHO/HGPRT Mutation Assay: Evaluation of Gases and Volatile Liquids', in *Genotoxic Effects of Airborne Agents*. Tice, R.R., D.L. Costa, K.M. Schaich (eds.), Plenum, New York, pp. 91-103.
- (64) Zamora, P.O. *et al.* (1983). Evaluation of an exposure system using cells grown on collagen gels for detecting highly volatile mutagens in the CHO/HGPRT mutation assay. *Environmental Mutagenesis*, Vol. 5/6, pp. 795-801.
- (65) Asakura, M. *et al.* (2008). An improved system for exposure of cultured mammalian cells to gaseous compounds in the chromosomal aberration assay. *Mutation Research*, Vol. 652/2, pp. 122-130.
- (66) Fenech, M. (1993). The cytokinesis-block micronucleus technique: a detailed description of the method and its application to genotoxicity studies in human populations. *Mutation Research*, Vol. 285/1, pp. 35-44.
- (67) Phelps, J.B., M.L. Garriott, W.P. Hoffman (2002). A protocol for the *in vitro* micronucleus test. II. Contributions to the validation of a protocol suitable for regulatory submissions from an examination of 10 chemicals with different mechanisms of action and different levels of activity. *Mutation Research*, Vol. 521/1-2, pp. 103-112.
- (68) Kirsch-Volders, M. *et al.* (2004). Corrigendum to 'Report from the *in vitro* micronucleus assay working group'. *Mutation Research*, 564, 97-100.
- (69) Lorge, E. *et al.* (2008). Comparison of different methods for an accurate assessment of cytotoxicity in the *in vitro* micronucleus test. I. Theoretical aspects. *Mutation Research*, Vol. 655/1-2, pp. 1-3.
- (70) Surralles, J. *et al.* (1995). Induction of micronuclei by five pyrethroid insecticides in whole-blood and isolated human lymphocyte cultures. *Mutation Research*, Vol. 341/3, pp. 169-184.
- (71) Honma, M. (2011). Cytotoxicity measurement in *in vitro* chromosome aberration test and micronucleus test. *Mutation Research*, Vol. 724, pp. 86-87.
- (72) Pfuhrer, S. *et al.* (2011). *In vitro* genotoxicity test approaches with better predictivity: Summary of an IWGT workshop. *Mutation Research*, Vol. 723/2, pp. 101-107.
- (73) OECD (2014). Document supporting the WNT decision to implement revised criteria for the selection of the top concentration in the *in vitro* mammalian cell assays on genotoxicity (Test Guidelines 473, 476 and 487). ENV/JM/TG(2014)17. Available upon request.

▼ M7

- (74) Morita T., M. Honma, K. Morikawa (2012). Effect of reducing the top concentration used in the *in vitro* chromosomal aberration test in CHL cells on the evaluation of industrial chemical genotoxicity. *Mutation Research*, Vol. 741, pp. 32-56.
- (75) Brookmire L., J.J. Chen, D.D. Levy (2013). Evaluation of the Highest Concentrations Used in the *in vitro* Chromosome Aberrations Assay. *Environmental and Molecular Mutagenesis*, Vol. 54/1, pp. 36-43.
- (76) EPA, Office of Chemical Safety and Pollution Prevention (2011). Chemical Substances of Unknown or Variable Composition, Complex Reaction Products and Biological Materials: UVCB Substances. <http://www.epa.gov/opptintr/newchems/pubs/uvcb.txt>.
- (77) Sobol, Z. *et al.* (2012). Development and validation of an *in vitro* micronucleus assay platform in TK6 cells. *Mutation Research*, Vol.746/1, pp. 29-34.
- (78) Hayashi, M., T. Sofuni, M. Jr. Ishidate (1983). An Application of Acridine Orange Fluorescent Staining to the Micronucleus Test. *Mutation Research*, Vol. 120/4, pp. 241-247.
- (79) MacGregor, J. T., C.M. Wehr, R.G. Langlois (1983). A Simple Fluorescent Staining Procedure for Micronuclei and RNA in Erythrocytes Using Hoechst 33258 and Pyronin Y. *Mutation Research*, Vol. 120/4, pp. 269-275.
- (80) Bryce, S.M. *et al.* (2011). Miniaturized flow cytometry-based CHO-K1 micronucleus assay discriminates aneugenic and clastogenic modes of action. *Environmental and Molecular Mutagenesis*, Vol. 52/4, pp. 280-286.
- (81) Nicolette, J. *et al.* (2011). *in vitro* micronucleus screening of pharmaceutical candidates by flow cytometry in Chinese hamster V79 cells. *Environmental and Molecular Mutagenesis*, Vol. 52/5, pp. 355-362.
- (82) Shi, J., R. Bezabie, A. Szkudlinska (2010). Further evaluation of a flow cytometric *in vitro* micronucleus assay in CHO-K1 cells: a reliable platform that detects micronuclei and discriminates apoptotic bodies. *Mutagenesis*, Vol. 25/1, pp. 33-40.
- (83) OECD (2014). Statistical analysis supporting the revision of the genotoxicity Test Guidelines. OECD Environment, Health and Safety Publications (EHS), Series on testing and assessment, No. 198, OECD Publishing, Paris.
- (84) Fenech, M. *et al.* (2003). HUMN project: detailed description of the scoring criteria for the cytokinesis-block micronucleus assay using isolated human lymphocyte cultures. *Mutation Research*, Vol. 534/1-2, pp. 65-75.
- (85) Elhajouji, A., M. Cunha, M. Kirsch-Volders (1998). Spindle poisons can induce polyploidy by mitotic slippage and micronucleate mononucleates in the cytokinesis-block assay. *Mutagenesis*, Vol. 13/2, pp. 193-8.
- (86) Kirsch-Volders, M. *et al.* (2011). The *in vitro* MN assay in 2011: origin and fate, biological significance, protocols, high throughput methodologies and toxicological relevance. *Archives of Toxicology*, Vol. 85/8, pp. 873-99.
- (87) Hayashi, M. *et al.* (2010). Compilation and use of genetic toxicity historical control Data. *Mutation Research/Genetic Toxicology and Environmental Mutagenesis*, Vol.723/2, pp. 87-90.
- (88) Ryan, T. P. (2000). *Statistical Methods for Quality Improvement*. 2nd ed., John Wiley and Sons, New York.
- (89) Hoffman, W.P., M.L. Garriott, C. Lee (2003). 'In vitro micronucleus test', in *Encyclopedia of Biopharmaceutical Statistics*, 2nd ed. Chow, S. (ed.), Marcel Dekker, Inc. New York, pp. 463-467.
- (90) Fleiss, J. L., B. Levin, M.C. Paik (2003). *Statistical Methods for Rates and Proportions*, 3rd ed. John Wiley & Sons, New York.
- (91) Galloway, S.M. *et al.* (1987). Chromosome aberration and sister chromatid exchanges in Chinese hamster ovary cells: Evaluation of 108 chemicals. *Environmental and Molecular Mutagenesis*, Vol. 10/suppl. 10, pp. 1-175.

▼ M7

- (92) Richardson, C. *et al.* (1989). Analysis of Data from *in vitro* Cytogenetic Assays. in *Statistical Evaluation of Mutagenicity Test Data*, Kirkland, D.J. (ed), Cambridge University Press, Cambridge, pp. 141-154.
- (93) International Conference on Harmonisation (ICH) Guidance S2 (R1) on Genotoxicity Testing and Data Interpretation for Pharmaceuticals Intended For Human Use.

▼ M7*Appendix 1*

DEFINITIONS:

Aneugen: any chemical or process that, by interacting with the components of the mitotic and meiotic cell division cycle apparatus, leads to aneuploidy in cells or organisms.

Aneuploidy: any deviation from the normal diploid (or haploid) number of chromosomes by a single chromosome or more than one, but not by entire set(s) of chromosomes (polyploidy).

Apoptosis: programmed cell death characterised by a series of steps leading to the disintegration of cells into membrane-bound particles that are then eliminated by phagocytosis or by shedding.

Cell proliferation: the increase in cell number as a result of mitotic cell division.

Centromere: the DNA region of a chromosome where both chromatids are held together and on which both kinetochores are attached side-to-side.

Chemical: a substance or a mixture.

Concentrations: refers to final concentrations of the test chemical in the culture medium.

Clastogen: any chemical or event which causes structural chromosomal aberrations in populations of cells or eukaryotic organisms.

Cytokinesis: the process of cell division immediately following mitosis to form two daughter cells, each containing a single nucleus.

Cytokinesis-Block Proliferation index (CBPI): the proportion of second-division cells in the treated population relative to the untreated control (see Appendix 2 for formula).

Cytostasis: inhibition of cell growth (see Appendix 2 for formula).

Cytotoxicity: For the assays covered in this test method performed in the presence of cytochalasin B, cytotoxicity is identified as a reduction in cytokinesis-block proliferation index (CBPI) or Replication Index (RI) of the treated cells as compared to the negative control (see paragraph 26 and Appendix 2)

For the assays covered in this test method performed in the absence of cytochalasin B, cytotoxicity is identified as a reduction in relative population doubling (RPD) or relative increase in cell count (RICC) of the treated cells as compared to the negative control (see paragraph 27 and Appendix 2).

Genotoxic: a general term encompassing all types of DNA or chromosome damage, including breaks, deletions, adducts, nucleotides modifications and linkages, rearrangements, gene mutations, chromosome aberrations, and aneuploidy. Not all types of genotoxic effects result in mutations or stable chromosome damage.

Interphase cells: cells not in the mitotic stage.

Kinetochores: a protein-containing structure that assembles at the centromere of a chromosome to which spindle fibres associate during cell division, allowing orderly movement of daughter chromosomes to the poles of the daughter cells.

▼ M7

Micronuclei: small nuclei, separate from and additional to the main nuclei of cells, produced during telophase of mitosis or meiosis by lagging chromosome fragments or whole chromosomes.

Mitosis: division of the cell nucleus usually divided into prophase, prometaphase, metaphase, anaphase and telophase.

Mitotic index: the ratio of cells in metaphase divided by the total number of cells observed in a population of cells; an indication of the degree of cell proliferation of that population.

Mutagenic: produces a heritable change of DNA base-pair sequences(s) in genes or of the structure of chromosomes (chromosome aberrations).

Non-disjunctio: failure of paired chromatids to disjoin and properly segregate to the developing daughter cells, resulting in daughter cells with abnormal numbers of chromosomes.

p53 status: p53 protein is involved in cell cycle regulation, apoptosis and DNA repair. Cells deficient in functional p53 protein, unable to arrest cell cycle or to eliminate damaged cells via apoptosis or other mechanisms (e.g. induction of DNA repair) related to p53 functions in response to DNA damage, should be theoretically more prone to gene mutations or chromosomal aberrations.

Polyploidy: numerical chromosome aberrations in cells or organisms involving entire set(s) of chromosomes, as opposed to an individual chromosome or chromosomes (aneuploidy).

Proliferation Index (PI): method for cytotoxicity measurement when cytoB is not used (see Appendix 2 for formula).

Relative Increase in Cell Count (RICC): method for cytotoxicity measurement when cytoB is not used (see Appendix 2 for formula).

Relative Population Doubling (RPD): method for cytotoxicity measurement when cytoB is not used (see Appendix 2 for formula).

Replication Index (RI): the proportion of cell division cycles completed in a treated culture, relative to the untreated control, during the exposure period and recovery (see Appendix 2 for formula).

S9 liver fraction: supernatant of liver homogenate after 9 000 g centrifugation, *i.e.* raw liver extract.

S9 mix: mix of the S9 liver fraction and cofactors necessary for metabolic enzyme activity.

Solvent control: General term to define the control cultures receiving the solvent alone used to dissolve the test chemical.

Test chemical: Any substance or mixture tested using this test method.

Untreated control: cultures that receive no treatment (*i.e.* no test chemical nor solvent) but are processed concurrently in the same way as the cultures receiving the test chemical.

▼ M7

Appendix 2

FORMULAS FOR CYTOTOXICITY ASSESSMENT

When cytoB is used, evaluation of cytotoxicity should be based on the **Cytokinesis-Block Proliferation Index (CBPI)** or **Replication Index (RI)** (17) (69). The CBPI indicates the average number of nuclei per cell, and may be used to calculate cell proliferation. The RI indicates the relative number of cell cycles per cell during the period of exposure to cytoB in treated cultures compared to control cultures and can be used to calculate the % cytostasis:

$$\% \text{ Cytostasis} = 100 - 100\{(\text{CBPI}_T - 1) \div (\text{CBPI}_C - 1)\}$$

and:

T = test chemical treatment culture

C = control culture

where:

$$\text{CBPI} = \frac{((\text{No. mononucleate cells}) + (2 \times \text{No. binucleate cells}) + (3 \times \text{No. multinucleate cells}))}{(\text{Total number of cells})}$$

Thus, a CBPI of 1 (all cells are mononucleate) is equivalent to 100 % cytostasis.

Cytostasis = 100-RI

$$\text{RI} = \frac{((\text{No. binucleate cells}) + (2 \times \text{No. multinucleate cells})) / (\text{Total number of cells})_T}{((\text{No. binucleate cells}) + (2 \times \text{No. multinucleate cells})) / (\text{Total number of cells})_C} \times 100$$

T = treated cultures

C = control cultures

Thus, an RI of 53 % means that, compared to the numbers of cells that have divided to form binucleate and multinucleate cells in the control culture, only 53 % of this number divided in the treated culture, *i.e.* 47 % cytostasis.

When cytoB is not used, evaluation of cytotoxicity based on **Relative Increase in Cell Counts (RICC)** or on **Relative Population Doubling (RPD)** is recommended (69), as both take into account the proportion of the cell population which has divided.

$$\text{RICC}(\%) = \frac{(\text{Increase in number of cells in treated cultures}(\text{final} - \text{starting}))}{(\text{Increase in numbers of cells in control cultures}(\text{final} - \text{starting}))} \times 100$$

$$\text{RPD}(\%) = \frac{(\text{No. of Population doublings in treated cultures})}{(\text{No. of population doublings in control cultures})} \times 100$$

where:

$$\text{Population Doubling} = [\log (\text{Post-treatment cell number} \div \text{Initial cell number})] \div \log 2$$

Thus, a RICC, or a RPD of 53 % indicates 47 % cytotoxicity/cytostasis.

▼ M7

By using a **Proliferation Index (PI)**, cytotoxicity may be assessed via counting the number of clones consisting of 1 cell (c1), 2 cells (c2), 3 to 4 cells (c4) and 5 to 8 cells (c8).

$$PI = \frac{(1 \times c1) + (2 \times c2) + (3 \times c4) + (4 \times c8)}{(c1 + c2 + c4 + c8)}$$

The PI has been used as a valuable and reliable cytotoxicity parameter also for cell lines cultured *in vitro* in the absence of cytoB (35) (36) (37) (38) and can be seen as a useful additional parameter.

In any case, the number of cells before treatment should be the same for treated and negative control cultures.

While RCC (*i.e.* Number of cells in treated cultures/Number of cells in control cultures) had been used as cytotoxicity parameter in the past, is no longer recommended because it can underestimate cytotoxicity.

When using automated scoring systems, for instance, flow cytometry, laser scanning cytometry or image analysis, the number of cells in the formula can be substituted by the number of nuclei.

In the negative control cultures, population doubling or replication index should be compatible with the requirement to sample cells after treatment at a time equivalent to about 1,5 - 2,0 normal cell cycle.

▼ M3**B.50. SKIN SENSITISATION: LOCAL LYMPH NODE ASSAY: DA**

INTRODUCTION

1. OECD Guidelines for the Testing of Chemicals and EU Test Methods are periodically reviewed in light of scientific progress, changing regulatory needs, and animal welfare considerations. The first Test Method (TM) (B.42) for the determination of skin sensitisation in the mouse, the Local Lymph Node Assay (LLNA; OECD Test Guideline 429) has been revised (1) The details of the validation of the LLNA and a review of the associated work have been published (2) (3) (4) (5) (6) (7) (8) (9). In the LLNA, radioisotopic thymidine or iodine is used to measure lymphocyte proliferation and therefore the assay has limited use where the acquisition, use, or disposal of radioactivity is problematic. The LLNA: DA (developed by Daicel Chemical Industries, Ltd) is a non-radioactive modification to the LLNA, which quantifies adenosine triphosphate (ATP) content via bio-luminescence as an indicator of lymphocyte proliferation. The LLNA: DA test method has been validated and reviewed and recommended by an international peer review panel as considered useful for identifying skin sensitising and non-sensitising chemicals, with certain limitations (10) (11) (12) (13). This TM is designed for assessing skin sensitisation potential of chemicals (substances and mixtures) in animals. Chapter B.6 of this Annex and OECD Test Guideline 406 utilise guinea pig tests, notably the guinea pig maximisation test and the Buehler test (14) The LLNA (Chapter B.42 of this Annex; OECD Test Guideline 429) and the two non-radioactive modifications, LLNA: DA (Chapter B.50 of this Annex; OECD Test Guideline 442 A) and LLNA: BrdU-ELISA (Chapter B.51 of this Annex; OECD Test Guideline 442 B), all provide an advantage over the guinea pig tests in B.6 and OECD Test Guideline 406 (14) in terms of reduction and refinement of animal use.
2. Similar to the LLNA, the LLNA: DA studies the induction phase of skin sensitisation and provides quantitative data suitable for dose-response assessment. Furthermore, an ability to detect skin sensitisers without the necessity for using a radiolabel for DNA eliminates the potential for occupational exposure to radioactivity and waste disposal issues. This in turn may allow for the increased use of mice to detect skin sensitisers, which could further reduce the use of guinea pigs to test for skin sensitisation potential (*i.e.* B.6; OECD Test Guideline 406) (14).

DEFINITIONS

3. Definitions used are provided in Appendix 1.

INITIAL CONSIDERATIONS AND LIMITATIONS

4. The LLNA: DA is a modified LLNA method for identifying potential skin sensitising chemicals, with specific limitations. This does not necessarily imply that in all instances the LLNA: DA should be used in place of the LLNA or guinea pig tests (*i.e.* B.6; OECD Test Guideline 406) (14), but rather that the assay is of equal merit and may be employed as an alternative in which positive and negative results generally no longer require further confirmation (10) (11). The testing laboratory should consider all available information on the test substance prior to conducting the study. Such information will include the identity and chemical structure of the test

▼ M3

substance; its physicochemical properties; the results of any other *in vitro* or *in vivo* toxicity tests on the test substance; and toxicological data on structurally related chemicals. This information should be considered in order to determine whether the LLNA: DA is appropriate for the test substance (given the incompatibility of limited types of chemicals with the LLNA: DA (see paragraph 5) and to aid in dose selection.

5. The LLNA: DA is an *in vivo* method and, as a consequence, will not eliminate the use of animals in the assessment of allergic contact sensitising activity. It has, however, the potential to reduce animal use for this purpose when compared to the guinea pig tests (B.6; OECD Test Guideline 406) (14). Moreover, the LLNA: DA offers a substantial refinement (less pain and distress) of the way in which animals are used for allergic contact sensitisation testing, since unlike the B.6 and OECD Test Guideline 406, the LLNA: DA does not require that challenge-induced dermal hypersensitivity reactions be elicited. Despite the advantages of the LLNA: DA over B.6 and OECD Test Guideline 406 (14), there are certain limitations that may necessitate the use of B.6 or OECD Test Guideline 406 (e.g. the testing of certain metals, false positive findings with certain skin irritants (such as some surfactant-type substances) (6) (1 and Chapter B.42 in this Annex), solubility of the test substance). In addition, chemical classes or substances containing functional groups shown to act as potential confounders (16) may necessitate the use of guinea pig tests (i.e. B.6; OECD Test Guideline 406 (14)). Limitations that have been identified for the LLNA (1 and Chapter B.42 in this Annex) have been recommended to apply also to the LLNA: DA (10). Additionally, the use of the LLNA: DA might not be appropriate for testing substances that affect ATP levels (e.g. substances that function as ATP inhibitors) or those that affect the accurate measurement of intracellular ATP (e.g. presence of ATP degrading enzymes, presence of extracellular ATP in the lymph node). Other than such identified limitations, the LLNA: DA should be applicable for testing any substances unless there are properties associated with these substances that may interfere with the accuracy of the LLNA: DA. In addition, consideration should be given to the possibility of borderline positive results when Stimulation Index (SI) values between 1,8 and 2,5 are obtained (see paragraphs 31-32). This is based on the validation database of 44 substances using an $SI \geq 1,8$ (see paragraph 6) for which the LLNA: DA correctly identified all 32 LLNA sensitisers, but incorrectly identified three of 12 LLNA non-sensitisers with SI values between 1,8 and 2,5 (i.e. borderline positive) (10). However, as the same dataset was used for setting the SI-values and calculating the predictive properties of the test, the stated results may be an over-estimation of the real predictive properties.

PRINCIPLE OF THE TEST METHOD

6. The basic principle underlying the LLNA: DA is that sensitisers induce proliferation of lymphocytes in the lymph nodes draining the site of test substance application. This proliferation is proportional to the dose and to the potency of the applied allergen and provides a simple means of obtaining a quantitative measurement of sensitisation. Proliferation is measured by comparing the mean proliferation in each test group to the mean proliferation in the vehicle treated control (VC) group. The ratio of the mean proliferation in each treated group to that in the concurrent VC group, termed the SI, is determined, and should be $\geq 1,8$ before further evaluation of the test substance as a potential skin sensitiser is warranted. The procedures described here are based on the use of measuring ATP content

▼ M3

by bioluminescence (known to correlate with living cell number) (17) to indicate an increased number of proliferating cells in the draining auricular lymph nodes (18) (19). The bioluminescent method utilises the luciferase enzyme to catalyse the formation of light from ATP and luciferin according to the following reaction:

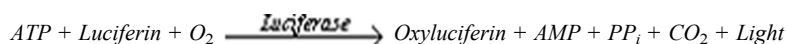

The emitted light intensity is linearly related to the ATP concentration and is measured using a luminometer. The luciferin-luciferase assay is a sensitive method for ATP quantitation used in a wide variety of applications (20).

DESCRIPTION OF THE ASSAY**Selection of animal species**

7. The mouse is the species of choice for this test. Validation studies for the LLNA: DA were conducted exclusively with the CBA/J strain, which is therefore considered the preferred strain (12) (13). Young adult female mice, which are nulliparous and non-pregnant, are used. At the start of the study, animals should be between 8-12 weeks old, and the weight variation of the animals should be minimal and not exceed 20 % of the mean weight. Alternatively, other strains and males may be used when sufficient data are generated to demonstrate that significant strain and/or gender-specific differences in the LLNA: DA response do not exist.

Housing and feeding conditions

8. Mice should be group-housed (21), unless adequate scientific rationale for housing mice individually is provided. The temperature of the experimental animal room should be 22 ± 3 °C. Although the relative humidity should be at least 30 % and preferably not exceed 70 %, other than during room cleaning, the aim should be 50-60 %. Lighting should be artificial, the sequence being 12 hours light, 12 hours dark. For feeding, conventional laboratory diets may be used with an unlimited supply of drinking water.

Preparation of animals

9. The animals are randomly selected, marked to permit individual identification (but not by any form of ear marking), and kept in their cages for at least five days prior to the start of dosing to allow for acclimatisation to the laboratory conditions. Prior to the start of treatment all animals are examined to ensure that they have no observable skin lesions.

Preparation of dosing solutions

10. Solid chemicals should be dissolved or suspended in solvents/vehicles and diluted, if appropriate, prior to application to an ear of the mice. Liquid chemicals may be applied neat or diluted prior to dosing. Insoluble chemicals, such as those generally seen in medical devices, should be subjected to an exaggerated extraction in an appropriate solvent to reveal all extractable constituents for testing prior to application to an ear of the mice. Test substances should be prepared daily unless stability data demonstrate the acceptability of storage.

▼ M3**Reliability check**

11. Positive control chemicals (PC) are used to demonstrate appropriate performance of the assay by responding with adequate and reproducible sensitivity to a sensitising test substance for which the magnitude of the response is well characterised. Inclusion of a concurrent PC is recommended because it demonstrates competency of the laboratory to successfully conduct each assay and allows for an assessment of intra- and inter-laboratory reproducibility and comparability. Some regulatory authorities also require a PC for each study and therefore users are encouraged to consult the relevant authorities prior to conducting the LLNA: DA. Accordingly, the routine use of a concurrent PC is encouraged to avoid the need for additional animal testing to meet such requirements that might arise from the use of a periodic PC (see paragraph 12). The PC should produce a positive LLNA: DA response at an exposure level expected to give an increase in the SI $\geq 1,8$ over the negative control (NC) group. The PC dose should be chosen such that it does not cause excessive skin irritation or systemic toxicity and the induction is reproducible but not excessive (e.g. SI > 10 would be considered excessive). Preferred PC are 25 % hexyl cinnamic aldehyde (Chemical Abstracts Service (CAS) number 101-86-0) and 25 % eugenol (CAS number 97-53-0) in acetone: olive oil (4:1, v/v). There may be circumstances in which, given adequate justification, other PC, meeting the above criteria, may be used.

12. While inclusion of a concurrent PC group is recommended, there may be situations in which periodic testing (i.e. at intervals ≤ 6 months) of the PC may be adequate for laboratories that conduct the LLNA: DA regularly (i.e. conduct the LLNA: DA at a frequency of no less than once per month) and have an established historical PC database that demonstrates the laboratory's ability to obtain reproducible and accurate results with PCs. Adequate proficiency with the LLNA: DA can be successfully demonstrated by generating consistent positive results with the PC in at least 10 independent tests conducted within a reasonable period of time (i.e. less than one year).

13. A concurrent PC group should always be included when there is a procedural change to the LLNA: DA (e.g. change in trained personnel, change in test method materials and/or reagents, change in test method equipment, change in source of test animals), and such changes should be documented in laboratory reports. Consideration should be given to the impact of these changes on the adequacy of the previously established historical database in determining the necessity for establishing a new historical database to document consistency in the PC results.

14. Investigators should be aware that the decision to conduct a PC study on a periodic basis instead of concurrently has ramifications on the adequacy and acceptability of negative study results generated without a concurrent PC during the interval between each periodic PC study. For example, if a false negative result is obtained in the periodic PC study, negative test substance results obtained in the interval between the last acceptable periodic PC study and the unacceptable periodic PC study may be questioned. Implications of these outcomes should be carefully considered when determining whether to include concurrent PCs or to only conduct periodic PCs. Consideration should also be given to using fewer animals in the concurrent PC group when this is scientifically justified and if the laboratory demonstrates, based on laboratory-specific historical data, that fewer mice can be used (22).

▼ M3

15. Although the PC should be tested in the vehicle that is known to elicit a consistent response (e.g. acetone: olive oil; 4:1, v/v), there may be certain regulatory situations in which testing in a non-standard vehicle (clinically/chemically relevant formulation) will also be necessary (23). If the concurrent PC is tested in a different vehicle than the test substance, then a separate VC for the concurrent PC should be included.

16. In instances where substances of a specific chemical class or range of responses are being evaluated, benchmark substances may also be useful to demonstrate that the test method is functioning properly for detecting the skin sensitisation potential of these types of substances. Appropriate benchmark substances should have the following properties:
 - structural and functional similarity to the class of the test substance being tested;

 - known physical chemical characteristics;

 - supporting data from the LLNA: DA;

 - supporting data from other animal models and/or from humans.

TEST PROCEDURE**Number of animals and dose levels**

17. A minimum of four animals is used per dose group, with a minimum of three concentrations of the test substance, plus a concurrent NC group treated only with the vehicle for the test substance, and a PC (concurrent or recent, based on laboratory policy in considering paragraphs 11-15). Testing multiple doses of the PC should be considered, especially when testing the PC on an intermittent basis. Except for absence of treatment with the test substance, animals in the control groups should be handled and treated in a manner identical to that of animals in the treatment groups.

18. Dose and vehicle selection should be based on the recommendations given in references (2) and (24). Consecutive doses are normally selected from an appropriate concentration series such as 100 %, 50 %, 25 %, 10 %, 5 %, 2,5 %, 1 %, 0,5 %, etc. Adequate scientific rationale should accompany the selection of the concentration series used. All existing toxicological information (e.g. acute toxicity and dermal irritation) and structural and physicochemical information on the test substance of interest (and/or structurally related substances) should be considered, where available, in selecting the three consecutive concentrations so that the highest concentration maximises exposure while avoiding systemic toxicity and/or excessive local skin irritation (24) (25). In the absence of such information, an initial pre-screen test may be necessary (see paragraphs 21-24).

19. The vehicle should not interfere with or bias the test result and should be selected on the basis of maximising the solubility in order to obtain the highest concentration achievable while producing a solution/suspension suitable for application of the test substance. Recommended vehicles are acetone: olive oil (4:1 v/v), N,N-dimethylformamide, methyl ethyl ketone, propylene glycol, and dimethyl sulphoxide (6) but others may be used if sufficient scientific rationale is provided. In certain situations it may be necessary to use a clinically relevant solvent or the commercial formulation in which the test substance is marketed as an additional control. Particular care should be taken to ensure that hydrophilic substances are incorporated into a vehicle system, which wets the skin and does not immediately run off, by incorporation of appropriate solubilisers (e.g. 1 % Pluronic® L92). Thus, wholly aqueous vehicles are to be avoided.

▼ **M3**

20. The processing of lymph nodes from individual mice allows for the assessment of inter-animal variability and a statistical comparison of the difference between test substance and VC group measurements (see paragraph 33). In addition, evaluating the possibility of reducing the number of mice in the PC group is only feasible when individual animal data are collected (22). Further, some regulatory authorities require the collection of individual animal data. Regular collection of individual animal data provides an animal welfare advantage by avoiding duplicate testing that would be necessary if the test substance results originally collected in one manner (e.g. via pooled animal data) were to be considered later by regulatory authorities with other requirements (e.g. individual animal data).

Pre-screen test

21. In the absence of information to determine the highest dose to be tested (see paragraph 18), a pre-screen test should be performed in order to define the appropriate dose level to test in the LLNA: DA. The purpose of the pre-screen test is to provide guidance for selecting the maximum dose level to use in the main LLNA: DA study, where information on the concentration that induces systemic toxicity (see paragraph 24) and/or excessive local skin irritation (see paragraph 23) is not available. The maximum dose level tested should be 100 % of the test substance for liquids or the maximum possible concentration for solids or suspensions.
22. The pre-screen test is conducted under conditions identical to the main LLNA: DA study, except there is no assessment of lymph node proliferation and fewer animals per dose group can be used. One or two animals per dose group are suggested. All mice will be observed daily for any clinical signs of systemic toxicity or local irritation at the application site. Body weights are recorded pre-test and prior to termination (Day 8). Both ears of each mouse are observed for erythema and scored using Table 1 (25). Ear thickness measurements are taken using a thickness gauge (e.g. digital micrometer or Peacock Dial thickness gauge) on Day 1 (pre-dose), Day 3 (approximately 48 hours after the first dose), Day 7 (24 hours prior to termination) and Day 8. Additionally on Day 8, ear thickness could be determined by ear punch weight determinations, which should be performed after the animals are humanely killed. Excessive local irritation is indicated by an erythema score ≥ 3 and/or ear thickness of ≥ 25 % on any day of measurement (26) (27). The highest dose selected for the main LLNA: DA study will be the next lower dose in the pre-screen concentration series (see paragraph 18) that does not induce systemic toxicity and/or excessive local skin irritation

Table 1

Erythema Scores

Observation	Score
No erythema	0
Very slight erythema (barely perceptible)	1
Well-defined erythema	2

▼ **M3**

Observation	Score
Moderate to severe erythema	3
Severe erythema (beet redness) to eschar formation preventing grading of erythema	4

23. In addition to a 25 % increase in ear thickness (26) (27), a statistically significant increase in ear thickness in the treated mice compared to control mice has also been used to identify irritants in the LLNA (28) (29) (30) (31) (32) (33) (34). However, while statistically significant increases can occur when ear thickness is less than 25 % they have not been associated specifically with excessive irritation (30) (31) (32) (33) (34).
24. The following clinical observations may indicate systemic toxicity (35) when used as part of an integrated assessment and therefore may indicate the maximum dose level to use in the main LLNA: DA: changes in nervous system function (*e.g.* pilo-erection, ataxia, tremors, and convulsions); changes in behaviour (*e.g.* aggressiveness, change in grooming activity, marked change in activity level); changes in respiratory patterns (*i.e.* changes in frequency and intensity of breathing such as dyspnea, gasping, and rales), and changes in food and water consumption. In addition, signs of lethargy and/or unresponsiveness and any clinical signs of more than slight or momentary pain and distress, or a > 5 % reduction in body weight from Day 1 to Day 8 and mortality, should be considered in the evaluation. Moribund animals or animals showing signs of severe pain and distress should be humanely killed (36).

Main study experimental schedule

25. The experimental schedule of the assay is as follows:
- *Day 1:* Individually identify and record the weight of each animal and any clinical observation. Apply 1 % sodium lauryl sulfate (SLS) aqueous solution to the dorsum of each ear by using a brush dipped in the SLS solution to cover the entire dorsum of each ear with four to five strokes. One hour after the SLS treatment, apply 25 µL of the appropriate dilution of the test substance, the vehicle alone, or the PC (concurrent or recent, based on laboratory policy in considering paragraphs 11-15), to the dorsum of each ear.
 - *Days 2, 3 and 7:* Repeat the 1 % SLS aqueous solution pre-treatment and test substance application procedure carried out on Day 1.
 - *Days 4, 5, and 6:* No treatment.
 - *Day 8:* Record the weight of each animal and any clinical observation. Approximately 24 to 30 hours after the start of application on Day 7, humanely kill the animals. Excise the draining auricular lymph nodes from each mouse ear and process separately in phosphate buffered saline (PBS) for each animal. Details and diagrams of the lymph node identification and dissection can be found in reference (22). To further monitor the local skin response in the main study, additional parameters such as scoring of ear erythema or ear thickness measurements (obtained either by using a thickness gauge, or ear punch weight determinations at necropsy) may be included in the study protocol.

▼ M3**Preparation of cell suspensions**

26. From each mouse, a single-cell suspension of lymph node cells (LNC) excised bilaterally is prepared by sandwiching the lymph nodes between two glass slides and applying light pressure to crush the nodes. After confirming that the tissue has spread out thinly pull the two slides apart. Suspend the tissue on both slides in PBS by holding each slide at an angle over the Petri dish and rinsing with PBS while concurrently scraping the tissue off of the slide with a cell scraper. Further, the lymph nodes in NC animals are small, so careful operation is important to avoid any artificial effects on SI values. A total volume of 1 mL PBS should be used for rinsing both slides. The LNC suspension in the Petri dish should be homogenised lightly with the cell scraper. A 20 µL aliquot of the LNC suspension is then collected with a micropipette, taking care not to take up the membrane that is visible to the eye, and subsequently mixed with 1,98 mL of PBS to yield a 2 mL sample. A second 2 mL sample is then prepared using the same procedure so that two samples are prepared for each animal.

Determination of cellular proliferation (measurement of ATP content of lymphocytes)

27. Increases in ATP content in the lymph nodes are measured by the luciferin/luciferase method using an ATP measurement kit, which measures bioluminescence in Relative Luminescence Units (RLU). The assay time from time of animal sacrifice to measurement of ATP content for each individual animal should be kept uniform, within approximately 30 minutes, because the ATP content is considered to gradually decrease with time after animal sacrifice (12). Thus, the series of procedures from excision of auricular lymph nodes to ATP measurement should be completed within 20 minutes by the pre-determined time schedule that is the same for each animal. ATP luminescence should be measured in each 2 mL sample so that a total of two ATP measurements are collected for each animal. The mean ATP luminescence is then determined and used in subsequent calculations (see paragraph 30).

OBSERVATIONS**Clinical observations**

28. Each mouse should be carefully observed at least once daily for any clinical signs, either of local irritation at the application site or of systemic toxicity. All observations are systematically recorded with records being maintained for each mouse. Monitoring plans should include criteria to promptly identify those mice exhibiting systemic toxicity, excessive local skin irritation, or corrosion of skin for euthanasia (36).

Body weights

29. As stated in paragraph 25, individual animal body weights should be measured at the start of the test and at the scheduled humane kill.

CALCULATION OF RESULTS

30. Results for each treatment group are expressed as the mean SI. The SI is derived by dividing the mean RLU/mouse within each test substance group and the PC group by the mean RLU/mouse for the solvent/VC group. The average SI for the VCs is then one.

▼ M3

31. The decision process regards a result as positive when $SI \geq 1,8$ (10). However, the strength of the dose-response relationship, the statistical significance and the consistency of the solvent/vehicle and PC responses may also be used when determining whether a borderline result (*i.e.* SI value between 1,8 and 2,5) is declared positive (2) (3) (37).
32. For a borderline positive response between an SI of 1,8 and 2,5, users may want to consider additional information such as dose-response relationship, evidence of systemic toxicity or excessive irritation, and where appropriate, statistical significance together with SI values to confirm that such results are positives (10). Consideration should also be given to various properties of the test substance, including whether it has a structural relationship to known skin sensitisers, whether it causes excessive skin irritation in the mouse, and the nature of the dose-response relationship observed. These and other considerations are discussed in detail elsewhere (4).
33. Collecting data at the level of the individual mouse will enable a statistical analysis for presence and degree of dose-response relationship in the data. Any statistical assessment could include an evaluation of the dose-response relationship as well as suitably adjusted comparisons of test groups (*e.g.* pair-wise dosed group versus concurrent solvent/vehicle control comparisons). Statistical analyses may include, *e.g.* linear regression or William's test to assess dose-response trends, and Dunnett's test for pair-wise comparisons. In choosing an appropriate method of statistical analysis, the investigator should maintain an awareness of possible inequalities of variances and other related problems that may necessitate a data transformation or a non-parametric statistical analysis. In any case, the investigator may need to carry out SI calculations and statistical analyses with and without certain data points (sometimes called 'outliers').

DATA AND REPORTING**Data**

34. Data should be summarised in tabular form showing the individual animal RLU values, the group mean RLU/animal, its associated error term (*e.g.* SD, SEM), and the mean SI for each dose group compared against the concurrent solvent/vehicle control group.

Test report

35. The test report should contain the following information:

Test and control chemicals:

- identification data (*e.g.* CAS number and EC number, if available; source; purity; known impurities; lot number);
- physical nature and physicochemical properties (*e.g.* volatility, stability, solubility);
- if mixture, composition and relative percentages of components;

Solvent/vehicle:

- identification data (purity; concentration, where appropriate; volume used);
- justification for choice of vehicle;

▼ M3

Test animals:

- source of CBA mice;
- microbiological status of the animals, when known;
- number and age of animals;
- source of animals, housing conditions, diet, etc.;

Test conditions:

- the source, lot number and manufacturer's quality assurance/quality control data for the ATP kit;
- details of test substance preparation and application;
- justification for dose selection (including results from pre-screen test, if conducted);
- vehicle and test substance concentrations used, and total amount of test substance applied;
- details of food and water quality (including diet type/source, water source);
- details of treatment and sampling schedules;
- methods for measurement of toxicity;
- criteria for considering studies as positive or negative;
- details of any protocol deviations and an explanation on how the deviation affects the study design and results;

Reliability check:

- a summary of results of latest reliability check, including information on test substance, concentration and vehicle used;
- concurrent and/or historical PC and concurrent negative (solvent/vehicle) control data for testing laboratory;
- if a concurrent PC was not included, the date and laboratory report for the most recent periodic PC and a report detailing the historical PC data for the laboratory justifying the basis for not conducting a concurrent PC;

Results:

- individual weights of mice at start of dosing and at scheduled kill; as well as mean and associated error term (*e.g.* SD, SEM) for each treatment group;
- time course of onset and signs of toxicity, including dermal irritation at site of administration, if any, for each animal;
- time of animal termination and time of ATP measurement for each animal;
- a table of individual mouse RLU values and SI values for each dose treatment group;
- mean and associated error term (*e.g.* SD, SEM) for RLU/mouse for each treatment group and the results of outlier analysis for each treatment group;

▼ **M3**

- calculated SI and an appropriate measure of variability that takes into account the inter-animal variability in both the test substance and control groups;
- dose response relationship;
- statistical analyses, where appropriate;

Discussion of results:

- a brief commentary on the results, the dose-response analysis, and statistical analyses, where appropriate, with a conclusion as to whether the test substance should be considered a skin sensitiser.

LITERATURE

- (1) OECD (2010), *Skin Sensitisation: Local Lymph Node Assay*, Test Guideline No 429, Guidelines for the Testing of Chemicals, OECD, Paris. Available at: [<http://www.oecd.org/env/testguidelines>]
- (2) Chamberlain, M. and Basketter, D.A. (1996), The local lymph node assay: status of validation. *Food Chem, Toxicol.*, 34, 999-1002.
- (3) Basketter, D.A., Gerberick, G.F., Kimber, I. and Loveless, S.E. (1996), The local lymph node assay: A viable alternative to currently accepted skin sensitisation tests. *Food Chem, Toxicol.*, 34, 985-997.
- (4) Basketter, D.A., Gerberick, G.F. and Kimber, I. (1998), Strategies for identifying false positive responses in predictive sensitisation tests. *Food Chem. Toxicol.*, 36, 327-333.
- (5) Van Och, F.M.M., Slob, W., De Jong, W.H., Vandebriel, R.J. and Van Loveren, H. (2000), A quantitative method for assessing the sensitising potency of low molecular weight chemicals using a local lymph node assay: employment of a regression method that includes determination of uncertainty margins. *Toxicol.*, 146, 49-59.
- (6) ICCVAM (1999), The murine local lymph node Assay: A test method for assessing the allergic contact dermatitis potential of chemicals/compounds: The results of an independent peer review evaluation coordinated by the Interagency Coordinating Committee on the Validation of Alternative Methods (ICCVAM) and the National Toxicology Program Center for the Evaluation of Alternative Toxicological Methods (NICETAM). NIH Publication No: 99-4494. Research Triangle Park, N.C. Available at: [http://iccvam.niehs.nih.gov/docs/immunotox_docs/llna/llnarep.pdf]
- (7) Dean, J.H., Twerdok, L.E., Tice, R.R., Sailstad, D.M., Hattan, D.G., Stokes, W.S. (2001), ICCVAM evaluation of the murine local lymph node assay: II. Conclusions and recommendations of an independent scientific peer review panel. *Reg. Toxicol. Pharmacol.* 34, 258-273.
- (8) Haneke, K.E., Tice, R.R., Carson, B.L., Margolin, B.H., Stokes, W.S. (2001), ICCVAM evaluation of the murine local lymph node assay: III. Data analyses completed by the national toxicology program interagency center for the evaluation of alternative toxicological methods. *Reg. Toxicol. Pharmacol.* 34, 274-286.
- (9) Sailstad, D.M., Hattan, D., Hill, R.N., Stokes, W.S. (2001), ICCVAM evaluation of the murine local lymph node assay: I. The ICCVAM review process. *Reg. Toxicol. Pharmacol.* 34, 249-257.
- (10) ICCVAM (2010), ICCVAM Test Method Evaluation Report. Nonradioactive local lymph node assay: modified by Daicel Chemical Industries, Ltd, based on ATP content test method protocol (LLNA: DA). NIH Publication No 10-7551A/B. Research Triangle Park, NC: National Institute of Environmental Health Sciences. Available at: [<http://iccvam.niehs.nih.gov/methods/immunotox/llna-DA/TMER.htm>]

▼ M3

- (11) ICCVAM (2009), Independent Scientific Peer Review Panel Report: Updated validation status of new versions and applications of the murine local lymph node assay: a test method for assessing the allergic contact dermatitis potential of chemicals and products. Research Triangle Park, NC: National Institute of Environmental Health Sciences. Available at: [http://iccvam.niehs.nih.gov/docs/immunotox_docs/LLNAPRPRpt2009.pdf].
- (12) Idehara, K., Yamagishi, G., Yamashita, K. and Ito, M. (2008), Characterization and evaluation of a modified local lymph node assay using ATP content as a non-radio isotopic endpoint. *J. Pharmacol. Toxicol. Meth.*, 58, 1-10.
- (13) Omori, T., Idehara, K., Kojima, H., Sozu, T., Arima, K., Goto, H., Hanada, T., Ikarashi, Y., Inoda, T., Kanazawa, Y., Kosaka, T., Maki, E., Morimoto, T., Shinoda, S., Shinoda, N., Takeyoshi, M., Tanaka, M., Uratani, M., Usami, M., Yamanaka, A., Yoneda, T., Yoshimura, I. and Yuasa, A. (2008), Interlaboratory validation of the modified murine local lymph node assay based on adenosine triphosphate measurement. *J. Pharmacol. Toxicol. Meth.*, 58, 11-26.
- (14) OECD (1992), *Skin Sensitisation*, Test Guideline No 406, Guidelines for Testing of Chemicals, OECD, Paris. Available at: [<http://www.oecd.org/env/testguidelines>]
- (15) Kreiling, R., Hollnagel, H.M., Hareng, L., Eigler, L., Lee, M.S., Griem, P., Dreesen, B., Kleber, M., Albrecht, A., Garcia, C. and Wendel, A. (2008), Comparison of the skin sensitising potential of unsaturated compounds as assessed by the murine local lymph node assay (LLNA) and the guinea pig maximization test (GPMT). *Food Chem. Toxicol.*, 46, 1896-1904.
- (16) Basketter, D., Ball, N., Cagen, S., Carrillo, J.C., Certa, H., Eigler, D., Garcia, C., Esch, H., Graham, C., Haux, C., Kreiling, R. and Mehling, A. (2009), Application of a weight of evidence approach to assessing discordant sensitisation datasets: implications for REACH. *Reg. Toxicol. Pharmacol.*, 55, 90-96.
- (17) Crouch, S.P., Kozlowski, R., Slater, K.J. and Fletcher J. (1993), The use of ATP bioluminescence as a measure of cell proliferation and cytotoxicity. *J. Immunol. Meth.*, 160, 81-88.
- (18) Ishizaka, A., Tono-oka, T. and Matsumoto, S. (1984), Evaluation of the proliferative response of lymphocytes by measurement of intracellular ATP. *J. Immunol. Meth.*, 72, 127-132.
- (19) Dexter, S.J., Cámara, M., Davies, M. and Shakesheff, K.M. (2003), Development of a bioluminescent ATP assay to quantify mammalian and bacterial cell number from a mixed population. *Biomat.*, 24, 27-34.
- (20) Lundin A. (2000), Use of firefly luciferase in ATP-related assays of biomass, enzymes, and metabolites. *Meth. Enzymol.*, 305, 346-370.
- (21) ILAR (1996), Institute of Laboratory Animal Research (ILAR) Guide for the Care and Use of Laboratory Animals. 7th ed. Washington, DC: National Academies Press.
- (22) ICCVAM (2009), Recommended Performance Standards: Murine Local Lymph Node Assay, NIH Publication Number 09-7357, Research Triangle Park, NC: National Institute of Environmental Health Science. Available at: [http://iccvam.niehs.nih.gov/docs/immunotox_docs/llna-ps/LLNAPerfStds.pdf]
- (23) McGarry, H.F. (2007), The murine local lymph node assay: regulatory and potency considerations under REACH. *Toxicol.*, 238, 71-89.
- (24) Kimber, I., Dearman, R.J., Scholes E.W. and Basketter, D.A. (1994), The local lymph node assay: developments and applications. *Toxicol.*, 93, 13-31.
- (25) OECD (2002), *Acute Dermal Irritation/Corrosion*, Test Guideline No 404, Guidelines for Testing of Chemicals, OECD, Paris. Available at: [<http://www.oecd.org/env/testguidelines>]

▼ **M3**

- (26) Reeder, M.K., Broomhead, Y.L., DiDonato, L. and DeGeorge, G.L. (2007), Use of an enhanced local lymph node assay to correctly classify irritants and false positive substances. *Toxicologist*, 96, 235.
- (27) ICCVAM (2009), Nonradioactive Murine Local Lymph Node Assay: Flow Cytometry Test Method Protocol (LLNA: BrdU-FC) Revised Draft Background Review Document. Research Triangle Park, NC: National Institute of Environmental Health Sciences. Available at: [<http://iccvam.niehs.nih.gov/methods/immunotox/fcLLNA/BRDcomplete.pdf>].
- (28) Hayes, B.B., Gerber, P.C., Griffey, S.S. and Meade, B.J. (1998), Contact hypersensitivity to dicyclohexylcarbodiimide and diisopropylcarbodiimide in female B6C3F1 mice. *Drug. Chem. Toxicol.*, 21, 195-206.
- (29) Homey, B., von Schilling, C., Blumel, J., Schuppe, H.C., Ruzicka, T., Ahr, H.J., Lehmann, P. and Vohr, V.W. (1998), An integrated model for the differentiation of chemical-induced allergic and irritant skin reactions. *Toxicol. Appl. Pharmacol.*, 153, 83-94.
- (30) Woolhiser, M.R., Hayes, B.B. and Meade, B.J. (1998), A combined murine local lymph node and irritancy assay to predict sensitisation and irritancy potential of chemicals. *Toxicol. Meth.*, 8, 245-256.
- (31) Hayes, B.B. and Meade, B.J. (1999), Contact sensitivity to selected acrylate compounds in B6C3F1 mice: relative potency, cross reactivity, and comparison of test methods. *Drug Chem. Toxicol.*, 22, 491-506.
- (32) Ehling, G., Hecht, M., Heusener, A., Huesler, J., Gamer, A.O., van Loveren, H., Maurer, T., Riecke, K., Ullmann, L., Ulrich, P., Vandebriel, R. and Vohr, H.W. (2005), A European inter-laboratory validation of alternative endpoints of the murine local lymph node assay: first round. *Toxicol.*, 212, 60-68.
- (33) Vohr, H.W. and Ahr, H.J. (2005), The local lymph node assay being too sensitive? *Arch. Toxicol.*, 79, 721-728.
- (34) Patterson, R.M., Noga, E. and Germolec, D. (2007), Lack of evidence for contact sensitisation by Pfiesteria extract. *Environ. Health Perspect.*, 115, 1023-1028.
- (35) ICCVAM (2009), Report on the ICCVAM-NICEATM/ECVAM/JaCVAM Scientific Workshop on Acute Chemical Safety Testing: Advancing *In Vitro* Approaches and Humane Endpoints for Systemic Toxicity Evaluations. Research Triangle Park, NC: National Institute of Environmental Health Sciences. Available at: [http://iccvam.niehs.nih.gov/methods/acutetox/Tox_workshop.htm]
- (36) OECD (2000), *Guidance Document on the Recognition, Assessment and Use of Clinical Signs as Humane Endpoints for Experimental Animals Used in Safety Evaluation*, Environmental Health and Safety Monograph Series on Testing and Assessment No 19, ENV/JM/MONO(2000)7, OECD, Paris. Available at: [<http://www.oecd.org/env/testguidelines>]
- (37) Kimber, I., Hilton, J., Dearman, R.J., Gerberick, G.F., Ryan, C.A., Basketter, D.A., Lea, L., House, R.V., Ladies, G.S., Loveless, S.E. and Hastings, K.L. (1998), Assessment of the skin sensitisation potential of topical medicaments using the local lymph node assay: An interlaboratory exercise. *J. Toxicol. Environ. Health*, 53 563-79.
- (38) OECD (2005), *Guidance Document on the Validation and International Acceptance of New or Updated Test Methods for Hazard Assessment*, Environment, Health and Safety Monograph Series on Testing and Assessment No 34, ENV/JM/MONO (2005)14, OECD, Paris. Available at: [<http://www.oecd.org/env/testguidelines>]

▼ **M3***Appendix 1*

DEFINITIONS

Accuracy: The closeness of agreement between test method results and accepted reference values. It is a measure of test method performance and one aspect of relevance. The term is often used interchangeably with 'concordance' to mean the proportion of correct outcomes of a test method (38).

Benchmark substance: A sensitising or non-sensitising substance used as a standard for comparison to a test substance. A benchmark substance should have the following properties; (i) a consistent and reliable source(s); (ii) structural and functional similarity to the class of substances being tested; (iii) known physicochemical characteristics; (iv) supporting data on known effects, and (v) known potency in the range of the desired response.

False negative: A substance incorrectly identified as negative or non-active by a test method, when in fact it is positive or active.

False positive: A substance incorrectly identified as positive or active by a test, when in fact it is negative or non-active.

Hazard: The potential for an adverse health or ecological effect. The adverse effect is manifested only if there is an exposure of sufficient level.

Inter-laboratory reproducibility: A measure of the extent to which different qualified laboratories, using the same protocol and testing the same test substances, can produce qualitatively and quantitatively similar results. Inter-laboratory reproducibility is determined during the pre-validation and validation processes, and indicates the extent to which a test can be successfully transferred between laboratories, also referred to as between-laboratory reproducibility (38).

Intra-laboratory reproducibility: A determination of the extent that qualified people within the same laboratory can successfully replicate results using a specific protocol at different times. Also referred to as within-laboratory reproducibility (38).

Outlier: An outlier is an observation that is markedly different from other values in a random sample from a population.

Quality assurance: A management process by which adherence to laboratory testing standards, requirements, and record keeping procedures, and the accuracy of data transfer, are assessed by individuals who are independent from those performing the testing.

Reliability: Measures of the extent that a test method can be performed reproducibly within and between laboratories over time, when performed using the same protocol. It is assessed by calculating intra- and inter-laboratory reproducibility (38).

Skin sensitisation: An immunological process that results when a susceptible individual is exposed topically to an inducing chemical allergen, which provokes a cutaneous immune response that can lead to the development of contact sensitisation.

Stimulation Index (SI): A value calculated to assess the skin sensitisation potential of a test substance that is the ratio of the proliferation in treated groups to that in the concurrent vehicle control group.

Test substance (also referred to as test chemical): Any substance or mixture tested using this TM.

▼ M3**B.51. SKIN SENSITISATION: LOCAL LYMPH NODE ASSAY:
BrdU-ELISA**

INTRODUCTION

1. OECD Guidelines for the Testing of Chemicals and EU Test Methods are periodically reviewed in light of scientific progress, changing regulatory needs, and animal welfare considerations. The first Test Method (TM) (B.42) for the determination of skin sensitisation in the mouse, the Local Lymph Node Assay (LLNA; OECD Test Guideline 429) has been revised (1 and Chapter B.42 in this Annex). The details of the validation of the LLNA and a review of the associated work have been published (2) (3) (4) (5) (6) (7) (8) (9). In the LLNA, radioisotopic thymidine or iodine is used to measure lymphocyte proliferation and therefore the assay has limited use where the acquisition, use, or disposal of radioactivity is problematic. The LLNA: BrdU-ELISA (Enzyme-Linked Immunosorbent Assay) is a non-radioactive modification to the LLNA TM, which utilises non-radiolabelled 5-bromo-2-deoxyuridine (BrdU) (Chemical Abstracts Service (CAS) No 59-14-3) in an ELISA-based test system to measure lymphocyte proliferation. The LLNA: BrdU-ELISA has been validated and reviewed and recommended by an international independent scientific peer review panel as considered useful for identifying skin sensitising and non-sensitising chemicals with certain limitations (10) (11) (12). This TM is designed for assessing skin sensitisation potential of chemicals (substances and mixtures) in animals. Chapter B.6 of this Annex and OECD Test Guideline 406 utilise guinea pig tests, notably the guinea pig maximisation test and the Buehler test (13). The LLNA (Chapter B.42 of this Annex; OECD Test Guideline 429) and the two non-radioactive modifications, LLNA: BrdU-ELISA (Chapter B.51 of this Annex; OECD Test Guideline 442 B) and LLNA: DA (Chapter B.50 of this Annex; OECD Test Guideline 442 A), all provide an advantage over the guinea pig tests in B.6 and OECD Test Guideline 406 (13) in terms of reduction and refinement of animal use.
2. Similar to the LLNA, the LLNA: BrdU-ELISA studies the induction phase of skin sensitisation and provides quantitative data suitable for dose-response assessment. Furthermore, an ability to detect skin sensitisers without the necessity for using a radiolabel for DNA eliminates the potential for occupational exposure to radioactivity and waste disposal issues. This in turn may allow for the increased use of mice to detect skin sensitisers, which could further reduce the use of guinea pigs to test for skin sensitisation potential (*i.e.* B.6; OECD Test Guideline 406) (13).

DEFINITIONS

3. Definitions used are provided in Appendix 1.

INITIAL CONSIDERATIONS AND LIMITATIONS

4. The LLNA: BrdU-ELISA is a modified LLNA method for identifying potential skin sensitising chemicals, with specific limitations. This does not necessarily imply that in all instances the LLNA: BrdU-ELISA should be used in place of the LLNA or guinea pig tests (*i.e.* B.6; OECD Test Guideline 406) (13), but rather that the assay is of equal merit and may be employed as an alternative in which positive and negative results generally no longer require further confirmation (10) (11). The testing laboratory should consider all available information on the test substance prior to conducting the study. Such information will include the identity and chemical structure of the test substance; its physicochemical properties; the results of any other *in vitro* or *in vivo* toxicity

▼ M3

tests on the test substance; and toxicological data on structurally related chemicals. This information should be considered in order to determine whether the LLNA: BrdU-ELISA is appropriate for the test substance (given the incompatibility of limited types of chemicals with the LLNA: BrdU-ELISA (see paragraph 5)) and to aid in dose selection.

5. The LLNA: BrdU-ELISA is an *in vivo* method and, as a consequence, will not eliminate the use of animals in the assessment of allergic contact sensitising activity. It has, however, the potential to reduce the animal use for this purpose when compared to the guinea pig tests (B.6; OECD Test Guideline 406) (13). Moreover, the LLNA: BrdU-ELISA offers a substantial refinement of the way in which animals are used for allergic contact sensitisation testing, since unlike the B.6 and OECD Test Guideline 406, the LLNA: BrdU-ELISA does not require that challenge-induced dermal hypersensitivity reactions be elicited. Furthermore, the LLNA: BrdU-ELISA does not require the use of an adjuvant, as is the case for the guinea pig maximisation test (Chapter B.6 of this Annex, 13). Thus, the LLNA: BrdU-ELISA reduces animal distress. Despite the advantages of the LLNA: BrdU-ELISA over B.6 and OECD Test Guideline 406 (13), there are certain limitations that may necessitate the use of B.6 or OECD Test Guideline 406 (e.g. the testing of certain metals, false positive findings with certain skin irritants (such as some surfactant-type substances) (6) (1 and Chapter B.42 in this Annex), solubility of the test substance). In addition, chemical classes or substances containing functional groups shown to act as potential confounders (15) may necessitate the use of guinea pig tests (*i.e.* B.6; OECD Test Guideline 406 (13)). Limitations that have been identified for the LLNA (1 and Chapter B.42 in this Annex) have been recommended to apply also to the LLNA: BrdU-ELISA (10). Other than such identified limitations, the LLNA: BrdU-ELISA should be applicable for testing any chemicals unless there are properties associated with these chemicals that may interfere with the accuracy of the LLNA: BrdU-ELISA. In addition, consideration should be given to the possibility of borderline positive results when Stimulation Index (SI) values between 1,6 and 1,9 are obtained (see paragraphs 31-32). This is based on the validation database of 43 substances using an $SI \geq 1,6$ (see paragraph 6) for which the LLNA: BrdU-ELISA correctly identified all 32 LLNA sensitisers, but incorrectly identified two of 11 LLNA non-sensitisers with SI values between 1,6 and 1,9 (*i.e.* borderline positive) (10). However, as the same dataset was used for setting the SI-values and calculating the predictive properties of the test, the stated results may be an over-estimation of the real predictive properties.

PRINCIPLE OF THE TEST METHOD

6. The basic principle underlying the LLNA: BrdU-ELISA is that sensitisers induce proliferation of lymphocytes in the lymph nodes draining the site of test substance application. This proliferation is proportional to the dose and to the potency of the applied allergen and provides a simple means of obtaining a quantitative measurement of sensitisation. Proliferation is measured by comparing the mean proliferation in each test group to the mean proliferation in the vehicle treated control group (VC). The ratio of the mean proliferation in each treated group to that in the concurrent VC group, termed the SI, is determined, and should be $\geq 1,6$ before further evaluation of the test substance as a potential skin sensitiser is warranted.

▼ M3

The procedures described here are based on the use of measuring BrdU content to indicate an increased number of proliferating cells in the draining auricular lymph nodes. BrdU is an analogue of thymidine and is similarly incorporated into the DNA of proliferating cells. The incorporation of BrdU is measured by ELISA, which utilises an antibody specific for BrdU that is also labelled with peroxidase. When the substrate is added, the peroxidase reacts with the substrate to produce a coloured product that is quantified at a specific absorbance using a microtitre plate reader.

DESCRIPTION OF THE ASSAY**Selection of animal species**

7. The mouse is the species of choice for this test. Validation studies for the LLNA: BrdU-ELISA were conducted exclusively with the CBA/JN strain, which is therefore considered the preferred strain (10) (12). Young adult female mice, which are nulliparous and non-pregnant, are used. At the start of the study, animals should be between 8-12 weeks old, and the weight variation of the animals should be minimal and not exceed 20 % of the mean weight. Alternatively, other strains and males may be used when sufficient data are generated to demonstrate that significant strain and/or gender-specific differences in the LLNA: BrdU-ELISA response do not exist.

Housing and feeding conditions

8. Mice should be group-housed (16), unless adequate scientific rationale for housing mice individually is provided. The temperature of the experimental animal room should be 22 ± 3 °C. Although the relative humidity should be at least 30 % and preferably not exceed 70 %, other than during room cleaning, the aim should be 50-60 %. Lighting should be artificial, the sequence being 12 hours light, 12 hours dark. For feeding, conventional laboratory diets may be used with an unlimited supply of drinking water.

Preparation of animals

9. The animals are randomly selected, marked to permit individual identification (but not by any form of ear marking), and kept in their cages for at least five days prior to the start of dosing to allow for acclimatisation to the laboratory conditions. Prior to the start of treatment all animals are examined to ensure that they have no observable skin lesions.

Preparation of dosing solutions

10. Solid chemicals should be dissolved or suspended in solvents/vehicles and diluted, if appropriate, prior to application to an ear of the mice. Liquid chemicals may be applied neat or diluted prior to dosing. Insoluble chemicals, such as those generally seen in medical devices, should be subjected to an exaggerated extraction in an appropriate solvent to reveal all extractable constituents for testing prior to application to an ear of the mice. Test substances should be prepared daily unless stability data demonstrate the acceptability of storage.

Reliability check

11. Positive control chemicals (PC) are used to demonstrate appropriate performance of the assay by responding with adequate and reproducible sensitivity as a sensitising test substance for which the magnitude of the response is well characterised. Inclusion of a concurrent PC is recommended because it demonstrates competency of the laboratory to successfully conduct each assay and allows for an assessment of intra- and inter-laboratory reproducibility and comparability. Some regulatory authorities also require a PC for each study and therefore users are encouraged to consult the relevant authorities prior to conducting the

▼ M3

LLNA: BrdU-ELISA. Accordingly, the routine use of a concurrent PC is encouraged to avoid the need for additional animal testing to meet such requirements that might arise from the use of a periodic PC (see paragraph 12). The PC should produce a positive LLNA: BrdU-ELISA response at an exposure level expected to give an increase in the SI $\geq 1,6$ over the negative control (NC) group. The PC dose should be chosen such that it does not cause excessive skin irritation or systemic toxicity and the induction is reproducible but not excessive (*e.g.* SI > 14 would be considered excessive). Preferred PC are 25 % hexyl cinnamic aldehyde (CAS No 101-86-0) and 25 % eugenol (CAS No 97-53-0) in acetone: olive oil (4:1, v/v). There may be circumstances in which, given adequate justification, other PC, meeting the above criteria, may be used.

12. While inclusion of a concurrent PC group is recommended, there may be situations in which periodic testing (*i.e.* at intervals ≤ 6 months) of the PC may be adequate for laboratories that conduct the LLNA: BrdU-ELISA regularly (*i.e.* conduct the LLNA: BrdU-ELISA at a frequency of no less than once per month) and have an established historical PC database that demonstrates the laboratory's ability to obtain reproducible and accurate results with PCs. Adequate proficiency with the LLNA: BrdU-ELISA can be successfully demonstrated by generating consistent positive results with the PC in at least 10 independent tests conducted within a reasonable period of time (*i.e.* less than one year).

13. A concurrent PC group should always be included when there is a procedural change to the LLNA: BrdU-ELISA (*e.g.* change in trained personnel, change in test method materials and/or reagents, change in test method equipment, change in source of test animals), and such changes should be documented in laboratory reports. Consideration should be given to the impact of these changes on the adequacy of the previously established historical database in determining the necessity for establishing a new historical database to document consistency in the PC results.

14. Investigators should be aware that the decision to conduct a PC study on a periodic basis instead of concurrently has ramifications on the adequacy and acceptability of negative study results generated without a concurrent PC during the interval between each periodic PC study. For example, if a false negative result is obtained in the periodic PC study, negative test substance results obtained in the interval between the last acceptable periodic PC study and the unacceptable periodic PC study may be questioned. Implications of these outcomes should be carefully considered when determining whether to include concurrent PCs or to only conduct periodic PCs. Consideration should also be given to using fewer animals in the concurrent PC group when this is scientifically justified and if the laboratory demonstrates, based on laboratory-specific historical data, that fewer mice can be used (17).

15. Although the PC should be tested in the vehicle that is known to elicit a consistent response (*e.g.* acetone: olive oil; 4:1, v/v), there may be certain regulatory situations in which testing in a non-standard vehicle (clinically/chemically relevant formulation) will also be necessary (18). If the concurrent PC is tested in a different vehicle than the test substance, then a separate VC for the concurrent PC should be included.

▼ M3

16. In instances where test substances of a specific chemical class or range of responses are being evaluated, benchmark substances may also be useful to demonstrate that the test method is functioning properly for detecting the skin sensitisation potential of these types of test substances. Appropriate benchmark substances should have the following properties:
- structural and functional similarity to the class of the test substance being tested;
 - known physical chemical characteristics;
 - supporting data from the LLNA: BrdU-ELISA;
 - supporting data from other animal models and/or from humans.

TEST PROCEDURE**Number of animals and dose levels**

17. A minimum of four animals is used per dose group, with a minimum of three concentrations of the test substance, plus a concurrent NC group treated only with the vehicle for the test substance, and a PC group (concurrent or recent, based on laboratory policy in considering paragraphs 11-15). Testing multiple doses of the PC should be considered especially when testing the PC on an intermittent basis. Except for absence of treatment with the test substance, animals in the control groups should be handled and treated in a manner identical to that of animals in the treatment groups.
18. Dose and vehicle selection should be based on the recommendations given in the references 2 and 19. Consecutive doses are normally selected from an appropriate concentration series such as 100 %, 50 %, 25 %, 10 %, 5 %, 2,5 %, 1 %, 0,5 %, etc. Adequate scientific rationale should accompany the selection of the concentration series used. All existing toxicological information (*e.g.* acute toxicity and dermal irritation) and structural and physicochemical information on the test substance of interest (and/or structurally related substances) should be considered, where available, in selecting the three consecutive concentrations so that the highest concentration maximises exposure while avoiding systemic toxicity and/or excessive local skin irritation (19) (20 and Chapter B.4 of this Annex). In the absence of such information, an initial pre-screen test may be necessary (see paragraphs 21-24).
19. The vehicle should not interfere with or bias the test result and should be selected on the basis of maximising the solubility in order to obtain the highest concentration achievable while producing a solution/suspension suitable for application of the test substance. Recommended vehicles are acetone: olive oil (4:1 v/v), *N,N*-dimethylformamide, methyl ethyl ketone, propylene glycol, and dimethyl sulphoxide (6) but others may be used if sufficient scientific rationale is provided. In certain situations it may be necessary to use a clinically relevant solvent or the commercial formulation in which the test substance is marketed as an additional control. Particular care should be taken to ensure that hydrophilic test substances are incorporated into a vehicle system, which wets the skin and does not immediately run off, by incorporation of appropriate solubilisers (*e.g.* 1 % Pluronic® L92). Thus, wholly aqueous vehicles are to be avoided.

▼ **M3**

20. The processing of lymph nodes from individual mice allows for the assessment of inter-animal variability and a statistical comparison of the difference between test substance and VC group measurements (see paragraph 33). In addition, evaluating the possibility of reducing the number of mice in the PC group is only feasible when individual animal data are collected (17). Further, some regulatory authorities require the collection of individual animal data. Regular collection of individual animal data provides an animal welfare advantage by avoiding duplicate testing that would be necessary if the test substance results originally collected in one manner (*e.g.* via pooled animal data) were to be considered later by regulatory authorities with other requirements (*e.g.* individual animal data).

Pre-screen test

21. In the absence of information to determine the highest dose to be tested (see paragraph 18), a pre-screen test should be performed in order to define the appropriate dose level to test in the LLNA: BrdU-ELISA. The purpose of the pre-screen test is to provide guidance for selecting the maximum dose level to use in the main LLNA: BrdU-ELISA study, where information on the concentration that induces systemic toxicity (see paragraph 24) and/or excessive local skin irritation (see paragraph 23) is not available. The maximum dose level tested should be a concentration of 100 % of the test substance for liquids or the maximum possible concentration for solids or suspensions.
22. The pre-screen test is conducted under conditions identical to the main LLNA: BrdU-ELISA study, except there is no assessment of lymph node proliferation and fewer animals per dose group can be used. One or two animals per dose group are suggested. All mice will be observed daily for any clinical signs of systemic toxicity or local irritation at the application site. Body weights are recorded pre-test and prior to termination (Day 6). Both ears of each mouse are observed for erythema and scored using Table 1 (20 and Chapter B.4 of this Annex). Ear thickness measurements are taken using a thickness gauge (*e.g.* digital micrometer or Peacock Dial thickness gauge) on Day 1 (pre-dose), Day 3 (approximately 48 hours after the first dose), and Day 6. Additionally, on Day 6, ear thickness could be determined by ear punch weight determinations, which should be performed after the animals are humanely killed. Excessive local irritation is indicated by an erythema score ≥ 3 and/or ear thickness of ≥ 25 % on any day of measurement (21) (22). The highest dose selected for the main LLNA: BrdU-ELISA study will be the next lower dose in the pre-screen concentration series (see paragraph 18) that does not induce systemic toxicity and/or excessive local skin irritation.

Table 1
Erythema Scores

Observation	Score
No erythema	0
Very slight erythema (barely perceptible)	1
Well-defined erythema	2

▼ **M3**

Observation	Score
Moderate to severe erythema	3
Severe erythema (beet redness) to eschar formation preventing grading of erythema	4

23. In addition to a 25 % increase in ear thickness (21) (22), a statistically significant increase in ear thickness in the treated mice compared to control mice has also been used to identify irritants in the LLNA (22) (23) (24) (25) (26) (27) (28). However, while statistically significant increases can occur when ear thickness is less than 25 % they have not been associated specifically with excessive irritation (25) (26) (27) (28) (29).
24. The following clinical observations may indicate systemic toxicity (30) when used as part of an integrated assessment and therefore may indicate the maximum dose level to use in the main LLNA: BrdU-ELISA: changes in nervous system function (*e.g.* pilo-erection, ataxia, tremors, and convulsions); changes in behaviour (*e.g.* aggressiveness, change in grooming activity, marked change in activity level); changes in respiratory patterns (*i.e.* changes in frequency and intensity of breathing such as dyspnea, gasping, and rales), and changes in food and water consumption. In addition, signs of lethargy and/or unresponsiveness and any clinical signs of more than slight or momentary pain and distress, or a > 5 % reduction in body weight from Day 1 to Day 6 and mortality should be considered in the evaluation. Moribund animals or animals showing signs of severe pain and distress should be humanely killed (31).

Main study experimental schedule

25. The experimental schedule of the assay is as follows:
- *Day 1:* Individually identify and record the weight of each animal and any clinical observation. Apply 25 µL of the appropriate dilution of the test substance, the vehicle alone, or the PC (concurrent or recent, based on laboratory policy in considering paragraphs 11-15), to the dorsum of each ear.
 - *Days 2 and 3:* Repeat the application procedure carried out on Day 1.
 - *Day 4:* No treatment.
 - *Day 5:* Inject 0,5 mL (5 mg/mouse) of BrdU (10 mg/mL) solution intra-peritoneally.
 - *Day 6:* Record the weight of each animal and any clinical observation. Approximately 24 hours (24 h) after BrdU injection, humanely kill the animals. Excise the draining auricular lymph nodes from each mouse ear and process separately in phosphate buffered saline (PBS) for each animal. Details and diagrams of the lymph node identification and dissection can be found in reference (17). To further monitor the local skin response in the main study, additional parameters such as scoring of ear erythema or ear thickness measurements (obtained either by using a thickness gauge, or ear punch weight determinations at necropsy) may be included into the study protocol.

▼ M3**Preparation of cell suspensions**

26. From each mouse, a single-cell suspension of lymph node cells (LNC) excised bilaterally is prepared by gentle mechanical disaggregation through 200 micron-mesh stainless steel gauze or another acceptable technique for generating a single-cell suspension (*e.g.* use of a disposable plastic pestle to crush the lymph nodes followed by passage through a #70 nylon mesh). The procedure for preparing the LNC suspension is critical in this assay and therefore every operator should establish the skill in advance. Further, the lymph nodes in NC animals are small, so careful operation is important to avoid any artificial effects on SI values. In each case, the target volume of the LNC suspension should be adjusted to a determined optimised volume (approximately 15 mL). The optimised volume is based on achieving a mean absorbance of the NC group within 0,1-0,2.

Determination of cellular proliferation (measurement of BrdU content in DNA of lymphocytes)

27. BrdU is measured by ELISA using a commercial kit (*e.g.* Roche Applied Science, Mannheim, Germany, Catalogue Number 11 647 229 001). Briefly, 100 µL of the LNC suspension is added to the wells of a flat-bottom microplate in triplicate. After fixation and denaturation of the LNC, anti-BrdU antibody is added to each well and allowed to react. Subsequently the anti-BrdU antibody is removed by washing and the substrate solution is then added and allowed to produce chromogen. Absorbance at 370 nm with a reference wavelength of 492 nm is then measured. In all cases, assay test conditions should be optimised (see paragraph 26).

OBSERVATIONS**Clinical observations**

28. Each mouse should be carefully observed at least once daily for any clinical signs, either of local irritation at the application site or of systemic toxicity. All observations are systematically recorded with records being maintained for each mouse. Monitoring plans should include criteria to promptly identify those mice exhibiting systemic toxicity, excessive local skin irritation, or corrosion of skin for euthanasia (31).

Body weights

29. As stated in paragraph 25, individual animal body weights should be measured at the start of the test and at the scheduled humane kill.

CALCULATION OF RESULTS

30. Results for each treatment group are expressed as the mean SI. The SI is derived by dividing the mean BrdU labelling index/mouse within each test substance group and the PC group by the mean BrdU labelling index for the solvent/VC group. The average SI for the VCs is then one.

The BrdU labelling index is defined as:

$$\text{BrdU labelling index} = (\text{ABS}_{\text{em}} - \text{ABS blank}_{\text{em}}) - (\text{ABS}_{\text{ref}} - \text{ABS blank}_{\text{ref}})$$

Where: em = emission wavelength; and ref = reference wavelength.

▼ M3

31. The decision process regards a result as positive when $SI \geq 1,6$ (10). However, the strength of the dose-response relationship, the statistical significance and the consistency of the solvent/vehicle and PC responses may also be used when determining whether a borderline result (*i.e.* SI value between 1,6 and 1,9) is declared positive (3) (6) (32).
32. For a borderline positive response between an SI of 1,6 and 1,9, users may want to consider additional information such as dose-response relationship, evidence of systemic toxicity or excessive irritation, and where appropriate, statistical significance together with SI values to confirm that such results are positives (10). Consideration should also be given to various properties of the test substance, including whether it has a structural relationship to known skin sensitisers, whether it causes excessive skin irritation in the mouse, and the nature of the dose-response observed. These and other considerations are discussed in detail elsewhere (4).
33. Collecting data at the level of the individual mouse will enable a statistical analysis for presence and degree of dose-response relationship in the data. Any statistical assessment could include an evaluation of the dose-response relationship as well as suitably adjusted comparisons of test groups (*e.g.* pair-wise dosed group versus concurrent solvent/vehicle control comparisons). Statistical analyses may include, *e.g.* linear regression or William's test to assess dose-response trends, and Dunnett's test for pair-wise comparisons. In choosing an appropriate method of statistical analysis, the investigator should maintain an awareness of possible inequalities of variances and other related problems that may necessitate a data transformation or a non-parametric statistical analysis. In any case, the investigator may need to carry out SI calculations and statistical analyses with and without certain data points (sometimes called 'outliers').

DATA AND REPORTING**Data**

34. Data should be summarised in tabular form showing the individual animal BrdU labelling index values, the group mean BrdU labelling index/animal, its associated error term (*e.g.* SD, SEM), and the mean SI for each dose group compared against the concurrent solvent/vehicle control group.

Test report

35. The test report should contain the following information:

Test and control chemicals:

- identification data (*e.g.* CAS number and EC number, if available; source; purity; known impurities; lot number);
- physical nature and physicochemical properties (*e.g.* volatility, stability, solubility);
- if mixture, composition and relative percentages of components;

Solvent/vehicle:

- identification data (purity; concentration, where appropriate; volume used);
- justification for choice of vehicle;

▼ M3

Test animals:

- source of CBA mice;
- microbiological status of the animals, when known;
- number and age of animals;
- source of animals, housing conditions, diet, etc.;

Test conditions:

- source, lot number, and manufacturer's quality assurance/quality control data (antibody sensitivity and specificity and the limit of detection) for the ELISA kit;
- details of test substance preparation and application;
- justification for dose selection (including results from pre-screen test, if conducted);
- vehicle and test substance concentrations used, and total amount of test substance applied;
- details of food and water quality (including diet type/source, water source);
- details of treatment and sampling schedules;
- methods for measurement of toxicity;
- criteria for considering studies as positive or negative;
- details of any protocol deviations and an explanation on how the deviation affects the study design and results;

Reliability check:

- a summary of results of latest reliability check, including information on test substance, concentration and vehicle used;
- concurrent and/or historical PC and concurrent negative (solvent/vehicle) control data for testing laboratory;
- if a concurrent PC was not included, the date and laboratory report for the most recent periodic PC and a report detailing the historical PC data for the laboratory justifying the basis for not conducting a concurrent PC;

Results:

- individual weights of mice at start of dosing and at scheduled humane kill; as well as mean and associated error term (*e.g.* SD, SEM) for each treatment group;
- time course of onset and signs of toxicity, including dermal irritation at site of administration, if any, for each animal;
- a table of individual mouse BrdU labelling indices and SI values for each treatment group;
- mean and associated error term (*e.g.* SD, SEM) for BrdU labelling index/mouse for each treatment group and the results of outlier analysis for each treatment group;

▼ **M3**

- calculated SI and an appropriate measure of variability that takes into account the inter-animal variability in both the test substance and control groups;
- dose-response relationship;
- statistical analyses, where appropriate;

Discussion of results:

- a brief commentary on the results, the dose-response analysis, and statistical analyses, where appropriate, with a conclusion as to whether the test substance should be considered a skin sensitiser.

LITERATURE

- (1) OECD (2010), Skin Sensitisation: Local Lymph Node Assay, Test Guideline No 429, Guidelines for the Testing of Chemicals, OECD, Paris. Available at: [<http://www.oecd.org/env/testguidelines>]
- (2) Chamberlain, M. and Basketter, D.A. (1996), The local lymph node assay: status of validation. *Food Chem. Toxicol.*, 34, 999-1002.
- (3) Basketter, D.A., Gerberick, G.F., Kimber, I. and Loveless, S.E. (1996), The local lymph node assay: A viable alternative to currently accepted skin sensitisation tests. *Food Chem. Toxicol.*, 34, 985-997.
- (4) Basketter, D.A., Gerberick, G.F. and Kimber, I. (1998), Strategies for identifying false positive responses in predictive sensitisation tests. *Food Chem. Toxicol.*, 36, 327-33.
- (5) Van Och, F.M.M., Slob, W., De Jong, W.H., Vandebriel, R.J. and Van Loveren, H. (2000), A quantitative method for assessing the sensitising potency of low molecular weight chemicals using a local lymph node assay: employment of a regression method that includes determination of uncertainty margins. *Toxicol.*, 146, 49-59.
- (6) ICCVAM (1999), The murine local lymph node Assay: A test method for assessing the allergic contact dermatitis potential of chemicals/compounds: The results of an independent peer review evaluation coordinated by the Interagency Coordinating Committee on the Validation of Alternative Methods (ICCVAM) and the National Toxicology Program Center for the Evaluation of Alternative Toxicological Methods (NICETAM). NIH Publication No: 99-4494. Research Triangle Park, N.C. Available at: [http://iccvam.niehs.nih.gov/docs/immunotox_docs/llna/llnarep.pdf]
- (7) Dean, J.H., Twerdok, L.E., Tice, R.R., Sailstad, D.M., Hattan, D.G., Stokes, W.S. (2001), ICCVAM evaluation of the murine local lymph node assay: II. Conclusions and recommendations of an independent scientific peer review panel. *Reg. Toxicol. Pharmacol.*, 34(3), 258-273.
- (8) Haneke, K.E., Tice, R.R., Carson, B.L., Margolin, B.H., Stokes, W.S. (2001), ICCVAM evaluation of the murine local lymph node assay: III. Data analyses completed by the national toxicology program interagency center for the evaluation of alternative toxicological methods. *Reg. Toxicol. Pharmacol.*, 34(3), 274-286.
- (9) Sailstad, D.M., Hattan, D., Hill, R.N., Stokes, W.S. (2001), ICCVAM evaluation of the murine local lymph node assay: I. The ICCVAM review process. *Reg. Toxicol. Pharmacol.*, 34(3), 249-257.
- (10) ICCVAM (2010), ICCVAM Test Method Evaluation Report. Nonradioactive local lymph node assay: BrdU-ELISA Test Method Protocol (LLNA: BrdU-ELISA). NIH Publication No 10-7552A/B. Research Triangle Park, NC: National Institute of Environmental Health Sciences. Available at: [<http://iccvam.niehs.nih.gov/methods/immunotox/llna-ELISA/TMER.htm>]

▼ **M3**

- (11) ICCVAM (2009), Independent Scientific Peer Review Panel Report: Updated validation status of new versions and applications of the murine local lymph node assay: a test method for assessing the allergic contact dermatitis potential of chemicals and products. Research Triangle Park, NC: National Institute of Environmental Health Sciences. Available at: [http://iccvam.niehs.nih.gov/docs/immunotox_docs/LLNAPRPrept2009.pdf]
- (12) Takeyoshi, M., Iida, K., Shiraishi, K. and Hoshuyama, S. (2005), Novel approach for classifying chemicals according to skin sensitising potency by non-radioisotopic modification of the local lymph node assay. *J. Appl. Toxicol.*, 25, 129-134.
- (13) OECD (1992), Skin Sensitisation, Test Guideline No 406, Guidelines for Testing of Chemicals, OECD, Paris. Available at: [<http://www.oecd.org/env/testguidelines>]
- (14) Kreiling, R., Hollnagel, H.M., Hareng, L., Eigler, L., Lee, M.S., Griem, P., Dreesen, B., Kleber, M., Albrecht, A., Garcia, C. and Wendel, A. (2008), Comparison of the skin sensitising potential of unsaturated compounds as assessed by the murine local lymph node assay (LLNA) and the guinea pig maximization test (GPMT). *Food Chem. Toxicol.*, 46, 1896-1904.
- (15) Basketter, D., Ball, N., Cagen, S., Carrilo, J.C., Certa, H., Eigler, D., Garcia, C., Esch, H., Graham, C., Haux, C., Kreiling, R. and Mehling, A. (2009), Application of a weight of evidence approach to assessing discordant sensitisation datasets: implications for REACH. *Reg. Toxicol. Pharmacol.*, 55, 90-96.
- (16) ILAR (1996), Institute of Laboratory Animal Research (ILAR) Guide for the Care and Use of Laboratory Animals. 7th ed. Washington, DC: National Academies Press.
- (17) ICCVAM (2009), Recommended Performance Standards: Murine Local Lymph Node Assay. NIH Publication Number 09-7357. Research Triangle Park, NC: National Institute of Environmental Health Sciences. Available at: [http://iccvam.niehs.nih.gov/docs/immunotox_docs/llna-ps/LLNAPerfStds.pdf]
- (18) McGarry, H.F. (2007), The murine local lymph node assay: regulatory and potency considerations under REACH. *Toxicol.*, 238, 71-89.
- (19) Kimber, I., Dearman, R.J., Scholes E.W. and Basketter, D.A. (1994), The local lymph node assay: developments and applications. *Toxicol.*, 93, 13-31.
- (20) OECD (2002), Acute Dermal Irritation/Corrosion, Test Guideline No 404, Guidelines for Testing of Chemicals, OECD, Paris. Available at: [<http://www.oecd.org/env/testguidelines>]
- (21) Reeder, M.K., Broomhead, Y.L., DiDonato, L. and DeGeorge, G.L. (2007), Use of an enhanced local lymph node assay to correctly classify irritants and false positive substances. *Toxicologist*, 96, 235.
- (22) ICCVAM (2009), Nonradioactive Murine Local Lymph Node Assay: Flow Cytometry Test Method Protocol (LLNA: BrdU-FC) Revised Draft Background Review Document. Research Triangle Park, NC: National Institute of Environmental Health Sciences. Available at: [<http://iccvam.niehs.nih.gov/methods/immunotox/fcLLNA/BRDcomplete.pdf>]
- (23) Hayes, B.B., Gerber, P.C., Griffey, S.S. and Meade, B.J. (1998), Contact hypersensitivity to dicyclohexylcarbodiimide and diisopropylcarbodiimide in female B6C3F1 mice. *Drug Chem. Toxicol.*, 21, 195-206.
- (24) Homey, B., von Schilling, C., Blumel, J., Schuppe, H.C., Ruzicka, T., Ahr, H.J., Lehmann, P. and Vohr, V.W. (1998), An integrated model for the differentiation of chemical-induced allergic and irritant skin reactions. *Toxicol. Appl. Pharmacol.*, 153, 83-94.
- (25) Woolhiser, M.R., Hayes, B.B. and Meade, B.J. (1998), A combined murine local lymph node and irritancy assay to predict sensitisation and irritancy potential of chemicals. *Toxicol. Meth.*, 8, 245-256.

▼ M3

- (26) Hayes, B.B. and Meade, B.J. (1999), Contact sensitivity to selected acrylate compounds in B6C3F1 mice: relative potency, cross reactivity, and comparison of test methods. *Drug. Chem. Toxicol.*, 22, 491-506.
- (27) Ehling, G., Hecht, M., Heusener, A., Huesler, J., Gamer, A.O., van Loveren, H., Maurer, T., Riecke, K., Ullmann, L., Ulrich, P., Vandebriel, R. and Vohr, H.W. (2005), A European inter-laboratory validation of alternative endpoints of the murine local lymph node assay: first round. *Toxicol.*, 212, 60-68.
- (28) Vohr, H.W. and Ahr, H.J. (2005), The local lymph node assay being too sensitive? *Arch. Toxicol.*, 79, 721-728.
- (29) Patterson, R.M., Noga, E. and Germolec D. (2007), Lack of evidence for contact sensitisation by Pfisteria extract. *Environ. Health Perspect.*, 115, 1023-1028.
- (30) ICCVAM (2009), Report on the ICCVAM-NICEATM/ECVAM/JaCVAM Scientific Workshop on Acute Chemical Safety Testing: Advancing *In Vitro* Approaches and Humane Endpoints for Systemic Toxicity Evaluations. Research Triangle Park, NC: National Institute of Environmental Health Sciences. Available at: [http://iccvam.niehs.nih.gov/methods/acutetox/Tox_workshop.htm].
- (31) OECD (2000), Guidance Document on the Recognition, Assessment and Use of Clinical Signs as Humane Endpoints for Experimental Animals Used in Safety Evaluation, Environmental Health and Safety Monograph Series on Testing and Assessment No 19, ENV/JM/MONO(2000)7, OECD, Paris. Available at: [<http://www.oecd.org/env/testguidelines>]
- (32) Kimber, I., Hilton, J., Dearman, R.J., Gerberick, G.F., Ryan, C.A., Basketter, D.A., Lea, L., House, R.V., Ladies, G.S., Loveless, S.E. and Hastings, K.L. (1998), Assessment of the skin sensitisation potential of topical medicaments using the local lymph node assay: An interlaboratory exercise. *J. Toxicol. Environ. Health*, 53, 563-79.
- (33) OECD (2005), Guidance Document on the Validation and International Acceptance of New or Updated Test Methods for Hazard Assessment, Environment, Health and Safety Monograph Series on Testing and Assessment No 34, ENV/JM/MONO(2005)14, OECD, Paris. Available at: [<http://www.oecd.org/env/testguidelines>]

▼ **M3***Appendix 1*

DEFINITIONS

Accuracy: The closeness of agreement between test method results and accepted reference values. It is a measure of test method performance and one aspect of relevance. The term is often used interchangeably with 'concordance' to mean the proportion of correct outcomes of a test method (33).

Benchmark substance: A sensitising or non-sensitising substance used as a standard for comparison to a test substance. A benchmark substance should have the following properties: (i) a consistent and reliable source(s); (ii) structural and functional similarity to the class of substances being tested; (iii) known physical/chemical characteristics; (iv) supporting data on known effects; and (v) known potency in the range of the desired response.

False negative: A test substance incorrectly identified as negative or non-active by a test method, when in fact it is positive or active (33).

False positive: A test substance incorrectly identified as positive or active by a test, when in fact it is negative or non-active (33).

Hazard: The potential for an adverse health or ecological effect. The adverse effect is manifested only if there is an exposure of sufficient level.

Inter-laboratory reproducibility: A measure of the extent to which different qualified laboratories, using the same protocol and testing the same test substance, can produce qualitatively and quantitatively similar results. Inter-laboratory reproducibility is determined during the pre-validation and validation processes, and indicates the extent to which a test can be successfully transferred between laboratories, also referred to as between-laboratory reproducibility (33).

Intra-laboratory reproducibility: A determination of the extent that qualified people within the same laboratory can successfully replicate results using a specific protocol at different times. Also referred to as within-laboratory reproducibility (33).

Outlier: An outlier is an observation that is markedly different from other values in a random sample from a population.

Quality assurance: A management process by which adherence to laboratory testing standards, requirements, and record keeping procedures, and the accuracy of data transfer, are assessed by individuals who are independent from those performing the testing.

Reliability: Measures of the extent that a test method can be performed reproducibly within and between laboratories over time, when performed using the same protocol. It is assessed by calculating intra- and inter-laboratory reproducibility (33).

Skin sensitisation: An immunological process that results when a susceptible individual is exposed topically to an inducing chemical allergen, which provokes a cutaneous immune response that can lead to the development of contact sensitisation.

Stimulation Index (SI): A value calculated to assess the skin sensitisation potential of a test substance that is the ratio of the proliferation in treated groups to that in the concurrent vehicle control group.

Test substance (also referred to as test chemical): Any substance or mixture tested using this TM.

▼M4**B.52. ACUTE INHALATION TOXICITY — ACUTE TOXIC CLASS METHOD**

INTRODUCTION

1. This Test Method is equivalent to OECD Test Guideline (TG) 436 (2009). The first acute inhalation TG 403 was adopted in 1981, and has since been revised (see chapter B.2 of this Annex (1)). Development of an Inhalation Acute Toxic Class (ATC) method (2) (3) (4) was considered appropriate following the adoption of the revised oral ATC method (chapter B.1 tris of this Annex) (5). A retrospective performance assessment of the ATC test method for acute inhalation toxicity showed that the method is suitable for being used for Classification and Labelling purposes (6). The inhalation ATC Test Method will allow the use of serial steps of fixed target concentrations to provide a ranking of test chemical toxicity. Lethality is used as key endpoint, however, animals in severe pain or distress, suffering or impending death should be humanely killed to minimise suffering. Guidance on humane endpoints is available in the OECD Guidance Document No 19 (7).
2. Guidance on the conduct and interpretation of this Test Method can be found in the Guidance Document No 39 on Acute Inhalation Toxicity Testing (GD 39) (8).
3. Definitions used in the context of this Test Method are provided in Appendix 1 and in GD 39 (8).
4. The Test Method provides information on the hazardous properties and allows the test chemical to be ranked and classified according to the Regulation (EC) No 1272/2008 for the classification of chemicals that cause acute toxicity (9). In case point estimates of LC₅₀-values or concentration-response analyses are required, chapter B.2 of this Annex (1) is the appropriate Test Method to use. Further guidance on Test Method selection can be found in GD 39 (8). This Test Method is not specially intended for the testing of specialized materials, such as poorly soluble isometric or fibrous materials or manufactured nanomaterials.

INITIAL CONSIDERATIONS

5. Before considering testing in accordance with this Test Method, all available information on the test chemical, including existing studies whose data would support not doing additional testing should be considered by the testing laboratory in order to minimize animal usage. Information that may assist in the selection of the most appropriate species, strain, sex, mode of exposure and appropriate test concentrations include the identity, chemical structure, and physico-chemical properties of the test chemical; results of any *in vitro* or *in vivo* toxicity tests; anticipated use(s) and potential for human exposure; available (Q)SAR data and toxicological data on structurally related chemicals. Concentrations that are expected to cause severe pain and distress, due to corrosive⁽¹⁾ or severely irritant actions, should not be tested with this Test Method [see GD 39 (8)].

⁽¹⁾ The corrosivity evaluation could be based on expert judgment using such evidence as: human and animal experience, existing (*in vitro*) data, e.g. chapter B.40 (10), B.40 bis (11) of this annex or OECD TG 435 (12), pH values, information from similar chemicals or any other pertinent data.

▼M4

PRINCIPLE OF THE TEST

6. It is the principle of the test that based on a stepwise procedure, sufficient information is obtained on the acute inhalation toxicity of the test chemical during an exposure period of 4 hours to enable its classification. Other durations of exposure may apply to serve specific regulatory purposes. At any of the defined concentration steps, 3 animals of each sex are tested. Depending on the mortality and/or the moribund status of the animals, 2 steps may be sufficient to allow judgement on the acute toxicity of the test chemical. If evidence is provided that one sex is more susceptible than the other, then the test may be continued with the more susceptible sex only. The outcome of the previous step will determine the following step such that:
 - a) No further testing is needed,
 - b) Testing of three animals per sex, or
 - c) Testing with 6 animals of the more susceptible sex only *i.e.* the lower boundary estimates of the toxic class should be based on 6 animals per test concentration group, regardless of sex.
7. Moribund animals or animals obviously in pain or showing signs of severe and enduring distress should be humanely killed, and are considered in the interpretation of the test results in the same way as animals that died on test. Criteria for making the decision to kill moribund or severely suffering animals, and guidance on the recognition of predictable or impending death, are the subject of Guidance Document No 19 on Humane Endpoints (7).

DESCRIPTION OF THE METHOD

Selection of animal species

8. Healthy young adult animals of commonly used laboratory strains should be used. The preferred species is the rat and justifications should be provided if other species are used.

Preparation of animals

9. Females should be nulliparous and non-pregnant. On the exposure day, animals should be young adults 8 to 12 weeks of age, and body weights should be within ± 20 % of the mean weight for each sex of any previously exposed animals at the same age. The animals are randomly selected, marked for individual identification. The animals are kept in their cages for at least 5 days prior to the start of the test to allow for acclimatisation to laboratory conditions. Animals should also be acclimatised to the test apparatus for a short period prior to testing, as this will lessen the stress caused by introduction to the new environment.

Animal husbandry

10. The temperature of the experimental animal maintenance room should be 22 ± 3 °C. The relative humidity should ideally be maintained in the range of 30 to 70 %, though this may not be possible when using water as a vehicle. Before and after exposures, animals generally should be caged in groups by sex and concentration, but the number of animals per cage should not interfere with clear observation of each animal and should minimise losses due to cannibalism and fighting. When animals are to be exposed nose-only, it may be necessary for them to be acclimated to the restraining tubes. The restraining tubes should not impose undue physical, thermal, or immobilisation stress on the animals. Restraint may affect physiological

▼ M4

endpoints such as body temperature (hyperthermia) and/or respiratory minute volume. If generic data are available to show that no such changes occur to any appreciable extent, then pre-adaptation to the restraining tubes is not necessary. Animals exposed whole-body to an aerosol should be housed individually during exposure to prevent them from filtering the test aerosol through the fur of their cage mates. Conventional and certified laboratory diets may be used, except during exposure, accompanied with an unlimited supply of municipal drinking water. Lighting should be artificial, the sequence being 12 hours light/12 hours dark.

Inhalation chambers

11. The nature of the test chemical and the objective of the test should be considered when selecting an inhalation chamber. The preferred mode of exposure is nose-only (which term includes head-only, nose-only or snout-only). Nose-only exposure is generally preferred for studies of liquid or solid aerosols and for vapours that may condense to form aerosols. Special objectives of the study may be better achieved by using a whole-body mode of exposure, but this should be justified in the study report. To ensure atmosphere stability when using a whole-body chamber, the total volume of the test animals should not exceed 5 % of the chamber volume. Principles of the nose-only and whole body exposure techniques and their particular advantages and disadvantages are described in GD 39 (8).

EXPOSURE CONDITIONS**Administrations of concentrations**

12. A fixed duration of exposure for four hours, excluding equilibration time, is recommended. Other durations may be needed to meet specific requirements, however, justification should be provided in the study report [see GD 39 (8)]. Animals exposed in whole-body chambers should be housed individually to prevent ingestion of test chemical due to grooming of cage mates. Feed should be withheld during the exposure period. Water may be provided throughout a whole-body exposure.
13. Animals are exposed to the test chemical as a gas, vapour, aerosol, or a mixture thereof. The physical state to be tested depends on the physico-chemical properties of the test chemical, the selected concentration, and/or the physical form most likely present during the handling and use of the test chemical. Hygroscopic and chemically reactive test chemicals should be tested under dry air conditions. Care should be taken to avoid generating explosive concentrations.

Particle-size distribution

14. Particle sizing should be performed for all aerosols and for vapours that may condense to form aerosols. To allow for exposure of all relevant regions of the respiratory tract, aerosols with mass median aerodynamic diameters (MMAD) ranging from 1 to 4 μm with a geometric standard deviation (σ_g) in the range of 1,5 to 3,0 are recommended (8) (13) (14). Although a reasonable effort should be made to meet this standard, expert judgment should be provided if it cannot be achieved. For example, metal fumes may be smaller than this standard, and charged particles, fibres, and hygroscopic materials (which increase in size in the moist environment of the respiratory tract) may exceed this standard.

▼M4**Test chemical preparation in a vehicle**

15. A vehicle may be used to generate an appropriate concentration and particle size of the test chemical in the atmosphere. As a rule, water should be given preference. Particulate material may be subjected to mechanical processes to achieve the required particle size distribution, however, care should be taken not to decompose or alter the test chemical. In cases where mechanical processes are believed to have altered test chemical composition (e.g. extreme temperature from excessive milling due to friction), the composition of the test chemical should be verified analytically. Adequate care should be taken to not contaminate the test chemical. It is not necessary to test non-friable granular materials which are purposefully formulated to be un-inhalable. An attrition test should be used to demonstrate that respirable particles are not produced when the granular material is handled. If an attrition test produces respirable particles, an inhalation toxicity test should be performed.

Control animals

16. A concurrent negative (air) control group is not necessary. When a vehicle other than water is used to assist in generating the test atmosphere, a vehicle control group should only be used when historical inhalation toxicity data are not available. If a toxicity study of a test chemical formulated in a vehicle reveals no toxicity, it follows that the vehicle is non-toxic at the concentration tested; thus, there is no need for a vehicle control.

MONITORING OF EXPOSURE CONDITIONS**Chamber airflow**

17. The flow of air through the chamber should be carefully controlled, continuously monitored, and recorded at least hourly during each exposure. The monitoring of test atmosphere concentration (or stability) is an integral measurement of all dynamic parameters and provides an indirect means to control all relevant dynamic atmosphere generation parameters. Special consideration should be given to avoiding re-breathing in nose-only chambers in cases where airflow through the exposure system are inadequate to provide dynamic flow of test chemical atmosphere. There are prescribed methodologies that can be used to demonstrate that re-breathing does not occur under the selected operation conditions (8) (15). Oxygen concentration should be at least 19 % and carbon dioxide concentration should not exceed 1 %. If there is reason to believe that these standards cannot be met, oxygen and carbon dioxide concentrations should be measured.

Chamber temperature and relative humidity

18. Chamber temperature should be maintained at 22 ± 3 °C. Relative humidity in the animals' breathing zone, for both nose-only and whole-body exposures, should be monitored and recorded at least three times for durations up to 4 hrs, and hourly for shorter durations. The relative humidity should ideally be maintained in the range of 30 to 70 %, but this may either be unattainable (e.g. when testing water based mixtures) or not measurable due to test chemical interference with the test method.

▼ M4**Test chemical: nominal concentration**

19. Whenever feasible, the nominal exposure chamber concentration should be calculated and recorded. The nominal concentration is the mass of generated test chemical divided by the total volume of air passed through the chamber system. The nominal concentration is not used to characterise the animals' exposure, but a comparison of the nominal and the actual concentration gives an indication of the generation efficiency of the test system, and thus may be used to discover generation problems.

Test chemical: actual concentration

20. The actual concentration is the test chemical concentration at the animals' breathing zone in an inhalation chamber. Actual concentrations can be obtained either by specific methods (*e.g.* direct sampling, adsorptive or chemical reactive methods, and subsequent analytical characterisation) or by non-specific methods such as gravimetric filter analysis. The use of gravimetric analysis is acceptable only for single component powder aerosols or aerosols of low volatility liquids and should be supported by appropriate pre-study test chemical-specific characterisations. Multi-component powder aerosol concentration may also be determined by gravimetric analysis. However, this requires analytical data which demonstrate that the composition of airborne material is similar to the starting material. If this information is not available, a reanalysis of the test chemical (ideally in its airborne state) at regular intervals during the course of the study may be necessary. For aerosolised agents that may evaporate or sublime, it should be shown that all phases were collected by the method chosen. The target, nominal, and actual concentrations should be provided in the study report, but only actual concentrations are used in statistical analyses to calculate lethal concentration values.
21. One lot of the test chemical should be used, if possible, and the test sample should be stored under conditions that maintain its purity, homogeneity, and stability. Prior to the start of the study, there should be a characterisation of the test chemical, including its purity and, if technically feasible, the identity, and quantities of identified contaminants and impurities. This can be demonstrated by, but is not limited to, the following data: retention time and relative peak area, molecular weight from mass spectroscopy or gas chromatography analyses, or other estimates. Although the test sample's identity is not the responsibility of the test laboratory, it may be prudent for the test laboratory to confirm the sponsor's characterisation at least in a limited way (*e.g.* colour, physical nature, etc.).
22. The exposure atmosphere shall be held as constant as practicable and monitored continuously and/or intermittently depending on the method of analysis. When intermittent sampling is used, chamber atmosphere samples should be taken at least twice in a four hour study. If not feasible due to limited air flow rates or low concentrations, one sample may be collected over the entire exposure period. If marked sample-to-sample fluctuations occur, the next concentrations tested should use four samples per exposure. Individual chamber concentration samples should not deviate from the mean chamber concentration by more than $\pm 10\%$ for gases and vapours, and by no more than $\pm 20\%$ for liquid or solid aerosols. Time to chamber equilibration (t_{95}) should be calculated and recorded. The duration of an exposure spans the time that the test chemical is generated and this takes into account the times required to attain t_{95} . Guidance for estimating t_{95} can be found in GD 39 (8).

▼ M4

23. For very complex mixtures consisting of vapours/gases, and aerosols (*e.g.* combustion atmospheres and test chemicals propelled from purpose-driven end-use products/devices), each phase may behave differently in an inhalation chamber so at least one indicator substance (analyte), normally the principal active substance in the mixture, of each phase (vapour/gas and aerosol) should be selected. When the test chemical is a mixture, the analytical concentration should be reported for the total mixture and not just for the active ingredient or the component (analyte). Additional information regarding actual concentrations can be found in GD 39 (8).

Test chemical: particle size distribution

24. The particle size distribution of aerosols should be determined at least twice during each 4 hour exposure by using a cascade impactor or an alternative instrument such as an aerodynamic particle sizer. If equivalence of the results obtained by a cascade impactor or an alternative instrument can be shown, then the alternative instrument may be used throughout the study. A second device, such as a gravimetric filter or an impinger/gas bubbler, should be used in parallel to the primary instrument to confirm the collection efficiency of the primary instrument. The mass concentration obtained by particle size analysis should be within reasonable limits of the mass concentration obtained by filter analysis [see GD 39 (8)]. If equivalence can be demonstrated in the early phase of the study, then further confirmatory measurements may be omitted. For animal welfare reasons, measures should be taken to minimize inconclusive data which may lead to a need to repeat an exposure. Particle sizing should be performed for vapours if there is any possibility that vapour condensation may result in the formation of an aerosol, or if particles are detected in a vapour atmosphere with potential for mixed phases (see paragraph 14).

PROCEDURE**Main test**

25. Three animals per sex, or six animals of the more susceptible sex, are used for each step. If rodent species other than rats are exposed nose-only, maximum exposure durations may be adjusted to minimise species-specific distress. The concentration level to be used as the starting dose is selected from one of four fixed levels and the starting concentration level should be that which is most likely to produce toxicity in some of the dosed animals. The testing schemes for gases, vapours and aerosols (included in Appendixes 2-4) represent the testing with the cut-off values of the CLP categories 1-4 (9) for gases (100, 500, 2 500, 20 000 ppm/4h) (Appendix 2), for vapours (0,5, 2, 10, 20 mg/l/4h) (Appendix 3) and for aerosols (0,05, 0,5, 1, 5 mg/l/4h) (Appendix 4). Category 5, which is not implemented in Regulation (EC) No 1272/2008 (9) relates to concentrations above the respective limit concentrations. For each starting concentration, the respective testing scheme applies. Depending on the number of humanely killed or dead animals, the test procedure follows the indicated arrows until a categorisation can be made.
26. The time interval between exposure groups is determined by the onset, duration, and severity of toxic signs. Exposure of animals at the next concentration level should be delayed until there is reasonable confidence in the survival of the previously tested animals. A period of three or four days between the exposures at each concentration level is recommended to allow for the observation of delayed toxicity. The time interval may be adjusted as appropriate, *e.g.* in case of inconclusive responses.

▼M4**Limit test**

27. The limit test is used when the test chemical is known or expected to be virtually non-toxic, i.e. eliciting a toxic response only above the regulatory limit concentration. Information about the toxicity of the test chemical can be gained from knowledge about similar tested substances or similar mixtures, taking into consideration the identity and percentage of components known to be of toxicological significance. In those situations where there is little or no information about its toxicity, or the test chemical is expected to be toxic, the main test should be performed [further guidance can be found in GD 39 (8)].
28. Using the normal procedure, three animals per sex, or six animals of the more susceptible sex, are exposed at concentrations of 20 000 ppm for gases, 20 mg/l for vapours and 5 mg/l for dusts/mists, respectively (if achievable), which serves as the limit test for this Test Method. When testing aerosols, the primary goal should be to achieve a respirable particle size (*i.e.* an MMAD of 1-4 µm). This is possible with most test chemicals at a concentration of 2 mg/l. Aerosol testing at greater than 2 mg/l should only be attempted if a respirable particle size can be achieved [see GD 39 (8)]. In accordance with GHS (16), testing in excess of a limit concentration is discouraged for animal welfare reasons. Testing in GHS Category 5 (16), which is not implemented in Regulation (EC) No 1272/2008 (9), should only be considered when there is a strong likelihood that results of such a test would have direct relevance for protecting human health, and justification provided in the study report. In the case of potentially explosive test chemicals, care should be taken to avoid conditions favourable for an explosion. To avoid an unnecessary use of animals, a test run without animals should be conducted prior to the limit test to ensure that the chamber conditions for a limit test can be achieved.

OBSERVATIONS

29. The animals should be clinically observed frequently during the exposure period. Following exposure, clinical observations should be made at least twice on the day of exposure, or more frequently when indicated by the response of the animals to treatment, and at least once daily thereafter for a total of 14 days. The length of the observation period is not fixed, but should be determined by the nature and time of onset of clinical signs and length of the recovery period. The times at which signs of toxicity appear and disappear are important, especially if there is a tendency for signs of toxicity to be delayed. All observations are systematically recorded with individual records being maintained for each animal. Animals found in a moribund condition and animals showing severe pain and/or enduring signs of severe distress should be humanely killed for animal welfare reasons. Care should be taken when conducting examinations for clinical signs of toxicity that initial poor appearance and transient respiratory changes, resulting from the exposure procedure, are not mistaken for treatment-related effects. The principles and criteria summarised in the Humane Endpoints Guidance Document should be taken into consideration (7). When animals are killed for humane reasons or found dead, the time of death should be recorded as precisely as possible.

▼ M4

30. Cage-side observations should include changes in the skin and fur, eyes and mucous membranes, and also respiratory, circulatory, autonomic and central nervous systems, and somato-motor activity and behaviour patterns. When possible, any differentiation between local and systemic effects should be noted. Attention should be directed to observations of tremors, convulsions, salivation, diarrhoea, lethargy, sleep and coma. The measurement of rectal temperatures may provide supportive evidence of reflex bradypnea or hypo/hyperthermia related to treatment or confinement.

Body weights

31. Individual animal weights should be recorded once during the acclimatisation period, on the day of exposure prior to exposure (day 0) and at least on days 1, 3 and 7 (and weekly thereafter), and at the time of death or euthanasia if exceeding day 1. Body weight is recognised as a critical indicator of toxicity and animals exhibiting a sustained decrement of $\geq 20\%$, compared to pre-study values, should be closely monitored. Surviving animals are weighed and humanely killed at the end of the post-exposure period.

Pathology

32. All test animals, including those which die during the test or are euthanised and removed from the study for animal welfare reasons, should be subjected to gross necropsy. If necropsy cannot be performed immediately after a dead animal is discovered, the animal should be refrigerated (not frozen) at temperatures low enough to minimize autolysis. Necropsies should be performed as soon as possible, normally within a day or two. All gross pathological changes should be recorded for each animal with particular attention to any changes in the respiratory tract.
33. Additional examinations included *a priori* by design may be considered to extend the interpretive value of the study, such as measuring lung weight of surviving rats and/or providing evidence of irritation by microscope examination of the respiratory tract. Examined organs may include those showing evidence of gross pathology in animals surviving 24 or more hours, and organs known or expected to be affected. Microscopic examination of the entire respiratory tract may provide useful information for test chemicals that are reactive with water, such as acids and hygroscopic test chemicals.

DATA AND REPORTING**Data**

34. Individual animal data on body weights and necropsy findings should be provided. Clinical observation data should be summarised in tabular form, showing for each test group the number of animals used, the number of animals displaying specific signs of toxicity, the number of animals found dead during the test or killed for humane reasons, time of death of individual animals, a description and time course of toxic effects and reversibility, and necropsy findings.

▼ M4**Test report**

35. The test report should include the following information, as appropriate:

Test animals and husbandry

- Description of caging conditions, including: number (or change in number) of animals per cage, bedding material, ambient temperature and relative humidity, photoperiod, and identification of diet;
- Species/strain used and justification for using a species other than the rat;
- Number, age, and sex of animals;
- Method of randomisation;
- Details of food and water quality (including diet type/source, water source);
- Description of any pre-test conditioning including diet, quarantine, and treatment for disease;

Test chemical

- Physical nature, purity, and, where relevant, physico-chemical properties (including isomerisation);
- Identification data and Chemical Abstract Services (CAS) Registry Number, if known;

Vehicle

- Justification for use of vehicle and justification for choice of vehicle (if other than water);
- Historical or concurrent data demonstrating that the vehicle does not interfere with the outcome of the study;

Inhalation chamber

- Description of the inhalation chamber including dimensions and volume;
- Source and description of equipment used for the exposure of animals as well as generation of atmosphere;
- Equipment for measuring temperature, humidity, particle-size, and actual concentration;
- Source of air, treatment of air supplied/extracted and system used for conditioning;
- Methods used for calibration of equipment to ensure a homogeneous test atmosphere;
- Pressure difference (positive or negative);
- Exposure ports per chamber (nose-only); location of animals in the system (whole-body);
- Temporal homogeneity/stability of test atmosphere;
- Location of temperature and humidity sensors and sampling of test atmosphere in the chamber;
- Air flow rates, air flow rate/exposure port (nose-only), or animal load/chamber (whole-body);
- Information about the equipment used to measure oxygen and carbon dioxide, if applicable;

▼ M4

- Time required to reach inhalation chamber equilibrium (t_{95});
- Number of volume changes per hour;
- Metering devices (if applicable);

Exposure data

- Rationale for target concentration selection in the main study;
- Nominal concentrations (total mass of test chemical generated into the inhalation chamber divided by the volume of air passed through the chamber);
- Actual test chemical concentrations collected from the animals' breathing zone; for test mixtures that produce heterogeneous physical forms (gases, vapours, aerosols), each may be analysed separately;
- All air concentrations should be reported in units of mass (e.g. mg/l, mg/m³, etc.), units of volume (e.g. ppm, ppb) may also be reported parenthetically;
- Particle size distribution, mass median aerodynamic diameter (MMAD), and geometric standard deviation (σ_g), including their methods of calculation. Individual particle size analyses should be reported;

Test conditions

- Details of test chemical preparation, including details of any procedures used to reduce the particle size of solid substances or to prepare solutions of the test chemical. In cases where mechanical processes may have altered test chemical composition, include the results of analyses to verify the composition of the test chemical;
- A description (preferably including a diagram) of the equipment used to generate the test atmosphere and to expose the animals to the test atmosphere;
- Details of the chemical analytical method used and method validation (including efficiency of recovery of test chemical from the sampling medium);
- The rationale for the selection of test concentrations;

Results

- Tabulation of chamber temperature, humidity, and airflow;
- Tabulation of chamber nominal and actual concentration data;
- Tabulation of particle size data including analytical sample collection data, particle size distribution, and calculations of the MMAD and σ_g ;
- Tabulation of response data and concentration level for each animal (i.e. animals showing signs of toxicity including mortality, nature, severity, and duration of effects);
- Individual body weights of animals collected on study days, date and time of death if prior to scheduled euthanasia; time course of onset of signs of toxicity, and whether these were reversible for each animal;

▼M4

- Necropsy findings and histopathological findings for each animal, if available;
- The CLP category classification and the LC₅₀ cut-off value;

Discussion and interpretation of results

- Particular emphasis should be made to the description of methods used to meet this Test Method's criteria, e.g. the limit concentration or the particle size;
- The respirability of particles in light of the overall findings should be addressed, especially if the particle-size criteria could not be met;
- The consistency of methods used to determine nominal and actual concentrations, and the relation of actual concentration to nominal concentration should be included in the overall assessment of the study;
- The likely cause of death and predominant mode of action (systemic versus local) should be addressed;
- An explanation should be provided if there was a need to humanely sacrifice animals in pain or showing signs of severe and enduring distress, based on the criteria in the OECD Guidance Document on Humane Endpoints (7).

LITERATURE:

- (1) Chapter B.2 of this Annex, Acute Toxicity (Inhalation).
- (2) Holzhütter H-G, Genschow E, Diener W, and Schlede E (2003). Dermal and Inhalation Acute Toxicity Class Methods: Test Procedures and Biometric Evaluations for the Globally Harmonized Classification System. *Arch. Toxicol.* 77: 243-254.
- (3) Diener W, Kayser D and Schlede E (1997). The Inhalation Acute-Toxic-Class Method; Test Procedures and Biometric Evaluations. *Arch. Toxicol.* 71: 537-549.
- (4) Diener W and Schlede E (1999). Acute Toxic Class Methods: Alternatives to LD/LC₅₀ Tests. *ALTEX* 1: 129-134.
- (5) Chapter B.1 tris of this Annex, Acute Oral Toxicity — Acute Toxic Class Method.
- (6) OECD (2009). Report on Biostatistical Performance Assessment of the Draft TG 436 Acute Toxic Class Testing Method for Acute Inhalation Toxicity. Environmental Health and Safety Monograph Series on Testing and Assessment No 105, OECD, Paris. Available at: [<http://www.oecd.org/env/testguidelines>]
- (7) OECD (2000). Guidance Document on the Recognition, Assessment and Use of Clinical Signs as Humane Endpoints for Experimental Animals Used in Safety Evaluation. Environmental Health and Safety Monograph Series on Testing and Assessment No 19. Available at: [<http://www.oecd.org/env/testguidelines>]
- (8) OECD (2009). Guidance Document on Acute Inhalation Toxicity Testing. Environmental Health and Safety Monograph Series on Testing and Assessment No 39, OECD, Paris. Available at: [<http://www.oecd.org/env/testguidelines>]
- (9) Regulation (EC) No 1272/2008 of the European Parliament and of the Council of 16 December 2008 on classification, labelling and packaging of substances and mixtures, amending and repealing Directives 67/548/EEC and 1999/45/EC, and amending Regulation (EC) No 1907/2006 (OJ L 353, 31.12.2008, p. 1).

▼M4

- (10) Chapter B.40 of this Annex, In Vitro Skin Corrosion: Transcutaneous Electrical Resistance Test (TER).
- (11) Chapter B.40 bis of this Annex, In Vitro Skin Corrosion: Human Skin Model Test.
- (12) OECD (2005). In Vitro Membrane Barrier Test Method for Skin Corrosion. OECD Guideline for testing of chemicals No 435, OECD, Paris. Available at: [<http://www.oecd.org/env/testguidelines>]
- (13) Phalen RF (2009). Inhalation Studies: Foundations and Techniques. (2nd Edition) Informa Healthcare, New York.
- (14) SOT (1992). Technical Committee of the Inhalation Specialty Section, Society of Toxicology (SOT). Recommendations for the Conduct of Acute Inhalation Limit Tests. *Fund. Appl. Toxicol.* 18: 321-327.
- (15) Pauluhn J and Thiel A (2007). A Simple Approach to Validation of Directed-Flow Nose-Only Inhalation Chambers. *J. Appl. Toxicol.* 27: 160-167
- (16) UN (2007), United Nations Globally Harmonized System of Classification and Labelling of Chemicals (GHS), ST/SG/AC.10/30, UN New York and Geneva. Available: [http://www.unece.org/trans/danger/publi/ghs/ghs_welcome_e.html]

▼ M4

Appendix 1

DEFINITION

Test chemical: Any substance or mixture tested using this Test Method.

▼ M4*Appendix 2***Procedure to be followed by each of the starting concentrations for gases (ppm/4h)**General remarks ⁽¹⁾

For each starting concentration, the respective testing schemes as included in this Appendix outline the procedure to be followed.

Appendix 2a: Starting concentration is 100 ppm

Appendix 2b: Starting concentration is 500 ppm

Appendix 2c: Starting concentration is 2 500 ppm

Appendix 2d: Starting concentration is 20 000 ppm

Depending on the number of humanely killed or dead animals, the test procedure follows the indicated arrows.

⁽¹⁾ In the following tables reference is made to GHS (Globally Harmonised System of Classification and Labelling of Chemicals (GHS). The EU equivalent is Regulation (EC) No 1272/2008. In the case of Acute Inhalation Toxicity, the Regulation (EC) No 1272/2008 (9) does not implement Category 5.

▼ **M4**

Appendix 2a

Acute Inhalation Toxicity:

Test Procedure with a starting concentration of 100 ppm/4h for gases

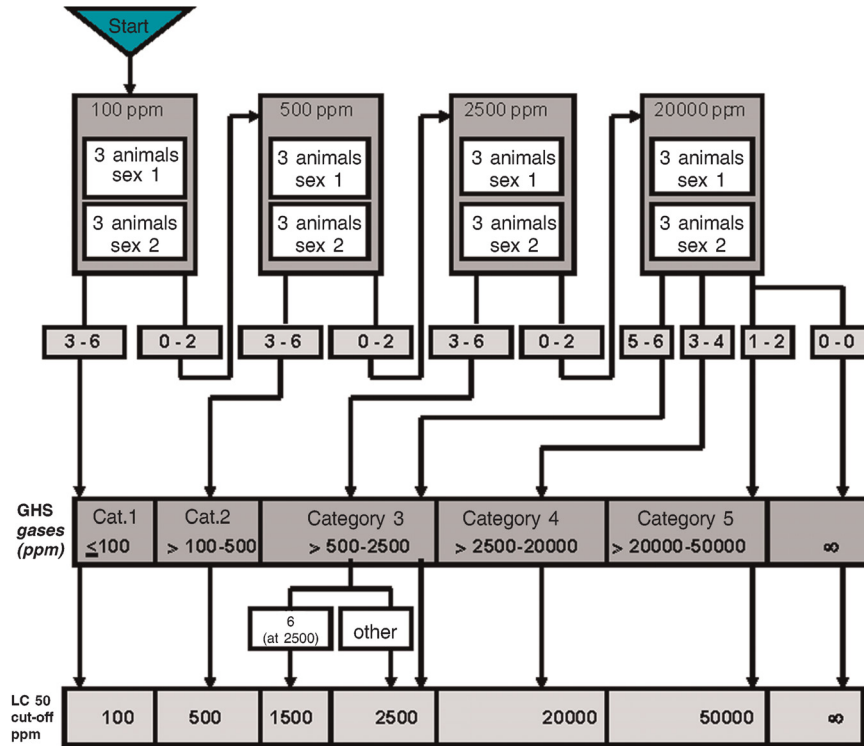

- 3 ♂ + 3 ♀, or 6 animals of the more susceptible sex are used per step
- 0-6: Number of moribund or dead animals/tested concentration
- GHS: Globally Harmonized Classification System
- ∞: unclassified
- Testing at ≥ 20000 ppm/4h: see Guidance Document 39 (8)

▼ **M4**

Appendix 2b

Acute Inhalation Toxicity:

Test Procedure with a starting concentration of 500 ppm/4h for gases

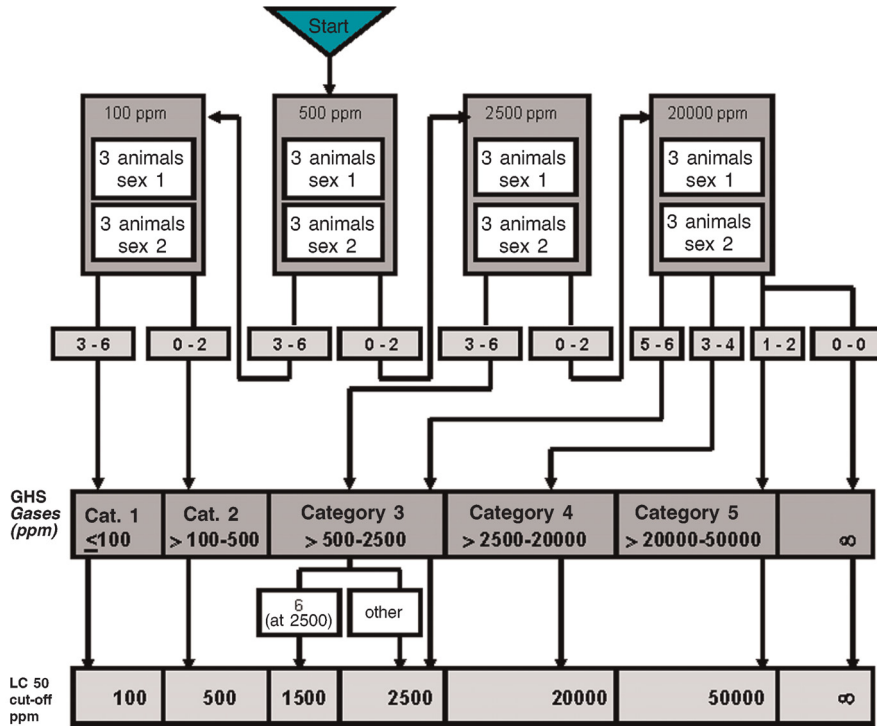

- 3 ♂ + 3 ♀, or 6 animals of the more susceptible sex are used per step
- 0-6: Number of moribund or dead animals/tested concentration
- GHS: Globally Harmonized Classification System
- ∞: unclassified
- Testing at ≥ 20000 ppm/4h: see Guidance Document 39 (8)

▼ **M4**

Appendix 2c

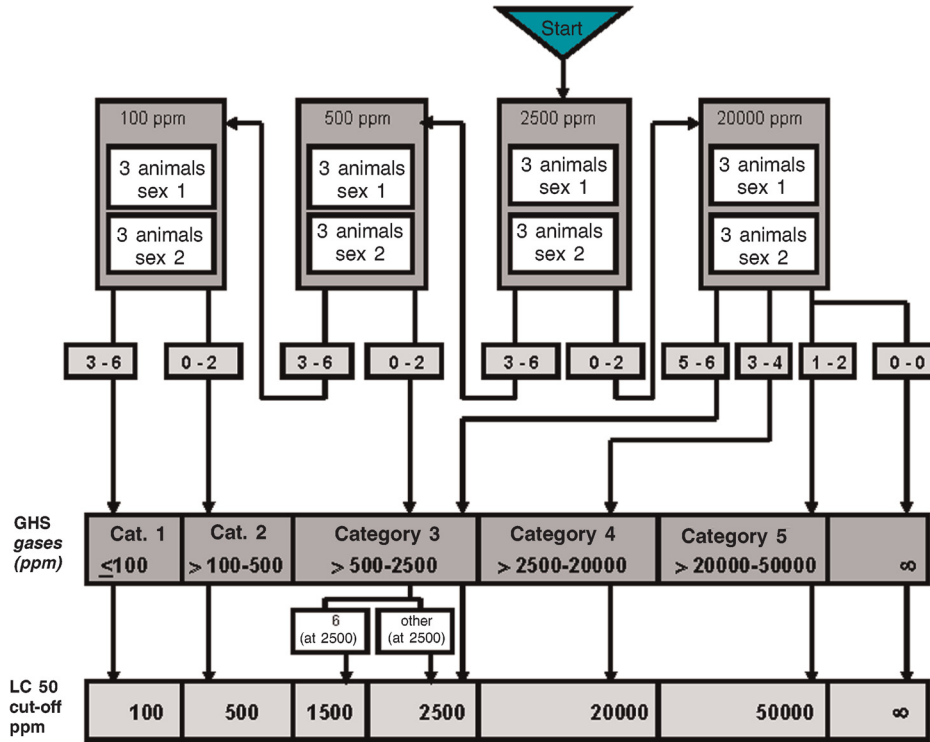
Acute Inhalation Toxicity:**Test Procedure with a starting concentration of 2 500 ppm/4h
for gases**

- 3 ♂ + 3 ♀, or 6 animals of the more susceptible sex are used per step
- 0-6: Number of moribund or dead animals/tested concentration
- GHS: Globally Harmonized Classification System
- ∞: unclassified
- Testing at ≥ 20000 ppm/4h: see Guidance Document 39 (8)

▼ **M4**

Appendix 2d

Acute Inhalation Toxicity:

Test Procedure with a starting concentration of 20 000 ppm/4h for gases

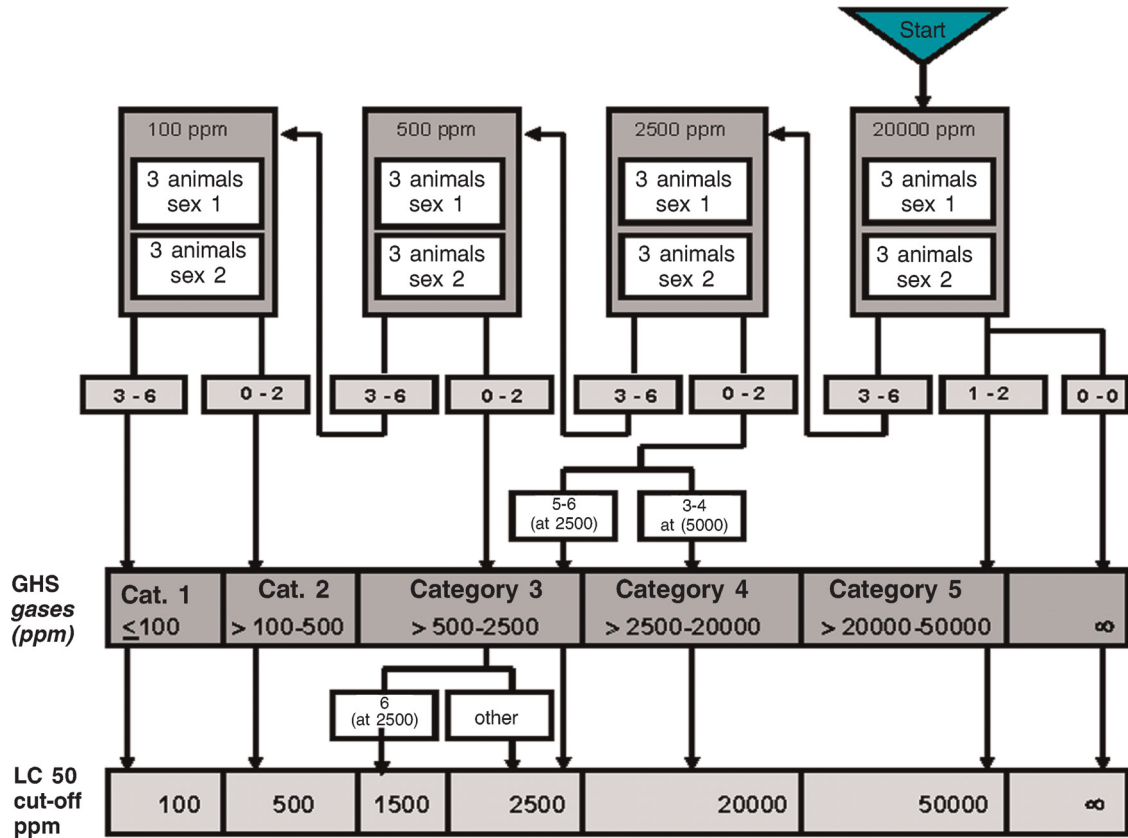

- 3 σ + 3 ϕ , or 6 animals of the more susceptible sex are used per step
- 0-6: Number of moribund or dead animals/tested concentraion
- GHS: Globally Harmonized Classification System
- ∞ : unclassified
- Testing at ≥ 20000 ppm/4h: see Guidance Document 39 (8)

▼M4*Appendix 3***Procedure to be followed by each of the starting concentrations for vapour (mg/l/4h)**General remarks ⁽¹⁾

For each starting concentration, the respective testing schemes as included in this Appendix outline the procedure to be followed.

Appendix 3a: Starting concentration is 0,5 mg/l

Appendix 3b: Starting concentration is 2,0 mg/l

Appendix 3c: Starting concentration is 10 mg/l

Appendix 3d: Starting concentration is 20 mg/l

Depending on the number of humanely killed or dead animals, the test procedure follows the indicated arrows.

⁽¹⁾ In the following tables reference is made to GHS (Globally Harmonised System of Classification and Labelling of Chemicals (GHS). The EU equivalent is Regulation (EC) No 1272/2008. In the case of Acute Inhalation Toxicity, the Regulation (EC) No 1272/2008 (9) does not implement Category 5.

▼ **M4**

Appendix 3a

Acute Inhalation Toxicity:

Test procedure with a starting concentration of 0,5 mg/L/4h for vapours

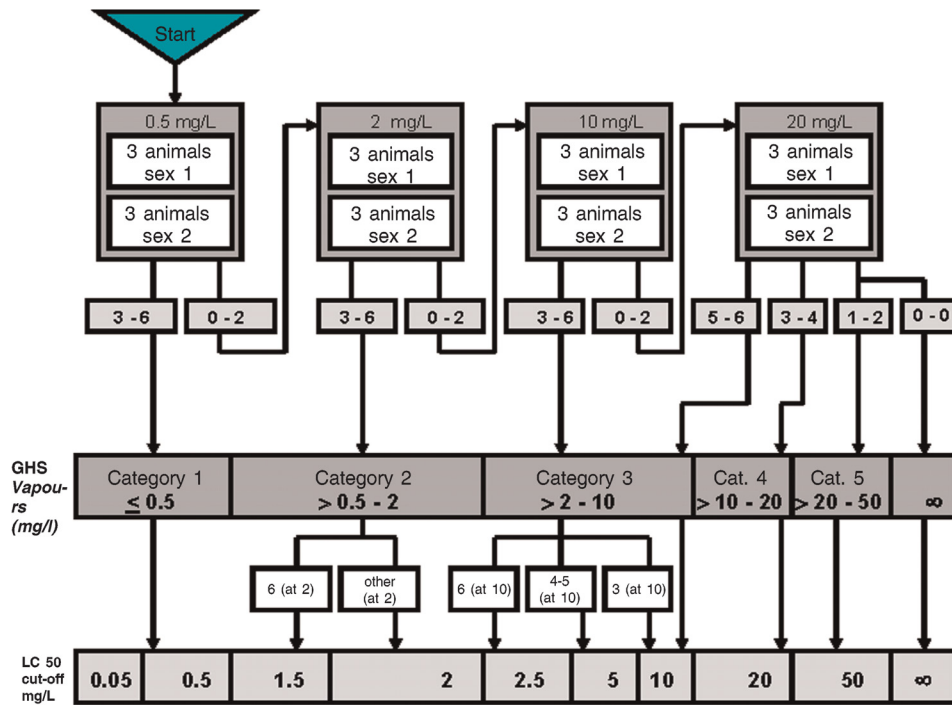

- 3 ♂ + 3 ♀, or 6 animals of the more susceptible sex are used per step
- 0-6: Number of moribund or dead animals/tested concentration
- GHS: Globally Harmonized Classification System
- ∞: unclassified
- Testing at 50 mg/L/4h: see Guidance Document 39 (8)

▼ M4

Appendix 3b

Acute Inhalation Toxicity:

Test procedure with a starting concentration of 2 mg/L/4h for vapours

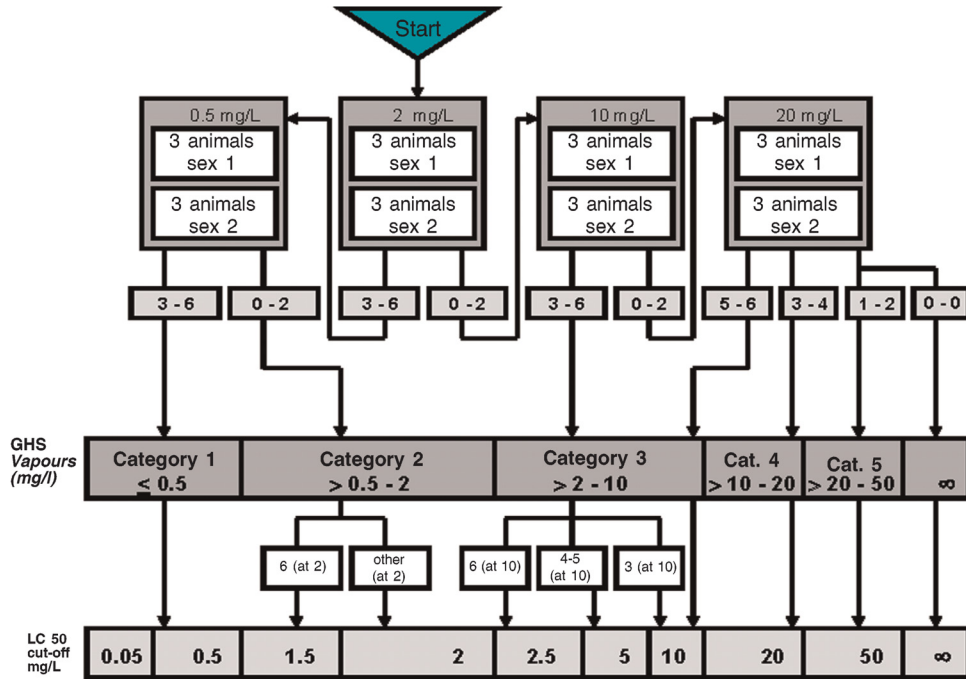

- 3 ♂ + 3 ♀, or 6 animals of the more susceptible sex are used per step
- 0-6: Number of moribund or dead animals/tested concentration
- GHS: Globally Harmonized Classification System
- ∞: unclassified
- Testing at 50 mg/L/4h: see Guidance Document 39 (8)

▼ **M4**

Appendix 3c

Acute Inhalation Toxicity:

Test procedure with a starting concentration of 10 mg/L/4h for vapours

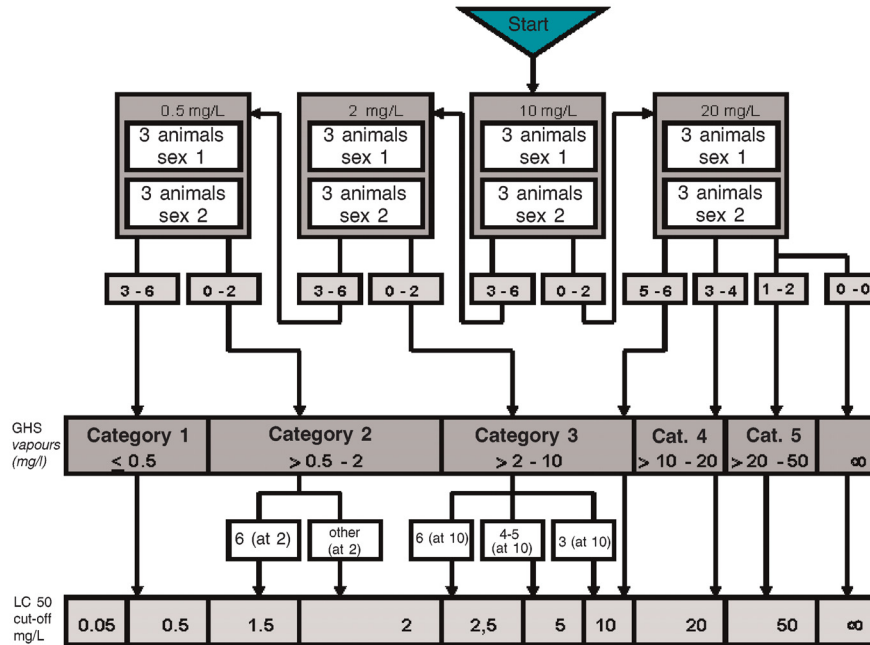

- 3 ♂ + 3 ♀, or 6 animals of the more susceptible sex are used pers step
- 0-6: Number of moribund or dead animals/tested concentraion
- GHS: Globally Harmonized Classification System
- ∞: unclassified
- Testing at 50 mg/L/4h: see Guidance Document 39 (8)

▼ **M4**

Appendix 3d

Acute Inhalation Toxicity:

Test procedure with a starting concentration of 20 mg/L/4h for vapours

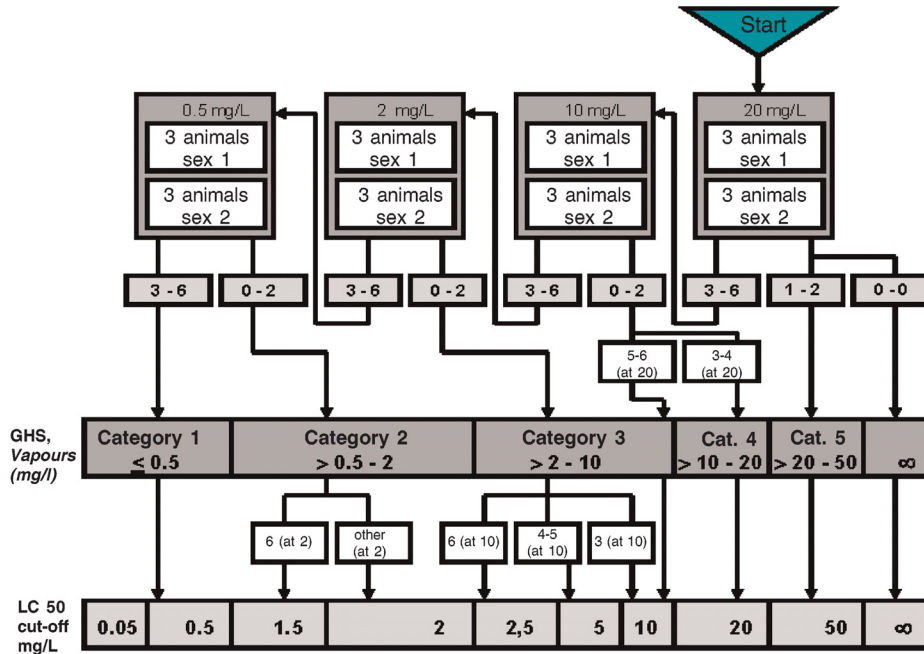

- 3 ♂ + 3 ♀, or 6 animals of the more susceptible sex are used per step
- 0-6: Number of moribund or dead animals/tested concentraion
- GHS: Globally Harmonized Classification System
- ∞: unclassified
- Testing at 50 mg/L/4h: see Guidance Document 39(8)

▼ M4*Appendix 4***Procedure to be followed by each of the starting concentrations for aerosols (mg/l/4h)**General remarks ⁽¹⁾

For each starting concentration, the respective testing schemes as included in this Appendix outline the procedure to be followed.

Appendix 4a: Starting concentration is 0,05 mg/l

Appendix 4b: Starting concentration is 0,5 mg/l

Appendix 4c: Starting concentration is 1 mg/l

Appendix 4d: Starting concentration is 5 mg/l

Depending on the number of humanely killed or dead animals, the test procedure follows the indicated arrows.

⁽¹⁾ In the following tables reference is made to GHS (Globally Harmonised System of Classification and Labelling of Chemicals (GHS). The EU equivalent is Regulation (EC) No 1272/2008. In the case of Acute Inhalation Toxicity the Regulation (EC) No 1272/2008 (9) does not implement Category 5.

▼ **M4**

Appendix 4a

Acute Inhalation Toxicity:

Test procedure with a starting concentration of 0,05 mg/L/4h for aerosols

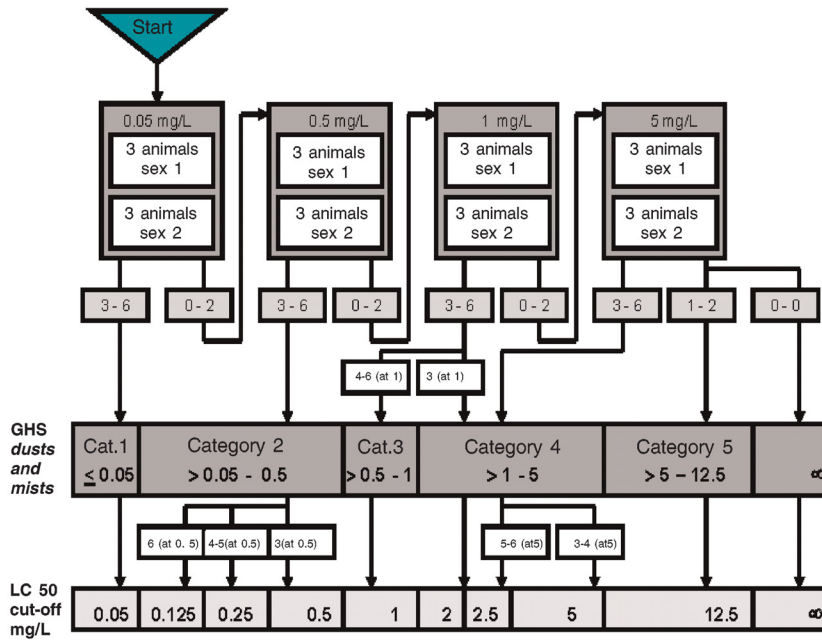

- 3 ♂ + 3 ♀, or 6 animals of the more susceptible sex are used per step
- 0-6: Number of moribund or dead animals/tested concentraion
- GHS: Globally Harmonized Classification System
- ∞: unclassified
- Testing at 12.5 mg/L/4h: see Guidance Document 39 (8)

▼ **M4**

Appendix 4b

Acute Inhalation Toxicity:

Test procedure with a starting concentration of 0,5 mg/L/4h for aerosols

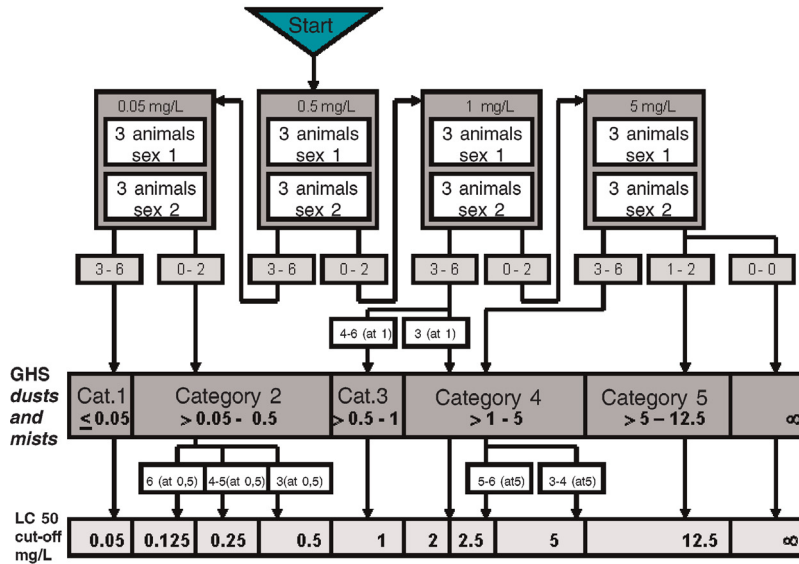

- 3 ♂ + 3 ♀, or 6 animals of the more susceptible sex are used per step
- 0-6: Number of moribund or dead animals/tested concentraion
- GHS: Globally Harmonized Classification System
- ∞: unclassified
- Testing at 12.5 mg/L4h: see Guidance Document 39 (8)

▼ **M4**

Appendix 4c

Acute Inhalation Toxicity:

Test procedure with a starting concentration of 1 mg/L/4h for aerosols

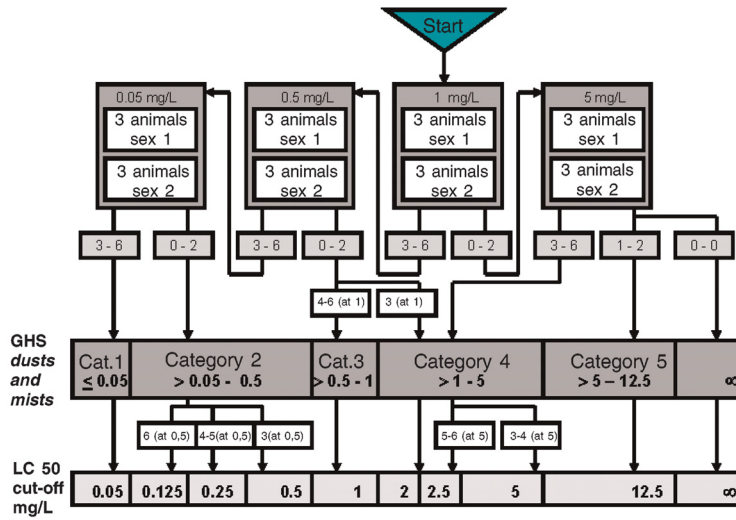

- 3 ♂ + 3 ♀, or 6 animals of the more susceptible sex are used per step
- 0-6: Number of moribund or dead animals/tested concentration
- GHS: Globally Harmonized Classification System
- ∞: unclassified
- Testing at 12.5 mg/L4h: see Guidance Document 39 (8)

▼ **M4***Appendix 4d***Acute Inhalation Toxicity:**

Test procedure with a starting concentration of 5 mg/L/4h for aerosols

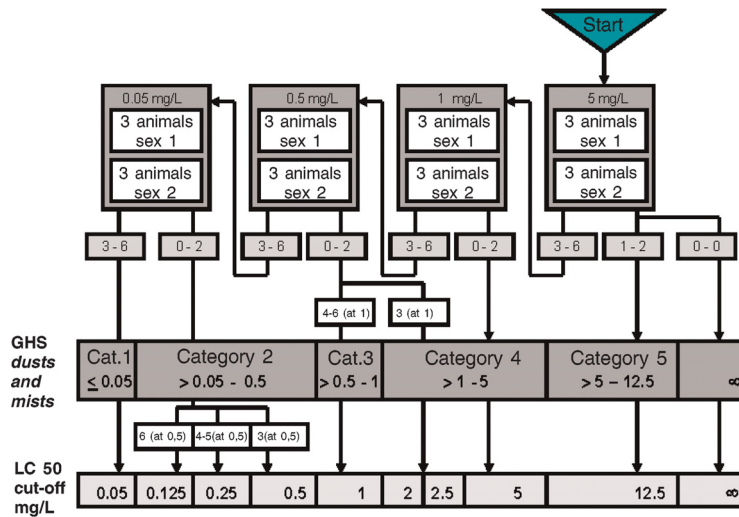

- 3 ♂ + 3 ♀, or 6 animals of the more susceptible sex are used per step
- 0-6 : Number of moribund or dead animals/tested concentration
- GHS: Globally Harmonized Classification System
- ∞: unclassified
- Testing at 12.5 mg/L/4h: see Guidance Document 39 (8)

▼ **M5****B.53 DEVELOPMENTAL NEUROTOXICITY STUDY**

INTRODUCTION

1. This test method is equivalent to OECD Test Guideline (TG) 426 (2007). In Copenhagen in June 1995, an OECD Working Group on Reproduction and Developmental Toxicity discussed the need to update existing OECD test guidelines for reproduction and developmental toxicity, and the development of new guidelines for endpoints not yet covered (1). The working group recommended that a test guideline for developmental neurotoxicity should be written based on a US EPA guideline, which has since been revised (2). In June 1996, a second consultation meeting was held in Copenhagen to provide the Secretariat with guidance on the outline of a new test guideline on developmental neurotoxicity, including the major elements, e.g. details concerning choice of animal species, dosing period, testing period, endpoints to be assessed, and criteria for evaluating results. A US neurotoxicity risk assessment guideline was published in 1998 (3). An OECD Expert Consultation Meeting and an ILSI Risk Science Institute Workshop were held back-to-back in October 2000 and an expert consultation meeting was held in Tokyo 2005. These meetings were held to discuss the scientific and technical issues related to the current test guideline and the recommendations from the meetings (4)(5)(6)(7) were considered in the development of this test method. Additional information on the conduct, interpretation and terminology used for this test method can be found in OECD Guidance Documents No 43 on 'Reproductive Toxicity Testing and Assessment' (8) and No 20 on 'Neurotoxicity Testing' (9).

INITIAL CONSIDERATIONS

2. A number of chemicals is known to produce developmental neurotoxic effects in humans and other species (10)(11)(12)(13). Determination of the potential for developmental neurotoxicity may be needed to assess and evaluate the toxic characteristics of a chemical. Developmental neurotoxicity studies are designed to provide data, including dose-response characterisations, on the potential functional and morphological effects on the developing nervous system of the offspring that may arise from exposure in utero and during early life.
3. A developmental neurotoxicity study can be conducted as a separate study, incorporated into a reproductive toxicity and/or adult neurotoxicity study (e.g. test methods B.34 (14), B.35 (15), B.43 (16)), or added onto a prenatal developmental toxicity study (e.g. test method B.31 (17)). When the developmental neurotoxicity study is incorporated within or attached to another study, it is imperative to preserve the integrity of both study types. All testing should comply with applicable legislation or government and institutional guidelines for the use of laboratory animals in research (e.g. 18).
4. The testing laboratory should consider all available information on the test chemical prior to conducting the study. Such information will include the identity and structure of the chemical; its physico-chemical properties; the results of any other *in vitro* or *in vivo* toxicity tests on the chemical; toxicological data on structurally related chemicals; and the anticipated use(s) of the chemical. This information is necessary to satisfy all concerned that the test is relevant for the protection of human health, and will help in the selection of an appropriate starting dose.

▼ M5

PRINCIPLE OF THE TEST

5. The test chemical is administered to animals during gestation and lactation. Dams are tested to assess effects in pregnant and lactating females and may also provide comparative information (dams versus offspring). Offspring are randomly selected from within litters for neurotoxicity evaluation. The evaluation consists of observations to detect gross neurologic and behavioural abnormalities, including the assessment of physical development, behavioural ontogeny, motor activity, motor and sensory function, and learning and memory; and the evaluation of brain weights and neuropathology during postnatal development and adulthood.

6. When the test method is conducted as a separate study, additional available animals in each group could be used for specific neurobehavioral, neuropathological, neurochemical or electrophysiological procedures that may supplement the data obtained from the examinations recommended by this test method (16)(19)(20)(21). The supplemental procedures can be particularly useful when empirical observation, anticipated effects, or mechanism/mode-of-action indicate a specific type of neurotoxicity. These supplemental procedures may be used in the dams as well as in the pups. In addition, *ex vivo* or *in vitro* procedures may also be used, as long as these procedures do not alter the integrity of the *in vivo* procedures.

PREPARATIONS FOR THE TEST

Selection of animal species

7. The preferred test species is the rat; other species can be used when appropriate. Note, however, the gestational and postnatal days specified in this test method are specific to commonly used strains of rats, and comparable days should be selected if a different species or unusual strain is used. The use of another species should be justified based on toxicological, pharmacokinetic, and/or other data. Justification should include availability of species-specific postnatal neurobehavioral and neuropathological assessments. If there was an earlier test that raised concerns, the species/strain that raised a concern should be considered. Because of the differing performance attributes of different rat strains, there should be evidence that the strain selected for use has adequate fecundity and responsiveness. The reliability and sensitivity of other species to detect developmental neurotoxicity should be documented.

Housing and feeding conditions

8. The temperature in the experimental animal room should be 22 ± 3 °C. Although the relative humidity should be at least 30 % and preferably not exceed 70 % other than during room cleaning, the aim should be 50-60 %. Lighting should be artificial, the sequence being 12 hours light, 12 hours dark. It is also possible to reverse the light cycle prior to mating and for the duration of the study, in order to perform the assessments of functional and behavioural endpoints during the dark period (under red light), i.e. during the time the animals are normally active (22). Any changes in the light-dark cycle should include adequate acclimation time to allow animals to adapt to the new cycle. For feeding, conventional laboratory diets may be used with an unlimited supply of drinking water. The type of food and water should be reported and both should be analysed for contaminants.

▼ M5

9. Animals may be housed individually or be caged in small groups of the same sex. Mating procedures should be carried out in cages suitable for the purpose. After evidence of copulation or no later than day 15 of pregnancy, mated animals should be caged separately in delivery or maternity cages. Cages should be arranged in such a way that possible effects due to cage placement are minimised. Mated females should be provided with appropriate and defined nesting materials when parturition is near. It is well known that inappropriate handling or stress during pregnancy can result in adverse outcomes, including prenatal loss and altered foetal and postnatal development. To guard against foetal loss from factors which are not treatment-related, animals should be carefully handled during pregnancy, and stress from outside factors such as excessive outside noise should be avoided.

Preparation of the animals

10. Healthy animals should be used, which have been acclimated to laboratory conditions and have not been subjected to previous experimental procedures, unless the study is incorporated in another study (see paragraph 3). The test animals should be characterised as to species, strain, source, sex, weight and age. Each animal should be assigned and marked with a unique identification number. The animals of all test groups should, as nearly as practicable, be of uniform weight and age, and should be within the normal range of the species and strain under study. Young adult nulliparous female animals should be used at each dose level. Siblings should not be mated, and care should be taken to ensure this. Gestation Day (GD) 0 is the day on which a vaginal plug and/or sperm are observed. Adequate acclimation time (e.g. 2-3 days) should be allowed when purchasing time-pregnant animals from a supplier. Mated females should be assigned in an unbiased way to the control and treatment groups, and as far as possible, they should be evenly distributed among the groups (e.g. a stratified random procedure is recommended to provide even distribution among all groups, such as that based on body weight). Females inseminated by the same male should be equalised across groups.

PROCEDURE**Number and sex of animals**

11. Each test and control group should contain a sufficient number of pregnant females to be exposed to the test chemical to ensure that an adequate number of offspring are produced for neurotoxicity evaluation. A total of 20 litters are recommended at each dose level. Replicate and staggered-group dosing designs are allowed if total numbers of litters per group are achieved, and appropriate statistical models are used to account for replicates.
12. On or before postnatal day (PND) 4 (day of delivery is PND 0), the size of each litter should be adjusted by eliminating extra pups by random selection to yield a uniform litter size for all litters (23). The litter size should not exceed the average litter size for the strain of rodents used (8-12). The litter should have, as nearly as possible, equal numbers of male and female pups. Selective elimination of pups, e.g. based upon body weight, is not appropriate. After standardisation of litters (culling) and prior to further testing of functional endpoints, individual pups that are scheduled for pre-weaning or post-weaning testing should be identified uniquely, using any suitable humane method for pup identification (e.g. 24).

▼ **M5****Assignment of animals for functional and behavioural tests, brain weights, and neuropathological evaluations**

13. The test method allows various approaches with respect to the assignment of animals exposed *in utero* and through lactation to functional and behavioural tests, sexual maturation, brain weight determination, and neuropathological evaluation (25). Other tests of neurobehavioral function (e.g. social behaviour), neurochemistry or neuropathology can be added on a case-by-case basis, as long as the integrity of the original required tests are not compromised.
14. Pups are selected from each dose group and assigned for endpoint assessments on or after PND 4. Selection of pups should be performed so that to the extent possible both sexes from each litter in each dose group are equally represented in all tests. For motor activity testing the same pair of male and female pups should be tested at all pre-weaning ages (see paragraph 35). For all other tests the same or separate pairs of male and female animals may be assigned to different behavioural tests. Different pups may need to be assigned to weanling versus adult tests of cognitive function in order to avoid confounding the effects of age and prior training on these measurements (26)(27). At weaning (PND 21), pups not selected for testing can be disposed of humanely. Any alterations in pup assignments should be reported. The statistical unit of measure should be the litter (or dam) and not the pup.
15. There are different ways to assign pups to the pre-weaning and post-weaning examinations, cognitive tests, pathological examinations, etc., (see Figure 1 for general design and Appendix 1 for examples of assignment). Recommended minimum numbers of animals in each dose group for pre-weaning and post-weaning examinations are as follows:

Clinical observations and bodyweight	All animals
Detailed clinical observations	20/sex (1/sex/litter)
Brain weight (post fixation) PND 11-22	10/sex (1/litter)
Brain weight (unfixed) ~ PND 70	10/sex (1/litter)
Neuropathology (immersion or perfusion fixation) PND 11-22	10/sex (1/litter)
Neuropathology (perfusion fixation) PND ~ 70	10/sex (1/litter)
Sexual maturation	20/sex (1/sex/litter)
Other developmental landmarks (optional)	All animals
Behavioural ontogeny	20/sex (1/sex/litter)
Motor activity	20/sex (1/sex/litter)
Motor and sensory function	20/sex (1/sex/litter)
Learning and memory	10/sex ^(a) (1/litter)

^(a) Depending on the sensitivity of cognitive function tests, investigation of a large higher number of animals should be considered e.g. up to 1 male and 1 female per litter (for animal assignments see Appendix 1) (further guidance on sample size is provided in the OECD Guidance Document 43 (8)).

▼ M5**Dosage**

16. At least three dose levels and a concurrent control should be used. The dose levels should be spaced to produce a gradation of toxic effects. Unless limited by the physico-chemical nature or biological properties of the chemical, the highest dose level should be chosen with the aim to induce some maternal toxicity (e.g. clinical signs, decreased body weight gain (not more than 10 %) and/or evidence of dose-limiting toxicity in a target organ). The high dose may be limited to 1 000 mg/kg/day body weight, with some exceptions. For example, expected human exposure may indicate the need for a higher dose level to be used. Alternatively, pilot studies or preliminary range-finding studies should be performed to determine the highest dosage to be used which should produce a minimal degree of maternal toxicity. If the test chemical has been shown to be developmentally toxic either in a standard developmental toxicity study or in a pilot study, the highest dose level should be the maximum dose which will not induce excessive offspring toxicity, or *in utero* or neonatal death or malformations, sufficient to preclude a meaningful evaluation of neurotoxicity. The lowest dose level should aim to not produce any evidence of either maternal or developmental toxicity including neurotoxicity. A descending sequence of dose levels should be selected with a view to demonstrating any dose-related response and a No-Observed-Adverse Effect Level (NOAEL), or doses near the limit of detection that would allow the determination of a benchmark dose. Two- to four-fold intervals are frequently optimal for setting the descending dose levels, and the addition of a fourth dose group is often preferable to using very large intervals (e.g. more than a factor of 10) between dosages.

17. Dose levels should be selected taking into account all existing toxicity data as well as additional information on metabolism and toxicokinetics of the test chemical or related materials. This information may also assist in demonstrating the adequacy of the dosing regimen. Direct dosing of pups should be considered based on exposure and pharmacokinetic information (28)(29). Careful consideration of benefits and disadvantages should be made prior to conducting direct dosing studies (30).

18. The concurrent control group should be a sham-treated control group or a vehicle-control group if a vehicle is used in administering the test chemical. All animals should normally be administered the same volume of either test chemical or vehicle on a body weight basis. If a vehicle or other additive is used to facilitate dosing, consideration should be given to the following characteristics: effects on the absorption, distribution, metabolism, or retention of the test chemical; effects on the chemical properties of the test chemical which may alter its toxic characteristics; and effects on the food or water consumption or the nutritional status of the animals. The vehicle should not cause effects that could interfere with the interpretation of the study neither should it be neurobehaviourally toxic nor have effects on reproduction or development. For novel vehicles, a sham-treated control group should be included in addition to a vehicle control group. Animals in the control group(s) should be handled in an identical manner to test group animals.

▼ M5**Administration of doses**

19. The test chemical or vehicle should be administered by the route most relevant to potential human exposure, and based on available metabolism and distribution information in the test animals. The route of administration will generally be oral (e.g. gavage, dietary, via drinking water), but other routes (e.g. dermal, inhalation) may be used depending on the characteristics and anticipated or known human exposure routes (further guidance is provided in the Guidance Document 43(8)). Justification should be provided for the route of administration chosen. The test chemical should be administered at approximately the same time every day.

20. The dose administered to each animal should normally be based on the most recent individual body weight determination. However, caution should be exercised when adjusting the doses during the last third of pregnancy. If excess toxicity is noted in the treated dams, those animals should be humanely killed.

21. The test chemical or vehicle should, as a minimum, be administered daily to mated females from the time of implantation (GD 6) throughout lactation (PND 21), so that the pups are exposed to the test chemical during pre- and postnatal neurological development. The age at which dosing starts, and the duration and frequency of dosing, may be adjusted if evidence supports an experimental design more relevant to human exposures. Dosing durations should be adjusted for other species to ensure exposure during all early periods of brain development (i.e. equivalent to prenatal and early postnatal human brain growth). Dosing may begin from the initiation of pregnancy (GD 0) although consideration should be given to the potential of the test chemical to cause pre-implantation loss. Administration beginning at GD 6 would avoid this risk, but the developmental stages between GD 0 and 6 would not be treated. When a laboratory purchases time-mated animals, it is impractical to begin dosing at GD 0, and thus GD 6 would be a good starting day. The testing laboratory should set the dosing regimen according to relevant information about the effects of the test chemical, prior experience, and logistical considerations; this may include extension of dosing past weaning. Dosing should not occur on the day of parturition in those animals which have not completely delivered their offspring. In general, it is assumed that exposure of the pups will occur through the maternal milk; however, direct dosing of pups should be considered in those cases where there is a lack of evidence of continued exposure to offspring. Evidence of continuous exposure can be retrieved from e.g. pharmacokinetic information, offspring toxicity or changes in bio-markers (28).

OBSERVATIONS**Observations on dams**

22. All dams should be carefully observed at least once daily with respect to their health condition, including morbidity and mortality.

23. During the treatment and observation periods, more detailed clinical observations should be conducted periodically (at least twice during the gestational dosing period and twice during the lactational dosing period) using at least 10 dams per dose level. The animals should be observed outside the home cage by trained technicians who are unaware of the animals' treatment, using standardised procedures to minimise animal stress and observer bias, and maximise inter-observer reliability. Where possible, it is advisable that the observations in a given study be made by the same technician.

▼ M5

24. The presence of observed signs should be recorded. Whenever feasible, the magnitude of the observed signs should also be recorded. Clinical observations should include, but not be limited to, changes in skin, fur, eyes, mucous membranes, occurrence of secretions, and autonomic activity (e.g. lacrimation, piloerection, pupil size, unusual respiratory pattern and/or mouth breathing, and any unusual signs of urination or defecation).
25. Any unusual responses with respect to body position, activity level (e.g. decreased or increased exploration of the standard area) and co-ordination of movement should also be noted. Changes in gait, (e.g. waddling, ataxia), posture (e.g. hunched-back) and reactivity to handling, placing or other environmental stimuli, as well as the presence of clonic or tonic movements, convulsions, tremors, stereotypies (e.g. excessive grooming, unusual head movements, repetitive circling), bizarre behaviour (e.g. biting or excessive licking, self-mutilation, walking backwards, vocalisation), or aggression should be recorded.
26. Signs of toxicity should be recorded, including the day of onset, time of day, degree, and duration.
27. Animals should be weighed at the time of dosing at least weekly throughout the study, on or near the day of delivery, and on PND 21 (weaning). For gavage studies dams should be weighed at least twice weekly. Doses should be adjusted at the time of each body weight determination, as appropriate. Food consumption should be measured weekly at a minimum during gestation and lactation. Water consumption should be measured at least weekly if exposure is via the water supply.

Observations on offspring

28. All offspring should be carefully observed at least daily for signs of toxicity and for morbidity and mortality.
29. During the treatment and observation periods, more detailed clinical observations of the offspring should be conducted. The offspring (at least one pup/sex/litter) should be observed by trained technicians who are unaware of the animals' treatment, using standardised procedures to minimise bias and maximise inter-observer reliability. Where possible, it is advisable that the observations are made by the same technician. At a minimum, the endpoints described in paragraphs 24 and 25 should be monitored as appropriate for the developmental stage being observed.
30. All signs of toxicity in the offspring should be recorded, including the day of onset, time of day, degree, and duration.

Physical and developmental landmarks

31. Changes in pre-weaning landmarks of development (e.g. pinna unfolding, eye opening, incisor eruption) are highly correlated with body weight (30)(31). Body weight may be the best indicator of physical development. Measurement of developmental landmarks is, therefore, recommended only when there is prior evidence that these endpoints will provide additional information. Timing for the assessment of these parameters is indicated in Table 1. Depending on the anticipated effects, and the results of the initial measurements, it may be advisable to add additional time points or to perform the measurements in other developmental stages.

▼ **M5**

32. It is advisable to use post-coital age instead of postnatal age when assessing physical development (33). If pups are tested on the day of weaning, it is recommended that this testing be carried out prior to actual weaning to avoid a confounding effect by the stress associated with weaning. In addition, any post-weaning testing of pups should not occur during the two days after weaning.

Table 1

Timing of the assessment of physical and developmental landmarks, and functional/behavioural endpoints (a)

Age Periods Endpoints	Pre-weaning (b)	Adolescence (b)	Young adults (b)
--------------------------	-----------------	-----------------	------------------

Physical and developmental landmarks

Body weight and Clinical Observations	weekly (c)	at least every two weeks	at least every two weeks
Brain weight	PND 22 (d)		at termination
Neuropathology	PND 22 (d)		at termination
Sexual maturation	—	as appropriate	—
Other developmental landmarks (e)	as appropriate	—	—

Functional/behavioural endpoints

Behavioural ontogeny	At least two measures		
Motor activity (including habituation)	1–3 times (f)	—	once
Motor and sensory function	—	once	once
Learning and memory	—	once	once

(a) This table presents the minimum number of times when measurements should be performed. Depending on the anticipated effects, and the results of the initial measurements, it may be advisable to add additional time points (e.g. aged animals) or to perform the measurements in other developmental stages.

(b) It is recommended that pups not be tested during the two days after weaning (see paragraph 32). Recommended ages for adolescent testing are: learning and memory = PND 25 ± 2; motor and sensory function = PND 25 ± 2. Recommended ages for testing young adults is PND 60-70.

(c) Body weights should be measured at least twice weekly when directly dosing pups for adjustment of doses at a time of rapid body weight gain.

(d) Brain weights and neuropathology may be assessed at some earlier time (e.g. PND 11), if appropriate (see paragraph 39).

(e) Other developmental landmarks in addition to the body weight (e.g. eye opening) should be recorded when appropriate (see paragraph 31).

(f) See paragraph 35.

33. Live pups should be counted and sexed e.g. by visual inspection or measurement of anogenital distance (34)(35), and each pup within a litter should be weighed individually at birth or soon thereafter, at least weekly throughout lactation, and at least once every two weeks thereafter. When sexual maturation is evaluated, the age and body weight of the animal when vaginal patency (36) or preputial separation (37) occurs should be determined for at least one male and one female per litter.

▼ M5**Behavioural ontogeny**

34. Ontogeny of selected behaviours should be measured in at least one pup/sex/litter during the appropriate age period, with the same pups being used on all test days for all behaviours assessed. The measurement days should be spaced evenly over that period to define either the normal or treatment-related change in ontogeny of that behaviour (38). The following are some examples of behaviours for which their ontogeny could be assessed: righting reflex, negative geotaxis and motor activity (38)(39)(40).

Motor activity

35. Motor activity should be monitored (41)(42)(43)(44)(45) during the pre-weaning and adult age periods. For testing at the time of weaning, see paragraph 32. The test session should be long enough to demonstrate intra-session habituation for non-treated controls. Use of motor activity to assess behavioural ontogeny is strongly recommended. If used as a test of behavioural ontogeny, then testing should utilise the same animals for all pre-weaning test sessions. Testing should be frequent enough to assess the ontogeny of intra-session habituation (44). This may require three or more time periods prior to, and including the day of weaning (e.g. PND 13, 17, 21). Testing of the same animals, or littermates, should also occur at an adult age close to study termination (e.g. PND 60-70). Testing on additional days may be done as necessary. Motor activity should be monitored by an automated activity recording apparatus which should be capable of detecting both increases and decreases in activity, (i.e. baseline activity as measured by the device should not be so low as to preclude detection of decreases, nor so high as to preclude detection of increases in activity). Each device should be tested by standard procedures to ensure, to the extent possible, reliability of operation across devices and across days. To the extent possible, treatment groups should be balanced across devices. Each animal should be tested individually. Treatment groups should be counter-balanced across test times to avoid confounding by circadian rhythms of activity. Efforts should be made to ensure that variations in the test conditions are minimal and are not systematically related to treatment. Among the variables that can affect many measures of behaviour, including motor activity, are sound level, size and shape of the test cage, temperature, relative humidity, light conditions, odours, use of home cage or novel test cage and environmental distractions.

Motor and sensory function

36. Motor and sensory function should be examined in detail at least once for the adolescent period and once during the young adult period (e.g. PND 60-70). For testing at the time of weaning, see paragraph 32. Sufficient testing should be conducted to ensure an adequate quantitative sampling of sensory modalities (e.g. somato-sensory, vestibular) and motor functions (e.g. strength, coordination). A few examples of tests for motor and sensory function are extensor thrust response (46), righting reflex (47)(48), auditory startle habituation (40)(49)(50)(51)(52)(53)(54), and evoked potentials (55).

▼ M5**Learning and memory tests**

37. A test of associative learning and memory should be conducted post-weaning (e.g. 25 ± 2 days) and for young adults (PND 60 and older). For testing at the time of weaning, see paragraph 32. The same or separate test(s) may be used at these two stages of development. Some flexibility is allowed in the choice of test(s) for learning and memory in weanling and adult rats. However, the test(s) should be designed so as to fulfil two criteria. First, learning should be assessed either as a change across several repeated learning trials or sessions, or, in tests involving a single trial, with reference to a condition that controls for non-associative effects of the training experience. Second, the test(s) should include some measure of memory (short-term or long-term) in addition to original learning (acquisition), but this measure of memory cannot be reported in the absence of a measure of acquisition obtained from the same test. If the test(s) of learning and memory reveal(s) an effect of the test chemical, additional tests to rule out alternative interpretations based on alterations in sensory, motivational, and/or motor capacities may be considered. In addition to the above two criteria, it is recommended that the test of learning and memory be chosen on the basis of its demonstrated sensitivity to the class of chemical under investigation, if such information is available in the literature. In the absence of such information, examples of tests that could be made to meet the above criteria include: passive avoidance (43)(56)(57), delayed-matching-to-position for the adult rat (58) and for the infant rat (59), olfactory conditioning (43)(60), Morris water maze (61)(62)(63), Biel or Cincinnati maze (64)(65), radial arm maze (66), T-maze (43), and acquisition and retention of schedule-controlled behaviour (26)(67)(68). Additional tests are described in the literature for weanling (26)(27) and adult rats (19)(20).

Post-mortem examination

38. Maternal animals can be euthanised after weaning of the offspring.
39. Neuropathological evaluation of the offspring will be conducted using tissues from animals humanely killed at PND 22 or at an earlier time point between PND 11 and PND 22, as well as at study termination. For offspring killed through PND 22, brain tissues should be evaluated; for animals killed at termination, both central nervous system (CNS) tissues and peripheral nervous system (PNS) tissues should be evaluated. Animals killed on PND 22 or earlier may be fixed either by immersion or perfusion. Animals killed at study termination should be fixed by perfusion. All aspects of the preparation of tissue samples, from the perfusion of animals, through the dissection of tissue samples, tissue processing, and staining of slides should employ a counterbalanced design such that each batch contains representative samples from each dose group. Additional guidance on neuropathology can be found in OECD Guidance Document No 20(9), see also (103).

Processing of tissue samples

40. All gross abnormalities apparent at the time of necropsy should be noted. Tissue samples taken should represent all major regions of the nervous system. The tissue samples should be retained in an appropriate fixative and processed according to standardised published histological protocols (69)(70)(71)(103). Paraffin embedding is acceptable for tissues of the CNS and PNS, but the use of osmium in post-fixation, together with

▼ M5

epoxy embedding, may be appropriate when a higher degree of resolution is required (e.g. for peripheral nerves when a peripheral neuropathy is suspected and/or for morphometric analysis of peripheral nerves). Brain tissue collected for morphometric analysis should be embedded in appropriate media at all dose levels at the same time in order to avoid shrinkage artefacts that may be associated with prolonged storage in fixative (6).

Neuropathological examination

41. The purposes of the qualitative examination are:
 - (i) to identify regions within the nervous system exhibiting evidence of neuropathological alterations;
 - (ii) to identify types of neuropathological alterations resulting from exposure to the test chemical; and
 - (iii) to determine the range of severity of the neuropathological alterations.

Representative histological sections from the tissue samples should be examined microscopically by an appropriately trained pathologist for evidence of neuropathological alterations. All neuropathologic alterations should be assigned a subjective grade indicating severity. A hematoxylin and eosin stain may be sufficient for evaluating brain sections from animals humanely killed at PND 22, or earlier. However, a myelin stain (e.g. luxol fast blue/cresyl violet) and a silver stain (e.g. Bielschowsky's or Bodians stains) are recommended for sections of CNS and PNS tissues from animals killed at study termination. Subject to the professional judgement of the pathologist and the kind of alterations observed, other stains may be considered appropriate to identify and characterise particular types of alterations (e.g. glial fibrillary acidic protein (GFAP) or lectin histochemistry to assess glial and microglial alterations (72), fluoro-jade to detect necrosis (73)(74), or silver stains specific for neural degeneration (75)).

42. Morphometric (quantitative) evaluation should be performed as these data may assist in the detection of a treatment-related effect and are valuable in the interpretation of treatment-related differences in brain weight or morphology (76)(77). Nervous tissue should be sampled and prepared to enable morphometric evaluation. Morphometric evaluations may include e.g. linear or areal measurements of specific brain regions (78). Linear or areal measurements require the use of homologous sections carefully selected based on reliable microscopic landmarks (6). Stereology may be used to identify treatment-related effects on parameters such as volume or cell number for specific neuroanatomic regions (79)(80)(81)(82)(83)(84).
43. The brains should be examined for any evidence of treatment-related neuropathological alterations and adequate samples should be taken from all major brain regions (e.g. olfactory bulbs, cerebral cortex, hippocampus, basal ganglia, thalamus, hypothalamus, midbrain (tectum, tegmentum, and cerebral peduncles), pons, medulla oblongata, cerebellum) to ensure a thorough examination. It is important that sections for all animals are taken in the same plane. In adults humanely killed at study termination, representative sections of the spinal cord and the PNS should be sampled. The areas examined should include the eye with optic nerve and retina, the spinal cord at the cervical and lumbar swellings, the dorsal and ventral root fibres, the proximal sciatic nerve, the proximal tibial nerve (at the knee), and the tibial nerve calf muscle branches. The spinal cord and peripheral nerve sections should include both cross or transverse and longitudinal sections.

▼ **M5**

44. Neuropathological evaluation should include an examination for indications of developmental damage to the nervous system (6)(85)(86)(87)(88)(89), in addition to the cellular alterations (e.g. neuronal vacuolation, degeneration, necrosis) and tissue changes (e.g. gliosis, leukocytic infiltration, cystic formation). In this regard, it is important that treatment-related effects be distinguished from normal developmental events known to occur at a developmental stage corresponding to the time of sacrifice (90). Examples of significant alterations indicative of developmental insult include, but are not restricted to:

- alterations in the gross size or shape of the olfactory bulbs, cerebrum or cerebellum;
- alterations in the relative size of various brain regions, including decreases or increases in the size of regions resulting from the loss or persistence of normally transient populations of cells or axonal projections (e.g. external germinal layer of cerebellum, corpus callosum);
- alterations in proliferation, migration, and differentiation, as indicated by areas of excessive apoptosis or necrosis, clusters or dispersed populations of ectopic, disoriented or malformed neurons or alterations in the relative size of various layers of cortical structures;
- alterations in patterns of myelination, including an overall size reduction or altered staining of myelinated structures;
- evidence of hydrocephalus, in particular enlargement of the ventricles, stenosis of the cerebral aqueduct and thinning of the cerebral hemispheres.

Analysis of the dose-response relationship of neuropathological alterations

45. The following stepwise procedure is recommended for the qualitative and quantitative neuropathological analyses. First, sections from the high dose group are compared with those of the control group. If no evidence of neuropathological alterations is found in animals of the high dose group, no further analysis is required. If evidence of neuropathological alterations is found in the high dose group, then animals from the intermediate and low dose groups are examined. If the high dose group is terminated due to death or other confounding toxicity, the high and intermediate dose groups should be analysed for neuropathological alterations. If there is any indication of neurotoxicity in lower dose groups, neuropathological analysis should be performed in those groups. If any treatment-related neuropathological alterations are found in the qualitative or quantitative examination, the dose-dependence of the incidence, frequency and severity grade of the lesions or of the morphometric alterations should be determined, based on an evaluation of all animals from all dose groups. All regions of the brain that exhibit any evidence of neuropathologic alteration should be included in this evaluation. For each type of lesion, the characteristics used to define each severity grade should be described, indicating the features used to differentiate each grade. The frequency of each type of lesion and its severity grade should be recorded and a statistical analysis should be performed to evaluate the nature of a dose-response relationships. The use of coded slides is recommended (91).

DATA AND REPORTING

Data

46. Data should be reported individually and summarised in tabular form, showing for each test group the types of change and the number of dams, offspring by sex, and litters displaying each type of change. If direct postnatal exposure of the offspring has been performed, the route, duration and period of exposure should be reported.

▼ M5**Evaluation and interpretation of results**

47. A developmental neurotoxicity study will provide information on the effects of repeated exposure to a chemical during *in utero* and early postnatal development. Since emphasis is placed on both general toxicity and developmental neurotoxicity endpoints, the results of the study will allow for the discrimination between neurodevelopmental effects occurring in the absence of general maternal toxicity, and those which are only expressed at levels that are also toxic to the maternal animal. Due to the complex interrelationships among study design, statistical analysis, and biological significance of the data, adequate interpretation of developmental neurotoxicity data will involve expert judgment (107)(109). The interpretation of test results should use a weight-of-evidence-approach (20)(92)(93)(94). Patterns of behavioural or morphological findings, if present, as well as evidence of dose-response should be discussed. Data from all studies relevant to the evaluation of developmental neurotoxicity, including human epidemiological studies or case reports, and experimental animal studies (e.g. toxicokinetic data, structure-activity information, data from other toxicity studies) should be included in this characterisation. This includes the relationship between the doses of the test chemical and the presence or absence, incidence, and extent of any neurotoxic effect for each sex (20)(95).
48. Evaluation of data should include a discussion of both the biological and statistical significance. Statistical analysis should be viewed as a tool that guides rather than determines the interpretation of data. Lack of statistical significance should not be the sole rationale for concluding a lack of treatment related effect, just as statistical significance should not be the sole justification for concluding a treatment-related effect. To guard against possible false-negative findings and the inherent difficulties in 'proving a negative,' available positive and historical control data should be discussed, especially when there are no treatment-related effects (102)(106). The probability of false positives should be discussed in light of the total statistical evaluation of the data (96). The evaluation should include the relationship, if any, between observed neuropathological and behavioural alterations.
49. All results should be analysed using statistical models appropriate to the experimental design (108). The choice of a parametric or a nonparametric analysis should be justified by considering factors such as the nature of the data (transformed or not) and their distribution, as well as the relative robustness of the statistical analysis selected. The purpose and design of the study should guide the choice of statistical analyses to minimise Type I (false positive) and Type II (false negative) errors (96)(97)(104)(105). Developmental studies using multiparous species where multiple pups per litter are tested should include the litter in the statistical model to guard against an inflated Type I error rates (98)(99)(100)(101). The statistical unit of measure should be the litter and not the pup. Experiments should be designed such that littermates are not treated as independent observations. Any endpoint repeatedly measured in the same subject should be analysed using statistical models that account for the non-independence of those measures.

Test report

50. The test report should include the following information:

Test chemical:

- physical nature and, where relevant, physiochemical properties;

- identification data, including source;

▼ M5

- purity of the preparation, and known and/or anticipated impurities.

Vehicle (if appropriate):

- justification for choice of vehicle, if other than water or physiological saline solution.

Test animals:

- species and strain used, and a justification if other than the rat;
- supplier of test animals;
- number, age at start, and sex of animals;
- source, housing conditions, diet, water, etc.;
- individual weights of animals at the start of the test.

Test conditions:

- rationale for dose level selection;
- rationale for dosing route and time period;
- specifications of the doses administered, including details of the vehicle, volume and physical form of the material administered;
- details of test chemical formulation/diet preparation, achieved concentration, stability and homogeneity of the preparation;
- method used for unique identification of dams and offspring;
- a detailed description of the randomisation procedure(s) used to assign dams to treatment groups, to select pups for culling, and to assign pups to test groups;
- details of the administration of the test chemical;
- conversion from diet/drinking water or inhalation test chemical concentration (ppm) to the actual dose (mg/kg body weight/day), if applicable;
- environmental conditions;
- details of food and water (e.g. tap, distilled) quality;
- dates of study start and end.

Observations and test procedures:

- a detailed description of the procedures used to standardise observations and procedures as well as operational definitions for scoring observations;
- a list of all test procedures used, and justification for their use;
- details of the behavioural/functional, pathological, neurochemical or electrophysiological procedures used, including information and details on automated devices;
- procedures for calibrating and ensuring the equivalence of devices and the balancing of treatment groups in testing procedures;
- a short justification explaining any decisions involving professional judgement.

▼ M5

Results (individual and summary, including mean and variance when appropriate):

- the number of animals at the start of the study and the number at the end of the study;
- the number of animals and litters used for each test method;
- identification number of each animal and the litter from which it came;
- litter size and mean weight at birth by sex;
- body weight and body weight change data, including terminal body weight for dams and offspring;
- food consumption data, and water consumption data if appropriate (e.g. if test chemical is administered via water);
- toxic response data by sex and dose level, including signs of toxicity or mortality, including time and cause of death, if appropriate;
- nature, severity, duration, day of onset, time of day, and subsequent course of the detailed clinical observations;
- score on each developmental landmark (weight, sexual maturation and behavioural ontogeny) at each observation time;
- a detailed description of all behavioural, functional, neuropathological, neurochemical, electrophysiological findings by sex, including both increases and decreases from controls;
- necropsy findings;
- brain weights;
- any diagnoses derived from neurological signs and lesions, including naturally-occurring diseases or conditions;
- images of exemplar findings;
- low-power images to assess homology of sections used for morphometry;
- absorption and metabolism data, including complementary data from a separate toxicokinetic study, if available;
- statistical treatment of results, including statistical models used to analyse the data, and the results, regardless of whether they were significant or not;
- list of study personnel, including professional training.

Discussion of results:

- dose response information, by sex and group;
- relationship of any other toxic effects to a conclusion about the neurotoxic potential of the test chemical, by sex and group;
- impact of any toxicokinetic information on the conclusions;
- similarities of effects to any known neurotoxicants;

▼ **M5**

- data supporting the reliability and sensitivity of the test method (i.e. positive and historical control data);
- relationships, if any, between neuropathological and functional effects;
- NOAEL or benchmark dose for dams and offspring, by sex and group.

Conclusions:

- a discussion of the overall interpretation of the data based on the results, including a conclusion of whether or not the test chemical caused developmental neurotoxicity and the NOAEL.

LITERATURE

- (1) OECD (1995). Draft Report of the OECD *Ad Hoc* Working Group on Reproduction and Developmental Toxicity. Copenhagen, Denmark, 13-14 June 1995.
- (2) US EPA (1998). U.S. Environmental Protection Agency Health Effects Test Guidelines. OPPTS 870.6300. Developmental Neurotoxicity Study. US EPA 712-C-98-239. Available: [http://www.epa.gov/opptsfrs/OPPTS_Harmonized/870_Health_Effects_Test_Guidelines/Series/].
- (3) US EPA (1998). Guidelines for Neurotoxicity Risk Assessment. US EPA 630/R-95/001F. Available: [<http://cfpub.epa.gov/ncea/cfm/recordisplay.cfm?PrintVersion=True&deid=12479>].
- (4) Cory-Slechta, D.A., Crofton, K.M., Foran, J.A., Ross, J.F., Sheets, L.P., Weiss, B., Mileson, B. (2001). Methods to identify and characterize developmental neurotoxicity for human health risk assessment: I. Behavioral effects. *Environ. Health Perspect.*, 109:79-91.
- (5) Dorman, D.C., Allen, S.L., Byczkowski, J.Z., Claudio, L., Fisher, J.E. Jr., Fisher, J.W., Harry, G.J., Li, A.A., Makris, S.L., Padilla, S., Sultatos, L.G., Mileson, B.E. (2001). Methods to identify and characterize developmental neurotoxicity for human health risk assessment: III. Pharmacokinetic and pharmacodynamic considerations. *Environ. Health Perspect.*, 109:101-111.
- (6) Garman, R.H., Fix, A.S., Jortner, B.S., Jensen, K.F., Hardisty, J.F., Claudio, L., Ferenc, S. (2001). Methods to identify and characterize developmental neurotoxicity for human health risk assessment: II. Neuropathology. *Environ. Health Perspect.*, 109:93-100.
- (7) OECD (2003). Report of the OECD Expert Consultation Meeting on Developmental Neurotoxicity Testing. Washington D.C., US, 23-25 October 2000.
- (8) OECD (2008). OECD Environment, Health and Safety Publications Series on Testing and Assessment No 43. Guidance Document on Mammalian Reproductive Toxicity Testing and Assessment. Environment Directorate, OECD, Paris. July 2008. Available: [[http://search.oecd.org/officialdocuments/displaydocumentpdf/?cote=env/jm/mono\(2008\)16&doclanguage=en](http://search.oecd.org/officialdocuments/displaydocumentpdf/?cote=env/jm/mono(2008)16&doclanguage=en)].
- (9) OECD (2003). OECD Environment, Health and Safety Publications Series on Testing and Assessment No 20. Guidance Document for Neurotoxicity Testing. Environment Directorate, OECD, Paris, September 2003. Available: [http://www.oecd.org/document/22/0,2340,en_2649_34377_1916054_1_1_1_1,00.html].
- (10) Kimmel, C.A., Rees, D.C., Francis, E.Z. (1990) Qualitative and quantitative comparability of human and animal developmental neurotoxicity. *Neurotoxicol. Teratol.*, 12: 173-292.
- (11) Spencer, P.S., Schaumburg, H.H., Ludolph, A.C. (2000) *Experimental and Clinical Neurotoxicology, 2nd Edition*, ISBN 0195084772, Oxford University Press, New York.

▼ **M5**

- (12) Mendola, P., Selevan, S.G., Gutter, S., Rice, D. (2002) Environmental factors associated with a spectrum of neurodevelopmental deficits. *Ment. Retard. Dev. Disabil. Res. Rev.* 8:188-197.
- (13) Slikker, W.B., Chang, L.W. (1998) *Handbook of Developmental Neurotoxicology, 1st Edition*, ISBN 0126488606, Academic Press, New York.
- (14) Chapter B.34 of this Annex, One-generation reproduction toxicity study.
- (15) Chapter B.35 of this Annex, Two-generation reproduction toxicity study.
- (16) Chapter B.43 of this Annex, Neurotoxicity Study in Rodents.
- (17) Chapter B.31 of this Annex, Prenatal developmental toxicity study.
- (18) Directive 2010/63/EU of the European Parliament and of the Council of 22 September 2010 on the protection of animals used for scientific purposes. OJ L 276, 20.10.2010, p. 33
- (19) WHO (1986) *Principles and Methods for the Assessment of Neurotoxicity Associated with Exposure to Chemicals*, (Environmental Health Criteria 60), Albany, New York: World Health Organization Publications Center, USA. Available: [<http://www.inchem.org/documents/ehc/ehc/ehc060.htm>].
- (20) WHO (2001) *Neurotoxicity Risk Assessment for Human Health: Principles and Approaches*, (Environmental Health Criteria 223), World Health Organization Publications, Geneva. Available: [<http://www.intox.org/databank/documents/supplem/supp/ehc223.htm>].
- (21) Chang, L.W., Slikker, W. (1995) *Neurotoxicology: Approaches and Methods, 1st Edition*, ISBN 012168055X, Academic Press, New York.
- (22) De Cabo, C., Viveros, M.P. (1997) Effects of neonatal naltrexone on neurological and somatic development in rats of both genders. *Neurotoxicol. Teratol.*, 19:499-509.
- (23) Agnish, N.D., Keller, K.A. (1997) The rationale for culling of rodent litters. *Fundam. Appl. Toxicol.*, 38:2-6.
- (24) Avery, D.L., Spyker, J.M. (1977) Foot tattoo of neonatal mice. *Lab. Animal Sci.*, 27:110-112.
- (25) Wier, P.J., Guerriero, F.J., Walker, R.F. (1989) Implementation of a primary screen for developmental neurotoxicity. *Fundam. Appl. Toxicol.*, 13:118-136.
- (26) Spear, N.E., Campbell, B.A. (1979) *Ontogeny of Learning and Memory*. ISBN 0470268492, Erlbaum Associates, New Jersey.
- (27) Krasnegor, N.A., Blass, E.M., Hofer, M.A., Smotherman, W. (1987) *Perinatal Development: A Psychobiological Perspective*. Academic Press, Orlando.
- (28) Zoetis, T., Walls, I. (2003) *Principles and Practices for Direct Dosing of Pre-Weaning Mammals in Toxicity Testing and Research*. ILSI Press, Washington, DC.
- (29) Moser, V., Walls, I., Zoetis, T. (2005) Direct dosing of preweaning rodents in toxicity testing and research: Deliberations of an ILSI RSI expert working group. *Int. J. Toxicol.*, 24:87-94.
- (30) Conolly, R.B., Beck, B.D., Goodman, J.I. (1999) Stimulating research to improve the scientific basis of risk assessment. *Toxicol. Sci.*, 49: 1-4.
- (31) ICH (1993) ICH Harmonised Tripartite Guideline: Detection of Toxicity to Reproduction for Medical Products (S5A). International Conference on Harmonisation of Technical Requirements for Registration of Pharmaceuticals for Human Use.
- (32) Lochry, E.A. (1987) Concurrent use of behavioral/functional testing in existing reproductive and developmental toxicity screens: Practical considerations. *J. Am. Coll. Toxicol.*, 6:433-439.

▼ M5

- (33) Tachibana, T., Narita, H., Ogawa, T., Tanimura, T. (1998) Using postnatal age to determine test dates leads to misinterpretation when treatments alter gestation length, results from a collaborative behavioral teratology study in Japan. *Neurotoxicol. Teratol.*, 20:449-457.
- (34) Gallavan, R.H. Jr., Holson, J.F., Stump, D.G., Knapp, J.F., Reynolds, V.L. (1999) Interpreting the toxicologic significance of alterations in anogenital distance: potential for confounding effects of progeny body weights. *Reprod. Toxicol.*, 13:383-390.
- (35) Gray, L.E. Jr., Ostby, J., Furr, J., Price, M., Veeramachaneni, D.N., Parks, L. (2000) Perinatal exposure to the phthalates DEHP, BBP, and DINP, but not DEP, DMP, or DOTP, alters sexual differentiation of the male rat. *Toxicol. Sci.*, 58:350-365.
- (36) Adams, J., Buelke-Sam, J., Kimmel, C.A., Nelson, C.J., Reiter, L.W., Sobotka, T.J., Tilson, H.A., Nelson, B.K. (1985) Collaborative behavioral teratology study: Protocol design and testing procedure. *Neurobehav. Toxicol. Teratol.*, 7:579-586.
- (37) Korenbrot, C.C., Huhtaniemi, I.T., Weiner, R.W. (1977) Preputial separation as an external sign of pubertal development in the male rat. *Biol. Reprod.*, 17:298-303.
- (38) Spear, L.P. (1990) Neurobehavioral assessment during the early postnatal period. *Neurotoxicol. Teratol.*, 12:489-95.
- (39) Altman, J., Sudarshan, K. (1975) Postnatal development of locomotion in the laboratory rat. *Anim. Behav.*, 23:896-920.
- (40) Adams, J. (1986) Methods in Behavioral Teratology. In: *Handbook of Behavioral Teratology*. Riley, E.P., Vorhees, C.V. (eds.) Plenum Press, New York, pp. 67-100.
- (41) Reiter, L.W., MacPhail, R.C. (1979) Motor activity: A survey of methods with potential use in toxicity testing. *Neurobehav. Toxicol.*, 1:53-66.
- (42) Robbins, T.W. (1977) A critique of the methods available for the measurement of spontaneous motor activity, *Handbook of Psychopharmacology*, Vol. 7, Iverson, L.L., Iverson, D.S., Snyder, S.H., (eds.) Plenum Press, New York, pp. 37-82.
- (43) Crofton, K.M., Peele, D.B., Stanton, M.E. (1993) Developmental neurotoxicity following neonatal exposure to 3,3'-iminodipropionitrile in the rat. *Neurotoxicol. Teratol.*, 15:117-129.
- (44) Ruppert, P.H., Dean, K.F., Reiter, L.W. (1985) Development of locomotor activity of rat pups in figure-eight mazes. *Dev. Psychobiol.*, 18:247-260.
- (45) Crofton, K.M., Howard, J.L., Moser, V.C., Gill, M.W., Reiter, L.W., Tilson, H.A., MacPhail, R.C. (1991) Interlaboratory comparison of motor activity experiments: Implications for neurotoxicological assessments. *Neurotoxicol. Teratol.*, 13:599-609.
- (46) Ross, J. F., Handley, D. E., Fix, A. S., Lawhorn, G. T., Carr, G. J. (1997) Quantification of the hind-limb extensor thrust response in rats. *Neurotoxicol. Teratol.*, 19:1997. 405-411.
- (47) Handley, D.E., Ross, J.F., Carr, G.J. (1998) A force plate system for measuring low-magnitude reaction forces in small laboratory animals. *Physiol. Behav.*, 64:661-669.
- (48) Edwards, P.M., Parker, V.H. (1977) A simple, sensitive, and objective method for early assessment of acrylamide neuropathy in rats. *Toxicol. Appl. Pharmacol.*, 40:589-591.
- (49) Davis, M. (1984) The mammalian startle response. In: *Neural Mechanisms of Startle Behavior*, Eaton, R.C. (ed), Plenum Press, New York, pp. 287-351
- (50) Koch, M. (1999) The neurobiology of startle. *Prog. Neurobiol.*, 59:107-128.
- (51) Crofton, K.M. (1992) Reflex modification and the assessment of sensory dysfunction. In *Target Organ Toxicology Series: Neurotoxicology*, Tilson, H., Mitchell, C. (eds). Raven Press, New York, pp. 181-211.

▼ M5

- (52) Crofton, K.M., Sheets, L.P. (1989) Evaluation of sensory system function using reflex modification of the startle response. *J. Am. Coll. Toxicol.*, 8:199-211.
- (53) Crofton, K.M., Lassiter, T.L., Rebert, C.S. (1994) Solvent-induced ototoxicity in rats: An atypical selective mid-frequency hearing deficit. *Hear. Res.*, 80:25-30.
- (54) Ison, J.R. (1984) Reflex modification as an objective test for sensory processing following toxicant exposure. *Neurobehav. Toxicol. Teratol.*, 6:437-445.
- (55) Mattsson, J.L., Boyes, W.K., Ross, J.F. (1992) Incorporating evoked potentials into neurotoxicity test schemes. In: *Target Organ Toxicology Series: Neurotoxicity*, Tilson, H., Mitchell, C., (eds.), Raven Press, New York. pp. 125-145.
- (56) Peele, D.B., Allison, S.D., Crofton, K.M. (1990) Learning and memory deficits in rats following exposure to 3,3'-iminopropionitrile. *Toxicol. Appl. Pharmacol.*, 105:321-332.
- (57) Bammer, G. (1982) Pharmacological investigations of neurotransmitter involvement in passive avoidance responding: A review and some new results. *Neurosci. Behav. Rev.*, 6:247-296.
- (58) Bushnell, P.J. (1988) Effects of delay, intertrial interval, delay behavior and trimethyltin on spatial delayed response in rats. *Neurotoxicol. Teratol.*, 10:237-244.
- (59) Green, R.J., Stanton, M.E. (1989) Differential ontogeny of working memory and reference memory in the rat. *Behav. Neurosci.*, 103:98-105.
- (60) Kucharski, D., Spear, N.E. (1984) Conditioning of aversion to an odor paired with peripheral shock in the developing rat. *Develop. Psychobiol.*, 17:465-479.
- (61) Morris, R. (1984) Developments of a water-maze procedure for studying spatial learning in the rat. *J. Neurosci. Methods*, 11:47-60.
- (62) Brandeis, R., Brandys, Y., Yehuda, S. (1989) The use of the Morris water maze in the study of memory and learning. *Int. J. Neurosci.*, 48:29-69.
- (63) D'Hooge, R., De Deyn, P.P. (2001) Applications of the Morris water maze in the study of learning and memory. *Brain Res. Rev.*, 36:60-90.
- (64) Vorhees, C.V. (1987) Maze learning in rats: A comparison of performance in two water mazes in progeny prenatally exposed to different doses of phenytoin. *Neurotoxicol. Teratol.*, 9:235-241.
- (65) Vorhees, C.V. (1997) Methods for detecting long-term CNS dysfunction after prenatal exposure to neurotoxins. *Drug Chem. Toxicol.*, 20:387-399.
- (66) Akaike, M., Tanaka, K., Goto, M., Sakaguchi, T. (1988) Impaired Biel and Radial arm maze learning in rats with methyl-nitrosurea induced microcephaly. *Neurotoxicol. Teratol.*, 10:327-332.
- (67) Cory-Slechta, D.A., Weiss, B., Cox, C. (1983) Delayed behavioral toxicity of lead with increasing exposure concentration. *Toxicol. Appl. Pharmacol.*, 71:342-352.
- (68) Campbell, B.A., Haroutunian, V. (1981) Effects of age on long-term memory: Retention of fixed interval responding. *J. Gerontol.*, 36:338-341.
- (69) Fix, A.S., Garman, R.H. (2000) Practical aspects of neuropathology: A technical guide for working with the nervous system. *Toxicol. Pathol.*, 28: 122-131.
- (70) Prophet, E.B., Mills, B., Arrington, J.B., Sobin, L.H. (1994) *Laboratory Methods in Histotechnology*, American Registry of Pathology, Washington, DC, pp. 84-107.
- (71) Bancroft, J.D., Gamble, M. (2002) *Theory and Practice of Histological Techniques*, 5th edition, Churchill Livingstone, London.

▼ M5

- (72) Fix, A.S., Ross, J.F., Stitzel, S.R., Switzer, R.C. (1996) Integrated evaluation of central nervous system lesions: stains for neurons, astrocytes, and microglia reveal the spatial and temporal features of MK-801-induced neuronal necrosis in the rat cerebral cortex. *Toxicol. Pathol.*, 24: 291-304.
- (73) Schmued, L.C., Hopkins, K.J. (2000) Fluoro-Jade B: A high affinity tracer for the localization of neuronal degeneration. *Brain Res.*, 874:123-130.
- (74) Krinke, G.J., Classen, W., Vidotto, N., Suter, E., Wurmlin, C.H. (2001) Detecting necrotic neurons with fluoro-jade stain. *Exp. Toxic. Pathol.*, 53:365-372.
- (75) De Olmos, I.S., Beltramino, C.A., and de Olmos de Lorenzo, S. (1994) Use of an amino-cupric-silver technique for the detection of early and semiacute neuronal degeneration caused by neurotoxicants, hypoxia and physical trauma. *Neurotoxicol. Teratol.*, 16, 545-561.
- (76) De Groot, D.M.G., Bos-Kuijpers, M.H.M., Kaufmann, W.S.H., Lammers, J.H.C.M., O'Callaghan, J.P., Pakkenberg, B., Pelgrim, M.T.M., Waalkens-Berendsen, I.D.H., Waanders, M.M., Gundersen, H.J. (2005a) Regulatory developmental neurotoxicity testing: A model study focusing on conventional neuropathology endpoints and other perspectives. *Environ. Toxicol. Pharmacol.*, 19:745-755.
- (77) De Groot, D.M.G., Hartgring, S., van de Horst, L., Moerkens, M., Otto, M., Bos-Kuijpers, M.H.M., Kaufmann, W.S.H., Lammers, J.H.C.M., O'Callaghan, J.P., Waalkens-Berendsen, I.D.H., Pakkenberg, B., Gundersen, H.J. (2005b) 2D and 3D assessment of neuropathology in rat brain after prenatal exposure to methylazoxymethanol, a model for developmental neurotoxicity. *Reprod. Toxicol.*, 20:417-432.
- (78) Rodier, P.M., Gramann, W.J. (1979) Morphologic effects of interference with cell proliferation in the early fetal period. *Neurobehav. Toxicol.*, 1:129-135.
- (79) Howard, C.V., Reed, M.G. (1998) *Unbiased Stereology: Three-Dimensional Measurement in Microscopy*, Springer-Verlag, New York.
- (80) Hyman, B.T., Gomez-Isla, T., Irizarry, M.C. (1998) Stereology: A practical primer for neuropathology. *J. Neuropathol. Exp. Neurol.*, 57: 305-310.
- (81) Korbo, L., Andersen, B.B., Ladefoged, O., Møller, A. (1993) Total numbers of various cell types in rat cerebellar cortex estimated using an unbiased stereological method. *Brain Res.*, 609: 262-268.
- (82) Schmitz, C. (1997) Towards more readily comprehensible procedures in disector stereology. *J. Neurocytol.*, 26:707-710.
- (83) West, M.J. (1999) Stereological methods for estimating the total number of neurons and synapses: Issues of precision and bias. *Trends Neurosci.*, 22:51-61.
- (84) Schmitz, C., Hof, P.R. (2005) Design-based stereology in neuroscience. *Neuroscience*, 130: 813-831.
- (85) Gavin, C.E., Kates, B., Gerken, L.A., Rodier, P.M. (1994) Patterns of growth deficiency in rats exposed *in utero* to undernutrition, ethanol, or the neuroteratogen methylazoxymethanol (MAM). *Teratology*, 49:113-121.
- (86) Ohno, M., Aotani, H., Shimada, M. (1995) Glial responses to hypoxic/ischemic encephalopathy in neonatal rat cerebrum. *Develop. Brain Res.*, 84:294-298.
- (87) Jensen KF, Catalano SM. (1998) Brain morphogenesis and developmental neurotoxicology. In: *Handbook of Developmental Neurotoxicology*, Slikker, Jr. W., Chang, L.W. (eds) Academic Press, New York, pp. 3-41.
- (88) Ikonomidou, C., Bosch, F., Miksa, M., Bittigau, P., Vöckler, J., Dikranian, K., Tenkova, T.I., Stefovská, V., Turski, L., Olney, J.W. (1999) Blockade of NMDA receptors and apoptotic neurodegeneration in the developing brain. *Science*, 283:70-74.

▼ M5

- (89) Ikonomidou, C., Bittigau, P., Ishimaru, M.J., Wozniak, D.F., Koch, C., Genz, K., Price, M.T., Sefovska, V., Hörster, F., Tenkova, T., Dikranian, K., Olney, J.W. (2000) Ethanol-induced apoptotic degeneration and fetal alcohol syndrome. *Science*, 287:1056–1060.
- (90) Friede, R. L. (1989) *Developmental Neuropathology*. Second edition. Springer-Verlag, Berlin.
- (91) House, D.E., Berman, E., Seeley, J.C., Simmons, J.E. (1992) Comparison of open and blind histopathologic evaluation of hepatic lesions. *Toxicol. Let.*, 63:127-133.
- (92) Tilson, H.A., MacPhail, R.C., Crofton, K.M. (1996) Setting exposure standards: a decision process. *Environ. Health Perspect.*, 104:401-405.
- (93) US EPA (2005) Guidelines for Carcinogen Risk Assessment. US EPA NCEA-F-0644A.
- (94) US EPA (1996) Guidelines for Reproductive Toxicity Risk Assessment, Federal Register 61(212): 56274-56322.
- (95) Danish Environmental Protection Agency (1995) *Neurotoxicology*. Review of Definitions, Methodology, and Criteria. Miljøprojekt nr. 282. Ladefoged, O., Lam, H.R., Østergaard, G., Nielsen, E., Arlien-Søborg, P.
- (96) Muller, K.E., Barton, C.N., Benignus, V.A. (1984). Recommendations for appropriate statistical practice in toxicologic experiments. *Neurotoxicology*, 5:113-126.
- (97) Gad, S.C. (1989) Principles of screening in toxicology with special emphasis on applications to Neurotoxicology. *J. Am. Coll. Toxicol.*, 8:21-27.
- (98) Abby, H., Howard, E. (1973) Statistical procedures in developmental studies on a species with multiple offspring. *Dev. Psychobiol.*, 6:329-335.
- (99) Haseman, J.K., Hogan, M.D. (1975) Selection of the experimental unit in teratology studies. *Teratology*, 12:165-172.
- (100) Holson, R.R., Pearce, B. (1992) Principles and pitfalls in the analysis of prenatal treatment effects in multiparous species. *Neurotoxicol. Teratol.*, 14: 221-228.
- (101) Nelson, C.J., Felton, R.P., Kimmel, C.A., Buelke-Sam, J., Adams, J. (1985) Collaborative Behavioral Teratology Study: Statistical approach. *Neurobehav. Toxicol. Teratol.*, 7:587-90.
- (102) Crofton, K.M., Makris, S.L., Sette, W.F., Mendez, E., Raffaele, K.C. (2004) A qualitative retrospective analysis of positive control data in developmental neurotoxicity studies. *Neurotoxicol. Teratol.*, 26:345-352.
- (103) Bolon, B., Garman, R., Jensen, K., Krinke, G., Stuart, B., and an *ad hoc* working group of the STP Scientific and Regulatory Policy Committee. (2006) A ‘best practices’ approach to neuropathological assessment in developmental neurotoxicity testing — for today. *Toxicol. Pathol.* 34:296-313.
- (104) Tamura, R.N., Buelke-Sam, J. (1992) The use of repeated measures analysis in developmental toxicology studies. *Neurotoxicol. Teratol.*, 14(3):205-210.
- (105) Tukey, J.W., Ciminera, J.L., Heyse, J.F. (1985) Testing the statistical certainty of a response to increasing doses of a drug. *Biometrics*, 41:295-301.
- (106) Crofton, K.M., Foss, J.A., Haas, U., Jensen, K., Levin, E.D., and Parker, S.P. (2008) Undertaking positive control studies as part of developmental neurotoxicity testing: report from the ILSI Research Foundation/Risk Science Institute expert working group on neurodevelopmental endpoints. *Neurotoxicology and Teratology*, 30(4):266-287.
- (107) Raffaele, K.C., Fisher, E., Hancock, S., Hazelden, K., and Sobrian, S.K. (2008) Determining normal variability in a developmental neurotoxicity test: report from the ILSI Research Foundation/Risk Science Institute expert working group on neurodevelopmental endpoints. *Neurotoxicology and Teratology*, 30(4):288-325.

▼ M5

- (108) Holson, R.R., Freshwater, L., Maurissen, J.P.J., Moser, V.C., and Phang, W. (2008) Statistical issues and techniques appropriate for developmental neurotoxicity testing: a report from the ILSI Research Foundation/Risk Science Institute expert working group on neurodevelopmental endpoints. *Neurotoxicology and Teratology*, 30(4):326-348.
- (109) Tyl, R.W., Crofton, K.M., Moretto, A., Moser, V.C., Sheets, L.P., and Sobotka, T.J. (2008) Identification and interpretation of developmental neurotoxicity effects: a report from the ILSI Research Foundation/Risk Science Institute expert working group on neurodevelopmental endpoints *Neurotoxicology and Teratology*, 30(4):349-381.

▼ M5

Figure 1

General testing scheme for functional/behavioural tests, neuropathology evaluation, and brain weights. This diagram is based on the description in paragraphs 13-15 (PND=postnatal day). Examples of animal assignment are given in Appendix 1.

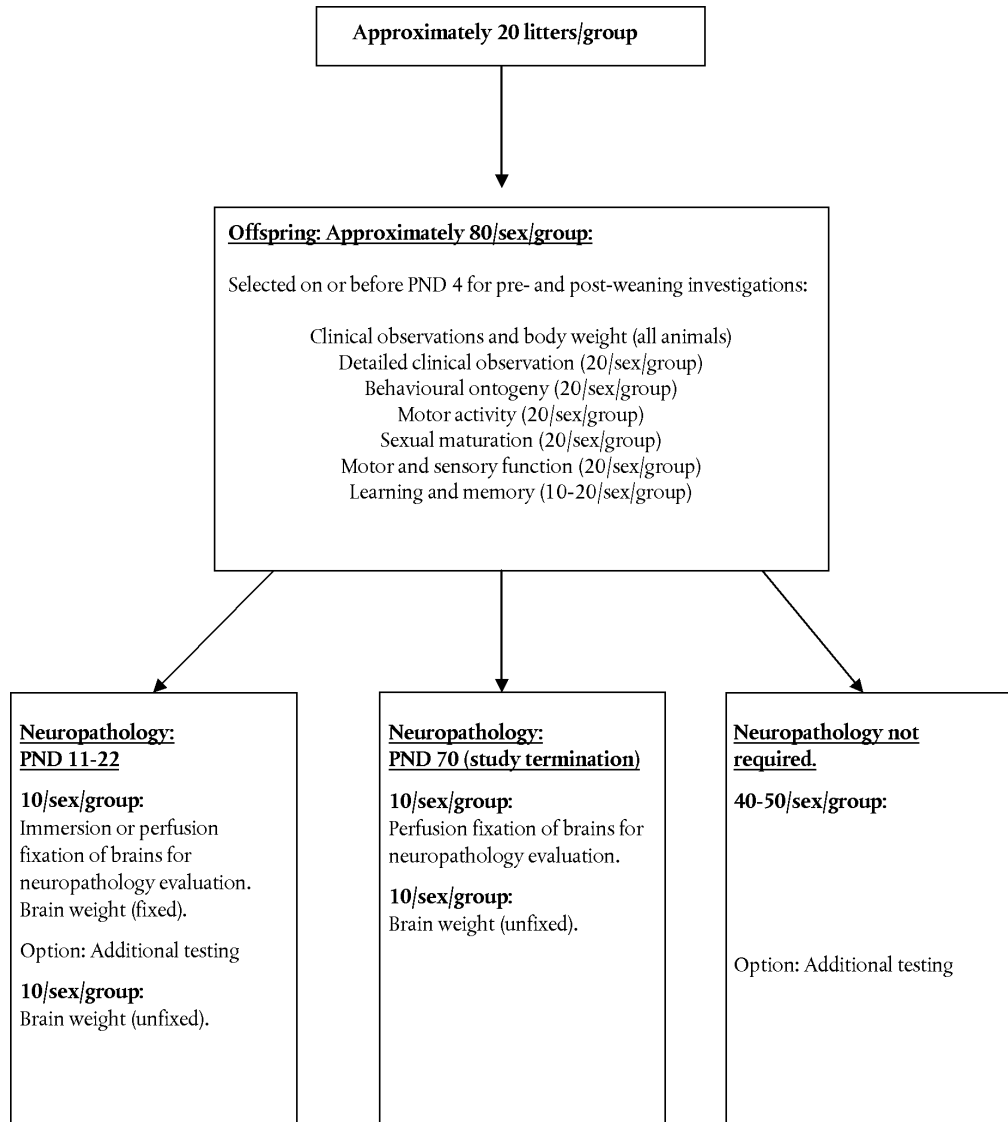

▼ **M5***Appendix 1*

1. Examples of possible assignments are described and tabulated below. These examples are provided to illustrate that assignment of study animals to various testing paradigms can be accomplished in a number of different ways.

Example 1

2. One set of 20 pups/sex/dose level (i.e. 1 male and 1 female per litter) is used for pre-weaning testing of behavioural ontogeny. Out of these animals, 10 pups/sex/dose level (i.e. 1 male or 1 female per litter) are humanely killed at PND 22. The brains are removed, weighed and processed for histopathologic evaluation. In addition, brain weight data are collected using unfixed brains from the remaining 10 males and 10 females per dose level.
3. Another set of 20 animals/sex/dose level (i.e. 1 male and 1 female per litter) is used for post-weaning functional/behavioral tests (detailed clinical observations, motor activity, auditory startle and cognitive function testing in adolescents) and assessing age of sexual maturation. Of these animals, 10 animals/sex/dose level (i.e. 1 male or 1 female per litter), are anaesthetised and fixed via perfusion at study termination (approximately PND 70). After additional fixation in situ, the brain is removed and processed for neuropathological evaluation.
4. For cognitive function testing in young adults (e.g. PND 60-70), a third set of 20 pups/sex/dose level is used (i.e. 1 male and 1 female per litter). Of these animals, 10 animals/sex/group (1 male or 1 female per litter) are killed at study termination and the brain is removed and weighed.
5. The remaining 20 animals/sex/group are reserved for possible additional tests.

Table 1

Pup No (^a)		No of pups assigned to test	Examination/Test
m	f		
1	5	20 m + 20 f	Behavioural ontogeny
		10 m + 10 f	PND 22 brain weight/neuropathology/morphometry
		10 m + 10 f	PND 22 brain weight
2	6	20 m + 20 f	Detailed clinical observations
		20 m + 20 f	Motor activity
		20 m + 20 f	Sexual maturation
		20 m + 20 f	Motor and sensory function
		20 m + 20 f	Learning and memory (PND 25)
		10 m + 10 f	Young adult brain weight/neuropathology/morphometry ~ PND 70

▼ M5

Pup No ^(a)		No of pups assigned to test	Examination/Test
m	f		
3	7	20 m + 20 f	Learning and memory (young adults)
		10 m + 10 f	Young adult brain weight ~ PND 70
4	8	—	Reserve animals for replacements or additional tests

(^a) For this example, litters are culled to 4 males + 4 females; male pups are numbered 1 through 4, female pups 5 through 8.

Example 2

6. One set of 20 pups/sex/dose level (i.e. 1 male and 1 female per litter) is used for pre-weaning testing of behavioural ontogeny. Out of these animals, 10 pups/sex/dose level (1 male or 1 female per litter), are humanely killed at PND 11. The brains are removed, weighed and processed for histopathologic evaluation.
7. Another set of 20 animals/sex/dose level (1 male and 1 female per litter) is used for post-weaning examinations (detailed clinical observations, motor activity, assessing age of sexual maturation and motor and sensory function). Of these animals, 10 animals/sex/dose level (i.e. 1 male or 1 female per litter) are anaesthetised and fixed via perfusion at study termination (approximately PND 70). After additional fixation *in situ*, the brain is removed, weighed and processed for neuropathological evaluation.
8. For cognitive function testing in adolescents and young adults, 10 pups/sex/dose level are used (i.e. 1 male or 1 female per litter). Different animals are used for testing for cognitive function tests at PND 23 and young adults. At termination, the 10 animals/sex/group tested as adults are killed, the brain is removed and weighed.
9. The remaining 20 animals/sex/group not selected for testing are killed and discarded at weaning.

Table 2

Pup No ^(a)		No of pups assigned to test	Examination/Test
m	f		
1	5	20 m + 20 f	Behavioural ontogeny
		10 m + 10 f	PND 11 brain weight/neuropathology/morphometry
2	6	20 m + 20 f	Detailed clinical observations
		20 m + 20 f	Motor activity
		20 m + 20 f	Sexual maturation
		20 m + 20 f	Motor and sensory function
		10 m + 10 f	Young adult brain weight/neuropathology/morphometry ~ PND 70

▼ M5

Pup No ^(a)		No of pups assigned to test	Examination/Test
m	f		
3	7	10 m + 10 f ^(b)	Learning and memory (PND 23)
3	7	10 m + 10 f ^(b)	Learning and memory (young adults) Young adult brain weight
4	8	—	Animals killed and discarded PND 21.

^(a) For this example, litters are culled to 4 males + 4 females; male pups are numbered 1 through 4, female pups 5 through 8.

^(b) Different pups are used for cognitive tests at PND 23 and in young adults (e.g. even/odd litters from total of 20).

Example 3

10. One set 20 pups/sex/dose level (i.e. 1 male and 1 female per litter) is used for brain weight and neuropathology assessment at PND 11. Out of these animals, 10 pups/sex/dose level (i.e. 1 male or 1 female per litter) are humanely killed at PND 11 and brains are removed, weighed and processed for histopathologic evaluation. In addition, brain weight data are collected using unfixed brains from the remaining 10 males and 10 females per dose level.
11. Another set of 20 animals/sex/dose level (i.e. 1 male and 1 female per litter) are used for behavioural ontogeny (motor activity), post-weaning examinations (motor activity and assessing age of sexual maturation), and cognitive function testing in adolescents.
12. Another set of 20 animals/sex/dose level (i.e. 1 male and 1 female per litter) is used for motor and sensory function tests (auditory startle) and detailed clinical observations. Of these animals, 10 animals/sex/dose level (i.e. 1 male or 1 female per litter) are anaesthetised and fixed via perfusion at study termination (approximately PND 70). After additional fixation *in situ*, the brain is removed, weighed and processed for neuropathological evaluation.
13. Another set of 20 pups/sex/dose level are used for cognitive function testing in young adults (i.e. 1 male and 1 female per litter). Of these, 10 animals/sex/group (i.e. 1 male or 1 female per litter) are killed at termination, the brain removed and weighed.

Table 3

Pup No ^(a)		No of pups assigned to test	Examination/Test
m	f		
1	5	10 m + 10 f	PND 11 brain weight/neuropathology/morphometry
		10 m + 10 f	PND 11 brain weight
2	6	20 m + 20 f	Behavioural ontogeny (motor activity)
		20 m + 20 f	Motor activity
		20 m + 20 f	Sexual maturation
		20 m + 20 f	Learning and memory (PND 27)

▼ **M5**

Pup No ^(a)		No of pups assigned to test	Examination/Test
m	f		
3	7	20 m + 20 f	Auditory startle (adolescents and young adults)
		20 m + 20 f	Detailed clinical observations
		10 m + 10 f	Young adult brain weight/neuropathology/morphometry ~ PND 70
4	8	20 m + 20 f	Learning and memory (young adults)
		10 m + 10 f	Young adult brain weight

^(a) For this example, litters are culled to 4 males + 4 females; male pups are numbered 1 through 4, female pups 5 through 8.

▼ M5

Appendix 2

Definitions

Chemical: A substance or a mixture

Test chemical: Any substance or mixture tested using this test method

▼ M5**B.54 UTEROTROPHIC BIOASSAY IN RODENTS: A SHORT-TERM SCREENING TEST FOR OESTROGENIC PROPERTIES**

INTRODUCTION

1. This test method is equivalent to OECD Test Guideline (TG) 440 (2007). The OECD initiated a high-priority activity in 1998 to revise existing guidelines and to develop new guidelines for the screening and testing of potential endocrine disruptors (1). One element of the activity was to develop a test guideline for the rodent Uterotrophic Bioassay. The rodent Uterotrophic Bioassay then underwent an extensive validation programme including the compilation of a detailed background document (2)(3) and the conduct of extensive intra- and interlaboratory studies to show the relevance and reproducibility of the bioassay with a potent reference oestrogen, weak oestrogen receptor agonists, a strong oestrogen receptor antagonist, and a negative reference chemical (4)(5)(6)(7)(8)(9). This test method B.54 is the outcome of the experience gained during the validation test programme and the results obtained thereby with oestrogenic agonists.
2. The Uterotrophic Bioassay is a short-term screening test that originated in the 1930s (27)(28) and was first standardised for screening by an expert committee in 1962 (32)(35). It is based on the increase in uterine weight or uterotrophic response (for review, see 29). It evaluates the ability of a chemical to elicit biological activities consistent with agonists or antagonists of natural oestrogens (e.g. 17 β -estradiol), however, its use for antagonist detection is much less common than for agonists. The uterus responds to oestrogens in two ways. An initial response is an increase in weight due to water imbibition. This response is followed by a weight gain due to tissue growth (30). The uterus responses in rats and mice qualitatively are comparable.
3. This bioassay serves as an *in vivo* screening assay and its application should be seen in the context of the 'OECD Conceptual Framework for the Testing and Assessment of Endocrine Disrupting Chemicals' (Appendix 2). In this Conceptual Framework the Uterotrophic Bioassay is contained in Level 3 as an *in vivo* assay providing data about a single endocrine mechanism, i.e. oestrogenicity.
4. The Uterotrophic Bioassay is intended to be included in a battery of *in vitro* and *in vivo* tests to identify chemicals with potential to interact with the endocrine system, ultimately leading to risk assessments for human health or the environment. The OECD validation programme used both strong and weak oestrogen agonists to evaluate the performance of the assay to identify oestrogenic chemicals (4)(5)(6)(7)(8). Thereby the sensitivity of the test procedure for oestrogen agonists was well demonstrated besides a good intra- and interlaboratory reproducibility.
5. With regard to negative chemicals, only one 'negative' reference chemical already reported negative by uterotrophic assay as well as *in vitro* receptor binding and receptor assays was included in the validation programme, but additional test data, not related to the OECD validation programme, have been evaluated, giving further support to the specificity of the Uterotrophic Bioassay for the screening of oestrogen agonists (16).

▼ M5

INITIAL CONSIDERATIONS AND LIMITATIONS

6. Oestrogen agonists and antagonists act as ligands for oestrogen receptors a and b and may activate or inhibit, respectively, the transcriptional action of the receptors. This may have the potential to lead to adverse health hazards, including reproductive and developmental effects. Therefore, the need exists to rapidly assess and evaluate a chemical as a possible oestrogen agonist or antagonist. While informative, the affinity of a ligand for an oestrogen receptor or transcriptional activation of reporter genes *in vitro* is only one of several determinants of possible hazard. Other determinants can include metabolic activation and deactivation upon entering the body, distribution to target tissues, and clearance from the body, depending at least in part on the route of administration and the chemical being tested. This leads to the need to screen the possible activity of a chemical *in vivo* under relevant conditions, unless the chemical's characteristics regarding Absorption — Distribution — Metabolism — Elimination (ADME) already provide appropriate information. Uterine tissues respond with rapid and vigorous growth to stimulation by oestrogens, particularly in laboratory rodents, where the oestrous cycle lasts approximately 4 days. Rodent species, particularly the rat, are also widely used in toxicity studies for hazard characterisation. Therefore, the rodent uterus is an appropriate target organ for the *in vivo* screening of oestrogen agonists and antagonists.

7. This test method is based on those protocols employed in the OECD validation study which have been shown to be reliable and repeatable in intra- and interlaboratory studies (5)(7). Currently two methods, namely the ovariectomised adult female method (ovx-adult method) and the immature non-ovariectomised method (immature method) are available. It was shown in the OECD validation test programme that both methods have comparable sensitivity and reproducibility. However, the immature, as it has an intact hypothalamic-pituitary-gonadal (HPG) axis, is somewhat less specific but covers a larger scope of investigation than the ovariectomised animal because it can respond to chemicals that interact with the HPG axis rather than just the oestrogen receptor. The HGP axis of the rat is functional at about 15 days of age. Prior to that, puberty cannot be accelerated with treatments like GnRH. As the females begin to reach puberty, prior to vaginal opening, the female will have several silent cycles that do not result in vaginal opening or ovulation, but there are some hormonal fluctuations. If a chemical stimulates the HPG axis directly or indirectly, precocious puberty, early ovulation and accelerated vaginal opening result. Not only chemicals that act on the HPG axis do this but some diets with higher metabolisable energy levels than others will stimulate growth and accelerate vaginal opening without being oestrogenic. Such chemicals would not induce an uterotrophic response in OVX adult animals as their HPG axis does not work.

8. For animal welfare reasons preference should be given to the method using immature rats, avoiding surgical pre-treatment of the animals and avoiding also a possible non-use of those animals which indicate any evidence entering oestrous (see paragraph 30).

▼ M5

9. The uterotrophic response is not entirely of oestrogenic origin, i.e. chemicals other than agonists or antagonists of oestrogens may also provide a response. For example, relatively high doses of progesterone, testosterone, or various synthetic progestins may all lead to a stimulative response (30). Any response may be analysed histologically for keratinisation and cornification of the vagina (30). Irrespective of the possible origin of the response, a positive outcome of an Uterotrophic Bioassay should normally initiate actions for further clarification. Additional evidence of oestrogenicity could come from *in vitro* assays, such as the ER binding assays and transcriptional activation assays, or from other *in vivo* assays such as the female pubertal assay.

10. Taking into account that the Uterotrophic Bioassay serves as an *in vivo* screening assay, the validation approach taken served both animal welfare considerations and a tiered testing strategy. To this end, effort was directed at rigorously validating reproducibility and sensitivity for oestrogenicity — the main concern for many chemicals-, while little effort was directed at the antioestrogenicity component of the assay. Only one antioestrogen with strong activity was tested since the number of chemicals with a clear antioestrogenic profile (not obscured by some oestrogenic activity) is very limited. Thus this test method is dedicated to the oestrogenic protocol, while the protocol describing the antagonist mode of the assay is included in a Guidance Document (37). The reproducibility and sensitivity of the assay for chemicals with purely anti-oestrogenic activity will be more clearly defined later on, after the test procedure has been in routine use for some time and more chemicals with this modality of action are identified.

11. It is acknowledged that all animal based procedures will conform to local standards of animal care; the descriptions of care and treatment set forth below are minimal performance standards, and will be superseded by local regulations such as Directive 2010/63/EU of the European Parliament and of the Council of 22 September 2010 on the protection of animals used for scientific purposes (38). Further guidance of the humane treatment of animals is given by the OECD (25).

12. As with all assays using live animals, it is essential to ensure that the data are truly necessary prior to the start of the assay. For example, two conditions where the data may be required are:
 - high exposure potential (Level 1 of the Conceptual Framework, Appendix 2) or indications for oestrogenicity (Level 2) to investigate whether such effects may occur *in vivo*;

 - effects indicating oestrogenicity in Level 4 or 5 *in vivo* tests to substantiate that the effects were related to an oestrogenic mechanism that cannot be elucidated using an *in vitro* test.

13. Definitions used in this test method are given in Appendix 1.

▼ M5**PRINCIPLE OF THE TEST**

14. The Uterotrophic Bioassay relies for its sensitivity on an animal test system in which the hypothalamic-pituitary-ovarian axis is not functional, leading to low endogenous levels of circulating oestrogen. This will ensure a low baseline uterine weight and a maximum range of response to administered oestrogens. Two oestrogen sensitive states in the female rodent meet this requirement:
 - (i) immature females after weaning and prior to puberty; and
 - (ii) young adult females after ovariectomy with adequate time for uterine tissues to regress.

15. The test chemical is administered daily by oral gavage or subcutaneous injection. Graduated test chemical doses are administered to a minimum of two treatment groups (see paragraph 33 for guidance) of experimental animals using one dose level per group and an administration period of three consecutive days for immature method and a minimum administration period of three consecutive days for ovx-adult method. The animals are necropsied approximately 24 hours after the last dose. For oestrogen agonists, the mean uterine weight of the treated animal groups relative to the vehicle group is assessed for a statistically significant increase. A statistically significant increase in the mean uterine weight of a test group indicates a positive response in this bioassay.

DESCRIPTION OF THE METHOD**Selection of animal species**

16. Commonly used laboratory rodent strains may be used. As an example, Sprague-Dawley and Wistar strains of rats were used during the validation. Strains with uteri known or suspected to be less responsive should not be used. The laboratory should demonstrate the sensitivity of the strain used as described in paragraphs 26 and 27.

17. The rat and mouse have been routinely used in the Uterotrophic Bioassay since the 1930s. The OECD validation studies were only performed with rats based on an understanding that both species are expected to be equivalent and therefore one species should be enough for the world-wide validation in order to save resources and animals. The rat is the species of choice in most reproductive and developmental toxicity studies. Taking into consideration that a vast historical database exists for mice and thus to broaden the scope of the Uterotrophic Bioassay test method in rodents to the use of mice as test species, a limited follow-up validation study was carried out in mice (16). A bridging approach with a limited number of test chemicals, participating laboratories and without coded sample testing has been selected in keeping with the original intent to save resources and animals. This bridging validation study shows for the Uterotrophic Bioassay in young adult ovariectomised mice that, qualitatively and quantitatively, the data obtained in rats and mice correspond well with each other. Where the Uterotrophic Bioassay result may be preliminary to a long-term study, this allows animals from the same strain and source to be used in both studies. The bridging approach was limited to the OVX mice and the report does not provide a robust data set to validate the immature model, thus the immature model for mice is not considered under the scope of the current test method.

▼ M5

18. Thus, in some cases mice may be used instead of rats. A rationale should be given for this species, based on toxicological, pharmacokinetic, and/or other criteria. Modifications of the protocol may be necessary for mice. For example, the food consumption of mice on a body weight basis is higher than that of rats and therefore the phyto-oestrogen content in food should be lower for mice than for rats (9)(20)(22).

Housing and feeding conditions

19. All procedures should conform with local standards of laboratory animal care. These descriptions of care and treatment are minimum standards and will be superseded by local regulations such as Directive 2010/63/EU of the European Parliament and of the Council of 22 September 2010 on the protection of animals used for scientific purposes (38). The temperature in the experimental animal room should be 22 °C (with an approximate range ± 3 °C). The relative humidity should be a minimum of 30 % and preferably should not exceed a maximum 70 %, other than during room cleaning. The aim should be relative humidity of 50-60 %. Lighting should be artificial. The daily lighting sequence should be 12 hours light, 12 hours dark.
20. Laboratory diet and drinking water should be provided *ad libitum*. Young adult animals may be housed individually or be caged in groups of up to three animals. Due to the young age of the immature animals, social group housing is recommended.
21. High levels of phyto-oestrogens in laboratory diets have been known to increase uterine weights in rodents to a degree enough as to interfere with the Uterotrophic Bioassay (13)(14)(15). High levels of phyto-oestrogens and of metabolisable energy in laboratory diets may also result in early puberty, if immature animals are used. The presence of phyto-oestrogens results primarily from the inclusion of soy and alfalfa products in the laboratory diets and concentrations of phyto-oestrogens have been shown to vary from batch-to-batch of standard laboratory diets (23). Body weight is an important variable, as the quantity of food consumed is related to body weight. Therefore, the actual phyto-oestrogen dose consumed from the same diet may vary among species and by age (9). For immature female rats, food consumption on a body weight basis may be approximately double that of ovariectomised young adult females. For young adult mice, food consumption on a body weight basis may be approximately quadruple that of ovariectomised young adult female rats.
22. Uterotrophic Bioassay results (9)(17)(18)(19), however, show that limited quantities of dietary phyto-oestrogens are acceptable and do not reduce the sensitivity of the bioassay. As a guide, dietary levels of phyto-oestrogens should not exceed 350 μg of genistein equivalents/gram of laboratory diet for immature female Sprague Dawley and Wistar rats (6)(9). Such diets should also be appropriate when testing in young adult ovariectomised rats because food consumption on a body weight basis is less in young adult as compared to immature animals. If adult ovariectomised mice or more phyto-oestrogen-sensitive rats are to be used, proportional reduction in dietary phyto-oestrogen levels must be considered (20). In addition, the differences in available metabolic energy from different diets may lead to time shifts for the onset of puberty (21)(22).

▼ M5

23. Prior to the study, careful selection is required of a diet without an elevated level of phyto-oestrogens (for guidance see (6)(9)) or metabolisable energy, that can confound the results (15)(17)(19)(22)(36). Ensuring the proper performance of the test system used by the laboratory as specified in paragraphs 26 and 27 is an important check on both of these factors. As a safeguard consistent with good laboratory practice (GLP) representative sampling of each batch of diet administered during the study should be conducted for possible analysis of phyto-oestrogen content (e.g. in the case of high uterine control weight relative to historic controls or an inadequate response to the reference oestrogen, 17 alpha ethinyl estradiol). Aliquots should be analysed as part of the study or frozen at -20°C or in such a way as to prevent the sample from decomposing prior to analysis.
24. Some bedding materials may contain naturally occurring oestrogenic or antioestrogenic chemicals (e.g. corn cob is known to affect the cyclicity of rats and appears to be antioestrogenic). The selected bedding material should contain a minimum level of phyto-oestrogens.

Preparation of animals

25. Experimental animals without evidence of any disease or physical abnormalities are randomly assigned to the control and treatment groups. Cages should be arranged in such a way that possible effects due to cage placement are minimised. The animals should be identified uniquely. Preferably, immature animals should be caged with dams or foster dams until weaning during acclimatisation. The acclimatisation period prior to the start of the study should be about 5 days for young adult animals and for the immature animals delivered with dams or foster dams. If immature animals are obtained as weanlings without dams a shorter duration of the acclimatisation period may become necessary as dosing should start immediately after weaning (see paragraph 29).

PROCEDURE**Verification of Laboratory Proficiency**

26. Two different options can be used to verify laboratory proficiency:
- Periodic verification, relying on an initial baseline positive control study (see paragraph 27). At least every 6 months and each time there is a change that may influence the performance of the assay (e.g. a new formulation of diet, change in personnel performing dissections, change in animal strain or supplier, etc.), the responsiveness of the test system (animal model) should be verified using an appropriate dose (based on the baseline positive control study described in paragraph 27) of a reference oestrogen: 17 α -ethinyl estradiol (CAS No 57-63-6) (EE).
 - Use of concurrent controls, by including a group administered with an appropriate dose of reference oestrogen in each assay.

If the system does not respond as expected, the experimental conditions should be examined and modified accordingly. It is recommended that the dose of reference oestrogen to be used in either approach be approximately the ED70 to 80.

▼ M5

27. **Baseline Positive Control Study** — Before a laboratory conducts a study under this test method for the first time, laboratory proficiency should be demonstrated by testing the responsiveness of the animal model, by establishing the dose response of a reference oestrogen: 17 α -ethinyl estradiol (CAS No 57-63-6) (EE) with a minimum of four doses. The uterine weight response will be compared to established historical data (see reference (5)). If this baseline positive control study does not yield the anticipated results the experimental conditions should be examined and modified.

Number and condition of animals

28. Each treated and control group should include at least 6 animals (for both immature and ovx-adult method protocols).

Age of immature animals

29. For the Uterotrophic Bioassay with immature animals the day of birth must be specified. Dosing should begin early enough to ensure that, at the end of test chemical administration, the physiological rise of endogenous oestrogens associated with puberty has not yet taken place. On the other hand, there is evidence that very young animals may be less sensitive. For defining the optimal age each laboratory should take its own background data on maturation into consideration.

As a general guide, dosing in rats may begin immediately after early weaning on postnatal day 18 (with the day of birth being postnatal day 0). Dosing in rats preferably should be completed on postnatal day 21 but in any case prior to postnatal day 25, because, after this age, the hypothalamic-pituitary-ovarian axis becomes functional and endogenous oestrogen levels may begin to rise with a concomitant increase in baseline uterine weight means and an increase in the group standard deviations (2)(3)(10)(11)(12).

Procedure for ovariectomy

30. For the ovariectomised female rat and mouse (treatment and control groups), ovariectomy should occur between 6 and 8 weeks of age. For rats, a minimum of 14 days should elapse between ovariectomy and the first day of administration in order to allow the uterus to regress to a minimum, stable baseline. For mice, at least 7 days should elapse between ovariectomy and the first day of administration. As small amounts of ovarian tissue are sufficient to produce significant circulating levels of oestrogens (3), the animals should be tested prior to use by observing epithelial cells swabbed from the vagina on at least five consecutive days (e.g. days 10-14 after ovariectomy for rats). If the animals indicate any evidence entering oestrous, the animals should not be used. Further, at necropsy, the ovarian stubs should be examined for any evidence that ovarian tissue is present. If so, the animal should not be used in the calculations (3).
31. The ovariectomy procedure begins with the animal in ventral recumbency after the animal has been properly anaesthetised. The incision opening the dorso-lateral abdominal wall should be approximately 1 cm lengthways at the mid-point between the costal inferior border and the iliac crest, and a few millimetres lateral to the lateral margin of the lumbar muscle. The ovary should be removed from the abdominal cavity onto an aseptic field. The ovary should be disconnected at the junction of the oviduct and the uterine body. After confirming that no massive bleeding is occurring, the abdominal wall should be closed by a suture and the skin closed by autoclips or appropriate suture. The ligation points are shown schematically in Figure 1. Appropriate post-operative analgesia should be used as recommended by a veterinarian experienced in rodent care.

▼ M5**Body weight**

32. In the ovx-adult method, body weight and uterine weight are not correlated because uterine weight is affected by hormones like oestrogens but not by the growth factors that regulate body size. On the contrary, body weight is related to uterine weight in the immature model, while it is maturing (34). Thus, at the commencement of the study the weight variation of animals used, in the immature model, should be minimal and not exceed $\pm 20\%$ of the mean weight. This means that the litter size should be standardised by the breeder, to ensure that offspring of different mother animals will be fed approximately the same. Animals should be assigned to groups (both control and treatment) by randomised weight distribution, so that mean body weight of each group is not statistically different from any other group. Consideration should be given to avoid assignment of littermates to the same treatment group as far as practicable without increasing the number of litters to be used for the investigation.

Dosage

33. In order to establish whether a test chemical can have oestrogenic action *in vivo*, two dose groups and a control are normally sufficient and this design is therefore preferred for animal welfare reasons. If the purpose is either to obtain a dose-response curve or to extrapolate to lower doses, at least 3 dose groups are needed. If information beyond identification of oestrogenic activity (such as an estimate of potency) is required, a different dosing regimen should be considered. Except for treatment with the test chemical, animals in the control group should be handled in an identical manner to the test group subjects. If a vehicle is used in administering the test chemical, the control group should receive the same amount of vehicle used with the treated groups (or highest volume used with the test groups if different among groups).

34. The objective in the case of the Uterotrophic Bioassay is to select doses that ensure animal survival and that are without significant toxicity or distress to the animals after three consecutive days of chemical administration up to a maximum dose of 1 000 mg/kg/d. All dose levels should be proposed and selected taking into account any existing toxicity and (toxico-) kinetic data available for the test chemical or related materials. The highest dose level should first take into consideration the LD50 and/or acute toxicity information in order to avoid death, severe suffering or distress in the animals (24)(25)(26). The highest dose should represent the maximum tolerated dose (MTD); a study conducted at a dose level that induced a positive uterotrophic response would be accepted too. As a screen, large intervals (e.g. one half log units corresponding to a dose progression of 3,2 or even up to one log units) between dosages are generally acceptable. If there are no suitable data available, a range finding study may be performed to aid the determination of the doses to be used.

35. Alternatively, if the oestrogenic potency of an agonist can be estimated by *in vitro* (or *in silico*) data, these may be taken into consideration for dose selection. For example, the amount of the test chemical that would produce uterotrophic responses equivalent to the reference agonist (ethinyl estradiol) is estimated by its relative *in vitro* potencies to ethinyl estradiol. The highest test dose would be given by multiplying this equivalent dose by an appropriate factor e.g. 10 or 100.

▼ M5**Considerations for range finding**

36. If necessary, a preliminary range finding study can be carried out with few animals. In this respect, OECD Guidance Document No 19(25) may be used defining clinical signs indicative of toxicity or distress to the animals. If feasible within this range finding study after three days of administration, the uteri may be excised and weighed approximately 24-hours after the last dose. These data could then be used to assist the main study design (select an acceptable maximum and lower doses and recommend the number of dose groups).

Administration of doses

37. The test chemical is administered by oral gavage or subcutaneous injection. Animal welfare considerations as well as toxicological aspects like the relevance to the human route of exposure to the chemical (e.g. oral gavage to model ingestion, subcutaneous injection to model inhalation or dermal adsorption), the physical/chemical properties of the test material and especially existing toxicological information and data on metabolism and kinetics (e.g. need to avoid first pass metabolism, better efficiency via a particular route) have to be taken into account when choosing the route of administration.
38. It is recommended that, wherever possible, the use of an aqueous solution/suspension be considered first. But as most oestrogen ligands or their metabolic precursors tend to be hydrophobic, the most common approach is to use a solution/suspension in oil (e.g. corn, peanut, sesame or olive oil). However, these oils have different caloric and fat content, thus the vehicle might affect total metabolisable energy (ME) intake, thereby potentially altering measured endpoints such as the uterine weight especially in the immature method (33). Thus, prior to the study, any vehicle to be used should be tested against controls without vehicles. Test chemicals can be dissolved in a minimal amount of 95 % ethanol or other appropriate solvents and diluted to final working concentrations in the test vehicle. The toxic characteristics of the solvent must be known, and should be tested in a separate solvent-only control group. If the test chemical is considered stable, gentle heating and vigorous mechanical action can be used to assist in dissolving the test chemical. The stability of the test chemical in the vehicle should be determined. If the test chemical is stable for the duration of the study, then one starting aliquot of the test chemical may be prepared, and the specified dosage dilutions prepared daily.
39. Dosage timing will depend of the model used (refer to paragraph 29 for the immature model and to paragraph 30 for ovx-adult model). Immature female rats are dosed with the test chemical daily for three consecutive days. A three-day treatment is also recommended for ovariectomised female rats but longer exposures are acceptable and may improve the detection of weakly active chemicals. With ovariectomised female mice, an application duration of 3 days should be sufficient without a significant advantage by an extension of up to seven days for strong oestrogen agonists, however, this relation was not demonstrated for weak oestrogens in the validation study (16) thus dosage should be extended up to 7 consecutive days in ovx-adult mice. The dose should be given at similar times each day. They should be adjusted as necessary to maintain a constant dose level in terms of animal body weight (e.g. mg of test chemical per kg of body weight per day). Regarding the test volume, its variability, on a body weight basis, should be minimised by adjusting the concentration of the dosing solution to ensure a constant volume on a body weight basis at all dose levels and for any route of administration.

▼ M5

40. When the test chemical is administered by gavage, this should be done in a single daily dose to the animals using a stomach tube or a suitable intubation cannula. The maximum volume of liquid that can be administered at one time depends on the size of the test animal. Local animal care guidelines should be followed, but the volume should not exceed 5 ml/kg body weight, except in the case of aqueous solutions where 10 ml/kg body weight may be used.

41. When the test chemical is administered by subcutaneous injection, this should be done in a single daily dose. Doses should be administered to the dorsoscapular or lumbar regions via sterile needle (e.g. 23- or 25-gauge) and a tuberculin syringe. Shaving the injection site is optional. Any losses, leakage at the injection site or incomplete dosing should be recorded. The total volume injected per rat per day should not exceed 5 ml/kg body weight, divided into 2 injection sites, except in the case of aqueous solutions where 10 ml/kg body weight may be used.

Observations*General and clinical observations*

42. General clinical observations should be made at least once a day and more frequently when signs of toxicity are observed. Observations should be carried out preferably at the same time(s) each day and considering the period of anticipated peak effects after dosing. All animals are to be observed for mortality, morbidity and general clinical signs such as changes in behaviour, skin, fur, eyes, mucous membranes, occurrence of secretions and excretions and autonomic activity (e.g. lacrimation, piloerection, pupil size, unusual respiratory pattern).

Body weight and food consumption

43. All animals should be weighed daily to the nearest 0,1 g, starting just prior to initiation of treatment i.e. when the animals are allocated into groups. As an optional measurement, the amount of food consumed during the treatment period may be measured per cage by weighing the feeders. The food consumption results should be expressed in grams per rat per day.

Dissection and measurement of uterus weight

44. Twenty-four hours after the last treatment, the rats will be humanely killed. Ideally, the necropsy order will be randomised across groups to avoid progression directly up or down dose groups that could subtly affect the data. The bioassay objective is to measure both the wet and blotted uterus weights. The wet weight includes the uterus and the luminal fluid contents. The blotted weight is measured after the luminal contents of the uterus have been expressed and removed.

45. Before dissection the vagina will be examined for opening status in immature animals. The dissection procedure begins by opening the abdominal wall starting at the pubic symphysis. Then, uterine horn and ovaries, if present, are detached from the dorsal abdominal wall. The urinary bladder and ureters are removed from the ventral and lateral side of uterus and vagina. Fibrous adhesion between the rectum and the vagina is detached until the junction of vaginal orifice and perineal skin can be identified. The uterus and vagina are detached from the body by incising the vaginal wall just above the junction between perineal skin as shown in

▼ **M5**

Figure 2. The uterus should be detached from the body wall by gently cutting the uterine mesentery at the point of its attachment along the full length of the dorsolateral aspect of each uterine horn. Once removed from the body, uterine handling should be sufficiently rapid to avoid desiccation of the tissues. Loss of weight due to desiccation becomes more important with small tissues such as the uterus (23). If ovaries are present, the ovaries are removed at the oviduct avoiding loss of luminal fluid from the uterine horn. If the animal has been ovariectomised, the stubs should be examined for the presence of any ovarian tissue. Excess fat and connective tissue should be trimmed away. The vagina is removed from the uterus just below the cervix so that the cervix remains with the uterine body as shown in Figure 2.

46. Each uterus should be transferred to a uniquely marked and weighed container (e.g. a petri-dish or plastic weight boat) with continuing care to avoid desiccation before weighing (e.g. filter paper slightly dampened with saline may be placed in the container). The uterus with luminal fluid will be weighed to the nearest 0,1 mg (wet uterine weight).
47. Each uterus will then be individually processed to remove the luminal fluid. Both uterine horns will be pierced or cut longitudinally. The uterus will be placed on lightly moistened filter paper (e.g. Whatman No 3) and gently pressed with a second piece of lightly moistened filter paper to completely remove the luminal fluid. The uterus without the luminal contents will be weighed to the nearest 0,1 mg (blotted uterine weight).
48. The uterus weight at termination can be used to ensure that the appropriate age in the immature intact rat was not exceeded, however, the historical data of the rat strain used by the laboratory are decisive in this respect (see paragraph 56 for interpretation of the results).

Optional investigations

49. After weighing, the uterus may be fixed in 10 % neutral buffered formalin to be examined histopathologically after Haematoxylin & Eosin (HE)-staining. The vagina may be investigated accordingly (see paragraph 9). In addition, morphometric measurement of endometrial epithelium may be done for quantitative comparison.

DATA AND REPORTING

Data

50. Study data should include:

- the number of animals at the start of the assay,
- the number and identity of animals found dead during the assay or killed for humane reasons and the date and time of any death or humane kill,
- the number and identity of animals showing signs of toxicity, and a description of the signs of toxicity observed, including time of onset, duration, and severity of any toxic effects, and
- the number and identity of animals showing any lesions and a description of the type of lesions.

▼ M5

51. Individual animal data should be recorded for the body weights, the wet uterine weight, and the blotted uterine weight. One-tailed statistical analyses for agonists should be used to determine whether the administration of a test chemical resulted in a statistically significant ($p < 0,05$) increase in the uterine weight. Appropriate statistical analyses should be carried out to test for treatment related changes in blotted and wet uterine weight. For example, the data may be evaluated by an analysis of covariance (ANCOVA) approach with body weight at necropsy as the co-variable. A variance-stabilising logarithmic transformation may be carried out on the uterine data prior to the data analysis. Dunnett and Hsu's test are appropriate for making pair wise comparisons of each dosed group to vehicle controls and to calculate the confidence intervals. Studentised residual plots can be used to detect possible outliers and to assess homogeneity of variances. These procedures were applied in the OECD validation programme using the PROC GLM in the Statistical Analysis System (SAS Institute, Cary, NC), version 8 (6)(7).

52. A final report shall include:

Testing facility:

- Responsible personnel and their study responsibilities
- Data from the Baseline Positive Control Test and periodic positive control data (see paragraphs 26 and 27)

Test chemical:

- Characterisation of test chemicals
- Physical nature and where relevant physicochemical properties
- Method and frequency of preparation of dilutions
- Any data generated on stability
- Any analyses of dosing solutions

Vehicle:

- Characterisation of test vehicle (nature, supplier and lot)
- Justification of choice of vehicle (if other than water)

Test animals:

- Species and strain and justification for their choice
- Supplier and specific supplier facility
- Age on supply with birth date
- If immature animals, whether or not supplied with dam or foster dam and date of weaning
- Details of animal acclimatisation procedure
- Number of animals per cage
- Detail and method of individual animal and group identification

Assay Conditions:

- Details of randomisation process (i.e. method used)
- Rationale for dose selection

▼ M5

- Details of test chemical formulation, its achieved concentrations, stability and homogeneity
- Details of test chemical administration and rationale for the choice of exposure route
- Diet (name, type, supplier, content, and, if known, phyto-oestrogen levels)
- Water source (e.g. tap water or filtered water) and supply (by tubing from a large container, in bottles, etc.)
- Bedding (name, type, supplier, content)
- Record of caging conditions, lighting interval, room temperature and humidity, room cleaning
- Detailed description of necropsy and uterine weighing procedures
- Description of statistical procedures

*Results**For individual animals:*

- All daily individual body weights (from allocation into groups through necropsy) (to the nearest 0,1 g)
- Age of each animal (in days counting day of birth as day 0) when administration of test chemical begins
- Date and time of each dose administration
- Calculated volume and dosage administered and observations of any dosage losses during or after administration
- Daily record of status of animal, including relevant symptoms and observations
- Suspected cause of death (if found during study in moribund state or dead)
- Date and time of humane killing with time interval to last dosing
- Wet uterine weight (to the nearest 0,1 mg) and any observations of luminal fluid losses during dissection and preparation for weighing
- Blotted uterine weight (to the nearest 0,1 mg)

For each group of animals:

- Mean daily body weights (to the nearest 0,1 g) and standard deviations (from allocation into groups through necropsy)
- Mean wet uterine weights and mean blotted uterine weights (to the nearest 0,1 mg) and standard deviations
- If measured, daily food consumption (calculated as grams of food consumed per animal)

▼ **M5**

- The results of statistical analyses comparing both the wet and blotted uterine weights of treated groups relative to the same measures in the vehicle control groups.

- The results of statistical analysis comparing the total body weight and the body weight gain of treated groups relative to the same measures in the vehicle control groups.

53. Summary of the important guidance facts of the test method

	Rat	Mice
Animals		
Strain	Commonly used laboratory rodent strain	
Number of animals	A minimum of 6 animals per dose group	
Number of groups	A minimum of 2 test groups (see paragraph 33 for guidance) and a negative control group For guidance on positive control groups see paragraphs 26 and 27	
Housing and feeding conditions		
T° in animal room	22 °C ± 3 °C	
Relative humidity	50-60 % and not below 30 % or above 70 %	
Daily lighting sequence	12 hours light, 12 hours dark	
Diet and drinking water	Ad libitum	
Housing	Individually or in groups of up to three animals (social group housing is recommended for immature animals)	
Diet and bedding	Low level of phyto-oestrogens recommended in diet and bedding	
Protocol		
Method	Immature non-ovariectomised method (the preferred one). Ovariectomised adult female method	Ovariectomised adult female method
Age of dosing for immature animals	PND 18 at the earliest. Dosing should be completed prior to PND 25	Not relevant under the scope of the current test method.
Age of ovariectomy	Between 6 and 8 weeks of age.	
Age of dosing for ovariectomised animals	A minimum of 14 days should elapse between ovariectomy and the 1 st day of administration.	A minimum of 7 days should elapse between ovariectomy and the 1 st day of administration.
Body weight	Body weight variation should be minimal and not exceed ± 20 % of the mean weight.	

▼ **M5**

	Rat	Mice
Dosing		
Route of administration	Oral gavage or subcutaneous injection	
Frequency of administration	Single daily dose	
Volume amount for gavage and injection	≤ 5 ml/kg body weight (or up to 10 ml/kg body weight in case of aqueous solutions) (in 2 injection sites for subcutaneous route)	
Duration of administration	3 consecutive days for immature model Minimum of 3 consecutive days for the OVX model	7 consecutive days for the OVX model
Time of necropsy	Approximately 24 hours after the last dose	
Results		
Positive response	Statistically significant increase of the mean uterus weight (wet and/or blotted)	
Reference oestrogen	17 α -ethinyl estradiol	

GUIDANCE FOR THE INTERPRETATION AND ACCEPTANCE OF THE RESULTS

54. In general, a test for oestrogenicity should be considered positive if there is a statistically significant increase in uterine weight ($p < 0,05$) at least at the high dose level as compared to the solvent control group. A positive result is further supported by the demonstration of a biologically plausible relationship between the dose and the magnitude of the response, bearing in mind that overlapping oestrogenic and antioestrogenic activities of the test chemical may affect the shape of the dose-response curve.
55. Care must be taken in order not to exceed the maximum tolerated dose to allow a meaningful interpretation of the data. Reduction of body weight, clinical signs and other findings should be thoroughly assessed in this respect.
56. An important consideration for the acceptance of the data from the Uterotrophic Bioassay is the uterine weights of the vehicle control group. High control values may compromise the responsiveness of the bioassay and the ability to detect very weak oestrogen agonists. Literature reviews and the data generated during the validation of the Uterotrophic Bioassay suggest that instances of high control means do occur spontaneously, particularly in immature animals (2)(3)(6)(9). As the uterine weight of immature rats depends on many variables like strain or body weight, no definitive upper limit for the uterine weight can be given. As a guide, if blotted uterine weights in immature control rats are comprised between 40 and 45 mg, results should be considered as suspicious and uterine weights above 45 mg may lead to rerun the test. However, this needs to be considered on a case by case basis (3)(6)(8). When testing in adult rats incomplete ovariectomy will leave ovarian tissue that can produce endogenous oestrogen and retard the regression of the uterine weight.

▼ **M5**

57. Blotted vehicle control uterine weights less than 0,09 % of body weight for immature female rats and less than 0,04 % for ovariectomised young adult females appear to yield acceptable results (see Table 31 (2)). If the control uterine weights are greater than these numbers, various factors should be scrutinised including the age of the animals, proper ovariectomy, dietary phyto-oestrogens, and so on, and a negative assay result (no indication for oestrogenic activity) should be used with caution.
58. Historical data for vehicle control groups should be maintained in the laboratory. Historical data for responses to positive reference oestrogens, such as 17 α -ethinyl estradiol, should also be maintained in the laboratory. Laboratories may also test the response to known weak oestrogen agonists. All these data can be compared to available data (2)(3)(4)(5)(6)(7)(8) to ensure that the laboratory's methods yield sufficient sensitivity.
59. The blotted uterine weights showed less variability in the course of the OECD validation study than the wet uterine weights (6)(7). However, a significant response in either measure would indicate that the test chemical is positive for oestrogenic activity.
60. The uterotrophic response is not entirely of oestrogenic origin, however, a positive result of the Uterotrophic Bioassay should generally be interpreted as evidence for oestrogenic potential *in vivo*, and should normally initiate actions for further clarification (see paragraph 9 and the 'OECD Conceptual Framework for the Testing and Assessment of Endocrine Disrupting Chemicals', Annex 2).

Figure 1

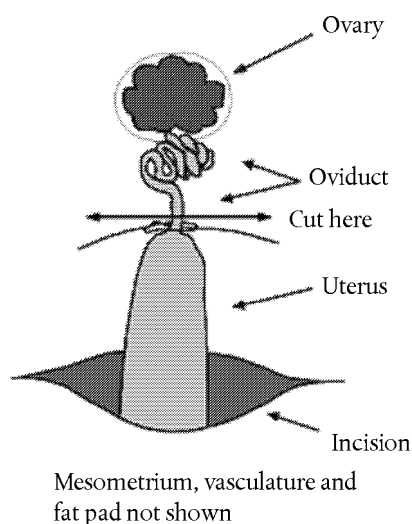
Schematic diagram showing the surgical removal of the ovaries

The procedure begins by opening dorso-lateral abdominal wall at the mid-point between the costal inferior border and the iliac crest, and a few millimetres lateral to the lateral margin of the lumbar muscle. Within the abdominal cavity, the ovaries should be located. On an aseptic field, the ovaries are then physically removed from the abdominal cavity, a ligature placed between the ovary and uterus to control bleeding, and the ovary detached by incision above the ligature at the junction of the oviduct and each uterine horn. After confirming that no significant bleeding persists, the abdominal wall should be closed by suture, and the skin closed, e.g. by autoclips or suture. The animals should be allowed to recover and the uterus weight to regress for a minimum of 14 days before use.

▼ M5

Figure 2

The removal and preparation of the uterine tissues for weight measurement.

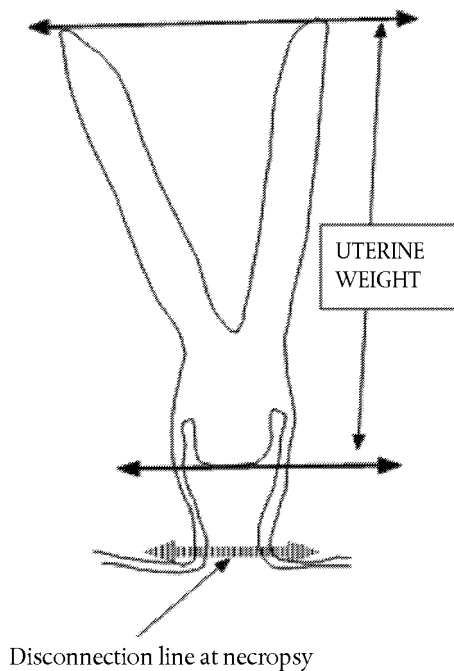

The procedure begins by opening the abdominal wall at the pubic symphysis. Then, each ovary, if present and uterine horn is detached from the dorsal abdominal wall. Urinary bladder and ureters are removed from the ventral and lateral side of uterus and vagina. Fibrous adhesion between the rectum and the vagina are detached until the junction of vaginal orifice and perineal skin can be identified. The uterus and vagina are detached from the body by incising the vaginal wall just above the junction between perineal skin as shown in the figure. The uterus should be detached from the body wall by gently cutting the uterine mesentery at the point of its attachment along the full length of the dorsolateral aspect of each uterine horn. After removal from the body, the excess fat and connective tissue is trimmed away. If ovaries are present, the ovaries are removed at the oviduct avoiding loss of luminal fluid from the uterine horn. If the animal has been ovariectomised, the stubs should be examined for the presence of any ovarian tissue. The vagina is removed from the uterus just below the cervix so that the cervix remains with the uterine body as shown in the figure. The uterus can then be weighed.

▼ **M5***Appendix 1*

DEFINITIONS:

Antioestrogenicity is the capability of a chemical to suppress the action of estradiol 17 β in a mammalian organism.

Chemical means a substance or a mixture.

Date of birth is postnatal day 0.

Dosage is a general term comprising of dose, its frequency and the duration of dosing.

Dose is the amount of test chemical administered. For the Uterotrophic Bioassay, the dose is expressed as weight of test chemical per unit body weight of test animal per day (e.g. mg/kg body weight/day).

Maximum Tolerable Dose (MTD) is the highest amount of a chemical that, when introduced into the body does not kill test animals (denoted by LD₀) (IUPAC, 1993)

Oestrogenicity is the capability of a chemical to act like estradiol 17 β in a mammalian organism.

Postnatal day X is the Xth day of life after the day of birth.

Sensitivity is the proportion of all positive/active chemicals that are correctly classified by the test. It is a measure of accuracy for a test method that produces categorical results, and is an important consideration in assessing the relevance of a test method.

Specificity is the proportion of all negative/inactive chemicals that are correctly classified by the test. It is a measure of accuracy for a test method that produces categorical results and is an important consideration in assessing the relevance of a test method.

Test chemical means any substance or mixture tested using this test method.

Uterotrophic is a term used to describe a positive influence on the growth of uterine tissues.

Validation is a scientific process designed to characterise the operational requirements and limitations of a test method and to demonstrate its reliability and relevance for a particular purpose.

Appendix 2

Note: Document prepared by the Secretariat of the Test Guidelines Programme based on the agreement reached at the 6th Meeting of the EDTA Task Force

OECD Conceptual Framework for the Testing and Assessment of Endocrine Disrupting Chemicals

<p>Level 1 Sorting & prioritization based upon existing information</p>	<ul style="list-style-type: none"> — physical & chemical properties, e.g., MW, reactivity, volatility, biodegradability, — human & environmental exposure, e.g., production volume, release, use patterns — hazard, e.g., available toxicological data 	
<p>Level 2 <i>In vitro</i> assays providing mechanistic data</p>	<ul style="list-style-type: none"> — ER, AR, TR receptor binding affinity — Transcriptional activation — Aromatase and steroidogenesis <i>in vitro</i> — Aryl hydrocarbon receptor recognition/binding — QSARs 	<ul style="list-style-type: none"> — High Through Put Prescreens — Thyroid function — Fish hepatocyte VTG assay — Others (as appropriate)
<p>Level 3 <i>In vivo</i> assays providing data about single endocrine Mechanisms and effects</p>	<ul style="list-style-type: none"> — Uterotrophic assay (estrogenic related) — Hershberger assay (androgenic related) — Non -receptor mediated hormone function — Others (e.g. thyroid) 	<ul style="list-style-type: none"> — Fish VTG (vitellogenin) assay (estrogenic related)
<p>Level 4 <i>In vivo</i> assays providing data about multiple endocrine Mechanisms and effects</p>	<ul style="list-style-type: none"> — enhanced OECD 407 (endpoints based on endocrine mechanisms) — male and female pubertal assays — adult intact male assay 	<ul style="list-style-type: none"> — Fish gonadal histopathology assay — Frog metamorphosis assay
<p>Level 5 <i>In vivo</i> assays providing data on effects from endocrine & other mechanisms</p>	<ul style="list-style-type: none"> — 1-generation assay (TG415 enhanced)¹ — 2-generation assay (TG416 enhanced)¹ — reproductive screening test (TG421 enhanced)¹ — combined 28 day/reproduction screening test (TG 422 enhanced)¹ <p>¹ Potential enhancements will be considered by VMG mamm</p>	<ul style="list-style-type: none"> — Partial and full life cycle assays in fish, birds, amphibians & invertebrates (developmental and reproduction)

VMG mamm: Validation Management Group on Mammalian Testing and Assessment

▼ M5

NOTES TO THE FRAMEWORK:

- Note 1:* Entering at all levels and exiting at all levels is possible and depends upon the nature of existing information needs for hazard and risk assessment purposes
- Note 2:* In level 5, ecotoxicology should include endpoints that indicate mechanisms of adverse effects, and potential population damage
- Note 3:* When a multimodal model covers several of the single endpoint assays, that model would replace the use of those single endpoint assays
- Note 4:* The assessment of each chemical should be based on a case by case basis, taking into account all available information, bearing in mind the function of the framework levels.
- Note 5:* The framework should not be considered as all inclusive at the present time. At levels 3, 4 and 5 it includes assays that are either available or for which validation is under way. With respect to the latter, these are provisionally included. Once developed and validated, they will be formally added to the framework.
- Note 6:* Level 5 should not be considered as including definitive tests only. Tests included at that level are considered to contribute to general hazard and risk assessment.

▼ **M5****LITERATURE**

- (1) OECD (1998). Report of the First Meeting of the OECD Endocrine Disrupter Testing and Assessment (EDTA) Task Force, 10th-11th March 1998, ENV/MC/CHEM/RA(98)5.
- (2) OECD (2003). Detailed Background Review of the Uterotrophic Bioassay: Summary of the Available Literature in Support of the Project of the OECD Task Force on Endocrine Disrupters Testing and Assessment (EDTA) to Standardise and Validate the Uterotrophic Bioassay. OECD Environmental Health and Safety Publication Series on Testing and Assessment No 38. ENV/JM/MONO(2003)1.
- (3) Owens JW, Ashby J. (2002). Critical Review and Evaluation of the Uterotrophic Bioassay for the Identification of Possible Estrogen Agonists and Antagonists: In Support of the Validation of the OECD Uterotrophic Protocols for the Laboratory Rodent. Crit. Rev. Toxicol. 32:445-520.
- (4) OECD (2006). OECD Report of the Initial Work Towards the Validation of the Rodent Uterotrophic Assay — Phase 1. OECD Environmental Health and Safety Publication Series on Testing and Assessment No 65. ENV/JM/MONO(2006)33.
- (5) Kanno, J, Onyon L, Haseman J, Fenner-Crisp P, Ashby J, Owens W. (2001). The OECD program to validate the rat uterotrophic bioassay to screen compounds for in vivo estrogenic responses: Phase 1. Environ Health Perspect. 109:785-94.
- (6) OECD (2006). OECD Report of the Validation of the Rodent Uterotrophic Bioassay: Phase 2 — Testing of Potent and Weak Oestrogen Agonists by Multiple Laboratories. OECD Environmental Health and Safety Publication Series on Testing and Assessment No 66. ENV/JM/MONO(2006)34.
- (7) Kanno J, Onyon L, Peddada S, Ashby J, Jacob E, Owens W. (2003). The OECD program to validate the rat uterotrophic bioassay: Phase Two — Dose Response Studies. Environ. Health Persp.111:1530-1549
- (8) Kanno J, Onyon L, Peddada S, Ashby J, Jacob E, Owens W. (2003). The OECD program to validate the rat uterotrophic bioassay: Phase Two — Coded Single Dose Studies. Environ. Health Persp.111:1550-1558.
- (9) Owens W, Ashby J, Odum J, Onyon L. (2003). The OECD program to validate the rat uterotrophic bioassay: Phase Two — Dietary phytoestrogen analyses. Environ. Health Persp. 111:1559-1567.
- (10) Ogasawara Y, Okamoto S, Kitamura Y, Matsumoto K. (1983). Proliferative pattern of uterine cells from birth to adulthood in intact, neonatally castrated, and/or adrenalectomized mice assayed by incorporation of [¹²⁵I]iododeoxyuridine. Endocrinology 113:582-587.
- (11) Branham WS, Sheehan DM, Zehr DR, Ridlon E, Nelson CJ. (1985). The postnatal ontogeny of rat uterine glands and age-related effects of 17β-estradiol. Endocrinology 117:2229-2237.
- (12) Schlumpf M, Berger L, Cotton B, Conscience-Egli M, Durrer S, Fleischmann I, Haller V, Maerkel K, Lichtensteiger W. (2001). Estrogen active UV screens. SÖFW-J. 127:10-15.
- (13) Zarrow MX, Lazo-Wasem EA, Shoger RL. (1953). Estrogenic activity in a commercial animal ration. Science 118:650-651.
- (14) Drane HM, Patterson DSP, Roberts BA, Saba N. (1975). The chance discovery of oestrogenic activity in laboratory rat cake. Fd. Cosmet. Toxicol. 13:425-427.
- (15) Boettger-Tong H, Murphy L, Chiappetta C, Kirkland JL, Goodwin B, Adlercreutz H, Stancel GM, Makela S. (1998). A case of a laboratory animal feed with high estrogenic activity and its impact on *in vivo* responses to exogenously administered estrogens. Environ. Health Perspec.106:369-373.

▼ **M5**

- (16) OECD (2007). Additional data supporting the Test Guideline on the Uterotrophic Bioassay in rodents. OECD Environmental Health and Safety Publication Series on Testing and Assessment No 67.
- (17) Degen GH, Janning P, Diel P, Bolt HM. (2002). Estrogenic isoflavones in rodent diets. *Toxicol. Lett.* 128:145-157.
- (18) Wade MG, Lee A, McMahon A, Cooke G, Curran I. (2003). The influence of dietary isoflavone on the uterotrophic response in juvenile rats. *Food Chem. Toxicol.* 41:1517-1525.
- (19) Yamasaki K, Sawaki M, Noda S, Wada T, Hara T, Takatsuki M. (2002). Immature uterotrophic assay of estrogenic compounds in rats given different phytoestrogen content diets and the ovarian changes in the immature rat uterotrophic of estrogenic compounds with ICI 182,780 or anti-estrogen. *Arch. Toxicol.* 76:613-620.
- (20) Thigpen JE, Haseman JK, Saunders HE, Setchell KDR, Grant MF, Forsythe D. (2003). Dietary phytoestrogens accelerate the time of vaginal opening in immature CD-1 mice. *Comp. Med.* 53:477-485.
- (21) Ashby J, Tinwell H, Odum J, Kimber I, Brooks AN, Pate I, Boyle CC. (2000). Diet and the aetiology of temporal advances in human and rodent sexual development. *J. Appl. Toxicol.* 20:343-347.
- (22) Thigpen JE, Lockear J, Haseman J, Saunders HE, Caviness G, Grant MF, Forsythe DB. (2002). Dietary factors affecting uterine weights of immature CD-1 mice used in uterotrophic bioassays. *Cancer Detect. Prev.* 26:381-393.
- (23) Thigpen JE, Li L-A, Richter CB, Lebetkin EH, Jameson CW. (1987). The mouse bioassay for the detection of estrogenic activity in rodent diets: I. A standardized method for conducting the mouse bioassay. *Lab. Anim. Sci.* 37:596-601.
- (24) OECD (2008). Acute oral toxicity — up-and-down procedure. OECD Guideline for the testing of chemicals No 425.
- (25) OECD (2000). Guidance document on the recognition, assessment and use of clinical signs as humane endpoints for experimental animals used in safety evaluation. Environmental Health and Safety Monograph Series on Testing and Assessment No 19. ENV/JM/MONO(2000)7.
- (26) OECD (2001). Guidance document on acute oral toxicity. Environmental Health and Safety Monograph Series on Testing and Assessment No 24. ENV/JM/MONO(2001)4.
- (27) Bulbring, E., and Burn, J.H. (1935). The estimation of oestrin and of male hormone in oily solution. *J. Physiol.* 85: 320 — 333.
- (28) Dorfman, R.I., Gallagher, T.F. and Koch, F.C (1936). The nature of the estrogenic substance in human male urine and bull testis. *Endocrinology* 19: 33 — 41.
- (29) Reel, J.R., Lamb IV, J.C. and Neal, B.H. (1996). Survey and assessment of mammalian estrogen biological assays for hazard characterization. *Fundam. Appl. Toxicol.* 34: 288 — 305.
- (30) Jones, R.C. and Edgren, R.A. (1973). The effects of various steroid on the vaginal histology in the rat. *Fertil. Steril.* 24: 284 — 291.
- (31) OECD (1982). Organization for Economic Co-operation and Development — Principles of Good Laboratory Practice, ISBN 92-64-12367-9, Paris.
- (32) Dorfman R.I. (1962). *Methods in Hormone Research, Vol. II, Part IV: Standard Methods Adopted by Official Organization.* New York, Academic Press.
- (33) Thigpen J. E. et al. (2004). Selecting the appropriate rodent diet for endocrine disruptor research and testing studies. *ILAR J* 45(4): 401-416.

▼M5

- (34) Gray L.E. and Ostby J. (1998). Effects of pesticides and toxic substances on behavioral and morphological reproductive development: endocrine versus non-endocrine mechanism. *Toxicol Ind Health*. 14 (1-2): 159-184.
- (35) Booth AN, Bickoff EM and Kohler GO. (1960). Estrogen-like activity in vegetable oils and mill by-products. *Science* 131:1807-1808.
- (36) Kato H, Iwata T, Katsu Y, Watanabe H, Ohta Y, Iguchi T (2004). Evaluation of estrogenic activity in diets for experimental animals using in vitro assay. *J. Agric Food Chem*. 52, 1410-1414.
- (37) OECD (2007). Guidance Document on the Uterotrophic Bioassay Procedure to Test for Antioestrogenicity. Series on Testing and Assessment. No 71.
- (38) Directive 2010/63/EU of the European Parliament and of the Council of 22 September 2010 on the protection of animals used for scientific purposes (OJ L 276, 20.10.2010, p. 33).

▼ M5**B.55 HERSHBERGER BIOASSAY IN RATS: A SHORT-TERM SCREENING ASSAY FOR (ANTI)ANDROGENIC PROPERTIES**

INTRODUCTION

1. This test method is equivalent to OECD Test Guideline (TG) 441 (2009). The OECD initiated a high-priority activity in 1998 to revise existing guidelines and to develop new guidelines for the screening and testing of potential endocrine disruptors (1). One element of the activity was to develop a test guideline for the rat Hershberger Bioassay. After several decades of use by the pharmaceutical industry, this assay was first standardised by an official expert committee in 1962 as a screening tool for androgenic chemicals (2). In 2001-2007, the rat Hershberger Bioassay has undergone an extensive validation programme including the generation of a Background Review Document (23), compilation of a detailed methods paper (3), development of a dissection guide (21) and the conduct of extensive intra- and interlaboratory studies to show the reliability and reproducibility of the bioassay. These validation studies were conducted with a potent reference androgen (testosterone propionate (TP)), two potent synthetic androgens (trenbolone acetate and methyl testosterone), a potent antiandrogenic pharmaceutical (flutamide), a potent inhibitor of the synthesis (finasteride) of the natural androgen (dihydrotestosterone-DHT), several weakly antiandrogenic pesticides (linuron, vinclozolin, procymidone, p,p' DDE), a potent 5 α reductase inhibitor (finasteride) and two known negative chemicals (dinitrophenol and nonylphenol) (4) (5) (6) (7) (8). This test method is the outcome of the long historical experience with the bioassay and the experience gained during the validation test programme and the results obtained therein.
2. The Hershberger Bioassay is a short-term *in vivo* screening test using accessory tissues of the male reproductive tract. The assay originated in the 1930s and was modified in the 1940s to include androgen-responsive muscles in the male reproductive tract (2) (9-15). In the 1960s, over 700 possible androgens were evaluated using a standardised version of the protocol (2) (14), and use of the assay for both androgens and anti-androgens was considered a standard method in the 1960s (2) (15). The current bioassay is based on the changes in weight of five androgen-dependent tissues in the castrate-peripubertal male rat. It evaluates the ability of a chemical to elicit biological activities consistent with androgen agonists, antagonists or 5 α -reductase inhibitors. The five target androgen-dependent tissues included in this test method are the ventral prostate (VP), seminal vesicle (SV) (plus fluids and coagulating glands), levator ani-bulbocavernosus (LABC) muscle, paired Cowper's glands (COW) and the glans penis (GP). In the castrate-peripubertal male rat, these five tissues all respond to androgens with an increase in absolute weight. When these same tissues are stimulated to increase in weight by administration of a potent reference androgen, these five tissues all respond to antiandrogens with a decrease in absolute weight. The primary model for the Hershberger bioassay has been the surgically castrated peripubertal male, which was validated in Phases 1, 2 and 3 of the Hershberger validation programme.
3. The Hershberger bioassay serves as a mechanistic *in vivo* screening assay for androgen agonists, androgen antagonists and 5 α -reductase inhibitors and its application should be seen in the context of the 'OECD Conceptual Framework for the Testing and Assessment of Endocrine Disrupting Chemicals' (Appendix 2). In this Conceptual Framework the Hershberger Bioassay is contained in Level 3 as an *in vivo* assay providing data

▼ M5

about a single endocrine mechanism, i.e. (anti)androgenicity. It is intended to be included in a battery of *in vitro* and *in vivo* tests to identify chemicals with potential to interact with the endocrine system, ultimately leading to hazard and risk assessments for human health or the environment.

4. Due to animal welfare concerns with the castration procedure, the intact (uncastrated) stimulated weanling male was sought as an alternative model for the Hershberger Bioassay to avoid the castration step. The stimulated weanling test method was validated (24); however, in the validation studies, the weanling version of the Hershberger Bioassay did not appear to be able to consistently detect effects on androgen-dependent organ weights from weak anti-androgens at the doses tested. Therefore, it was not included in this test method. However, recognising that its use may provide not only animal welfare benefits but also may provide information on other modes of action, it is available in OECD Guidance Document 115(25).

INITIAL CONSIDERATIONS AND LIMITATIONS

5. Androgen agonists and antagonists act as ligands for the androgen receptor and may activate or inhibit, respectively, gene transcription controlled by the receptor. In addition, some chemicals inhibit the conversion of testosterone to the more potent natural androgen dihydrotestosterone in some androgen target tissues (5 α -reductase inhibitors). Such chemicals have the potential to lead to adverse health hazards, including reproductive and developmental effects. Therefore, the regulatory need exists to rapidly assess and evaluate a chemical as a possible androgen agonist or antagonist or 5 α -reductase inhibitor. While informative, the affinity of a ligand for an androgen receptor as measured by receptor binding or transcriptional activation of reporter genes *in vitro* is not the only determinant of possible hazard. Other determinants include metabolic activation and deactivation upon entering the body, chemical distribution to target tissues, and clearance from the body. This leads to the need to screen the possible activity of a chemical *in vivo* under relevant conditions and exposure. *In vivo* evaluation is less critical if the chemical's characteristics regarding Absorption — Distribution — Metabolism — Elimination (ADME) are known. Androgen-dependent tissues respond with rapid and vigorous growth to stimulation by androgens, particularly in castrate-peripubertal male rats. Rodent species, particularly the rat, are also widely used in toxicity studies for hazard characterisation. Therefore, the assay version, using the castrated peripubertal rat and the five target tissues in this assay, is appropriate for the *in vivo* screening of androgen agonists and antagonists and 5 α -reductase inhibitors.
6. This test method is based on those protocols employed in the OECD validation study which have been shown to be reliable and reproducible in intra- and inter-laboratory studies (4)(5)(6)(7)(8). Both androgen and antiandrogen procedures are presented in this test method.
7. Although there was some variation in the dose of TP used to detect anti-androgens in the OECD Hershberger Bioassay validation programme by the different laboratories (0,2 versus 0,4 mg/kg/d, subcutaneous injection) there was little difference between these two protocol variations in the ability to detect weak or strong antiandrogenic activity. However, it is clear that the dose of TP should not be too high to block the effects of weak androgen receptor (AR) antagonists or so low that the androgenic tissues display little growth response even without antiandrogen coadministration.

▼ **M5**

8. The growth response of the individual androgen-dependent tissues is not entirely of androgenic origin, i.e. chemicals other than androgen agonists can alter the weight of certain tissues. However, the growth response of several tissues concomitantly substantiates a more androgen-specific mechanism. For example, high doses of potent oestrogens can increase the weight of the seminal vesicles; however, the other androgen-dependent tissues in the assay do not respond in a similar manner. Antiandrogenic chemicals can act either as androgen receptor antagonists or 5 α -reductase inhibitors. 5 α -reductase inhibitors have a variable effect, because the conversion to more potent dihydrotestosterone varies by tissue. Antiandrogens that inhibit 5 α -reductase, like finasteride, have more pronounced effects in the ventral prostate than other tissues as compared to a potent AR antagonist, like flutamide. This difference in tissue response can be used to differentiate between AR mediated and 5 α -reductase mediated modes of action. In addition, the androgen receptor is evolutionarily related to that of other steroid hormones, and some other hormones, when administered at high, supraphysiological dosage levels, can bind and antagonise the growth-promoting effects of TP (13). Further, it also is plausible that enhanced steroid metabolism and a consequent lowering of serum testosterone could reduce androgen-dependent tissue growth. Therefore, any positive outcome in the Hershberger Bioassay should normally be evaluated using a weight of evidence approach, including *in vitro* assays, such as the AR and oestrogen receptor (ER) binding assays and corresponding transcriptional activation assays, or from other *in vivo* assays that examine similar androgen target tissues such as the male pubertal assay, 15-day intact adult male assay, or 28-day or 90-day repeat dose studies.

9. Experience indicates that xenobiotic androgens are rarer than xenobiotic antiandrogens. The expectation then is that the Hershberger bioassay will be used most often for the screening of antiandrogens. However, the procedure to test for androgens could, nevertheless, be recommended for steroidal or steroid-like chemicals or for chemicals for which an indication of possible androgenic effects was derived from methods contained in Level 1 or 2 of the conceptual framework (Appendix 2). Similarly, adverse effects associated with (anti)androgenic profiles may be observed in Level 5 assays, leading to the need to assess whether a chemical operates by an endocrine mode of action.

10. It is acknowledged that all animal-based procedures should conform to local standards of animal care; the descriptions of care and treatment set forth below are minimal performance standards, and will be superseded by local regulations such as Directive 2010/63/EU of the European Parliament and of the Council of 22 September 2010 on the protection of animals used for scientific purposes (26). Further guidance of the humane treatment of animals is given by the OECD (17).

11. As in any bioassay using experimental animals, careful considerations should be given to the necessity to carry out this study. Basically there may be two reasons for such a decision:
 - high exposure potential (Level 1 of the Conceptual Framework) or indications for (anti)androgenicity in *in vitro* assays (Level 2) supporting investigations whether such effects may occur *in vivo*;

 - effects consistent with (anti)androgenicity in Level 4 or 5 *in vivo* tests supporting investigations of the specific mode of action, e.g. to determine whether the effects were due to an (anti)androgenic mechanism.

▼ M5

12. Definitions used in this test method are given in Appendix 1.

PRINCIPLE OF THE TEST

13. The Hershberger Bioassay achieves its sensitivity by using males with minimal endogenous androgen production. This is achieved through the use of castrated males provided an adequate time after castration for the target tissues to regress to a minimal and uniform baseline weight is allowed. Thus, when screening of potential androgenic activity, there are low endogenous levels of circulating androgens, the hypothalamic — pituitary — gonad axis is rendered unable to compensate via feedback mechanisms, the ability of the tissues to respond is maximised, and the starting tissue weight variability is minimised. When screening of potential anti-androgenic activity, a more consistent tissue weight gain can be achieved when the tissues are stimulated by a reference androgen. As a result, the Hershberger Bioassay requires only 6 animals per dose group whereas other assays with intact pubertal or adult males suggest using 15 males per dose group.

14. Castration of peripubertal male rats should be done in an appropriate manner using approved anaesthetics and aseptic technique. Analgesics should be administered on the first few days following surgery to eliminate post-surgical discomfort. Castration enhances the precision of the assay to detect weak androgens and antiandrogens by eliminating compensatory endocrine feed-back mechanisms present in the intact animal that can attenuate the effects of administered androgens and antiandrogens and by eliminating the large inter-individual variability in serum testosterone levels. Hence, castration reduces the numbers of animals required to screen for these endocrine activities.

15. When screening for potential androgenic activity, the test chemical is administered daily by oral gavage or subcutaneous (sc) injection for a period of 10 consecutive days. Test chemicals are administered to a minimum of two treatment groups of experimental animals using one dose level per group. The animals are necropsied approximately 24 hours after the last dose. A statistically significant increase in two or more target organ weights of the test chemical groups compared to the vehicle control group indicates that the test chemical is positive for potential androgenic activity (See paragraph 60). Androgens, like trenbolone that cannot be 5 α -reduced have more pronounced effects on the LABC and GP versus TP, but all tissues should display increased growth.

16. When screening for potential antiandrogenic activity, the test chemical is administered daily by oral gavage or subcutaneous injection for a period of 10 consecutive days in concert with daily TP doses (0,2 or 0,4 mg/kg/d) by sc injection. It was determined in the validation programme that either 0,2 or 0,4 mg/kg/d of TP could be used as both were effective in the detection of antiandrogens and, therefore, only one dose should be selected for use in the assay. Graduated test chemical doses are administered to a minimum of three treatment groups of experimental animals using one dose level per group. The animals are necropsied approximately 24 hours after the last dose. A statistically significant decrease in two or more target organ weights of the test chemical plus TP groups compared to the TP only control group indicates that the test chemical is positive for potential anti-androgenic activity (See paragraph 61).

▼ M5**DESCRIPTION OF THE METHOD****Selection of species and strain**

17. The rat has been routinely used in the Hershberger Bioassay since the 1930s. Although it is biologically plausible that both the rat and mouse would display similar responses, based upon 70 years of experience with the rat model, the rat is the species of choice for the Hershberger Bioassay. In addition, since Hershberger Bioassay data may be preliminary to a long-term multigenerational study, this allows animals from the same species, strain and source to be used in both studies.

18. This protocol allows laboratories to select the strain of rat to be used in the assay which should generally be that used historically by the participating laboratory. Commonly used laboratory rat strains may be used; however, strains that mature significantly later than 42 days of age should not be used since castration of these males at 42 days of age could preclude measurement of glans penis weights, which can only be done after the prepuce is separated from the penile shaft. Thus, strains derived from the Fisher 344 rat should not be used, except in rare cases. The Fisher 344 rat has a different timing of sexual development compared with other more commonly used strains such as Sprague Dawley or Wistar strains (16). If such a strain is to be used, the laboratory should castrate them at a slightly older age and be able to demonstrate the sensitivity of the strain used. The rationale for the choice of rat strain should be clearly stated by the laboratory. Where the screening assay may be preliminary to a repeated dose oral study, a reproductive and developmental study, or a long-term study, preferably animals from the same strain and source should be used in all studies.

Housing and feeding conditions

19. All procedures should conform to all local standards of laboratory animal care. These descriptions of care and treatment are minimum standards and will be superseded by more stringent local regulations, such as Directive 2010/63/EU of the European Parliament and of the Council of 22 September 2010 on the protection of animals used for scientific purposes (26). The temperature in the experimental animal room should be 22 °C (with an approximate range ± 3 °C). The relative humidity should be a minimum of 30 % and preferably should not exceed a maximum 70 %, other than during room cleaning. The aim should be relative humidity of 50-60 %. Lighting should be artificial. The daily lighting sequence should be 12 hours light, 12 hours dark.

20. Group housing is preferable to isolation because of the young age of the animals and the fact that rats are social animals. Housing of two or three animals per cage avoids crowding and associated stress that may interfere with the hormonal control of the development of the sex accessory tissue. Cages should be thoroughly cleaned to remove possible contaminants and arranged in such a way that possible effects due to cage placement are minimised. Cages of a proper size (~ 2 000 square centimetres) will prevent overcrowding.

21. Each animal should be identified individually (e.g. ear mark or tag) using a humane method. The method of identification should be recorded.

▼ **M5**

22. Laboratory diet and drinking water should be provided *ad libitum*. Laboratories executing the Hershberger Bioassay should use the laboratory diet normally used in their chemical testing work. In the validation studies of the Bioassay, no effects or variability were observed that were attributable to the diet. The diet used will be recorded and a sample of the laboratory diet should be retained for possible future analysis.

Performance Criteria for androgen-dependent organ weights

23. During the validation study, there was no evidence that a decrease in body weight affected increases or decreases in the growth of tissue weights for target tissues (i.e. that should be weighted in this study).
24. Among the different strains of rat used successfully in the validation programme, androgen-dependent organ weights are larger in the heavier rat strains than in the lighter strains. Therefore, the Hershberger Bioassay performance criteria do not include absolute expected organ weights for positive and negative controls.
25. Because the Coefficient of Variation (CV) for a tissue has an inverse relationship with statistical power, the Hershberger Bioassay performance criteria are based on maximum CV values for each tissue (Table 1). The CVs are derived from the OECD validation studies. In the case of negative outcomes, laboratories should examine the CVs from the control group and the high dose treatment group to determine if the maximum CV performance criteria have been exceeded.
26. The study should be repeated when: 1) three or more of the 10 possible individual CVs in the control and high dose treatment groups exceed the maximums designated for agonist and antagonist studies in Tables 1 and 2) at least two target tissues were marginally insignificant, i.e. *r* values between 0,05 and 0,10. ⁽¹⁾

Table 1

Maximum allowable CVs Determined for the Target Sex Accessory Tissues for the castrate model in the OECD Validation Studies ⁽¹⁾.

Tissue	Antiandrogenic effects	Androgenic effects
Seminal vesicles	40 %	40 %
Ventral prostate	40 %	45 %
LABC	20 %	30 %
Cowper's glands	35 %	55 %
Glans penis	17 %	22 %

⁽¹⁾ The threshold CV for a given tissue was identified from a graph of CV values — arranged from smallest sequentially to largest — for all means from all experiments in the validation exercise using a specific model (agonist or antagonist). The threshold CV was read from the point at which the increments between to the next highest CVs in the series are dramatically larger than the preceding few CVs- the 'breakpoint'. It should be noted that although this analysis identified relatively reliable 'breakpoints' for the antagonist model of the assay, CV curves for the agonist assay showed a more uniform increase making identification of a threshold CV by this method somewhat arbitrary.

▼ M5**PROCEDURE****Regulatory compliance and laboratory verification**

27. Unlike the Uterotrophic assay (Chapter B.54 of this Annex), a demonstration of laboratory competence prior to the initiation of the study is not necessary for the Hershberger assay because concurrent positive (Testosterone Propionate and Flutamide) and negative controls are run as an integral part of the assay.

Number and condition of animals

28. Each treated and control group should include a minimum of 6 animals. This applies to both the androgenic and antiandrogenic protocols.

Castration

29. There should be an initial acclimatisation period of several days after receipt of the animals to ensure that the animals are healthy and thriving. Since animals castrated before 42 days of age or postnatal day (pnd) 42 may not display preputial separation, animals should be castrated on pnd 42 or thereafter, not before. The animals are castrated under anaesthesia by placing an incision in the scrotum and removing both testes and epididymides with ligation of blood vessels and seminal ducts. After confirming that no bleeding is occurring, the scrotum should be closed with suture or autoclips. Animals should be treated with analgesics for the first few days after surgery to alleviate any post-surgical discomfort. If castrated animals are purchased from an animal supplier, the age of animals and stage of sexual maturity should be assured by the supplier.

Acclimatisation after castration

30. The animals should continue acclimation to the laboratory conditions to allow for the regression in the target tissue weights for a minimum of 7 days following castration. Animals should be observed daily, and any animals with evidence of disease or physical abnormalities should be removed. Thus, treatment with initiation of dosing (on study) may commence as early as pnd 49 days of age, but not later than pnd 60. Age at necropsy should not be greater than pnd 70. This flexibility allows a laboratory to schedule the experimental work efficiently.

Body weight and group randomisation

31. Differences in individual body weights are a source of variability in tissue weights both within and among groups of animals. Increasing tissue weight variability results in an increased coefficient of variation (CV) and decreases the statistical power of the assay (sometimes referred to as assay sensitivity). Therefore, variations in body weight should be both experimentally and statistically controlled.
32. Experimental control involves producing small variations in body weight within and among the study groups. First, unusually small or large animals should be avoided and not placed in the study cohort. At study commencement the weight variation of animals used should not exceed $\pm 20\%$ of the mean weight (e.g. $175\text{ g} \pm 35\text{ g}$ for castrated peripubertal rats). Second, animals should be assigned to groups (both control and treatment) by randomised weight distribution, so that mean body weight of each group is not statistically different from any other group. The block randomisation procedure used should be recorded.

▼ M5

33. Because toxicity may decrease the body weight of treated groups relative to the control group, the body weight on the first day of test chemical administration could be used as the statistical covariate, not the body weight at necropsy.

Dosage

34. In order to establish whether a test chemical can have androgenic action *in vivo*, two dose groups of the test chemical plus positive and vehicle (negative) controls (See paragraph 43) are normally sufficient, and this design is therefore preferred for animal welfare reasons. If the purpose is either to obtain a dose-response curve or to extrapolate to lower doses, at least 3 dose groups are needed. If information beyond identification of androgenic activity (such as an estimate of potency) is required, a different dosing regimen should be considered. To test for antiandrogens, the test chemical is administered together with a reference androgen agonist. A minimum of 3 test groups with different doses of the test chemical and a positive and a negative control (See paragraph 44) should be used. Except for treatment with the test chemical, animals in the control group should be handled in an identical manner to the test group subjects. If a vehicle is used in administering the test chemical, the control group should receive the vehicle in the highest volume used with the test groups.

35. All dose levels should be proposed and selected taking into account any existing toxicity and (toxico-) kinetic data available for the test chemical or related materials. The highest dose level should first take into consideration the LD₅₀ and/or acute toxicity information in order to avoid death, severe suffering or distress in the animals (17)(18)(19)(20) and, second, take into consideration available information on the doses used in subchronic and chronic studies. In general, the highest dose should not cause a reduction in the final body weight of the animals greater than 10 % of control weight. The highest dose should be either 1) the highest dose that ensures animal survival and that is without significant toxicity or distress to the animals after 10 consecutive days of administration up to a maximal dose of 1 000 mg/kg/day (See paragraph 36) or 2) a dose inducing (anti)androgenic effects, whichever is lower. As a screen, large intervals, e.g. one half log units (corresponding to a dose progression of 3,2) or even one log units, between dosages are acceptable. If there are no suitable data available, a range finding study (See paragraph 37) may be performed to aid the determination of the doses to be used.

Limit dose level

36. If a test at the limit dose of 1 000 mg/kg body weight/day and a lower dose using the procedures described for this study fails to produce a statistically significant change in reproductive organ weights, then additional dose levels may be considered unnecessary. The limit dose applies except when human exposure data indicate the need for a higher dose level to be used.

Considerations for range finding

37. If necessary, a preliminary range finding study can be carried out with a few animals to select the appropriate dose groups [using methods for acute toxicity testing (Chapters B.1 bis, B.1 tris of this Annex (27), OECD TG 425 (19))]. The objective in the case of the Hershberger Bioassay is to select doses that ensure animal survival and that are without significant toxicity or distress to the animals after 10 consecutive days of chemical

▼ M5

administration up to a limit dose of 1 000 mg/kg/d as noted in paragraphs 35 and 36. In this respect an OECD Guidance Document (17) may be used defining clinical signs indicative of toxicity or distress to the animals. If feasible within this range finding study after 10 days of administration, the target tissues may be excised and weighed approximately 24-hours after the last dose is administered. These data could then be used to assist the selection of the doses in the main study.

Reference chemicals and vehicle

38. The reference androgen agonist should be Testosterone Propionate (TP), CAS No 57-82-5. The reference TP dosage may be either 0,2 mg/kg-bw/d or 0,4 mg/kg-bw/d. The reference androgen antagonist should be Flutamide (FT), CAS No 1311-84-7. The reference FT dosage should be 3 mg/kg-bw/d, and the FT should be co-administered with the reference TP dosage.

39. It is recommended that, wherever possible, the use of an aqueous solution/suspension be considered first. However, since many androgen ligands or their metabolic precursors tend to be hydrophobic, the most common approach is to use a solution/suspension in oil (e.g. corn, peanut, sesame or olive oil). Test chemicals can be dissolved in a minimal amount of 95 % ethanol or other appropriate solvents and diluted to final working concentrations in the test vehicle. The toxic characteristics of the solvent should be known, and should be tested in a separate solvent-only control group. If the test chemical is considered stable, gentle heating and vigorous mechanical action can be used to assist in dissolving the test chemical. The stability of the test chemical in the vehicle should be determined. If the test chemical is stable for the duration of the study, then one starting aliquot of the test chemical may be prepared, and the specified dosage dilutions prepared daily using care to avoid contamination and spoilage of the samples.

Administration of doses

40. TP should be administered by subcutaneous injection, and FT by oral gavage.

41. The test chemical is administered by oral gavage or subcutaneous injection. Animal welfare considerations and the physical/chemical properties of the test chemical need to be taken into account when choosing the route of administration. In addition, toxicological aspects like the relevance to the human route of exposure to the chemical (e.g. oral gavage to model ingestion, subcutaneous injection to model inhalation or dermal adsorption) and existing toxicological information and data on metabolism and kinetics (e.g. need to avoid first pass metabolism, better efficiency via a particular route) should be taken into account before extensive, long-term testing is initiated if positive results are obtained by injection.

42. The animals should be dosed in the same manner and time sequence for 10 consecutive days at approximately 24 hour intervals. The dosage level should be adjusted daily based on the concurrent daily measures of body weight. The volume of dose and time that it is administered should be recorded on each day of exposure. Care should be taken in order not to exceed the maximum dose described in paragraph 35 to allow a meaningful interpretation of the data. Reduction of body weight, clinical signs, and other findings should be thoroughly assessed in this respect. For oral gavage, a stomach tube or a suitable intubation cannula should be used. The maximum volume of liquid that can be administered at one time

▼ M5

depends on the size of the test animal. Local animal care guidelines should be followed, but the volume should not exceed 5 ml/kg body weight, except in the case of aqueous solutions where 10 ml/kg body weight may be used. For subcutaneous injections, doses should be administered to the dorsoscapular and or lumbar regions via sterile needle (e.g. 23- or 25-gauge) and a tuberculin syringe. Shaving the injection site is optional. Any losses, leakage at the injection site or incomplete dosing should be recorded. The total volume injected per rat per day should not exceed 0,5 ml/kg body weight.

Specific procedures for androgen agonists

43. For the test for androgen agonists, the vehicle is the negative control, and the TP-treated group is the positive control. Biological activity consistent with androgen agonists is tested by administering a test chemical to treatment groups at the selected doses for 10 consecutive days. The weights of the five sex accessory tissues from the test chemical groups are compared to the vehicle group for statistically significant increases in weight.

Specific procedures for androgen antagonists and 5 α -reductase inhibitors

44. For the test for androgen antagonists and 5 α -reductase inhibitors, the TP-treated group is the negative control, and the group coadministered with reference doses of TP and FT is the positive control. Biological activity consistent with androgen antagonists and 5 α -reductase inhibitors is tested by administering a reference dose of TP and administering the test chemical for 10 consecutive days. The weights of the five sex accessory tissues from the TP plus test chemical groups are compared to the reference TP-only group for statistically significant decreases in weights.

OBSERVATIONS**Clinical observations**

45. General clinical observations should be made at least once a day and more frequently when signs of toxicity are observed. Observations should be carried out preferably at the same time(s) each day and considering the period of anticipated peak effects after dosing. All animals should be observed for mortality, morbidity and general clinical signs such as changes in behaviour, skin, fur, eyes, mucous membranes, occurrence of secretions and excretions and autonomic activity (e.g. lacrimation, piloerection, pupil size, unusual respiratory pattern).
46. Any animal found dead should be removed and disposed of without further data analysis. Any mortality of animals prior to necropsy should be included in the study record together with any apparent reasons for mortality. Any moribund animals should be humanely terminated. Any moribund and subsequently euthanised animals should be included in the study record with apparent reasons for morbidity.

▼ M5**Body weight and food consumption**

47. All animals should be weighed daily to the nearest 0,1 g, starting just prior to initiation of treatment, i.e. when the animals are allocated into groups. As an optional measurement, the amount of food consumed during the treatment period may be measured per cage by weighing the feeders. The food consumption results should be expressed in grams per rat per day.

Dissection and measurement of tissue and organ weights

48. Approximately 24 hours after the last administration of the test chemical, the rats should be euthanised and exsanguinated according to the normal procedures of the conducting laboratory, and necropsy carried out. The method of humane killing should be recorded in the laboratory report.
49. Ideally, the necropsy order should be randomised across groups to avoid progression directly up or down dose groups that could affect the data. Any finding at necropsy, i.e. pathological changes/visible lesions should be noted and reported.
50. The five androgen-dependent tissues (VP, SV, LABC, COW, GP) should be weighted. These tissues should be excised, carefully trimmed of excess adhering tissue and fat, and their fresh (unfixed) weights determined. Each tissue should be handled with particular care to avoid the loss of fluids and to avoid desiccation, which may introduce significant errors and variability by decreasing the recorded weights. Several of the tissues may be very small or difficult to dissect, and this will introduce variability. Therefore, it is important that persons carrying out the dissection of the sex accessory tissues are familiar with standard dissection procedures for these tissues. A standard operating procedure (SOP) manual for dissection is available from the OECD (21). Careful training according to the SOP guide will minimise a potential source of variation in the study. Ideally the same prosector should be responsible for the dissection of a given tissue to eliminate inter-individual differences in tissue processing. If this is not possible, the necropsy should be designed such that each prosector dissects a given tissue from all treatment groups as opposed to one individual dissecting all tissues from a control group, while someone else is responsible for the treated groups. Each sex accessory tissues should be weighed without blotting to the nearest 0,1 mg, and the weights recorded for each animal.
51. Several of the tissues may be very small or difficult to dissect, and this will introduce variability. Previous work has indicated a range of coefficient of variations (CVs) that appears to differ based upon the proficiency of the laboratory. In a few cases, large differences in the absolute weights of the tissues such as the VP and COWS have been observed within a particular laboratory.
52. Liver, paired kidney, and paired adrenal weights are optional measurements. Again, tissues should be trimmed free of any adhering fascia and fat. The liver should be weighed and recorded to the nearest 0,1 g and the paired kidneys and paired adrenals should be weighed and recorded to the nearest 0,1 mg. The liver, kidney and adrenals are not only influenced by androgens; they also provide useful indices of systemic toxicity.

▼ M5

53. Measurement of serum luteinising hormone (LH), follicular stimulating hormone (FSH) and testosterone (T) is optional. Serum T levels are useful to determine if the test chemical induces liver metabolism of testosterone, lowering serum levels. Without the T data, such an effect might appear to be via an antiandrogenic mechanism. LH levels provides information about the ability of an antiandrogen to not only reduce organ weights, but also to affect hypothalamic-pituitary function, which in long term studies can induce testis tumors. FSH is an important hormone for spermatogenesis. Serum T4 and T3 also are optional measures that would provide useful supplemental information about the ability to disrupt thyroid hormone homeostasis. If hormone measurements are to be made, the rats should be anaesthetised prior to necropsy and blood taken by cardiac puncture, and the method of anaesthesia should be chosen with care so that it does not affect hormone measurement. The method of serum preparation, the source of radioimmunoassay or other measurement kits, the analytical procedures, and the results should be recorded. LH levels should be reported as ng per ml of serum, and T should also be reported as ng per ml of serum.
54. The dissection of the tissues is described as follows with a detailed dissection guide with photographs published as supplementary materials as part of the validation programme (21). A dissection video is also available from the Korea Food and Drug Administration web page (22).
- With the ventral surface of the animal upwards, determine if the prepuce of the penis has separated from the glans penis. If so, then retract the prepuce and remove the glans penis, weigh (nearest 0,1 mg), and record the weight;

 - Open the abdominal skin and wall, exposing the viscera. If the optional organs are weighed, remove and weigh liver to nearest 0,1 g, remove the stomach and intestines, remove and weigh the paired kidneys and paired adrenals to the nearest 0,1 mg. This dissection exposes the bladder and begins the dissection of the target male accessory tissues.

 - To dissect the VP, separate bladder from the ventral muscle layer by cutting connective tissue along the midline. Displace the bladder anteriorly towards the seminal vesicles (SV), revealing the left and right lobes of the ventral prostate (covered by a layer of fat). Carefully tease the fat from the right and left lobes of the VP. Gently displace the VP right lobe from the urethra and dissect the lobe from the urethra. While still holding the VP right lobe, gently displace the VP left lobe from the urethra and then dissect; weigh to nearest 0,1 mg and record the weight.

 - To dissect the SVCG, displace the bladder caudally, exposing the vas deferens and right and left lobes of the seminal vesicles plus coagulating glands (SVCG). Prevent leakage of fluid by clamping a haemostat at the base of the SVCGs, where the vas deferens joins the urethra. Carefully dissect the SVCGs, with the haemostat in place trim fat and adnexa away, place in a tared weigh-boat, remove the haemostat, and weigh to the nearest 0,1 mg and record the weight.

▼ M5

- To dissect the levator ani plus bulbocavernosus muscles (LABC), the muscles and the base of the penis are exposed. The LA muscles wrap around the colon, while the anterior LA and BC muscles are attached to the penile bulbs. The skin and adnexa from the perianal region extending from the base of the penis to the anterior end of the anus are removed. The BC muscles are gradually dissected from the penile bulb and tissues. The colon is cut in two and, the full LABC can be dissected and removed. The LABC should be trimmed of fat and adnexa, weighed to the nearest 0,1 mg, and record the weight.
 - After the LABC has been removed, the round Cowper's or bulbourethral glands (COW) are visible at the base of, and slightly dorsal to, the penile bulbs. Careful dissection is required to avoid nicking the thin capsule in order to prevent fluid leakage. Weigh the paired COW to the nearest 0,1 mg, and record the weight.
 - In addition, if fluid is lost from any gland during the necropsy and dissection, this should be recorded.
55. If the evaluation of each chemical requires necropsy of more animals than is reasonable for a single day, the study start may be staggered on two consecutive days, resulting in the staggering of the necropsy and the related work over two days. If staggered in this manner, one-half of the animals per treatment group should be used per day.
56. Carcasses should be disposed of in an appropriate manner following necropsy.

REPORTING**Data**

57. Data should be reported individually (i.e. body weight, accessory sex tissue weights, optional measurements and other responses and observations) and for each group of animals (means and standard deviations of all measurement taken). The data should be summarised in tabular form. The data should show the number of animals at the start of the test, the number of animals found dead during the test or found showing signs of toxicity, a description of the signs of toxicity observed, including time of onset, duration and severity.
58. A final report should include:

Testing facility

- Name of facility, location
- Study director and other personnel and their study responsibilities
- Dates the study began and ended, i.e. first day of test chemical administration and last day of necropsy, respectively.

Test chemical

- Source, lot/batch number, identity, purity, full address of the supplier and characterisation of the test chemical(s)
- Physical nature and, where relevant, physicochemical properties;
- Storage conditions and the method and frequency of dilution preparation
- Any data generated on stability
- Any analyses of dosing solutions/suspensions.

▼ M5*Vehicle*

- Characterisation of the vehicle (identity, supplier and lot #)
- Justification of the vehicle choice (if other than water)

Test animals and animal husbandry procedures

- Species/strain used and rationale for choice
- Source or supplier of animals, including full address
- Number and age of animals supplied
- Housing conditions (temperature, lighting, and so on)
- Diet (name, type, supplier, lot number, content and if known, phytoestrogens levels)
- Bedding (name, type, supplier, content)
- Caging conditions and number of animals per cage;

Assay Conditions

- Age at castration and duration of acclimatisation after castration;
- Individual weights of animals at the start of the study (to nearest 0,1 g);
- Randomisation process and a record of the assignment to vehicle, reference, test chemical groups, and cages
- Mean and standard deviation of the body weights for each group for each weigh day throughout the study;
- Rationale for dose selection
- Route of administration of test chemical and rationale for the choice of exposure route
- If an assay for antiandrogenicity, the TP treatment (dose and volume),
- Test chemical treatment (dose and volume),
- Time of dosing
- Necropsy procedures, including means of exsanguinations and any anaesthesia
- If serum analyses are performed, details of the method should be supplied. For example, if RIA is used, the RIA procedure, source of RIA kits, kit expiration dates, procedure for scintillation counting, and standardisation should be reported.

Results

- Daily observations for each animal during dosing, including:
 - Body weights (to the nearest 0,1 g),
 - Clinical signs (if any),
 - Any measurement or notes of food consumption.
- Necropsy observations for each animal, including:

▼ M5

- Date of necropsy,
- Animal treatment group,
- Animal ID,
- Prosector,
- Time of day necropsy and dissection are performed,
- Animal age,
- Final body weight at necropsy, noting any statistically significant increase or decrease,
- Order of animal exsanguination and dissection at necropsy,
- Weights of the five target androgen dependent tissues:
 - Ventral prostate (to the nearest 0,1 mg)
 - Seminal vesicles plus coagulating glands, including fluid (paired, to nearest 0,1 mg)
 - Levator ani plus bulbocavernosus muscle complex (to nearest 0,1 mg)
 - Cowper's glands (fresh weight — paired, to nearest 0,1 mg).
 - Glans penis (fresh weight to nearest 0,1 mg)
- Weights of optional tissues, if performed:
 - Liver (to nearest 0,1 g)
 - Kidney (paired, to nearest 0,1 mg)
 - Adrenal (paired, to nearest 0,1 mg)
- General remarks and comments
- Analyses of serum hormones, if performed.
 - Serum LH (optional — ng per ml of serum), and
 - Serum T (optional — ng per ml of serum)
- General remarks and comments

Data summarisation

Data should be summarised in tabular form containing the sample size for each group, the mean of the value, and the standard error of the mean or the standard deviation. Tables should include necropsy body weights, body weight changes from the beginning of dosing until necropsy, target accessory sex tissues weights, and any optional organ weights.

*Discussion of the results***Analysis of results**

59. Necropsy body and organ weights should be statistically analysed for characteristics such as homogeneity of variance with appropriate data transformations as needed. Treatment groups should be compared to a control group using techniques such as ANOVA followed by pairwise comparisons (e.g. Dunnett's one tailed test) and the criterion for statistical difference, for example, $p \leq 0,05$. Those groups attaining statistical significance should be identified. However, 'relative organ' weights should be avoided due to the invalid statistical assumptions underlying this data manipulation.

▼ M5

60. For androgen agonism, the control should be the vehicle-only test group. The mode of action characteristics of a test chemical can lead to different relative responses amongst the tissues, for example trenbolone, which cannot be 5 alpha-reduced, has more pronounced effects on the LABC and GP than does TP. A statistically significant increase ($p \leq 0,05$) in any two or more of the five target androgen-dependent tissue weights (VP, LABC, GP, CG and SVCG) should be considered a positive androgen agonist result, and all the target tissues should display some degree of increased growth. Combined evaluation of all accessory sex organs (ASO) tissue responses could be achieved using appropriate multivariate data analysis. This could improve the analysis, especially in cases where only a single tissue gives a statistically significant response.
61. For androgen antagonism, the control should be the reference androgen (testosterone propionate only) test group. The mode of action characteristics of a test chemical can lead to different relative responses amongst the tissues, for example 5 alpha α -reductase inhibitors, like finasteride, have more pronounced effects on the ventral prostate than other tissues as compared to potent AR antagonists, like flutamide. A statistically significant reduction ($p \leq 0,05$) in any two or more of the five target androgen-dependent tissue weights (VP, LABC, GP, CG and SVCG) relative to TP treatment alone should be considered a positive androgen antagonist result and all the target tissues should display some degree of reduced growth. Combined evaluation of all ASO tissue responses could be achieved using appropriate multivariate data analysis. This could improve the analysis, especially in cases where only a single tissue gives a statistically significant response.
62. Data should be summarised in tabular form containing the mean, standard error of the mean (standard deviation would also be acceptable) and sample size for each group. Individual data tables should also be included. The individual values, mean, SE (SD) and CV values for the control data should be examined to determine if they meet acceptable criteria for consistency with expected historical values. CVs that exceed CV values listed in Table 1 (see paragraphs 25 and 26) for each organ weight should determine if there are errors in data recording or entry or if the laboratory has not yet mastered accurate dissection of the androgen-dependent tissues and further training/practice is warranted. Generally, CVs (the standard deviation divided by the mean organ weight) are reproducible from lab to lab and study to study. Data presented should include at least: ventral prostate, seminal vesicle, levator ani plus bulbocavernosus, Cowper's glands, glans penis, liver, and body weights and body weight change from the beginning of dosing until necropsy. Data also may be presented after covariance adjustment for body weight, but this should not replace presentation of the unadjusted data. In addition, if preputial separation (PPS) does not occur in any of the groups, the incidence of PPS should be recorded and statistically compared to the control group using Fisher Exact test.

▼ M5

63. When verifying the computer data entries with the original data sheets for accuracy, organ weight values that are not biologically plausible or vary by more than three standard deviations from that treatment group means should be carefully scrutinised and may need to be discarded, likely being recording errors.
64. Comparison of study results with OECD CV values (in Table 1) is often an important step in interpretation as to the validity of the study results. Historical data for vehicle control groups should be maintained in the laboratory. Historical data for responses to positive reference chemicals, such as TP and FT, should also be maintained in the laboratory. Laboratories may also periodically test the response to known weak androgen agonists and antagonists and maintain these data. These data can be compared to available OECD data to ensure that the laboratory's methods yield sufficient statistical precision and power.

▼ M5*Appendix 1*

DEFINITIONS:

Androgenic is a term used to describe a positive influence on the growth of androgen-dependent tissues

Antiandrogenic is the capability of a chemical to suppress the action of TP in a mammalian organism.

Chemical means a substance or a mixture.

Date of birth is postnatal day 0.

Dose is the amount of test chemical administered. For the Hershberger Bioassay, the dose is expressed as weight of test chemical per unit body weight of test animal per day (e.g. mg/kg body weight/day).

Dosage is a general term comprising of dose, its frequency and the duration of dosing.

Moribund is a term used to describe an animal in a dying state, i.e. near the point of death.

Postnatal day X is the Xth day of life after the day of birth.

Sensitivity is the capability of a test method to correctly identify chemicals having the property that is being tested for.

Specificity is the capability of a test method to correctly identify chemicals not having the property that is being tested for.

Test chemical means any substance or mixture tested using this test method.

Validation is a scientific process designed to characterise the operational requirements and limitations of a test method and to demonstrate its reliability and relevance for a particular purpose.

Appendix 2

Note: Document prepared by the Secretariat of the Test Guidelines Programme based on the agreement reached at the 6th Meeting of the EDTA Task Force

OECD Conceptual Framework for the Testing and Assessment of Endocrine Disrupting Chemicals

<p>Level 1 Sorting & prioritization based upon existing information</p>	<ul style="list-style-type: none"> — physical & chemical properties, e.g., MW, reactivity, volatility, biodegradability, — human & environmental exposure, e.g., production volume, release, use patterns — hazard, e.g., available toxicological data 	
<p>Level 2 <i>In vitro</i> assays providing mechanistic data</p>	<ul style="list-style-type: none"> — ER, AR, TR receptor binding affinity — Transcriptional activation — Aromatase and steroidogenesis <i>in vitro</i> — Aryl hydrocarbon receptor recognition/binding — QSARs 	<ul style="list-style-type: none"> — High Through Put Prescreens — Thyroid function — Fish hepatocyte VTG assay — Others (as appropriate)
<p>Level 3 <i>In vivo</i> assays providing data about single endocrine Mechanisms and effects</p>	<ul style="list-style-type: none"> — Uterotrophic assay (estrogenic related) — Hershberger assay (androgenic related) — Non-receptor mediated hormone function — Others (e.g. thyroid) 	<ul style="list-style-type: none"> — Fish VTG (vitellogenin) assay (estrogenic related)
<p>Level 4 <i>In vivo</i> assays providing data about multiple endocrine Mechanisms and effects</p>	<ul style="list-style-type: none"> — enhanced OECD 407 (endpoints based on endocrine mechanisms) — male and female pubertal assays — adult intact male assay 	<ul style="list-style-type: none"> — Fish gonadal histopathology assay — Frog metamorphosis assay
<p>Level 5 <i>In vivo</i> assays providing data on effects from endocrine & other mechanisms</p>	<ul style="list-style-type: none"> — 1-generation assay (TG415 enhanced)¹ — 2-generation assay (TG416 enhanced)¹ — reproductive screening test (TG421 enhanced)¹ — combined 28 day/reproduction screening test (TG 422 enhanced)¹ <p>¹ Potential enhancements will be considered by VMG mamm</p>	<ul style="list-style-type: none"> — Partial and full life cycle assays in fish, birds, amphibians & invertebrates (developmental and reproduction)

VMG mamm: Validation Management Group on Mammalian Testing and Assessment

▼ M5

NOTES TO THE FRAMEWORK:

- Note 1:* Entering at all levels and exiting at all levels is possible and depends upon the nature of existing information needs for hazard and risk assessment purposes
- Note 2:* In level 5, ecotoxicology should include endpoints that indicate mechanisms of adverse effects, and potential population damage
- Note 3:* When a multimodal model covers several of the single endpoint assays, that model would replace the use of those single endpoint assays
- Note 4:* The assessment of each chemical should be based on a case by case basis, taking into account all available information, bearing in mind the function of the framework levels.
- Note 5:* The framework should not be considered as all inclusive at the present time. At levels 3, 4 and 5 it includes assays that are either available or for which validation is under way. With respect to the latter, these are provisionally included. Once developed and validated, they will be formally added to the framework.
- Note 6:* Level 5 should not be considered as including definitive tests only. Tests included at that level are considered to contribute to general hazard and risk assessment.

LITERATURE

- (1) OECD (1998). Report of the First Meeting of the OECD Endocrine Disrupter Testing and Assessment (EDTA) Task Force, 10th-11th March 1998, ENV/MC/CHEM/RA(98)5.
- (2) Dorfman RI (1962). Standard methods adopted by official organization. Academic Press, NY.
- (3) Gray LE Jr, Furr J and Ostby JS (2005). Hershberger assay to investigate the effects of endocrine disrupting compounds with androgenic and anti-androgenic activity in castrate-immature male rats. In: *Current Protocols in Toxicology* 16.9.1-16.9.15. J Wiley and Sons Inc.
- (4) OECD (2006). Final OECD report of the initial work towards the validation of the rat Hershberger assay. Phase 1. Androgenic response to testosterone propionate and anti-androgenic effects of flutamide. Environmental Health and Safety, Monograph Series on Testing and Assessment N° 62. ENV/JM/MONO(2006)30.
- (5) OECD (2008). Report of the OECD Validation of the Rat Hershberger Bioassay: Phase 2: Testing of Androgen Agonists, Androgen Antagonists and a 5 α -Reductase Inhibitor in Dose Response Studies by Multiple Laboratories. Environmental Health and Safety, Monograph Series on Testing and Assessment N° 86. ENV/JM/MONO(2008)3.
- (6) OECD (2007). Report of the Validation of the Rat Hershberger Assay: Phase 3: Coded Testing of Androgen Agonists, Androgen Antagonists and Negative Reference Chemicals by Multiple Laboratories. Surgical Castrate Model Protocol. Environmental Health and Safety, Monograph Series on Testing and Assessment N° 73. ENV/JM/MONO(2007)20.
- (7) Owens, W, Zeiger E, Walker M, Ashby J, Onyon L, Gray, Jr, LE (2006). The OECD programme to validate the rat Hershberger bioassay to screen compounds for in vivo androgen and antiandrogen responses. Phase 1: Use of a potent agonist and a potent antagonist to test the standardized protocol. *Env. Health Persp.* 114:1265-1269.

▼ **M5**

- (8) Owens W, Gray LE, Zeiger E, Walker M, Yamasaki K, Ashby J, Jacob E (2007). The OECD program to validate the rat Hershberger bioassay to screen compounds for in vivo androgen and antiandrogen responses: phase 2 dose-response studies. *Environ Health Perspect.* 115(5):671-8.
- (9) Korenchevsky V (1932). The assay of testicular hormone preparations. *Biochem J*26:413-422.
- (10) Korenchevsky V, Dennison M, Schalit R (1932). The response of castrated male rats to the injection of the testicular hormone. *Biochem J*26:1306-1314.
- (11) Eisenberg E, Gordan GS (1950). The levator ani muscle of the rat as an index of myotrophic activity of steroidal hormones. *J Pharmacol Exp Therap* 99:38-44.
- (12) Eisenberg E, Gordan GS, Elliott HW (1949). Testosterone and tissue respiration of the castrate male rat with a possible test for myotrophic activity. *Endocrinology* 45:113-119.
- (13) Hershberger L, Shipley E, Meyer R (1953). Myotrophic activity of 19-nortestosterone and other steroids determined by modified levator ani muscle method. *Proc Soc Exp Biol Med* 83:175-180.
- (14) Hilgar AG, Vollmer EP (1964). *Endocrine bioassay data: Androgenic and myogenic.* Washington DC: United States Public Health Service.
- (15) Dorfman RI (1969). Androgens and anabolic agents. In: *Methods in Hormone Research, volume IIA.* (Dorfman RI, ed.) New York:Academic Press, 151-220.
- (16) Massaro EJ (2002). *Handbook of Neurotoxicology, volume I.* New York: Humana Press, p 38.
- (17) OECD (2000). Guidance document on the recognition, assessment and use of clinical signs as humane endpoints for experimental animals used in safety evaluation. *Environmental Health and Safety Monograph Series on Testing and Assessment No 19.* ENV/JM/MONO(2000)7.
- (18) OECD (1982). *Organization for Economic Co-operation and Development — Principles of Good Laboratory Practice,* ISBN 92-64-12367-9, Paris.
- (19) OECD (2008). *Acute oral toxicity — up-and-down procedure.* OECD Guideline for the testing of chemicals No 425.
- (20) OECD (2001). *Guidance document on acute oral toxicity.* *Environmental Health and Safety Monograph Series on Testing and Assessment No 24.* ENV/JM/MONO(2001)4.
- (21) Supplemental materials for Owens et al. (2006). The OECD programme to validate the rat Hershberger bioassay to screen compounds for in vivo androgen and antiandrogen responses. Phase 1: Use of a potent agonist and a potent antagonist to test the standardized protocol. *Env. Health Persp.* 114:1265-1269. See, section II, The dissection guidance provided to the laboratories: <http://www.ehponline.org/docs/2006/8751/suppl.pdf>.
- (22) Korea Food and Drug Administration. *Visual reference guide on Hershberger assay procedure, including a dissection video.* http://rmdmoa.kfda.go.kr/endocrine/reference/education_fr.html
- (23) OECD (2008). *Background Review Document on the Rodent Hershberger Bioassay.* *Environmental Health and Safety Monograph Series on Testing and Assessment No 90.* ENV/JM/MONO(2008)17.
- (24) OECD (2008). *Draft Validation report of the Intact, Stimulated, Weanling Male Rat Version of the Hershberger Bioassay.*
- (25) OECD (2009). *Guidance Document on the Weanling Hershberger Bioassay in rats: A shortterm screening assay for (anti)androgenic properties.* *Series on Testing and Assessment, Number 115.*

▼ **M5**

- (26) Directive 2010/63/EU of the European Parliament and of the Council of 22 September 2010 on the protection of animals used for scientific purposes (OJ L 276, 20.10.2010, p. 33).
- (27) The following chapters of this Annex:
 - B.1 bis, Acute oral toxicity — fixed dose procedure
 - B.1 tris, Acute oral toxicity — acute toxic class method

▼ M5**B.56 EXTENDED ONE-GENERATION REPRODUCTIVE TOXICITY STUDY**

INTRODUCTION

1. This test method is equivalent to OECD Test Guideline (TG) 443 (2012). It is based on the International Life Science Institute (ILSI)-Health and Environmental Sciences Institute (HESI), Agricultural Chemical Safety Assessment (ACSA) Technical Committee proposal for a life stage F₁ extended one generation reproductive study as published in Cooper et al., 2006 (1). Several improvements and clarifications have been made to the study design to provide flexibility and to stress the importance of starting with existing knowledge, while using in-life observations to guide and tailor the testing. This test method provides a detailed description of the operational conduct of an Extended One-Generation Reproductive Toxicity Study. The test method describes three cohorts of F₁ animals:

Cohort 1: assesses reproductive/developmental endpoints; this cohort may be extended to include an F₂ generation.

Cohort 2: assesses the potential impact of chemical exposure on the developing nervous system.

Cohort 3: assesses the potential impact of chemical exposure on the developing immune system.

2. Decisions on whether to assess the second generation and to omit the developmental neurotoxicity cohort and/or developmental immunotoxicity cohort should reflect existing knowledge for the chemical being evaluated, as well as the needs of various regulatory authorities. The purpose of the test method is to provide details on how the study can be conducted and to address how each cohort should be evaluated.
3. Procedure for the decision on the internal triggering for producing a second generation is described in OECD Guidance Document 117(39) for those regulatory authorities using internal triggers.

INITIAL CONSIDERATIONS AND OBJECTIVES

4. The main objective of the Extended One-Generation Reproductive Toxicity Study is to evaluate specific life stages not covered by other types of toxicity studies and test for effects that may occur as a result of pre- and postnatal chemical exposure. For reproductive endpoints, it is envisaged that, as a first step and when available, information from repeat-dose studies (including screening reproductive toxicity studies, e.g. OECD TG 422 (32)), or short term endocrine disrupter screening assays, (e.g. Uterotrophic assay — test method B.54 (36); and Hershberger assay — test method B.55 (37)) is used to detect effects on reproductive organs for males and females. This might include spermatogenesis (testicular histopathology) for males and oestrous cycles, follicle counts/oocyte maturation and ovarian integrity (histopathology) for females. The Extended One-Generation Reproductive Toxicity Study then serves as a test for reproductive endpoints that require the interaction of males with females, females with conceptus, and females with offspring and the F₁ generation until after sexual maturity (see OECD Guidance Document 151 supporting this test method (40)).

▼ M5

5. The test method is designed to provide an evaluation of the pre- and postnatal effects of chemicals on development as well as a thorough evaluation of systemic toxicity in pregnant and lactating females and young and adult offspring. Detailed examination of key developmental endpoints, such as offspring viability, neonatal health, developmental status at birth, and physical and functional development until adulthood, is expected to identify specific target organs in the offspring. In addition, the study will provide and/or confirm information about the effects of a test chemical on the integrity and performance of the adult male and female reproductive systems. Specifically, but not exclusively, the following parameters are considered: gonadal function, the oestrous cycle, epididymal sperm maturation, mating behaviour, conception, pregnancy, parturition, and lactation. Furthermore, the information obtained from the developmental neurotoxicity and developmental immunotoxicity assessments will characterise potential effects in those systems. The data derived from these tests should allow the determination of No-Observed Adverse Effect Levels (NOAELs), Lowest Observed Adverse Effect Levels (LOAELs) and/or benchmark doses for the various endpoints and/or be used to characterise effects detected in previous repeat-dose studies and/or serve as a guide for subsequent testing.

6. A schematic drawing of the protocol is presented in Figure 1. The test chemical is administered continuously in graduated doses to several groups of sexually mature males and females. This parental (P) generation is dosed for a defined pre-mating period (selected based on the available information for the test chemical; but for a minimum of two weeks) and a two-week mating period. P males are further treated at least until weaning of the F₁. They should be treated for a minimum of 10 weeks. They may be treated for longer if there is a need to clarify effects on reproduction. Treatment of the P females is continued during pregnancy and lactation until termination after the weaning of their litters (i.e. 8-10 weeks of treatment). The F₁ offspring receive further treatment with the test chemical from weaning to adulthood. If a second generation is assessed (see OECD Guidance Document 117(39)), the F₁ offspring will be maintained on treatment until weaning of the F₂, or until termination of the study.

7. Clinical observations and pathology examinations are performed on all animals for signs of toxicity, with special emphasis on the integrity and performance of the male and female reproductive systems and the health, growth, development and function of the offspring. At weaning, selected offspring are assigned to specific subgroups (cohorts 1-3, see paragraphs 33 and 34 and Figure 1) for further investigations, including sexual maturation, reproductive organ integrity and function, neurological and behavioural endpoints, and immune functions.

8. In conducting the study, the guiding principles and considerations outlined in the OECD Guidance Document No 19 on the recognition, assessment, and use of clinical signs as humane endpoints for experimental animals used in safety evaluations (34) should be followed.

▼ M5

9. When a sufficient number of studies are available to ascertain the impact of this new study design, the test method will be reviewed and if necessary revised in light of experience gained.

Figure 1

Scheme of the Extended One-Generation Reproductive Toxicity Study

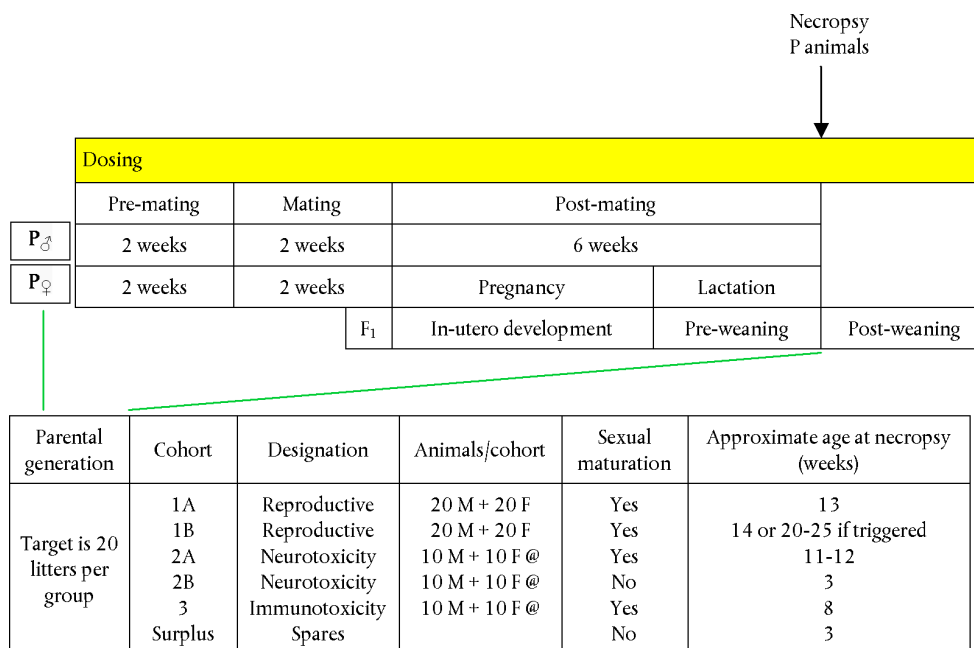

@ one per litter and representative of 20 litters in total where possible

DESCRIPTION OF THE METHOD/PREPARATIONS FOR THE TEST

Animals*Selection of animal species and strain*

10. The choice of species for the reproductive toxicity test should be carefully considered in light of all available information. However, because of the extent of background data and the comparability to general toxicity tests, the rat is normally the preferred species, and criteria and recommendations given in this test method refer to this species. If another species is used, justification should be given and appropriate modifications to the protocol will be necessary. Strains with low fecundity or a well-known high incidence of spontaneous developmental defects should not be used.

Age, body weight and inclusion criteria

11. Healthy parental animals, which have not been subjected to previous experimental procedures, should be used. Both males and females should be studied and the females should be nulliparous and non-pregnant. The P animals should be sexually mature, of similar weight (within sex) at initiation of dosing, similar age (approximately 90 days) at mating, and representative of the species and strain under study. Animals should be acclimated for at least 5 days after arrival. The animals are randomly assigned to the control and treatment groups, in a manner, which results in comparable mean body weight values among the groups (i.e. $\pm 20\%$ of the mean).

▼ M5*Housing and feeding conditions*

12. The temperature in the experimental animal room should be 22 °C (± 3 °C). Relative humidity should be between 30-70 %, with an ideal range of 50-60 %. Artificial lighting should be set at 12 hours light, 12 hours dark. Conventional laboratory diets may be used with an unlimited supply of drinking water. Careful attention should be given to diet phytoestrogen content, as a high level of phytoestrogen in the diet might affect some reproductive endpoints. Standardised, open-formula diets in which estrogenic chemicals have been reduced are recommended (2)(30). The choice of diet may be influenced by the need to ensure a suitable admixture of a test chemical when administered by this method. Content, homogeneity and stability of the test chemical in the diets should be verified. The feed and drinking water should be regularly analysed for contaminants. Samples of each batch of the diet used during the study should be retained under appropriate conditions (e.g. frozen at -20 °C), until finalisation of the report, in case the results necessitate a further analysis of diet ingredients.

13. Animals should be caged in small groups of the same sex and treatment group. They may be housed individually to avoid possible injuries (e.g. males after the mating period). Mating procedures should be carried out in suitable cages. After evidence of copulation, females that are presumed to be pregnant are housed separately in parturition or maternity cages where they are provided with appropriate and defined nesting materials. Litters are housed with their mothers until weaning. F₁ animals should be housed in small groups of the same sex and treatment group from weaning to termination. If scientifically justified, animals can be housed individually. The level of phytoestrogens contained in the selected bedding material should be minimal.

Number and identification of animals

14. Normally, each test and control group should contain a sufficient number of mating pairs to yield at least 20 pregnant females per dose group. The objective is to produce enough pregnancies to ensure a meaningful evaluation of the potential of the chemical to affect fertility, pregnancy and maternal behaviour of the P generation and growth and development of the F₁ offspring, from conception to maturity. Failure to achieve the desired number of pregnant animals does not necessarily invalidate the study and should be evaluated on a case-by-case basis, considering a possible causal relationship to the test chemical.

15. Each P animal is assigned a unique identification number before dosing starts. If laboratory historical data suggest that a significant proportion of females may not show regular (4 or 5-day) oestrous cycles, then an assessment of oestrous cycles before start of treatment is advised. Alternatively, the group size may be increased to ensure that at least 20 females in each group would have regular (4 or 5-day) oestrous cycles at start of treatment. All F₁ offspring are uniquely identified when neonates are first examined on postnatal day (PND) 0 or 1. Records indicating the litter of origin should be maintained for all F₁ animals, and F₂ animals where applicable, throughout the study.

▼ M5**Test chemical***Available information on the test chemical*

16. The review of existing information is important for decisions on the route of administration, the choice of the vehicle, the selection of animal species, the selection of dosages and potential modifications of the dosing schedule. Therefore, all the relevant available information on the test chemical, i.e. physico-chemical, toxicokinetics (including species-specific metabolism), toxicodynamic properties, structure-activity relationships (SARs), *in vitro* metabolic processes, results of previous toxicity studies and relevant information on structural analogues should be taken into consideration in planning the Extended One-Generation Reproductive Toxicity Study. Preliminary information on absorption, distribution, metabolism and elimination (ADME) and bioaccumulation may be derived from chemical structure, physico-chemical data, extent of plasma protein binding or toxicokinetic (TK) studies, while results from toxicity studies give additional information, e.g. on NOAEL, metabolism or induction of metabolism.

Consideration of toxicokinetic data

17. Although not required, TK data from previously conducted dose range-finding or other studies are extremely useful in the planning of the study design, selection of dose levels and interpretation of results. Of particular utility are data which: 1) verify exposure of developing fetuses and pups to the test chemical (or relevant metabolites), 2) provide an estimate of internal dosimetry, and 3) evaluate for potential dose-dependent saturation of kinetic processes. Additional TK data, such as metabolite profiles, concentration-time courses, etc. should also be considered, if they are available. Supplemental TK data may also be collected during the main study, provided that it does not interfere with the collection and interpretation of the main study endpoints.

As a general guide, the following TK data set would be useful in planning the Extended One-Generation Reproductive Toxicity Study:

— Late pregnancy (e.g. Gestation Day 20) — maternal blood and foetal blood

— Mid-lactation (PND 10) — maternal blood, pup blood and/or milk

— Early post-weaning (e.g. PND 28) — weanling blood samples.

Flexibility should be employed in determining the specific analytes (e.g. parent chemical and/or metabolites) and sampling scheme. For example, the number and timing of sample collection on a given sampling day will be dependent upon route of exposure and prior knowledge of TK properties in non-pregnant animals. For dietary studies, sampling at a single consistent time on each of these days is sufficient, whereas gavage dosing may warrant additional sampling times to obtain a better estimate of the range of internal doses. However, it is not necessary to generate a full concentration time-course on any of the sampling days. If necessary, blood can be pooled by sex within litters for fetal and neonatal analyses.

▼ M5*Route of administration*

18. Selection of the route should take into consideration the route(s) most relevant for human exposure. Although the protocol is designed for administration of the test chemical through the diet, it can be modified for administration by other routes (drinking water, gavage, inhalation, dermal), depending on the characteristics of the chemical and the information required.

Choice of the vehicle

19. Where necessary, the test chemical is dissolved or suspended in a suitable vehicle. It is recommended that, where possible, the use of an aqueous solution/suspension is considered first, followed by consideration of a solution/suspension in oil (e.g. corn oil). For vehicles other than water, the toxic characteristics of the vehicle should be known. Use of vehicles with potential intrinsic toxicity should be avoided (e.g. acetone, DMSO). The stability of the test chemical in the vehicle should be determined. Considerations should be given to the following characteristics if a vehicle or other additive is used to facilitate dosing: effects on the absorption, distribution, metabolism, or retention of the test chemical; effects on the chemical properties of the test chemical that may alter its toxic characteristics; and effects on the food or water consumption or the nutritional status of the animals.

Dose selection

20. Normally, the study should include at least three dose levels and a concurrent control. When selecting appropriate dose levels, the investigator should consider all available information, including the dosing information from previous studies, TK data from pregnant or non-pregnant animals, the extent of lactational transfer, and estimates of human exposure. If TK data are available which indicate dose-dependent saturation of TK processes, care should be taken to avoid high dose levels which clearly exhibit saturation, provided of course, that human exposures are expected to be well below the point of saturation. In such cases, the highest dose level should be at, or just slightly above the inflection point for transition to nonlinear TK behaviour.
21. In the absence of relevant TK data, the dose levels should be based on toxic effects, unless limited by the physical/chemical nature of the test chemical. If dose levels are based on toxicity, the highest dose should be chosen with the aim to induce some systemic toxicity, but not death or severe suffering of the animals.
22. A descending sequence of dose levels should be selected in order to demonstrate any dose-related effect and to establish NOAELs or doses near the limit of detection that would allow for derivation of a benchmark dose for the most sensitive endpoint(s). To avoid large dose spacing between NOAELs and LOAELs, two- or four-fold intervals are frequently optimal. The addition of a fourth test group is often preferable to using a very large interval (e.g. more than a factor of 10) between doses.
23. Except for treatment with the test chemical, animals in the control group are handled in an identical manner to the test group subjects. This group should be untreated or sham-treated or a vehicle-control group if a vehicle is used in administering the test chemical. If a vehicle is used, the control group should receive the vehicle in the highest volume used.

▼ M5*Limit test*

24. If there is no evidence of toxicity at a dose of at least 1 000 mg/kg body weight/day in repeat-dose studies, or if toxicity would not be expected based upon data from structurally- and/or metabolically-related chemicals, indicating similarity in the *in vivo/in vitro* metabolic properties, a study using several dose levels may not be necessary. In such cases, the Extended One-Generation Reproductive Toxicity Study could be conducted using a control group and a single dose of at least 1 000 mg/kg body weight/day. However, should evidence for reproductive or developmental toxicity be found at this limit dose, further studies at lower dose levels will be required to identify a NOAEL. These limit test considerations apply only when human exposure does not indicate the need for a higher dose level.

PROCEDURES

Exposure of offspring

25. Dietary exposure is the preferred method of administration. If gavage studies are performed, it should be noted that the pups will normally only receive test chemical indirectly through the milk, until direct dosing commences for them at weaning. In diet or drinking water studies, the pups will additionally receive test chemical directly when they commence eating for themselves during the last week of the lactation period. Modifications to the study design should be considered when excretion of the test chemical in milk is poor and where there is lack of evidence for a continuous exposure of the offspring. In these cases, direct dosing of pups during the lactation period should be considered based on available TK information, offspring toxicity or changes in bio-markers (3) (4). Careful consideration of benefits and disadvantages should be made prior to conducting direct-dosing studies on nursing pups (5).

Dosing schedule and administration of doses

26. Some information on oestrous cycles, male and female reproductive tract histopathology and testicular/epididymal sperm analysis may be available from previous repeat-dose toxicity studies of adequate duration. The duration of the pre-mating treatment in the Extended One-Generation Reproductive Toxicity Study is therefore aimed at the detection of effects on functional changes that may interfere with mating behaviour and fertilisation. The pre-mating treatment should be sufficiently long to achieve steady-state exposure conditions in P males and females. A 2-week pre-mating treatment for both sexes is considered adequate in most cases. For females, this covers 3-4 complete oestrous cycles and should be sufficient to detect any adverse effects on cyclicity. For males, this is equivalent to the time required for epididymal transit of maturing spermatozoa and should allow the detection of post-testicular effects on sperm (during the final stages of spermiation and epididymal sperm maturation) at mating. At the time of termination, when testicular and epididymal histopathology and analysis of sperm parameters are scheduled, the P and F₁ males, will have been exposed for at least one entire spermatogenic process ((6) (7) (8) (9) and OECD Guidance Document 151(40)).

▼ M5

27. Pre-mating exposure scenarios for males could be adapted if testicular toxicity (impairment of spermatogenesis) or effects on sperm integrity and function have been clearly identified in previous studies. Similarly, for females, known effects of the test chemical on the oestrous cycle and thus sexual receptivity, may justify different pre-mating exposure scenarios. In special cases it may be acceptable that treatment of the P females is initiated only after a sperm-positive smear has been obtained (see OECD Guidance Document 151(40)).

28. Once the pre-mating dosing period is established, the animals should be treated with the test chemical continuously on a 7-days/week basis until necropsy. All animals should be dosed by the same method. Dosing should continue during the 2-week mating period and, for P females, throughout gestation and lactation up to the day of termination after weaning. Males should be treated in the same manner until termination at the time when the F₁ animals are weaned. For necropsy, priority should be given to females which should be necropsied on the same/similar day of lactation. Necropsy of males can be spread over a larger number of days, depending on laboratory facilities. Unless already initiated during the lactation period, direct dosing of the selected F₁ males and females should begin at weaning and continue until scheduled necropsy, depending on cohort assignment.

29. For chemicals administered via the diet or drinking water, it is important to ensure that the quantities of the test chemical involved do not interfere with normal nutrition or water balance. When the test chemical is administered in the diet, either a constant dietary concentration (ppm) or a constant dose level in terms of the body weight of the animal may be employed; the option chosen should be specified.

30. When the test chemical is administered by gavage, the volume of liquid administered at one time should not normally exceed 1 ml/100 g body weight (0,4 ml/100 g body weight is the maximum for oil, e.g. corn oil). Except for irritant or corrosive chemicals, which will normally reveal exacerbated effects with higher concentrations, variability in test volume should be minimised by adjusting the concentration to ensure a constant volume at all dose levels. The treatment should be given at similar times each day. The dose to each animal should normally be based on the most recent individual bodyweight determination and adjusted at least weekly in adult males and adult non-pregnant females, and every two days in pregnant females and F₁ animals when administered prior to weaning and during the 2 weeks following weaning. If TK data indicate a low placental transfer of the test chemical, the gavage dose during the last week of pregnancy may have to be adjusted to prevent administration of an excessively toxic dose to the dam. Females should not be treated by gavage, or any other route of treatment where the animal needs to be handled, on the day of parturition; omission of test chemical administration on that day is preferable to a disturbance of the birth process.

▼ **M5****Mating**

31. Each P female should be placed with a single, randomly selected, unrelated male from the same dose group (1:1 pairing) until evidence of copulation is observed or 2 weeks have elapsed. If there are insufficient males, for example due to male death before pairing, then male(s) which have already mated may be paired (1:1) with a second female(s) such that all females are paired. Day 0 of pregnancy is defined as the day on which mating evidence is confirmed (a vaginal plug or sperm are found). Animals should be separated as soon as possible after evidence of copulation is observed. If mating has not occurred after 2 weeks, the animals should be separated without further opportunity for mating. Mating pairs should be clearly identified in the data.

Litter size

32. On day 4 after birth, the size of each litter may be adjusted by eliminating extra pups by random selection to yield, as nearly as possible, five males and five females per litter. Selective elimination of pups, e.g. based upon body weight, is not appropriate. Whenever the number of male or female pups prevents having five of each sex per litter, partial adjustment (for example, six males and four females) is acceptable.

Selection of pups for post-weaning studies (see Figure 1)

33. At weaning (around PND 21) pups from all available litters up to 20 per dose and control group are selected for further examinations and maintained until sexual maturation (unless earlier testing is required). Pups are selected randomly, with the exception that obvious runts (animals with a body weight more than two standard deviations below the mean pup weight of the respective litter) should not be included, as they are unlikely to be representative of the treatment group.

On PND 21, the selected F₁ pups are randomly assigned to one of three cohorts of animals, as follows:

Cohort 1 (1A and 1B) = Reproductive/developmental toxicity testing

Cohort 2 (2A and 2B) = Developmental neurotoxicity testing

Cohort 3 = Developmental immunotoxicity testing

Cohort 1A: One male and one female/litter/group (20/sex/group): priority selection for primary assessment of effects upon reproductive systems and of general toxicity.

Cohort 1B: One male and one female/litter/group (20/sex/group): priority selection for follow-up assessment of reproductive performance by mating F1 animals, when assessed (see OECD Guidance Document 117(39)), and for obtaining additional histopathology data in cases of suspected reproductive or endocrine toxicants, or when results from cohort 1A are equivocal.

Cohort 2A: Total of 20 pups per group (10 males and 10 females per group; one male or one female per litter) assigned for neurobehavioral testing followed by neurohistopathology assessment as adults.

Cohort 2B: Total of 20 pups per group (10 males and 10 females per group; one male or one female per litter) assigned for neurohistopathology assessment at weaning (PND 21 or PND 22). If there are insufficient numbers of animals, preference should be given to assign animals to Cohort 2A.

▼ M5

Cohort 3: Total of 20 pups per group (10 males and 10 females per group; one per litter, where possible). Additional pups may be required from the control group to act as positive control animals in the T-cell dependant antibody response assay (TDAR) at PND 56 ± 3 .

34. Should there be an insufficient number of pups in a litter to serve all cohorts, the cohort 1 takes precedence, as it can be extended to produce an F₂ generation. Additional pups may be assigned to any of the cohorts in case of specific concern, e.g. if a chemical is suspected to be a neurotoxicant, immunotoxicant or reproductive toxicant. These pups may be used for examinations at different timepoints or for the evaluation of supplementary endpoints. Pups not assigned to cohorts will be submitted to clinical biochemistry (paragraph 55) and gross necropsy (paragraph 68).

Second mating of the P animals

35. A second mating is not normally recommended for the P animals, as it comes at the expense of losing important information on the number of implantation sites (and thus post-implantation and peri-natal loss data, indicators of a possible teratogenic potential) for the first litter. The need to verify or elucidate an effect in exposed females would be served better by extending the study to include a mating of the F₁ generation. However, a second mating of the P males with untreated females is always an option to clarify equivocal findings or for further characterisation of effects on fertility observed in the first mating.

IN-LIFE OBSERVATIONS**Clinical observations**

36. For the P and the selected F₁ animals, a general clinical observation is made once a day. In the case of gavage dosing, the timing of clinical observations should be prior to and post dosing (for possible signs of toxicity associated with peak plasma concentration). Pertinent behavioural changes, signs of difficult or prolonged parturition and all signs of toxicity are recorded. Twice daily, during the weekend once daily, all animals are observed for severe toxicity, morbidity and mortality.

37. In addition, a more detailed examination of all P and F₁ animals (after weaning) is conducted on a weekly basis and could conveniently be performed on an occasion when the animal is weighed, which would minimise handling stress. Observations should be carefully conducted and recorded using scoring systems that have been defined by the testing laboratory. Efforts should be made to ensure that variations in the test conditions are minimal. Signs noted should include, but not be limited to, changes in skin, fur, eyes, mucous membranes, occurrence of secretions and excretions and autonomic activity (e.g. lacrimation, piloerection, pupil size, unusual respiratory pattern). Changes in gait, posture, response to handling, as well as the presence of clonic or tonic movements, stereotypy (e.g. excessive grooming, repetitive circling) or bizarre behaviour (e.g. self-mutilation, walking backwards) should also be recorded.

▼ M5**Body weight and food/water consumption**

38. P animals are weighed on the first day of dosing and at least weekly thereafter. In addition, P females are weighed during lactation on the same days as the weighing of the pups in their litters (see paragraph 44). All F₁ animals are weighed individually at weaning (PND 21) and at least weekly thereafter. Body weight is also recorded on the day when they attain puberty (completion of preputial separation or vaginal patency). All animals are weighed at sacrifice.

39. During the study, food and water consumption (in the case of test chemical administration in the drinking water) are recorded at least weekly on the same days as animal body weights (except during cohabitation). The food consumption of each cage of F₁ animals is recorded weekly commencing with selection to a respective cohort.

Oestrous cycles

40. Preliminary information of test chemical-related effects on the oestrous cycle may already be available from previous repeat-dose toxicity studies, and may be used in designing a test chemical-specific protocol for the Extended One-Generation Reproductive Toxicity Study. Normally the assessment of oestrous cyclicity (by vaginal cytology) will start at the beginning of the treatment period and continue until confirmation of mating or the end of the 2-week mating period. If females have been screened for normal oestrous cycles before treatment, then it is useful to continue smearing as treatment starts, but if there is concern about non-specific effects at the start of treatment (such as an initial marked reduction in food consumption) then animals may be allowed to adapt to treatment for up to two weeks before the start of the 2-week smearing period leading into pairing. If the female treatment period is extended in this way (i.e. to a 4-week pre-mating treatment) then consideration should be made to purchasing animals younger and to extending the period of male treatment before pairing. When obtaining vaginal/cervical cells, care should be taken to avoid disturbance of mucosa and subsequently, the induction of pseudopregnancy (10) (11).

41. Vaginal smears should be examined daily for all F₁ females in cohort 1A, after the onset of vaginal patency, until the first cornified smear is recorded, in order to determine the time interval between these two events. Oestrous cycles for all F₁ females in cohort 1A should also be monitored for a period of two weeks, commencing around PND 75. In addition, should mating of the F₁ generation be necessary, the vaginal cytology in cohort 1B will be followed from the time of pairing until mating evidence is detected.

Mating and pregnancy

42. In addition to the standard endpoints (e.g. body weight, food consumption, clinical observations including mortality/morbidity checks), the dates of pairing, the date of insemination and the date of parturition are recorded and the precoital interval (pairing to insemination) and the duration of pregnancy (insemination to parturition) are calculated. The P females should be examined carefully at the time of expected parturition for any signs of dystocia. Any abnormalities in nesting behaviour or nursing performance should be recorded.

▼ M5

43. The day on which parturition occurs is lactation day 0 (LD 0) for the dam and postnatal day 0 (PND 0) for the offspring. Alternatively, all comparisons may also be based on post-coital time to eliminate confounding of postnatal development data, by differences in the duration of pregnancy; however, timing relative to parturition should also be recorded. This is especially important when the test chemical exerts an influence on the duration of pregnancy.

Offspring parameters

44. Each litter should be examined as soon as possible after parturition (PND 0 or 1) to establish the number and sex of pups, stillbirths, live births, and the presence of gross anomalies (externally visible abnormalities, including cleft palate; subcutaneous haemorrhages; abnormal skin colour or texture; presence of umbilical cord; lack of milk in stomach; presence of dried secretions). In addition, the first clinical examination of the neonates should include a qualitative assessment of body temperature, state of activity and reaction to handling. Pups found dead on PND 0 or at a later time should be examined for possible defects and cause of death. Live pups are counted and weighed individually on PND 0 or PND 1, and regularly thereafter, e.g. at least on PND 4, 7, 14, and 21. Clinical examinations, as applicable for the age of the animals, should be repeated when the offspring are weighed, or more often if case-specific findings have been made at birth. Signs noted could include, but may not be limited to, external abnormalities, changes in skin, fur, eyes, mucous membranes, occurrence of secretions and excretions and autonomic activity. Changes in gait, posture, response to handling, as well as the presence of clonic or tonic movements, stereotypy or bizarre behaviour, should also be recorded.
45. The anogenital distance (AGD) of each pup should be measured on at least one occasion from PND 0 through PND 4. Pup body weight should be collected on the day the AGD is measured and the AGD should be normalised to a measure of pup size, preferably the cube root of body weight (12). The presence of nipples/areolae in male pups should be checked on PND 12 or 13.
46. All selected F₁ animals are evaluated daily for balano-preputial separation or vaginal patency for male/female respectively commencing before the expected day for achievement of these endpoints to detect if sexual maturation occurs early. Any abnormalities of genital organs, such as persistent vaginal thread, hypospadias or cleft penis, should be noted. Sexual maturity of F₁ animals is compared to physical development by determining age and body weight at balano-preputial separation or vaginal opening for male/female respectively (13).

Assessment of potential developmental neurotoxicity (cohorts 2A and 2B)

47. Ten male and 10 female cohort 2A animals and 10 male and 10 female cohort 2B animals, from each treatment group (for each cohort: 1 male or 1 female per litter; all litters represented by at least 1 pup; randomly selected) should be used for neurotoxicity assessments. Cohort 2A animals should be subjected to auditory startle, functional observational battery, motor activity (see paragraphs 48-50), and neuropathology assessments (see paragraphs 74-75). Efforts should be made to ensure that variations in all test

▼ M5

conditions are minimal and are not systematically related to treatment. Among the variables that can affect behaviour are sound level (e.g. intermittent noise), temperature, humidity, lighting, odours, time of day, and environmental distractions. Results of the neurotoxicity assays should be interpreted in relation to appropriate historical control reference ranges. Cohort 2B animals should be used for neuropathology assessment on PND 21 or PND 22 (see paragraphs 74-75).

48. An auditory startle test should be performed on PND 24 (\pm 1 day) using animals in cohort 2A. The day of testing should be counterbalanced across treated and control groups. Each session consists of 50 trials. In performing the auditory startle test, the mean response amplitude on each block of 10 trials (5 blocks of 10 trials) should be determined, with test conditions optimised to produce intra-session habituation. These procedures should be consistent with test method B.53 (35).

49. At an appropriate time between PND 63 and PND 75, the cohort 2A animals are subjected to a functional observational battery and an automated test of motor activity. These procedures should be consistent with test methods B.43 (33) and B.53 (35). The functional observational battery includes a thorough description of the subject's appearance, behaviour and functional integrity. This is assessed through observations in the home cage, after removal to a standard arena for observation (open field) where the animal is moving freely, and through manipulative tests. Testing should proceed from the least to the most interactive. A list of measures is presented in Appendix 1. All animals should be observed carefully by trained observers who are unaware of the animals' treatment status, using standardised procedures to minimise observer variability. Where possible, it is advisable that the same observer evaluates the animals in a given test. If this is not possible, some demonstration of inter-observer reliability is required. For each parameter in the behavioural testing battery, explicit operationally defined scales and scoring criteria are to be used. If possible, objective quantitative measures should be developed for observational endpoints, which involve subjective ranking. For motor activity, each animal is tested individually. The test session should be long enough to demonstrate intra-session habituation for controls. Motor activity should be monitored by an automated activity recording apparatus which should be capable of detecting both increases and decreases in activity, (i.e. baseline activity as measured by the device should not be so low as to preclude detection of decreases, nor so high as to preclude detection of increases in activity). Each device should be tested by standard procedures to ensure, to the extent possible, reliability of operation across devices and across days. To the extent possible, treatment groups should be balanced across devices. Treatment groups should be counter-balanced across test times to avoid confounding by circadian rhythms of activity.

50. If existing information indicates the need for other functional testing (e.g. sensory, social, cognitive), these should be integrated without compromising the integrity of the other evaluations conducted in the study. If this testing is performed in the same animals as used for standard auditory startle, functional observational battery and motor activity testing, different tests should be scheduled to minimise the risk of compromising the integrity of these tests. Supplemental procedures may be particularly useful when empirical observation, anticipated effects, or mechanistic/mode-of-action indicate a specific type of neurotoxicity.

▼ M5**Assessment of potential developmental immunotoxicity (cohort 3)**

51. At PND 56 (\pm 3 days), 10 male and 10 female cohort 3 animals from each treatment group (1 male or 1 female per litter; all litters represented by at least 1 pup; randomly selected) should be used in a T-cell dependant antibody response assay, i.e. the primary IgM antibody response to a T-cell dependent antigen, such as Sheep Red Blood Cells (SRBC) or Keyhole Limpet Hemocyanin (KLH), consistent with current immunotoxicity testing procedures (14) (15). The response may be evaluated by counting specific plaque-forming cells (PFC) in the spleen or by determining the titer of SRBC- or KLH-specific IgM antibody in the serum by ELISA, at the peak of the response. Responses typically peak four (PFC response) or five (ELISA) days after intravenous immunisation. If the primary antibody response is assayed by counting plaque-forming cells, it is permissible to evaluate subgroups of animals on separate days, provided that: subgroup immunisation and sacrifice are timed so that PFCs are counted at the peak of the response; that subgroups contain an equal number of male and female offspring from all dose groups, including controls; and that subgroups are evaluated at approximately the same postnatal age. Exposure to the test chemical will continue until the day before collecting spleens for the PFC response or serum for the ELISA assay.

Follow-up assessment of potential reproductive toxicity (cohort 1B)

52. Cohort 1B animals can be maintained on treatment beyond PND 90 and bred to obtain a F₂ generation if necessary. Males and females of the same dose group should be cohabited (avoiding the pairing of siblings) for up to two weeks, beginning on or after PND 90, but not exceeding PND 120. Procedures should be similar to those for the P animals. However, based on a weight of evidence, it may suffice to terminate the litters on PND 4 rather than follow them to weaning or beyond.

TERMINAL OBSERVATIONS

Clinical biochemistry/Haematology

53. Systemic effects should be monitored in P animals. Fasted blood samples from a defined site are taken from 10 randomly-selected P males and females per dose group at termination, stored under appropriate conditions and subjected to partial or full-scale haematology, clinical biochemistry, assay of T4 and TSH or other examinations suggested by the known effect profile of the test chemical (see OECD Guidance Document 151(40)). The following haematological parameters should be examined: haematocrit, haemoglobin concentration, erythrocyte count, total and differential leukocyte count, platelet count and blood clotting time/potential. Investigations of plasma or serum should include: glucose, total cholesterol, urea, creatinine, total protein, albumin and at least two enzymes indicative of hepatocellular effects (such as alanine aminotransferase, aspartate aminotransferase, alkaline phosphatase, gamma glutamyl transpeptidase and sorbitol dehydrogenase). Measurements of additional enzymes and bile acids may provide useful information under certain circumstances. In addition, blood from all animals may be taken and stored for possible analysis at a later time to help clarify equivocal effects or to generate

▼ M5

internal exposure data. If a second mating of P animals is not intended, the blood samples are obtained just prior to, or as part of, the procedure at scheduled sacrifice. In the case animals are retained, blood samples should be collected a few days before the animals are mated for the second time. Unless existing data from repeated-dose studies indicate that the parameter is not affected by the test chemical, urinalysis should be performed prior to termination and the following parameters evaluated: appearance, volume, osmolality or specific gravity, pH, protein, glucose, blood and blood cells, cell debris. Urine may also be collected to monitor excretion of test chemical and/or metabolite(s).

54. Systemic effects should also be monitored in F₁ animals. Fasted blood samples from a defined site are taken from 10 randomly selected cohort 1A males and females per dose group at termination, stored under appropriate conditions and subjected to standard clinical biochemistry, including the assessment of serum levels for thyroid hormones (T4 and TSH), haematology (total and differential leukocyte plus erythrocyte counts) and urinalysis assessments.
55. The surplus pups at PND 4 are subject to gross necropsy and consideration given to measuring serum thyroid hormone (T4) concentrations. If necessary, neonatal (PND 4) blood can be pooled by litters for biochemical/thyroid hormone analyses. Blood is also collected for T4 and TSH analysis from weanlings subject to gross necropsy on PND 22 (F₁ pups not selected for cohorts).

Sperm parameters

56. Sperm parameters should be measured in all P generation males unless there is existing data to show that sperm parameters are unaffected in a 90-day study. Examination of sperm parameters should be performed in all cohort 1A males.
57. At termination, testis and epididymis weights are recorded for all P and F₁ (cohort 1A) males. At least one testis and one epididymis are reserved for histopathological examination. The remaining epididymis is used for enumeration of cauda epididymis sperm reserves (16) (17). In addition, sperm from the cauda epididymis (or vas deferens) is collected using methods that minimise damage for evaluation of sperm motility and morphology (18).
58. Sperm motility can either be evaluated immediately after sacrifice or recorded for later analysis. The percentage of progressively motile sperm could be determined either subjectively or objectively by computer-assisted motion analysis (19) (20) (21) (22) (23) (24). For the evaluation of sperm morphology, an epididymal (or vas deferens) sperm sample should be examined as fixed or wet preparations (25) and at least 200 spermatozoa per sample classified as either normal (both head and midpiece/tail appear normal) or abnormal. Examples of morphologic sperm abnormalities would include fusion, isolated heads, and misshapen heads and/or tails (26). Misshapen or large sperm heads may indicate defects in spermiation.
59. If sperm samples are frozen, smears fixed and images for sperm motility analysis recorded at the time of necropsy (27), subsequent analysis may be restricted to control and high-dose males. However, if treatment-related effects are observed, the lower dose groups should also be evaluated.

▼ M5**Gross necropsy**

60. At the time of termination or premature death, all P and F₁ animals are necropsied and examined macroscopically for any structural abnormalities or pathological changes. Special attention should be paid to the organs of the reproductive system. Pups that are humanely killed in a moribund condition and dead pups should be recorded and, when not macerated, examined for possible defects and/or cause of death and preserved.
61. For adult P and F₁ females, a vaginal smear is examined on the day of necropsy to determine the stage of the oestrous cycle and allow correlation with histopathology in reproductive organs. The uteri of all P females (and F₁ females, if applicable) are examined for the presence and number of implantation sites, in a manner which does not compromise histopathological evaluation.

Organ weight and tissue preservation — P and F₁ adult animals

62. At the time of termination, body weights and wet weights of the organs listed below from all P animals and all F₁ adults, from relevant cohorts (as outlined below), are determined as soon as possible after dissection to avoid drying. These organs should then be preserved under appropriate conditions. Unless specified otherwise, paired organs can be weighed individually or combined, consistent with the typical practice of the performing laboratory.
- Uterus (with oviducts and cervix), ovaries
 - Testes, epididymides (total and cauda for the samples used for sperm counts)
 - Prostate (dorsolateral and ventral parts combined). Care should be exercised when trimming the prostate complex to avoid puncture of the fluid filled seminal vesicles. In the event of a treatment-related effect on total prostate weight, the dorsolateral and ventral segments should be carefully dissected after fixation, and weighed separately.
 - Seminal vesicles with coagulating glands and their fluids (as one unit)
 - Brain, liver, kidneys, heart, spleen, thymus, pituitary, thyroid (post-fixation), adrenal glands and known target organs or tissues.
63. In addition to the organs listed above, samples of peripheral nerve, muscle, spinal cord, eye plus optic nerve, gastrointestinal tract, urinary bladder, lung, trachea (with thyroid and parathyroid attached), bone marrow, vas deferens (males), mammary gland (males and females) and vagina should be preserved under appropriate conditions.
64. Cohort 1A animals have all organs weighed and preserved for histopathology.
65. For the investigation of pre- and postnatally induced immunotoxic effects, 10 male and 10 female cohort 1A animals from each treatment group (1 male or 1 female per litter; all litters represented by at least 1 pup; randomly selected) will be subject to the following at termination:
- weighing of the lymph nodes associated with and distant from the route of exposure (in addition to the weight of the adrenal glands, the thymus and the spleen, already performed in all cohort 1A animals)

▼ M5

- splenic lymphocyte subpopulation analysis (CD4+ and CD8+ T lymphocytes, B lymphocytes, and natural killer cells) using one half of the spleen, the other half of the spleen being preserved for histopathological evaluation,

Analysis of splenic lymphocyte subpopulations in non-immunised (cohort 1A) animals will determine if exposure is related to a shift in the immunological steady state distribution of ‘helper’ (CD4+) or cytotoxic (CD8+) thymus-derived lymphocytes or natural killer (NK) cells (rapid responses to neoplastic cells and pathogens).

66. Cohort 1B animals should have the following organs weighed and corresponding tissues processed to the block stage:

- Vagina (not weighed)
- Uterus with cervix
- Ovaries
- Testes (at least one)
- Epididymides
- Seminal vesicles and coagulating glands
- Prostate
- Pituitary
- Identified target organs

Histopathology in cohort 1B would be conducted if results from cohort 1A are equivocal or in cases of suspected reproductive or endocrine toxicants.

67. Cohorts 2A and 2B: Developmental neurotoxicity testing (PND 21 or PND 22 and adult offspring). Cohort 2A animals are terminated after behavioural testing, with brain weight recorded and full neurohistopathology for purposes of neurotoxicity assessment. Cohort 2B animals are terminated on PND 21 or PND 22, with brain weight recorded and microscopic examination of the brain for purposes of neurotoxicity assessment. Perfusion fixation is required for cohort 2A animals and optional for cohort 2B animals, as provided in test method B.53 (35).

Organ weight and tissue preservation — F₁ weanlings

68. The pups not selected for cohorts, including runts, are terminated after weaning, on PND 22, unless the results indicate the need for further in-life investigations. Terminated pups are subjected to gross necropsy including an assessment of the reproductive organs, as described in paragraphs 62 and 63. For up to 10 pups per sex per group, from as many litters as possible, brain, spleen, and thymus should be weighed and retained under appropriate conditions. In addition, mammary tissues for these male and female pups may be preserved for further microscopic analysis⁽¹⁾ (see OECD Guidance Document 151(40)). Gross abnormalities and target tissues should be saved for possible histological examination.

⁽¹⁾ Research has shown the mammary gland, especially in early life mammary gland development, to be a sensitive endpoint for oestrogen action. It is recommended that endpoints involving pup mammary glands of both sexes be included in this test method, when validated.

▼ M5**Histopathology — P animals**

69. Full histopathology of the organs listed in paragraphs 62 and 63 is performed for all high-dose and control P animals. Organs demonstrating treatment-related changes should also be examined in all animals at the lower dose groups to aid in determining a NOAEL. Additionally, reproductive organs of all animals suspected of reduced fertility, e.g. those that failed to mate, conceive, sire, or deliver healthy offspring, or for which oestrous cyclicity or sperm number, motility, or morphology were affected, and all gross lesions should be subjected to histopathological evaluation.

Histopathology — F₁ animals*Cohort 1 animals*

70. Full histopathology of the organs listed in paragraphs 62 and 63 is performed for all high-dose and control adult cohort 1A animals. All litters should be represented by at least 1 pup per sex. Organs and tissues demonstrating treatment-related changes and all gross lesions should also be examined in all animals in the lower dose groups to aid in determining a NOAEL. For the evaluation of pre- and postnatally induced effects on lymphoid organs also the histopathology on the collected lymph nodes and bone marrow should be evaluated of 10 male and 10 female cohort 1A animals next to histopathological evaluation of the thymus, spleen, and the adrenal glands already performed in all 1A animals.
71. Reproductive and endocrine tissues from all cohort 1B animals, processed to the block stage as described in paragraph 66, should be examined for histopathology in cases of suspected reproductive or endocrine toxicants. Cohort 1B should also undergo histological examination if results from cohort 1A are equivocal.
72. Ovaries of adult females should contain primordial and growing follicles, as well as corpora lutea; therefore, a histopathological examination should be aimed at detecting a quantitative evaluation of primordial and small growing follicles, as well as corpora lutea, in F₁ females; the number of animals, ovarian section selection, and section sample size should be statistically appropriate for the evaluation procedure used. Follicular enumeration may first be conducted on control and high-dose animals, and in the event of an adverse effect in the latter, lower doses should be examined. Examination should include enumeration of the number of primordial follicles, which can be combined with small growing follicles, for comparison of treated and control ovaries (see OECD Guidance Document 151(40)). Corpora lutea assessment should be conducted in parallel with oestrous cyclicity testing so that the stage of the cycle can be taken into account in the assessment. Oviduct, uterus and vagina are examined for appropriate organ-typic development.
73. Detailed testicular histopathology examinations are conducted on the F₁ males in order to identify treatment-related effects on testis differentiation and development and on spermatogenesis (38). When possible, sections of the rete testis should be examined. Caput, corpus, and cauda of the epididymis and the vas deferens are examined for appropriate organ-typic development, as well as for the parameters required for the P males.

▼ M5*Cohort 2 animals*

74. Neurohistopathology is performed for all high-dose and control cohort 2A animals per sex following completion of neurobehavioral testing (after PND 75, but not to exceed PND 90). Brain histopathology is performed for all high-dose and control cohort 2B animals per sex on PND 21 or PND 22. Organs or tissues demonstrating treatment-related changes should also be examined for the animals in the lower dose groups to aid in determining a NOAEL. For cohort 2A and 2B animals, multiple sections are examined from the brain to allow examination of olfactory bulbs, cerebral cortex, hippocampus, basal ganglia, thalamus, hypothalamus, mid-brain (thecum, tegmentum, and cerebral peduncles), brain-stem and cerebellum. For cohort 2A only, the eyes (retina and optic nerve) and samples of peripheral nerve, muscle and spinal cord are examined. All neurohistological procedures should be consistent with test method B.53 (35).
75. Morphometric (quantitative) evaluations should be performed on representative areas of the brain (homologous sections carefully selected based on reliable microscopic landmarks) and may include linear and/or areal measurements of specific brain regions. At least three consecutive sections should be taken at each landmark (level) in order to select the most homologous and representative section for the specific brain area to be evaluated. The neuropathologist should exercise appropriate judgment as to whether sections prepared for measurement are homologous with others in the sample set and therefore suitable for inclusion, since linear measurements in particular may change over a relatively short distance (28). Non-homologous sections should not be used. While the objective is to sample all animals reserved for this purpose (10/sex/dose level), smaller numbers may still be adequate. However, samples from fewer than 6 animals/sex/dose level would generally not be considered sufficient for the purposes of this test method. Stereology may be used to identify treatment-related effects on parameters such as volume or cell number for specific neuroanatomic regions. All aspects of the preparation of tissue samples, from tissue fixation, through the dissection of tissue samples, tissue processing, and staining of slides, should employ a counterbalanced design, such that each batch contains representative samples from each dose group. When morphometric or stereological analyses are to be used, then brain tissue should be embedded in appropriate media at all dose levels at the same time in order to avoid shrinkage artefacts associated with prolonged storage in fixative.

REPORTING

Data

76. Data are reported individually and summarised in tabular form. Where appropriate, for each test group and each generation, the following should be reported: number of animals at the start of the test, number of animals found dead during the test or killed for humane reasons, time of any death or humane kill, number of fertile animals, number of pregnant females, number of females giving birth to a litter, and number of animals showing signs of toxicity. A description of the toxicity, including time of onset, duration, and severity should also be reported.
77. Numerical results should be evaluated by an appropriate, and accepted statistical method. The statistical methods should be selected as part of the study design and should appropriately address non-normal data (e.g. count data), censored data (e.g. limited observation time), non-independence (e.g. litter effects and repeated measures), and unequal variances.

▼ M5

Generalised linear mixed models and dose-response models cover a broad class of analytical tools that may be appropriate for the data generated under this test method. The report should include sufficient information on the method of analysis and the computer program employed, so that an independent reviewer/statistician can evaluate/re-evaluate the analysis.

Evaluation of results

78. The findings should be evaluated in terms of the observed effects, including necropsy and microscopic findings. The evaluation includes the relationship, or lack thereof, between the dose and the presence, incidence, and severity of abnormalities, including gross lesions. Target organs, fertility, clinical abnormalities, reproductive and litter performance, body weight changes, mortality and any other toxic and developmental effects should also be assessed. Special attention should be given to sex-specific changes. The physico-chemical properties of the test chemical, and when available, TK data, including placental transfer and milk excretion, should be taken into consideration when evaluating the test results.

Test report

79. The test report should include the following information obtained in the present study from P, F₁ animals and F₂ animals (where relevant):

Test chemical:

- All relevant available information on the chemical, toxicokinetic and toxicodynamic properties of the test chemical;
- Identification data;
- Purity;

Vehicle (if appropriate):

- Justification for choice of vehicle if other than water;

Test animals:

- Species/strain used;
- Number, age and sex of animals;
- Source, housing conditions, diet, nesting materials, etc.;
- Individual weights of animals at the start of the test;
- Vaginal smear data for P females before initiation of treatment (if data are collected at that time);
- P generation pairing records indicating male and female partner of a mating and mating success;
- Litter of origin records for adult F₁ generation animals;

Test conditions:

- Rationale for dose level selection;
- Details of test chemical formulation/diet preparation, achieved concentrations;

▼ M5

- Stability and homogeneity of the preparation in the vehicle or carrier (e.g. diet, drinking water), in the blood and/or milk under the conditions of use and storage between uses;
- Details of the administration of the test chemical;
- Conversion from diet/drinking water test chemical concentration (ppm) to the achieved dose (mg/kg body weight/day), if applicable;
- Details of food and water quality (including diet composition, if available);
- Detailed description of the randomisation procedures to select pups for culling and to assign pups to test groups;
- Environmental conditions;
- List of study personnel, including professional training;

Results (summary and individual data by sex and dose):

- Food consumption, water consumption if available, food efficiency (body weight gain per gram of food consumed, except for the period of cohabitation and during lactation), and test chemical consumption (for dietary/drinking water administration) for P and F₁ animals;
- Absorption data (if available);
- Body weight data for P animals;
- Body weight data for the selected F₁ animals postweaning;
- Time of death during the study or whether animals survived to termination;
- Nature, severity and duration of clinical observations (whether reversible or not);
- Haematology, urinalysis and clinical chemistry data including TSH and T₄;
- Phenotypic analysis of spleen cells (T-, B-, NK-cells);
- Bone marrow cellularity;
- Toxic response data;
- Number of P and F₁ females with normal or abnormal oestrous cycle and cycle duration;
- Time to mating (precoital interval, the number of days between pairing and mating);
- Toxic or other effects on reproduction, including numbers and percentages of animals that accomplished mating, pregnancy, parturition and lactation, of males inducing pregnancy, of females with signs of dystocia/prolonged or difficult parturition;
- Duration of pregnancy and, if available, parturition;
- Numbers of implantations, litter size and percentage of male pups;
- Number and percent of post-implantation loss, live births and stillbirths;

▼ M5

- Litter weight and pup weight data (males, females and combined), the number of runts if determined;
- Number of pups with grossly visible abnormalities;
- Toxic or other effects on offspring, postnatal growth, viability, etc.;
- Data on physical landmarks in pups and other postnatal developmental data;
- Data on sexual maturation of F₁ animals;
- Data on functional observations in pups and adults, as applicable;
- Body weight at sacrifice and absolute and relative organ weight data for the P and adult F₁ animals;
- Necropsy findings;
- Detailed description of all histopathological findings;
- Total cauda epididymal sperm number, percent progressively motile sperm, percent morphologically normal sperm, and percent of sperm with each identified abnormality for P and F₁ males;
- Numbers and maturational stages of follicles contained in the ovaries of P and F₁ females, where applicable;
- Enumeration of corpora lutea in the ovaries of F₁ females;
- Statistical treatment of results, where appropriate;

Cohort 2 parameters:

- Detailed description of the procedures used to standardise observations and procedures as well as operational definitions for scoring observations;
- List of all test procedures used, and justification for their use;
- Details of the behavioural/functional, neuropathological and morphometric procedures used, including information and details on automated devices;
- Procedures for calibrating and ensuring the equivalence of devices and the balancing of treatment groups in testing procedures;
- Short justification explaining any decisions involving professional judgment;
- Detailed description of all behavioural/functional, neuropathological and morphometric findings by sex and dose group, including both increases and decreases from controls;
- Brain weight;
- Any diagnoses derived from neurological signs and lesions, including naturally-occurring diseases or conditions;
- Images of exemplar findings;
- Low-power images to assess homology of sections used for morphometry;

▼ M5

- Statistical treatment of results, including statistical models used to analyse the data, and the results, regardless of whether they were significant or not;
- Relationship of any other toxic effects to a conclusion about the neurotoxic potential of the test chemical, by sex and dose group;
- Impact of any toxicokinetic information on the conclusions;
- Data supporting the reliability and sensitivity of the test method (i.e. positive and historical control data);
- Relationships, if any, between neuropathological and functional effects;
- NOAEL or benchmark dose for dams and offspring, by sex and dose group;
- Discussion of the overall interpretation of the data based on the results, including a conclusion of whether or not the chemical caused developmental neurotoxicity and the NOAEL;

Cohort 3 parameters:

- Serum IgM antibody titres (sensitisation to SRBC or KLH), or splenic IgM PFC units (sensitisation to SRBC);
- Performance of the TDAR method should be confirmed as part of the optimisation process by laboratory setting up the assay for the first time, and periodically (e.g. yearly) by all laboratories;
- Discussion of the overall interpretation of the data based on the results, including a conclusion of whether or not the chemical caused developmental immunotoxicity and the NOAEL;

*Discussion of results**Conclusions, including NOAEL values for parental and offspring effects*

All information not obtained during the study, but useful for the interpretation of the results (e.g. similarities of effects to any known neurotoxicants), should also be provided.

Interpretation of Results

80. An Extended One-Generation Reproductive Toxicity Study will provide information on the effects of repeated exposure to a chemical during all phases of the reproductive cycle, as necessary. In particular, the study provides information on the reproductive system, and on development, growth, survival, and functional endpoints of offspring up to PND 90.
81. Interpretation of the results of the study should take into account all available information on the chemical, including physico-chemical, TK and toxicodynamic properties, available relevant information on structural analogues, and results of previously-conducted toxicity studies with the test chemical (e.g. acute toxicity, toxicity after repeated application, mechanistic studies and studies assessing if there are substantial qualitative and quantitative species differences in *in vivo/in vitro* metabolic properties). Gross necropsy and organ weight results should be assessed in context with observations made in other repeat-dose studies, when feasible. Decreases in offspring growth might be considered in relationship to an influence of the test chemical on milk composition (29).

▼ **M5***Cohort 2 (Developmental neurotoxicity)*

82. Neurobehavioral and neuropathology results should be interpreted in the context of all findings, using a weight-of-evidence approach with expert judgment. Patterns of behavioural or morphological findings, if present, as well as evidence of dose-response should be discussed. The evaluation of developmental neurotoxicity, including human epidemiological studies or case reports, and experimental animal studies (e.g. toxicokinetic data, structure-activity information, data from other toxicity studies) should be included in this characterisation. Evaluation of data should include a discussion of both the biological and statistical significance. The evaluation should include the relationship, if any, between observed neuropathological and behavioural alterations. For guidance on the interpretation of developmental neurotoxicity results, refer to test method B.53 (35) and Tyl et al., 2008 (31).

Cohort 3 (Developmental immunotoxicity)

83. Suppression or enhancement of immune function as assessed by TDAR (T-cell dependent antibody response), should be evaluated in the context of all observations made. Significance of the outcome of TDAR may be supported by other effects on immunologically-related indicators (e.g. bone marrow cellularity, weight and histopathology of lymphoid tissues, lymphocyte subset distribution). Effects established by TDAR may be less meaningful in case of other toxicities observed at lower exposure concentrations.
84. OECD Guidance Document 43 should be consulted for aid in the interpretation of reproduction and neurotoxicity results (26).

LITERATURE

- (1) Cooper, R.L., J.C. Lamb, S.M. Barlow, K. Bentley, A.M. Brady, N. Doerr, D.L. Eisenbrandt, P.A. Fenner-Crisp, R.N. Hines, L.F.H. Irvine, C.A. Kimmel, H. Koeter, A.A. Li, S.L. Makris, L.P. Sheets, G.J.A. Speijers and K.E. Whitby (2006), 'A Tiered Approach to Life Stages Testing for Agricultural Chemical Safety Assessment', *Critical Reviews in Toxicology*, 36, 69-98.
- (2) Thigpen, J.E., K.D.R. Setchell, K.B. Ahlmark, J. Locklear, T. Spahr, G.F. Leviness, M.F. Goelz, J.K. Haseman, R.R. Newbold, and D.B. Forsythe (1999), 'Phytoestrogen Content of Purified Open and Closed Formula Laboratory Animal Diets', *Lab. Anim. Sci.*, 49, 530- 536.
- (3) Zoetis, T. and I. Walls (2003), *Principles and Practices for Direct Dosing of Pre-Weaning Mammals in Toxicity Testing and Research*, ILSI Press, Washington, DC.
- (4) Moser, V.C., I. Walls and T. Zoetis (2005), 'Direct Dosing of Preweaning Rodents in Toxicity Testing and Research: Deliberations of an ILSI RSI Expert Working Group', *International Journal of Toxicology*, 24, 87-94.
- (5) Conolly, R.B., B.D. Beck, and J.I. Goodman (1999), 'Stimulating Research to Improve the Scientific Basis of Risk Assessment', *Toxicological Sciences*, 49, 1-4.
- (6) Ulbrich, B. and A.K. Palmer (1995), 'Detection of Effects on Male Reproduction — a Literature Survey', *Journal of the American College of Toxicologists*, 14, 293-327.
- (7) Mangelsdorf, I., J. Buschmann and B. Orthen (2003), 'Some Aspects Relating to the Evaluation of the Effects of Chemicals on Male Fertility', *Regulatory Toxicology and Pharmacology*, 37, 356-369.

▼ M5

- (8) Sakai, T., M. Takahashi, K. Mitsumori, K. Yasuhara, K. Kawashima, H. Mayahara and Y. Ohno (2000). 'Collaborative work to evaluate toxicity on male reproductive organs by repeated dose studies in rats — overview of the studies', *Journal of Toxicological Sciences*, 25, 1-21.
- (9) Creasy, D.M. (2003), 'Evaluation of Testicular Toxicology: A Synopsis and Discussion of the Recommendations Proposed by the Society of Toxicologic Pathology', *Birth Defects Research, Part B*, 68, 408-415.
- (10) Goldman, J.M., A.S. Murr, A.R. Buckalew, J.M. Ferrell and R.L. Cooper (2007), 'The Rodent Estrous Cycle: Characterization of Vaginal Cytology and its Utility in Toxicological Studies', *Birth Defects Research, Part B*, 80 (2), 84-97.
- (11) Sadleir, R.M.F.S. (1979), 'Cycles and Seasons', in C.R. Auston and R.V. Short (eds.), *Reproduction in Mammals: I. Germ Cells and Fertilization*, Cambridge, New York.
- (12) Gallavan, R.H. Jr, J.F. Holson, D.G. Stump, J.F. Knapp and V.L. Reynolds (1999), 'Interpreting the Toxicologic Significance of Alterations in Anogenital Distance: Potential for Confounding Effects of Progeny Body Weights', *Reproductive Toxicology*, 13: 383-390.
- (13) Korenbrot, C.C., I.T. Huhtaniemi and R.I. Weiner (1977), 'Preputial Separation as an External Sign of Pubertal Development in the Male Rat', *Biological Reproduction*, 17, 298-303.
- (14) Ladics, G.S. (2007), 'Use of SRBC Antibody Responses for Immunotoxicity Testing', *Methods*, 41, 9-19.
- (15) Gore, E.R., J. Gower, E. Kurali, J.L. Sui, J. Bynum, D. Enmulat and D.J. Herzyk (2004), 'Primary Antibody Response to Keyhole Limpet Hemocyanin in Rat as a Model for Immunotoxicity Evaluation', *Toxicology*, 197, 23-35.
- (16) Gray, L.E., J. Ostby, J. Ferrell, G. Rehnberg, R. Linder, R. Cooper, J. Goldman, V. Slott and J. Laskey (1989), 'A Dose-Response Analysis of Methoxychlor-Induced Alterations of Reproductive Development and Function in the Rat', *Fundamental and Applied Toxicology*, 12, 92-108.
- (17) Robb, G.W., R.P. Amann and G.J. Killian (1978), 'Daily Sperm Production and Epididymal Sperm Reserves of Pubertal and Adult Rats', *Journal of Reproduction and Fertility*, 54, 103-107.
- (18) Klinefelter, G.R., L.E. Jr Gray and J.D. Suarez (1991), 'The Method of Sperm Collection Significantly Influences Sperm Motion Parameters Following Ethane Dimethanesulfonate Administration in the Rat'. *Reproductive Toxicology*, 5, 39-44.
- (19) Seed, J., R.E. Chapin, E.D. Clegg, L.A. Dostal, R.H. Foote, M.E. Hurtt, G.R. Klinefelter, S.L. Makris, S.D. Perreault, S. Schrader, D. Seyler, R. Sprando, K.A. Treinen, D.N. Veeramachaneni and L.D. Wise (1996), 'Methods for Assessing Sperm Motility, Morphology, and Counts in the Rat, Rabbit, and Dog: a Consensus Report', *Reproductive Toxicology*, 10, 237- 244.
- (20) Chapin, R.E., R.S. Filler, D. Gulati, J.J. Heindel, D.F. Katz, C.A. Mebus, F. Obasaju, S.D. Perreault, S.R. Russell and S. Schrader (1992), 'Methods for Assessing Rat Sperm Motility', *Reproductive Toxicology*, 6, 267-273.
- (21) Klinefelter, G.R., N.L. Roberts and J.D. Suarez (1992), 'Direct Effects of Ethane Dimethanesulphonate on Epididymal Function in Adult Rats: an *In Vitro* Demonstration', *Journal of Andrology*, 13, 409-421.
- (22) Slott, V.L., J.D. Suarez and S.D. Perreault (1991), 'Rat Sperm Motility Analysis: Methodologic Considerations', *Reproductive Toxicology*, 5, 449-458.

▼ M5

- (23) Slott, V.L., and S.D. Perreault (1993), 'Computer-Assisted Sperm Analysis of Rodent Epididymal Sperm Motility Using the Hamilton-Thorn Motility Analyzer', *Methods in Toxicology, Part A*, Academic, Orlando, Florida. pp. 319-333.
- (24) Toth, G.P., J.A. Stober, E.J. Read, H. Zenick and M.K. Smith (1989), "The Automated Analysis of Rat Sperm Motility Following Subchronic Epichlorohydrin Administration: Methodologic and Statistical Considerations", *Journal of Andrology*, 10, 401-415.
- (25) Linder, R.E., L.F. Strader, V.L. Slott and J.D. Suarez (1992), 'Endpoints of Spermatotoxicity in the Rat After Short Duration Exposures to Fourteen Reproductive Toxicants', *Reproductive Toxicology*, 6, 491-505.
- (26) OECD (2008), *Guidance Document on Mammalian Reproductive Toxicity Testing and Assessment*, Series on Testing and Assessment, No 43, ENV/JM/MONO(2008)16, OECD, Paris.
- (27) Working, P.K., M. Hurtt (1987), 'Computerized Videomicrographic Analysis of Rat Sperm Motility', *Journal of Andrology*, 8, 330-337.
- (28) Bolin, B., R. Garman, K. Jensen, G. Krinke, B. Stuart, and an ad Hoc Working Group of the STP Scientific and Regulatory Policy Committee (2006), 'A "Best Practices" Approach to Neuropathologic Assessment in Developmental Neurotoxicity Testing — for Today', *Toxicological Pathology*, 34, 296-313.
- (29) Stütz, N., B. Bongiovanni, M. Rassetto, A. Ferri, A.M. Evangelista de Duffard, and R. Duffard (2006), 'Detection of 2,4-dichlorophenoxyacetic Acid in Rat Milk of Dams Exposed During Lactation and Milk Analysis of their Major Components', *Food Chemicals Toxicology*, 44, 8-16.
- (30) Thigpen, JE, K.D.R. Setchell, J.K. Haseman, H.E. Saunders, G.F. Caviness, G.E. Kissling, M.G. Grant and D.B. Forsythe (2007), 'Variations in Phytoestrogen Content between Different Mill Dates of the Same Diet Produces Significant Differences in the Time of Vaginal Opening in CD-1 Mice and F344 Rats but not in CD Sprague Dawley Rats', *Environmental health perspectives*, 115(12), 1717-1726.
- (31) Tyl, R.W., K. Crofton, A. Moretto, V. Moser, L.P. Sheets and T.J. Sobotka (2008), 'Identification and Interpretation of Developmental Neurotoxicity Effects: a Report from the ILSI Research Foundation/Risk Science Institute Expert Working Group on Neurodevelopmental Endpoints', *Neurotoxicology and Teratology*, 30: 349-381.
- (32) OECD (1996), *Combined Repeated Dose Toxicity Study with the Reproduction/Developmental Toxicity Screening Test*, OECD Guideline for Testing of Chemicals, No 422, OECD, Paris.
- (33) Chapter B.43 of this Annex, Neurotoxicity Study in Rodents
- (34) OECD (2000), *Guidance Document on the recognition, assessment, and use of clinical signs as humane endpoints for experimental animals used in safety evaluations*, Series on Testing and Assessment, No 19, ENV/JM/MONO(2000)7, OECD, Paris.
- (35) Chapter B.53 of this Annex, Developmental Neurotoxicity Study
- (36) Chapter B.54 of this Annex, Uterotrophic Bioassay in Rodents: A short-term Screening Test for Oestrogenic Properties
- (37) Chapter B.55 of this Annex, Hershberger Bioassay in Rats: A Short-term Screening Assay for (Anti)Androgenic Properties

▼ M5

- (38) OECD (2009), Guidance Document for Histologic Evaluation of Endocrine and Reproductive Test in Rodents, Series on Testing and Assessment, No 106, OECD, Paris.
- (39) OECD (2011), Guidance Document on the Current Implementation of Internal Triggers in the Extended One Generation Reproductive Toxicity Study in the United States and Canada, Series on Testing and Assessment, No 117, ENV/JM/MONO(2011)21, OECD, Paris.
- (40) OECD (2013), Guidance Document supporting TG 443: Extended One Generation Reproductive Toxicity Study, Series on Testing and Assessment, No 151, OECD, Paris.

▼ **M5***Appendix 1***Measures and observations included in the functional observational battery (Cohort 2A)**

Home Cage & Open Field	Manipulative	Physiologic
Posture	Ease of removal	Temperature
Involuntary Clonic & Tonic	Ease of handling	Body weight
Palpebral Closure	Muscle Tone	Pupil response
Piloerection	Approach Response	Pupil size
Salivation	Touch Response	
Lacrimation	Auditory Response	
Vocalisations	Tail Pinch Response	
Rearing	Righting Response	
Gait Abnormalities	Landing Foot Splay	
Arousal	Forelimb Grip Strength	
Stereotypy	Hindlimb Grip Strength	
Bizarre Behaviour		
Stains		
Respiratory Abnormalities		

▼ M5

Appendix 2

DEFINITIONS:

Chemical: A substance or a mixture.

Test Chemical: Any substance or mixture tested using this test method.

▼ **M5****B.57 H295R STEROIDOGENESIS ASSAY**

INTRODUCTION

1. This test method is equivalent to OECD Test Guideline (TG) 456 (2011). The OECD initiated a high-priority activity in 1998 to revise existing, and to develop new, test guidelines for the screening and testing of potential endocrine disrupting chemicals. The 2002 OECD Conceptual Framework for Testing and Assessment of Endocrine Disrupting Chemicals comprises five levels, each level corresponding to a different level of biological complexity (1). The *in vitro* H295R Steroidogenesis Assay (H295R) described in this test method utilises a human adeno-carcinoma cell line (NCI-H295R cells) and constitutes a level 2 '*in vitro* assay, providing mechanistic data', to be used for screening and prioritisation purposes. Development and standardisation of the assay as a screen for chemical effects on steroidogenesis, specifically the production of 17 β -oestradiol (E2) and testosterone (T), was carried out in a multi-step process. The H295R assay has been optimised and validated (2) (3) (4) (5).
2. The objective of the H295R Steroidogenesis Assay is to detect chemicals that affect production of E2 and T. The H295R assay is intended to identify xenobiotics that have as their target site(s) the endogenous components that comprise the intracellular biochemical pathway beginning with the sequence of reactions from cholesterol to the production of E2 and/or T. The H295R assay is not intended to identify chemicals that affect steroidogenesis due to effects on the hypothalamic-pituitary-gonadal (HPG) axis. The goal of the assay is to provide a YES/NO answer with regard to the potential of a chemical to induce or inhibit the production of T and E2; however, quantitative results may be obtained in some cases (see paragraphs 53 and 54). The results of the assay are expressed as relative changes in hormone production compared with the solvent controls (SCs). The assay does not aim to provide specific mechanistic information concerning the interaction of the test chemical with the endocrine system. Research has been conducted using the cell line to identify effects on specific enzymes and intermediate hormones such as progesterone (2).
3. Definitions and abbreviations used in this test method are described in the Appendix. A detailed protocol including instructions on how to prepare solutions, cultivate cells and perform various aspects of the test is available as Appendix I-III to the OECD document 'Multi-Laboratory Validation of the H295R Steroidogenesis Assay to Identify Modulators of Testosterone and Estradiol Production' (4).

INITIAL CONSIDERATIONS AND LIMITATIONS

4. Five different enzymes catalysing six different reactions are involved in sex steroid hormone biosynthesis. Enzymatic conversion of cholesterol to pregnenolone by the cytochrome P450 (CYP) cholesterol side-chain cleavage enzyme (CYP11A) constitutes the initial step in a series of biochemical reactions that culminate in synthesis of steroid end-products. Depending upon the order of the next two reactions, the steroidogenic pathway splits into two paths, the Δ^5 -hydroxysteroid pathway and Δ^4 -ketosteroid pathway, which converge in the production of androstenedione (Figure 1).
5. Androstenedione is converted to testosterone (T) by 17 β -hydroxysteroid dehydrogenase (17 β -HSD). Testosterone is both an intermediate and end-hormone product. In the male, T can be converted to dihydrotestosterone (DHT) by 5 α -reductase, which is found in the cellular membranes, nuclear envelope, and endoplasmic reticulum of target tissues of androgenic action such as prostate and seminal vesicles. DHT is significantly more potent as an androgen than T and is also considered an end-product hormone. The H295R assay does not measure DHT (see paragraph 10).

▼ M5

6. The enzyme in the steroidogenic pathway which converts androgenic chemicals into oestrogenic chemicals is aromatase (CYP19). CYP19 converts T into 17 β -oestradiol (E2) and androstenedione into oestrone. E2 and T are considered end-product hormones of the steroidogenic pathway.
7. The specificity of the lyase activity of CYP17 differs for the intermediate substrates among species. In the human, the enzyme favours substrates of the Δ^5 -hydroxysteroid pathway (pregnenolone), whereas substrates in the Δ^4 -ketosteroid pathway (progesterone) are favoured in the rat (19). Such differences in the CYP17 lyase activity may explain some species-dependent differences in response to chemicals that alter steroidogenesis *in vivo* (6). The H295 cells have been shown to most closely reflect human adult adrenal enzyme expression and steroid production pattern (20), but are known to express enzymes for both the Δ^5 -hydroxysteroid and Δ^4 -ketosteroid pathways for androgen synthesis (7) (11) (13) (15).

Figure 1

Steroidogenic pathway in H295R cells.

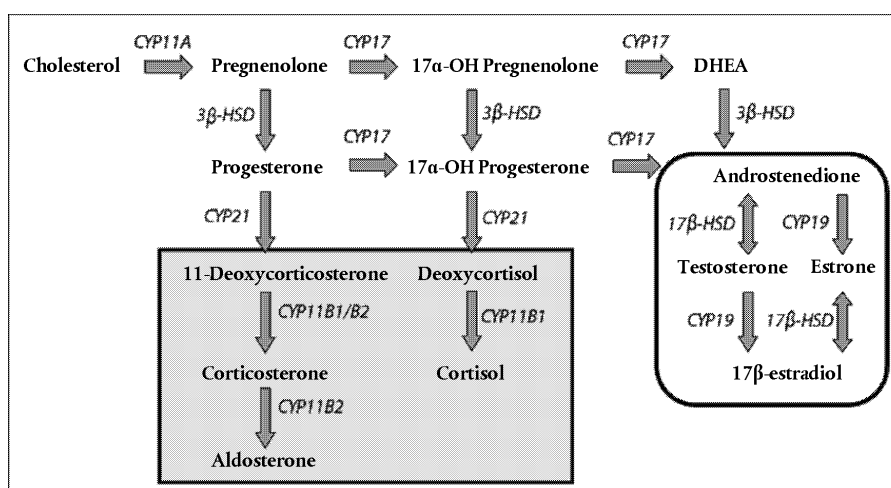

Note:

Enzymes are in italics, hormones are bolded and arrows indicate the direction of synthesis. Gray background indicates corticosteroid pathways/products. Sex steroid pathways/products are circled. CYP = cytochrome P450; HSD = hydroxysteroid dehydrogenase; DHEA = dehydroepiandrosterone.

8. The human H295R adreno-carcinoma cell line is a useful *in vitro* model for the investigation of effects on steroid hormone synthesis (2) (7) (8) (9) (10). The H295R cell line expresses genes that encode for all the key enzymes for steroidogenesis noted above (11) (15) (Figure 1). This is a unique property because *in vivo* expression of these genes is tissue and developmental stage-specific with typically no one tissue or one developmental stage expressing all of the genes involved in steroidogenesis (2). H295R cells have physiological characteristics of zonally undifferentiated human foetal adrenal cells (11). The cells represent a unique *in vitro* system in that they have the ability to produce all of the steroid hormones found in the adult adrenal cortex and the gonads, allowing testing for effects on both corticosteroid synthesis and the production of sex steroid hormones such as androgens and oestrogens, although the assay was validated only to detect T and E2. Changes recorded by the test system in the form of alteration in the

▼ M5

production of T and E2 can be the result of a multitude of different interactions of test chemicals with steroidogenic functions that are expressed by the H295R cells. These include modulation of the expression, synthesis or function of enzymes involved in the production, transformation, or elimination of steroid hormones (12) (13) (14). Inhibition of hormone production can be due to direct competitive binding to an enzyme in the pathway, impact on co-factors such as NADPH (Nicotinamide Adenine Dinucleotide Phosphate) and cAMP (cyclic Adenosine Monophosphate), and/or increase in steroid metabolism or suppression of gene expression of certain enzymes in the steroidogenesis pathway. While inhibition can be a function of both direct or indirect processes involved with hormone production, induction is typically of an indirect nature, such as by affecting co-factors such as NADPH and cAMP (as in the case of forskolin), decreasing steroid metabolism (13), and or up-regulating steroidogenic gene expression.

9. The H295R assay has several advantages:
 - It allows for the detection of both increases and decreases in the production of both T and E2;
 - It permits the direct assessment of the potential impact of a chemical on cell viability/cytotoxicity. This is an important feature as it allows for the discrimination between effects that are due to cytotoxicity from those due to the direct interaction of chemicals with steroidogenic pathways, which is not possible in tissue explants systems that consist of multiple cell types of varying sensitivities and functionalities;
 - It does not require the use of animals;
 - The H295R cell line is commercially available.

10. The principle limitations of the assay are as follows:
 - Its metabolic capability is unknown but probably quite limited; therefore, chemicals that need to be metabolically activated will probably be missed in this assay.
 - Being derived from adrenal tissue, the H295R possesses the enzymes capable of producing the gluco-, and mineral-corticoids as well as the sex hormones; therefore, effects on the production of gluco-, and mineral corticoids could influence the levels of T and E2 observed in the assay.
 - It does not measure DHT and, therefore, would not be expected to detect chemicals that inhibit 5 α -reductase in which case the Hershberger assay (16) can be used.
 - The H295R assay will not detect chemicals that interfere with steroidogenesis by affecting the hypothalamic-pituitary-gonadal axis (HPG) axis as this can only be studied in intact animals.

PRINCIPLE OF THE TEST

11. The purpose of the assay is the detection of chemicals that affect T and E2 production. T is also an intermediate in the pathway to produce E2. The assay can detect chemicals that typically inhibit or induce the enzymes of the steroidogenesis pathway.

▼ M5

12. The assay is usually performed under standard cell culture conditions in 24-well culture plates. Alternatively, other plate sizes can be used for conducting the assay; however, seeding and experimental conditions should be adjusted accordingly to maintain adherence to the performance criteria.

13. After an acclimation period of 24 h in multi-well plates, cells are exposed for 48 h to seven concentrations of the test chemical in at least triplicate. Solvent and a known inhibitor and inducer of hormone production are run at a fixed concentration as negative and positive controls. At the end of the exposure period, the medium is removed from each well. Cell viability in each well is analysed immediately after removal of medium. Concentrations of hormones in the medium can be measured using a variety of methods including commercially available hormone measurement kits and/or instrumental techniques such as liquid chromatography-mass spectrometry (LC-MS). Data are expressed as fold change relative to the solvent control and the Lowest-Observed-Effect-Concentration (LOEC). If the assay is negative, the highest concentration tested is reported as the No-Observed-Effect-Concentration (NOEC). Conclusions regarding the ability of a chemical to affect steroidogenesis should be based on at least two independent test runs. The first test run may function as a range finding run with subsequent adjustment of concentrations for runs 2 and 3, if applicable, if solubility or cytotoxicity problems are encountered or the activity of the chemical seems to be at the end of the range of concentrations tested.

CULTURE PROCEDURE**Cell Line**

14. The NCI-H295R cells are commercially available from the American Type Culture Collections (ATCC) upon signing a Material Transfer Agreement (MTA) ⁽¹⁾.

Introduction

15. Due to changes in the E2 producing capacity of the cells with increasing age/passages (2), cells should be cultured following a specific protocol before they are used and the number of passages since the cells were defrosted as well as the passage number at which the cells were frozen and placed in liquid nitrogen storage should be noted. The first number indicates the actual cell passage number and the second number describes the passage number at which the cells were frozen and placed in storage. For example, cells that were frozen after passage five and defrosted and then were split three times (4 passages counting the freshly thawed cells as passage 1) after they were cultured again would be labelled passage 4.5. An example of a numbering scheme is illustrated in Appendix I to the validation report (4).

16. Stock medium is used as the base for the supplemented and freezing mediums. Supplemented medium is a necessary component for culturing cells. Freezing medium is specifically designed to allow for impact-free freezing of cells for long-term storage. Prior to use, Nu-serum (or a comparable serum of equal properties that has been demonstrated to produce data that meets the test performance and Quality Control (QC) requirements), which is a constituent of supplemented media, should be analysed for background T and E2 concentrations. The preparation of these solutions is described in Appendix II to the validation report (4).

⁽¹⁾ ATCC CRL-2128; ATCC, Manassas, VA, USA, [<http://www.lgcstandards-atcc.org/>].

▼ M5

17. After initiation of an H295R cell culture from an original ATCC batch, cells should be grown for five passages (i.e. the cells are split 4 times). Passage five cells are then frozen in liquid nitrogen for storage. Prior to freezing the cells, a sample of the previous passage four cells is run in a QC plate (See paragraph 36 and 37) to verify whether the basal production of hormones and the response to positive control chemicals meet the assay quality control criteria as defined in Table 5.

18. H295R cells need to be cultured, frozen and stored in liquid nitrogen to make sure that there are always cells of the appropriate passage/age available for culture and use. The maximum number of passages after taking a new ⁽¹⁾ or frozen ⁽²⁾ batch of cells into culture that is acceptable for use in the H295R assay should not exceed 10. For example, acceptable passages for cultures of cells from a batch frozen at passage 5 would be 4.5 through 10.5. For cells started from these frozen batches, the procedure described in paragraph 19 should be followed. These cells should be cultured for at least four (4) additional passages (passage 4.5) prior to their use in testing.

Starting Cells from the Frozen Stock

19. The procedure for starting the cells from frozen stock is to be used when a new batch of cells is removed from liquid nitrogen storage for the purpose of culture and testing. Details for this procedure are set forth in Appendix III to the validation report (4). Cells are removed from liquid nitrogen storage, thawed rapidly, placed in supplemented medium in a centrifuge tube, centrifuged at room temperature, re-suspended in supplemented medium, and transferred to a culture flask. The medium should be changed the following day. The H295R cells are cultivated in an incubator at 37 °C with 5 % CO₂ in air atmosphere and the medium is renewed 2-3 times per week. When the cells are approximately 85-90 % confluent, they should be split. Splitting of the cells is necessary to ensure the health and growth of the cells and to maintain cells for performing bioassays. The cells are rinsed three times with phosphate-buffered saline (PBS, without Ca²⁺ Mg²⁺) and freed from the culture flask by the addition of an appropriate detachment enzyme, e.g. trypsin, in PBS (without Ca²⁺ Mg²⁺). Immediately after the cells detach from the culture flask, the enzyme action should be stopped with the addition of supplemented medium at a ratio of 3× the volume used for the enzyme treatment. Cells are placed into a centrifuge tube, centrifuged at room temperature, the supernatant is removed and the pellet of cells is re-suspended in supplemented medium. The appropriate amount of cell solution is placed in the new culture flask. The amount of cell solution should be adjusted so that the cells are confluent within 5-7 days. The recommended sub-cultivation ratio is 1:3 to 1:4. The plate should be carefully labelled. The cells are now ready to be used in the assay and excess cells should be frozen in liquid nitrogen as described in paragraph 20.

⁽¹⁾ 'New batch' refers to a fresh batch of cells received from ATCC.

⁽²⁾ 'Frozen batch' refers to cells that have been previously cultured and then frozen at a laboratory other than ATCC.

▼ M5**Freezing H295R Cells (preparing cells for liquid nitrogen storage)**

20. To prepare H295R cells for freezing, the procedure described above for splitting cells should be followed until the step for re-suspending the pellet of cells in the bottom of the centrifuge tube. Here, the pellet of cells is re-suspended in freezing medium. The solution is transferred to a cryogenic vial, labelled appropriately, and frozen at $-80\text{ }^{\circ}\text{C}$ for 24 hours after which the cryogenic vial is transferred to liquid nitrogen for storage. Details for this procedure are set forth in Appendix III to the validation report (4).

Plating and Pre-incubation of Cells for Testing

21. The number of 24-well plates, prepared as outlined in paragraph 19, that will be needed depends on the number of chemicals to be tested and the confluency of the cells in the culture dishes. As a general rule, one culture flask (75 cm^2) of 80-90 % confluent cells will supply sufficient cells for one to 1,5 (24-well) plates at a target density of 200 000 to 300 000 cells per ml of medium resulting in approximately 50-60 % confluency in the wells at 24 hours (Figure 2). This is typically the optimal cell density for hormone production in the assay. At higher densities, T as well as E2 production patterns are altered. Before conducting the assay the first time, it is recommended that different seeding densities between 200 000 and 300 000 cells per ml be tested, and the density resulting in 50-60 % confluency in the well at 24 hours be selected for further experiments.

Figure 2

Photomicrograph of H295R cells at a seeding density of 50 % in a 24 well culture plate at 24 hours taken at the edge (A) and centre (B) of a well

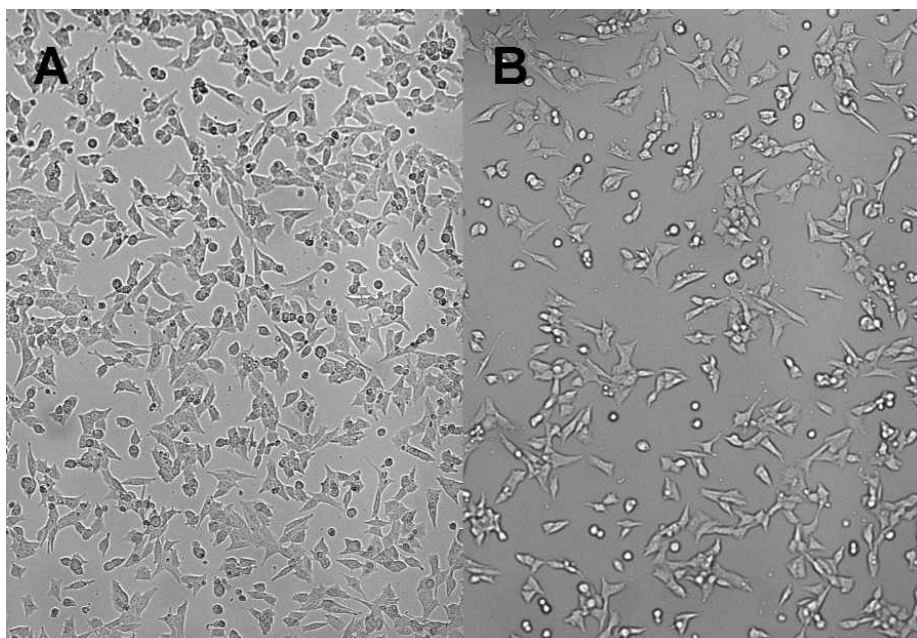

22. The medium is pipetted off the culture flask, and the cells are rinsed 3 times with sterile PBS (without Ca^{2+} Mg^{2+}). An enzyme solution (in PBS) is added to detach the cells from the culture flask. Following an appropriate time for detachment of the cells, the enzyme action should be stopped with the addition of supplemented medium at a ratio of $3 \times$ the volume used for the enzyme treatment. Cells are placed into a centrifuge tube, centrifuged at

▼ M5

room temperature, the supernatant is removed, and the pellet of cells is re-suspended in supplemented medium. The cell density is calculated using e.g. a haemocytometer or cell counter. The cell solution should be diluted to the desired plating density and thoroughly mixed to assure homogenous cell density. The cells should be plated with 1 ml of the cell solution/well and the plates and wells labelled. The seeded plates are incubated at 37 °C under 5 % CO₂ in air atmosphere for 24 hours to allow the cells to attach to the wells.

QUALITY CONTROL REQUIREMENTS

23. It is critical that exact volumes of solutions and samples are delivered into the wells during dosing because these volumes determine the concentrations used in the calculations of assay results.
24. Prior to the initiation of cell culture and any subsequent testing, each laboratory should demonstrate the sensitivity of its hormone measurement system (paragraphs 29-31).
25. If antibody-based hormone measurement assays are to be used, the chemicals to be tested should be analysed for their potential to interfere with the measurement system used to quantify T and E2 as outlined in paragraph 32 prior to initiating testing.
26. DMSO is the recommended solvent for the assay. If an alternative solvent is utilised, the following should be determined:
 - The solubility of the test chemical, forskolin and prochloraz in the solvent; and
 - The cytotoxicity as a function of the concentration of solvent.

It is recommended that the maximum allowable solvent concentration should not exceed a 10 × dilution of the least cytotoxic concentration of the solvent.

27. Prior to conducting testing for the first time, the laboratory should conduct a qualifying experiment demonstrating that the laboratory is capable of maintaining and achieving appropriate cell culture and experimental conditions required for chemical testing as described in paragraphs 33-35.
28. When initiating testing using a new batch, a control plate should be run before using a new batch of cells to evaluate the performance of the cells as described in paragraphs 36 and 37.

Performance of the Hormone Measurement System

Method sensitivity, accuracy, precision and cross-reactivity with sample matrix

29. Each laboratory may use a hormone measurement system of its choice for the analysis of the production of T and E2 by H295R cells so long as it meets performance criteria, including the Limit of Quantification (LOQ). Nominally these are 100 pg/ml for T and 10 pg/ml for E2, which are based on the basal hormone levels observed in the validation studies. However, greater or lower levels may be appropriate depending upon the basal hormone levels achieved in the performing laboratory. Prior to initiation of QC plate and test runs, the laboratory should demonstrate that the

▼ M5

hormone assay to be used can measure hormone concentrations in supplemented medium with sufficient accuracy and precision to meet the QC criteria specified in Tables 1 and 5 by analysing supplemented medium spiked with an internal hormone control. Supplemented medium should be spiked with at least three concentrations of each hormone (e.g. 100, 500 and 2 500 pg/ml of T; 10, 50 and 250 pg/ml of E2; or the lowest possible concentrations based upon the detection limits of the chosen hormone measurement system can be used for the lowest spike concentrations for T and E2) and analysed. Measured hormone concentrations of non-extracted samples should be within 30 % of nominal concentrations, and variation between replicate measurements of the same sample should not exceed 25 % (see also Table 8 for additional QC criteria). If these QC criteria are fulfilled it is assumed that the selected hormone measurement assay is sufficiently accurate, precise and does not cross-react with components in the medium (sample matrix) such that a significant influence on the outcome of the assay would be expected. In this case, no extraction of samples prior to measurement of hormones is required.

30. In the case that the QC criteria in Tables 1 and 8 are not fulfilled, a significant matrix effect may be occurring, and an experiment with extracted spiked medium should be conducted. An example of an extraction procedure is described in Appendix II to the validation report (4). Measurements of the hormone concentrations in the extracted samples should be made in triplicate.⁽¹⁾ If it can be shown that after extraction the components of the medium do not interfere with the hormone detection method as defined by the QC criteria, all further experiments should be conducted using extracted samples. If the QC criteria cannot be met after extraction, the utilised hormone measurement system is not suitable for the purpose of the H295R Steroidogenesis Assay, and an alternative hormone detection method should be used.

Standard curve

31. The hormone concentrations of the solvent controls (SC) should be within the linear portion of the standard curve. Preferably, the SC values should fall close to the centre of the linear portion to ensure that induction and inhibition of hormone synthesis can be measured. Dilutions of medium (or extracts) to be measured are to be selected accordingly. The linear relationship is to be determined by a suitable statistical approach.

Chemical interference test

32. If antibody-based assays such as Enzyme-Linked Immunosorbent Assays (ELISAs) and Radio-Immuno Assays (RIAs) are going to be used to measure hormones, each chemical should be tested for potential interference with the hormone measurement system to be utilised prior to initiation of the actual testing of chemicals (Appendix III to the validation report (4)) because some chemicals can interfere with these tests (17). If interference occurs that is ≥ 20 % of basal hormone production for T and/or E2 as determined by hormone analysis, the Chemical Hormone Assay Interference Test (such as described in Appendix III to the validation report (4) section 5.0) should be run on all test chemical stock solution dilutions to identify the threshold dose at which significant (≥ 20 %) interference occurs. If

⁽¹⁾ *Note:* If extraction is required, three replicate measurements are made for each extract. Each sample will be extracted only once.

▼ **M5**

interference is less than 30 %, results may be corrected for the interference. If interference exceeds 30 %, the data are invalid and the data at these concentrations should be discarded. If significant interference of a test chemical with a hormone measurement system occurs at more than one non-cytotoxic concentration, a different hormone measurement system should be used. In order to avoid interference from contaminating chemicals it is recommended that hormones are extracted from the medium using suitable solvent, possible methods can be found in the validation report (4).

Table 1

Performance criteria for hormone measurement systems

Parameter	Criterion
Measurement Method Sensitivity	Limit of Quantification (LOQ) T: 100 pg/ml; E2: 10 pg/ml ^(a)
Hormone Extraction Efficiency (only when extraction is needed)	The average recovery rates (based on triplicate measures) for the spiked amounts of hormone should not deviate more than 30 % from amount that was added.
Chemical Interference (only antibody based systems)	No substantial (≥ 30 % of basal hormone production of the respective hormone) cross-reactivity with any of the hormones produced by the cells should occur ^(b) ^(c)

^(a) *Note:* Method measurement limits are based on the basal hormone production values provided in Table 5, and are performance based. If greater basal hormone production can be achieved the limit can be greater.

^(b) Some T and E2 antibodies may cross-react with androstenedione and oestrone, respectively, at a greater percentage. In such cases it is not possible to accurately determine effects on 17 β -HSD. However, the data can still provide useful information regarding the effects on oestrogen or androgen production in general. In such cases data should be expressed as androgen/oestrogen responses rather than E2 and T.

^(c) These include: cholesterol, pregnenolone, progesterone, 11-deoxycorticosterone, corticosterone, aldosterone, 17 α -pregnenolone, 17 α -progesterone, deoxycortisol, cortisol, DHEA, androstenedione, oestrone.

Laboratory Proficiency Test

33. Before testing unknown chemicals, a laboratory should demonstrate that it is capable of achieving and maintaining appropriate cell culture and test conditions required for the successful conduct of the assay by running the laboratory proficiency test. As the performance of an assay is directly linked to the laboratory personnel conducting the assay, these procedures should be partly repeated if a change in laboratory personnel occurs.

34. This proficiency test will be conducted under the same conditions listed in paragraphs 38 through 40 by exposing cells to 7 increasing concentrations of strong, moderate and weak inducers and inhibitors as well as a negative chemical (see Table 2). Specifically, chemicals to be tested include the strong inducer forskolin (CAS No 66575-29-9); the strong inhibitor prochloraz (CAS No 67747-09-5); the moderate inducer atrazine

▼ **M5**

(CAS No 1912-24-9); the moderate inhibitor aminoglutethimide (CAS No 125-84-8); the weak inducer (E2 production) and weak inhibitor (T production) bisphenol A (CAS No 80-05-7); and the negative chemical human chorionic gonadotropin (HCG) (CAS No 9002-61-3) as shown in Table 2. Separate plates are run for all chemicals using the format as shown in Table 6. One QC plate (Table 4, paragraphs 36-37) should be included with each daily run for the proficiency chemicals.

Table 2

Proficiency chemicals and exposure concentrations

Proficiency chemical	Test Concentrations [μM]
Prochloraz	0 ^(a) , 0,01, 0,03, 0,1, 0,3, 1, 3, 10
Forskolin	0 ^(a) , 0,03, 0,1, 0,3, 1, 3, 10, 30
Atrazine	0 ^(a) , 0,03, 0,1, 1, 3, 10, 30, 100
Aminoglutethimide	0 ^(a) , 0,03, 0,1, 1, 3, 10, 30, 100
Bisphenol A	0 ^(a) , 0,03, 0,1, 1, 3, 10, 30, 100
HCG	0 ^(a) , 0,03, 0,1, 1, 3, 10, 30, 100

^(a) Solvent (DMSO) control (0), 1 μl DMSO/well.

Exposure of H295R to proficiency chemicals should be conducted in 24 well plates during the laboratory proficiency test. Dosing is in μM for all test chemical doses. Doses should be administered in DMSO at 0,1 % v/v per well. All test concentrations should be tested in triplicate wells (Table 6). Separate plates are run for each chemical. One QC plate is included with each daily run.

35. Cell viability and hormone analyses should be conducted as provided in paragraphs 42 through 46. The threshold value (lowest observed effect concentration, LOEC) and classification decision should be reported and compared with the values in Table 3. The data are considered acceptable if they meet the LOEC and decision classification in Table 3.

Table 3

Threshold values (LOECs) and decision classifications for Proficiency Chemicals

	CAS No	LOEC [μM]		Decision Classification	
		T	E2	T	E2
Prochloraz	67747-09-5	$\leq 0,1$	$\leq 1,0$	+ ^(a) (Inhibition)	+ (Inhibition)
Forskolin	66575-29-9	≤ 10	$\leq 0,1$	+ (Induction)	+ (Induction)
Atrazine	1912-24-9	≤ 100	≤ 10	+ (Induction)	+ (Induction)
Aminoglutethimide	125-84-8	≤ 100	≤ 100	+ (Inhibition)	+ (Inhibition)

▼ M5

	CAS No	LOEC [μ M]		Decision Classification	
		T	E2	T	E2
Bisphenol A	80-05-7	≤ 10	≤ 10	+ (Inhibition)	+ (Induction)
HCG	9002-61-3	n/a	n/a	Negative	Negative

^(a) +, positive

n/a: not applicable as no changes should occur after exposure to non-cytotoxic concentrations of negative control.

Quality Control Plate

36. The quality control (QC) plate is used to verify the performance of the H295R cells under standard culture conditions, and to establish a historical database for hormone concentrations in solvent controls, positive and negative controls, as well as other QC measures over time.

— H295R cell performance should be assessed using a QC plate for each new ATCC batch or after using a previously frozen stock of cells for the first time unless the laboratory proficiency test (paragraphs 32-34) has been run with that batch of cells.

— A QC plate provides a complete assessment of the assay conditions (e.g. cell viability, solvent controls, negative and positive controls, as well as intra- and inter-assay variability) when testing chemicals and should be part of each test run.

37. The QC test is conducted in a 24-well plate and follows the same incubation, dosing, cell viability/cytotoxicity, hormone extraction and hormone analysis procedures described in paragraphs 38 through 46 for testing chemicals. The QC plate contains blanks, solvent controls, and two concentrations of a known inducer (forskolin, 1, 10 μ M) and inhibitor (prochloraz, 0,1, 1 μ M) of E2 and T synthesis. In addition, MeOH is used in select wells as a positive control for the viability/cytotoxicity assay. A detailed description of the plate layout is provided in Table 4. The criteria to be met on the QC plate are listed in Table 5. The minimum basal hormone production for T and E2 should be met in both the solvent control and blank wells.

Table 4

Quality control plate layout for testing performance of unexposed H295R cells and cells exposed to known inhibitors (PRO = prochloraz) and stimulators (FOR = forskolin) of E2 and T production. After termination of the exposure experiment and removal of medium, a 70 % methanol solution will be added to all MeOH wells to serve as a positive control for cytotoxicity (see cytotoxicity assay in Appendix III to the validation report (4))

	1	2	3	4	5	6
A	Blank ^(a)	Blank ^(a)	Blank ^(a)	Blank ^(a) (+ MeOH) ^(b)	Blank ^(a) (+ MeOH) ^(b)	Blank ^(a) (+ MeOH) ^(b)
B	DMSO ^(c) 1 μ l	DMSO ^(c) 1 μ l	DMSO ^(c) 1 μ l	DMSO ^(c) 1 μ l (+ MeOH) ^(b)	DMSO ^(c) 1 μ l (+ MeOH) ^(b)	DMSO ^(c) 1 μ l (+ MeOH) ^(b)

▼ M5

	1	2	3	4	5	6
C	FOR 1 μM	FOR 1 μM	FOR 1 μM	PRO 0,1 μM	PRO 0,1 μM	PRO 0,1 μM
D	FOR 10 μM	FOR 10 μM	FOR 10 μM	PRO 1 μM	PRO 1 μM	PRO 1 μM

(^a) Cells in Blank wells receive medium only (i.e. no solvent).

(^b) Methanol (MeOH) will be added **after** the exposure is terminated and the medium is removed from these wells.

(^c) DMSO solvent control (1 μl/well).

Table 5

Performance criteria for the Quality Control Plate

	T	E2
Basal Production of hormone in the solvent control (SC)	≥ 5 times the LOQ	≥ 2,5 times the LOQ
Induction (10 μM forskolin)	≥ 1,5 times the SC	≥ 7,5 times the SC
Inhibition (1μM prochloraz)	≤ 0,5 times the SC	≤ 0,5 times the SC

CHEMICAL EXPOSURE PROCEDURE

38. The pre-incubated cells are removed from the incubator (paragraph 21) and checked under a microscope to assure that they are in good condition (attachment, morphology) prior to dosing.
39. The cells are placed in a bio-safety cabinet and the supplemented medium removed and replaced with new supplemented medium (1 ml/well). DMSO is the preferred solvent for this test method. However, if there are reasons for using other solvents the scientific rationale should be described. Cells are exposed to the test chemical by adding 1 μl of the appropriate stock solution in DMSO (see Appendix II to the validation report (4)) per 1 ml supplemented medium (well volume). This results in a final concentration of 0,1 % DMSO in the wells. To assure adequate mixing it is generally preferred that the appropriate stock solution of the test chemical in DMSO is mixed with supplemented medium to yield the desired final concentration for each dose, and the mixture added to each well immediately after removal of old medium. If this option is used, the concentration of DMSO (0,1 %) should remain consistent among all wells. The wells containing the greatest two concentrations are visually assessed for formation of precipitates or cloudiness as an indication of incomplete solubility of the test chemical by using a stereo microscope. If such conditions (cloudiness, formation precipitates) are observed, wells containing the next lesser concentrations are examined as well (and so forth) and concentrations that did not completely go into solution are to be excluded from further evaluation and analysis. The plate is returned to the incubator at 37 °C under a 5 % CO₂ in air atmosphere for 48 hours. The test chemical plate layout is shown in Table 6. Stocks 1 -7 show placement of increasing doses of test chemical.

▼ **M5**

Table 6

Dosing schematic for the exposure of H295R cells to test chemicals in a 24 well plate

	1	2	3	4	5	6
A	DMSO	DMSO	DMSO	Stock 4	Stock 4	Stock 4
B	Stock 1	Stock 1	Stock 1	Stock 5	Stock 5	Stock 5
C	Stock 2	Stock 2	Stock 2	Stock 6	Stock 6	Stock 6
D	Stock 3	Stock 3	Stock 3	Stock 7	Stock 7	Stock 7

40. After 48 hours the exposure plates are removed from the incubator and every well is checked under the microscope for cell condition (attachment, morphology, degree of confluence) and signs of cytotoxicity. The medium from each well is split into two equal amounts (approximately 490 µl each) and transferred to two separate vials appropriately labelled (i.e. one aliquot to provide a spare sample for each well). To prevent cells from drying out, medium is removed a row or column at a time and replaced with the medium for the cell viability/cytotoxicity assay. If cell viability/cytotoxicity is not to be measured immediately, 200 µl PBS with Ca²⁺ and Mg²⁺ is added to each well. The media are frozen at – 80 °C until further processing to analyse hormone concentrations (see paragraphs 44-46). While T and E2 in medium kept at – 80 °C are generally stable for at least 3 months, hormone stability during storage should be documented within each laboratory.
41. Immediately after removing the medium, cell viability/cytotoxicity is determined for each exposure plate.

Cell Viability Determination

42. A cell viability/cytotoxicity assay of choice can be used to determine the potential impact of the test chemical on cell viability. The assay should be able to provide a true measure of the percentage of viable cells present in a well, or it should be demonstrated that it is directly comparable to (a linear function of) the Live/Dead® Assay (see Appendix III to the validation report (4)). An alternative assay that has been shown to work equally well is the MTT [3-(4,5-dimethylthiazol-2-yl)-2,5-diphenyl tetrazolium bromide] test (18). The assessment of cell viability using the above methods is a relative measurement that does not necessarily exhibit linear relationships with the absolute number of cells in a well. Therefore, a subjective parallel visual assessment of each well by the analyst should be conducted, and digital pictures of the SCs and the two greatest non-cytotoxic concentrations are to be taken and archived to enable later assessment of true cell density if this should be required. If by visual inspection or as demonstrated by the viability/cytotoxicity assay there appears to be an increase in cell number, the apparent increase needs to be verified. If an increase in cell numbers is verified, this should be stated in the test report. Cell viability will be expressed relative to the average response in the SCs, which is considered 100 % viable cells, and is calculated as appropriate for the cell viability/cytotoxicity assay that is used. For the MTT assay, the following formula may be used:

▼ M5

% viable cells = (response in well – average response in MeOH treated [= 100 % dead] wells) ÷ (average response in SC wells – average response in MeOH treated [= 100 % dead] wells)

43. Wells with viability lower than 80 %, relative to the average viability in the SCs (= 100 % viability), should not be included in the final data analysis. Inhibition of steroidogenesis occurring in the presence of almost 20 % cytotoxicity should be carefully evaluated to ensure that cytotoxicity is not the cause for the inhibition.

Hormone Analysis

44. Each laboratory can use a hormone measurement system of its choice for the analysis of T and E2. Spare aliquots of medium from each treatment group may be used to prepare dilutions to bring the concentration within the linear part of the standard curve. As noted in paragraph 29, each laboratory should demonstrate the conformance of their hormone measurement system (e.g. ELISA, RIA, LC-MS, LC-MS/MS) with the QC criteria by analysing supplemented medium spiked with an internal hormone control prior to conducting QC runs or testing of chemicals. In order to ensure that the components of the test system do not interfere with measurement of hormones, the hormones may need to be extracted from the media prior to their measurement (see paragraph 30 for the conditions under which an extraction is or is not required). It is recommended to conduct extraction following the procedures in Appendix III to the validation report (4).
45. If a commercial test kit is being used to measure the hormone production, the hormone analysis should be conducted as specified in the manuals provided by the test kit manufacturer. Most manufacturers have a unique procedure by which the hormone analyses are conducted. Dilutions of samples need to be adjusted such that expected hormone concentrations for the solvent controls fall within the centre of the linear range of the standard curve of the individual assay (Appendix III to the validation report (4)). Values outside of the linear portion of the standard curve should be rejected.
46. Final hormone concentrations are calculated as follows:

Example:

Extracted:	450 µl medium
Reconstituted in:	250 µl assay buffer
Dilution in Assay:	1:10 (to bring the sample within the linear range of the standard curve)
Hormone Concentration in Assay:	150 pg/ml (already adjusted to concentration per ml sample assayed)
Recovery:	89 %
Final hormone concentration =	(Hormone concentration (per ml) ÷ recovery) (dilution factor)
Final hormone concentration =	(150 pg/ml) ÷ (0,89) × (250 µl/450 µl) × 10 = 936,3 pg/ml

▼ **M5****Selection of test concentrations**

47. A minimum of two independent runs of the assay should be conducted. Unless prior information such as information on solubility limits or cytotoxicity provides a basis for selecting test concentrations, it is recommended that the test concentrations for the initial run be spaced at \log_{10} intervals with 10^{-3} M being the maximum concentration. If the chemical is soluble, and not cytotoxic at any of the tested concentrations, and the first run was negative for all concentrations, then it is to be confirmed in one more run using the same conditions as the first run was conducted (Table 7). If the results of the first run are *equivocal* (i.e. the fold-change is statistically significant from the SC at only one concentration) or positive (i.e. the fold change at two or more adjacent concentrations is statistically significant), the test should be repeated as indicated in Table 7 by refining the selected test concentrations. Test concentrations in runs two and three (if applicable) should be adjusted on the basis of the results of the initial run bracketing concentrations that elicited an effect using 1/2-log concentration spacing (e.g. if the original run of 0,001, 0,01, 0,1, 1, 10, 100, 1 000 μ M resulted in inductions at 1 and 10 μ M, the concentrations tested in the second run should be 0,1, 0,3, 1, 3, 10, 30, 100 μ M), unless lower concentrations need to be employed to achieve a LOEC. In the latter case, at least five concentrations below the lowest concentration tested in the first run should be used in the second run using a 1/2-log scale. If the second run does not confirm the first run (i.e. statistical significance does not occur at the previously positively tested Live/Deadconcentration \pm 1 concentration-increment), a third experiment is to be conducted using the original testing conditions. Equivocal results in the first run are considered negative if the observed effect could not be confirmed in any of the two subsequent runs. Equivocal results are considered as positive responses (effect) when the response can be confirmed in at least one more run within a \pm 1 concentration increment (see section 55 for the Data Interpretation Procedure).

Table 7

Decision matrix for possible outcome scenarios

Run 1	Run 2		Run 3		Decision	
Scenario	Decision	Scenario	Decision	Scenario	Positive	Negative
Negative	Confirm ^(a)	Negative	Stop			X
Negative	Confirm ^(a)	Positive	Refine ^(b)	Negative		X
Equivocal ^(c)	Refine ^(b)	Negative	Confirm ^(a)	Negative		X
Equivocal ^(c)	Refine ^(b)	Negative	Confirm ^(a)	Positive	X	
Equivocal ^(c)	Refine ^(b)	Positive			X	
Positive	Refine ^(b)	Negative	Confirm ^(a)	Positive	X	

▼ M5

Run 1	Run 2		Run 3		Decision	
Scenario	Decision	Scenario	Decision	Scenario	Positive	Negative
Negative	Confirm ^(a)	Positive	Refine ^(b)	Positive	X	
Positive	Refine ^(b)	Positive	Stop		X	

^(a) Confirm previous run using the same experimental design.

^(b) Re-run assay at 1/2-log concentration spacing (bracketing the concentration that tested significantly different in the preceding experiment).

^(c) Fold-change at one concentration is statistically significantly different from the SC

Quality Control of the Test Plate

48. In addition to meeting the criteria for the QC plate, other quality criteria that pertain to acceptable variation between replicate wells, replicate experiments, linearity and sensitivity of hormone measurement systems, variability between replicate hormone measures of the same sample, and percentage recovery of hormone spikes after extraction of medium (if applicable; see Paragraph 30 regarding extraction requirements) should be met and are provided in Table 8. Data should fall within the acceptable ranges defined for each parameter to be considered for further evaluation. If these criteria are not met, the spreadsheet should note that QC criteria were not met for the sample in question, and the sample should be re-analysed or dropped from the data set.

Table 8

Acceptable ranges and/or variation (%) for H295R assay test plate parameters.

(LOQ: Limit of Quantification of the hormone measurement system. CV: Coefficient of variation; SC: Solvent Control; DPM: Disintegrations per minute)

	Comparison Between	T	E2
Basal hormone production in SCs	Fold-greater than LOQ	≥ 5-fold	≥ 2,5-fold
Exposure Experiments — Within Plate CV for SCs (Replicate Wells)	Absolute Concentrations	≤ 30 %	≤ 30 %
Exposure Experiments — Between Plate CV for SCs (Replicate Experiments)	Fold-Change	≤ 30 %	≤ 30 %
Hormone Measurement System — Sensitivity	Detectable fold-decrease relative to SC	≥ 5-fold	≥ 2,5-fold
Hormone Measurement System — Replicate Measure CV for SCs ^(a)	Absolute Concentrations	≤ 25 %	≤ 25 %
Medium Extraction — Recovery of Internal 3H Standard (If Applicable)	DPM	≥ 65 % Nominal	

^(a) Refers to replicate measures of the same sample

▼ M5

DATA ANALYSIS AND REPORTING

Data Analysis

49. To evaluate the relative increase/decrease in chemically altered hormone production, the results should be normalised to the mean SC value of each test plate, and results expressed as changes relative to the SC in each test plate. All data are to be expressed as mean \pm 1 standard deviation (SD).
50. Only hormone data from wells where cytotoxicity was less than 20 % should be included in the data analysis. Relative changes should be calculated as follows:

Relative Change = (Hormone concentration in each well) \div (Mean hormone concentration in all solvent control well).

51. If by visual inspection of the well or as demonstrated by the viability/cytotoxicity assay described in paragraph 42 there appears to be an increase in cell number, the apparent increase needs to be verified. If an increase in cell numbers is verified, this should be stated in the test report.
52. Prior to conducting statistical analyses, the assumptions of normality and variance homogeneity should be evaluated. Normality should be evaluated using standard probability plots or other appropriate statistical method (e.g. Shapiro-Wilk's test). If the data (fold changes) are not normally distributed, transformation of the data should be attempted to approximate a normal distribution. If the data are normally distributed or approximate a normal distribution, differences between chemical concentration groups and SCs should be analysed using a parametric test (e.g. Dunnett's Test) with *concentration* being the independent, and *response* (fold-change) being the dependent variable. If data are not normally distributed, an appropriate non-parametric test should be used (e.g. Kruskal Wallis, Steel's Many-one rank test). Differences are considered significant at $p \leq 0.05$. Statistical evaluations are done based on average values for each well that represent independent replicate data points. It is anticipated that due to the large spacing of doses in the first run (\log_{10} scale) in many cases it will not be possible to describe clear concentration-response relationships where the two greatest doses will be on the linear portion of the sigmoid curve. Therefore, for the first run or any other data sets where this condition occurs (e.g. where no maximum efficacy can be estimated) type I fixed variable statistics as described above will be applied.
53. If more than two data points lie on the linear portion of the curve and where maximum efficacies can be calculated — as is anticipated for some of the 2nd runs that are conducted using a semi-log spacing of exposure concentrations — a probit, logit or other appropriate regression model should be utilised to calculate effective concentrations (e.g. EC50 and EC20).
54. Results should be provided both in graphical (bar graphs representing mean \pm 1 SD) and tabular (LOEC/NOEC, direction of effect, and strength of maximum response that is part of the dose-response portion of the data) formats (see Figure 3 for an example). Data assessment is only considered valid if it has been based on at least two independently conducted runs. An experiment or run is considered independent if it has been conducted at a different date using a new set of solutions and controls. The concentration range used in runs 2 and 3 (if necessary) may be tailored on the basis of the results of run 1 to better define the dose response range containing the LOEC (see paragraph 47).

▼ M5

Figure 3

Example of the presentation and evaluation of data obtained during the conduct of the H295R Assay in graphical and tabular format.

Asterisks indicate statistically significant differences from the solvent control ($p < 0,05$). LOEC: Lowest observed effective concentration; Max Change: Maximum strength of the response observed at any concentration relative to the average SC response (= 1).

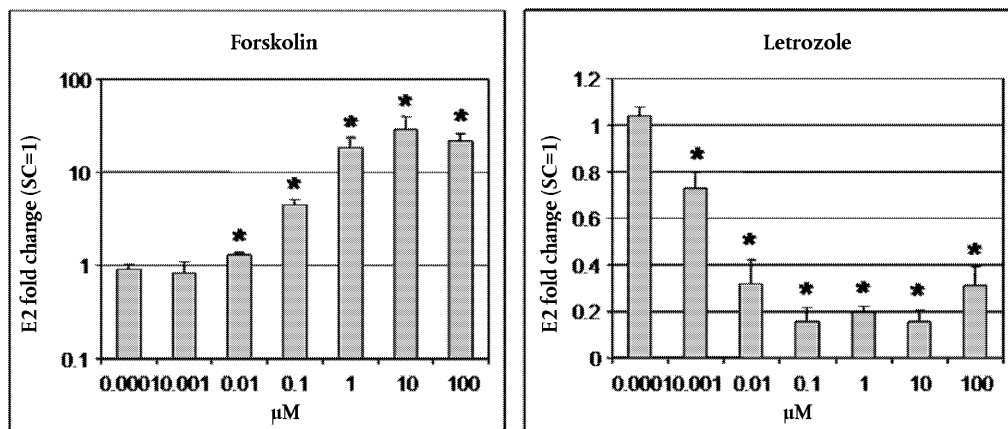

Chemical	LOEC	Max Change
Forskolin	0,01	0,15 fold
Letrozole	0,001	29 fold

Data Interpretation Procedure

55. A test chemical is judged to be positive if the fold induction is statistically different ($p \leq 0,05$) from the solvent control at two adjacent concentrations in at least two independent runs (Table 7). A test chemical is judged to be negative following two independent negative runs, or in three runs, comprising two negative runs and one equivocal or positive run. If the data generated in three independent experiments does not meet the decision criteria listed in Table 7, the experimental results are not interpretable. Results at concentrations exceeding the limits of solubility or at cytotoxic concentrations should not be included in the interpretation of results.

Test Report

56. The test report should include the following information:

Testing facility

- Name of facility and location;
- Study director and other personnel and their study responsibilities;
- Dates the study began and ended;

▼ M5*Test chemical, reagents and controls*

- Identity (name/CAS No as appropriate), source, lot/batch number, purity, supplier, and characterisation of test chemical, reagents, and controls;
- Physical nature and relevant physicochemical properties of test chemical;
- Storage conditions and the method and frequency of preparation of test chemicals, reagents and controls;
- Stability of test chemical;

Cells

- Source and type of cells;
- Number of cell passages (cell passage identifier) of cells used in test;
- Description of procedures for maintenance of cell cultures;

Pre-test requirements (if applicable)

- Description and results of chemical hormone-assay interference test;
- Description and results of hormone extraction efficiency measurements;
- Standard and calibration curves for all analytical assays to be conducted;
- Detection limits for the selected analytical assays;

Test conditions

- Composition of media;
- Concentration of test chemical;
- Cell density (estimated or measured cell concentrations at 24 hours and 48 hours)
- Solubility of test chemical (limit of solubility, if determined);
- Incubation time and conditions;

Test results

- Raw data for each well for controls and test chemicals—each replicate measure in form of the original data provided by the instrument utilised to measure hormone production (e.g. OD, fluorescence units, DPM, etc.);
- Validation of normality or explanation of data transformation;
- Mean responses ± 1 SD for each well measured;
- Cytotoxicity data (test concentrations that caused cytotoxicity);
- Confirmation that QC requirements were met;

▼ M5

- Relative change compared with solvent control corrected for cytotoxicity;
- A bar graph showing relative (fold change) at each concentration, SD and statistical significance as stated in paragraph 49-54;

Data interpretation

- Apply the data interpretation procedure to the results and discuss findings;

Discussion

- Are there any indications from the study regarding the possibility that the T/E2 data could be influenced by indirect effects on the gluco-, and mineral-corticoid pathways?

*Conclusions***LITERATURE**

- (1) OECD (2002), OECD Conceptual Framework for the Testing and Assessment of Endocrine Disrupting Chemicals, in Appendix 2 to Chapter B.54 of this Annex
- (2) Hecker, M., Newsted, J.L., Murphy, M.B., Higley, E.B., Jones, P.D., Wu, R. and Giesy, J.P. (2006), Human adrenocarcinoma (H295R) cells for rapid in vitro determination of effects on steroidogenesis: Hormone production, *Toxicol. Appl. Pharmacol.*, 217, 114-124.
- (3) Hecker, M., Hollert, H., Cooper, R., Vinggaard, A.-M., Akahori, Y., Murphy, M., Nellemann, C., Higley, E., Newsted, J., Wu, R., Lam, P., Laskey, J., Buckalew, A., Grund, S., Nakai, M., Timm, G., and Giesy, J. P. (2007), The OECD validation program of the H295R steroidogenesis assay for the identification of in vitro inhibitors or inducers of testosterone and estradiol production, Phase 2: inter laboratory pre-validation studies. *Env. Sci. Pollut. Res.*, 14, 23-30.
- (4) OECD (2010), *Multi-Laboratory Validation of the H295R Steroidogenesis Assay to Identify Modulators of Testosterone and Estradiol Production*, OECD Series of Testing and Assessment No 132, ENV/JM/MONO(2010)31, Paris. Available at [http://www.oecd.org/document/30/0,3746,en_2649_34377_1916638_1_1_1_1,00.html]
- (5) OECD (2010), *Peer Review Report of the H295R Cell-Based Assay for Steroidogenesis*, OECD Series of Testing and Assessment No 133, ENV/JM/MONO(2010)32, Paris. Available at: [http://www.oecd.org/document/30/0,3746,en_2649_34377_1916638_1_1_1_1,00.html]
- (6) Battelle (2005), Detailed Review Paper on Steroidogenesis, Available at: [http://www.epa.gov/endo/pubs/edmvs/steroidogenesis_drp_final_3_29_05.pdf]
- (7) Hilscherova, K., Jones, P. D., Gracia, T., Newsted, J. L., Zhang, X., Sanderson, J. T., Yu, R. M. K., Wu, R. S. S. and Giesy, J. P. (2004), Assessment of the Effects of Chemicals on the Expression of Ten Steroidogenic Genes in the H295R Cell Line Using Real-Time PCR, *Toxicol. Sci.*, 81, 78-89.
- (8) Sanderson, J. T., Boerma, J., Lansbergen, G. and Van den Berg, M. (2002), Induction and inhibition of aromatase (CYP19) activity by various classes of pesticides in H295R human adrenocortical carcinoma cells, *Toxicol. Appl. Pharmacol.*, 182, 44-54.
- (9) Breen, M.S., Breen, M., Terasaki, N., Yamazaki, M. and Conolly, R.B. (2010), Computational model of steroidogenesis in human H295R cells to predict biochemical response to endocrine-active chemicals: Model development for metyrapone, *Environ. Health Perspect.*, 118: 265-272.

▼ **M5**

- (10) Higley, E.B., Newsted, J.L., Zhang, X., Giesy, J.P. and Hecker, M. (2010), Assessment of chemical effects on aromatase activity using the H295R cell line, *Environ. Sci. Poll. Res.*, 17:1137-1148.
- (11) Gazdar, A. F., Oie, H. K., Shackleton, C. H., Chen, T. R., Triche, T. J., Myers, C. E., Chrousos, G. P., Brennan, M. F., Stein, C. A. and La Rocca, R. V. (1990), Establishment and characterization of a human adrenocortical carcinoma cell line that expresses Multiple pathways of steroid biosynthesis, *Cancer Res.*, 50, 5488-5496.
- (12) He, Y.H., Wiseman, S.B., Zhang, X.W., Hecker, M., Jones, P.D., El-Din, M.G., Martin, J.W. and Giesy, J.P. (2010), Ozonation attenuates the steroidogenic disruptive effects of sediment free oil sands process water in the H295R cell line, *Chemosphere*, 80:578-584.
- (13) Zhang, X.W., Yu, R.M.K., Jones, P.D., Lam, G.K.W., Newsted, J.L., Gracia, T., Hecker, M., Hilscherova, K., Sanderson, J.T., Wu, R.S.S. and Giesy, J.P. (2005), Quantitative RT-PCR methods for evaluating toxicant-induced effects on steroidogenesis using the H295R cell line, *Environ. Sci. Technol.*, 39:2777-2785.
- (14) Higley, E.B., Newsted, J.L., Zhang, X., Giesy, J.P. and Hecker, M. (2010), Differential assessment of chemical effects on aromatase activity, and E2 and T production using the H295R cell line, *Environ. Sci. Pol. Res.*, 17:1137-1148.
- (15) Rainey, W. E., Bird, I. M., Sawetawan, C., Hanley, N. A., Mccarthy, J. L., Mcgee, E. A., Wester, R. and Mason, J. I. (1993), Regulation of human adrenal carcinoma cell (NCI-H295) production of C19 steroids, *J. Clin. Endocrinol. Metab.*, 77, 731-737.
- (16) Chapter B.55 of this Annex: Hershberger Bioassay in Rats: A short-term Screening Assay for (Anti)Androgenic Properties.
- (17) Shapiro, R., and Page, L.B. (1976), Interference by 2,3-dimercapto-1-propanol (BAL) in angiotensin I radioimmunoassay, *J. Lab. Clin. Med.*, 2, 222-231.
- (18) Mosmann, T. (1983), Rapid colorimetric assay for growth and survival: application to proliferation and cytotoxicity assays, *J. Immunol. Methods.*, 65, 55-63.
- (19) Brock, B.J., Waterman, M.R. (1999). Biochemical differences between rat and human cytochrome P450c17 support the different steroidogenic needs of these two species, *Biochemistry*. 38:1598-1606.
- (20) Oskarsson, A., Ulleras, E., Plant, K., Hinson, J. Goldfarb, P.S., (2006), Steroidogenic gene expression in H295R cells and the human adrenal gland: adrenotoxic effects of lindane in vitro, *J. Appl. Toxicol.*, 26:484-492.

▼ **M5***Appendix*

DEFINITIONS:

Confluency refers to the coverage or proliferation that the cells are allowed over or throughout the culture medium.

Chemical means a substance or a mixture.

CV refers to the coefficient of variation, and is defined as the ratio of the standard deviation of a distribution to its arithmetic mean.

CYP stands for cytochrome P450 mono-oxygenases, a family of genes and the enzymes produced from them that are involved in catalysing a wide variety of biochemical reactions including the synthesis and metabolism of steroid hormones.

DPM are disintegration per minute. It is the number of atoms in a given quantity of radioactive material that is detected to have decayed in one minute.

E2 is 17 β -oestradiol, the most important oestrogen in mammalian systems.

H295R cells are human adreno-carcinoma cells which have the physiological characteristics of zonally undifferentiated human foetal adrenal cells and which express all of the enzymes of the steroidogenesis pathway. They are available from the ATCC.

Freeze medium is used to freeze and to store frozen cells. It consists of stock medium plus BD NuSerum and dimethyl sulfoxide.

Linear Range is the range within the standard curve for a hormone measurement system where the results are proportional to the concentration of the analyte present in the sample.

LOQ stands for '*Limit of Quantification*', and is the lowest quantity of a chemical that can be distinguished from the absence of that chemical (a blank value) within a stated confidence limit. For the purpose of this method, the LOQ is typically defined by the manufacturer of the test systems if not specified differently.

LOEC is the Lowest Observed Effect Concentration, the lowest concentration level at which the assay response is statistically different from that of the solvent control.

NOEC is the No Observed Effect Concentration, which is the highest concentration tested if the assay does not provide a positive response.

Passage is the number of times that cells are split after initiation of a culture from frozen stock. The initial passage that was started from the frozen stock is assigned the number one (1). Cells that were split 1 time are labelled passage 2, etc.

PBS is Dulbecco's phosphate buffered saline.

Quality Control, abbreviated QC, refers to the measures needed to assure valid data.

Quality control plate is a 24 well plate containing two concentrations of the positive and negative controls to monitor the performance of a new batch of cells or to provide the positive controls for the assay when testing chemicals.

Run is an independent experiment characterised by a new set of solutions and controls.

▼ M5

Stock medium is the base for the preparation of other reagents. It consists of a 1:1 mixture of Dulbecco's Modified Eagle's Medium and Ham's F-12 Nutrient mixture (DMEM/F12) in 15 mM HEPES buffer without phenol red or sodium bicarbonate. Sodium bicarbonate is added as the buffer, see Appendix II to the validation report (4).

Supplemented medium consist of stock medium plus BD Nu-Serum and ITS+ premium mix, see Appendix II to the validation report (4).

Steroidogenesis is the synthetic pathway leading from cholesterol to the various steroid hormones. Several intermediates in the steroid synthesis pathway such as progesterone and testosterone are important hormones in their own right but also serve as precursors to hormones farther down the synthetic pathway.

T stands for testosterone, one of the two most important androgens in mammalian systems.

Test chemical is any substance or mixture tested using this test method.

Test plate is the plate on which H295R cells are exposed to test chemicals. Test plates contain the solvent control and the test chemical at seven concentration levels in triplicate.

Trypsin 1X is a dilute solution of the enzyme trypsin, a pancreatic serine protease, used to loosen cells from a cell cultivation plate, see Appendix III to the validation report (4).

▼ M5**B.58 TRANSGENIC RODENT SOMATIC AND GERM CELL GENE MUTATION ASSAYS**

INTRODUCTION

1. This test method is equivalent to OECD Test Guideline (TG) 488 (2013). EU test methods are available for a wide range of *in vitro* mutation assays that are able to detect chromosomal and/or gene mutations. There are test methods for *in vivo* endpoints (i.e. chromosomal aberrations and unscheduled DNA synthesis); however, these do not measure gene mutations. Transgenic Rodent (TGR) mutation assays fulfil the need for practical and widely available *in vivo* tests for gene mutations.
2. The TGR mutation assays have been reviewed extensively (24) (33). They use transgenic rats and mice that contain multiple copies of chromosomally integrated plasmid or phage shuttle vectors. The transgenes contain reporter genes for the detection of various types of mutations induced *in vivo* by test chemicals.
3. Mutations arising in a rodent are scored by recovering the transgene and analysing the phenotype of the reporter gene in a bacterial host deficient for the reporter gene. TGR gene mutation assays measure mutations induced in genetically neutral genes recovered from virtually any tissue of the rodent. These assays, therefore, circumvent many of the existing limitations associated with the study of *in vivo* gene mutation in endogenous genes (e.g. limited tissues suitable for analysis, negative/positive selection against mutations).
4. The weight of evidence suggests that transgenes respond to mutagens in a similar manner to endogenous genes, especially with regard to the detection of base pair substitutions, frameshift mutations, and small deletions and insertions(24).
5. The International Workshops on Genotoxicity Testing (IWGT) have endorsed the inclusion of TGR gene mutation assays for *in vivo* detection of gene mutations, and have recommended a protocol for their implementation (15) (29). This test method is based on these recommendations. Further analysis supporting the use of this protocol can be found in (16).
6. It is anticipated that in the future it may be possible to combine a TGR gene mutation assay with a repeat dose toxicity study (Chapter B.7 of this Annex). However, data are required to ensure that the sensitivity of TGR gene mutation assays is unaffected by the shorter one day period of time between the end of the administration period and the sampling time, as used in the repeat dose toxicology study, compared to 3 days used in TGR gene mutation assays. Data are also required to indicate that the performance of the repeat dose assay is not adversely affected by using a transgenic rodent strain rather than traditional rodent strains. When these data are available, this test method will be updated.
7. Definitions of key terms are set out in the Appendix.

▼ M5

INITIAL CONSIDERATIONS

8. TGR gene mutation assays for which sufficient data are available to support their use in this test method are: *lacZ* bacteriophage mouse (MutaTMMouse); *lacZ* plasmid mouse; *gpt* delta (*gpt* and *Spi*⁻) mouse and rat; *lacI* mouse and rat (Big Blue®), as performed under standard conditions. In addition, the *cII* positiveselection assay can be used for evaluating mutations in the Big Blue® and MutaTMMouse models. Mutagenesis in the TGR models is normally assessed as mutant frequency; if required, however, molecular analysis of the mutations can provide additional information (see paragraph 24).

9. These rodent *in vivo* gene mutation tests are especially relevant to assessing mutagenic hazard in that the assays' responses are dependent upon *in vivo* metabolism, pharmacokinetics, DNA repair processes, and translesion DNA synthesis, although these may vary among species, among tissues and among the types of DNA damage. An *in vivo* assay for gene mutations is useful for further investigation of a mutagenic effect detected by an *in vitro* system, and for following up results of tests using other *in vivo* endpoints (24). In addition to being causally associated with the induction of cancer, gene mutation is a relevant endpoint for the prediction of mutation-based non-cancer diseases in somatic tissues (12) (13) as well as diseases transmitted through the germline.

10. If there is evidence that the test chemical, or a relevant metabolite, will not reach any of the tissues of interest, it is not appropriate to perform a TGR gene mutation assay.

PRINCIPLE OF THE TEST

11. In the assays described in paragraph 8, the target gene is bacterial or bacteriophage in origin, and the means of recovery from the rodent genomic DNA is by incorporation of the transgene into a λ bacteriophage or plasmid shuttle vector. The procedure involves the extraction of genomic DNA from the rodent tissue of interest, *in vitro* processing of the genomic DNA (i.e. packaging of λ vectors, or ligation and electroporation of plasmids to recover the shuttle vector), and subsequent detection of mutations in bacterial hosts under suitable conditions. The assays employ neutral transgenes that are readily recoverable from most tissues.

12. The basic TGR gene mutation experiment involves treatment of the rodent with a chemical over a period of time. Chemicals may be administered by any appropriate route, including implantation (e.g. medical device testing). The total period during which an animal is dosed is referred to as the administration period. Administration is usually followed by a period of time, prior to sacrifice, during which the chemical is not administered and during which unrepaired DNA lesions are fixed into stable mutations. In the literature, this period has been variously referred to as the manifestation time, fixation time or expression time; the end of this period is the sampling time (15) (29). After the animal is sacrificed, genomic DNA is isolated from the tissue(s) of interest and purified.

▼ **M5**

13. Data for a single tissue per animal from multiple packaging/ligations are usually aggregated, and mutant frequency is generally evaluated using a total of between 10^5 and 10^7 plaque-forming or colony-forming units. When using positive selection methods, total plaque-forming units are determined with a separate set of non-selective plates.
14. Positive selection methods have been developed to facilitate the detection of mutations in both the *gpt* gene [*gpt* delta mouse and rat, *gpt*⁻ phenotype (20) (22) (28)] and the *lacZ* gene [Muta™Mouse or *lacZ* plasmid mouse (3) (10) (11) (30)]; whereas, *lacI* gene mutations in Big Blue® animals are detected through a non-selective method that identifies mutants through the generation of coloured (blue) plaques. Positive selection methodology is also in place to detect point mutations arising in the *cII* gene of the λ bacteriophage shuttle vector [Big Blue® mouse or rat, and Muta™Mouse (17)] and deletion mutations in the λ *red* and *gam* genes [Spi⁻ selection in *gpt* delta mouse and rat (21) (22) (28)]. Mutant frequency is calculated by dividing the number of plaques/plasmids containing mutations in the transgene by the total number of plaques/plasmids recovered from the same DNA sample. In TGR gene mutation studies, the mutant frequency is the reported parameter. In addition, a mutation frequency can be determined as the fraction of cells carrying independent mutations; this calculation requires correction for clonal expansion by sequencing the recovered mutants (24).
15. The mutations scored in the *lacI*, *lacZ*, *cII* and *gpt* point mutation assays consist primarily of base pair substitution mutations, frameshift mutations and small insertions/deletions. The relative proportion of these mutation types among spontaneous mutations is similar to that seen in the endogenous *Hprt* gene. Large deletions are detected only with the Spi⁻ selection and the *lacZ* plasmid assays (24). Mutations of interest are *in vivo* mutations that arise in the mouse or rat. *In vitro* and *ex vivo* mutations, which may arise during phage/plasmid recovery, replication or repair, are relatively rare, and in some systems can be specifically identified, or excluded by the bacterial host/positive selection system.

DESCRIPTION OF THE METHOD

Preparations*Selection of animal species*

16. A variety of transgenic mouse gene mutation detection models are currently available, and these systems have been more widely used than transgenic rat models. If the rat is clearly a more appropriate model than the mouse (e.g. when investigating the mechanism of carcinogenesis for a tumour seen only in rats, to correlate with a rat toxicity study, or if rat metabolism is known to be more representative of human metabolism) the use of transgenic rat models should be considered.

Housing and feeding conditions

17. The temperature in the experimental animal room ideally should be 22 °C (± 3 °C). Although the relative humidity should be at least 30 % and preferably not exceed 70 % other than during room cleaning, the goal should be to maintain a relative humidity of 50-60 %. Lighting should be artificial, with a daily sequence of 12 hours light, followed by 12 hours dark. For feeding, conventional laboratory diets may be used with an

▼ M5

unlimited supply of drinking water. The choice of diet may be influenced by the need to ensure a suitable admixture of a test chemical when administered by this route. Animals should be housed in small groups (no more than five) of the same sex if no aggressive behaviour is expected. Animals may be housed individually if scientifically justified.

Preparation of the animals

18. Healthy young sexually mature adult animals (8-12 weeks old at start of treatment) are randomly assigned to the control and treatment groups. The animals are identified uniquely. The animals are acclimated to the laboratory conditions for at least five days. Cages should be arranged in such a way that possible effects due to cage placement are minimised. At the commencement of the study, the weight variation of animals should be minimal and not exceed $\pm 20\%$ of the mean weight of each sex.

Preparation of doses

19. Solid test chemicals should be dissolved or suspended in appropriate solvents or vehicles or admixed in diet or drinking water prior to dosing of the animals. Liquid test chemicals may be dosed directly or diluted prior to dosing. For inhalation exposures, test chemicals can be administered as gas, vapour or a solid/liquid aerosol, depending on their physicochemical properties. Fresh preparations of the test chemical should be employed unless stability data demonstrate the acceptability of storage.

Test Conditions*Solvent/vehicle*

20. The solvent/vehicle should not produce toxic effects at the dose volumes used, and should not be suspected of chemical reaction with the test chemical. If other than well-known solvents/vehicles are used, their inclusion should be supported with reference data indicating their compatibility. It is recommended that wherever possible, the use of an aqueous solvent/vehicle should be considered first.

Positive Controls

21. Concurrent positive control animals should normally be used. However, for laboratories that have demonstrated competency (see paragraph 23) and routinely use these assays, DNA from previous positive control treated animals may be included with each study to confirm the success of the method. Such DNA from previous experiments should be obtained from the same species and tissues of interest, and properly stored (see paragraph 36). When concurrent positive controls are used, it is not necessary to administer them by the same route as the test chemical; however, the positive controls should be known to induce mutations in one or more tissues of interest for the test chemical. The doses of the positive control chemicals should be selected so as to produce weak or moderate effects that critically assess the performance and sensitivity of the assay. Examples of positive control chemicals and some of their target tissues are included in Table 1.

▼ **M5**

Table 1

Examples of positive control chemicals and some of their target tissues

Positive control chemical and CAS No	EINECS name and EINECS No	Characteristics	Mutation Target Tissue	
			Rat	Mouse
N-Ethyl-N-nitrosourea [CAS No 759-73-9]	N-Ethyl-N-nitrosourea [212-072-2]	Direct acting mutagen	Liver, lung	Bone marrow, colon, colonic epithelium, intestine, liver, lung, spleen, kidney, ovarian granulosa cells, male germ cells
Ethyl carbamate (urethane) [CAS No 51-79-6]	Urethane [200-123-1]	Mutagen, requires metabolism but produces only weak effects		Bone marrow, forestomach, small intestine, liver, lung, spleen
2,4-Diaminotoluene [CAS No 95-80-7]	4-Methyl-m-phenylenediamine [202-453-1]	Mutagen, requires metabolism, also positive in the Spi ⁻ assay	Liver	Liver
Benzo[a]pyrene [CAS No 50-32-8]	Benzo[def]chrysene [200-028-5]	Mutagen, requires metabolism	Liver, omenta,	Bone marrow, breast, colon, forestomach, glandular stomach, heart, liver, lung, male germ cells

Negative controls

22. Negative controls, treated with solvent or vehicle alone, and otherwise treated in the same way as the treatment groups, should be included for every sampling time. In the absence of historical or published control data showing that no deleterious or mutagenic effects are induced by the chosen solvent/vehicle, untreated controls should also be included for every sampling time in order to establish acceptability of the vehicle control.

Verification of laboratory proficiency

23. Competency in these assays should be established by demonstrating the ability to reproduce expected results from published data (24) for: 1) mutant frequencies with positive control chemicals (including weak responses) such as those listed in Table 1, non-mutagens, and vehicle controls; and 2) transgene recovery from genomic DNA (e.g. packaging efficiency).

Sequencing of mutants

24. For regulatory applications, DNA sequencing of mutants is not required, particularly where a clear positive or negative result is obtained. However, sequencing data may be useful when high inter-individual variation is observed. In these cases, sequencing can be used to rule out the possibility of jackpots or clonal events by identifying the proportion of unique mutants from a particular tissue. Sequencing approximately 10 mutants per tissue per animal should be sufficient for simply determining if clonal mutants contribute to the mutant frequency; sequencing as many as 25 mutants may

▼ M5

be necessary to correct mutant frequency mathematically for clonality. Sequencing of mutants also may be considered when small increases in mutant frequency (i.e. just exceeding the untreated control values) are found. Differences in the mutant spectrum between the mutant colonies from treated and untreated animals may lend support to a mutagenic effect (29). Also, mutation spectra may be useful for developing mechanistic hypotheses. When sequencing is to be included as part of the study protocol, special care should be taken in the design of such studies, in particular with respect to the number of mutants sequenced per sample, to achieve adequate power according to the statistical model used (see paragraph 43).

PROCEDURE**Number and Sex of Animals**

25. The number of animals per group should be predetermined to be sufficient to provide statistical power necessary to detect at least a doubling in mutant frequency. Group sizes will consist of a minimum of five animals; however, if the statistical power is insufficient, the number of animals should be increased as required. Male animals should normally be used. There may be cases where testing females alone would be justified; for example, when testing human female-specific drugs, or when investigating female-specific metabolism. If there are significant differences between the sexes in terms of toxicity or metabolism, then both males and females will be required.

Administration Period

26. Based on observations that mutations accumulate with each treatment, a repeated-dose regimen is necessary, with daily treatments for a period of 28 days. This is generally considered acceptable both for producing a sufficient accumulation of mutations by weak mutagens, and for providing an exposure time adequate for detecting mutations in slowly proliferating organs. Alternative treatment regimens may be appropriate for some evaluations, and these alternative dosing schedules should be scientifically justified in the protocol. Treatments should not be shorter than the time required for the complete induction of all the relevant metabolising enzymes, and shorter treatments may necessitate the use of multiple sampling times that are suitable for organs with different proliferation rates. In any case, all available information (e.g. on general toxicity or metabolism and pharmacokinetics) should be used when justifying a protocol, especially when deviating from the above standard recommendations. While it may increase sensitivity, treatment times longer than 8 weeks should be explained clearly and justified, since long treatment times may produce an apparent increase in mutant frequency through clonal expansion (29).

Dose Levels

27. Dose levels should be based on the results of a dose range-finding study measuring general toxicity that was conducted by the same route of exposure, or on the results of pre-existing sub-acute toxicity studies. Non-transgenic animals of the same rodent strain may be used for determining dose ranges. In the main test, in order to obtain dose response information, a complete study should include a negative control group (see paragraph 22) and a minimum of three, appropriately-spaced dose

▼ M5

levels, except where the limit dose has been used (see paragraph 28). The top dose should be the Maximum Tolerated Dose (MTD). The MTD is defined as the dose producing signs of toxicity such that higher dose levels, based on the same dosing regimen, would be expected to produce lethality. Chemicals with specific biological activities at low non-toxic doses (such as hormones and mitogens), and chemicals which exhibit saturation of toxicokinetic properties may be exceptions to the dose-setting criteria and should be evaluated on a case-by-case basis. The dose levels used should cover a range from the maximum to little or no toxicity.

Limit Test

28. If dose range-finding experiments, or existing data from related rodent strains, indicate that a treatment regime of at least the limit dose (see below) produces no observable toxic effects, and if genotoxicity would not be expected based upon data from structurally related chemicals, then a full study using three dose levels may not be considered necessary. For an administration period of 28 days (i.e. 28 daily treatments), the limit dose is 1 000 mg/kg body weight/day. For administration periods of 14 days or less, the limit dose is 2 000 mg/kg/body weight/day (dosing schedules differing from 28 daily treatments should be scientifically justified in the protocol; see paragraph 26).

Administration of Doses

29. The test chemical is usually administered by gavage using a stomach tube or a suitable intubation cannula. In general, the anticipated route of human exposure should be considered when designing an assay. Therefore, other routes of exposure (such as drinking water, subcutaneous, intravenous, topical, inhalation, intratracheal, dietary, or implantation) may be acceptable where they can be justified. Intraperitoneal injection is not recommended since it is not a physiologically relevant route of human exposure. The maximum volume of liquid that can be administered by gavage or injection at one time depends on the size of the test animal. The volume should not exceed 2 ml/100 g body weight. The use of volumes greater than this should be justified. Except for irritating or corrosive chemicals, which will normally reveal exacerbated effects at higher concentrations, variability in test volume should be minimised by adjusting the concentration to ensure a constant volume at all dose levels.

Sampling Time*Somatic Cells*

30. The sampling time is a critical variable because it is determined by the period needed for mutations to be fixed. This period is tissue-specific and appears to be related to the turnover time of the cell population, with bone marrow and intestine being rapid responders and the liver being much slower. A suitable compromise for the measurement of mutant frequencies in both rapidly and slowly proliferating tissues is 28 consecutive daily treatments (as indicated in paragraph 26) and sampling three days after the final treatment; although the maximum mutant frequency may not manifest itself in slowly proliferating tissues under these conditions. If slowly proliferating tissues are of particular importance, then a later sampling time of 28 days following the 28 day administration period may be more appropriate (16) (29). In such cases, the later sampling time would replace the 3 day sampling time, and would require scientific justification.

▼ M5*Germ Cells*

31. TGR assays are well-suited for the study of gene mutation induction in male germ cells (7) (8) (27), in which the timing and kinetics of spermatogenesis have been well-defined (27). The low numbers of ova available for analysis, even after super-ovulation, and the fact that there is no DNA synthesis in the oocyte, preclude the determination of mutation in female germ cells using transgenic assays (31).

32. The sampling times for male germ cells should be selected so that the range of exposed cell types throughout germ cell development is sampled, and so that the stage targeted in the sampling has received sufficient exposure. The time for the progression of developing germ cells from spermatogonial stem cells to mature sperm reaching the vas deferens/cauda epididymis ~ 49 days for the mouse (36) and ~70 days for the rat (34) (35). Following a 28-day exposure with a subsequent three day sampling period, accumulated sperm collected from the vas deferens/cauda epididymis (7)(8) will represent a population of cells exposed during approximately the latter half of spermatogenesis, which includes the meiotic and postmeiotic period, but not the spermatogonial or stem cell period. In order to adequately sample cells in the vas deferens/cauda epididymis that were spermatogonial stem cells during the exposure period, an additional sampling time at a minimum of 7 weeks (mice) or 10 weeks (rat), after the end of treatment is required.

33. Cells extruded from seminiferous tubules after a 28 + 3 day regimen comprise a mixed population enriched for all stages of developing germ cells (7) (8). Sampling these cells for gene mutation detection does not provide as precise an assessment of the stages at which germ cell mutations are induced as can be obtained from sampling spermatozoa from the vas deferens/cauda epididymis (since there is a range of germ cell types sampled from the tubules, and there will be some somatic cells contaminating this cell population). However, sampling cells from seminiferous tubules in addition to spermatozoa from the vas deferens/cauda epididymis following only a 28 + 3 day sampling regimen would provide some coverage of cells exposed across the majority of phases of germ cell development, and may be useful for detecting some germ cell mutagens.

Observations

34. General clinical observations should be made at least once a day, preferably at the same time(s) each day and considering the peak period of anticipated effects after dosing. The health condition of the animals should be recorded. At least twice daily, all animals should be observed for morbidity and mortality. All animals should be weighed at least once a week, and at sacrifice. Measurements of food consumption should be made at least weekly. If the test chemical is administered via the drinking water, water consumption should be measured at each change of water and at least weekly. Animals exhibiting non-lethal indicators of excess toxicity should be euthanatised prior to completion of the test period (23).

▼ M5**Tissue Collection**

35. The rationale for tissue collection should be defined clearly. Since it is possible to study mutation induction in virtually any tissue, the selection of tissues to be collected should be based upon the reason for conducting the study and any existing mutagenicity, carcinogenicity or toxicity data for the chemical under investigation. Important factors for consideration should include the route of administration (based on likely human exposure route(s)), the predicted tissue distribution, and the possible mechanism of action. In the absence of any background information, several somatic tissues as may be of interest should be collected. These should represent rapidly proliferating, slowly proliferating and site of contact tissues. In addition, spermatozoa from the vas deferens/cauda epididymis and developing germ cells from the seminiferous tubules (as described in paragraphs 32 and 33) should be collected and stored in case future analysis of germ cell mutagenicity is required. Organ weights should be obtained, and for larger organs, the same area should be collected from all animals.

Storage of Tissues and DNA

36. Tissues (or tissue homogenates) should be stored at or below $-70\text{ }^{\circ}\text{C}$ and be used for DNA isolation within 5 years. Isolated DNA, stored refrigerated at $4\text{ }^{\circ}\text{C}$ in appropriate buffer, should be used optimally for mutation analysis within 1 year.

Selection of Tissues for Mutant Analysis

37. The choice of tissues should be based on considerations such as: 1) the route of administration or site of first contact (e.g. glandular stomach if administration is oral, lung if administration is through inhalation, or skin if topical application has been used); and 2) pharmacokinetic parameters observed in general toxicity studies, which indicate tissue disposition, retention or accumulation, or target organs for toxicity. If studies are conducted to follow up carcinogenicity studies, target tissues for carcinogenicity should be considered. The choice of tissues for analysis should maximise the detection of chemicals that are direct-acting *in vitro* mutagens, rapidly metabolised, highly reactive or poorly absorbed, or those for which the target tissue is determined by route of administration (6).
38. In the absence of background information and taking into consideration the site of contact due to route of administration, the liver and at least one rapidly dividing tissue (e.g. glandular stomach, bone marrow) should be evaluated for mutagenicity. In most cases, the above requirements can be achieved from analyses of two carefully selected tissues, but in some cases, three or more would be needed. If there are reasons to be specifically concerned about germ cell effects, including positive responses in somatic cells, germ cell tissues should be evaluated for mutations.

Methods of Measurement

39. Standard laboratory or published methods for the detection of mutants are available for the recommended transgenic models: *lacZ* lambda bacteriophage and plasmid (30); *lacI* mouse (2) (18); *gpt* delta mouse (22); *gpt* delta rat (28); *cII* (17). Modifications should be justified and properly documented. Data from multiple packagings can be aggregated and used to reach an adequate number of plaques or colonies. However, the need for a large number of packaging reactions to reach the appropriate number of plaques may be an indication of poor DNA quality. In such cases, data should be considered cautiously because they may be unreliable. The optimal total number of plaques or colonies per DNA sample is governed

▼ M5

by the statistical probability of detecting sufficient numbers of mutants at a given spontaneous mutant frequency. In general, a minimum of 125 000 to 300 000 plaques is required if the spontaneous mutant frequency is in the order of 3×10^{-5} (15). For the Big Blue® *lacI* assay, it is important to demonstrate that the whole range of mutant colour phenotypes can be detected by inclusion of appropriate colour controls concurrent with each plating. Tissues and the resulting samples (items) should be processed and analysed using a block design, where items from the vehicle/solvent control group, the positive control group (if used) or positive control DNA (where appropriate), and each treatment group are processed together.

DATA AND REPORTING**Treatment of Results**

40. Individual animal data should be presented in tabular form. The experimental unit is the animal. The report should include the total number of plaque-forming units (pfu) or colony-forming units (cfu), the number of mutants, and the mutant frequency for each tissue from each animal. If there are multiple packaging/rescue reactions, the number of reactions per DNA sample should be reported. While data for each individual reaction should be retained, only the total pfu or cfu need be reported. Data on toxicity and clinical signs as per paragraph 34 should be reported. Any sequencing results should be presented for each mutant analysed, and resulting mutation frequency calculations for each animal and tissue should be shown.

Statistical Evaluation and Interpretation of Results

41. There are several criteria for determining a positive result, such as a dose-related increase in the mutant frequency, or a clear increase in the mutant frequency in a single dose group compared to the solvent/vehicle control group. At least three treated dose groups should be analysed in order to provide sufficient data for dose-response analysis. While biological relevance of the results should be the primary consideration, appropriate statistical methods may be used as an aid in evaluating the test results (4) (14) (15) (25) (26). Statistical tests used should consider the animal as the experimental unit.
42. A test chemical for which the results do not meet the above criteria in any tissue is considered non-mutagenic in this assay. For biological relevance of a negative result, tissue exposure should be confirmed.
43. For DNA sequencing analyses, a number of statistical approaches are available to assist in interpreting the results (1) (5) (9) (19).
44. Consideration of whether the observed values are within or outside of the historical control range can provide guidance when evaluating the biological significance of the response (32).

▼ M5**Test report**

45. The test report should include the following information:

Test chemical:

- identification data and CAS n^o, if known;
- source, lot number if available;
- physical nature and purity;
- physiochemical properties relevant to the conduct of the study;
- stability of the test chemical, if known;

Solvent/vehicle:

- justification for choice of vehicle;
- solubility and stability of the test chemical in the solvent/vehicle, if known;
- preparation of dietary, drinking water or inhalation formulations;
- analytical determinations on formulations (e.g. stability, homogeneity, nominal concentrations);

Test animals:

- species/strain used and justification for the choice;
- number, age and sex of animals;
- source, housing conditions, diet, etc.;
- individual weight of the animals at the start of the test, including body weight range, mean and standard deviation for each group;

Test conditions:

- positive and negative (vehicle/solvent) control data;
- data from the range-finding study;
- rationale for dose level selection;
- details of test chemical preparation;
- details of the administration of the test chemical;
- rationale for route of administration;
- methods for measurement of animal toxicity, including, where available, histopathological or haematological analyses and the frequency with which animal observations and body weights were taken;
- methods for verifying that the test chemical reached the target tissue, or general circulation, if negative results are obtained;

▼ M5

- actual dose (mg/kg body weight/day) calculated from diet/drinking water test chemical concentration (ppm) and consumption, if applicable;
- details of food and water quality;
- detailed description of treatment and sampling schedules and justifications for the choices;
- method of euthanasia;
- procedures for isolating and preserving tissues;
- methods for isolation of rodent genomic DNA, rescuing the transgene from genomic DNA, and transferring transgenic DNA to a bacterial host;
- source and lot numbers of all cells, kits and reagents (where applicable);
- methods for enumeration of mutants;
- methods for molecular analysis of mutants and use in correcting for clonality and/or calculating mutation frequencies, if applicable;

Results:

- animal condition prior to and throughout the test period, including signs of toxicity;
- body and organ weights at sacrifice;
- for each tissue/animal, the number of mutants, number of plaques or colonies evaluated, mutant frequency;
- for each tissue/animal group, number of packaging reactions per DNA sample, total number of mutants, mean mutant frequency, standard deviation;
- dose-response relationship, where possible;
- for each tissue/animal, the number of independent mutants and mean mutation frequency, where molecular analysis of mutations was performed;
- concurrent and historical negative control data with ranges, means and standard deviations;
- concurrent positive control (or non-concurrent DNA positive control) data;
- analytical determinations, if available (e.g. DNA concentrations used in packaging, DNA sequencing data);
- statistical analyses and methods applied;

*Discussion of the results**Conclusion*

▼ M5

LITERATURE

- (1) Adams, W.T. and T.R. Skopek (1987), 'Statistical Test for the Comparison of Samples from Mutational Spectra', *J. Mol. Biol.*, 194: 391-396.
- (2) Bielas, J.H. (2002), 'A more Efficient Big Blue® Protocol Improves Transgene Rescue and Accuracy in an Adduct and Mutation Measurement', *Mutation Res.*, 518: 107-112.
- (3) Boerrigter, M.E., M.E. Dollé, H.-J. Martus, J.A. Gossen and J. Vijg (1995), 'Plasmid-based Transgenic Mouse Model for Studying *in vivo* Mutations' *Nature*, 377(6550): 657-659
- (4) Carr, G.J. and N.J. Gorelick (1995), 'Statistical Design and Analysis of Mutation Studies in Transgenic Mice', *Environ. Mol. Mutagen*, 25(3): 246-255.
- (5) Carr, G.J. and N.J. Gorelick (1996), 'Mutational Spectra in Transgenic Animal Research: Data Analysis and Study Design Based upon the Mutant or Mutation Frequency', *Environ. Mol. Mutagen*, 28: 405-413.
- (6) Dean, S.W., T.M. Brooks, B. Burlinson, J. Mirsalis, B. Myhr, L. Recio and V. Thybaud (1999), 'Transgenic Mouse Mutation Assay Systems can Play an important Role in Regulatory Mutagenicity Testing *in vivo* for the Detection of Site-of-contact Mutagens', *Mutagenesis*, 14(1): 141-151.
- (7) Douglas, G.R., J. Jiao, J.D. Gingerich, J.A. Gossen and L.M. Soper(1995), 'Temporal and Molecular Characteristics of Mutations Induced by Ethylnitrosourea in Germ Cells Isolated from Seminiferous Tubules and in Spermatozoa of *lacZ* Transgenic Mice', *Proc. Natl. Acad. Sci. USA*, 92: 7485-7489.
- (8) Douglas, G.R., J.D. Gingerich, L.M. Soper and J. Jiao (1997), 'Toward an Understanding of the Use of Transgenic Mice for the Detection of Gene Mutations in Germ Cells', *Mutation Res.*, 388(2-3): 197-212.
- (9) Dunson, D.B. and K.R. Tindall (2000), 'Bayesian Analysis of Mutational Spectra', *Genetics*, 156: 1411-1418.
- (10) Gossen, J.A., W.J. de Leeuw, C.H. Tan, E.C. Zwarthoff, F. Berends, P.H. Lohman, D.L. Knook and J. Vijg(1989), 'Efficient Rescue of Integrated Shuttle Vectors from Transgenic Mice: a Model for Studying Mutations *in vivo*', *Proc. Natl. Acad. Sci. USA*, 86(20): 7971-7975.
- (11) Gossen, J.A. and J. Vijg (1993), 'A Selective System for *lacZ*-Phage using a Galactose-sensitive *E. coli* Host', *Biotechniques*, 14(3): 326, 330.
- (12) Erikson, R.P. (2003), 'Somatic Gene Mutation and Human Disease other than Cancer', *Mutation Res.*, 543: 125-136.
- (13) Erikson, R.P. (2010), 'Somatic Gene Mutation and Human Disease other than Cancer: an Update', *Mutation Res.*, **705**: 96-106.
- (14) Fung, K.Y., G.R. Douglas and D. Krewski (1998), 'Statistical Analysis of *lacZ* Mutant Frequency Data from Muta™Mouse Mutagenicity Assays', *Mutagenesis*, 13(3): 249-255.
- (15) Heddle, J.A., S. Dean, T. Nohmi, M. Boerrigter, D. Casciano, G.R. Douglas, B.W. Glickman, N.J. Gorelick, J.C. Mirsalis, H.-J. Martus, T.R. Skopek, V. Thybaud, K.R.Tindall and N. Yajima (2000), 'In vivo Transgenic Mutation Assays', *Environ. Mol. Mutagen.*, 35: 253-259.
- (16) Heddle, J.A., H.-J. Martus and G.R. Douglas (2003), 'Treatment and Sampling Protocols for Transgenic Mutation Assays', *Environ. Mol. Mutagen.*, 41: 1-6.

▼ M5

- (17) Jakubczak, J.L., G. Merlino, J.E. French, W.J. Muller, B. Paul, S. Adhya and S. Garges (1996), 'Analysis of Genetic Instability during Mammary Tumor Progression using a novel Selection-based Assay for *in vivo* Mutations in a Bacteriophage λ Transgene Target', *Proc. Natl. Acad. Sci. USA*, 93(17): 9073–9078.
- (18) Kohler, S.W., G.S. Provost, P.L. Kretz, A. Fieck, J.A. Sorge and J.M. Short (1990), 'The Use of Transgenic Mice for Short-term, *in vivo* Mutagenicity Testing', *Genet. Anal. Tech. Appl.*, 7(8): 212–218.
- (19) Lewis P.D., B. Manshian, M.N. Routledge, G.B. Scott and P.A. Burns (2008), 'Comparison of Induced and Cancer-associated Mutational Spectra using Multivariate Data Analysis', *Carcinogenesis*, 29(4): 772-778.
- (20) Nohmi, T., M. Katoh, H. Suzuki, M. Matsui, M. Yamada, M. Watanabe, M. Suzuki, N. Horiya, O. Ueda, T. Shibuya, H. Ikeda and T. Sofuni (1996), 'A new Transgenic Mouse Mutagenesis Test System using Spi⁻ and 6-thioguanine Selections', *Environ. Mol. Mutagen.*, 28(4): 465–470.
- (21) Nohmi, T., M. Suzuki, K. Masumura, M. Yamada, K. Matsui, O. Ueda, H. Suzuki, M. Katoh, H. Ikeda and T. Sofuni (1999), 'Spi⁻ Selection: an Efficient Method to Detect γ -ray-induced Deletions in Transgenic Mice', *Environ. Mol. Mutagen.*, 34(1): 9–15.
- (22) Nohmi, T., T. Suzuki and K.I. Masumura (2000), 'Recent Advances in the Protocols of Transgenic Mouse Mutation Assays', *Mutation Res.*, 455(1–2): 191–215.
- (23) OECD (2000), Guidance Document on the Recognition, Assessment and Use of Clinical Signs as Humane Endpoints for Experimental Animals Used in Safety Evaluation, Series on Testing and Assessment, N° 19, ENV/JM/MONO(2000)7, OECD, Paris.
- (24) OECD (2009), Detailed Review Paper on Transgenic Rodent Mutation Assays, Series on Testing and Assessment, N° 103, ENV/JM/MONO(2009)7, OECD, Paris.
- (25) Piegorsch, W.W., B.H. Margolin, M.D. Shelby, A. Johnson, J.E. French, R.W. Tennant and K.R. Tindall (1995), 'Study Design and Sample Sizes for a lacI Transgenic Mouse Mutation Assay', *Environ. Mol. Mutagen.*, 25(3): 231–245.
- (26) Piegorsch, W.W., A.C. Lockhart, G.J. Carr, B.H. Margolin, T. Brooks, ... G.R. Douglas, U.M. Liegibel, T. Suzuki, V. Thybaud, J.H. van Delft and N.J. Gorelick (1997), 'Sources of Variability in Data from a Positive Selection lacZ Transgenic Mouse Mutation Assay: an Interlaboratory Study', *Mutation. Res.*, 388(2–3): 249–289.
- (27) Singer, T.M., I.B. Lambert, A. Williams, G.R. Douglas and C.L. Yauk (2006), 'Detection of Induced Male Germline Mutation: Correlations and Comparisons between Traditional Germline Mutation Assays, Transgenic Rodent Assays and Expanded Simple Tandem Repeat Instability Assays', *Mutation. Res.*, 598: 164-193.
- (28) Toyoda-Hokaiwado, N., T. Inoue, K. Masumura, H. Hayashi, Y. Kawamura, Y. Kurata, M. Takamune, M. Yamada, H. Sanada, T. Umemura, A. Nishikawa and T. Nohmi (2010), 'Integration of *in vivo* Genotoxicity and Short-term Carcinogenicity Assays using F344 gpt delta Transgenic Rats: *in vivo* Mutagenicity of 2,4-diaminotoluene and 2,6-diaminotoluene Structural Isomers', *Toxicol. Sci.*, 114(1): 71-78.
- (29) Thybaud, V., S. Dean, T. Nohmi, J. de Boer, G.R. Douglas, B.W. Glickman, N.J. Gorelick, J.A. Heddle, R.H. Heflich, I. Lambert, H.-J. Martus, J.C. Mirsalis, T. Suzuki and N. Yajima (2003), '*In vivo* Transgenic Mutation Assays', *Mutation Res.*, 540: 141-151.
- (30) Vijg, J. and G.R. Douglas (1996), 'Bacteriophage λ and Plasmid lacZ Transgenic Mice for studying Mutations *in vivo*' in: G. Pfeifer (ed.), *Technologies for Detection of DNA Damage and Mutations, Part II*, Plenum Press, New York, NY, USA, pp. 391–410.

▼ **M5**

- (31) Yauk, C.L., J.D. Gingerich, L. Soper, A. MacMahon, W.G. Foster and G.R. Douglas (2005), 'A *lacZ* Transgenic Mouse Assay for the Detection of Mutations in Follicular Granulosa Cells', *Mutation Res.*, 578(1-2): 117-123.
- (32) Hayashi, M., K. Dearfield, P. Kasper, D. Lovell, H.-J. Martus, V. Thybaud (2011), 'Compilation and Use of Genetic Toxicity Historical Control Data', *Mutation Res.*, doi:10.1016/j.mrgentox.2010.09.007.
- (33) OECD (2011), *Retrospective Performance Assessment of OECD Test Guideline on Transgenic Rodent Somatic and Germ Cell Gene Mutation Assays*, Series on Testing and Assessment, N° 145, ENV/JM/MONO(2011)20, OECD, Paris.
- (34) Clermont, Y. (1972), 'Kinetics of spermatogenesis in mammals seminiferous epithelium cycle and spermatogonial renewal'. *Physiol. Rev.* 52: 198-236.
- (35) Robaire, B., Hinton, B.T., and Oregbin-Crist, M.-C. (2006), 'The Epididymis', in Neil, J.D., Pfaff, D.W., Chalis, J.R.G., de Kretser, D.M., Richards, J.S., and P. M. Wassarman (eds.), *Physiology of Reproduction*, Elsevier, the Netherlands, pp. 1071-1148.
- (36) Russell, L.B. (2004), 'Effects of male germ-cell stage on the frequency, nature, and spectrum of induced specific-locus mutations in the mouse', *Genetica*, 122: 25-36.

▼ M5*Appendix*

DEFINITIONS:

Administration period: the total period during which an animal is dosed.

Base pair substitution: a type of mutation that causes the replacement of a single DNA nucleotide base with another DNA nucleotide base.

Capsid: the protein shell that surrounds a virus particle.

Chemical: a substance or a mixture.

Clonal expansion: the production of many cells from a single (mutant) cell.

Colony-forming unit (cfu): a measure of viable bacterial numbers.

Concatamer: a long continuous biomolecule composed of multiple identical copies linked in series.

Cos site: a 12-nucleotide segment of single-stranded DNA that exists at both ends of the bacteriophage lambda's double-stranded genome.

Deletion: a mutation in which one or more (sequential) nucleotides is lost by the genome.

Electroporation: the application of electric pulses to increase the permeability of cell membranes.

Endogenous gene: a gene native to the genome.

Extrabinomial variation: greater variability in repeat estimates of a population proportion than would be expected if the population had a binomial distribution.

Frameshift mutation: a genetic mutation caused by insertions or deletions of a number of nucleotides that is not evenly divisible by three within a DNA sequence that codes for a protein/peptide.

Insertion: the addition of one or more nucleotide base pairs into a DNA sequence.

Jackpot: a large number of mutants that arose through clonal expansion from a single mutation.

Large deletions: deletions in DNA of more than several kilobases (which are effectively detected with the Spi⁻ selection and the lacZ plasmid assays).

Ligation: the covalent linking of two ends of DNA molecules using DNA ligase.

Mitogen: a chemical that stimulates a cell to commence cell division, triggering mitosis (i.e. cell division).

Neutral gene: a gene that is not affected by positive or negative selective pressures.

Packaging: the synthesis of infective phage particles from a preparation of phage capsid and tail proteins and a concatamer of phage DNA molecules. Commonly used to package DNA cloned onto a lambda vector (separated by cos sites) into infectious lambda particles.

Packaging efficiency: the efficiency with which packaged bacteriophages are recovered in host bacteria.

▼ M5

Plaque forming unit (pfu): a measure of viable bacteriophage numbers.

Point mutation: a general term for a mutation affecting only a small sequence of DNA including small insertions, deletions, and base pair substitutions.

Positive selection: a method that permits only mutants to survive.

Reporter gene: a gene whose mutant gene product is easily detected.

Sampling time: the end of the period of time, prior to sacrifice, during which the chemical is not administered and during which unprocessed DNA lesions are fixed into stable mutations.

Shuttle vector: a vector constructed so that it can propagate in two different host species; accordingly, DNA inserted into a shuttle vector can be tested or manipulated in two different cell types or two different organisms.

Test chemical: Any substance or mixture tested using this test method.

Transgenic: of, relating to, or being an organism whose genome has been altered by the transfer of a gene or genes from another species.

▼M7**B.59. IN CHEMICO SKIN SENSITISATION: DIRECT PEPTIDE REACTIVITY ASSAY (DPRA)**

INTRODUCTION

This test method (TM) is equivalent to the OECD test guideline (TG) 442C (2015). A skin sensitizer refers to a substance that will lead to an allergic response following skin contact as defined by the United Nations Globally Harmonized System of Classification and Labelling of Chemicals (UN GHS) (1) and Regulation (EC) No 1272/2008 of the European Parliament and Council on Classification, Labelling and Packaging of Substances and Mixtures (CLP) (1). This test method provides an *in chemico* procedure (Direct Peptide Reactivity Assay — DPRA) to be used for supporting the discrimination between skin sensitizers and non-sensitizers in accordance with the UN GHS and CLP.

There is general agreement regarding the key biological events underlying skin sensitization. The existing knowledge of the chemical and biological mechanisms associated with skin sensitization has been summarised in the form of an Adverse Outcome Pathway (AOP) (2), from the molecular initiating event through the intermediate events to the adverse effect namely allergic contact dermatitis in humans or contact hypersensitivity in rodents. Within the skin sensitization AOP, the molecular initiating event is the covalent binding of electrophilic substances to nucleophilic centres in skin proteins.

The assessment of skin sensitization has typically involved the use of laboratory animals. The classical methods based on guinea-pigs, the Magnusson Kligman Guinea Pig Maximisation Test (GMPT) and the Buehler Test (TM B.6 (3)), study both the induction and elicitation phases of skin sensitization. A murine test, the Local Lymph Node Assay (LLNA, TM B.42 (4)) and its two non-radioactive modifications, LLNA: DA (TM B.50 (5)) and LLNA: BrdU-ELISA (TM B.51 (6)), which all assess the induction response exclusively, have also gained acceptance since they provide an advantage over the guinea pig tests in terms of animal welfare and an objective measurement of the induction phase of skin sensitization.

More recently, mechanistically based *in chemico* and *in vitro* test methods have been considered scientifically valid for the evaluation of the skin sensitization hazard of chemicals. However, combinations of non-animal methods (*in silico*, *in chemico*, *in vitro*) within Integrated Approaches to Testing and Assessment (IATA) will be needed to be able to fully substitute for the animal tests currently in use given the restricted AOP mechanistic coverage of each of the currently available non-animal test methods (2) (7).

The DPRA is proposed to address the molecular initiating event of the skin sensitization AOP, namely protein reactivity, by quantifying the reactivity of test chemicals towards model synthetic peptides containing either lysine or cysteine (8). Cysteine and lysine percent peptide depletion values are then used to categorise a substance in one of four classes of reactivity for supporting the discrimination between skin sensitizers and non-sensitizers (9).

(1) Regulation (EC) No 1272/2008 of the European Parliament and of the Council of 16 December 2008 on classification, labelling and packaging of substances and mixtures, amending and repealing Directives 67/548/EEC and 1999/45/EC, and amending Regulation (EC) No 1907/2006 (OJ L 353, 31.12.2008, p. 1).

▼ M7

The DPRA has been evaluated in a European Union Reference Laboratory for Alternatives to Animal Testing (EURL ECVAM)-lead validation study and subsequent independent peer review by the EURL ECVAM Scientific Advisory Committee (ESAC) and was considered scientifically valid (10) to be used as part of an IATA to support the discrimination between skin sensitisers and non-sensitisers for the purpose of hazard classification and labelling. Examples on the use of DPRA data in combination with other information are reported in the literature (11) (12) (13) (14).

Definitions are provided in Appendix I.

INITIAL CONSIDERATIONS, APPLICABILITY AND LIMITATIONS

The correlation of protein reactivity with skin sensitisation potential is well established (15) (16) (17). Nevertheless, since protein binding represents only one key event, albeit the molecular initiating event of the skin sensitisation AOP, protein reactivity information generated with testing and non-testing methods may not be sufficient on its own to conclude on the absence of skin sensitisation potential of chemicals. Therefore, data generated with this test method should be considered in the context of integrated approaches such as IATA, combining them with other complementary information e.g. derived from *in vitro* assays addressing other key events of the skin sensitisation AOP as well as non-testing methods including read-across from chemical analogues.

This test method can be used, in combination with other complementary information, to support the discrimination between skin sensitisers (i.e. UN GHS/CLP Category 1) and non-sensitisers in the context of IATA. This test method cannot be used on its own, neither to sub-categorise skin sensitisers into subcategories 1A and 1B as defined by UN GHS/CLP, nor to predict potency for safety assessment decisions. However, depending on the regulatory framework, a positive result with the DPRA may be used on its own to classify a chemical into UN GHS/CLP category 1.

The DPRA test method proved to be transferable to laboratories experienced in high-performance liquid chromatography (HPLC) analysis. The level of reproducibility in predictions that can be expected from the test method is in the order of 85 % within laboratories and 80 % between laboratories (10). Results generated in the validation study (18) and published studies (19) overall indicate that the accuracy of the DPRA in discriminating sensitisers (i.e. UN GHS/CLP Cat. 1) from non-sensitisers is 80 % (N=157) with a sensitivity of 80 % (88/109) and specificity of 77 % (37/48) when compared to LLNA results. The DPRA is more likely to under predict chemicals showing a low to moderate skin sensitisation potency (i.e. UN GHS/CLP subcategory 1B) than chemicals showing a high skin sensitisation potency (i.e. UN GHS/CLP subcategory 1A) (18) (19). However, the accuracy values given here for the DPRA as a stand-alone test method are only indicative since the test method should be considered in combination with other sources of information in the context of an IATA and in accordance with the provisions of paragraph 9 above. Furthermore when evaluating non-animal methods for skin sensitisation, it should be kept in mind that the LLNA test as well as other animal tests may not fully reflect the situation in the species of interest, i.e. humans. On the basis of the overall data available, the DPRA was shown to be applicable to test chemicals covering a variety of organic functional groups, reaction mechanisms, skin sensitisation potency (as determined in *in vivo* studies) and physico-chemical properties (8) (9) (10) (19). Taken together, this information indicates the usefulness of the DPRA to contribute to the identification of skin sensitisation hazard.

▼ M7

The term 'test chemical' is used in this test method to refer to what is being tested and is not related to the applicability of the DPRA to the testing of substances and/or mixtures. This test method is not applicable for the testing of metal compounds since they are known to react with proteins with mechanisms other than covalent binding. A test chemical should be soluble in an appropriate solvent at a final concentration of 100 mM (see paragraph 18). However, test chemicals that are not soluble at this concentration may still be tested at lower soluble concentrations. In such a case, a positive result could still be used to support the identification of the test chemical as a skin sensitiser but no firm conclusion on the lack of reactivity should be drawn from a negative result. Limited information is currently available on the applicability of the DPRA to mixtures of known composition (18) (19). The DPRA is nevertheless considered to be technically applicable to the testing of multi-constituent substances and mixtures of known composition (see paragraph 18). Before use of this test method on a mixture for generating data for an intended regulatory purpose, it should be considered whether, and if so why, it may provide adequate results for that purpose. Such considerations are not needed when there is a regulatory requirement for testing of the mixture. The current prediction model cannot be used for complex mixtures of unknown composition or for substances of unknown or variable composition, complex reaction products or biological materials (i.e. UVCB substances) due to the defined molar ratio of test chemical and peptide. For this purpose a new prediction model based on a gravimetric approach will need to be developed. In cases where evidence can be demonstrated on the non-applicability of the test method to other specific categories of chemicals, the test method should not be used for those specific categories of chemicals.

This test method is an *in chemico* method that does not encompass a metabolic system. Chemicals that require enzymatic bioactivation to exert their skin sensitisation potential (i.e. pro-haptens) cannot be detected by the test method. Chemicals that become sensitisers after abiotic transformation (i.e. pre-haptens) are reported to be in some cases correctly detected by the test method (18). In the light of the above, negative results obtained with the test method should be interpreted in the context of the stated limitations and in the connection with other information sources within the framework of an IATA. Test chemicals that do not covalently bind to the peptide but promote its oxidation (i.e. cysteine dimerisation) could lead to a potential over estimation of peptide depletion, resulting in possible false positive predictions and/or assignment to a higher reactivity class (see paragraphs 29 and 30).

As described, the DPRA supports the discrimination between skin sensitisers and non-sensitisers. However, it may also potentially contribute to the assessment of sensitising potency (11) when used in integrated approaches such as IATA. However further work, preferably based on human data, is required to determine how DPRA results may possibly inform potency assessment.

PRINCIPLE OF THE TEST

The DPRA is an *in chemico* method which quantifies the remaining concentration of cysteine- or lysine-containing peptide following 24 hours incubation with the test chemical at $25 \pm 2,5$ °C. The synthetic peptides contain phenylalanine to aid in the detection. Relative peptide concentration is measured by high-performance liquid chromatography (HPLC) with gradient elution and UV detection at 220 nm. Cysteine- and lysine peptide percent depletion values are then calculated and used in a prediction model (see paragraph 29) which allows assigning the test chemical to one of four reactivity classes used to support the discrimination between sensitisers and non-sensitisers.

▼M7

Prior to routine use of the method described in this test method, laboratories should demonstrate technical proficiency, using the ten proficiency substances listed in Appendix 2.

PROCEDURE

This test method is based on the DPRA DB-ALM protocol n° 154 (20) which represents the protocol used for the EURL ECVAM-coordinated validation study. It is recommended that this protocol is used when implementing and using the method in the laboratory. The following is a description of the main components and procedures for the DPRA. If an alternative HPLC set-up is used, its equivalence to the validated set-up described in the DB-ALM protocol should be demonstrated (e.g. by testing the proficiency substances in Appendix 2).

Preparation of the cysteine or lysine-containing peptides

Stock solutions of cysteine (Ac-RFAACAA-COOH) and lysine (Ac-RFAAKAA-COOH) containing synthetic peptides of purity higher than 85 % and preferably in the range of 90-95 %, should be freshly prepared just before their incubation with the test chemical. The final concentration of the cysteine peptide should be 0,667 mM in pH 7,5 phosphate buffer whereas the final concentration of the lysine peptide should be 0,667 mM in pH 10,2 ammonium acetate buffer. The HPLC run sequence should be set up in order to keep the HPLC analysis time less than 30 hours. For the HPLC set up used in the validation study and described in this test method, up to 26 analysis samples (which include the test chemical, the positive control and the appropriate number of solvent controls based on the number of individual solvents used in the test, each tested in triplicate), can be accommodated in a single HPLC run. All of the replicates analysed in the same run should use the identical cysteine and lysine peptide stock solutions. It is recommended to prove individual peptide batches for proper solubility prior to their use.

Preparation of the test chemical

Solubility of the test chemical in an appropriate solvent should be assessed before performing the assay following the solubilisation procedure described in the DPRA DB-ALM protocol (20). An appropriate solvent will dissolve the test chemical completely. Since in the DPRA the test chemical is incubated in large excess with either the cysteine or the lysine peptides, visual inspection of the forming of a clear solution is considered sufficient to ascertain that the test chemical (and all of its components in the case of testing a multi-constituent substance or a mixture) is dissolved. Suitable solvents are acetonitrile, water, 1:1 mixture water:acetonitrile, isopropanol, acetone or 1:1 mixture acetone:acetonitrile. Other solvents can be used as long as they do not impact on the stability of the peptide as monitored with reference controls C (i.e. samples constituted by the peptide alone dissolved in the appropriate solvent; see Appendix 3). As a last option if the test chemical is not soluble in any of these solvents attempts should be made to solubilise it in 300 µL of DMSO and dilute the resulting solution with 2 700 µL of acetonitrile and if the test chemical is not soluble in this mixture attempts should be made to solubilise the same amount of test chemical in 1 500 µL of DMSO and dilute the resulting solution with 1 500 µL of acetonitrile. The test chemical should be pre-weighed into glass vials and dissolved immediately before testing in an appropriate solvent to prepare a 100 mM solution. For mixtures

▼ M7

and multi-constituent substances of known composition, a single purity should be determined by the sum of the proportion of its constituents (excluding water), and a single apparent molecular weight should be determined by considering the individual molecular weights of each component in the mixture (excluding water) and their individual proportions. The resulting purity and apparent molecular weight should then be used to calculate the weight of test chemical necessary to prepare a 100 mM solution. For polymers for which a predominant molecular weight cannot be determined, the molecular weight of the monomer (or the apparent molecular weight of the various monomers constituting the polymer) may be considered to prepare a 100 mM solution. However, when testing mixtures, multi-constituent substances or polymers of known composition, it should be considered to also test the neat chemical. For liquids, the neat chemical should be tested as such without any prior dilution by incubating it at 1:10 and 1:50 molar ratio with the cysteine and lysine peptides, respectively. For solids, the test chemical should be dissolved to its maximum soluble concentration in the same solvent used to prepare the apparent 100 mM solution. It should then be tested as such without any further dilution by incubating it at 1:10 and 1:50 ratio with the cysteine and lysine peptides, respectively. Concordant results (reactive or non-reactive) between the apparent 100 mM solution and the neat chemical should allow for a firm conclusion on the result.

Preparation of the positive control, reference controls and coelution controls

Cinnamic aldehyde (CAS 104-55-2; ≥ 95 % food-grade purity) should be used as positive control (PC) at a concentration of 100 mM in acetonitrile. Other suitable positive controls preferentially providing mid-range depletion values may be used if historical data are available to derive comparable run acceptance criteria. In addition, reference controls (i.e. samples containing only the peptide dissolved in the appropriate solvent) should also be included in the HPLC run sequence and these are used to verify the HPLC system suitability prior to the analysis (reference controls A), the stability of the reference controls over time (reference controls B) and to verify that the solvent used to dissolve the test chemical does not impact the percent peptide depletion (reference controls C) (see Appendix 3). The appropriate reference control for each chemical is used to calculate the percent peptide depletion for that chemical (see paragraph 26). In addition a co-elution control constituted by the test chemical alone for each of the test chemicals analysed should be included in the run sequence to detect possible co-elution of the test chemical with either the lysine or the cysteine peptide.

Incubation of the test chemical with the cysteine and lysine peptide solutions

Cysteine and lysine peptide solutions should be incubated in glass autosampler vials with the test chemical at 1:10 and 1:50 ratio respectively. If a precipitate is observed immediately upon addition of the test chemical solution to the peptide solution, due to low aqueous solubility of the test chemical, in this case one cannot be sure how much test chemical remained in the solution to react with the peptide. Therefore, in such a case, a positive result could still be used, but a negative result is uncertain and should be interpreted with due care (see also provisions in paragraph 11 for the testing of chemicals not soluble up to a concentration of 100 mM). The reaction solution should be left in the dark at $25 \pm 2,5$ °C for 24 ± 2 hours before running the HPLC analysis. Each test chemical should be analysed in triplicate for both peptides. Samples have to be visually inspected prior to HPLC analysis. If a precipitate or phase separation is observed, samples may be centrifuged at low speed (100-400 xg) to force precipitate to the bottom of the vial as a precaution since large amounts of precipitate may clog the HPLC tubing or columns. If a precipitation or phase separation is observed after the incubation period, peptide depletion may be underestimated and a conclusion on the lack of reactivity cannot be drawn with sufficient confidence in case of a negative result.

▼ M7**Preparation of the HPLC standard calibration curve**

A standard calibration curve should be generated for both the cysteine and the lysine peptides. Peptide standards should be prepared in a solution of 20 % or 25 % acetonitrile:buffer using phosphate buffer (pH 7,5) for the cysteine peptide and ammonium acetate buffer (pH 10,2) for the lysine peptide. Using serial dilution standards of the peptide stock solution (0,667 mM), 6 calibration solutions should be prepared to cover the range from 0,534 to 0,0167 mM. A blank of the dilution buffer should also be included in the standard calibration curve. Suitable calibration curves should have an $r^2 > 0,99$.

HPLC preparation and analysis

The suitability of the HPLC system should be verified before conducting the analysis. Peptide depletion is monitored by HPLC coupled with an UV detector (photodiode array detector or fixed wavelength absorbance detector with 220 nm signal). The appropriate column is installed in the HPLC system. The HPLC set-up described in the validated protocol uses a Zorbax SB-C-18 2,1 mm × 100 mm × 3,5 micron as preferred column. With this reversed-phase HPLC column, the entire system should be equilibrated at 30 °C with 50 % phase A (0,1 % (v/v) trifluoroacetic acid in water) and 50 % phase B (0,085 % (v/v) trifluoroacetic acid in acetonitrile) for at least 2 hours before running. The HPLC analysis should be performed using a flow rate of 0,35 ml/min and a linear gradient from 10 % to 25 % acetonitrile over 10 minutes, followed by a rapid increase to 90 % acetonitrile to remove other materials. Equal volumes of each standard, sample and control should be injected. The column should be re-equilibrated under initial conditions for 7 minutes between injections. If a different reversed-phase HPLC column is used, the set-up parameters described above may need to be adjusted to guarantee an appropriate elution and integration of the cysteine and lysine peptides, including the injection volume, which may vary according to the system used (typically in the range from 3-10 µl). Importantly, if an alternative HPLC set-up is used, its equivalence to the validated set-up described above should be demonstrated (e.g. by testing the proficiency substances in Appendix 2). Absorbance is monitored at 220 nm. If a photodiode array detector is used, absorbance at 258 nm should also be recorded. It should be noted that some supplies of acetonitrile could have a negative impact on peptide stability and this has to be assessed when a new batch of acetonitrile is used. The ratio of the 220 peak area and the 258 peak area can be used as an indicator of co-elution. For each sample a ratio in the range of 90 % < mean⁽¹⁾ area ratio of control samples < 100 % would give a good indication that co-elution has not occurred.

There may be test chemicals which could promote the oxidation of the cysteine peptide. The peak of the dimerised cysteine peptide may be visually monitored. If dimerisation appears to have occurred, this should be noted as percent peptide depletion may be over-estimated leading to false positive predictions and/or assignment to a higher reactivity class (see paragraphs 29 and 30).

HPLC analysis for the cysteine and lysine peptides can be performed concurrently (if two HPLC systems are available) or on separate days. If analysis is conducted on separate days then all test chemical solutions should be freshly prepared for both assays on each day. The analysis should be timed to assure that the injection of the first sample starts 22 to 26 hours after the test chemical was mixed with the peptide solution. The HPLC run sequence should be set up in order to keep the HPLC analysis time less than 30 hours. For the HPLC set up used in the validation study and described in this test method, up to 26 analysis

⁽¹⁾ For mean it is meant arithmetic mean throughout the document.

▼M7

samples can be accommodated in a single HPLC run (see also paragraph 17). An example of HPLC analysis sequence is provided in Appendix 3.

DATA AND REPORTING**Data evaluation**

The concentration of cysteine or lysine peptide is photometrically determined at 220 nm in each sample by measuring the peak area (area under the curve, AUC) of the appropriate peaks and by calculating the concentration of peptide using the linear calibration curve derived from the standards.

The percent peptide depletion is determined in each sample by measuring the peak area and dividing it by the mean peak area of the relevant reference controls C (see Appendix 3) according to the formula described below.

$$\text{Percent peptide depletion} = \left[1 - \left(\frac{\text{Peptide peak area in replicate injection}}{\text{mean peptide peak area in reference controls C}} \right) \right] \times 100$$

Acceptance criteria

The following criteria should be met for a run to be considered valid:

- (a) the standard calibration curve should have an $r^2 > 0,99$,
- (b) the mean percent peptide depletion value of the three replicates for the positive control cinnamic aldehyde should be between 60,8 % and 100 % for the cysteine peptide and between 40,2 % and 69,0 % for the lysine peptide and the maximum standard deviation (SD) for the positive control replicates should be < 14,9 % for the percent cysteine depletion and < 11,6 % for the percent lysine depletion, and
- (c) the mean peptide concentration of reference controls A should be $0,50 \pm 0,05$ mM and the coefficient of variation (CV) of peptide peak areas for the nine reference controls B and C in acetonitrile should be < 15,0 %.

If one or more of these criteria is not met the run should be repeated.

The following criteria should be met for a test chemical's results to be considered valid:

- (a) the maximum standard deviation for the test chemical replicates should be < 14,9 % for the percent cysteine depletion and < 11,6 % for the percent lysine depletion,
- (b) the mean peptide concentration of the three reference controls C in the appropriate solvent should be $0,50 \pm 0,05$ mM. If these criteria are not met the data should be rejected and the run should be repeated for that specific test chemical.

Prediction model

The mean percent cysteine and percent lysine depletion value is calculated for each test chemical. Negative depletion is considered as '0' when calculating the mean. By using the cysteine 1:10/lysine 1:50 prediction model shown in Table 1, the threshold of 6,38 % average peptide depletion should be used to support the discrimination between skin sensitisers and non-sensitisers in the framework of an IATA. Application of the prediction model for assigning a test chemical to a reactivity class (i.e. low, moderate and high reactivity) may perhaps prove useful to inform potency assessment within the framework of an IATA.

▼ **M7**

Table 1

Cysteine 1:10/lysine 1:50 prediction model ⁽¹⁾

Mean of cysteine and lysine % depletion	Reactivity Class	DPRA Prediction ⁽²⁾
$0\% \leq \text{mean \% depletion} \leq 6,38\%$	No or minimal reactivity	Negative
$6,38\% < \text{mean \% depletion} \leq 22,62\%$	Low reactivity	Positive
$22,62\% < \text{mean \% depletion} \leq 42,47\%$	Moderate reactivity	
$42,47\% < \text{mean \% depletion} \leq 100\%$	High reactivity	

⁽¹⁾ The numbers refer to statistically generated threshold values and are not related to the precision of the measurement.

⁽²⁾ A DPRA prediction should be considered in the framework of an IATA and in accordance with the provisions of paragraphs 9 and 12.

There might be cases where the test chemical (the substance or one or several of the components of a multi-constituent substance or a mixture) absorbs significantly at 220 nm and has the same retention time of the peptide (co-elution). Co-elution may be resolved by slightly adjusting the HPLC set-up in order to further separate the elution time of the test chemical and the peptide. If an alternative HPLC set-up is used to try to resolve co-elution, its equivalence to the validated set-up should be demonstrated (e.g. by testing the proficiency substances in Appendix 2). When co-elution occurs the peak of the peptide cannot be integrated and the calculation of the percent peptide depletion is not possible. If co-elution of such test chemicals occurs with both the cysteine and the lysine peptides then the analysis should be reported as 'inconclusive'. In cases where co-elution occurs only with the lysine peptide, then the cysteine 1:10 prediction model reported in Table 2 can be used.

Table 2

Cysteine 1:10 prediction model ⁽¹⁾

Cysteine (Cys) % depletion	Reactivity class	DPRA prediction ⁽²⁾
$0\% \leq \text{Cys \% depletion} \leq 13,89\%$	No or minimal reactivity	Negative
$13,89\% < \text{Cys \% depletion} \leq 23,09\%$	Low reactivity	Positive
$23,09\% < \text{Cys \% depletion} \leq 98,24\%$	Moderate reactivity	
$98,24\% < \text{Cys \% depletion} \leq 100\%$	High reactivity	

⁽¹⁾ The numbers refer to statistically generated threshold values and are not related to the precision of the measurement.

⁽²⁾ A DPRA prediction should be considered in the framework of an IATA and in accordance with the provisions of paragraphs 9 and 12.

There might be other cases where the overlap in retention time between the test chemical and either of the peptides is incomplete. In such cases percent peptide depletion values can be estimated and used in the cysteine 1:10/lysine 1:50 prediction model, however assignment of the test chemical to a reactivity class cannot be made with accuracy.

▼M7

A single HPLC analysis for both the cysteine and the lysine peptide should be sufficient for a test chemical when the result is unequivocal. However, in cases of results close to the threshold used to discriminate between positive and negative results (i.e. borderline results), additional testing may be necessary. If situations where the mean percent depletion falls in the range of 3 % to 10 % for the cysteine 1:10/lysine 1:50 prediction model or the cysteine percent depletion falls in the range of 9 % to 17 % for the cysteine 1:10 prediction model, a second run should be considered, as well as a third one in case of discordant results between the first two runs.

Test report

The test report should include the following information

Test chemical

- Mono-constituent substance
 - Chemical identification, such as IUPAC or CAS name(s), CAS number(s), SMILES or InChI code, structural formula, and/or other identifiers;
 - Physical appearance, water solubility, molecular weight, and additional relevant physicochemical properties, to the extent available;
 - Purity, chemical identity of impurities as appropriate and practically feasible, etc;
 - Treatment prior to testing, if applicable (e.g. warming, grinding);
 - Concentration(s) tested;
 - Storage conditions and stability to the extent available.
- Multi-constituent substance, UVCB and mixture:
 - Characterisation as far as possible by e.g. chemical identity (see above), purity, quantitative occurrence and relevant physicochemical properties (see above) of the constituents, to the extent available;
 - Physical appearance, water solubility and additional relevant physicochemical properties, to the extent available;
 - Molecular weight or apparent molecular weight in case of mixtures/polymers of known compositions or other information relevant for the conduct of the study;
 - Treatment prior to testing, if applicable (e.g. warming, grinding);
 - Concentration(s) tested;
 - Storage conditions and stability to the extent available.

Controls

- Positive control
 - Chemical identification, such as IUPAC or CAS name(s), CAS number(s), SMILES or InChI code, structural formula, and/or other identifiers;
 - Physical appearance, water solubility, molecular weight, and additional relevant physicochemical properties, to the extent available;
 - Purity, chemical identity of impurities as appropriate and practically feasible, etc;

▼M7

- Treatment prior to testing, if applicable (e.g. warming, grinding);
- Concentration(s) tested;
- Storage conditions and stability to the extent available;
- Reference to historical positive control results demonstrating suitable run acceptance criteria, if applicable.
- Solvent/vehicle
 - Solvent/vehicle used and ratio of its constituents, if applicable;
 - Chemical identification(s), such as IUPAC or CAS name(s), CAS number(s), and/or other identifiers;
 - Purity, chemical identity of impurities as appropriate and practically feasible, etc;
 - Physical appearance, molecular weight, and additional relevant physico-chemical properties in the case other solvents / vehicles than those mentioned in the test method are used and to the extent available;
 - Storage conditions and stability to the extent available;
 - Justification for choice of solvent for each test chemical;
 - For acetonitrile, results of test of impact on peptide stability.

Preparation of peptides, positive control and test chemical

- Characterisation of peptide solutions (supplier, lot, exact weight of peptide, volume added for the stock solution);
- Characterisation of positive control solution (exact weight of positive control substance, volume added for the test solution);
- Characterisation of test chemical solutions (exact weight of test chemical, volume added for the test solution).

HPLC instrument setting and analysis

- Type of HPLC instrument, HPLC and guard columns, detector, autosampler;
- Parameters relevant for the HPLC analysis such as column temperature, injection volumes, flow rate and gradient.

System suitability

- Peptide peak area at 220 nm of each standard and reference control A replicate;
- Linear calibration curve graphically represented and the r^2 reported;
- Peptide concentration of each reference control A replicate;
- Mean peptide concentration (mM) of the three reference controls A, SD and CV;
- Peptide concentration of reference controls A and C.

▼ M7*Analysis sequence*

- For reference controls:
 - Peptide peak area at 220 nm of each B and C replicate;
 - Mean peptide peak area at 220 nm of the nine reference controls B and C in acetonitrile, SD and CV (for stability of reference controls over analysis time);
 - For each solvent used, the mean peptide peak area at 220 nm of the three appropriate reference controls C (for the calculation of percent peptide depletion);
 - For each solvent used, the peptide concentration (mM) of the three appropriate reference controls C;
 - For each solvent used, the mean peptide concentration (mM) of the three appropriate reference controls C, SD and CV.
- For positive control:
 - Peptide peak area at 220 nm of each replicate;
 - Percent peptide depletion of each replicate;
 - Mean percent peptide depletion of the three replicates, SD and CV.
- For each test chemical:
 - Appearance of precipitate in the reaction mixture at the end of the incubation time, if observed. If precipitate was re-solubilised or centrifuged;
 - Presence of co-elution;
 - Description of any other relevant observations, if applicable;
 - Peptide peak area at 220 nm of each replicate;
 - Percent peptide depletion of each replicate;
 - Mean of percent peptide depletion of the three replicates, SD and CV;
 - Mean of percent cysteine and percent lysine depletion values;
 - Prediction model used and DPRA prediction.

Proficiency testing

- If applicable, the procedure used to demonstrate proficiency of the laboratory in performing the test method (e.g. by testing of proficiency substances) or to demonstrate reproducible performance of the test method over time.

Discussion of the results

- Discussion of the results obtained with the DPRA test method;
- Discussion of the test method results in the context of an IATA if other relevant information is available.

Conclusion

▼ M7

LITERATURE:

- (1) United Nations (UN) (2013). Globally Harmonized System of Classification and Labelling of Chemicals (GHS). Fifth revised edition, UN New York and Geneva, 2013. Available at: http://www.unece.org/trans/danger/publi/ghs/ghs_rev05/05files_e.html
- (2) OECD (2012). The Adverse Outcome Pathway for Skin Sensitisation Initiated by Covalent Binding to Proteins. Part 1: Scientific Evidence. Series on Testing and Assessment No. 168, OECD, Paris.
- (3) Chapter B.6 of this Annex: Skin Sensitisation.
- (4) Chapter B.42 of this Annex: The Local Lymph Node Assay
- (5) Chapter B.50 of this Annex: Skin Sensitisation: Local Lymph Node Assay: DA.
- (6) Chapter B.51 of this Annex: Skin Sensitisation: Local Lymph Node Assay BrdU-ELISA
- (7) Adler *et al.* (2011). Alternative (non-animal) methods for cosmetics testing: current status and future prospects-2010. *Archives of Toxicology* 85:367-485.
- (8) Gerberick *et al.* (2004). Development of a peptide reactivity assay for screening contact allergens. *Toxicological Sciences* 81:332-343.
- (9) Gerberick *et al.* (2007). Quantification of chemical peptide reactivity for screening contact allergens: A classification tree model approach. *Toxicological Sciences* 97:417-427.
- (10) EC EURL-ECVAM (2013). Recommendation on the Direct Peptide Reactivity Assay (DPRA) for skin sensitisation testing. Available at: <https://eurl-ecvam.jrc.ec.europa.eu/eurl-ecvam-recommendations/eurl-ecvam-recommendation-on-the-direct-peptide-reactivity-assay-dpra>
- (11) Jaworska *et al.* (2013). Bayesian integrated testing strategy to assess skin sensitization potency: from theory to practice. *Journal of Applied Toxicology*, published online, 14 May 2013, DOI: 10.1002/jat.2869.
- (12) Bauch *et al.* (2012). Putting the parts together: combining *in vitro* methods to test for skin sensitizing potential. *Regulatory Toxicology and Pharmacology* 63: 489-504.
- (13) Nukada *et al.* (2013). Data integration of non-animal tests for the development of a test battery to predict the skin sensitizing potential and potency of chemicals. *Toxicology in vitro* 27:609-618.
- (14) Ball *et al.* (2011). Evaluating the sensitization potential of surfactants: integrating data from the local lymph node assay, guinea pig maximization test, and *in vitro* methods in a weight-of-evidence approach. *Regulatory Toxicology and Pharmacology* 60:389-400.
- (15) Landsteiner and Jacobs (1936). Studies on the sensitization of animals with simple chemical compounds. *Journal of Experimental Medicine* 64:625-639.
- (16) Dupuis and Benezra (1982). Allergic contact dermatitis to simple chemicals: a molecular approach. New York & Basel: Marcel Dekker Inc.
- (17) Lepoittevin *et al.* (1998). Allergic contact dermatitis: the molecular basis. Springer, Berlin.
- (18) EC EURL ECVAM (2012). Direct Peptide Reactivity Assay (DPRA) Validation Study Report 74pp. Accessible at: http://ihcp.jrc.ec.europa.eu/our_labs/eurl-ecvam/eurl-ecvam-recommendations/eurl-ecvam-recommendation-on-the-direct-peptide-reactivity-assay-dpra

▼ M7

- (19) Natsch *et al.* (2013). A dataset on 145 chemicals tested in alternative assays for skin sensitization undergoing prevalidation. *Journal of Applied Toxicology*, published online, 9 April 2013, DOI:10.1002/jat.2868.
- (20) DB-ALM (INVITTOX) Protocol 154: Direct Peptide Reactivity assay (DPRA) for skin sensitisation testing 17pp. Accessible at: <http://ecvam-dbalm.jrc.ec.europa.eu/>
- (21) OECD (2005). Guidance Document on the Validation and International Acceptance of New or Updated Test Methods for Hazard Assessment. OECD Series on Testing and Assessment, No. 34. Organisation for Economic Cooperation and Development, Paris, France.
- (22) FDA (Food and Drug Administration (2001). Guidance for Industry: Bioanalytical Method Validation 22pp. Accessible at: www.fda.gov/downloads/drugs/guidancecomplianceregulatoryinformation/guidance/ucm070107.pdf - 138
- (23) ECETOC (2003). Contact sensitization: Classification according to potency. European Centre for Ecotoxicology & Toxicology of Chemicals (Technical Report No. 87).

▼ M7

Appendix 1

DEFINITIONS

Accuracy: The closeness of agreement between test method results and accepted reference values. It is a measure of test method performance and one aspect of 'relevance'. The term is often used interchangeably with 'concordance', to mean the proportion of correct outcomes of a test method (21).

AOP (Adverse Outcome Pathway): Sequence of events from the chemical structure of a target chemical or group of similar chemicals through the molecular initiating event to an *in vivo* outcome of interest (2).

Calibration curve: The relationship between the experimental response value and the analytical concentration (also called *standard curve*) of a known substance.

Chemical: A substance or a mixture.

Coefficient of variation: A measure of variability that is calculated for a group of replicate data by dividing the standard deviation by the mean. It can be multiplied by 100 for expression as a percentage.

Hazard: Inherent property of an agent or situation having the potential to cause adverse effects when an organism, system or (sub) population is exposed to that agent.

IATA (Integrated Approach to Testing and Assessment): A structured approach used for hazard identification (potential), hazard characterisation (potency) and/or safety assessment (potential/potency and exposure) of a chemical or group of chemicals, which strategically integrates and weights all relevant data to inform regulatory decision regarding potential hazard and/or risk and/or the need for further targeted and therefore minimal testing.

Molecular Initiating Event: Chemical-induced perturbation of a biological system at the molecular level identified to be the starting event in the adverse outcome pathway.

Mixture: A mixture or a solution composed of two or more substances in which they do not react (1).

Mono-constituent substance: A substance, defined by its quantitative composition, in which one main constituent is present to at least 80 % (w/w).

Multi-constituent substance: A substance, defined by its quantitative composition, in which more than one main constituent is present in a concentration ≥ 10 % (w/w) and < 80 % (w/w). A multi-constituent substance is the result of a manufacturing process. The difference between mixture and multi-constituent substance is that a mixture is obtained by blending of two or more substances without chemical reaction. A multi-constituent substance is the result of a chemical reaction.

Positive control: A replicate containing all components of a test system and treated with a substance known to induce a positive response. To ensure that variability in the positive control response across time can be assessed, the magnitude of the positive response should not be excessive.

Reference control: An untreated sample containing all components of a test system, including the solvent or vehicle that is processed with the test chemical treated and other control samples to establish the baseline response for the samples treated with the test chemical dissolved in the same solvent

▼ M7

or vehicle. When tested with a concurrent negative control, this sample also demonstrates whether the solvent or vehicle interacts with the test system.

Relevance: Description of relationship of the test to the effect of interest and whether it is meaningful and useful for a particular purpose. It is the extent to which the test correctly measures or predicts the biological effect of interest. Relevance incorporates consideration of the accuracy (concordance) of a test method (21).

Reliability: Measures of the extent that a test method can be performed reproducibly within and between laboratories over time, when performed using the same protocol. It is assessed by calculating intra- and inter-laboratory reproducibility and intra-laboratory repeatability (21).

Reproducibility: The agreement among results obtained from testing the same chemical using the same test protocol (see reliability) (21).

Sensitivity: The proportion of all positive/active chemicals that are correctly classified by the test method. It is a measure of accuracy for a test method that produces categorical results, and is an important consideration in assessing the relevance of a test method (21).

Specificity: The proportion of all negative/inactive chemicals that are correctly classified by the test method. It is a measure of accuracy for a test method that produces categorical results and is an important consideration in assessing the relevance of a test method (21).

Substance: Chemical elements and their compounds in the natural state or obtained by any production process, including any additive necessary to preserve the stability of the product and any impurities deriving from the process used, but excluding any solvent which may be separated without affecting the stability of the substance or changing its composition (1).

System suitability: Determination of instrument performance (e.g. sensitivity) by analysis of a reference standard prior to running the analytical batch (22).

Test chemical: The term 'test chemical' is used to refer to what is being tested.

United Nations Globally Harmonized System of Classification and Labelling of Chemicals (UN GHS): A system proposing the classification of chemicals (substances and mixtures) according to standardised types and levels of physical, health and environmental hazards, and addressing corresponding communication elements, such as pictograms, signal words, hazard statements, precautionary statements and safety data sheets, so that to convey information on their adverse effects with a view to protect people (including employers, workers, transporters, consumers and emergency responders) and the environment (1).

UVCB: Substances of unknown or variable composition, complex reaction products or biological materials.

Valid test method: A test method considered to have sufficient relevance and reliability for a specific purpose and which is based on scientifically sound principles. A test method is never valid in an absolute sense, but only in relation to a defined purpose (21).

▼ **M7**

Appendix 2

PROFICIENCY SUBSTANCES***In Chemico* Skin Sensitisation: Direct Peptide Reactivity Assay**

Prior to routine use of this test method, laboratories should demonstrate technical proficiency by correctly obtaining the expected DPRA prediction for the 10 proficiency substances recommended in Table 1 and by obtaining cysteine and lysine depletion values that fall within the respective reference range for 8 out of the 10 proficiency substances for each peptide. These proficiency substances were selected to represent the range of responses for skin sensitisation hazards. Other selection criteria were that they are commercially available, that high quality *in vivo* reference data and high quality *in vitro* data generated with the DPRA are available, and that they were used in the EURL ECVAM-coordinated validation study to demonstrate successful implementation of the test method in the laboratories participating in the study.

Table 1

Recommended proficiency substances for demonstrating technical proficiency with the Direct Peptide Reactivity Assay

Proficiency substances	CASRN	Physical state	<i>In vivo</i> prediction ⁽¹⁾	DPRA prediction ⁽²⁾	Range ⁽³⁾ of % cysteine peptide depletion	Range ⁽³⁾ of % lysine peptide depletion
2,4-Dinitrochlorobenzene	97-00-7	Solid	Sensitiser (extreme)	Positive	90-100	15-45
Oxazolone	15646-46-5	Solid	Sensitiser (extreme)	Positive	60-80	10-55
Formaldehyde	50-00-0	Liquid	Sensitiser (strong)	Positive	30-60	0-24
Benzylideneacetone	122-57-6	Solid	Sensitiser (moderate)	Positive	80-100	0-7
Farnesal	19317-11-4	Liquid	Sensitiser (weak)	Positive	15-55	0-25
2,3-Butanedione	431-03-8	Liquid	Sensitiser (weak)	Positive	60-100	10-45
1-Butanol	71-36-3	Liquid	Non-sensitizer	Negative	0-7	0-5,5
6-Methylcoumarin	92-48-8	Solid	Non-sensitizer	Negative	0-7	0-5,5
Lactic Acid	50-21-5	Liquid	Non-sensitizer	Negative	0-7	0-5,5
4-Methoxyacetophenone	100-06-1	Solid	Non-sensitizer	Negative	0-7	0-5,5

⁽¹⁾ The *in vivo* hazard and (potency) predictions are based on LLNA data (19). The *in vivo* potency is derived using the criteria proposed by ECETOC (23).

⁽²⁾ A DPRA prediction should be considered in the framework of an IATA and in accordance with the provisions of paragraphs 9 and 11.

⁽³⁾ Ranges determined on the basis of at least 10 depletion values generated by 6 independent laboratories.

▼ M7

Appendix 3

EXAMPLES OF ANALYSIS SEQUENCE

Calibration standards and reference controls	STD1 STD2 STD3 STD4 STD5 STD6 Dilution buffer Reference control A, rep 1 Reference control A, rep 2 Reference control A, rep 3
Co-elution controls	Co-elution control 1 for test chemical 1 Co-elution control 2 for test chemical 2
Reference controls	Reference control B, rep 1 Reference control B, rep 2 Reference control B, rep 3
First set of replicates	Reference control C, rep 1 Cinnamic aldehyde, rep 1 Sample 1, rep 1 Sample 2, rep 1
Second set of replicates	Reference control C, rep 2 Cinnamic aldehyde, rep 2 Sample 1, rep 2 Sample 2, rep 2
Third set of replicates	Reference control C, rep 3 Cinnamic aldehyde, rep 3 Sample 1, rep 3 Sample 2, rep 3
Reference controls	Reference control B, rep 4 Reference control B, rep 5 Reference control B, rep 6

Three sets of reference controls (i.e. samples constituted only by the peptide dissolved in the appropriate solvent) should be included in the analysis sequence:

Reference control A: used to verify the suitability of the HPLC system.

Reference control B: included at the beginning and at the end of the analysis sequence to verify stability of reference controls over the analysis time.

Reference control C: included in the analysis sequence to verify that the solvent used to dissolve the test chemical does not impact the percent peptide depletion.

▼M7**B.60. *IN VITRO* SKIN SENSITISATION: ARE-NRF2 LUCIFERASE TEST METHOD**

INTRODUCTION

This test method (TM) is equivalent to OECD test guideline (TG) 442D (2015). A skin sensitizer refers to a substance that will lead to an allergic response following skin contact as defined by the United Nations Globally Harmonized System of Classification and Labelling of Chemicals (UN GHS) (1) and Regulation (EC) No 1272/2008 of the European Parliament and of the Council on Classification, Labelling and Packaging of Substances and Mixtures (CLP) (1). This test method provides an *in vitro* procedure (the ARE-Nrf2 luciferase assay) to be used for supporting the discrimination between skin sensitizers and non-sensitizers in accordance with the UN GHS (1) and CLP.

There is general agreement regarding the key biological events underlying skin sensitization. The existing knowledge of the chemical and biological mechanisms associated with skin sensitization has been summarised in the form of an Adverse Outcome Pathway (AOP) (2), going from the molecular initiating event through the intermediate events up to the adverse health effect, i.e. allergic contact dermatitis in humans or contact hypersensitivity in rodents (2) (3). The molecular initiating event is the covalent binding of electrophilic substances to nucleophilic centres in skin proteins. The second key event in this AOP takes place in the keratinocytes and includes inflammatory responses as well as gene expression associated with specific cell signalling pathways such as the antioxidant/electrophile response element (ARE)-dependent pathways. The third key event is the activation of dendritic cells, typically assessed by expression of specific cell surface markers, chemokines and cytokines. The fourth key event is T-cell proliferation, which is indirectly assessed in the murine Local Lymph Node Assay (4).

The assessment of skin sensitization has typically involved the use of laboratory animals. The classical methods based on guinea-pigs, the Magnusson Kligman Guinea Pig Maximisation Test (GMPT) and the Buehler Test (TM B.6 (5)), study both the induction and elicitation phases of skin sensitization. A murine test, the Local Lymph Node Assay (LLNA) (TM B.42 (4)) and its two non-radioactive modifications, LLNA: DA (TM B.50 (6)) and LLNA: BrdU-ELISA (TM B.51 (7)), which all assess the induction response exclusively, have also gained acceptance since they provide advantages over the guinea pig tests in terms of both animal welfare and objective measurement of the induction phase of skin sensitization.

More recently, mechanistically-based *in chemico* and *in vitro* test methods have been considered scientifically valid for the evaluation of the skin sensitization hazard of chemicals. However, combinations of non-animal methods (*in silico*, *in chemico*, *in vitro*) within Integrated Approaches to Testing and Assessment (IATA) will be needed to be able to fully substitute for the animal tests currently in use given the restricted AOP mechanistic coverage of each of the currently available non-animal test methods (2) (3).

This test method (ARE-Nrf2 luciferase assay) is proposed to address the second key event as explained in paragraph 2. Skin sensitizers have been reported to induce genes that are regulated by the antioxidant response element (ARE) (8) (9). Small electrophilic substances such as skin sensitizers can act on the sensor

(1) Regulation (EC) No 1272/2008 of the European Parliament and of the Council of 16 December 2008 on classification, labelling and packaging of substances and mixtures, amending and repealing Directives 67/548/EEC and 1999/45/EC, and amending Regulation (EC) No 1907/2006 (OJ L 353, 31.12.2008, p. 1).

▼ M7

protein Keap1 (Kelch-like ECH-associated protein 1), by e.g. covalent modification of its cysteine residue, resulting in its dissociation from the transcription factor Nrf2 (nuclear factor-erythroid 2-related factor 2). The dissociated Nrf2 can then activate ARE-dependent genes such as those coding for phase II detoxifying enzymes (8) (10) (11).

Currently, the only *in vitro* ARE-Nrf2 luciferase assay covered by this test method is the KeratinoSens™ assay for which validation studies have been completed (9) (12) (13) followed by an independent peer review conducted by the European Union Reference Laboratory for Alternatives to Animal Testing (EURL ECVAM) (14). The KeratinoSens™ assay was considered scientifically valid to be used as part of an IATA, to support the discrimination between skin sensitisers and non-sensitisers for the purpose of hazard classification and labelling (14). Laboratories willing to implement the test method can obtain the recombinant cell line used in the KeratinoSens™ assay by establishing a licence agreement with the test method developer (15).

Definitions are provided in Appendix 1.

INITIAL CONSIDERATIONS, APPLICABILITY AND LIMITATIONS

Since activation of the Keap1-Nrf2-ARE pathway addresses only the second key event of the skin sensitisation AOP, information from test methods based on the activation of this pathway is unlikely to be sufficient when used on its own to conclude on the skin sensitisation potential of chemicals. Therefore, data generated with the present test method should be considered in the context of integrated approaches, such as IATA, combining them with other complementary information e.g. derived from *in vitro* assays addressing other key events of the skin sensitisation AOP as well as non-testing methods including read-across from chemical analogues. Examples on how to use the ARE-Nrf2 luciferase test method in combination with other information are reported in literature (13) (16) (17) (18) (19).

This test method can be used to support the discrimination between skin sensitisers (i.e. UN GHS/CLP Category 1) and non-sensitisers in the context of IATA. This test method cannot be used on its own, neither to sub-categorise skin sensitisers into subcategories 1A and 1B as defined by the UN GHS/CLP nor to predict potency for safety assessment decisions. However, depending on the regulatory framework, a positive result may be used on its own to classify a chemical into UN GHS/CLP category 1.

Based on the dataset from the validation study and in-house testing used for the independent peer-review of the test method, the KeratinoSens™ assay proved to be transferable to laboratories experienced in cell culture. The level of reproducibility in predictions that can be expected from the test method is in the order of 85 % within and between laboratories (14). The accuracy (77 % - 155/201), sensitivity (78 % - 71/91) and specificity (76 % - 84/110) of the KeratinoSens™ assay for discriminating skin sensitisers (i.e. UN GHS/CLP Cat. 1) from non-sensitisers when compared to LLNA results were calculated by considering all of the data submitted to EURL ECVAM for evaluation and peer-review of the test

▼ M7

method (14). These figures are similar to those recently published based on in-house testing of about 145 substances (77 % accuracy, 79 % sensitivity, 72 % specificity) (13). The KeratinoSens™ assay is more likely to under predict chemicals showing a low to moderate skin sensitisation potency (i.e. UN GHS/CLP subcategory 1B) than chemicals showing a high skin sensitisation potency (i.e. UN GHS/CLP subcategory 1A) (13) (14). Taken together, this information indicates the usefulness of the KeratinoSens™ assay to contribute to the identification of skin sensitisation hazard. However, the accuracy values given here for the KeratinoSens™ assay as a stand-alone test method are only indicative since the test method should be considered in combination with other sources of information in the context of an IATA and in accordance with the provisions of paragraph 9 above. Furthermore when evaluating non-animal methods for skin sensitisation, it should be kept in mind that the LLNA as well as other animal tests, may not fully reflect the situation in the species of interest i.e. humans.

The term ‘test chemical’ is used in this test method to refer to what is being tested and is not related to the applicability of the ARE-Nrf2 luciferase test method to the testing of substances and/or mixtures. On the basis of the current data available the KeratinoSens™ assay was shown to be applicable to test chemicals covering a variety of organic functional groups, reaction mechanisms, skin sensitisation potency (as determined with *in vivo* studies) and physico-chemical properties (9) (12) (13) (14). Mainly mono-constituent substances were tested, although a limited amount of data also exist on the testing of mixtures (20). The test method is nevertheless technically applicable to the testing of multi-constituent substances and mixtures. However, before use of this test method on a mixture for generating data for an intended regulatory purpose, it should be considered whether, and if so why, it may provide adequate results for that purpose. Such considerations are not needed, when there is a regulatory requirement for testing of the mixture. Moreover, when testing multi-constituent substances or mixtures, consideration should be given to possible interference of cytotoxic constituents with the observed responses. The test method is applicable to test chemicals soluble or that form a stable dispersion (i.e. a colloid or suspension in which the test chemical does not settle or separate from the solvent into different phases) either in water or DMSO (including all of the test chemical components in the case of testing a multi-constituent substance or a mixture). Test chemicals that do not fulfil these conditions at the highest final required concentration of 2 000 µM (cf. paragraph 22) may still be tested at lower concentrations. In such a case, results fulfilling the criteria for positivity described in paragraph 39 could still be used to support the identification of the test chemical as a skin sensitiser, whereas a negative result obtained with concentrations < 1 000 µM should be considered as inconclusive (see prediction model in paragraph 39). In general substances with a LogP of up to 5 have been successfully tested whereas extremely hydrophobic substances with a LogP above 7 are outside the known applicability of the test method (14). For substances having a LogP falling between 5 and 7, only limited information is available.

Negative results should be interpreted with caution as substances with an exclusive reactivity towards lysine-residues can be detected as negative by the test method. Furthermore, because of the limited metabolic capability of the cell line used (21) and because of the experimental conditions, pro-haptens (i.e. chemicals requiring enzymatic activation for example via P450 enzymes) and pre-haptens (i.e. chemicals activated by auto-oxidation) in particular with a slow oxidation rate may also provide negative results. Test chemicals that do not act as a sensitiser but are nevertheless chemical stressors may lead on the other hand to false positive results (14). Furthermore, highly cytotoxic test chemicals cannot always be reliably assessed. Finally, test chemicals that interfere with the luciferase enzyme can confound the activity of luciferase in cell-based assays causing either apparent inhibition or increased luminescence (22). For example, phytoestrogen concentrations higher than 1 µM were reported to interfere with the luminescence signals in other luciferase-based reporter gene assays due to over-activation of the luciferase reporter gene (23). As a consequence, luciferase expression obtained at high concentrations of phytoestrogens or similar chemicals suspected of producing phytoestrogen-like over-activation of the luciferase reporter gene needs to be examined carefully (23). In cases where evidence

▼ M7

can be demonstrated on the non-applicability of the test method to other specific categories of test chemicals, the test method should not be used for those specific categories.

In addition to supporting discrimination between skin sensitisers and non-sensitisers, the KeratinoSens™ assay also provides concentration-response information that may potentially contribute to the assessment of sensitising potency when used in integrated approaches such as IATA (19). However, further work preferably based on reliable human data is required to determine how KeratinoSens™ assay results can contribute to potency assessment (24) and to sub-categorisation of sensitisers according to UN GHS/CLP.

PRINCIPLE OF THE TEST

The ARE-Nrf2 luciferase test method makes use of an immortalised adherent cell line derived from HaCaT human keratinocytes stably transfected with a selectable plasmid. The cell line contains the luciferase gene under the transcriptional control of a constitutive promoter fused with an ARE element from a gene that is known to be up-regulated by contact sensitisers (25) (26). The luciferase signal reflects the activation by sensitisers of endogenous Nrf2 dependent genes, and the dependence of the luciferase signal in the recombinant cell line on Nrf2 has been demonstrated (27). This allows quantitative measurement (by luminescence detection) of luciferase gene induction, using well established light producing luciferase substrates, as an indicator of the activity of the Nrf2 transcription factor in cells following exposure to electrophilic substances.

Test chemicals are considered positive in the KeratinoSens™ assay if they induce a statistically significant induction of the luciferase activity above a given threshold (i.e. > 1,5 fold or 50 % increase), below a defined concentration which does not significantly affect cell viability (i.e. below 1 000 µM and at a concentration at which the cellular viability is above 70 % (9) (12)). For this purpose, the maximal fold induction of the luciferase activity over solvent (negative) control (I_{max}) is determined. Furthermore, since cells are exposed to series of concentrations of the test chemicals, the concentration needed for a statistically significant induction of luciferase activity above the threshold (i.e. $EC_{1,5}$ value) should be interpolated from the dose-response curve (see paragraph 32 for calculations). Finally, parallel cytotoxicity measurements should be conducted to assess whether luciferase activity induction levels occur at sub-cytotoxic concentrations.

Prior to routine use of the ARE-Nrf2 luciferase assay that adheres to this test method, laboratories should demonstrate technical proficiency, using the ten Proficiency Substances listed in Appendix 2.

Performance standards (PS) (28) are available to facilitate the validation of new or modified *in vitro* ARE-Nrf2 luciferase test methods similar to the KeratinoSens™ assay and allow for timely amendment of this test method for their inclusion. Mutual Acceptance of Data (MAD) according to the OECD agreement will only be guaranteed for test methods validated according to the PS, if these test methods have been reviewed and included in the corresponding test guideline by OECD.

▼ M7**PROCEDURE**

Currently, the only method covered by this test method is the scientifically valid KeratinoSens™ assay (9) (12) (13) (14). The Standard Operating Procedures (SOP) for the KeratinoSens™ assay is available and should be employed when implementing and using the test method in the laboratory (15). Laboratories willing to implement the test method can obtain the recombinant cell line used in the KeratinoSens™ assay by establishing a licence agreement with the test method developer. The following paragraphs provide with a description of the main components and procedures of the ARE-Nrf2 luciferase test method.

Preparation of the keratinocyte cultures

A transgenic cell line having a stable insertion of the luciferase reporter gene under the control of the ARE-element should be used (e.g. the KeratinoSens™ cell line). Upon receipt, cells are propagated (e.g. 2 to 4 passages) and stored frozen as a homogeneous stock. Cells from this original stock can be propagated up to a maximum passage number (i.e. 25 in the case of KeratinoSens™) and are employed for routine testing using the appropriate maintenance medium (in the case of KeratinoSens™ this represents DMEM containing serum and Geneticin).

For testing, cells should be 80-90 % confluent, and care should be taken to ensure that cells are never grown to full confluence. One day prior to testing cells are harvested, and distributed into 96-well plates (10 000 cells/well in the case of KeratinoSens™). Attention should be paid to avoid sedimentation of the cells during seeding to ensure homogeneous cell number distribution across wells. If this is not the case, this step may give rise to high well-to-well variability. For each repetition, three replicates are used for the luciferase activity measurements, and one parallel replicate used for the cell viability assay.

Preparation of the test chemical and control substances

The test chemical and control substances are prepared on the day of testing. For the KeratinoSens™ assay, test chemicals are dissolved in dimethyl sulfoxide (DMSO) to the final desired concentration (e.g. 200 mM). The DMSO solutions can be considered self-sterilising, so that no sterile filtration is needed. Test chemical not soluble in DMSO is dissolved in sterile water or culture medium, and the solutions sterilised by e.g. filtration. For a test chemical which has no defined molecular weight (MW), a stock solution is prepared to a default concentration (40 mg/mL or 4 % (w/v)) in the KeratinoSens™ assay. In case solvents other than DMSO, water or the culture medium are used, sufficient scientific rationale should be provided.

Based on the stock DMSO solutions of the test chemical, serial dilutions are made using DMSO to obtain 12 master concentrations of the chemical to be tested (from 0,098 to 200 mM in the KeratinoSens™ assay). For a test chemical not soluble in DMSO, the dilutions to obtain the master concentrations are made using sterile water or sterile culture medium. Independent of the solvent used, the master concentrations, are then further diluted 25 fold into culture medium containing serum, and finally used for treatment with a further 4 fold dilution factor so that the final concentrations of the tested chemical range from 0,98 to 2 000 µM in the KeratinoSens™ assay. Alternative concentrations may be used upon justification (e.g. in case of cytotoxicity or poor solubility).

The negative (solvent) control used in the KeratinoSens™ assay is DMSO (CAS No. 67-68-5, ≥ 99 % purity), for which six wells per plate are prepared. It undergoes the same dilution as described for the master concentrations in paragraph 22, so that the final negative (solvent) control concentration is 1 %, known not to affect cell viability and corresponding to the same concentration of

▼ M7

DMSO found in the tested chemical and in the positive control. For a test chemical not soluble in DMSO, for which the dilutions were made in water, the DMSO level in all wells of the final test solution must be adjusted to 1 % as for the other test chemicals and control substances.

The positive control used in the case of the KeratinoSens™ assay is cinnamic aldehyde (CAS No. 14371-10-9, ≥ 98 % purity), for which a series of 5 master concentrations ranging from 0,4 to 6,4 mM are prepared in DMSO (from a 6,4 mM stock solution) and diluted as described for the master concentrations in paragraph 22, so that the final concentration of the positive control range from 4 to 64 µM. Other suitable positive controls, preferentially providing EC_{1,5} values in the mid-range, may be used if historical data are available to derive comparable run acceptance criteria.

Application of the test chemical and control substances

For each test chemical and positive control substance, one experiment is needed to derive a prediction (positive or negative), consisting of at least two independent repetitions containing each three replicates (i.e. n = 6). In case of discordant results between the two independent repetitions, a third repetition containing three replicates should be performed (i.e. n = 9). Each independent repetition is performed on a different day with fresh stock solution of test chemicals and independently harvested cells. Cells may come from the same passage however.

After seeding as described in paragraph 20, cells are grown for 24 hours in the 96-wells microtiter plates. The medium is then removed and replaced with fresh culture medium (150 µl culture medium containing serum but without Geneticin in the case of KeratinoSens™) to which 50 µl of the 25 fold diluted test chemical and control substances are added. At least one well per plate should be left empty (no cells and no treatment) to assess background values.

The treated plates are then incubated for about 48 hours at 37 ± 1 °C in the presence of 5 % CO₂ in the KeratinoSens™ assay. Care should be taken to avoid evaporation of volatile test chemicals and cross-contamination between wells by test chemicals by e.g. covering the plates with a foil prior to the incubation with the test chemicals.

Luciferase activity measurements

Three factors are critical to ensure appropriate luminescence readings:

- the choice of a sensitive luminometer,
- the use of a plate format with sufficient height to avoid light-cross-contamination; and
- the use of a luciferase substrate with sufficient light output to ensure sufficient sensitivity and low variability.

Prior to testing, a control experiment setup as described in Appendix 3 should be carried out to ensure that these three points are met.

After the 48 hour exposure time with the test chemical and control substances in the KeratinoSens™ assay, cells are washed with a phosphate buffered saline, and the relevant lysis buffer for luminescence readings added to each well for 20 min at room temperature.

▼ M7

Plates with the cell lysate are then placed in the luminometer for reading which in the KeratinoSens™ assay is programmed to: (i) add the luciferase substrate to each well (i.e. 50 µl), (ii) wait for 1 second, and (iii) integrate the luciferase activity for 2 seconds. In case alternative settings are used, e.g. depending on the model of luminometer used, these should be justified. Furthermore, a glow substrate may also be used provided that the quality control experiment of Appendix 3 is successfully fulfilled.

Cytotoxicity Assessment

For the KeratinoSens™ cell viability assay, medium is replaced after the 48 hour exposure time with fresh medium containing MTT (3-(4,5-Dimethylthiazol-2-yl)-2,5-diphenyltetrazolium bromide, Thiazolyl blue tetrazolium bromide; CAS No. 298-93-1) and cells incubated for 4 hours at 37 °C in the presence of 5 % CO₂. The MTT medium is then removed and cells are lysed (e.g. by adding 10 % SDS solution to each well) overnight. After shaking, the absorption is measured at i.e. 600 nm with a photometer.

DATA AND REPORTING**Data evaluation**

The following parameters are calculated in the KeratinoSens™ assay:

- the maximal average fold induction of luciferase activity (I_{\max}) value observed at any concentration of the tested chemical and positive control;
- the EC_{1,5} value representing the concentration for which induction of luciferase activity is above the 1,5 fold threshold (i.e. 50 % enhanced luciferase activity) was obtained; and
- the IC₅₀ and IC₃₀ concentration values for 50 % and 30 % reduction of cellular viability.
- Fold luciferase activity induction is calculated by Equation 1, and the overall maximal fold induction (I_{\max}) is calculated as the average of the individual repetitions.

Equation 1:

$$\text{Fold induction} = \frac{(L_{\text{sample}} - L_{\text{blank}})}{(L_{\text{solvent}} - L_{\text{blank}})}$$

where

L_{sample} is the luminescence reading in the test chemical well

L_{blank} is the luminescence reading in the blank well containing no cells and no treatment

L_{solvent} is the average luminescence reading in the wells containing cells and solvent (negative) control

EC_{1,5} is calculated by linear interpolation according to Equation 2, and the overall EC_{1,5} is calculated as the geometric mean of the individual repetitions.

Equation 2:

$$EC_{1,5} = (C_b - C_a) \times \left(\frac{1,5 - I_a}{I_b - I_a} \right) + C_a$$

▼ M7

where

C_a is the lowest concentration in μM with $> 1,5$ fold induction

C_b is the highest concentration in μM with $< 1,5$ fold induction

I_a is the fold induction measured at the lowest concentration with $> 1,5$ fold induction (mean of three replicate wells)

I_b is the fold induction at the highest concentration with $< 1,5$ fold induction (mean of three replicate wells)

Viability is calculated by Equation 3:

Equation 3:

$$Viability = \frac{(V_{sample} - V_{blank})}{V_{solvent} - V_{blank}} \times 100$$

where

V_{sample} is the MTT-absorbance reading in the test chemical well

V_{blank} is the MTT-absorbance reading in the blank well containing no cells and no treatment

$V_{solvent}$ is the average MTT-absorbance reading in the wells containing cells and solvent (negative) control

IC_{50} and IC_{30} are calculated by linear interpolation according to Equation 4, and the overall IC_{50} and IC_{30} are calculated as the geometric mean of the individual repetitions.

Equation 4:

$$IC_x = (C_b - C_a) \times \left(\frac{(100 - x) - V_a}{V_b - V_a} \right) + C_a$$

where

X is the % reduction at the concentration to be calculated (50 and 30 for IC_{50} and IC_{30})

C_a is the lowest concentration in μM with $> x$ % reduction in viability

C_b is the highest concentration in μM with $< x$ % reduction in viability

V_a is the % viability at the lowest concentration with $> x$ % reduction in viability

V_b is the % viability at the highest concentration with $< x$ % reduction in viability

For each concentration showing $> 1,5$ fold luciferase activity induction, statistical significance is calculated (e.g. by a two-tailed Student's t-test), comparing the luminescence values for the three replicate samples with the luminescence values in the solvent (negative) control wells to determine whether the luciferase activity induction is statistically significant ($p < 0,05$). The lowest concentration with $> 1,5$ fold luciferase activity induction is the value determining the $EC_{1,5}$ value. It is checked in each case whether this value is below the IC_{30} value, indicating that there is less than 30 % reduction in cellular viability at the $EC_{1,5}$ determining concentration.

▼ M7

It is recommended that data are visually checked with the help of graphs. If no clear dose-response curve is observed, or if the dose-response curve obtained is biphasic (i.e. crossing the threshold of 1,5 twice), the experiment should be repeated to verify whether this is specific to the test chemical or due to an experimental artefact. In case the biphasic response is reproducible in an independent experiment, the lower $EC_{1,5}$ value (the concentration when the threshold of 1,5 is crossed the first time) should be reported.

In the rare cases where a statistically non-significant induction above 1,5 fold is observed followed by a higher concentration with a statistically significant induction, results from this repetition are only considered as valid and positive if the statistically significant induction above the threshold of 1,5 was obtained for a non-cytotoxic concentration.

Finally, for test chemicals generating a 1,5 fold or higher induction already at the lowest test concentration of 0,98 μM , the $EC_{1,5}$ value of $< 0,98$ is set based on visual inspection of the dose-response curve.

Acceptance criteria

The following acceptance criteria should be met when using the KeratinoSensTM assay. First, the luciferase activity induction obtained with the positive control, cinnamic aldehyde, should be statistically significant above the threshold of 1,5 (e.g. using a T-test) in at least one of the tested concentrations (from 4 to 64 μM).

Second, the $EC_{1,5}$ value should be within two standard deviations of the historical mean of the testing facility (e.g. between 7 μM and 30 μM based on the validation dataset) which should be regularly updated. In addition, the average induction in the three replicates for cinnamic aldehyde at 64 μM should be between 2 and 8. If the latter criterion is not fulfilled, the dose-response of cinnamic aldehyde should be carefully checked, and tests may be accepted only if there is a clear dose-response with increasing luciferase activity induction at increasing concentrations for the positive control.

Finally, the average coefficient of variation of the luminescence reading for the negative (solvent) control DMSO should be below 20 % in each repetition which consists of 6 wells tested in triplicate. If the variability is higher, results should be discarded.

Interpretation of results and prediction model

A KeratinoSensTM prediction is considered positive if the following 4 conditions are all met in 2 of 2 or in the same 2 of 3 repetitions, otherwise the KeratinoSensTM prediction is considered negative (Figure 1):

1. the I_{max} is higher than ($>$) 1,5 fold and statistically significantly different as compared to the solvent (negative) control (as determined by a two-tailed, unpaired Student's t-test);
2. the cellular viability is higher than ($>$) 70 % at the lowest concentration with induction of luciferase activity above 1,5 fold (i.e. at the $EC_{1,5}$ determining concentration);
3. the $EC_{1,5}$ value is less than ($<$) 1 000 μM (or $<$ 200 $\mu\text{g/ml}$ for test chemicals with no defined MW);
4. there is an apparent overall dose-response for luciferase induction (or a biphasic response as mentioned under paragraph 33).

▼ **M7**

If in a given repetition, all of the three first conditions are met but a clear dose-response for the luciferase induction cannot be observed, then the result of that repetition should be considered inconclusive and further testing may be required (Figure 1). In addition, a negative result obtained with concentrations $< 1\,000\ \mu\text{M}$ (or $< 200\ \mu\text{g/ml}$ for test chemicals with no defined MW) should also be considered as inconclusive (see paragraph 11).

Figure 1

Prediction model used in the KeratinoSens™ assay. A KeratinoSens™ prediction should be considered in the framework of an IATA and in accordance with the provision of paragraphs 9 and 11

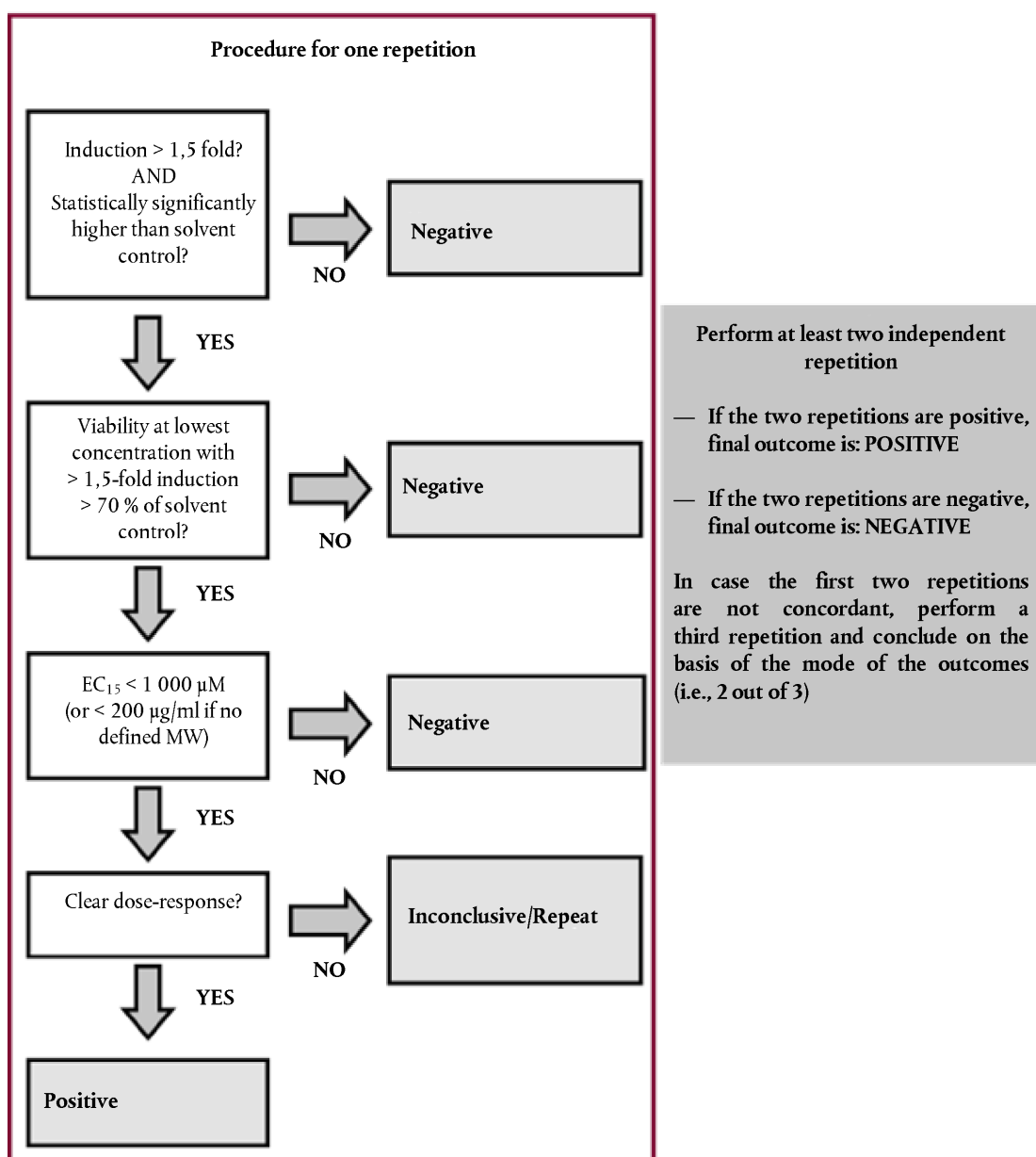

In rare cases, test chemicals which induce the luciferase activity very close to the cytotoxic levels can be positive in some repetitions at non-cytotoxic levels (i.e. $EC_{1,5}$ determining concentration below ($<$) the IC_{30}), and in other repetitions only at cytotoxic levels (i.e. $EC_{1,5}$ determining concentration above ($>$) the IC_{30}). Such

▼M7

test chemicals shall be retested with more narrow dose-response analysis using a lower dilution factor (e.g. 1,33 or $\sqrt{2}$ (= 1,41) fold dilution between wells), to determine if induction has occurred at cytotoxic levels or not (9).

Test report

The test report should include the following information:

Test chemical

- Mono-constituent substance
 - Chemical identification, such as IUPAC or CAS name(s), CAS number(s), SMILES or InChI code, structural formula, and/or other identifiers;
 - Physical appearance, water solubility, DMSO solubility, molecular weight, and additional relevant physicochemical properties, to the extent available;
 - Purity, chemical identity of impurities as appropriate and practically feasible, etc;
 - Treatment prior to testing, if applicable (e.g. warming, grinding);
 - Concentration(s) tested;
 - Storage conditions and stability to the extent available.
- Multi-constituent substance, UVCB and mixture:
 - Characterisation as far as possible by e.g. chemical identity (see above), purity, quantitative occurrence and relevant physicochemical properties (see above) of the constituents, to the extent available;
 - Physical appearance, water solubility, DMSO solubility and additional relevant physicochemical properties, to the extent available;
 - Molecular weight or apparent molecular weight in case of mixtures/polymers of known compositions or other information relevant for the conduct of the study;
 - Treatment prior to testing, if applicable (e.g. warming, grinding);
 - Concentration(s) tested;
 - Storage conditions and stability to the extent available.

Controls

- Positive control
 - Chemical identification, such as IUPAC or CAS name(s), CAS number(s), SMILES or InChI code, structural formula, and/or other identifiers;
 - Physical appearance, water solubility, DMSO solubility, molecular weight, and additional relevant physicochemical properties, to the extent available and where applicable;
 - Purity, chemical identity of impurities as appropriate and practically feasible, etc;
 - Treatment prior to testing, if applicable (e.g. warming, grinding);
 - Concentration(s) tested;
 - Storage conditions and stability to the extent available;

▼ M7

- Reference to historical positive control results demonstrating suitable run acceptance criteria, if applicable.
- Negative (vehicle) control
 - Chemical identification, such as IUPAC or CAS name(s), CAS number(s), and/or other identifiers;
 - Purity, chemical identity of impurities as appropriate and practically feasible, etc;
 - Physical appearance, molecular weight, and additional relevant physico-chemical properties in the case other negative controls / vehicles than those mentioned in this test method are used and to the extent available;
 - Storage conditions and stability to the extent available;
 - Justification for choice of solvent for each test chemical.

Test method conditions

- Name and address of the sponsor, test facility and study director;
- Description of test method used;
- Cell line used, its storage conditions and source (e.g. the facility from which they were obtained);
- Passage number and level of confluence of cells used for testing;
- Cell counting method used for seeding prior to testing and measures taken to ensure homogeneous cell number distribution (cf. paragraph 20);
- Luminometer used (e.g. model), including instrument settings, luciferase substrate used, and demonstration of appropriate luminescence measurements based on the control test described in Appendix 3;
- The procedure used to demonstrate proficiency of the laboratory in performing the test method (e.g. by testing of proficiency substances) or to demonstrate reproducible performance of the test method over time.

Test procedure

- Number of repetitions and replicates used;
- Test chemical concentrations, application procedure and exposure time used (if different than the one recommended)
- Description of evaluation and decision criteria used;
- Description of study acceptance criteria used;
- Description of any modifications of the test procedure.

Results

- Tabulation of I_{\max} , $EC_{1,5}$ and viability values (i.e. IC_{50} , IC_{30}) obtained for the test chemical and for the positive control for each repetition as well as the mean values (I_{\max} : average; $EC_{1,5}$ and viability values: geometric mean) and SD calculated using data from all individual repetitions and an indication of the rating of the test chemical according to the prediction model;

▼M7

- Coefficient of variation obtained with the luminescence readings for the negative control for each experiment;
- A graph depicting dose-response curves for induction of luciferase activity and viability;
- Description of any other relevant observations, if applicable.

Discussion of the results

- Discussion of the results obtained with the KeratinoSensTM assay;
- Consideration of the test method results within the context of an IATA, if other relevant information is available.

Conclusion

LITERATURE:

- (1) United Nations (UN) (2013). Globally Harmonized System of Classification and Labelling of Chemicals (GHS), Fifth revised edition, UN New York and Geneva, 2013. Available at: http://www.unece.org/trans/danger/publi/ghs/ghs_rev05/05files_e.html.
- (2) OECD (2012). The Adverse Outcome Pathway for Skin Sensitisation Initiated by Covalent Binding to Proteins. Part 1: Scientific Evidence. OECD Environment, Health and Safety publications, Series on Testing and Assessment No. 168. OECD, Paris.
- (3) Adler S., Basketter D., Creton S., Pelkonen O., van Benthem J., Zuang V., Andersen K.E., Angers-Loustau A., Aptula A., Bal-Price A., Benfenati E., Bernauer U., Bessems J., Bois F.Y., Boobis A., Brandon E., Bremer S., Broschard T., Casati S., Coecke S., Corvi R., Cronin M., Daston G., Dekant W., Felter S., Grignard E., Gundert-Remy U., Heinonen T., Kimber I., Kleinjans J., Komulainen H., Kreiling R., Kreysa J., Leite S.B., Loizou G., Maxwell G., Mazzatorta P., Munn S., Pfuhler S., Phrakonkham P., Piersma A., Poth A., Prieto P., Repetto G., Rogiers V., Schoeters G., Schwarz M., Serafimova R., Tähti H., Testai E., van Delft J., van Loveren H., Vinken M., Worth A., Zaldivar J.M. (2011). Alternative (non-animal) methods for cosmetics testing: current status and future prospects-2010. *Archives of Toxicology* 85, 367-485.
- (4) Chapter B.42 of this Annex: Skin sensitization: Local Lymph Node assay.
- (5) Chapter B.6 of this Annex: Skin Sensitisation.
- (6) Chapter B.50 of this Annex: Skin sensitization: Local Lymph Node assay: DA.
- (7) Chapter B.51 of this Annex: Skin sensitization: Local Lymph Node assay: BrdU-ELISA.
- (8) Natsch A. (2010). The Nrf2-Keap1-ARE Toxicity Pathway as a Cellular Sensor for Skin Sensitizers-Functional Relevance and Hypothesis on Innate Reactions to Skin Sensitizers. *Toxicological Sciences* 113, 284-292.
- (9) Emter R., Ellis G., Natsch A. (2010). Performance of a novel keratinocyte-based reporter cell line to screen skin sensitizers *in vitro*. *Toxicology and Applied Pharmacology* 245, 281-290.
- (10) Dinkova-Kostova A.T., Holtzclaw W.D., Kensler T.W. (2005). The role of Keap1 in cellular protective responses. *Chem. Res. Toxicol.* 18, 1779-1791.

▼ M7

- (11) Kansanen E., Kuosmanen S.M., Leinonen H., Levonen A.L. (2013). The Keap1-Nrf2 pathway: Mechanisms of activation and dysregulation in cancer. *Redox Biol.* 1(1), 45-49.
- (12) Natsch A., Bauch C., Foertsch L., Gerberick F., Normann K., Hilberer A., Inglis H., Landsiedel R., Onken S., Reuter H., Schepky A., Emter R. (2011). The intra- and inter-laboratory reproducibility and predictivity of the KeratinoSens assay to predict skin sensitizers *in vitro*: results of a ring-study in five laboratories. *Toxicol. In Vitro* 25, 733-744.
- (13) Natsch A., Ryan C.A., Foertsch L., Emter R., Jaworska J., Gerberick G.F., Kern P. (2013). A dataset on 145 chemicals tested in alternative assays for skin sensitization undergoing prevalidation. *Journal of Applied Toxicology*, 33, 1337-1352.
- (14) EURL-ECVAM (2014). Recommendation on the KeratinoSens™ assay for skin sensitisation testing, 42 pp. Available at: http://ihcp.jrc.ec.europa.eu/our_labs/eurl-ecvam/eurl-ecvam-recommendations/recommendation-keratinosens-skin-sensitisation.
- (15) DB-ALM (INVITTOX) (2013) Protocol 155: KeratinoSens™, 17 pp. Available: <http://ecvam-dbalm.jrc.ec.europa.eu/beta/index.cfm/methodsAndProtocols/index>
- (16) Natsch A., Emter R., Ellis G. (2009). Filling the concept with data: integrating data from different *in vitro* and *in silico* assays on skin sensitizers to explore the battery approach for animal-free skin sensitization testing. *Toxicol. Sci.* 107, 106-121.
- (17) Ball N., Cagen S., Carrillo J.C., Certa H., Eigler D., Emter R., Faulhammer F., Garcia C., Graham C., Haux C., Kolle S.N., Kreiling R., Natsch A., Mehling A. (2011). Evaluating the sensitization potential of surfactants: integrating data from the local lymph node assay, guinea pig maximization test, and *in vitro* methods in a weight-of-evidence approach. *Regul. Toxicol. Pharmacol.* 60, 389-400.
- (18) Bauch C., Kolle S.N., Ramirez T., Eltze T., Fabian E., Mehling A., Teubner W., van Ravenzwaay B., Landsiedel R. (2012). Putting the parts together: combining *in vitro* methods to test for skin sensitizing potentials. *Regul. Toxicol. Pharmacol.* 63, 489-504.
- (19) Jaworska J., Dancik Y., Kern P., Gerberick F., Natsch A. (2013). Bayesian integrated testing strategy to assess skin sensitization potency: from theory to practice. *J Appl Toxicol.* 33, 1353-1364.
- (20) Andres E., Sa-Rocha V.M., Barrichello C., Haupt T., Ellis G., Natsch A. (2013). The sensitivity of the KeratinoSens™ assay to evaluate plant extracts: A pilot study. *Toxicology In Vitro* 27, 1220-1225.
- (21) Fabian E., Vogel D., Blatz V., Ramirez T., Kolle S., Eltze T., van Ravenzwaay B., Oesch F., Landsiedel R. (2013). Xenobiotic metabolizing enzyme activities in cells used for testing skin sensitization *in vitro*. *Arch. Toxicol.* 87, 1683-1969.
- (22) Thorne N., Inglese J., Auld D.S. (2010). Illuminating Insights into Firefly Luciferase and Other Bioluminescent Reporters Used in Chemical Biology. *Chemistry and Biology* 17, 646-657.
- (23) OECD (2012). BG1Luc Estrogen Receptor Transactivation Test Method for Identifying Estrogen Receptor Agonists and Antagonists. OECD Guidelines for Chemical Testing No. 457. OECD, Paris.
- (24) ECETOC (2003). Contact sensitization: Classification according to potency. European Centre for Ecotoxicology & Toxicology of Chemicals (Technical Report No. 87).
- (25) Gildea L.A., Ryan C.A., Foertsch L.M., Kennedy J.M., Dearman R.J., Kimber I., Gerberick G.F. (2006). Identification of gene expression changes induced by chemical allergens in dendritic cells: opportunities for skin sensitization testing. *J. Invest. Dermatol.*, 126, 1813-1822.

▼ M7

- (26) Ryan C.A., Gildea L.A., Hulette B.C., Dearman R.J., Kimber I., Gerberick G.F. (2004). Gene expressing changes in peripheral blood-derived dendritic cells following exposure to a contact allergen. *Toxicol. Lett.* 150, 301-316.
- (27) Emter R., van der Veen J.W., Adamson G., Ezendam J., van Loveren H., Natsch A. (2013). Gene expression changes induced by skin sensitizers in the KeratinoSens™ cell line: Discriminating Nrf2-dependent and Nrf2-independent events. *Toxicol. in vitro* 27, 2225-2232.
- (28) OECD (2015). Performance Standards for assessment of proposed similar or modified *in vitro* skin sensitisation ARE-Nrf2 luciferase test methods. OECD Environment, Health and Safety publications, Series on Testing and Assessment N0 213, OECD, Paris.
- (29) OECD (2005). Guidance Document on the Validation and International Acceptance of New or Updated Test Methods for Hazard Assessment. OECD Environment, Health and Safety publications, Series on Testing and Assessment No.34. OECD, Paris, France.
- (30) NAFTA (North American Free Trade Agreement) (2012). Technical Working Group on Pesticides — (Quantitative) Structure Activity Relationship ((Q)SAR) Guidance Document. 186 pp. <http://www.epa.gov/oppfead1/international/naftatwg/guidance/qsar-guidance.pdf>

▼ M7

Appendix 1

DEFINITIONS

Accuracy: The closeness of agreement between test method results and accepted reference values. It is a measure of test method performance and one aspect of 'relevance'. The term is often used interchangeably with 'concordance', to mean the proportion of correct outcomes of a test method (29).

AOP (Adverse Outcome Pathway): Sequence of events from the chemical structure of a target chemical or group of similar chemicals through the molecular initiating event to an *in vivo* outcome of interest (2).

ARE: Antioxidant response element (also called EpRE, electrophile response element), is a response element found in the upstream promoter region of many cytoprotective and phase II genes. When activated by Nrf2, it mediates the transcriptional induction of these genes.

Chemical: A substance or a mixture.

Coefficient of variation: A measure of variability that is calculated for a group of replicate data by dividing the standard deviation by the mean. It can be multiplied by 100 for expression as a percentage.

EC_{1,5}: Interpolated concentration for a 1,5 fold luciferase induction.

IC₃₀: Concentration effecting a reduction of cellular viability by 30 %.

IC₅₀: Concentration effecting a reduction of cellular viability by 50 %.

Hazard: Inherent property of an agent or situation having the potential to cause adverse effects when an organism, system or (sub) population is exposed to that agent.

IATA (Integrated Approach to Testing and Assessment): A structured approach used for hazard identification (potential), hazard characterisation (potency) and/or safety assessment (potential/potency and exposure) of a chemical or group of chemicals, which strategically integrates and weights all relevant data to inform regulatory decision regarding potential hazard and/or risk and/or the need for further targeted and therefore minimal testing.

I_{max}: Maximal induction factor of luciferase activity compared to the solvent (negative) control measured at any test chemical concentration.

Keap1: Kelch-like ECH-associated protein 1, is a sensor protein that can regulate the Nrf2 activity. Under un-induced conditions the Keap1 sensor protein targets the Nrf2 transcription factor for ubiquitinylation and proteolytic degradation in the proteasome. Covalent modification of the reactive cysteine residues of Keap 1 by small molecules can lead to dissociation of Nrf2 from Keap1 (8) (10) (11).

▼ M7

Mixture: A mixture or a solution composed of two or more substances in which they do not react (1).

Mono-constituent substance: A substance, defined by its quantitative composition, in which one main constituent is present to at least 80 % (w/w).

Multi-constituent substance: A substance, defined by its quantitative composition, in which more than one main constituent is present in a concentration ≥ 10 % (w/w) and < 80 % (w/w). A multi-constituent substance is the result of a manufacturing process. The difference between mixture and multi-constituent substance is that a mixture is obtained by blending of two or more substances without chemical reaction. A multi-constituent substance is the result of a chemical reaction.

Nrf2: Nuclear factor (erythroid-derived 2)-like 2, is a transcription factor involved in the antioxidant response pathway. When Nrf2 is not ubiquitinated, it builds up in the cytoplasm and translocates into the nucleus, where it combines to the ARE in the upstream promoter region of many cytoprotective genes, initiating their transcription (8) (10) (11).

Positive control: A replicate containing all components of a test system and treated with a substance known to induce a positive response. To ensure that variability in the positive control response across time can be assessed, the magnitude of the positive response should not be excessive.

Relevance: Description of relationship of the test to the effect of interest and whether it is meaningful and useful for a particular purpose. It is the extent to which the test correctly measures or predicts the biological effect of interest. Relevance incorporates consideration of the accuracy (concordance) of a test method (29).

Reliability: Measures of the extent that a test method can be performed reproducibly within and between laboratories over time, when performed using the same protocol. It is assessed by calculating intra- and inter-laboratory reproducibility and intra-laboratory repeatability (29).

Reproducibility: The agreement among results obtained from testing the same chemical using the same test protocol (see reliability) (29).

Sensitivity: The proportion of all positive / active chemicals that are correctly classified by the test method. It is a measure of accuracy for a test method that produces categorical results, and is an important consideration in assessing the relevance of a test method (29).

Solvent/vehicle control: A replicate containing all components of a test system except of the test chemical, but including the solvent that is used. It is used to establish the baseline response for the samples treated with the test chemical dissolved in the same solvent.

Specificity: The proportion of all negative / inactive chemicals that are correctly classified by the test method. It is a measure of accuracy for a test method that produces categorical results and is an important consideration in assessing the relevance of a test method (29).

Substance: Chemical elements and their compounds in the natural state or obtained by any production process, including any additive necessary to preserve the stability of the product and any impurities deriving from the process used, but excluding any solvent which may be separated without affecting the stability of the substance or changing its composition (1).

Test chemical: The term 'test chemical' is used to refer to what is being tested.

▼ M7

United Nations Globally Harmonized System of Classification and Labelling of Chemicals (UN GHS): A system proposing the classification of chemicals (substances and mixtures) according to standardised types and levels of physical, health and environmental hazards, and addressing corresponding communication elements, such as pictograms, signal words, hazard statements, precautionary statements and safety data sheets, so that to convey information on their adverse effects with a view to protect people (including employers, workers, transporters, consumers and emergency responders) and the environment (1).

UVCB: Substances of unknown or variable composition, complex reaction products or biological materials.

Valid test method: A test method considered to have sufficient relevance and reliability for a specific purpose and which is based on scientifically sound principles. A test method is never valid in an absolute sense, but only in relation to a defined purpose (29).

▼ **M7**

Appendix 2

PROFICIENCY SUBSTANCES***In Vitro* Skin Sensitisation: ARE-Nrf2 Luciferase Test Method**

Prior to routine use of this test method, laboratories should demonstrate technical proficiency by correctly obtaining the expected KeratinoSens™ prediction for the 10 Proficiency Substances recommended in Table 1 and by obtaining the EC_{1,5} and IC₅₀ values that fall within the respective reference range for at least 8 out of the 10 proficiency substances. These Proficiency Substances were selected to represent the range of responses for skin sensitisation hazards. Other selection criteria were commercial availability, availability of high quality *in vivo* reference, and availability of high quality *in vitro* data from the KeratinoSens™ assay.

Table 1

Recommended substances for demonstrating technical proficiency with the KeratinoSens™ assay

Proficiency Substances	CASRN	Physical Form	<i>In Vivo</i> Prediction ⁽¹⁾	Keratino-Sens™ Prediction ⁽²⁾	EC _{1,5} (µM) Reference Range ⁽³⁾	IC ₅₀ (µM) Reference Range ⁽³⁾
Isopropanol	67-63-0	Liquid	Non-sensitiser	Negative	> 1 000	> 1 000
Salicylic acid	69-72-7	Solid	Non-sensitiser	Negative	> 1 000	> 1 000
Lactic acid	50-21-5	Liquid	Non-sensitiser	Negative	> 1 000	> 1 000
Glycerol	56-81-5	Liquid	Non-sensitiser	Negative	> 1 000	> 1 000
Cinnamyl alcohol	104-54-1	Solid	Sensitiser (weak)	Positive	25 - 175	> 1 000
Ethylene glycol dimethacrylate	97-90-5	Liquid	Sensitiser (weak)	Positive	5 - 125	> 500
2-Mercaptobenzothiazole	149-30-4	Solid	Sensitiser (moderate)	Positive	25 - 250	> 500
Methyldibromo glutaronitrile	35691-65-7	Solid	Sensitiser (strong)	Positive	< 20	20 - 100
4-Methylaminophenol sulfate	55-55-0	Solid	Sensitiser (strong)	Positive	< 12,5	20 - 200
2,4-Dinitro-chlorobenzene	97-00-7	Solid	Sensitiser (extreme)	Positive	< 12,5	5 - 20

⁽¹⁾ The *in vivo* hazard (and potency) predictions are based on LLNA data (13). The *in vivo* potency is derived using the criteria proposed by ECETOC (24).

⁽²⁾ A KeratinoSens™ prediction should be considered in the framework of an IATA and in accordance with the provisions of paragraphs 9 and 11 of this test method.

⁽³⁾ Based on the historical observed values (12).

▼ **M7***Appendix 3***QUALITY CONTROL OF LUMINESCENCE MEASUREMENTS****Basic experiment for ensuring optimal luminescence measurements in the KeratinoSens™ assay**

The following three parameters are critical to ensure obtaining reliable results with the luminometer:

- having a sufficient sensitivity giving a stable background in control wells;
- having no gradient over the plate due to long reading times; and
- having no light contamination in adjacent wells from strongly active wells.

Prior to testing it is recommended to ensure having appropriate luminescence measurements, by testing a control plate set-up as described below (triplicate analysis).

Plate setup of first training experiment

	1	2	3	4	5	6	7	8	9	10	11	12
A	DMSO	DMSO	DMSO	DMSO	DMSO	DMSO	DMSO	DMSO	DMSO	DMSO	DMSO	DMSO
B	DMSO	DMSO	DMSO	DMSO	DMSO	DMSO	DMSO	DMSO	DMSO	DMSO	DMSO	DMSO
C	DMSO	DMSO	DMSO	DMSO	DMSO	DMSO	DMSO	DMSO	DMSO	DMSO	DMSO	DMSO
D	EGDMA 0,98	EGDMA 1,95	EGDMA 3,9	EGDMA 7,8	EGDMA 15,6	EGDMA 31,25	EGDMA 62,5	EGDMA 125	EGDMA 250	EGDMA 500	EGDMA 1000	EGDMA 2000
E	DMSO	DMSO	DMSO	DMSO	DMSO	DMSO	DMSO	DMSO	DMSO	DMSO	DMSO	DMSO
F	DMSO	DMSO	DMSO	DMSO	DMSO	DMSO	DMSO	DMSO	DMSO	DMSO	DMSO	DMSO
G	DMSO	DMSO	DMSO	DMSO	DMSO	DMSO	DMSO	DMSO	DMSO	DMSO	DMSO	DMSO
H	DMSO	DMSO	DMSO	DMSO	DMSO	DMSO	CA 4	CA 8	CA 16	CA 32	CA 64	Blank

EGDMA = Ethylene glycol dimethacrylate (CAS No.: 97-90-5) a strongly inducing chemical

CA = Cinnamic aldehyde, positive reference (CAS No.: 104-55-2)

The quality control analysis should demonstrate:

- a clear dose-response in row D, with the $I_{\max} > 20$ fold above background (in most cases I_{\max} values between 100 and 300 are reached);
- no dose-response in row C and E (no induction value above 1,5 (ideally not above 1,3) due to possible light contamination especially next to strongly active wells in the EGDMA row);
- no statistically significant difference between the rows A, B, C, E, F and G. (i.e. no gradient over plate); and
- variability in any of the rows A, B, C, E, F and G and in the DMSO wells in row H should be below 20 % (i.e. stable background).

▼ M7**B.61. FLUORESCHEIN LEAKAGE TEST METHOD FOR IDENTIFYING OCULAR CORROSIVES AND SEVERE IRRITANTS**

INTRODUCTION

This test method (TM) is equivalent to OECD test guideline (TG) 460 (2012). The Fluorescein Leakage (FL) test method is an *in vitro* test method that can be used under certain circumstances and with specific limitations to classify chemicals (substances and mixtures) as ocular corrosives and severe irritants, as defined by the United Nations (UN) Globally Harmonized System of Classification and Labelling of Chemicals (GHS) (Category 1), Regulation (EC) No 1272/2008 on Classification, Labelling and Packaging of Substances and Mixtures (CLP)⁽¹⁾ (Category 1), and the U.S. Environmental Protection Agency (EPA) (Category I) (1)(2). For the purpose of this test method, severe ocular irritants are defined as chemicals that cause tissue damage in the eye following test chemical administration that is not reversible within 21 days or causes serious physical decay of vision, while ocular corrosives are chemicals that cause irreversible tissue damage to the eye. These chemicals are classified as UN GHS Category 1, EU CLP Category 1, or U.S. EPA Category I.

While the FL test method is not considered valid as a complete replacement for the *in vivo* rabbit eye test, the FL is recommended for use as part of a tiered testing strategy for regulatory classification and labelling. Thus, the FL is recommended as an initial step within a Top-Down approach to identify ocular corrosives/severe irritants, specifically for limited types of chemicals (*i.e.* water soluble substances and mixtures) (3)(4).

It is currently generally accepted that, in the foreseeable future, no single *in vitro* eye irritation test will be able to replace the *in vivo* eye test (TM B.5 (5)) to predict across the full range of irritation for different chemical classes. However, strategic combinations of several alternative test methods within a (tiered) testing strategy may be able to replace the *in vivo* eye test (4). The Top-Down approach (4) is designed to be used when, based on existing information, a chemical is expected to have high irritancy potential.

Based on the prediction model detailed in paragraph 35, the FL test method can identify chemicals within a limited applicability domain as ocular corrosives/severe irritants (UN GHS Category 1; EU CLP Category 1; U.S. EPA Category I) without any further testing. The same is assumed for mixtures although mixtures were not used in the validation. Therefore, the FL test method may be used to determine the eye irritancy/corrosivity of chemicals, following the sequential testing strategy of TM B.5 (5). However, a chemical that is not predicted as ocular corrosive or severe irritant with the FL test method would need to be tested in one or more additional test methods (*in vitro* and/or *in vivo*) that are capable of accurately identifying i) chemicals that are *in vitro* false negative ocular corrosives/severe irritants in the FL (UN GHS Category 1; EU CLP Category 1; U.S. EPA Category I); ii) chemicals that are not classified for eye corrosion/irritation (UN GHS No Category; EU CLP No Category; U.S. EPA

⁽¹⁾ Regulation (EC) No 1272/2008 of the European Parliament and of the Council of 16 December 2008 on classification, labelling and packaging of substances and mixtures, amending and repealing Directives 67/548/EEC and 1999/45/EC, and amending Regulation (EC) No 1907/2006, OJ L 353, 31.12.2008, p. 1.

▼M7

Category IV); and/or iii) chemicals that are moderate/mild eye irritants (UN GHS Categories 2A and 2B; EU CLP Category 2; U.S. EPA Categories II and III).

The purpose of this test method is to describe the procedures used to evaluate the potential ocular corrosivity or severe irritancy of a test chemical as measured by its ability to induce damage to an impermeable confluent epithelial monolayer. The integrity of trans-epithelial permeability is a major function of an epithelium such as that found in the conjunctiva and the cornea. Trans-epithelial permeability is controlled by various tight junctions. Increasing the permeability of the corneal epithelium *in vivo* has been shown to correlate with the level of inflammation and surface damage observed as eye irritation develops.

In the FL test method, toxic effects after a short exposure time to the test chemical are measured by an increase in permeability of sodium fluorescein through the epithelial monolayer of Madin-Darby Canine Kidney (MDCK) cells cultured on permeable inserts. The amount of fluorescein leakage that occurs is proportional to the chemical-induced damage to the tight junctions, desmosomal junctions and cell membranes, and can be used to estimate the ocular toxicity potential of a test chemical. Appendix 1 provides a diagram of MDCK cells grown on an insert membrane for the FL test method.

Definitions are provided in Appendix 2.

INITIAL CONSIDERATIONS AND LIMITATIONS

This test method is based on the INVITTOX protocol No. 71 (6) that has been evaluated in an international validation study by the European Centre for the Validation of Alternative Methods (ECVAM), in collaboration with the US Inter-agency Coordinating Committee on the Validation of Alternative Methods (ICCVAM) and the Japanese Center for the Validation of Alternative Methods (JaCVAM).

The FL test method is not recommended for the identification of chemicals which should be classified as mild/moderate irritants or of chemicals which should not be classified for ocular irritation (substances and mixtures) (i.e. GHS Cat. 2A/2B, no category; EU CLP Cat. 2, no category; US EPA Cat. II/III/IV), as demonstrated by the validation study (3) (7).

The test method is only applicable to water soluble chemicals (substances and mixtures). The ocular severe irritation potential of chemicals that are water soluble and/or where the toxic effect is not affected by dilution is generally predicted accurately using the FL test method (7). To categorise a chemical as water soluble, under experimental conditions, it should be soluble in sterile calcium-containing (at a concentration of 1,0-1,8 mM), phenol red-free, Hanks' Balanced Salt Solution (HBSS) at a concentration ≥ 250 mg/ml (one dose above the cut-off of 100 mg/ml). However, if the test chemical is soluble below the concentration 100 mg/ml, but already induces a FL induction of 20 % at that concentration (meaning $FL_{20} < 100$ mg/ml), it can still be classified as GHS Cat. 1 or EPA Cat. I.

The identified limitations for this test method exclude strong acids and bases, cell fixatives and highly volatile chemicals from the applicability domain. These chemicals have mechanisms that are not measured by the FL test method, e.g.

▼ M7

extensive coagulation, saponification or specific reactive chemistries. Other identified limitations for this method are based upon the results for the predictive capacity for coloured and viscous test chemical (7). It is suggested that both types of chemicals are difficult to remove from the monolayer following the short exposure period and that predictivity of the test method could be improved if a higher number of washing steps was used. Solid chemicals suspended in liquid have the propensity to precipitate out and the final concentration to cells can be difficult to determine. When chemicals within these chemical and physical classes are excluded from the database, the accuracy of FL across the EU, EPA, and GHS classification systems is substantially improved (7).

Based on the purpose of this test method (*i.e.* to identify ocular corrosives/severe irritants only), false negative rates (see Paragraph 13) are not critical since such chemicals would be subsequently tested with other adequately validated *in vitro* tests or in rabbits, depending on regulatory requirements, using a sequential testing strategy in a weight of evidence approach (5) (see also paragraphs 3 and 4).

Other identified limitations of the FL test method are based on false negative and false positive rates. When used as an initial step within a Top-Down approach to identify water soluble ocular corrosive/severe irritant substances and mixtures (UN GHS Category 1; EU CLP Category 1; U.S. EPA Category I), the false positive rate for the FL test method ranged from 7 % (7/103; UN GHS and EU CLP) to 9 % (9/99; U.S. EPA) and the false negative rate ranged from 54 % (15/28; U.S. EPA) to 56 % (27/48; UN GHS and EU CLP) when compared to *in vivo* results. Chemical groups showing false positive and/or false negative results in the FL test method are not defined here.

Certain technical limitations are specific to the MDCK cell culture. The tight junctions that block the passage of the sodium-fluorescein dye through the monolayer are increasingly compromised with increasing cell passage number. Incomplete formation of the tight junctions results in increased FL in the non-treated control. Therefore, a defined permissible maximal leakage in the non-treated controls is important (see paragraph 38: 0 % leakage). As with all *in vitro* assays there is the potential for the cells to become transformed over time, thus it is vital that passage number ranges for the assays are stated.

The current applicability domain might be increased in some cases, but only after analysing an expanded data set of studied test chemicals, preferably acquired through testing (3). This test method will be updated accordingly as new information and data are considered.

For any laboratory initially establishing this assay, the proficiency chemicals provided in Appendix 3 should be used. Laboratories can use these chemicals to demonstrate their technical competence in performing the FL test method prior to submitting FL assay data for regulatory hazard classification purposes.

PRINCIPLE OF THE TEST

The FL test method is a cytotoxicity and cell-function based *in vitro* assay that is performed on a confluent monolayer of MDCK CB997 tubular epithelial cells that are grown on semi-permeable inserts and model the non-proliferating state of the *in vivo* corneal epithelium. The MDCK cell line is well established and forms tight junctions and desmosomal junctions similar to those found on the apical side of conjunctival and corneal epithelia. Tight and desmosomal junctions *in vivo* prevent solutes and foreign materials penetrating the corneal epithelium. Loss of trans-epithelial impermeability, due to damaged tight junctions and desmosomal junctions, is one of the early events in chemical-induced ocular irritation.

▼ M7

The test chemical is applied to the confluent layer of cells grown on the apical side of the insert. A short 1 min exposure is routinely used to reflect the normal clearance rate in human exposures. An advantage of the short exposure period is that water-based substances and mixtures can be tested neat, if they can be easily removed after the exposure period. This allows more direct comparisons of the results with the chemical effects in humans. The test chemical is then removed and the non-toxic, highly fluorescent sodium-fluorescein dye is added to the apical side of the monolayer for 30 minutes. The damage caused by the test chemical to the tight junctions is determined by the amount of fluorescein which leaks through the cell layer within a defined period of time.

The amount of sodium-fluorescein dye that passes through the monolayer and the insert membrane into a set volume of solution present in the well (to which the sodium-fluorescein dye leaks in) is determined by measuring spectrofluorometrically the fluorescein concentration in the well. The amount of fluorescein leakage (FL) is calculated with reference to fluorescence intensity (FI) readings from two controls: a blank control, and a maximum leakage control. The percentage of leakage and therefore amount of damage to the tight junctions is expressed, relative to these controls, for each of the set concentrations of the test chemical. Then the FL₂₀ (*i.e.* concentration that causes 20 % FL relative to the value recorded for the untreated confluent monolayer and inserts without cells), is calculated. The FL₂₀ (mg/ml) value is used in the prediction model for identification of ocular corrosives and severe irritants (see paragraph 35).

Recovery is an important part of a test chemical's toxicity profile that is also assessed by the *in vivo* ocular irritation test. Preliminary analyses indicated that recovery data (up to 72 h following the chemical exposure) could potentially increase the predictive capacity of INVITTOX Protocol 71 but further evaluation is needed and would benefit from additional data, preferably acquired by further testing (6). This test method will be updated accordingly as new information and data are considered.

PROCEDURE**Preparation of the cellular monolayer**

The monolayer of MDCK CB997 cells is prepared using sub-confluent cells growing in cell culture flasks in DMEM/Nutrient Mix F12 (1x concentrate with L-glutamine, 15 mM HEPES, calcium (at a concentration of 1,0-1,8 mM) and 10 % heat-inactivated FCS/FBS). Importantly, all media/solutions used throughout the FL assay should contain calcium at a concentration between 1,8 mM (200 mg/l) and 1,0 mM (111 mg/l) to ensure tight junction formation and integrity. Cell passage number range should be controlled to ensure even and reproducible tight junctions formation. Preferably, the cells should be within the passage range 3-30 from thawing because cells within this passage range have similar functionality, which aids assay results to be reproducible.

Prior to performing the FL test method, the cells are detached from the flask by trypsinisation, centrifuged and an appropriate amount of cells is seeded into the inserts placed in 24-well plates (see Appendix 1). Twelve mm diameter inserts with membrane of mixed cellulose esters, a thickness of 80-150 µm and a pore size of 0,45 µm, should be used to seed the cells. In the validation study, Millicell-HA 12 mm inserts were used. The properties of the insert and membrane type are important as these may affect cell growth and chemical binding. Certain types of chemicals may bind to the Millicell-HA insert membrane, which could affect the interpretation of results. Proficiency chemicals (see Appendix 3) should be used to demonstrate equivalency if other membranes are used.

▼M7

Chemical binding to the insert membrane is more common for cationic chemicals, such as benzalkonium chloride, which are attracted to the charged membrane (7). Chemical binding to the insert membrane may increase the chemical exposure period, leading to an over-estimation of the toxic potential of the chemical, but can also physically reduce the leakage of fluorescein through the insert by binding of the dye to the cationic chemical bound to the insert membrane, leading to an under-estimation of the toxic potential of the chemical. This can be readily monitored by exposing the membrane alone to the top concentration of the chemical tested and then adding sodium-fluorescein dye at the normal concentration for the standard time (no cell control). If binding of the sodium-fluorescein dye occurs, the insert membrane appears yellow after the test material has been washed-off. Thus, it is essential to know the binding properties of the test chemical in order to be able to interpret the effect of the chemical on the cells.

Cell seeding on inserts should produce a confluent monolayer at the time of chemical exposure. 1.6×10^5 cells should be added per insert (400 μ l of a cell suspension with a density of 4×10^5 cells / ml). Under these conditions, a confluent monolayer is usually obtained after 96 hours in culture. Inserts should be examined visually prior to seeding, so as to ensure that any damages recorded at the visual control described at paragraph 30 is due to handling.

The MDCK cell cultures should be kept in incubators in a humidified atmosphere, at $5\% \pm 1\%$ CO₂ and 37 ± 1 °C. The cells should be free of contamination by bacteria, viruses, mycoplasma and fungi.

Application of the Test and Control Chemicals

A fresh stock solution of test chemical should be prepared for each experimental run and used within 30 minutes of preparation. Test chemicals should be prepared in calcium-containing (at a concentration of 1,0-1,8 mM), phenol red-free, HBSS to avoid serum protein binding. Solubility of the chemical at 250 mg/ml in HBSS should be assessed prior to testing. If at this concentration the chemical forms a stable suspension or emulsion (*i.e.* maintains uniformity and does not settle or separate into more than one phase) over 30 minutes, HBSS can still be used as solvent. However, if the chemical is found to be insoluble in HBSS at this concentration, the use of other test methods instead of FL should be considered. The use of light mineral oil as a solvent, in cases where the chemical is found to be insoluble in HBSS, should be considered with caution as there is not enough data available to conclude on the performance of the FL assay under such conditions.

All chemicals to be tested are prepared in sterile calcium-containing (at a concentration of 1,0-1,8 mM), phenol red-free, HBSS from the stock solution, at five fixed concentrations diluted on a weight per volume basis: 1, 25, 100, 250 mg/ml and a neat or a saturated solution. When testing a solid chemical, a very high concentration of 750 mg/ml should be included. This concentration of chemical may have to be applied on the cells using a positive displacement pipette. If the toxicity is found to be between 25 and 100 mg/ml, the following additional concentrations should be tested twice: 1, 25, 50, 75, 100 mg/ml. The FL₂₀ value should be derived from these concentrations provided the acceptance criteria were met.

The test chemicals are applied to the confluent cell monolayers after removal of the cell culture medium and washing twice with sterile, warm (37 °C), calcium-containing (at a concentration of 1,0-1,8 mM), phenol red-free, HBSS. Previously, the filters have been visually checked for any pre-existing damages that could be falsely attributed to potential incompatibilities with test chemicals. At least three replicates should be used for each concentration of the test chemical and for the controls in each run. After 1 min of exposure at room temperature, the test chemical should be carefully removed by aspiration, the

▼ M7

monolayer should be washed twice with sterile, warm (37 °C), calcium-containing (at a concentration of 1,0-1,8 mM), phenol red-free, HBSS, and the fluorescein leakage should be immediately measured.

Concurrent negative (NC) and positive controls (PC) should be used in each run to demonstrate that monolayer integrity (NC) and sensitivity of the cells (PC) are within a defined historical acceptance range. The suggested PC chemical is Brij 35 (CAS No. 9002-92-0) at 100 mg/ml. This concentration should give approximately 30 % fluorescein leakage (acceptable range 20-40 % fluorescein leakage, *i.e.* damage to cell layer). The suggested NC chemical is calcium-containing (at a concentration of 1,0-1,8 mM), phenol red-free, HBSS (untreated, blank control). A maximum leakage control should also be included in each run to allow for the calculation of FL₂₀ values. Maximum leakage is determined using a control insert without cells.

Determination of fluorescein permeability

Immediately after removal of the test and control chemicals, 400 µl of 0,1 mg/ml sodium-fluorescein solution (0,01 % (w/v) in calcium-containing [at a concentration of 1,0-1,8 mM], phenol red-free, HBSS) is added to the inserts (e.g. Millicell-HA). The cultures are kept for 30 minutes at room temperature. At the end of the incubation with fluorescein, the inserts are carefully removed from each well. Visual check is performed on each filter and any damage which may have occurred during handling is recorded.

The amount of fluorescein that leaked through the monolayer and the insert is quantified in the solution which remained in the wells after removal of the inserts. Measurements are done in a spectrofluorometer at excitation and emission wavelengths of 485 nm and 530 nm, respectively. The sensitivity of the spectrofluorometer should be set so that there is the highest numerical difference between the maximum FL (insert with no cells) and the minimum FL (insert with confluent monolayer treated with NC). Because of the differences in the used spectrofluorometer, it is suggested that a sensitivity is used which will give fluorescence intensity > 4 000 at the maximum fluorescein leakage control. The maximum FL value should not be greater than 9 999. The maximum fluorescence leakage intensity should fall within the linear range of the spectrofluorometer used.

Interpretation of results and Prediction model

The amount of FL is proportional to the chemical-induced damage to the tight junctions. The percentage of FL for each tested concentration of chemical is calculated from the FL values obtained for the test chemical with reference to FL values from the NC (reading from the confluent monolayer of cells treated with the NC) and a maximum leakage control (reading for the amount of FL through an insert without cells).

The mean maximum leakage fluorescence intensity = x

The mean 0 % leakage fluorescence intensity (NC) = y

The mean 100 % leakage is obtained by subtracting the mean 0 % leakage from the mean maximum leakage,

i.e. $x - y = z$

The percentage leakage for each fixed dose is obtained by subtracting the 0 % leakage to the mean fluorescence intensity of the three replicate readings (m), and dividing this value by the 100 % leakage, *i.e.* %FL = $[(m-y) / z] \times 100 \%$, where:

▼M7

m = the mean fluorescence intensity of the three replicate measurements for the concentration involved

% FL = the percent of the fluorescein which leaks through the cell layer

The following equation for the calculation of the chemical concentration causing 20 % FL should be applied:

$$FL_D = [(A-B) / (C-B)] \times (M_C - M_B) + M_B$$

Where:

D = % of inhibition

A = % damage (20 % fluorescein leakage)

B = % fluorescein leakage < A

C = % fluorescein leakage > A

M_C = Concentration (mg/ml) of C

M_B = Concentration (mg/ml) of B

The cut-off value of FL₂₀ for predicting chemicals as ocular corrosives/severe irritants is given below:

FL ₂₀ (mg/ml)	UN GHS C&L	EU CLP C&L	U.S. EPA C&L
≤ 100	Category 1	Category 1	Category I

C&L: classification and labelling.

The FL test method is recommended only for the identification of water soluble ocular corrosives and severe irritants (UN GHS Category 1, EU CLP Category 1, U.S. EPA Category I) (see paragraphs 1 and 10).

In order to identify water soluble chemicals (substances and mixtures) (3) (6) (7) as 'inducing serious eye damage' (UN GHS/EU CLP Category 1) or as an 'ocular corrosive or severe irritant' (U.S. EPA Category I), the test chemical should induce an FL₂₀ value of ≤ 100 mg/ml.

Acceptance of results

The mean maximum fluorescein leakage value (x) should be higher than 4 000 (see paragraph 31), the mean 0 % leakage (y) should be equal or lower than 300, and the mean 100 % leakage (z) should fall between 3 700 and 6 000.

A test is considered acceptable if the positive control produced 20 % to 40 % damage to the cell layer (measure as % fluorescein leakage).

DATA AND REPORTING

Data

For each run, data from individual replicate wells (e.g. fluorescence intensity values and calculated percentage FL data for each test chemical, including classification) should be reported in tabular form. In addition, means ± SD of individual replicate measurements in each run should be reported.

▼ M7**Test Report**

The test report should include the following information:

Test and Control Chemicals

- Chemical name(s) such as the structural name used by the Chemical Abstracts Service (CAS), followed by other names, if known;
- Chemical CAS number, if known;
- Purity and composition of the substance or mixture (in percentage(s) by weight), to the extent this information is available;
- Physical-chemical properties relevant to the conduct of the study (e.g. physical state, volatility, pH, stability, water solubility, chemical class);
- Treatment of the test/control chemical prior to testing, if applicable (e.g. warming, grinding);
- Storage conditions;

Justification of the test method and Protocol Used

- Should include considerations regarding applicability domain and limitations of the test method;

Test Conditions

- Description of cell system used, including certificate of authenticity and the mycoplasma status of the cell line;
- Details of test procedure used;
- Test chemical concentration(s) used;
- Duration of exposure to the test chemical;
- Duration of incubation with fluorescein;
- Description of any modifications of the test procedure;
- Description of evaluation criteria used;
- Reference to historical data of the model (e.g. negative and positive controls, benchmark chemicals, if applicable);
- Information on the technical proficiency demonstrated by the laboratory;

Results

- Tabulation of data from individual test chemicals and controls for each run and each replicate measurement (including individual results, means and SDs);
- The derived classification(s) with reference to the prediction model and/or decision criteria used;
- Description of other effects observed;

▼ M7*Discussion of the Results*

— Should include considerations regarding a non-conclusive outcome (paragraph 35: FL₂₀ > 100 mg/ml) and further testing;

Conclusions

LITERATURE:

- (1) UN (2009), United Nations Globally Harmonized System of Classification and Labelling of Chemicals (GHS), Third revised edition, New York & Geneva: United Nations Publications. ISBN: 978-92-1-117006-1. Available at: [http://www.unece.org/trans/danger/publi/ghs/ghs_rev03/03files_e.html]
- (2) U.S. EPA (1996), Label Review Manual: 2nd Edition, EPA737-B-96-001, Washington DC: U.S. Environmental Protection Agency.
- (3) EC-ECVAM (2009), Statement on the scientific validity of cytotoxicity/cell-function based *in vitro* assays for eye irritation testing.
- (4) Scott, L. *et al.* (2010), A proposed eye irritation testing strategy to reduce and replace *in vivo* studies using Bottom-Up and Top-Down approaches, *Toxicol. In Vitro* 24, 1-9
- (5) Chapter B.5 of this Annex, *Acute Eye Irritation/Corrosion*
- (6) EC-ECVAM (1999), INVITOX Protocol 71: Fluorescein Leakage Test, Ispra, Italy: European Centre for the Validation of Alternative Methods (ECVAM). Available at: [<http://ecvam-dbalm.jrc.ec.europa.eu>]
- (7) EC-ECVAM (2008), Fluorescein Leakage Assay Background Review Document as an Alternative Method for Eye Irritation Testing.
- (8) OECD (2005), *Guidance Document on the Validation and International Acceptance of New or Updated Test Methods for Hazard Assessment*, OECD Series on Testing and Assessment No. 34. OECD, Paris.

▼ M7*Appendix 1***DIAGRAM OF MDCK CELLS GROWN ON AN INSERT MEMBRANE
FOR THE FL TEST METHOD**

A confluent layer of MDCK cells is grown on the semi-permeable membrane of an insert. The inserts are placed into the wells of 24 well plates.

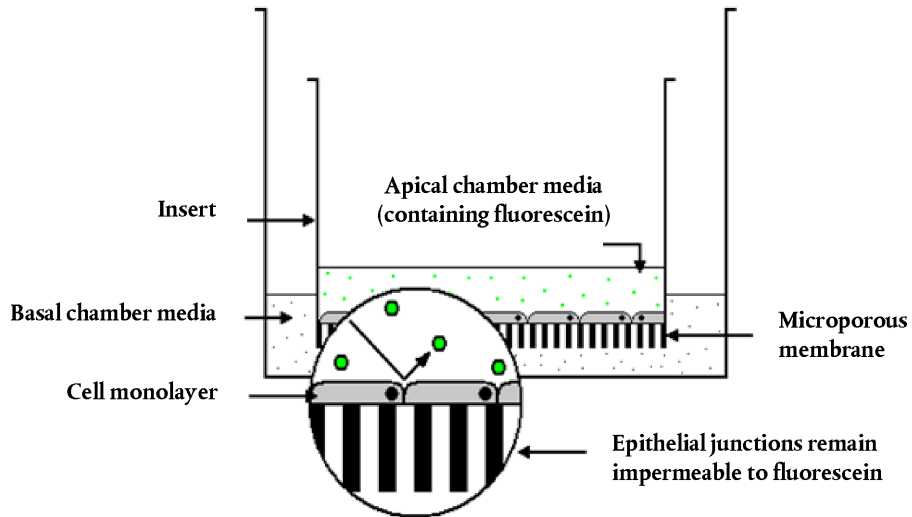

Figure taken from: Wilkinson, P.J. (2006), Development of an *in vitro* model to investigate repeat ocular exposure, Ph.D. Thesis, University of Nottingham, UK.

▼ M7*Appendix 2*

DEFINITIONS

Accuracy: The closeness of agreement between test method results and accepted reference values. It is a measure of test method performance and one aspect of 'relevance'. The term is often used interchangeably with 'concordance', to mean the proportion of correct outcomes of a test method.

Chemical: A substance or a mixture.

EPA Category I: Chemicals that produce corrosive (irreversible destruction of ocular tissue) or corneal involvement or irritation persisting for more than 21 days (2).

EU CLP (Regulation (EC) No1272/2008 on Classification, Labelling and Packaging of Substances and Mixtures): Implements in the European Union (EU) the UN GHS system for the classification of chemicals (substances and mixtures).

False negative rate: The proportion of all positive chemicals falsely identified by a test method as negative. It is one indicator of test method performance.

False positive rate: The proportion of all negative chemicals that are falsely identified by a test method as positive. It is one indicator of test method performance.

FL₂₀: Can be estimated by the determination of the concentration at which the tested chemical causes 20 % of the fluorescein leakage through the cell layer.

Fluorescein leakage: the amount of fluorescein which passes through the cell layer, measured spectrofluorometrically.

GHS (Globally Harmonized System of Classification and Labeling of Chemicals by the United Nation (UN)): A system proposing the classification of chemicals (substances and mixtures) according to standardised types and levels of physical, health and environmental hazards, and addressing corresponding communication elements, such as pictograms, signal words, hazard statements, precautionary statements and safety data sheets, so that to convey information on their adverse effects with a view to protect people (including employers, workers, transporters, consumers and emergency responders) and the environment.

GHS Category 1: Production of tissue damage in the eye, or serious physical decay of vision, following application of a test chemical to the anterior surface of the eye, which is not fully reversible within 21 days of application.

Hazard: Inherent property of an agent or situation having the potential to cause adverse effects when an organism, system or (sub) population is exposed to that agent.

Mixture: Used in the context of the UN GHS as a mixture or solution composed of two or more substances in which they do not react.

Negative control: An untreated replicate containing all components of a test system. This sample is processed with test chemical-treated samples and other control samples to determine whether the solvent interacts with the test system.

▼ M7

Not-classified: Chemicals that are not classified as UN GHS Categories 1, 2A, or 2B; EU CLP Categories 1 or 2; or U.S. EPA Categories I, II, or III ocular irritants.

Ocular corrosive: (a) A chemical that causes irreversible tissue damage to the eye. (b) Chemicals that are classified as UN GHS Category 1; EU CLP Category 1; or U.S. EPA Category I ocular irritants.

Ocular irritant: (a) A chemical that produces a reversible change in the eye following application to the anterior surface of the eye; (b) Chemicals that are classified as UN GHS Categories 2A, or 2B; EU CLP Category 2; or U.S. EPA Categories II or III ocular irritants.

Ocular severe irritant: (a) A chemical that causes tissue damage in the eye following application to the anterior surface of the eye that is not reversible within 21 days of application or causes serious physical decay of vision. (b) Chemicals that are classified as UN GHS Category 1; EU CLP Category 1; or U.S. EPA Category I ocular irritants.

Positive control: A replicate containing all components of a test system and treated with a chemical known to induce a positive response. To ensure that variability in the positive control response across time can be assessed, the magnitude of the positive response should not be extreme.

Proficiency Chemicals: A sub-set of the list of Reference Chemicals that can be used by a naïve laboratory to demonstrate proficiency with the validated reference test method.

Relevance: Description of relationship of the test to the effect of interest and whether it is meaningful and useful for a particular purpose. It is the extent to which the test correctly measures or predicts the biological effect of interest. Relevance incorporates consideration of the accuracy (concordance) of a test method (8).

Reliability: Measures of the extent that a test method can be performed reproducibly within and between laboratories over time, when performed using the same protocol. It is assessed by calculating intra- and inter-laboratory reproducibility and intra-laboratory repeatability.

Replacement test: A test which is designed to substitute for a test that is in routine use and accepted for hazard identification and/or risk assessment, and which has been determined to provide equivalent or improved protection of human or animal health or the environment, as applicable, compared to the accepted test, for all possible testing situations and chemicals.

Sensitivity: The proportion of all positive/active chemicals that are correctly classified by the test. It is a measure of accuracy for a test method that produces categorical results, and is an important consideration in assessing the relevance of a test method (8).

Serious eye damage: Is the production of tissue damage in the eye, or serious physical decay of vision, following application of a test chemical to the anterior surface of the eye, which is not fully reversible within 21 days of application.

Solvent/vehicle control: An untreated sample containing all components of a test system, including the solvent or vehicle that is processed with the test chemical-treated and other control samples to establish the baseline response for the

▼ M7

samples treated with the test chemical dissolved in the same solvent or vehicle. When tested with a concurrent negative control, this sample also demonstrates whether the solvent or vehicle interacts with the test system.

Specificity: The proportion of all negative/inactive chemicals that are correctly classified by the test. It is a measure of accuracy for a test method that produces categorical results and is an important consideration in assessing the relevance of a test method.

Substance: Used in the context of the UN GHS as chemical elements and their compounds in the natural state or obtained by any production process, including any additive necessary to preserve the stability of the product and any impurities deriving from the process used, but excluding any solvent which may be separated without affecting the stability of the substance or changing its composition.

Test chemical: Any substance or mixture tested using this test method.

Tiered testing strategy: A stepwise testing strategy where all existing information on a test chemical is reviewed, in a specified order, using a weight-of-evidence process at each tier to determine if sufficient information is available for a hazard classification decision, prior to progression to the next tier. If the irritancy potential of a test chemical can be assigned based on the existing information, no additional testing is required. If the irritancy potential of a test chemical cannot be assigned based on the existing information, a step-wise sequential animal testing procedure is performed until an unequivocal classification can be made.

Validated test method: A test method for which validation studies have been completed to determine the relevance (including accuracy) and reliability for a specific purpose. It is important to note that a validated test method may not have sufficient performance in terms of accuracy and reliability to be found acceptable for the proposed purpose (8).

Weight-of-evidence: The process of considering the strengths and weaknesses of various pieces of information in reaching and supporting a conclusion concerning the hazard potential of a chemical.

▼M7

Appendix 3

PROFICIENCY CHEMICALS FOR THE FL TEST METHOD

Prior to routine use of this test method, laboratories should demonstrate technical proficiency by correctly identifying the ocular corrosivity classification of the 8 chemicals recommended in Table 1. These chemicals were selected to represent the range of responses for local eye irritation/corrosion, which is based on results in the *in vivo* rabbit eye test (TG 405, TM B.5(5)) (*i.e.*, Categories 1, 2A, 2B, or no classification according to the UN GHS). However, considering the validated usefulness of the FL assay (*i.e.*, to identify ocular corrosives/severe irritants only), there are only two test outcomes for classification purposes (corrosive/severe irritant or non-corrosive/non-severe irritant) to demonstrate proficiency. Other selection criteria were that chemicals are commercially available, there are high quality *in vivo* reference data available, and there are high quality data from the FL test method. For this reason, the proficiency chemicals were selected from the 'Fluorescein Leakage Assay Background Review Document as an Alternative Method for Eye Irritation Testing' (8), which was used for the retrospective validation of the FL test method.

Table 1

Recommended chemicals for demonstrating technical proficiency with FL

Chemical	CAS NR	Chemical Class ⁽¹⁾	Physical Form	In Vivo Classification ⁽²⁾	In Vitro Classification ⁽³⁾
Benzalkonium chloride (5 %)	8001-54-5	Onium compound	Liquid	Category 1	Corrosive/Severe Irritant
Promethazine hydrochloride	58-33-3	Amine/Amidine, Heterocyclic, Organic sulphur compound	Solid	Category 1	Corrosive/Severe Irritant
Sodium hydroxide (10 %)	1310-73-2	Alkali	Liquid	Category 1	Corrosive/Severe Irritant
Sodium lauryl sulfate (15 %)	151-21-3	Carboxylic acid (salt)	Liquid	Category 1	Corrosive/Severe Irritant
4-carboxy-benzaldehyde	619-66-9	Carboxylic acid, Aldehyde	Solid	Category 2(A)	Non-corrosive/Non-severe irritant
Ammonium nitrate	6484-52-2	Inorganic salt	Solid	Category 2(A)	Noncorrosive/Non-severe irritant
Ethyl-2-methylacetoacetate	609-14-3	Ketone, Ester	Liquid	Category 2(B)	Noncorrosive/Non-severe irritant
Glycerol	56-81-5	Alcohol	Liquid	No Category	Noncorrosive/Non-severe irritant

Abbreviations: CAS NR = Chemical Abstracts Service Registry Number

⁽¹⁾ Chemical classes were assigned to each test chemical using a standard classification scheme, based on the National Library of Medicine Medical Subject Headings (MeSH) classification system (available at <http://www.nlm.nih.gov/mesh>)

⁽²⁾ Based on results from the *in vivo* rabbit eye test (OECD TG 405, TM B.5) and using the UN GHS and EU CLP.

⁽³⁾ Based on results obtained with FL (INVITTOX Protocol No. 71(6))

▼ M7**B.62. *IN VIVO* MAMMALIAN ALKALINE COMET ASSAY****INTRODUCTION**

This test method (TM) is equivalent to OECD test guideline (TG) 489 (2016). The *in vivo* alkaline comet (single cell gel electrophoresis) assay (hereafter called simply the comet assay) is used for the detection of DNA strand breaks in cells or nuclei isolated from multiple tissues of animals, usually rodents, that have been exposed to potentially genotoxic material(s). The comet assay has been reviewed and recommendations have been published by various expert groups (1) (2) (3) (4) (5) (6) (7) (8) (9) (10). This test method is part of a series of test methods on genetic toxicology. An OECD document that provides succinct information on genetic toxicology testing and an overview of the recent changes that were made to these Test Guidelines has been developed (11).

The purpose of the comet assay is to identify chemicals that cause DNA damage. Under alkaline conditions (> pH 13), the comet assay can detect single and double stranded breaks, resulting, for example, from direct interactions with DNA, alkali labile sites or as a consequence of transient DNA strand breaks resulting from DNA excision repair. These strand breaks may be repaired, resulting in no persistent effect, may be lethal to the cell, or may be fixed into a mutation resulting in a permanent viable change. They may also lead to chromosomal damage which is also associated with many human diseases including cancer.

A formal validation trial of the *in vivo* rodent comet assay was performed in 2006-2012, coordinated by the Japanese Center for the Validation of Alternative Methods (JaCVAM), in conjunction with the European Centre for the Validation of Alternative Methods (ECVAM), the Interagency Coordinating Committee on the Validation of Alternative Methods (ICCVAM) and the NTP Interagency Center for the Evaluation of Alternative Toxicological Methods (NICEATM) (12). This test method includes the recommended use and limitations of the comet assay, and is based on the final protocol (12) used in the validation trial, and on additional relevant published and unpublished (laboratories proprietary) data.

Definitions of key terms are set out in Appendix 1. It is noted that many different platforms can be used for this assay (microscope slides, gel spots, 96-well plates etc.). For convenience the term 'slide' is used throughout the remainder of this document but encompasses all of the other platforms.

INITIAL CONSIDERATIONS AND LIMITATIONS

The comet assay is a method for measuring DNA strand breaks in eukaryotic cells. Single cells/nuclei embedded in agarose on a slide are lysed with detergent and high salt concentration. This lysis step digests the cellular and nuclear membranes and allows the release of coiled DNA loops generally called nucleoids and DNA fragments. Electrophoresis at high pH results in structures resembling comets, which, by using appropriate fluorescent stains, can be observed by fluorescence microscopy; DNA fragments migrate away from the 'head' into the 'tail' based on their size, and the intensity of the comet tail relative to the total intensity (head plus tail) reflects the amount of DNA breakage (13) (14) (15).

The *in vivo* alkaline comet assay is especially relevant to assess genotoxic hazard in that the assay's responses are dependent upon *in vivo* ADME (absorption, distribution, metabolism and excretion), and also on DNA repair processes. These may vary among species, among tissues and among the types of DNA damage.

▼ M7

To fulfil animal welfare requirements, in particular the reduction in animal usage (3Rs — Replacement, Reduction, Refinement— principles), this assay can also be integrated with other toxicological studies, e.g. repeated dose toxicity studies (10) (16) (17), or the endpoint can be combined with other genotoxicity endpoints such as the *in vivo* mammalian erythrocyte micronucleus assay (18) (19) (20). The comet assay is most often performed in rodents, although it has been applied to other mammalian and non-mammalian species. The use of non-rodent species should be scientifically and ethically justified on a case-by-case basis and it is strongly recommended that the comet assay only be performed on species other than rodents as part of another toxicity study and not as a standalone test.

The selection of route of exposure and tissue(s) to be studied should be determined based on all available/existing knowledge of the test chemicals e.g. intended/expected route of human exposure, metabolism and distribution, potential for site-of-contact effects, structural alerts, other genotoxicity or toxicity data, and the purpose of the study. Thus, where appropriate, the genotoxic potential of the test chemicals can be assayed in the target tissue(s) of carcinogenic and/or other toxic effects. The assay is also considered useful for further investigation of genotoxicity detected by an *in vitro* system. It is appropriate to perform an *in vivo* comet assay in a tissue of interest when it can be reasonably expected that the tissue of interest will be adequately exposed.

The assay has been most extensively validated in somatic tissues of male rats in collaborative studies such as the JaCVAM trial (12) and in Rothfuss *et al.*, 2010 (10). The liver and stomach were used in the JaCVAM international validation trial. The liver, because it is the most active organ in metabolism of chemicals and also frequently a target organ for carcinogenicity. The stomach, because it is usually first site of contact for chemicals after oral exposure, although other areas of the gastro-intestinal tract such as the duodenum and jejunum should also be considered as site-of-contact tissues and may be considered more relevant for humans than the rodent glandular stomach. Care should be taken to ensure that such tissues are not exposed to excessively high test chemical concentrations (21). The technique is in principle applicable to any tissue from which analysable single cell/nuclei suspensions can be derived. Proprietary data from several laboratories demonstrate its successful application to many different tissues, and there are many publications showing the applicability of the technique to organs or tissues other than liver and stomach, e.g. jejunum (22), kidney (23) (24), skin (25) (26), or urinary bladder (27) (28), lungs and bronchoalveolar lavage cells (relevant for studies of inhaled chemicals) (29) (30), and tests have also been performed in multiple organs (31) (32).

Whilst there may be an interest in genotoxic effects in germ cells, it should be noted that the standard alkaline comet assay as described in this test method is not considered appropriate to measure DNA strand breaks in mature germ cells. Since high and variable background levels in DNA damage were reported in a literature review on the use of the comet assay for germ cell genotoxicity (33), protocol modifications together with improved standardization and validation studies are deemed necessary before the comet assay on mature germ cells (e.g. sperm) can be included in the test method. In addition, the recommended exposure regimen described in this test method is not optimal and longer exposures or sampling times would be necessary for a meaningful analysis of DNA strand breaks in mature sperm. Genotoxic effects as measured by the comet assay in testicular cells at different stages of differentiation have been described in the literature (34) (35). However, it should be noted that gonads contain a mixture of somatic and germ cells. For this reason, positive results in whole gonad (testis) are not necessarily reflective of germ cell damage; nevertheless, they indicate that tested chemical(s) and/or its metabolites have reached the gonad.

▼M7

Cross-links cannot be reliably detected with the standard experimental conditions of the comet assay. Under certain modified experimental conditions, DNA-DNA and DNA-protein crosslinks, and other base modifications such as oxidized bases might be detected (23) (36) (37) (38) (39). But further work would be needed to adequately characterize the necessary protocol modifications. Thus detection of cross linking agents is not the primary purpose of the assay as described here. The assay is not appropriate, even with modifications, for detecting aneuploids.

Due to the current status of knowledge, several additional limitations (see Appendix 3) are associated with the *in vivo* comet assay. It is expected that the test method will be reviewed in the future and if necessary revised in light of experience gained.

Before use of the test method on a mixture for generating data for an intended regulatory purpose, it should be considered whether, and if so why, it may provide adequate results for that purpose. Such considerations are not needed, when there is a regulatory requirement for testing of the mixture.

PRINCIPLE OF THE METHOD

Animals are exposed to the test chemical by an appropriate route. A detailed description of dosing and sampling is given in paragraphs 36-40. At the selected sampling time(s), the tissues of interest are dissected and single cells/nuclei suspensions are prepared (*in situ* perfusion may be performed where considered useful e.g. liver) and embedded in soft agar so as to immobilize them on slides. Cells/nuclei are treated with lysis buffer to remove cellular and/or nuclear membrane, and exposed to strong alkali e.g. pH ≥ 13 to allow DNA unwinding and release of relaxed DNA loops and fragments. The nuclear DNA in the agar is then subjected to electrophoresis. Normal non-fragmented DNA molecules remain in the position where the nuclear DNA had been in the agar, while any fragmented DNA and relaxed DNA loops would migrate towards the anode. After electrophoresis, the DNA is visualized using an appropriate fluorescent stain. Preparations should be analysed using a microscope and full or semi-automated image analysis systems. The extent of DNA that has migrated during electrophoresis and the migration distance reflects the amount and size of DNA fragments. There are several endpoints for the comet assay. The DNA content in the tail (% tail DNA or % tail intensity) has been recommended to assess DNA damage (12) (40) (41) (42). After analysis of a sufficient number of nuclei, the data are analysed with appropriate methods to judge the assay results.

It should be noted that altering various aspects of the methodology, including sample preparation, electrophoresis conditions, visual analysis parameters (e.g. stain intensity, microscope bulb light intensity, and use of microscope filters and camera dynamics) and ambient conditions (e.g. background lighting), have been investigated and may affect DNA migration (43) (44) (45) (46).

VERIFICATION OF LABORATORY PROFICIENCY

Each laboratory should establish experimental competency in the comet assay by demonstrating the ability to obtain single cell or nuclei suspensions of sufficient quality for each target tissue(s) for each species used. The quality of the preparations will be evaluated firstly by the % tail DNA for vehicle treated animals falling within a reproducible low range. Current data suggest that the group mean % tail DNA (based on mean of medians — see paragraph 57 for details of these terms) in the rat liver should be preferably not exceed 6 %, which would be consistent with the values in the JaCVAM validation trial (12) and from other published and proprietary data. There are not enough data at this time to make

▼ M7

recommendations about optimum or acceptable ranges for other tissues. This does not preclude the use of other tissues if justified. The test report should provide appropriate review of the performance of the comet assay in these tissues in relation to the published literature or from proprietary data. Firstly, a low range of % tail DNA in controls is desirable to provide sufficient dynamic range to detect a positive effect. Secondly, each laboratory should be able to reproduce expected responses for direct mutagens and pro-mutagens, with different modes of action as suggested in Table 1 (paragraph 29).

Positive substances may be selected, for example from the JaCVAM validation trial (12) or from other published data (see paragraph 9), if appropriate, with justification, and demonstrating clear positive responses in the tissues of interest. The ability to detect weak effects of known mutagens e.g. EMS at low doses, should also be demonstrated, for example by establishing dose-response relationships with appropriate numbers and spacing of doses. Initial efforts should focus on establishing proficiency with the most commonly used tissues e.g. the rodent liver, where comparison with existing data and expected results may be made (12). Data from other tissues e.g. stomach/duodenum/jejunum, blood etc. could be collected at the same time. The laboratory needs to demonstrate proficiency with each individual tissue in each species they are planning to study, and will need to demonstrate that an acceptable positive response with a known mutagen (e.g. EMS) can be obtained in that tissue.

Vehicle/negative control data should be collected so as to demonstrate reproducibility of negative data responses, and to ensure that the technical aspects of the assay were properly controlled or to suggest the need to re-establish historical control ranges (see paragraph 22).

It should be noted, that whilst multiple tissues can be collected at necropsy and processed for comet analysis, the laboratory needs to be proficient in harvesting multiple tissues from a single animal, thereby ensuring that any potential DNA lesion is not lost and comet analysis is not compromised. The length of time from euthanasia to removal of tissues for processing may be critical (see paragraph 44).

Animal welfare must be considered whilst developing proficiency in this test and therefore tissues from animals used in other tests can be used when developing competence in the various aspects of the test. Furthermore, it may not be necessary to conduct a full study during the stages of establishing a new test method in a laboratory and fewer animals or test concentrations can be used when developing the necessary skills.

Historical control data

During the course of the proficiency investigations, the laboratory should build a historical database to establish positive and negative control ranges and distributions for relevant tissues and species. Recommendations on how to build and use the historical data (i.e. criteria for inclusion and exclusion of data in historical data and the acceptability criteria for a given experiment) can be found in the literature (47). Different tissues and different species, as well as different vehicles and routes of administrations, may give different negative control % tail DNA values. It is therefore important to establish negative control ranges for each tissue and species. Laboratories should use quality control methods, such as control charts (e.g. C-charts or X-bar charts (48)), to identify how variable their data are, and to show that the methodology is 'under control' in their laboratory. Selection of appropriate positive control substances,

▼M7

dose ranges and experimental conditions (e.g. electrophoresis conditions) may need also to be optimised for the detection of weak effects (see paragraph 17).

Any changes to the experimental protocol should be considered in terms of their consistency with the laboratory's existing historical control databases. Any major inconsistencies should result in the establishment of a new historical control database.

DESCRIPTION OF THE METHOD**Preparations***Selection of animal species*

Common laboratory strains of healthy young adult rodents (6-10 weeks old at start of treatment though slightly older animals are also acceptable) are normally used. The choice of rodent species should be based on (i) species used in other toxicity studies (to be able to correlate data and to allow integrated studies), (ii) species that developed tumours in a carcinogenicity study (when investigating the mechanism of carcinogenesis), or (iii) species with the most relevant metabolism for humans, if known. Rats are routinely used in this test. However, other species can be used if ethically and scientifically justified.

Animal housing and feeding conditions

For rodents, the temperature in the experimental animal room ideally should be 22 °C (± 3 °C). The relative humidity ideally should be 50-60 %, being at least 30 % and preferably not exceeding 70 % other than during room cleaning. Lighting should be artificial, the sequence being 12 hours light, 12 hours dark. For feeding, conventional laboratory diets may be used with an unlimited supply of drinking water. The choice of diet may be influenced by the need to ensure a suitable admixture of a test chemical when administered by this route. Rodents should be housed in small groups (usually no more than five) of the same sex if no aggressive behaviour is expected. Animals may be housed individually only if scientifically justified. Solid floors should be used wherever possible as mesh floors can cause serious injury (49). Appropriate environmental enrichment must be provided.

Preparation of the animals

Animals are randomly assigned to the control and treatment groups. The animals are identified uniquely and acclimated to the laboratory conditions for at least five days before the start of treatment. The least invasive method of uniquely identifying animals must be used. Appropriate methods include ringing, tagging, micro-chipping and biometric identification. Toe and ear clipping are not scientifically justified in these tests. Cages should be arranged in such a way that possible effects due to cage placement are minimized. At the commencement of the study, the weight variation of animals should be minimal and not exceed ± 20 %.

Preparation of doses

Solid test chemicals should be dissolved or suspended in appropriate vehicles or admixed in diet or drinking water prior to dosing of the animals. Liquid test chemicals may be dosed directly or diluted prior to dosing. For inhalation exposures, test chemicals can be administered as gas, vapour, or a solid/liquid aerosol, depending on their physicochemical properties (50) (51).

Fresh preparations of the test chemical should be employed unless stability data demonstrate the acceptability of storage and define the appropriate storage conditions.

▼ **M7****Test Conditions***Vehicle*

The vehicle should not produce toxic effects at the dose volumes used, and should not be suspected of chemical reaction with the test chemicals. If other than well-known vehicles are used, their inclusion should be supported with reference data indicating their compatibility in terms of test animals, route of administration and endpoint. It is recommended that wherever possible, the use of an aqueous solvent/vehicle should be considered first. It should be noted that some vehicles (particularly viscous vehicles) can induce inflammation and increase background levels of DNA strand breaks at the site of contact, particularly with multiple administrations.

Controls*Positive controls*

At this time, a group of a minimum of 3 analysable animals of one sex, or of each sex if both are used (see paragraph 32), treated with a positive control substance should normally be included with each test. In future, it may be possible to demonstrate adequate proficiency to reduce the need for positive controls. If multiple sampling times are used (e.g. with a single administration protocol) it is only necessary to include positive controls at one of the sampling times, but a balanced design should be ensured (see paragraph 48). It is not necessary to administer concurrent positive control substances by the same route as the test chemical, although it is important that the same route should be used when measuring site-of-contact effects. The positive control substances should be shown to induce DNA strand breaks in all of the tissues of interest for the test chemical, and EMS is likely to be the positive control of choice since it has produced DNA strand breaks in all tissues that have been studied. The doses of the positive control substances should be selected so as to produce moderate effects that critically assess the performance and sensitivity of the assay and could be based on dose-response curves established by the laboratory during the demonstration of proficiency. The % tail DNA in concurrent positive control animals should be consistent with the pre-established laboratory range for each individual tissue and sampling time for that species (see paragraph 16). Examples of positive control substances and some of their target tissues (in rodents) are included in Table 1. Substances other than those given in Table 1 can be selected if scientifically justified.

*Table 1***Examples of positive control substances and some of their target tissues**

Substances and CAS RN No.
Ethyl methanesulfonate (CAS RN 62-50-0) for any tissue
Ethyl nitrosourea (CAS RN 759-73-9) for liver and stomach, duodenum or jejunum
Methyl methanesulfonate (CAS RN 66-27-3) for liver, stomach, duodenum or jejunum, lung and bronchoalveolar lavage (BAL) cells, kidney, bladder, lung, testis and bone marrow/blood
<i>N</i> -Methyl- <i>N'</i> -nitro- <i>N</i> -nitrosoguanidine (CAS RN: 70-25-7) for stomach, duodenum or jejunum
1,2-Dimethylhydrazine 2HCl (CAS RN 306-37-6) for liver and intestine
<i>N</i> -methyl- <i>N</i> -nitrosourea (CAS RN 684-93-5) for liver, bone marrow, blood, kidney, stomach, jejunum, and brain.

▼ M7*Negative controls*

A group of negative control animals, treated with vehicle alone, and otherwise treated in the same way as the treatment groups, should be included with each test for every sampling time and tissue. The % tail DNA in negative control animals should be within the pre-established laboratory background range for each individual tissue and sampling time for that species (see paragraph 16). In the absence of historical or published control data showing that no deleterious or genotoxic effects are induced by the chosen vehicle, by the number of administrations or by the route of administration, initial studies should be performed prior to conducting the full study, in order to establish acceptability of the vehicle control.

PROCEDURE

Number and Sex of Animals

Although there is little data on female animals from which to make comparison between sexes in relation to the comet assay, in general, other *in vivo* genotoxicity responses are similar between male and female animals and therefore most studies could be performed in either sex. Data demonstrating relevant differences between males and females (e.g. differences in systemic toxicity, metabolism, bioavailability, etc. including e.g. in a range-finding study) encourage the use of both sexes. In this case, it may be appropriate to perform a study in both sexes e.g. as part of a repeated dose toxicity study. It might be appropriate to use the factorial design in case both sexes are used. Details on how to analyse the data using this design are given in Appendix 2.

Group sizes at study initiation (and during establishment of proficiency) should be established with the aim of providing a minimum of 5 analysable animals of one sex, or of each sex if both are used, per group (less in the concurrent positive control group — see paragraph 29). Where human exposure to chemicals may be sex-specific, as for example with some pharmaceuticals, the test should be performed with the appropriate sex. As a guide to maximum typical animal requirements, a study conducted according the parameters established in paragraph 33 with three dose groups and concurrent negative and positive controls (each group composed of five animals of a single sex) would require between 25 and 35 animals.

TREATMENT SCHEDULE

Animals should be given daily treatments over a duration of 2 or more days (i.e. two or more treatments at approximately 24 hour intervals), and samples should be collected once at 2-6 h (or at the T_{max}) after the last treatment (12). Samples from extended dose regimens (e.g. 28-day daily dosing) are acceptable. Successful combination of the comet and the erythrocyte micronucleus test has been demonstrated (10) (19). However careful consideration should be given to the logistics involved in tissue sampling for comet analysis alongside the requirements of tissue sampling for other types of toxicological assessments. Harvest 24 hours after the last dose, which is typical of a general toxicity study, is not appropriate in most cases (see paragraph 40 on sampling time). The use of other treatment and sampling schedules should be justified (see Appendix 3). For example single treatment with multiple sampling could be used however, it should be noted that more animals will be required for a study with a single administration study because of the need for multiple sampling times, but on occasions this may be preferable, e.g. when the test chemical induces excessive toxicity following repeated administrations.

▼ M7

Whatever way the test is performed, it is acceptable as long as the test chemical gives a positive response or, for a negative study, as long as direct or indirect evidence supportive of exposure of, or toxicity to, the target tissue(s) has been demonstrated or if the limit dose is achieved (see paragraph 36).

Test chemicals also may be administered as a split dose, i.e., two treatments on the same day separated by no more than 2-3 hours, to facilitate administering a large volume. Under these circumstances, the sampling time should be scheduled based on the time of the last dosing (see paragraph 40).

Dose Levels

If a preliminary range-finding study is performed because there are no suitable data available from other relevant studies to aid in dose selection, it should be performed in the same laboratory, using the same species, strain, sex, and treatment regimen to be used in the main study according to current approaches for conducting dose range-finding studies. The study should aim to identify the maximum tolerated dose (MTD), defined as the dose inducing slight toxic effects relative to the duration of the study period (for example, clear clinical signs such as abnormal behaviour or reactions, minor body weight depression or target tissue cytotoxicity), but not death or evidence of pain, suffering or distress necessitating euthanasia. For a non-toxic test chemical, with an administration period of 14 days or more, the maximum (limit) dose is 1 000 mg/kg bodyweight/day. For administration periods of less than 14 days the maximum (limit) dose is 2 000 mg/kg bodyweight/day. For certain types of test chemicals (e.g. human pharmaceuticals) covered by specific regulations these limits may vary.

Chemicals that exhibit saturation of toxicokinetic properties, or induce detoxification processes that may lead to a decrease in exposure after long-term administration, may be exceptions to the dose-setting criteria and should be evaluated on a case-by-case basis.

For both acute and sub-acute versions of the comet assay, in addition to the maximum dose (MTD, maximum feasible dose, maximum exposure or limit dose) a descending sequence of at least two additional appropriately spaced dose levels (preferably separated by less than $\sqrt{10}$) should be selected for each sampling time to demonstrate dose-related responses. However, the dose levels used should also preferably cover a range from the maximum to one producing little or no toxicity. When target tissue toxicity is observed at all dose levels tested, further study at non-toxic doses is advisable (see paragraphs 54-55). Studies intending to more fully investigate the shape of the dose-response curve may require additional dose group(s).

Administration of Doses

The anticipated route of human exposure should be considered when designing an assay. Therefore, routes of exposure such as dietary, drinking water, topical, subcutaneous, intravenous, oral (by gavage), inhalation, intratracheal, or implantation may be chosen as justified. In any case the route should be chosen to ensure adequate exposure of the target tissue(s). Intraperitoneal injection is generally not recommended since it is not a typical relevant route of human

▼M7

exposure, and should only be used with specific justification (e.g. some positive control substances, for investigative purposes, or for some drugs that are administered by the intraperitoneal route). The maximum volume of liquid that can be administered by gavage or injection at one time depends on the size of the test animal. The volume should not exceed 1 ml/100 g body weight, except in the case of aqueous solutions where 2 ml/100g body weight may be used. The use of volumes greater than this (if permitted by animal welfare legislation) should be justified. Wherever possible different dose levels should be achieved by adjusting the concentration of the dosing formulation to ensure a constant volume in relation to body weight at all dose levels.

Sampling Time

The sampling time is a critical variable because it is determined by the period needed for the test chemicals to reach maximum concentration in the target tissue and for DNA strand breaks to be induced but before those breaks are removed, repaired or lead to cell death. The persistence of some of the lesions that lead to the DNA strand breaks detected by the comet assay may be very short, at least for some chemicals tested *in vitro* (52) (53). Accordingly, if such transient DNA lesions are suspected, measures should be taken to mitigate their loss by ensuring that tissues are sampled sufficiently early, possibly earlier than the default times given below. The optimum sampling time(s) may be chemical- or route-specific resulting in, for example, rapid tissue exposure with intravenous administration or inhalation exposure. Accordingly, where available, sampling times should be determined from kinetic data (e.g. the time (T_{max}) at which the peak plasma or tissue concentration (C_{max}) is achieved, or at the steady state for multiple administrations). In the absence of kinetic data a suitable compromise for the measurement of genotoxicity is to sample at 2-6 h after the last treatment for two or more treatments, or at both 2-6 and 16-26 h after a single administration, although care should be taken to necropsy all animals at the same time after the last (or only) dose. Information on the appearance of toxic effects in target organs (if available) may also be used to select appropriate sampling times.

Observations

General clinical observations related to the health of the animals should be made and recorded at least once a day preferably at the same time(s) each day and considering the peak period of anticipated effects after dosing (54). At least twice daily, all animals should be observed for morbidity and mortality. For longer duration studies, all animals should be weighed at least once a week, and at completion of the test period. Food consumption should be measured at each change of food and at least weekly. If the test chemical is administered via the drinking water, water consumption should be measured at each change of water and at least weekly. Animals exhibiting non-lethal indicators of excessive toxicity should be euthanized prior to completion of the test period, and are generally not used for comet analysis.

Tissue Collection

Since it is possible to study induction of DNA strand breaks (comets) in virtually any tissue, the rationale for selection of tissue(s) to be collected should be clearly defined and based upon the reason for conducting the study together with any existing ADME, genotoxicity, carcinogenicity or other toxicity data for the test chemicals under investigation. Important factors for consideration should include the route of administration (based on likely human exposure route(s)), the predicted tissue distribution and absorption, the role of metabolism and the possible mechanism of action of the test chemicals. The liver has been the tissue most frequently studied and for which there are the most data. Therefore, in the absence of any background information, and if no specific tissues of

▼ M7

interest are identified, sampling the liver would be justified as this is a primary site of xenobiotic metabolism and is often highly exposed to both parent substance(s) and metabolite(s). In some cases, examination of a site of direct contact (for example, for orally-administered chemicals the glandular stomach or duodenum/jejunum, or for inhaled chemicals the lungs) may be most relevant. Additional or alternative tissues should be selected based on the specific reasons for the test is being conducted but it may be useful to examine multiple tissues in the same animals providing the laboratory has demonstrated proficiency with those tissues and competency in handling multiple tissues at the same time.

Preparation of specimens

For the processes described in the following paragraphs (44-49) it is important that all solutions or stable suspensions should be used within their expiration date, or should be freshly prepared if needed. Also in the following paragraphs, the times taken to (i) remove each tissue after necropsy, (ii) process each tissue into cell/nuclei suspensions, and (iii) process the suspension and prepare the slides are all considered critical variables (see Definitions, Appendix 1), and acceptable lengths of time for each of these steps should have been determined during establishment of the method and demonstration of proficiency.

Animals will be euthanised, consistent with effective animal welfare legislation and 3Rs principles, at the appropriate time(s) after the last treatment with a test chemical. Selected tissue(s) is removed, dissected, and a portion is collected for the comet assay, whilst at the same time a section from the same part of the tissue should be cut and placed in formaldehyde solution or appropriate fixative for possible histopathology analysis (see paragraph 55) according to standard methods (12). The tissue for the comet assay is placed into mincing buffer, rinsed sufficiently with cold mincing buffer to remove residual blood, and stored in ice-cold mincing buffer until processed. *In situ* perfusion may also be performed, e.g. for liver, kidney.

Many published methods exist for cell/nuclei isolation. These include mincing of tissues such as liver and kidney, scraping mucosal surfaces in the case of the gastro-intestinal tract, homogenization and enzymic digestion. The JaCVAM validation trial only studied isolated cells, and therefore in terms of establishing the method and being able to refer to the JaCVAM trial data for demonstration of proficiency, isolated cells are preferred. However, it has been shown that there was no essential difference in the assay result whether isolated cells or nuclei were used (8). Also different methods to isolate cells/nuclei (e.g. homogenizing, mincing, enzymic digestion and mesh filtration) gave comparable results (55). Consequently, either isolated cells or isolated nuclei can be used. A laboratory should thoroughly evaluate and validate tissue-specific methods of single cell/nuclei isolation. As discussed in paragraph 40, the persistence of some of the lesions that lead to the DNA strand breaks detected by the comet assay may be very short (52) (53). Therefore, whatever method is used to prepare the single cell/nuclei suspensions, it is important that tissues are processed as soon as possible after the animals have been euthanised and placed in conditions that reduce the removal of lesions (e.g. by maintaining the tissue at low temperature). The cell suspensions should be kept ice-cold until ready for use, so that minimal inter-sample variation and appropriate positive and negative control responses can be demonstrated.

▼ M7**PREPARATION OF SLIDES**

Slide preparation should be done as soon as possible (ideally within one hour) after single cell/nuclei preparation, but the temperature and time between animal death and slide preparation should be tightly controlled and validated under the laboratory's conditions. The volume of the cell suspension added to low melting point agarose (usually 0,5-1,0 %) to make the slides should not reduce the percentage of low melting point agarose to less than 0,45 %. The optimum cell density will be determined by the image analysis system used for scoring comets.

Lysis

Lysis conditions are also a critical variable and may interfere with the strand breaks resulting from specific types of DNA modifications (certain DNA alkylations and base adducts). It is therefore recommended that the lysis conditions be kept as constant as possible for all slides within an experiment. Once prepared, the slides should be immersed in chilled lysing solution for at least one hour (or overnight) at around 2-8 °C under subdued lighting conditions e.g. yellow light (or light proof) that avoid exposure to white light that may contain UV components. After this incubation period, the slides should be rinsed to remove residual detergent and salts prior to the alkali unwinding step. This can be done using purified water, neutralization buffer or phosphate buffer. Electrophoresis buffer can also be used. This would maintain the alkaline conditions in the electrophoresis chamber.

Unwinding and electrophoresis

Slides should be randomly placed onto the platform of a submarine-type electrophoresis unit containing sufficient electrophoresis solution such that the surfaces of the slides are completely covered (the depth of covering should also be consistent from run to run). In another type of comet assay electrophoresis units i.e. with active cooling, circulation and high capacity power supply a higher solution covering will result in higher electric current while the voltage is kept constant. A balanced design should be used to place slides in the electrophoresis tank to mitigate the effects of any trends or edge effect within the tank and to minimize batch-to-batch variability, i.e., in each electrophoresis run, there should be the same number of slides from each animal in the study and samples from the different dosage groups, negative and positive controls, should be included. The slides should be left for at least 20 minutes for the DNA to unwind, and then subjected to electrophoresis under controlled conditions that will maximize the sensitivity and dynamic range of the assay (i.e. lead to acceptable levels of % tail DNA for negative and positive controls that maximize sensitivity). The level of DNA migration is linearly associated with the duration of electrophoresis, and also with the potential (V/cm). Based on the JaCVAM trial this could be 0,7 V/cm for at least 20 minutes. The duration of electrophoresis is considered a critical variable and the electrophoresis time should be set to optimize the dynamic range. Longer electrophoresis times (e.g. 30 or 40 minutes to maximize sensitivity) usually lead to stronger positive responses with known mutagens. However longer electrophoresis times may also lead to excessive migration in control samples. In each experiment the voltage should be kept constant, and the variability in the other parameters should be within a narrow and specified range, for example in the JaCVAM trial 0,7 V/cm delivered a starting current of 300 mA. The depth of buffer should be adjusted to achieve the required conditions and maintained throughout the experiment. The current at the start and end of the electrophoresis period should be recorded. The optimum conditions should therefore be determined during the initial demonstration of proficiency in the laboratory concerned with each tissue studied. The temperature of the electrophoresis solution through unwinding and

▼ M7

electrophoresis should be maintained at a low temperature, usually 2-10 °C (10). The temperature of the electrophoresis solution at the start of unwinding, the start of electrophoresis, and the end of electrophoresis should be recorded.

After completion of electrophoresis, the slides should be immersed/rinsed in the neutralization buffer for at least 5 minutes. Gels can be stained and scored 'fresh' (e.g. within 1-2 days) or can be dehydrated for later scoring (e.g. within 1-2 weeks after staining) (56). However, the conditions should be validated during the demonstration of proficiency and historical data should be obtained and retained separately for each of these conditions. In case of the latter, slides should be dehydrated by immersion into absolute ethanol for at least 5 minutes, allowed to air dry, and then stored, either at room temperature or in a container in a refrigerator until scored.

Methods of Measurement

Comets should be scored quantitatively using an automated or semi-automated image-analysis system. The slides will be stained with an appropriate fluorescent stain e.g. SYBR Gold, Green I, propidium iodide or ethidium bromide and measured at a suitable magnification (e.g. 200x) on a microscope equipped with epi-fluorescence and appropriate detectors or a digital (e.g. CCD) camera.

Cells may be classified into three categories as described in the atlas of comet images (57), namely scorable, non-scorable and 'hedgehog' (see paragraph 56 for further discussion). Only scorable cells (clearly defined head and tail with no interference with neighbouring cells) should be scored for % tail DNA to avoid artefacts. There is no need to report the frequency of non-scorable cells. The frequency of hedgehogs should be determined based on the visual scoring (since the absence of a clearly-defined head will mean they are not readily detected by image analysis) of at least 150 cells per sample (see paragraph 56 for further discussion) and separately documented.

All slides for analysis, including those of positive and negative controls, should be independently coded and scored 'blinded' so the scorer is unaware of the treatment condition. For each sample (per tissue per animal), at least 150 cells (excluding hedgehogs — see paragraph 56) should be analysed. Scoring 150 cells per animal in at least 5 animals per dose (less in the concurrent positive control — see paragraph 29) provides adequate statistical power according to the analysis of Smith *et al.*, 2008 (5). If slides are used, this could be from 2 or 3 slides scored per sample when five animals per group are used. Several areas of the slide should be observed at a density that ensures there is no overlapping of tails. Scoring at the edge of slides should be avoided.

DNA strand breaks in the comet assay can be measured by independent endpoints such as % tail DNA, tail length and tail moment. All three measurements can be made if the appropriate image software analyser system is used. However, the % tail DNA (also known as % tail intensity) is recommended for the evaluation and interpretation of results (12) (40) (41) (42), and is determined by the DNA fragment intensity in the tail expressed as a percentage of the cell's total intensity (13).

▼ M7**Tissue damage and cytotoxicity**

Positive findings in the comet assay may not be solely due to genotoxicity, target tissue toxicity may also result in increases in DNA migration (12) (41). Conversely, low or moderate cytotoxicity is often seen with known genotoxins (12), showing that it is not possible to distinguish DNA migration induced by genotoxicity versus that induced by cytotoxicity in the comet assay alone. However, where increases in DNA migration are observed, it is recommended that an examination of one or more indicators of cytotoxicity is performed as this can aid in interpretation of the findings. Increases in DNA migration in the presence of clear evidence of cytotoxicity should be interpreted with caution.

Many measures of cytotoxicity have been proposed and of these histopathological changes are considered a relevant measure of tissue toxicity. Observations such as inflammation, cell infiltration, apoptotic or necrotic changes have been associated with increases in DNA migration, however, as demonstrated by the JaCVAM validation trial (12) no definitive list of histopathological changes that are always associated with increased DNA migration is available. Changes in clinical chemistry measures (e.g. AST, ALT), can also provide useful information on tissue damage and additional indicators such as caspase activation, TUNEL stain, Annexin V stain, etc. may also be considered. However, there are limited published data where the latter have been used for *in vivo* studies and some may be less reliable than others.

Hedgehogs (or clouds, ghost cells) are cells that exhibit a microscopic image consisting of a small or non-existent head, and large diffuse tails and are considered to be heavily damaged cells, although the etiology of the hedgehogs is uncertain (see Appendix 3). Due to their appearance, % tail DNA measurements by image analysis are unreliable and therefore hedgehogs should be evaluated separately. The occurrence of hedgehogs should be noted and reported and any relevant increase thought to be due to the test chemical should be investigated and interpreted with care. Knowledge of the potential mode of action of the test chemicals may help with such considerations.

DATA AND REPORTING**Treatment of Results**

The animal is the experimental unit and therefore both individual animal data and summarized results should be presented in tabular form. Due to the hierarchical nature of the data it is recommended that the median %tail DNA for each slide is determined and the mean of the median values is calculated for each animal (12). The mean of the individual animal means is then determined to give a group mean. All of these values should be included in the report. Alternative approaches (see paragraph 53) may be used if scientifically and statistically justified. Statistical analysis can be done using a variety of approaches (58) (59) (60) (61). When selecting the statistical methods to be used, the need for transformation (e.g. log or square root) of the data and/or addition of a small number (e.g. 0,001) to all (even non-zero) values to mitigate the effects of zero cell values, should be considered as discussed in the above references. Details of analysis of treatment/sex interactions when both sexes are used, and subsequent analysis of data where either differences or no differences are found is given in Appendix 2. Data on toxicity and clinical signs should also be reported.

Acceptability Criteria

Acceptance of a test is based on the following criteria:

- (a) The concurrent negative control is considered acceptable for addition to the laboratory historical negative control database as described in paragraph 16

▼ M7

- (b) Concurrent positive controls (see paragraph 29) should induce responses that are compatible with those generated in the historical positive control database and produce a statistically significant increase compared with the concurrent negative control.
- (c) Adequate numbers of cells and doses have been analysed (paragraphs 52 and 36-38).
- (d) The criteria for the selection of highest dose are consistent with those described in paragraph 36.

Evaluation and Interpretation of Results

Providing that all acceptability criteria are fulfilled, a test chemical is considered to be clearly positive if:

- (a) at least one of the test doses exhibits a statistically significant increase compared with the concurrent negative control,
- (b) the increase is dose-related when evaluated with an appropriate trend test,
- (c) any of the results are outside the distribution of the historical negative control data for a given species, vehicle, route, tissue, and number of administrations.

When all of these criteria are met, the test chemical is then considered able to induce DNA strand breakage in the tissues studied in this test system. If only one or two of these criteria are satisfied, see paragraph 62.

Providing that all acceptability criteria are fulfilled, a test chemical is considered clearly negative if:

- (a) none of the test concentrations exhibits a statistically significant increase compared with the concurrent negative control,
- (b) there is no concentration-related increase when evaluated with an appropriate trend test.
- (c) all results are inside the distribution of the historical negative control data for a given species, vehicle, route, tissue, and number of administrations.
- (d) direct or indirect evidence supportive of exposure of, or toxicity to, the target tissue(s) has been demonstrated.

The test chemical is then considered unable to induce DNA strand breakage in the tissues studied in this test system.

There is no requirement for verification of a clearly positive or negative response.

In case the response is neither clearly negative nor clearly positive (i.e. not all the criteria listed in paragraphs 59 or 60 are met) and in order to assist in establishing the biological relevance of a result, the data should be evaluated by expert judgement and/or further investigations conducted, if scientifically justified. Scoring additional cells (where appropriate) or performing a repeat experiment possibly using optimised experimental conditions (e.g. dose spacing, other routes of administration, other sampling times or other tissues) could be useful.

In rare cases, even after further investigations, the data set will preclude making a conclusion of positive or negative results, and will therefore be concluded as equivocal.

▼M7

To assess the biological relevance of a positive or equivocal result, information on cytotoxicity at the target tissue is required (see paragraphs 54-55). Where positive or equivocal findings are observed solely in the presence of clear evidence of cytotoxicity, the study would be concluded as equivocal for genotoxicity unless there is enough information that is supportive of a definitive conclusion. In cases of a negative study outcome where there are signs of toxicity at all doses tested, further study at non-toxic doses may be advisable.

Test Report

The test report should include the following information:

Test chemical:

- source, lot number if available;
- stability of the test chemical, limit date for use, or date for re-analysis if known.

Mono-constituent substance:

- physical appearance, water solubility, and additional relevant physico-chemical properties;
- chemical identification, such as IUPAC or CAS name, CAS number, SMILES or InChI code, structural formula, purity, chemical identity of impurities as appropriate and practically feasible, etc.

Multi-constituent substance, UVCBs and mixtures:

- characterised as far as possible by chemical identity (see above), quantitative occurrence and relevant physicochemical properties of the constituents.

Solvent/vehicle:

- justification for choice of solvent/vehicle;
- solubility and stability of the test chemical in the solvent/vehicle, if known;
- preparation of dose formulations;
- analytical determinations on formulations (e.g. stability, homogeneity, nominal concentrations).

Test animals:

- species/strain used and scientific and ethical justifications for the choice;
- number, age and sex of animals;
- source, housing conditions, diet, enrichment, etc.;
- individual weight of the animals at the start and at the end of the test, including body weight range, mean and standard deviation for each group.

Test conditions:

- positive and negative (vehicle/solvent) control data;

▼M7

- results from the range-finding study (if conducted);
- rationale for dose level selection;
- details of test chemical preparation;
- details of the administration of the test chemical;
- rationale for route of administration;
- site of injection (for subcutaneous or intravenous studies);
- methods for sample preparation, where available, histopathological analyses, especially for a chemical giving a positive comet response;
- rationale for tissue selection;
- methods for verifying that the test chemical reached the target tissue, or general circulation, if negative results are obtained;
- actual dose (mg/kg body weight/day) calculated from diet/drinking water test chemical concentration (ppm) and consumption, if applicable;
- details of diet and water quality;
- detailed description of treatment and sampling schedules and justifications for the choices (e.g. toxicokinetic data, where available);
- method of pain relief, analgesia;
- method of euthanasia;
- procedures for isolating and preserving tissues;
- methods for preparing single cell/nucleus suspension;
- source and lot numbers of all reagents (where possible);
- methods for evaluating cytotoxicity;
- electrophoresis conditions;
- staining techniques used; and
- methods for scoring and measuring comets.

Results:

- General clinical observations, if any, prior to and throughout the test period for each animal;
- evidence of cytotoxicity if performed;

▼M7

- for studies longer than one week: Individual body weights during the study, including body weight range, mean and standard deviation for each group; food consumption;
- dose-response relationship, where evident;
- for each tissue/animal, the % tail DNA (or other measures, if chosen) and median values per slide, mean values per animal and mean values per group;
- concurrent and historical negative control data with ranges, means/medians and standard deviations for each tissue evaluated;
- concurrent and historical positive control data;
- for tissues other than liver, a dose-response curve using the positive control. This can be from data collected during the demonstration of proficiency (see paragraphs 16-17) and should be accompanied by a justification, with citations to current literature, for the appropriateness of the magnitude and scatter of the responses to the controls in that tissue;
- statistical analyses and methods applied; and criteria for considering a response as positive, negative or equivocal;
- frequency of hedgehogs in each group and per animal.

*Discussion of the results**Conclusion**References*

LITERATURE:

- (1) Kirkland, D., G. Speit (2008), Evaluation of the ability of a battery of three *in vitro* genotoxicity tests to discriminate rodent carcinogens and non-carcinogens III. Appropriate follow-up testing *in vivo*, *Mutation Research*, Vol. 654/2, pp. 114-32.
- (2) Brendler-Schwaab, S. *et al.* (2005), The *in vivo* Comet assay: use and status in genotoxicity testing, *Mutagenesis*, Vol. 20/4, pp. 245-54.
- (3) Burlinson, B. *et al.* (2007), Fourth International Workgroup on Genotoxicity Testing: result of the *in vivo* Comet assay workgroup, *Mutation Research*, Vol. 627/1, pp. 31-5.
- (4) Burlinson, B. (2012), The *in vitro* and *in vivo* Comet assays, *Methods in Molecular Biology*, Vol. 817, pp. 143-63.
- (5) Smith, C.C. *et al.* (2008), Recommendations for design of the rat Comet assay, *Mutagenesis*, Vol. 23/3, pp. 233-40.
- (6) Hartmann, A. *et al.* (2003), Recommendations for conducting the *in vivo* alkaline Comet assay, *Mutagenesis*, Vol. 18/1, pp. 45-51.
- (7) McKelvey-Martin, V.J. *et al.* (1993), The single cell gel electrophoresis assay (Comet assay): a European review, *Mutation Research*, Vol. 288/1, pp. 47-63.
- (8) Tice, R.R. *et al.* (2000), Single cell gel/Comet assay: guidelines for *in vitro* and *in vivo* genetic toxicology testing, *Environmental and Molecular Mutagenesis*, Vol. 35/3, pp. 206-21.

▼ **M7**

- (9) Singh, N.P. *et al.* (1988), A simple technique for quantitation of low levels of DNA damage in individual cells, *Experimental Cell Research*, Vol. 175/1, pp. 184-91.
- (10) Rothfuss, A. *et al.* (2010), Collaborative study on fifteen compounds in the rat-liver Comet assay integrated into 2- and 4-week repeat-dose studies, *Mutation Research*, Vol., 702/1, pp. 40-69.
- (11) OECD (2016). Overview of the set of OECD Genetic Toxicology Test Guidelines and updates performed in 2014-2015. ENV Publications. Series on Testing and Assessment, No. 234, OECD, Paris.
- (12) OECD (2014), *Reports of the JaCVAM initiative international pre-validation and validation studies of the in vivo rodent alkaline comet assay for the detection of genotoxic carcinogens*, Series on Testing and Assessment, Nos. 195 and 196, OECD Publishing, Paris.
- (13) Olive, P.L., J.P. Banath, R.E. Durand (1990), Heterogeneity in radiation-induced DNA damage and repair in tumor and normal cells using the 'Comet' assay, *Radiation Research*, Vol. 122/1, pp. 86-94.
- (14) Tice, R.R., G.H. Strauss (1995), The single cell gel electrophoresis/Comet assay: a potential tool for detecting radiation-induced DNA damage in humans, *Stem Cells*, Vol. 13/1, pp. 207-14.
- (15) Collins, A.R (2004), The Comet assay for DNA damage and repair: principles, applications, and limitations, *Molecular Biotechnology*, Vol. 26/3, pp. 249-61.
- (16) Rothfuss, A. *et al.* (2011), Improvement of *in vivo* genotoxicity assessment: combination of acute tests and integration into standard toxicity testing, *Mutation Research/Genetic Toxicology and Environmental Mutagenesis*, Vol. 723/2, pp. 108-20.
- (17) Kushwaha, S. *et al.* (2010), Evaluation of multi-organ DNA damage by Comet assay from 28 days repeated dose oral toxicity test in mice: A practical approach for test integration in regulatory toxicity testing, *Regulatory Toxicology and Pharmacology*, Vol. 58/1, pp. 145-54.
- (18) Vasquez, M.Z. (2010), Combining the *in vivo* Comet and micronucleus assays: a practical approach to genotoxicity testing and data interpretation, *Mutagenesis*, Vol. 25/2, pp. 187-99.
- (19) Bowen, D.E. (2011), Evaluation of a multi-endpoint assay in rats, combining the bone-marrow micronucleus test, the Comet assay and the flow-cytometric peripheral blood micronucleus test, *Mutation Research*, Vol. 722/1, pp. 7-19.
- (20) Recio, L. *et al.* (2010), Dose-response assessment of four genotoxic chemicals in a combined mouse and rat micronucleus (MN) and Comet assay protocol, *The Journal of Toxicological Science*, Vol. 35/2, pp. 149-62.
- (21) O'Donovan, M., B. Burlinson (2013), Maximum dose levels for the rodent comet assay to examine damage at the site of contact or to the gastrointestinal tract, *Mutagenesis*, Vol. 28/6, pp. 621-3.
- (22) Hartmann, A. (2004), **Use of the alkaline *in vivo* Comet assay for mechanistic genotoxicity investigations**, *Mutagenesis*, Vol. 19/1, pp. 51-9.
- (23) Nesslany, F. (2007), *In vivo* Comet assay on isolated kidney cells to distinguish genotoxic carcinogens from epigenetic carcinogens or cytotoxic compounds, *Mutation Research/Genetic Toxicology and Environmental Mutagenesis*, Vol. 630/1, pp. 28-41.
- (24) Brendler-Schwaab, S.Y., B.A. Herbold (1997), A new method for the enrichment of single renal proximal tubular cells and their first use in the Comet assay, *Mutation Research/Genetic Toxicology and Environmental Mutagenesis*, Vol. 393/1-2, pp. 175-8.

▼ M7

- (25) Toyozumi, T. *et al.* (2011), Use of the *in vivo* skin Comet assay to evaluate the DNA-damaging potential of chemicals applied to the skin, *Mutation Research/Genetic Toxicology and Environmental Mutagenesis*, Vol. 726/2, pp. 175-80.
- (26) Struwe, M. *et al.* (2008), Detection of photogenotoxicity in skin and eye in rat with the photo Comet assay, *Photochemical and Photobiological Sciences*, Vol. 7/2, pp. 240-9.
- (27) Wada, K. *et al.* (2012), A comparison of cell-collecting methods for the Comet assay in urinary bladders of rats, *Mutation Research/Genetic Toxicology and Environmental Mutagenesis*, Vol. 742/1-2, pp. 26-30.
- (28) Wang, A. *et al.* (2007), Measurement of DNA damage in rat urinary bladder transitional cells: improved selective harvest of transitional cells and detailed Comet assay protocols, *Mutation Research/Genetic Toxicology and Environmental Mutagenesis*, Vol. 634/ 1-2, pp. 51-9.
- (29) Burlinson, B. *et al.* (2007), *In Vivo* Comet Assay Workgroup, part of the Fourth International Workgroup on Genotoxicity Testing. Fourth International Workgroup on Genotoxicity testing: results of the *in vivo* Comet assay workgroup, *Mutation Research/Genetic Toxicology and Environmental Mutagenesis*, Vol. 627/1, pp. 31-5.
- (30) Jackson, P. *et al.* (2012), Pulmonary exposure to carbon black by inhalation or instillation in pregnant mice: effects on liver DNA strand breaks in dams and offspring, *Nanotoxicology*, Vol. 6/5, pp. 486-500.
- (31) Sasaki, Y.F. *et al.* (2000), The comet assay with multiple mouse organs: comparison of Comet assay results and carcinogenicity with 208 chemicals selected from the IARC monographs and U.S. NTP Carcinogenicity Database, *Critical Reviews in Toxicology*, Vol. 30/6, pp. 629-799.
- (32) Sekihashi, K. *et al.* (2002), Comparative investigations of multiple organs of mice and rats in the Comet assay, *Mutation Research*, Vol. 517/1-2, pp. 53-74.
- (33) Speit, G, M. Vasquez, A. Hartmann (2009), **The comet assay as an indicator test for germ cell genotoxicity**, *Mutation Research*, Vol. 681/1, pp. 3-12.
- (34) Zheng, H., P.L. Olive (1997), Influence of oxygen on radiation-induced DNA damage in testicular cells of C3H mice, *International Journal of Radiation Biology*, Vol. 71/3, pp. 275-282.
- (35) Cordelli, E. *et al.* (2003), Evaluation of DNA damage in different stages of mouse spermatogenesis after testicular X irradiation, *Journal of Radiation Research*, Vol. 160/4, pp. 443-451.
- (36) Merk, O., G. Speit (1999), Detection of crosslinks with the Comet assay in relationship to genotoxicity and cytotoxicity, *Environmental and Molecular Mutagenesis*, Vol. 33/2, pp. 167-72.
- (37) Pfuhrer, S., H.U. Wolf (1996), Detection of DNA-crosslinking agents with the alkaline Comet assay, *Environmental and Molecular Mutagenesis*, Vol. 27/3, pp. 196-201.
- (38) Wu, J.H., N.J. Jones (2012), Assessment of DNA interstrand crosslinks using the modified alkaline Comet assay, *Methods in Molecular Biology*, Vol. 817, pp. 165-81.
- (39) Spanswick, V.J., J.M. Hartley, J.A. Hartley (2010), **Measurement of DNA interstrand crosslinking in individual cells using the Single Cell Gel Electrophoresis (Comet) assay**, *Methods in Molecular Biology*, Vol. 613, pp. 267-282.

▼ M7

- (40) Kumaravel, T.S., A.N. Jha (2006), Reliable Comet assay measurements for detecting DNA damage induced by ionizing radiation and chemicals, *Mutation Research/Genetic Toxicology and Environmental Mutagenesis*, Vol. 605(1-2), pp. 7-16.
- (41) Burlinson, B. *et al.* (2007), Fourth International Workgroup on Genotoxicity Testing: result of the *in vivo* Comet assay workgroup, *Mutation Research*, Vol.627/1, pp. 31-5.
- (42) Kumaravel, T.S. *et al.* (2009), Comet Assay measurements: a perspective, *Cell Biology and Toxicology*, Vol. 25/1, pp. 53-64.
- (43) Ersson, C., L. Möller (2011), The effects on DNA migration of altering parameters in the Comet assay protocol such as agarose density, electrophoresis conditions and durations of the enzyme or the alkaline treatments, *Mutagenesis*, Vol. 26/6, pp. 689-95.
- (44) Møller, P. *et al.* (2010), Assessment and reduction of Comet assay variation in relation to DNA damage: studies from the European Comet Assay Validation Group, *Mutagenesis*, Vol. 25/2, pp. 109-11.
- (45) Forchhammer, L. *et al.* (2010), Variation in the measurement of DNA damage by Comet assay measured by the ECVAG inter-laboratory validation trial, *Mutagenesis*, Vol. 25/2, pp. 113-23.
- (46) Azqueta, A. *et al.* (2011), Towards a more reliable comet assay: Optimising agarose concentration, unwinding time and electrophoresis conditions, *Mutation Research*, Vol. 724/1-2, pp. 41-45.
- (47) Hayashi, M. *et al.* (2011), Compilation and use of genetic toxicity historical control data, *Mutation Research*, Vol. 723/2, pp. 87-90.
- (48) Ryan, T. P. (2000), *Statistical Methods for Quality Improvement*, John Wiley and Sons, New York 2nd ed.
- (49) Appendix A of the European Convention for the Protection of Vertebrate Animals used for Experimental and other Scientific Purposes (ETS No. 123)
- (50) Chapter B.8 of this Annex: *Subacute Inhalation Toxicity: 28-Day Study*.
- (51) Chapter B.29 of this Annex: *Subchronic Inhalation Toxicity: 90-day Study*.
- (52) Blakey, D.H., G.R. Douglas (1984), Transient DNA lesions induced by benzo[a]pyrene in Chinese hamster ovary cells, *Mutation Research*, Vol. 140/2-3, pp. 141-45.
- (53) Blakey, D.H., G.R. Douglas (1990), The role of excision repair in the removal of transient benzo[a]pyrene-induced DNA lesions in Chinese hamster ovary cells, *Mutation Research*, Vol. 236/1, pp. 35-41.
- (54) OECD (2002), 'Guidance Document on the Recognition, Assessment and Use of Clinical Signs as Humane Endpoints for Experimental Animals Used in Safety Evaluation', OECD Environment, Health and Safety Publications (EHS), Series on Testing and Assessment, No. 19, OECD Publishing, Paris.
- (55) Nakajima, M. (2012), Tissue sample preparation for *in vivo* rodent alkaline Comet assay, *Genes and Environment*, Vol. 34/1, pp. 50-4.
- (56) Hartmann, A. *et al.* (2003), Recommendations for conducting the *in vivo* alkaline Comet assay, *Mutagenesis*, Vol.18/1, pp.45-51.
- (57) Atlas of Comet Assay Images, Scientist Press Co., Ltd., Tokyo, Japan.
- (58) Lovell, D.P., G. Thomas, R. Dubow (1999), Issues related to the experimental design and subsequent statistical analysis of *in vivo* and *in vitro* Comet studies, *Teratogenesis Carcinogenesis Mutagenesis*, Vol. 19/2, pp. 109-19.

▼ M7

- (59) Wiklund, S.J., E. Agurell (2003), Aspects of design and statistical analysis in the Comet assay, *Mutagenesis*, Vol. 18/2, pp. 167-75.
- (60) Bright, J. *et al.* (2011), Recommendations on the statistical analysis of the Comet assay, *Pharmaceutical Statistics*, Vol. 10/6, pp. 485-93.
- (61) Lovell, D.P., T. Omori (2008), Statistical issues in the use of the Comet assay, *Mutagenesis*, Vol. 23/3, pp. 171-82.

▼ M7*Appendix 1*

DEFINITIONS:

Alkaline single cell gel electrophoresis: Sensitive technique for the detection of primary DNA damage at the level of individual cell/nucleus.

Chemical: A substance or a mixture.

Comet: The shape that nucleoids adopt after submitted to one electrophoretic field, due to its similarity to comets: the head is the nucleus and the tail is constituted by the DNA migrating out of the nucleus in the electric field.

A critical variable/parameter: This is a protocol variable for which a small change can have a large impact on the conclusion of the assay. Critical variables can be tissue-specific. Critical variables should not be altered, especially within a test, without consideration of how the alteration will alter an assay response, for example as indicated by the magnitude and variability in positive and negative controls. The test report should list alterations of critical variables made during the test or compared to the standard protocol for the laboratory and provide a justification for each alteration.

Tail intensity or % tail DNA: This corresponds to the intensity of the comet tail relative to the total intensity (head plus tail). It reflects the amount of DNA breakage, expressed as a percentage.

Test chemical: Any substance or mixture tested using this test method.

UVCB: Substances of unknown or variable composition, complex reaction products or biological materials.

▼ **M7***Appendix 2***THE FACTORIAL DESIGN FOR IDENTIFYING SEX DIFFERENCES IN THE *IN VIVO* COMET ASSAY****The factorial design and its analysis**

In this design, a minimum of 5 males and 5 females are tested at each concentration level resulting in a design using a minimum of 40 animals (20 males and 20 females, plus relevant positive controls.)

The design, which is one of the simpler factorial designs, is equivalent to a two-way analysis of variance with sex and concentration level as the main effects. The data can be analysed using many standard statistical software packages such as SPSS, SAS, STATA, Genstat as well as using R.

The analysis partitions the variability in the dataset into that between the sexes, between the concentrations and that related to the interaction between the sexes and the concentrations. Each of the terms is tested against an estimate of the variability between the replicate animals within the groups of animals of the same sex given the same concentration. Full details of the underlying methodology are available in many standard statistical textbooks (see references) and in the 'help' facilities provided with statistical packages.

The analysis proceeds by inspecting the sex x concentration interaction term in the ANOVA table⁽¹⁾. In the absence of a significant interaction term the combined values across sexes or across concentration levels provide valid statistical tests between the levels based upon the pooled within group variability term of the ANOVA.

The analysis continues by partitioning the estimate of the between concentrations variability into contrasts which provide for a test for linear and quadratic contrasts of the responses across the concentration levels. When there is a significant sex x concentration interaction this term can also be partitioned into linear x sex and quadratic x sex interaction contrasts. These terms provide tests of whether the concentration responses are parallel for the two sexes or whether there is a differential response between the two sexes.

The estimate of the pooled within group variability can be used to provide pair-wise tests of the difference between means. These comparisons could be made between the means for the two sexes and between the means for the different concentration level such as for comparisons with the negative control levels. In those cases where there is a significant interaction comparisons can be made between the means of different concentrations within a sex or between the means of the sexes at the same concentration.

References

There are many statistical textbooks which discuss the theory, design, methodology, analysis and interpretation of factorial designs ranging from the simplest two factor analyses to the more complex forms used in Design of Experiment methodology. The following is a non-exhaustive list. Some books provide worked examples of comparable designs, in some cases with code for running the analyses using various software packages.

⁽¹⁾ Statisticians who take a modelling approach such as using General Linear Models (GLMs) may approach the analysis in a different but comparable way but will not necessarily derive the traditional ANOVA table, which dates back to algorithmic approaches to calculating the statistics developed in a pre-computer age.

▼M7

- (1) Box, G.E.P, Hunter, W.G. and Hunter, J.S. (1978). *Statistics for Experimenters. An Introduction to Design, Data Analysis, and Model Building*. New York: John Wiley & Sons.
- (2) Box G.E.P. & Draper, N.R. (1987) *Empirical model-building and response surfaces*. John Wiley & Sons Inc.
- (3) Doncaster, C.P. & Davey, A.J.H. (2007) *Analysis of Variance and Covariance: How to choose and Construct Models for the Life Sciences*. Cambridge University Press.
- (4) Mead, R. (1990) *The Design of Experiments. Statistical principles for practical application*. Cambridge University Press.
- (5) Montgomery D.C. (1997) *Design and Analysis of Experiments*. John Wiley & Sons Inc.
- (6) Winer, B.J. (1971) *Statistical Principles in Experimental Design*. McGraw Hill.
- (7) Wu, C.F.J & Hamada, M.S. (2009) *Experiments: Planning, Analysis and Optimization*. John Wiley & Sons Inc.

▼ M7

Appendix 3

CURRENT LIMITATIONS OF THE ASSAY

Due to the current status of knowledge, several limitations are associated with the *in vivo* comet assay. It is expected that these limitations will be reduced or more narrowly defined as there is more experience with application of the assay to answer safety issues in a regulatory context.

1. Some types of DNA damage may be short-lived, i.e. may be repaired too quickly to be observed 24 hours or more after the last dose. There is no identifiable list of the types of short-lived damages, nor of the chemicals which are likely to cause this type of damage, nor is it known over what time period this type of damage can be detected. The optimum sampling time(s) may also be chemical- or route-specific and sampling times should be determined from kinetic data (for example the time, T_{max} , at which the peak plasma or tissue concentration is achieved), when such data are available. Most of the validation studies supporting this test method specified necropsy 2 or 3 hours following administration of the final dose. Most studies in the published literature describe administration of the final dose between 2 and 6 hours prior to sacrifice. Therefore, these experiences were used as the basis for the recommendation in the test method that, in the absence of data indicating otherwise, the final dose should be administered at a specified time point between 2 and 6 hours prior to necropsy.
2. There are no identifiable study data that examine the sensitivity of the test for the detection of short-lived DNA damage following administration in food or drinking water compared to administration by gavage. DNA damage has been detected following administration in feed and drinking water, but there are relatively few such reports compared to the much greater experience with gavage and i.p. administration. Thus the sensitivity of the assay may be reduced for chemicals which induce short-lived damage administered through feed or drinking water.
3. No inter-laboratory studies have been conducted in tissues other than liver and stomach, therefore no recommendation has been established for how to achieve a sensitive and reproducible response in tissues other than liver, such as expected positive and negative control ranges. For the liver, agreement on setting a lower limit to the negative control value also could not be reached.
4. Although there are several publications demonstrating the confounding effect of cytotoxicity *in vitro*, very little data have been published *in vivo* and therefore no single measure of cytotoxicity could be recommended. Histopathological changes such as inflammation, cell infiltration, apoptotic or necrotic changes have been associated with increases in DNA migration however, as demonstrated by the JaCVAM validation trial (OECD, 2014), these changes do not always result in positive comet findings and consequently no definitive list of histopathological changes that are always associated with increased DNA migration is available. Hedgehogs (or clouds, ghost cells) have previously been suggested as an indicator of cytotoxicity, however, the etiology of the hedgehogs is uncertain. Data exist which suggest that they can be caused by chemical-related cytotoxicity, mechanical/enzyme-induced damage initiated during sample preparation (Guerard *et al.*, 2014) and/or a more extreme effect of test chemical genotoxicity. Other data seem to show they are due to extensive, but perhaps repairable DNA damage (Lorenzo *et al.*, 2013).

▼ M7

5. Tissues or cell nuclei have been successfully frozen for later analysis. This usually results in a measurable effect on the response to the vehicle and positive control (Recio *et al.*, 2010; Recio *et al.*, 2012; Jackson *et al.*, 2013). If used, the laboratory should demonstrate competency in freezing methodologies and confirm acceptable low ranges of % tail DNA in target tissues of vehicle treated animals, and that positive responses can still be detected. In the literature, the freezing of tissues has been described using different methods. However, currently there is no agreement on how to best freeze and thaw tissues, and how to assess whether a potentially altered response may affect the sensitivity of the test.
6. Recent work demonstrates that the list of critical variables is expected to continue to become shorter and the parameters for critical variables more precisely defined (Guerard *et al.*, 2014).

References

- (1) Guerard, M., C. Marchand, U. Plappert-Helbig (2014), Influence of Experimental Conditions on Data Variability in the Liver Comet Assay, *Environmental and Molecular Mutagenesis*, Vol. 55/2, pp. 114-21.
- (2) Jackson, P. *et al.* (2013), Validation of use of frozen tissues in high-throughput comet assay with fully-automatic scoring, *Mutagenesis*, Vol. 28/6, pp. 699-707.
- (3) Lorenzo, Y. *et al.* (2013), The comet assay, DNA damage, DNA repair and cytotoxicity: hedgehogs are not always dead, *Mutagenesis*, Vol. 28/4, pp. 427-32.
- (4) OECD (2014), *Reports of the JaCVAM initiative international pre-validation and validation studies of the in vivo rodent alkaline comet assay for the detection of genotoxic carcinogens*, Series on Testing and Assessment, Nos. 195 and 196, OECD Publishing, Paris.
- (5) Recio L, Hobbs C, Caspary W, Witt KL, (2010), Dose-response assessment of four genotoxic chemicals in a combined mouse and rat micronucleus (MN) and Comet assay protocol, *J. Toxicol. Sci.* 35:149-62.
- (6) Recio, L. *et al.* (2012), Comparison of Comet assay dose-response for ethyl methanesulfonate using freshly prepared versus cryopreserved tissues, *Environmental and Molecular Mutagenesis*, Vol. 53/2, pp. 101-13.

▼M8**B.63. REPRODUCTION/DEVELOPMENTAL TOXICITY SCREENING TEST**

INTRODUCTION

1. This test method is equivalent to OECD test guideline (TG) 421 (2016). OECD guidelines for the testing of chemicals are periodically reviewed in the light of scientific progress. The original screening test guideline 421 was adopted in 1995, based on a protocol for a 'Preliminary Reproduction Toxicity Screening Test' discussed in two expert meetings, in London in 1990 (1) and in Tokyo in 1992 (2).
2. This test method has been updated with endocrine disruptor relevant endpoints, as a follow up to the high-priority activity initiated at OECD in 1998 to revise existing test guidelines and to develop new test guidelines for the screening and testing of potential endocrine disruptors (3). OECD TG 407 (Repeated Dose 28-Day Oral Toxicity Study in Rodents, Chapter B.7 of this Annex) for example, was enhanced in 2008 by parameters suitable to detect endocrine activity of test chemicals. The objective in updating TG 421 was to include some endocrine disruptor relevant endpoints in screening TGs where the exposure periods cover some of the sensitive periods during development (pre- or early postnatal periods).
3. The selected additional endocrine disruptor relevant endpoints, also part of TG 443 (Extended One Generation Reproductive Toxicity Study, Chapter B.56 of this Annex), were included in TG 421 based on a feasibility study addressing scientific and technical questions related to their inclusion, as well as possible adaptations of the test design needed for their inclusion (4).
4. This test method is designed to generate limited information concerning the effects of a test chemical on male and female reproductive performance such as gonadal function, mating behaviour, conception, development of the conceptus and parturition. It is not an alternative to, nor does it replace the existing test methods B.31, B.34, B.35 or B.56.

INITIAL CONSIDERATIONS

5. This screening test method can be used to provide initial information on possible effects on reproduction and/or development, either at an early stage of assessing the toxicological properties of chemicals, or on chemicals of concern. It can also be used as part of a set of initial screening tests for existing chemicals for which little or no toxicological information is available, as a dose range finding study for more extensive reproduction/developmental studies, or when otherwise considered relevant. In conducting the study, the guiding principles and considerations outlined in the OECD guidance document no 19 on the recognition, assessment, and use of clinical signs as humane endpoints for experimental animals used in safety evaluations (5) should be followed.

▼M8

6. This test method does not provide complete information on all aspects of reproduction and development. In particular, it offers only limited means of detecting post-natal manifestations of pre-natal exposure, or effects that may be induced during post-natal exposure. Due (amongst other reasons) to the relatively small numbers of animals in the dose groups, the selectivity of the end points, and the short duration of the study, this method will not provide evidence for definite claims of no effects. Moreover, in the absence of data from other reproduction/developmental toxicity tests, positive results are useful for initial hazard assessment and contribute to decisions with respect to the necessity and timing of additional testing.
7. The results obtained by the endocrine related parameters should be seen in the context of the 'OECD Conceptual Framework for Testing and Assessment of Endocrine Disrupting Chemicals' (6). In this Conceptual Framework, the enhanced OECD TG 421 is contained in level 4 as an *in vivo* assay providing data on adverse effects on endocrine relevant endpoints. An endocrine signal might not however be considered sufficient evidence on its own that the test chemical is an endocrine disruptor.
8. This test method assumes oral administration of the test chemical. Modifications may be required if other routes of exposure are used.
9. Before use of the test method on a mixture for generating data for an intended regulatory purpose, it should be considered whether, and if so why, it may provide adequate results for that purpose. Such considerations are not needed, when there is a regulatory requirement for testing of the mixture.
10. Definitions used are given in Appendix 1.

PRINCIPLE OF THE TEST

11. The test chemical is administered in graduated doses to several groups of males and females. Males should be dosed for a minimum of four weeks and up to and including the day before scheduled kill (this includes a minimum of two weeks prior to mating, during the mating period and, approximately, two weeks post-mating). In view of the limited pre-mating dosing period in males, fertility may not be a particular sensitive indicator of testicular toxicity. Therefore, a detailed histological examination of the testes is essential. The combination of a pre-mating dosing period of two weeks and subsequent mating/fertility observations with an overall dosing period of at least four weeks, followed by detailed histopathology of the male gonads, is considered sufficient to enable detection of the majority of effects on male fertility and spermatogenesis.
12. Females should be dosed throughout the study. This includes two weeks prior to mating (with the objective of covering at least two complete oestrous cycles), the variable time to conception, the duration of pregnancy and at least thirteen days after delivery, up to and including the day before scheduled kill.
13. Duration of study, following acclimatisation and pre-dosing oestrous cycle evaluation, is dependent on the female performance and is approximately 63 days, [at least 14 days pre-mating, (up to) 14 days mating, 22 days gestation, 13 days lactation].

▼M8

14. During the period of administration, the animals are observed closely each day for signs of toxicity. Animals which die or are killed during the test period are necropsied and, at the conclusion of the test, surviving animals are killed and necropsied.

DESCRIPTION OF THE METHOD**Selection of animal species**

15. This test method is designed for use with the rat. If the parameters specified within this test method are investigated in another rodent species a detailed justification should be given. In the international validation program for the detection of endocrine disrupters in OECD TG 407 (corresponding to Chapter B.7 of this Annex), the rat was the only species used. Strains with low fecundity or well-known high incidence of developmental defects should not be used. Healthy virgin animals, not subjected to previous experimental procedures, should be used. The test animals should be characterised as to species, strain, sex, weight and age. At the commencement of the study the weight variation of animals used should be minimal and not exceed 20 % of the mean weight of each sex. Where the study is conducted as a preliminary study to a long-term or a full-generation study, it is preferable that animals from the same strain and source are used in both studies.

Housing and feeding

16. All procedures should conform to local standards of laboratory animal care. The temperature in the experimental animal room should be 22 °C (\pm 3 °). Although the relative humidity should be at least 30 % and preferably not exceed 70 % other than during room cleaning, the aim should be 50-60 %. Lighting should be artificial, the photoperiod being 12 hours light, 12 hours dark. For feeding, conventional laboratory diets may be used with an unlimited supply of drinking water. The choice of diet may be influenced by the need to ensure a suitable admixture of a test chemical when administered by this method.
17. Animals should be group housed in small groups of the same sex; animals may be housed individually if scientifically justified. For group caging, no more than five animals should be housed per cage. Mating procedures should be carried out in cages suitable for the purpose. Pregnant females should be caged individually and provided with nesting materials. Lactating females will be caged individually with their offspring.
18. The feed should be regularly analysed for contaminants. A sample of the diet should be retained until finalisation of the report.

Preparation of the animals

19. Healthy young adult animals are randomly assigned to the control and treatment groups. Cages should be arranged in such a way that possible effects due to cage placement are minimised. The animals are uniquely identified and kept in their cages for at least five days prior to the start of the study to allow for acclimatisation to the laboratory conditions.

Preparation of doses

20. It is recommended that the test chemical be administered orally unless other routes of administration are considered more appropriate. When the oral route is selected, the test chemical is usually administered by gavage; however, alternatively, test chemicals may be administered via the diet or drinking water.

▼M8

21. Where necessary, the test chemical is dissolved or suspended in a suitable vehicle. It is recommended that, wherever possible, the use of an aqueous solution/suspension be considered first, followed by consideration of a solution/emulsion in oil (e.g. corn oil) and then by possible solution in other vehicles. For vehicles other than water the toxic characteristics of the vehicle should be known. The stability and homogeneity of the test chemical in the vehicle should be determined.

PROCEDURE**Number and sex of animals**

22. It is recommended that each group be started with at least 10 males and 12-13 females. Females will be evaluated pre-exposure for oestrous cyclicity and animals that fail to exhibit typical 4-5 day cycles will not be included in the study; therefore, extra females are recommended in order to yield 10 females per group. Except in the case of marked toxic effects, it is expected that this will provide at least 8 pregnant females per group which normally is the minimum acceptable number of pregnant females per group. The objective is to produce enough pregnancies and offspring to assure a meaningful evaluation of the potential of the test chemical to affect fertility, pregnancy, maternal and suckling behaviour, and growth and development of the F₁ offspring from conception to day 13 post-partum.

Dosage

23. Generally, at least three test groups and a control group should be used. Dose levels may be based on information from acute toxicity tests or on results from repeated dose studies. Except for treatment with the test chemical, animals in the control group should be handled in an identical manner to the test group subjects. If a vehicle is used in administering the test chemical, the control group should receive the vehicle in the highest volume used.
24. Dose levels should be selected taking into account any existing toxicity and (toxico-) kinetic data available. It should also be taken into account that there may be differences in sensitivity between pregnant and non-pregnant animals. The highest dose level should be chosen with the aim of inducing toxic effects but not death or severe suffering. Thereafter, a descending sequence of dose levels should be selected with a view to demonstrating any dosage related response and no-observed-adverse effects (NOAEL) at the lowest dose level. Two to four fold intervals are frequently optimal for setting the descending dose levels and addition of a fourth test group is often preferable to using very large intervals (e.g. more than a factor of 10) between dosages.
25. In the presence of observed general toxicity (e.g. reduced body weight, liver, heart, lung or kidney effects, etc.) or other changes that may not be toxic responses (e.g. reduced food intake, liver enlargement), observed effects on endocrine sensitive endpoints should be interpreted with caution.

Limit test

26. If an oral study at one dose level of at least 1 000 mg/kg body weight/day or, for dietary or drinking water administration, an equivalent percentage in the diet or drinking water, using the procedures described for this study, produces no observable toxic effects and if toxicity would not be expected based upon data from structurally related substances, then a full study using several dose levels may not be considered necessary. The limit test applies except when human exposure indicates the need for a higher oral dose level to be used. For other types of administration, such as inhalation or dermal application, the physical chemical properties of the test chemicals often may dictate the maximum attainable concentration.

▼M8**Administration of doses**

27. The animals are dosed with the test chemical daily for 7 days a week. When the test chemical is administered by gavage, this should be done in a single dose to the animals using a stomach tube or a suitable intubation cannula. The maximum volume of liquid that can be administered at one time depends on the size of the test animal. The volume should not exceed 1 ml/100 g body weight, except in the case of aqueous solutions where 2 ml/100 g body weight may be used. Except for irritating or corrosive test chemicals which will normally reveal exacerbated effects with higher concentrations, variability in test volume should be minimised by adjusting the concentration to ensure a constant volume at all dose levels.

28. For test chemical administered via the diet or drinking water, it is important to ensure that the quantities of the test chemical involved do not interfere with normal nutrition or water balance. When the test chemical is administered in the diet either a constant dietary concentration (ppm) or a constant dose level in terms of the animals' body weight may be used; the alternative used should be specified. For a test chemical administered by gavage, the dose should be given at similar times each day, and adjusted at least weekly to maintain a constant dose level in terms of animal body weight.

Experimental schedule

29. Dosing of both sexes should begin at least 2 weeks prior to mating, after they have been acclimatised for at least five days and females have been screened for normal oestrous cycles (in a 2 weeks pre-treatment period). The study should be scheduled in such a way that oestrous cycle evaluation begins soon after the animals have attained full sexual maturity. This may vary slightly for different strains of rats in different laboratories, e.g. Sprague Dawley rats 10 weeks of age, Wistar rats about 12 weeks of age. Dams with offspring should be killed on day 13 post-partum, or shortly thereafter. The day of birth (viz. when parturition is complete) is defined as day 0 post-partum. Females showing no-evidence of copulation are killed 24-26 days after the last day of the mating period. Dosing is continued in both sexes during the mating period. Males should further be dosed after the mating period at least until the minimum total dosing period of 28 days has been completed. They are then killed, or, alternatively, are retained and continued to be dosed for the possible conduction of a second mating if considered appropriate.

30. Daily dosing of the parental females should continue throughout pregnancy and at least up to, and including, day 13 post-partum or the day before sacrifice. For studies where the test chemical is administered by inhalation or by the dermal route, dosing should be continued at least up to, and including, day 19 of gestation, and dosing should be re-initiated as soon as possible and not later than PND 4.

31. A diagram of the experimental schedule is given in Appendix 2.

Mating procedure

32. Normally, 1:1 (one male to one female) matings should be used in this study. Exceptions can arise in the case of occasional deaths of males. The female should be placed with the same male until evidence of copulation is observed or two weeks have elapsed. Each morning the females should be examined for the presence of sperm or a vaginal plug. Day 0 of pregnancy is defined as the day on which mating evidence is confirmed (a vaginal plug or sperm is found). In case pairing is unsuccessful, re-mating of females with proven males of the same group could be considered.

▼ M8**Litter size**

33. On day 4 after birth, the size of each litter may be adjusted by eliminating extra pups by random selection to yield, as nearly as possible, four or five pups per sex per litter depending on the normal litter size in the strain of rats used. Blood samples should be collected from two of the surplus pups, pooled, and used for determination of serum T4 levels. Selective elimination of pups, e.g. based upon body weight, or anogenital distance (AGD) is not appropriate. Whenever the number of male or female pups prevents having four or five of each sex per litter, partial adjustment (for example, six males and four females) is acceptable. No pups will be eliminated when litter size will drop below the culling target (8 or 10 pups/litter). If there is only one pup available above the culling target, only one pup will be eliminated and used for blood collection for possible serum T4 assessments.

34. If litter size is not adjusted, two pups per litter are sacrificed on day 4 after birth and blood samples are taken for measurement of serum thyroid hormone concentrations. If possible the two pups per litter should be female pups to reserve male pups for nipple retention evaluations except in the event that removing these pups leaves no remaining females for assessment at termination. No pups will be eliminated when litter size will drop below 8 or 10 pups/litter (depending on the normal litter size in the strain of rats used). If there is only one pup available above the normal litter size, only one pup will be eliminated and used for blood collection for possible serum T4 assessments.

In life observations*Clinical observations*

35. Throughout the test period, general clinical observations should be made at least once a day, and more frequently when signs of toxicity are observed. They should be made preferably at the same time(s) each day, considering the peak period of anticipated effects after dosing. Pertinent behavioural changes, signs of difficult or prolonged parturition and all signs of toxicity, including mortality, should be recorded. These records should include time of onset, degree and duration of toxicity signs.

Body weight and food/water consumption

36. Males and females should be weighed on the first day of dosing, at least weekly thereafter, and at termination. During pregnancy, females should be weighed on days 0, 7, 14 and 20 and within 24 hours of parturition (day 0 or 1 post-partum) and at least day 4 and 13 post-partum. These observations should be reported individually for each adult animal.

37. During pre-mating, pregnancy and lactation, food consumption should be measured at least weekly. The measurement of food consumption during mating is optional. Water consumption during these periods should also be measured when the test chemical is administered via drinking water.

Oestrous cycles

38. Oestrous cycles should be monitored before treatment starts to select for the study females with regular cyclicity (see paragraph 22). Vaginal smears should also be monitored daily from the beginning of the treatment period until evidence of mating. If there is concern about acute stress effects that

▼M8

could alter oestrous cycles with the initiation of dosing, laboratories can expose test animals for 2 weeks, then collect vaginal smears daily to monitor oestrous cycle for a minimum of two weeks during the pre-mating period with continued monitoring into the mating period until there is evidence of mating. When obtaining vaginal/cervical cells, care should be taken to avoid disturbance of mucosa, which could induce pseudo-pregnancy (7) (8).

Offspring parameters

39. The duration of gestation should be recorded and is calculated from day 0 of pregnancy. Each litter should be examined as soon as possible after delivery to establish the number and sex of pups, stillbirths, live births, runts (pups that are significantly smaller than corresponding control pups) and the presence of gross abnormalities.
40. Live pups should be counted and sexed and litters weighed within 24 hours of parturition (day 0 or 1 post-partum) and at least on day 4 and 13 post-partum. In addition to the observations described in paragraph 35, any abnormal behaviour of the offspring should be recorded.
41. The AGD of each pup should be measured on the same postnatal day between PND 0 through PND 4. Pup body weight should be collected on the day the AGD is measured and the AGD should be normalised to a measure of pup size, preferably the cube root of body weight (9). The number of nipples/areolae in male pups should be counted on PND 12 or 13 as recommended in OECD GD 151 (10).

Clinical biochemistry

42. Blood samples from a defined site are taken based on the following schedule:
 - from at least two pups per litter on day 4 after birth, if the number of pups allows (see paragraphs 33-34)
 - from all dams and at least two pups per litter at termination on day 13, and
 - from all adult males, at termination,

All blood samples are stored under appropriate conditions. Blood samples from the day 13 pups and the adult males are assessed for serum levels for thyroid hormones (T4). Further assessment of T4 in blood samples from the dams and day 4 pups is done if relevant. As an option other hormones may be measured if relevant. Pup blood can be pooled by litter for thyroid hormone analyses. Thyroid hormones (T4 and TSH) should preferably be measured as 'total'.

43. The following factors may influence the variability and the absolute concentrations of the hormone determinations:
 - time of sacrifice because of diurnal variation of hormone concentrations
 - method of sacrifice to avoid undue stress to the animals that may affect hormone concentrations
 - test kits for hormone determinations that may differ by their standard curves.

▼M8

44. Plasma samples specifically intended for hormone determination should be obtained at a comparable time of the day. The numerical values obtained when analysing hormone concentrations differ with various commercial assay kits.

Pathology*Gross necropsy*

45. At the time of sacrifice or death during the study, the adult animals should be examined macroscopically for any abnormalities or pathological changes. Special attention should be paid to the organs of the reproductive system. The number of implantation sites should be recorded. Vaginal smears should be examined in the morning on the day of necropsy to determine the stage of the oestrous cycle and allow correlation with histopathology of ovaries.
46. The testes and epididymides as well as prostate and seminal vesicles with coagulating glands as a whole, of all male adult animals should be trimmed of any adherent tissue, as appropriate, and their wet weight taken as soon as possible after dissection to avoid drying. In addition, optional organ weights could include levator ani plus bulbocavernosus muscle complex, Cowper's glands and glans penis in males and paired ovaries (wet weight) and uterus (including cervix) in females; if included, these weights should be collected as soon as possible after dissection.
47. Dead pups and pups killed at day 13 post-partum, or shortly thereafter, should, at least, be carefully examined externally for gross abnormalities. Particular attention should be paid to the external reproductive genitals which should be examined for signs of altered development. At day 13 the thyroid from 1 male and 1 female pup per litter should be preserved.
48. The ovaries, testes, accessory sex organs (uterus and cervix, epididymides, prostate, seminal vesicles plus coagulating glands), thyroid and all organs showing macroscopic lesions of all adult animals should be preserved. Formalin fixation is not recommended for routine examination of testes and epididymides. An acceptable method is the use of Bouin's fixative or modified Davidsons for these tissues (11). The tunica albuginea may be gently and shallowly punctured at the both poles of the organ with a needle to permit rapid penetration of the fixative.

Histopathology

49. Detailed histological examination should be performed on the ovaries, testes and epididymides (with special emphasis on stages of spermatogenesis and histopathology of interstitial testicular cell structure) of the animals of the highest dose group and the control group. The other preserved organs including thyroid from pups and adult animals may be examined when necessary. The thyroid weight could be determined after fixation. Trimming should also be done very carefully and only after fixation to avoid tissue damage. Tissue damage could compromise histopathology analysis. Examinations should be extended to the animals of other dosage groups when changes are seen in the highest dose group. The Guidance on histopathology (11) details extra information on dissection, fixation, sectioning and histopathology of endocrine tissues.

▼ M8**DATA AND REPORTING****Data**

50. Individual animal data should be provided. Additionally, all data should be summarised in tabular form, showing for each test group the number of animals at the start of the test, the number of animals found dead during the test or killed for humane reasons, the time of any death or humane kill, the number of fertile animals, the number of pregnant females, the number of animals showing signs of toxicity, a description of the signs of toxicity observed, including time of onset, duration, and severity of any toxic effects, the types of histopathological changes, and all relevant litter data. A tabular summary report format that has proven to be very useful for the evaluation of reproductive/developmental effect is given in Appendix 3.
51. Due to the limited dimensions of the study, statistical analyses in the form of tests for 'significance' are of limited value for many endpoints, especially reproductive endpoints. If statistical analyses are used then the method chosen should be appropriate for the distribution of the variable examined, and be selected prior to the start of the study. Statistical analysis of AGD and nipple retention should be based on individual pup data, taking litter effects into account. Where appropriate, the litter is the unit of analysis. Statistical analysis of pup body weight should be based on individual pup data, taking litter size into account. Because of the small group size, the use of historic control data (e.g. for litter size), where available, may also be useful as an aid to the interpretation of the study.

Evaluation of results

52. The findings of this toxicity study should be evaluated in terms of the observed effects, necropsy and microscopic findings. The evaluation will include the relationship between the dose of the test chemical and the presence or absence, incidence and severity of abnormalities, including gross lesions, identified target organs, infertility, clinical abnormalities, affected reproductive and litter performance, body weight changes, effects on mortality and any other toxic effects.
53. Because of the short period of treatment of the male, the histopathology of the testes and epididymides should be considered along with the fertility data, when assessing male reproductive effects. The use of historical control data on reproduction/development (e.g., for litter size, AGD, nipple retention, serum T4 levels), where available, may also be useful as an aid to the interpretation of the study.
54. For quality control it is proposed that historical control data are collected and that for numerical data coefficients of variation are calculated, especially for the parameters linked with endocrine disrupter detection. These data can be used for comparison purposes when actual studies are evaluated.

Test report

55. The test report should include the following information:

Test chemical:

— source, lot number, limit date for use, if available

— stability of the test chemical, if known.

▼ M8

Mono-constituent substance:

- physical appearance, water solubility, and additional relevant physico-chemical properties;
- chemical identification, such as IUPAC or CAS name, CAS number, SMILES or InChI code, structural formula, purity, chemical identity of impurities as appropriate and practically feasible, etc.

Multi-constituent substance, UVCBs and mixtures:

- characterised as far as possible by chemical identity (see above), quantitative occurrence and relevant physicochemical properties of the constituents.

Vehicle (if appropriate):

- justification for choice of vehicle if other than water.

Test animals:

- species/strain used;
- number, age and sex of animals;
- source, housing conditions, diet, etc.;
- individual weights of animals at the start of the test.
- justification for species if not rat

Test conditions:

- rationale for dose level selection;
- details of test chemical formulation/diet preparation, achieved concentrations, stability and homogeneity of the preparation;
- details of the administration of the test chemical;
- conversion from diet/drinking water test chemical concentration (ppm) to the actual dose (mg/kg body weight/day), if applicable;
- details of food and water quality;
- detailed description of the randomisation procedure to select pups for culling, if culled.

Results:

- body weight/body weight changes;
- food consumption, and water consumption if available;
- toxic response data by sex and dose, including fertility, gestation, and any other signs of toxicity;
- gestation length;
- toxic or other effects on reproduction, offspring, post-natal growth, etc.;
- nature, severity and duration of clinical observations (whether reversible or not);
- number of adult females with normal or abnormal oestrous cycle and cycle duration;
- number of live births and post-implantation loss;
- pup body weight data
- AGD of all pups (and body weight on day of AGD measurement)

▼M8

- nipple retention in male pups,
- thyroid hormone levels, day 13 pups and adult males (and dams and day 4 pups if measured)
- number pups with grossly visible abnormalities, gross evaluation of external genitalia, number of runts;
- time of death during the study or whether animals survived to termination;
- number of implantations, litter size and litter weights at the time of recording;
- body weight at sacrifice and organ weight data for the parental animals;
- necropsy findings;
- detailed description of histopathological findings;
- absorption data (if available);
- statistical treatment of results, where appropriate.

Discussion of results.

Conclusions.

Interpretation of results

56. The study will provide evaluations of reproduction/developmental toxicity associated with administration of repeated doses (see paragraphs 5 and 6). It could provide an indication of the need to conduct further investigations and provides guidance in the design of subsequent studies. OECD Guidance Document 43 should be consulted for aid in the interpretation of reproduction and developmental results (12). OECD Guidance Document No 106 on Histologic Evaluation of Endocrine and Reproductive Tests in Rodents (11) provides information on the preparation and evaluation of (endocrine) organs and vaginal smears that may be helpful for this TG.

LITERATURE

- (1) OECD (1990). Room Document No 1 for the 14th Joint Meeting of the Chemicals Group and Management Committee. Available upon request at Organisation for Economic and Cooperation and Development, Paris.
- (2) OECD (1992). Chairman's Report of the ad hoc Expert Meeting on Reproductive Toxicity Screening Methods, Tokyo, 27th-29th October, 1992. Available Upon Request at Organisation for Economic Cooperation and Development, Paris.
- (3) OECD (1998). Report of the First Meeting of the OECD Endocrine Disrupter Testing and Assessment (EDTA) Task Force, 10th-11th March 1998. Available Upon Request at Organisation for Economic Cooperation and Development, Paris.
- (4) OECD (2015). Feasibility Study for Minor Enhancements of TG 421/422 with ED Relevant Endpoints. Environment, Health and Safety Publications, Series on Testing and Assessment (No 217), Organisation for Economic Cooperation and Development, Paris.
- (5) OECD (2000). Guidance Document on the Recognition, Assessment, and Use of Clinical Signs as Humane Endpoints for Experimental Animals Used in Safety Evaluations. Series on Testing and Assessment, (No 19), Organisation for Economic Cooperation and Development, Paris.

▼M8

- (6) OECD (2011). Guidance Document on Standardised Test Guidelines for Evaluating Chemicals for Endocrine Disruption. Environment, Health and Safety Publications, Series on Testing and Assessment(No 150), Organisation for Economic Cooperation and Development, Paris.
- (7) Goldman, J.M., Murr A.S., Buckalew A.R., Ferrell J.M. and Cooper R.L. (2007). The Rodent Estrous Cycle: Characterization of Vaginal Cytology and its Utility in Toxicological Studies, Birth Defects Research, Part B, 80 (2), 84-97.
- (8) Sadleir R.M.F.S (1979). Cycles and Seasons, in Auston C.R. and Short R.V. (eds.), Reproduction in Mammals: I. Germ Cells and Fertilization, Cambridge, New York.
- (9) Gallavan R.H. Jr, Holson J.F., Stump D.G., Knapp J.F. and Reynolds V.L. (1999). Interpreting the Toxicologic Significance of Alterations in Anogenital Distance: Potential for Confounding Effects of Progeny Body Weights, Reproductive Toxicology, 13: 383-390.
- (10) OECD (2013). Guidance Document in Support of the Test Guideline on the Extended One Generation Reproductive Toxicity Study. Environment, Health and Safety Publications, Series on Testing and Assessment (No 151), Organisation for Economic Cooperation and Development, Paris.
- (11) OECD (2009). Guidance Document for Histologic Evaluation of Endocrine and Reproductive Tests in Rodents. Environment, Health and Safety Publications, Series on Testing and Assessment (No106), Organisation for Economic Cooperation and Development, Paris.
- (12) OECD (2008). Guidance Document on Mammalian Reproductive Toxicity Testing and Assessment. Environment, Health and Safety Publications, Series on Testing and Assessment (No 43), Organisation for Economic Cooperation and Development, Paris.

▼M8*Appendix 1*

DEFINITIONS (SEE ALSO OECD GD 150 (6))

Androgenicity is the capability of a chemical to act like a natural androgenic hormone (e.g. testosterone) in a mammalian organism.

Antiandrogenicity is the capability of a chemical to suppress the action of a natural androgenic hormone (e.g. testosterone) in a mammalian organism.

Antioestrogenicity is the capability of a chemical to suppress the action of a natural oestrogenic hormone (e.g. oestradiol 17 β) in a mammalian organism.

Antithyroid activity is the capability of a chemical to suppress the action of a natural thyroid hormone (e.g. T₃) in a mammalian organism.

Chemical is a substance or a mixture.

Developmental toxicity: the manifestation of reproductive toxicity, representing pre-, peri- post-natal, structural, or functional disorders in the progeny.

Dosage is a general term comprising of dose, its frequency and the duration of dosing.

Dose is the amount of test chemical administered. The dose is expressed as weight of test chemical per unit body weight of test animal per day (e.g. mg/kg body weight/day), or as a constant dietary concentration.

Evident toxicity is a general term describing clear signs of toxicity following administration of test chemical. These should be sufficient for hazard assessment and should be such that an increase in the dose administered can be expected to result in the development of severe toxic signs and probable mortality.

Impairment of fertility represents disorders of male or female reproductive functions or capacity.

Maternal toxicity: adverse effects on gravid females, occurring either specifically (direct effect) or not specifically (indirect effect).

NOAEL is the abbreviation for no-observed-adverse effect level. This is the highest dose level where no adverse treatment-related findings are observed due to treatment.

Oestrogenicity is the capability of a chemical to act like a natural oestrogenic hormone (e.g. oestradiol 17 β) in a mammalian organism.

Reproduction toxicity represents harmful effects on the progeny and/or an impairment of male and female reproductive functions or capacity.

Test chemical is any substance or mixture tested using this test method.

Thyroid activity is the capability of a chemical to act like a natural thyroid hormone (e.g. T₃) in a mammalian organism.

Validation is a scientific process designed to characterise the operational requirements and limitations of a test method and to demonstrate its reliability and relevance for a particular purpose.

▼ **M8**

Appendix 2

DIAGRAM OF THE EXPERIMENTAL SCHEDULE INDICATING THE MAXIMUM STUDY DURATION, BASED ON A FULL 14-DAY MATING PERIOD

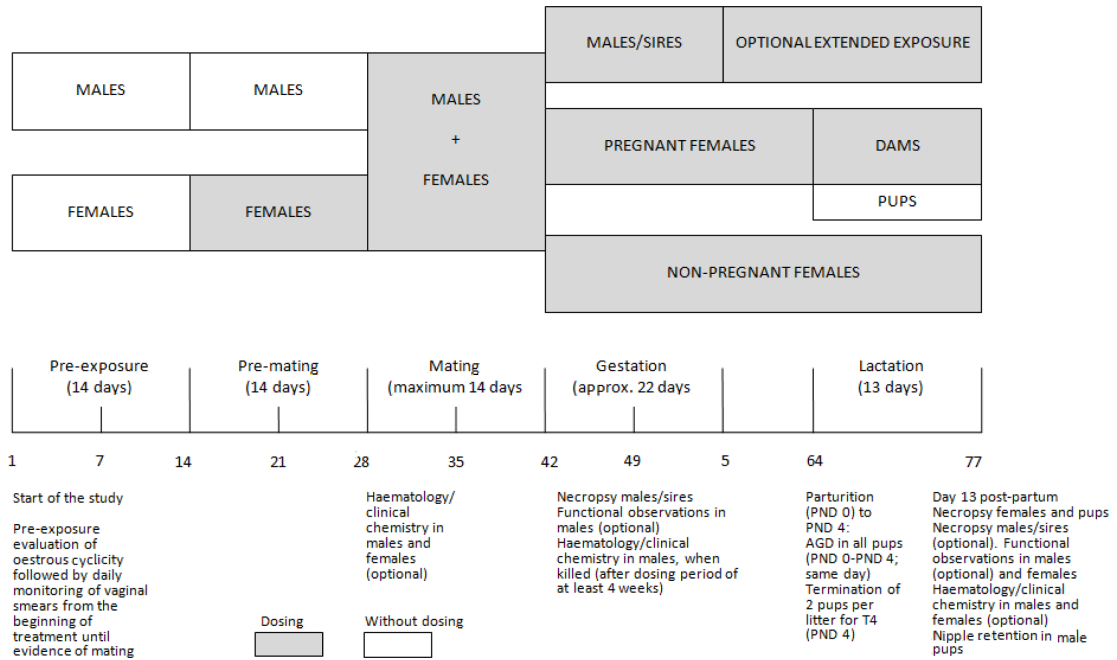

▼ **M8***Appendix 3*

TABULAR SUMMARY REPORT OF EFFECTS ON REPRODUCTION/DEVELOPMENT

OBSERVATIONS	VALUES				
	0 (control)
Dosage (units)					
Pairs started (N)					
Oestrus cycle (at least mean length and frequency of irregular cycles)					
Females showing evidence of copulation (N)					
Females achieving pregnancy (N)					
Conceiving days 1 - 5 (N)					
Conceiving days 6 -... (!) (N)					
Pregnancy 21 days (N)					
Pregnancy = 22 days (N)					
Pregnancy 23 days (N)					
Dams with live young born (N)					
Dams with live young at day 4 pp (N)					
Implants/dam (mean)					
Live pups/dam at birth (mean)					
Live pups/dam at day 4 (mean)					
Sex ratio (m/f) at birth (mean)					
Sex ratio (m/f) at day 4 (mean)					
Litter weight at birth (mean)					
Litter weight at day 4 (mean)					
Pup weight at birth (mean)					
Pup weight at the time of AGD measurement (mean males, mean females)					

▼ **M8**

OBSERVATIONS	VALUES				
Dosage (units)	0 (control)
Pup AGD on the same postnatal day, birth – day 4 (mean males, mean females, note PND)					
Pup weight at day 4 (mean)					
Male pup nipple retention at day 13 (mean)					
Pup weight at day 13 (mean)					
ABNORMAL PUPS					
Dams with 0					
Dams with 1					
Dams with 2					
LOSS OF OFFSPRING					
Pre-natal/post-implantations (implantations minus live births)					
Females with 0					
Females with 1					
Females with 2					
Females with 3					
Post-natal (live births minus alive at post-natal day 13)					
Females with 0					
Females with 1					
Females with 2					
Females with 3					
⁽¹⁾ last day of the mating period					

▼M8**B.64. COMBINED REPEATED DOSE TOXICITY STUDY WITH THE REPRODUCTION/DEVELOPMENTAL TOXICITY SCREENING TEST**

INTRODUCTION

1. This test method is equivalent to OECD test guideline (TG) 422 (2016). OECD guidelines for the Testing of Chemicals are periodically reviewed in the light of scientific progress. The original screening test guideline 422 was adopted in 1996, based on a protocol for a 'Combined Repeat Dose and Reproductive/Developmental Screening Test' discussed in two expert meetings, in London in 1990 (1) and in Tokyo in 1992 (2).
2. This test method combines a reproduction/developmental toxicity screening part which is based on experience gained in Member countries from using the original method on existing high production volume chemicals and in exploratory tests with positive control substances (3) (4), and a repeated dose toxicity part, in concordance with OECD test guideline 407 (Repeated Dose 28-Day Oral Toxicity Study in Rodents, corresponding to Chapter B.7 of this Annex).
3. This test method has been updated with endocrine disruptor relevant endpoints, as a follow up to the high-priority activity initiated at OECD in 1998 to revise existing test guidelines and to develop new test guidelines for the screening and testing of potential endocrine disruptors (5). In this context TG 407 (corresponding to Chapter B.7 of this Annex) was enhanced in 2008 by parameters suitable to detect endocrine activity of test chemicals. The objective in updating TG 422 was to include some endocrine disruptor relevant endpoints in screening TGs where the exposure periods cover some of the sensitive periods during development (pre- or early postnatal periods).
4. The selected additional endocrine disruptor relevant endpoints, also part of TG 443 (Extended One Generation Reproductive Toxicity Study, corresponding to Chapter B.56 of this Annex), were included in TG 422 based on a feasibility study addressing scientific and technical questions related to their inclusion, as well as possible adaptations of the test design needed for their inclusion (6).
5. This test method is designed to generate limited information concerning the effects of a test chemical on male and female reproductive performance such as gonadal function, mating behaviour, conception, development of the conceptus and parturition. It is not an alternative to, nor does it replace the existing test methods B.31, B.34, B.35 or B.56.

INITIAL CONSIDERATIONS

6. In the assessment and evaluation of the toxic characteristics of a test chemical the determination of oral toxicity using repeated doses may be carried out after the initial information on toxicity has been obtained by acute testing. This study provides information on the possible health hazards likely to arise from repeated exposure over a relatively limited period of time. The method comprises the basic repeated dose toxicity study that may be used for chemicals on which a 90-day study is not warranted (e.g. when the production volume does not exceed certain limits) or as a preliminary study to a long-term study. In conducting the study, the guiding principles and considerations outlined in the OECD guidance document n° 19 on the recognition, assessment, and use of clinical signs as humane endpoints for experimental animals used in safety evaluations (7) should be followed.

▼M8

7. It further comprises a reproduction/developmental toxicity screening test and, therefore, can also be used to provide initial information on possible effects on male and female reproductive performance such as gonadal function, mating behaviour, conception, development of the conceptus and parturition, either at an early stage of assessing the toxicological properties of test chemicals, or on test chemicals of concern. This test method does not provide complete information on all aspects of reproduction and development. In particular, it offers only limited means of detecting postnatal manifestations of prenatal exposure, or effects that may be induced during postnatal exposure. Due (amongst other reasons) to the selectivity of the end points, and the short duration of the study, this method will not provide evidence for definite claims of no reproduction/developmental effects. Moreover, in the absence of data from other reproduction/developmental toxicity tests, positive results are useful for initial hazard assessment and contribute to decisions with respect to the necessity and timing of additional testing.
8. The results obtained by the endocrine related parameters should be seen in the context of the 'OECD Conceptual Framework for Testing and Assessment of Endocrine Disrupting Chemicals' (8). In this Conceptual Framework, the enhanced OECD TG 422 is contained in level 4 as an *in vivo* assay providing data on adverse effects on endocrine relevant endpoints. An endocrine signal might not however be considered sufficient evidence on its own that the test chemical is an endocrine disruptor.
9. The test method also places emphasis on neurological effects as a specific endpoint, and the need for careful clinical observations of the animals, so as to obtain as much information as possible, is stressed. The method should identify chemicals with neurotoxic potential, and which may warrant further in-depth investigation of this aspect. In addition, the method may also give a basic indication of immunological effects.
10. In the absence of data from other systemic toxicity, reproduction/developmental toxicity, neurotoxicity and/or immunotoxicity studies, positive results are useful for initial hazard assessment and contribute to decisions with respect to the necessity and timing of additional testing. The test may be particularly useful as part of the OECD Screening Information Data Set (SIDS) for the assessment of existing chemicals for which little or no toxicological information is available and can serve as an alternative to conducting two separate tests for repeated dose toxicity (OCD TG 407, corresponding to Chapter B.7 of this Annex) and reproduction/developmental toxicity (OECD TG 421, corresponding to Chapter B.63 of this Annex), respectively. It can also be used as a dose range finding study for more extensive reproduction/developmental studies, or when otherwise considered relevant.
11. Generally, it is assumed that there are differences in sensitivity between pregnant and non-pregnant animals. Consequently, it may be more complicated to determine dose levels in this combined test that are adequate to evaluate both general systemic toxicity and specific reproduction/developmental toxicity, rather than when the individual tests are conducted separately. Moreover, interpretation of the test results with respect to general systemic toxicity may be more difficult than when conducting a separate

▼M8

repeated-dose study, especially when serum and histopathology parameters are not evaluated at the same time in the study. Because of these technical complexities, considerable experience in toxicity testing is required for the performance of this combined screening test. On the other hand, apart from the smaller number of animals involved, the combined test may offer a better means of discriminating direct effects on reproduction/development from those that are secondary to other (systemic) effects.

12. In this test, the dosing period is longer than in a conventional 28-day repeated dose study. However, it uses fewer animals of each sex per group when compared with the situation where a conventional 28-day repeated dose study is conducted in addition to a Reproduction/Developmental Toxicity Screening Test.
13. This test method assumes oral administration of the test chemical. Modifications may be required if other routes of exposure are used.
14. Before use of the test method on a mixture for generating data for an intended regulatory purpose, it should be considered whether, and if so why, it may provide adequate results for that purpose. Such considerations are not needed, when there is a regulatory requirement for testing of the mixture.
15. Definitions used are given in Appendix 1.

PRINCIPLE OF THE TEST

16. The test chemical is administered in graduated doses to several groups of males and females. Males should be dosed for a minimum of four weeks, up to and including the day before scheduled kill (this includes a minimum of two weeks prior to mating, during the mating period and, approximately, two weeks post mating). In view of the limited pre-mating dosing period in males, fertility may not be a particularly sensitive indicator of testicular toxicity. Therefore, a detailed histological examination of the testes is essential. The combination of a pre-mating dosing period of two weeks and subsequent mating/fertility observations with an overall dosing period of at least four weeks, followed by detailed histopathology of the male gonads, is considered sufficient to enable detection of the majority of effects on male fertility and spermatogenesis.
17. Females should be dosed throughout the study. This includes two weeks prior to mating (with the objective of covering at least two complete oestrous cycles), the variable time to conception, the duration of pregnancy and at least thirteen days after delivery, up to and including the day before scheduled kill.
18. Duration of study, following acclimatisation and pre-dosing oestrous cycle evaluation, is dependent on the female performance and is approximately 63 days, [at least 14 days pre-mating, (up to) 14 days mating, 22 days gestation, 13 days lactation].
19. During the period of administration, the animals are observed closely each day for signs of toxicity. Animals which die or are killed during the test are necropsied and, at the conclusion of the test, surviving animals are killed and necropsied.

▼M8**DESCRIPTION OF THE METHOD****Selection of animal species**

20. This test method is designed for use with the rat. If the parameters specified within this TG 422 are investigated in another rodent species a detailed justification should be given. In the international validation program for the detection of endocrine disrupters on TG 407, the rat was the only species used. Strains with low fecundity or well-known high incidence of developmental defects should not be used. Healthy virgin animals, not subjected to previous experimental procedures, should be used. The test animals should be characterised as to species, strain, sex, weight and age. At the commencement of the study the weight variation of animals used should be minimal and not exceed $\pm 20\%$ of the mean weight of each sex. Where the study is conducted as a preliminary study to a long-term or a full-generation study, it is preferable that animals from the same strain and source are used in both studies.

Housing and feeding

21. All procedures should conform to local standards of laboratory animal care. The temperature in the experimental animal room should be $22\text{ }^{\circ}\text{C}$ ($\pm 3\text{ }^{\circ}$). The relative humidity should be at least 30 % and preferably not exceed 70 % other than during room cleaning. Lighting should be artificial, the photoperiod being 12 hours light, 12 hours dark. For feeding, conventional laboratory diets may be used with an unlimited supply of drinking water. The choice of diet may be influenced by the need to ensure a suitable admixture of a test chemical when administered by this method.
22. Animals should be group housed in small groups of the same sex; animals may be housed individually if scientifically justified. For group caging, no more than five animals should be housed per cage. Mating procedures should be carried out in cages suitable for the purpose. Pregnant females should be caged individually and provided with nesting materials. Lactating females will be caged individually with their offspring.
23. The feed should be regularly analysed for contaminants. A sample of the diet should be retained until finalisation of the report.

Preparation of the animals

24. Healthy young adult animals are randomised and assigned to the treatment groups and cages. Cages should be arranged in such a way that possible effects due to cage placements are minimised. The animals are uniquely identified and kept in their cages for at least five days prior to the start of the study to allow for acclimatisation to the laboratory conditions.

Preparation of doses

25. It is recommended that the test chemical be administered orally unless other routes of administration are considered more appropriate. When the oral route is selected, the test chemical is usually administered by gavage; however, alternatively, test chemicals may also be administered via the diet or drinking water.
26. Where necessary, the test chemical is dissolved or suspended in a suitable vehicle. It is recommended that, wherever possible, the use of an aqueous solution/suspension be considered first, followed by consideration of a solution/suspension in oil (e.g. corn oil) and then by possible solution in other vehicles. For non-aqueous vehicles the toxic characteristics of the vehicle should be known. The stability and homogeneity of the test chemical in the vehicle should be determined.

▼ M8**PROCEDURE****Number and sex of animals**

27. It is recommended that each group be started with at least 10 males and 12-13 females. Females will be evaluated pre-exposure for oestrous cyclicity and animals that fail to exhibit typical 4-5 day cycles will not be included in the study; therefore, extra females are recommended in order to yield 10 females per group. Except in the case of marked toxic effects, it is expected that this will provide at least 8 pregnant females per group which normally is the minimum acceptable number of pregnant females per group. The objective is to produce enough pregnancies and offspring to assure a meaningful evaluation of the potential of the test chemical to affect fertility, pregnancy, maternal and suckling behaviour, and growth and development of the F₁ offspring from conception to day 13 post-partum. If interim kills are planned, the number should be increased by the number of animals scheduled to be killed before the completion of the study. Consideration should be given to an additional satellite group of five animals per sex in the control and the top dose group for observation of reversibility, persistence or delayed occurrence of systemic toxic effects, for at least 14 days post treatment. Animals of the satellite groups will not be mated and, consequently, are not used for the assessment of reproduction/developmental toxicity.

Dosage

28. Generally, at least three test groups and a control group should be used. If there are no suitable general toxicity data available, a range finding study may (animals of the same strain and source) be performed to aid the determination of the doses to be used. Except for treatment with the test chemical, animals in the control group should be handled in an identical manner to the test group subjects. If a vehicle is used in administering the test chemical, the control group should receive the vehicle in the highest volume used.
29. Dose levels should be selected taking into account any existing toxicity and (toxico-) kinetic data available. It should also be taken into account that there may be differences in sensitivity between pregnant and non-pregnant animals. The highest dose level should be chosen with the aim of inducing toxic effects but not death nor obvious suffering. Thereafter, a descending sequence of dose levels should be selected with a view to demonstrating any dosage related response and no adverse effects at the lowest dose level. Two- to four- fold intervals are frequently optimum and addition of a fourth test group is often preferable to using very large intervals (e.g. more than a factor of 10) between dosages.
30. In the presence of observed general toxicity (e.g. reduced body weight, liver, heart, lung or kidney effects, etc.) or other changes that may not be toxic responses (e.g. reduced food intake, liver enlargement), observed effects on endocrine sensitive endpoints should be interpreted with caution.

Limit test

31. If an oral study at one dose level of at least 1 000 mg/kg body weight/day or, for dietary administration, an equivalent percentage in the diet, or drinking water (based upon body weight determinations), using the procedures described for this study, produces no observable toxic effects and if toxicity would not be expected based upon data from structurally related

▼M8

substances, then a full study using several dose levels may not be considered necessary. The limit test applies except when human exposure indicates the need for a higher dose level to be used. For other types of administration, such as inhalation or dermal application, the physical chemical properties of the test chemicals often may dictate the maximum attainable exposure.

Administration of doses

32. The animals are dosed with the test chemical daily for 7 days a week. When the test chemical is administered by gavage, this should be done in a single dose to the animals using a stomach tube or a suitable intubation cannula. The maximum volume of liquid that can be administered at one time depends on the size of the test animal. The volume should not exceed 1 ml/100 g body weight, except in the case of aqueous solutions where 2 ml/100 g body weight may be used. Except for irritating or corrosive test chemicals which will normally reveal exacerbated effects with higher concentrations, variability in test volume should be minimised by adjusting the concentration to ensure a constant volume at all dose levels.

33. For test chemicals administered via the diet or drinking water, it is important to ensure that the quantities of the test chemical involved do not interfere with normal nutrition or water balance. When the test chemical is administered in the diet either a constant dietary concentration (ppm) or a constant dose level in terms of the animals' body weight may be used; the alternative used should be specified. For a test chemical administered by gavage, the dose should be given at similar times each day, and adjusted at least weekly to maintain a constant dose level in terms of animal body weight. Where the combined study is used as a preliminary to a long term or a full reproduction toxicity study, a similar diet should be used in both studies.

Experimental schedule

34. Dosing of both sexes should begin 2 weeks prior to mating, after they have been acclimatised for at least five days and females have been screened for normal oestrous cycles (in a 2 weeks pre-treatment period). The study should be scheduled in such a way that oestrous cycle evaluation begins soon after the animals have attained full sexual maturity. This may vary slightly for different strains of rats in different laboratories, e.g. Sprague Dawley rats 10 weeks of age, Wistar rats about 12 weeks of age. Dams with offspring should be killed on day 13 post-partum, or shortly thereafter. In order to allow for overnight fasting of dams prior to blood collection (if this option is preferred), dams and their offspring need not necessarily be killed on the same day. The day of birth (viz. when parturition is complete) is defined as day 0 post-partum. Females showing no-evidence of copulation are killed 24-26 days after the last day of the mating period. Dosing is continued in both sexes during the mating period. Males should further be dosed after the mating period at least until the minimum total dosing period of 28 days has been completed. They are then killed, or, alternatively, are retained and continued to be dosed for the possible conduction of a second mating if considered appropriate.

35. Daily dosing of the parental females should continue throughout pregnancy and at least up to, and including, day 13 post-partum or the day before sacrifice. For studies where the test chemical is administered by inhalation or by the dermal route, dosing should be continued at least up to, and including, day 19 of gestation, and dosing should be re-initiated as soon as possible and not later than postnatal day (PND) 4.

▼M8

36. Animals in a satellite group scheduled for follow-up observations, if included, are not mated. They should be kept at least for a further 14 days after the first scheduled kill of dams, without treatment to detect delayed occurrence, or persistence of, or recovery from toxic effects.

37. A diagram of the experimental schedule is given in Appendix 2.

Oestrous cycles

38. Oestrous cycles should be monitored before treatment starts to select for the study females with regular cyclicity (see paragraph 27). Vaginal smears should also be monitored daily from the beginning of the treatment period until evidence of mating. If there is concern about acute stress effects that could alter estrous cycles with the initiation of dosing, laboratories can expose test animals for 2 weeks, then collect vaginal smears daily to monitor estrous cycle for a minimum of two weeks during the pre-mating period with continued monitoring into the mating period until there is evidence of mating. When obtaining vaginal/cervical cells, care should be taken to avoid disturbance of mucosa, which could induce pseudopregnancy (8) (9).

Mating procedure

39. Normally, 1:1 (one male to one female) matings should be used in this study. Exceptions can arise in the case of occasional deaths of males. The female should be placed with the same male until evidence of copulation is observed or two weeks have elapsed. Each morning the females should be examined for the presence of sperm or a vaginal plug. Day 0 of pregnancy is defined as the day on which mating evidence is confirmed (a vaginal plug or sperm is found). In case pairing was unsuccessful, re-mating of females with proven males of the same group could be considered.

Litter size

40. On day 4 after birth, the size of each litter may be adjusted by eliminating extra pups by random selection to yield, as nearly as possible, four or five pups per sex per litter depending on the normal litter size in the strain of rats used. Blood samples should be collected from two of the surplus pups, pooled, and used for determination of serum T4 levels. Selective elimination of pups, e.g. based upon body weight, or anogenital distance (AGD) is not appropriate. Whenever the number of male or female pups prevents having four or five of each sex per litter, partial adjustment (for example, six males and four females) is acceptable. No pups will be eliminated when litter size will drop below the culling target (8 or 10 pups/litter). If there is only one pup available above the culling target, only one pup will be eliminated and used for blood collection for possible serum T4 assessments.

41. If litter size is not adjusted, two pups per litter are sacrificed on day 4 after birth and blood samples are taken for measurement of serum thyroid hormone concentrations. If possible the two pups per litter should be female pups to reserve male pups for nipple retention evaluations, except in the event that removing these pups leaves no remaining females for assessment at termination. No pups will be eliminated when litter size will drop below 8 or 10 pups/litter (depending on the normal litter size in the strain of rats used). If there is only one pup available above the normal litter size, only one pup will be eliminated and used for blood collection for possible serum T4 assessments.

▼ M8**Observations**

42. General clinical observations should be made at least once a day, preferably at the same time(s) each day and considering the peak period of anticipated effects after dosing. The health condition of the animals should be recorded. At least twice daily all animals are observed for morbidity and mortality.

43. Once before the first exposure (to allow for within-subject comparisons), and at least once a week thereafter, detailed clinical observations should be made in all parental animals. These observations should be made outside the home cage in a standard arena and preferably at the same time, each day. They should be carefully recorded; preferably using scoring systems, explicitly defined by the testing laboratory. Effort should be made to ensure that variations in the test conditions are minimal and that observations are preferably conducted by observers unaware of the treatment. Signs noted should include, but not be limited to, changes in skin, fur, eyes, mucous membranes, occurrence of secretions and excretions and autonomic activity (e.g. lacrimation, piloerection, pupil size, unusual respiratory pattern). Changes in gait, posture and response to handling as well as the presence of clonic or tonic movements, stereotypies (e.g. excessive grooming, repetitive circling), difficult or prolonged parturition or bizarre behaviour (e.g. self-mutilation, walking backwards) should also be recorded (10).

44. At one time during the study, sensory reactivity to stimuli of different modalities (e.g. auditory, visual and proprioceptive stimuli) (8) (9) (11), assessment of grip strength (12) and motor activity assessment (13) should be conducted in five males and five females, randomly selected from each group. Further details of the procedures that could be followed are given in the respective references. However, alternative procedures than those referenced could also be used. In males, these functional observations should be made towards the end of their dosing period, shortly before scheduled kill but before blood sampling for haematology or clinical chemistry (see paragraphs 53-56, including footnote 1). Females should be in a physiologically similar state during these functional tests and should preferably be tested once during the last week of lactation (e.g., LD 6-13), shortly before scheduled kill. To the extent possible, minimise dams and pups separation times.

45. Functional observations made once towards the end of the study may be omitted when the study is conducted as a preliminary study to a subsequent subchronic (90-day) or long-term study. In that case, the functional observations should be included in this follow-up study. On the other hand, the availability of data on functional observations from this repeated dose study may enhance the ability to select dose levels for a subsequent subchronic or long-term study.

46. As an exception, functional observations may also be omitted for groups that otherwise reveal signs of toxicity to an extent that would significantly interfere with the functional test performance.

47. The duration of gestation should be recorded and is calculated from day 0 of pregnancy. Each litter should be examined as soon as possible after delivery to establish the number and sex of pups, stillbirths, live births, runts (pups that are significantly smaller than corresponding control pups), and the presence of gross abnormalities.

▼M8

48. Live pups should be counted and sexed and litters weighed within 24 hours of parturition (day 0 or 1 post-partum) and at least on day 4 and day 13 post-partum. In addition to the observations on parent animals (see paragraphs 43 and 44), any abnormal behaviour of the offspring should be recorded.

49. The AGD of each pup should be measured on the same postnatal day between PND 0 through PND 4. Pup body weight should be collected on the day the AGD is measured and the AGD should be normalised to a measure of pup size, preferably the cube root of body weight (14). The number of nipples/areolae in male pups should be counted on PND 12 or 13 as recommended in OECD GD 151 (15).

Body weight and food/water consumption

50. Males and females should be weighed on the first day of dosing, at least weekly thereafter, and at termination. During pregnancy, females should be weighed on days 0, 7, 14 and 20 and within 24 hours of parturition (day 0 or 1 post-partum), and at least day 4 and day 13 post-partum. These observations should be reported individually for each adult animal.

51. During pre-mating, pregnancy and lactation, food consumption should be measured at least weekly. The measurement of food consumption during mating is optional. Water consumption during these periods should also be measured, when the test chemical is administered by that medium.

Haematology

52. Once during the study, the following haematological examinations should be made in five males and five females randomly selected from each group: haematocrit, haemoglobin concentrations, erythrocyte count, reticulocytes, total and differential leucocyte count, platelet count and a measure of blood clotting time/potential. Other determinations that should be carried out, if the test chemical or its putative metabolites have or are suspected to have oxidising properties include methaemoglobin concentration and Heinz bodies.

53. Blood samples should be taken from a named site. Females should be in a physiologically similar state during sampling. In order to avoid practical difficulties related to the variability in the onset of gestation, blood collection in females may be done at the end of the pre-mating period as an alternative to sampling just prior to, or as part of, the procedure for euthanasia of the animals. Blood samples of males should preferably be taken just prior to, or as part of, the procedure for euthanasia of the animals. Alternatively, blood collection in males may also be done at the end of the pre-mating period when this time point was preferred for females.

54. Blood samples should be stored under appropriate conditions.

Clinical biochemistry

55. Clinical biochemistry determinations to investigate major toxic effects in tissues and, specifically, effects on kidney and liver, should be performed on blood samples obtained from the selected five males and five females of

▼M8

each group. Overnight fasting of the animals prior to blood sampling is recommended⁽¹⁾. Investigations of plasma or serum should include sodium, potassium, glucose, total cholesterol, urea, creatinine, total protein and albumin, at least two enzymes indicative of hepatocellular effects (such as alanin aminotransferase, aspartate aminotransferase and sorbitol dehydrogenase) and bile acids. Measurements of additional enzymes (of hepatic or other origin) and bilirubin may provide useful information under certain circumstances.

56. Blood samples from a defined site are taken based on the following schedule:

- from at least two pups per litter on day 4 after birth, if the number of pups allows (see paragraphs 40-41)

- from all dams and at least two pups per litter at termination on day 13, and

- from all adult males, at termination

All blood samples are stored under appropriate conditions. Blood samples from the day 13 pups and the adult males are assessed for serum levels for thyroid hormones (T4). Further assessment of T4 in blood samples from the dams and day 4 pups is done if relevant. As an option, other hormones may be measured if relevant. Pup blood can be pooled by litter for thyroid hormone analyses. Thyroid hormones (T4 and TSH) should preferably be measured as 'total'.

57. Optionally, the following urinalysis determinations could be performed in five randomly selected males of each group during the last week of the study using timed urine volume collection; appearance, volume, osmolality or specific gravity, pH, protein, glucose and blood/blood cells.

58. In addition, studies to investigate serum markers of general tissue damage should be considered. Other determinations that should be carried out if the known properties of the test chemical may, or are suspected to, affect related metabolic profiles include calcium, phosphate, fasting triglycerides and fasting glucose, specific hormones, methaemoglobin and cholinesterase. These need to be identified on a case-by-case basis.

59. The following factors may influence the variability and the absolute concentrations of the hormone determinations:

- time of sacrifice because of diurnal variation of hormone concentrations

⁽¹⁾ For a number of measurements in serum and plasma, most notably for glucose, overnight fasting would be preferable. The major reason for this preference is that the increased variability which would inevitably result from non-fasting, would tend to mask more subtle effects and make interpretation difficult. On the other hand, however, overnight fasting may interfere with the general metabolism of the (pregnant) animals, disturbs lactation and nursing behaviour, and, particularly in feeding studies, may disturb the daily exposure to the test chemical. If overnight fasting is adopted, clinical biochemical determinations should be performed after the conduct of functional observations in week 4 of the study for the males. The dams should be retained for an additional day after the pups are removed on e.g. PND 13). Dams should be fasted overnight from lactation day 13-14 and terminal blood used for clinical chemistry parameters.

▼ M8

- method of sacrifice to avoid undue stress to the animals that may affect hormone concentrations

 - test kits for hormone determinations that may differ by their standard curves.
60. Plasma samples specifically intended for hormone determination should be obtained at a comparable time of the day. The numerical values obtained when analysing hormone concentrations differ with various commercial assay kits.
61. If historical baseline data are inadequate, consideration should be given to determination of haematological and clinical biochemistry variables before dosing commences or preferably in a set of animals not included in the experimental groups. For females, the data have to be from lactating animals.

PATHOLOGY**Gross necropsy**

62. All adult animals in the study should be subjected to a full, detailed gross necropsy which includes careful examination of the external surface of the body, all orifices, and the cranial, thoracic and abdominal cavities and their contents. Special attention should be paid to the organs of the reproductive system. The number of implantation sites should be recorded. Vaginal smears should be examined on the day of necropsy to determine the stage of the oestrous cycle and allow correlation with histopathology of female reproductive organs.
63. The testes and epididymides as well as prostate and seminal vesicles with coagulating glands as a whole of all male adult animals should be trimmed of any adherent tissue, as appropriate, and their wet weight taken as soon as possible after dissection to avoid drying. In addition, optional organ weights could include levator ani plus bulbocavernosus muscle complex, Cowper's glands and glans penis in males and paired ovaries (wet weight) and uterus (including cervix) in females; if included, these weights should be collected as soon as possible after dissection. The ovaries, testes, epididymides, accessory sex organs, and all organs showing macroscopic lesions of all adult animals, should be preserved.
64. From all adult males and females and one male and female day 13 pup from each litter thyroid glands should be preserved in the most appropriate fixation medium for the intended subsequent histopathological examination. The thyroid weight could be determined after fixation. Trimming should also be done very carefully and only after fixation to avoid tissue damage. Tissue damage could compromise histopathology analysis. Blood samples should be taken from a named site just prior to or as part of the procedure for euthanasia of the animals, and stored under appropriate conditions (see paragraph 56).

▼ M8

65. In addition, for a least five adult males and females, randomly selected from each group (apart from those found moribund and/or euthanised prior to the termination of the study), the liver, kidneys, adrenals, thymus, spleen, brain and heart should be trimmed of any adherent tissue, as appropriate and their wet weight taken as soon as possible after dissection to avoid drying. The following tissues should be preserved in the most appropriate fixation medium for both the type of tissue and the intended subsequent histopathological examination: all gross lesions, brain (representative regions including cerebrum, cerebellum and pons), spinal cord, eye, stomach, small and large intestines (including Peyer's patches), liver, kidneys, adrenals, spleen, heart, thymus, trachea and lungs (preserved by inflation with fixative and then immersion), gonads (testis and ovaries), accessory sex organs (uterus and cervix, epididymides, prostate, seminal vesicles plus coagulating glands), vagina, urinary bladder, lymph nodes (besides the most proximal draining node, another lymph node should be taken according to the laboratory's experience (16)), peripheral nerve (sciatic or tibial) preferably in close proximity to the muscle, skeletal muscle and bone, with bone marrow (section or, alternatively, a fresh mounted bone marrow aspirate). It is recommended that testes be fixed by immersion in Bouin's or modified Davidson's fixative (16) (17) (18); formalin fixation is not recommended for these tissues. The tunica albuginea may be gently and shallowly punctured at the both poles of the organ with a needle to permit rapid penetration of the fixative. The clinical and other findings may suggest the need to examine additional tissues. Also any organs considered likely to be target organs based on the known properties of the test chemical should be preserved.
66. The following tissues may give valuable indication for endocrine-related effects: Gonads (ovaries and testes), accessory sex organs (uterus including cervix, epididymides, seminal vesicles with coagulation glands, dorsolateral and ventral prostate), vagina, pituitary, male mammary gland and adrenal gland. Changes in male mammary glands have not been sufficiently documented but this parameter may be very sensitive to substances with estrogenic action. Observation of organs/tissues that are not listed in paragraph 65 is optional.
67. Dead pups and pups killed at day 13 post-partum, or shortly thereafter, should, at least, be carefully examined externally for gross abnormalities. Particular attention should be paid to the external reproductive genitals which should be examined for signs of altered development.

Histopathology

68. Full histopathology should be carried out on the preserved organs and tissues of the selected animals in the control and high dose groups (with special emphasis on stages of spermatogenesis in the male gonads and histopathology of interstitial testicular cell structure). The thyroid gland from pups and from the remaining adult animals may be examined when necessary. These examinations should be extended to animals of other dosage groups, if treatment-related changes are observed in the high dose group. The Guidance on histopathology (10) details extra information on dissection, fixation, sectioning and histopathology of endocrine tissues.
69. All gross lesions should be examined. To aid in the elucidation of NOAELs, target organs in other dose groups should be examined, particularly in groups claimed to show a NOAEL.

▼M8

70. When a satellite group is used, histopathology should be performed on tissues and organs identified as showing effects in the treated groups.

DATA AND REPORTING**Data**

71. Individual animal data should be provided. Additionally, all data should be summarised in tabular form, showing for each test group the number of animals at the start of the test, the number of animals found dead during the test or euthanised for humane reasons, the time of any death or euthanasia, the number of fertile animals, the number of pregnant females, the number of animals showing signs of toxicity, a description of the signs of toxicity observed, including time of onset, duration, and severity of any toxic effects, the types of histopathological changes, and all relevant litter data. A tabular summary report format, which has proven to be very useful for the evaluation of reproductive/developmental effects, is given in Appendix 3.
72. When possible, numerical results should be evaluated by an appropriate and general acceptable statistical method. Comparisons of the effect along a dose range should avoid the use of multiple t-tests. The statistical methods should be selected during the design of the study. Statistical analysis of AGD and nipple retention should be based on individual pup data, taking litter effects into account. Where appropriate, the litter is the unit of analysis. Statistical analysis of pup body weight should be based on individual pup data, taking litter size into account. Due to the limited dimensions of the study, statistical analyses in the form of tests for 'significance' are of limited value for many endpoints, especially reproductive endpoints. Some of the most widely used methods, especially parametric tests for measures of central tendency, are inappropriate. If statistical analyses are used then the method chosen should be appropriate for the distribution of the variable examined and be selected prior to the start of the study.

Evaluation of results

73. The findings of this toxicity study should be evaluated in terms of the observed effects, necropsy and microscopic findings. The evaluation will include the relationship between the dose of the test chemical and the presence or absence, incidence and severity of abnormalities, including gross lesions, identified target organs, infertility, clinical abnormalities, affected reproductive and litter performance, body weight changes, effects on mortality and any other toxic effects.
74. Because of the short period of treatment of the male, the histopathology of the testes and epididymides should be considered along with the fertility data, when assessing male reproduction effects. The use of historic control data on reproduction/development (e.g. for litter size, AGD, nipple retention, serum T4 levels), where available, may also be useful as an aid to the interpretation of the study.
75. For quality control it is proposed that historical control data are collected and that for numerical data coefficients of variation are calculated, especially for the parameters linked with endocrine disrupter detection. These data can be used for comparison purposes when actual studies are evaluated.

▼M8**Test report**

76. The test report should include the following information:

Test chemical:

- source, lot number, limit date for use, if available
- stability of the test chemical, if known.

Mono-constituent substance:

- physical appearance, water solubility, and additional relevant physico-chemical properties;
- chemical identification, such as IUPAC or CAS name, CAS number, SMILES or InChI code, structural formula, purity, chemical identity of impurities as appropriate and practically feasible, etc.

Multi-constituent substance, UVCBs and mixtures:

- characterised as far as possible by chemical identity (see above), quantitative occurrence and relevant physicochemical properties of the constituents.

Vehicle (if appropriate):

- justification for choice of vehicle, if other than water.

Test animals:

- species/strain used;
- number, age and sex of animals;
- source, housing conditions, diet, etc.;
- individual weights of animals at the start of the test.
- justification for species if not rat

Test conditions:

- rationale for dose level selection;
- details of test chemical formulation/diet preparation, achieved concentration, stability and homogeneity of the preparation;
- details of the administration of the test chemical;
- conversion from diet/drinking water test chemical concentration (ppm) to the actual dose (mg/kg body weight/day), if applicable;
- details of food and water quality;
- detailed description of the randomisation procedure to select pups for culling, if culled.

Results:

- body weight/body weight changes;
- food consumption and water consumption, if applicable;

▼M8

- toxic response data by sex and dose, including fertility, gestation, and any other signs of toxicity;
- gestation length;
- toxic or other effects on reproduction, offspring, postnatal growth, etc.;
- nature, severity and duration of clinical observations (whether reversible or not);
- sensory activity, grip strength and motor activity assessments;
- haematological tests with relevant baseline values;
- clinical biochemistry tests with relevant base-line values;
- number of adult females with normal or abnormal oestrous cycle and cycle duration;
- number of live births and post implantation loss;
- number of pups with grossly visible abnormalities; gross evaluation of external genitalia, number of runts;
- time of death during the study or whether animals survived to termination;
- number of implantations, litter size and litter weights at the time of recording;
- pup body weight data
- AGD of all pups (and body weight on day of AGD measurement)
- nipple retention in male pups,
- thyroid hormone levels, day 13 pups and adult males (and dams and day 4 pups if measured)
- body weight at sacrifice and organ weight data for the parental animals;
- necropsy findings;
- a detailed description of histopathological findings;
- absorption data (if available);
- statistical treatment of results, where appropriate.

Discussion of results.

Conclusions.

▼ M8**Interpretation of Results**

77. The study will provide evaluations of reproduction/developmental toxicity associated with administration of repeated doses. In particular, since emphasis is placed on both general toxicity and reproduction/developmental toxicity endpoints, the results of the study will allow for the discrimination between reproduction/developmental effects occurring in the absence of general toxicity and those which are only expressed at levels that are also toxic to parent animals (see paragraphs 7-11). It could provide an indication of the need to conduct further investigations and could provide guidance in the design of subsequent studies. OECD Guidance Document 43 should be consulted for aid in the interpretation of reproduction and developmental results (19). OECD Guidance Document 106 on Histologic Evaluation of Endocrine and Reproductive Tests in Rodents (16) provides information on the preparation and evaluation of (endocrine) organs and vaginal smears that may be helpful for this test method.

LITERATURE

- (1) OECD (1990). Room Document No 1 for the 14th Joint Meeting of the Chemicals Group and Management Committee. Available upon request at Organisation for Economic Cooperation and Development, Paris
- (2) OECD (1992). Chairman's Report of the ad hoc Expert Meeting on Reproductive Toxicity Screening Methods, Tokyo, 27th-29th October, 1992. Available upon request at Organisation for Economic Cooperation and Development, Paris
- (3) Mitsumori K., Kodama Y., Uchida O., Takada K., Saito M. Naito K., Tanaka S., Kurokawa Y., Usami, M., Kawashima K., Yasuhara K., Toyoda K., Onodera H., Furukawa F., Takahashi M. and Hayashi Y. (1994). Confirmation Study, Using Nitro-Benzene, of the Combined Repeat Dose and Reproductive/ Developmental Toxicity Test Protocol Proposed by the Organization for Economic Cooperation and Development (OECD). *J. Toxicol, Sci.*, 19, 141-149.
- (4) Tanaka S., Kawashima K., Naito K., Usami M., Nakadate M., Imaida K., Takahashi M., Hayashi Y., Kurokawa Y. and Tobe M. (1992). Combined Repeat Dose and Reproductive/Developmental Toxicity Screening Test (OECD): Familiarization Using Cyclophosphamide. *Fundam. Appl. Toxicol.*, 18, 89-95.
- (5) OECD (1998). Report of the First Meeting of the OECD Endocrine Disrupter Testing and Assessment (EDTA) Task Force, 10th-11th March 1998, Available upon request at Organisation for Economic Cooperation and Development, Paris
- (6) OECD (2015). Feasibility Study for Minor Enhancements of TG 421/422 with ED Relevant Endpoints. Environment, Health and Safety Publications, Series on Testing and Assessment (No 217), Organisation for Economic Cooperation and Development, Paris.
- (7) OECD (2000). Guidance Document on the Recognition, Assessment, and Use of Clinical Signs as Humane Endpoints for Experimental Animals Used in Safety Evaluations, Environment, Health and Safety Publications, Series on Testing and Assessment, (No 19), Organisation for Economic Cooperation and Development, Paris.

▼ **M8**

- (8) Goldman J.M., Murr A.S., Buckalew A.R., Ferrell J.M. and Cooper R.L. (2007). The Rodent Estrous Cycle: Characterization of Vaginal Cytology and its Utility in Toxicological Studies, *Birth Defects Research, Part B*, 80 (2), 84-97.
- (9) Sadleir R.M.F.S. (1979). Cycles and Seasons, in Auston C.R. and Short R.V. (Eds.), *Reproduction in Mammals: I. Germ Cells and Fertilization*, Cambridge, New York.
- (10) IPCS (1986). Principles and Methods for the Assessment of Neurotoxicity Associated with Exposure to Chemicals. Environmental Health Criteria Document (No 60).
- (11) Moser V.C., McDaniel K.M. and Phillips P.M. (1991). Rat Strain and Stock Comparisons Using a Functional Observational Battery: Baseline Values and Effects of Amitraz. *Toxicol. Appl. Pharmacol.*, 108, 267-283.
- (12) Meyer O.A., Tilson H.A., Byrd W.C. and Riley M.T. (1979). A Method for the Routine Assessment of Fore- and Hindlimb Grip Strength of Rats and Mice. *Neurobehav. Toxicol.*, 1, 233-236.
- (13) Crofton K.M., Howard J.L., Moser V.C., Gill M.W., Reiter L.W., Tilson H.A., MacPhail R.C. (1991). Interlaboratory Comparison of Motor Activity Experiments: Implication for Neurotoxicological Assessments. *Neurotoxicol. Teratol.* 13, 599-609.
- (14) Gallavan R.H. Jr, J.F. Holson, D.G. Stump, J.F. Knapp and V.L. Reynolds. (1999). 'Interpreting the Toxicologic Significance of Alterations in Anogenital Distance: Potential for Confounding Effects of Progeny Body Weights', *Reproductive Toxicology*, 13: 383-390.
- (15) OECD (2013). Guidance Document in Support of the Test Guideline on the Extended One Generation Reproductive Toxicity Study. Environment, Health and Safety Publications, Series on Testing and Assessment (No 151). Organisation for Economic Cooperation and Development, Paris.
- (15) OECD (2009). Guidance Document for Histologic Evaluation of Endocrine and Reproductive Tests in Rodents. Environment, Health and Safety Publications, Series on Testing and Assessment (No. 106) Organisation for Economic Cooperation and Development, Paris.
- (17) Hess RA and Moore BJ. (1993). Histological Methods for the Evaluation of the Testis. In: *Methods in Reproductive Toxicology*, Chapin RE and Heindel JJ (Eds.). Academic Press: San Diego, CA, pp. 52-85.
- (18) Latendresse JR, Warbritton AR, Jonassen H, Creasy DM. (2002). Fixation of Testes and Eyes Using a Modified Davidson's Fluid: Comparison with Bouin's Fluid and Conventional Davidson's fluid. *Toxicol. Pathol.* 30, 524-533.
- (19) OECD (2008). Guidance Document on Mammalian Reproductive Toxicity Testing and Assessment. Environment, Health and Safety Publications, Series on Testing and Assessment (No 43), Organisation for Economic Cooperation and Development, Paris.
- (20) OECD (2011), Guidance Document on Standardised Test Guidelines for Evaluating Chemicals for Endocrine Disruption (No 150), Organisation for Economic Cooperation and Development, Paris.

▼M8*Appendix 1*

DEFINITIONS (SEE ALSO (20) OECD GD 150)

Androgenicity is the capability of a chemical to act like a natural androgenic hormone (e.g. testosterone) in a mammalian organism.

Antiandrogenicity is the capability of a chemical to suppress the action of a natural androgenic hormone (e.g. testosterone) in a mammalian organism.

Antioestrogenicity is the capability of a chemical to suppress the action of a natural oestrogenic hormone (e.g. oestradiol 17 β) in a mammalian organism.

Antithyroid activity is the capability of a chemical to suppress the action of a natural thyroid hormone (e.g. T₃) in a mammalian organism.

Chemical is a substance or a mixture.

Developmental toxicity: the manifestation of reproductive toxicity, representing pre-, peri- post-natal, structural, or functional disorders in the progeny.

Dose is the amount of test chemical administered. The dose is expressed as weight of test chemical per unit body weight of test animal per day (e.g. mg/kg body weight/day), or as a constant dietary concentration.

Dosage is a general term comprising dose, its frequency and the duration of dosing.

Evident toxicity is a general term describing clear signs of toxicity following administration of test chemical. These should be sufficient for hazard assessment and should be such that an increase in the dose administered can be expected to result in the development of severe toxic signs and probable mortality.

Impairment of fertility represents disorders of male or female reproductive functions or capacity.

Maternal toxicity: adverse effects on gravid females, occurring either specifically (direct effect) or not specifically (indirect effect) and being related to the gravid state.

NOAEL is the abbreviation for no-observed-adverse-effect level. This is the highest dose level where no adverse treatment-related findings are observed due to treatment.

Oestrogenicity is the capability of a chemical to act like a natural oestrogenic hormone (e.g. oestradiol 17 β) in a mammalian organism.

Reproduction toxicity represents harmful effects on the progeny and/or an impairment of male and female reproductive functions or capacity.

Test chemical is any substance or mixture tested using this test method.

Thyroid activity is the capability of a chemical to act like a natural thyroid hormone (e.g. T₃) in a mammalian organism.

Validation is a scientific process designed to characterise the operational requirements and limitations of a test method and to demonstrate its reliability and relevance for a particular purpose.

▼M8

Appendix 2

DIAGRAM OF THE EXPERIMENTAL SCHEDULE, INDICATING THE MAXIMUM STUDY DURATION, BASED ON A FULL 14-DAY MATING PERIOD

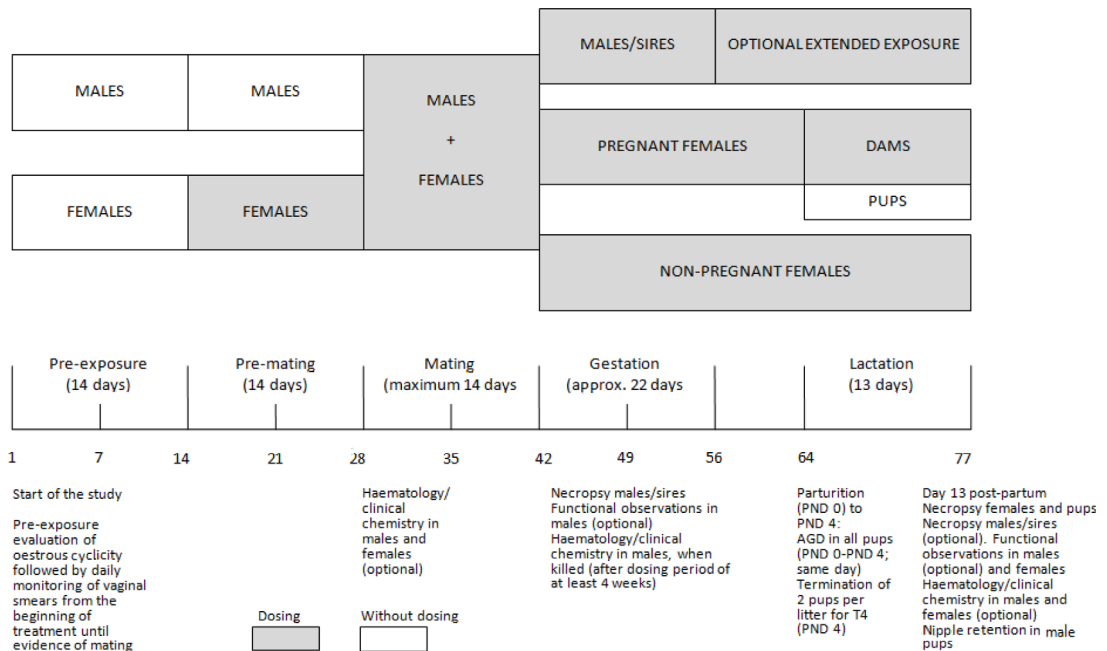
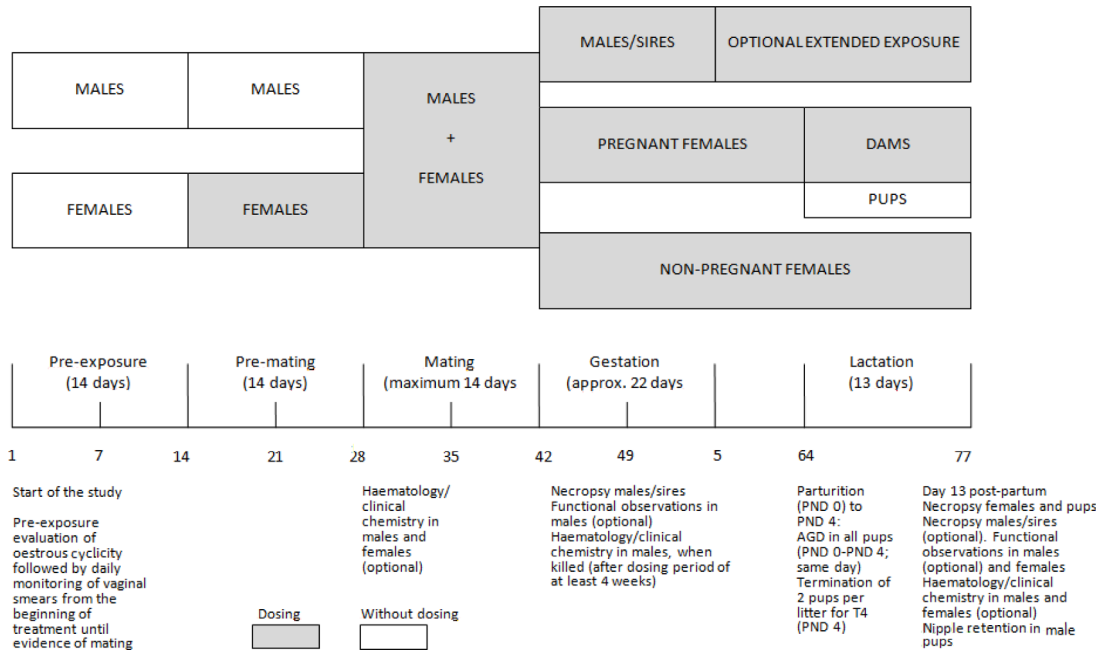

▼M8

Appendix 3

TABULAR SUMMARY REPORT OF EFFECTS ON REPRODUCTION/DEVELOPMENT

OBSERVATIONS	VALUES				
	0 (control)
Dosage (units).....	0 (control)
Pairs started (N)					
Oestrus cycle (at least mean length and frequency of irregular cycles)					
Females showing evidence of copulation (N)					
Females achieving pregnancy (N)					
Conceiving days 1 - 5 (N)					
Conceiving days 6 -... (1) (N)					
Pregnancy ≤ 21 days (N)					
Pregnancy = 22 days (N)					
Pregnancy ≥ 23 days (N)					
Dams with live young born (N)					
Dams with live young at day 4 pp (N)					
Implants/dam (mean)					
Live pups/dam at birth (mean)					
Live pups/dam at day 4 (mean)					
Sex ratio (m/f) at birth (mean)					
Sex ratio (m/f) at day 4 (mean)					
Litter weight at birth (mean)					
Litter weight at day 4 (mean)					
Pup weight at birth (mean)					
Pup weight at the time of AGD measurement(mean males, mean females)					
Pup AGD on the same postnatal day, birth- day 4 (mean males, mean females, note PND)					
Pup weight at day 4 (mean)					
Pup weight at day 13 (mean)					

▼ **M8**

OBSERVATIONS	VALUES				
Male pup nipple retention at day 13 (mean)					
ABNORMAL PUPS					
Dams with 0					
Dams with 1					
Dams with ≥ 2					
LOSS OF OFFSPRING					
Pre-natal (implantations minus live births)					
Females with 0					
Females with 1					
Females with 2					
Females with ≥ 3					
Post-natal (live births minus alive at post natal day 13)					
Females with 0					
Females with 1					
Females with 2					
Females with ≥ 3					
(¹) last day of the mating period					

▼M8**B.65. IN VITRO MEMBRANE BARRIER TEST METHOD FOR SKIN CORROSION**

INTRODUCTION

1. This test method is equivalent to OECD test guideline (TG) 435 (2015). Skin corrosion refers to the production of irreversible damage to the skin, manifested as visible necrosis through the epidermis and into the dermis, following the application of a test chemical as defined by the United Nations (UN) Globally Harmonized System of Classification and Labelling of Chemicals (GHS) (1) and the European Union (EU) Regulation 1272/2008 on Classification, Labelling and Packaging of Substances and Mixtures (CLP) (1). This test method, equivalent to the updated OECD test guideline 435 provides an *in vitro* membrane barrier test method that can be used to identify corrosive chemicals. The test method utilises an artificial membrane designed to respond to corrosive chemicals in a manner similar to animal skin *in situ*.
2. Skin corrosivity has traditionally been assessed by applying the test chemical to the skin of living animals and assessing the extent of tissue damage after a fixed period of time (2). Besides the present test method, a number of other *in vitro* test methods have been adopted as alternatives (3)(4) to the standard *in vivo* rabbit skin procedure (Chapter B.4 of this Annex, equivalent to OECD TG 404) used to identify corrosive chemicals (2). The UN GHS tiered testing and evaluation strategy for the assessment and classification of skin corrosivity and the OECD Guidance Document on Integrated Approaches to Testing and Assessment (IATA) for Skin Irritation/Corrosion recommend the use of validated and accepted *in vitro* test methods under modules 3 and 4 (1)(5). The IATA describes several modules which group information sources and analysis tools and (i) provides guidance on how to integrate and use existing test and non-test data for the assessment of the skin irritation and skin corrosion potentials of chemicals and (ii) proposes an approach when further testing is needed, including when negative results are found (5). In this modular approach, positive results from *in vitro* test methods can be used to classify a chemical as corrosive without the need for animal testing, thus reducing and refining the use of animals in and avoiding the pain and distress that might occur if animals were used for this purpose.
3. Validation studies have been completed for the *in vitro* membrane barrier model commercially available as Corrositex® (6)(7)(8), showing an overall accuracy to predict skin corrosivity of 79 % (128/163), a sensitivity of 85 % (76/89), and a specificity of 70 % (52/74) for a database of 163 substances and mixtures (7). Based on its acknowledged validity, this validated reference method (VRM) has been recommended for use as part of a tiered testing strategy for assessing the dermal corrosion hazard potential of chemicals (5)(7). Before an *in vitro* membrane barrier model for skin corrosion can be used for regulatory purposes, its reliability, relevance (accuracy), and limitations for its proposed use should be determined to ensure that it is similar to that of the VRM (9), in accordance with the pre-defined performance standards (PS) (10). The OECD Mutual Acceptance

(1) Regulation (EC) No 1272/2008 of the European Parliament and of the Council of 16 December 2008 on classification, labelling and packaging of substances and mixtures, amending and repealing Directives 67/548/EEC and 1999/45/EC, and amending Regulation (EC) No 1907/2006, OJ L 353/1, 31.12.2008

▼ **M8**

of Data will only be guaranteed after any proposed new or updated method following the PS have been reviewed and included in the equivalent OECD test guideline. Currently, only one *in vitro* method is covered by OECD test guideline 435 and this test method, the commercially available Corrositex[®] model.

- Other test methods for skin corrosivity testing are based on the use of reconstituted human skin (OECD TG 431) (3) and isolated rat skin (OECD TG 430) (4). This Test Guideline also provides for subcategorisation of corrosive chemicals into the three UN GHS Sub-categories of corrosivity and the three UN Transport Packing Groups for corrosivity hazard. This Test Guideline was originally adopted in 2006 and updated in 2015 to refer to the IATA guidance document and update the list of proficiency substances.

DEFINITIONS

- Definitions used are provided in the Appendix.

INITIAL CONSIDERATIONS AND LIMITATIONS

- The test described in this test method allows the identification of corrosive test chemicals and allows the sub-categorisation of corrosive test chemicals according to UN GHS/CLP (Table 1). In addition, such a test method may be used to make decisions on the corrosivity and non-corrosivity of specific classes of chemicals, *e.g.* organic and inorganic acids, acid derivatives⁽¹⁾, and bases for certain transport testing purposes (7)(11)(12). This test method describes a generic procedure similar to the validated reference test method (7). While this test method does not provide adequate information on skin irritation, it should be noted that TM B.46 (equivalent to OECD TG439) specifically addresses the health effect skin irritation *in vitro* (13). For a full evaluation of local skin effects after a single dermal exposure, the OECD Guidance Document on Integrated Approaches for Testing Assessment should be consulted (5).

Table 1

The UN GHS Skin Corrosive Category and Subcategories⁽¹⁾

Corrosive Category (category 1) (for authorities not using subcategories)	Potential Corrosive Subcategories ⁽¹⁾ (for authorities using subcategories, including the CLP Regulation)	Corrosive in ≥ 1 of 3 animals	
		Exposure	Observation
Corrosive	Corrosive subcategory 1A	≤ 3 minutes	≤ 1 hour
	Corrosive subcategory 1B	> 3 minutes ≤ 1 hour	≤ 14 days
	Corrosive subcategory 1C	> 1 hour ≤ 4 hours	≤ 14 days

⁽¹⁾ For the EU, the CLP Regulation applies the three skin corrosion subcategories 1A, 1B and 1C.

- A limitation of the validated reference method (7) is that many non-corrosive chemicals and some corrosive chemicals may not qualify for testing, based on the results of the initial compatibility test (see paragraph 13). Aqueous

⁽¹⁾ 'Acid derivative' is a non-specific class designation and is broadly defined as a chemical produced from an acid either directly or by modification or partial substitution. This class includes anhydrides, halo acids, salts, and other types of chemicals.

▼M8

chemicals with a pH in the range of 4.5 to 8.5 often do not qualify for testing; however, 85 % of chemicals tested in this pH range were non-corrosive in animal tests (7). The *in vitro* membrane barrier method may be used to test solids (soluble or insoluble in water), liquids (aqueous or non-aqueous), and emulsions. However, test chemicals not causing a detectable change in the compatibility test (*i.e.* colour change in the Chemical Detection System (CDS) of the validated reference test method) cannot be tested with the membrane barrier method and should be tested using other test methods.

PRINCIPLE OF THE TEST

8. The test system comprises two components: a synthetic macromolecular bio-barrier and a chemical detection system (CDS); this test method detects via the CDS membrane barrier damage caused by corrosive test chemicals after the application of the test chemical to the surface of the synthetic macromolecular membrane barrier (7), presumably by the same mechanism(s) of corrosion that operate on living skin.
9. Penetration of the membrane barrier (or breakthrough) might be measured by a number of procedures or CDS, including a change in the colour of a pH indicator dye or in some other property of the indicator solution below the barrier.
10. The membrane barrier should be determined to be valid, *i.e.* relevant and reliable, for its intended use. This includes ensuring that different preparations are consistent in regard to barrier properties, *e.g.* capable of maintaining a barrier to non-corrosive chemicals, able to categorise the corrosive properties of chemicals across the various UN GHS Sub-categories of corrosivity (1). The classification assigned is based on the time it takes a chemical to penetrate through the membrane barrier to the indicator solution.

DEMONSTRATION OF PROFICIENCY

11. Prior to routine use of the *in vitro* membrane barrier method, adhering to this test method, laboratories should demonstrate technical proficiency by correctly classifying the twelve Proficiency Substances recommended in Table 2. In situations where a listed substance is unavailable or where justifiable, another substance for which adequate *in vivo* and *in vitro* reference data are available may be used (*e.g.* from the list of reference chemicals (10)) provided that the same selection criteria as described in Table 1 is applied.

Table 2

Proficiency Substances⁽¹⁾

Substance ⁽²⁾	CASRN	Chemical Class	<i>In Vivo</i> UN GHS Sub-category ⁽³⁾	<i>In Vitro</i> UN GHS Sub-category ⁽³⁾
Boron trifluoride dihydrate	13 319-75-0	Inorganic acids	1A	1A
Nitric acid	7 697-37-2	Inorganic acids	1A	1A
Phosphorus pentachloride	10 026-13-8	Precursors of inorganic acids	1A	1A
Valeryl chloride	638-29-9	Acid chlorides	1B	1B
Sodium Hydroxide	1 310-73-2	Inorganic bases	1B	1B

▼M8

Substance ⁽²⁾	CASRN	Chemical Class	<i>In Vivo</i> UN GHS Sub-category ⁽³⁾	<i>In Vitro</i> UN GHS Sub-category ⁽³⁾
1-(2-Aminoethyl) piperazine	140-31-8	Aliphatic amines	1B	1B
Benzenesulfonyl chloride	98-09-9	Acid chlorides	1C	1C
N,N-Dimethyl benzylamine	103-83-3	Anilines	1C	1C
Tetraethylenepentamine	112-57-2	Aliphatic amines	1C	1C
Eugenol	97-53-0	Phenols	NC	NC
Nonyl acrylate	2 664-55-3	Acrylates/methacrylates	NC	NC
Sodium bicarbonate	144-55-8	Inorganic salts	NC	NC

⁽¹⁾ The twelve substances listed above contain three substances from each of the three UN GHS subcategories for corrosive substances and three non-corrosive substances, are readily available from commercial suppliers, and the UN GHS subcategory is based on the results of high-quality *in vivo* testing. These substances are taken from the list of 40 reference substances that are included in the minimum list of chemicals identified for demonstrating the accuracy and reliability of test methods that are structurally and functionally similar to the validated reference test method, and were selected from the 163 reference chemicals that were originally used to validate the reference test method (Corrositex[®]) (7) (10) (14). The goal of this selection process was to include, to the extent possible, chemicals that: were representative of the range of corrosivity responses (e.g. non-corrosives; UN Packing Groups I, II, and III corrosives) that the validated reference test method is capable of measuring or predicting; were representative of the chemical classes used during the validation process; have chemical structures that were well-defined; induced reproducible results in the validated reference test method; induced definitive results in the *in vivo* reference test; were commercially available; and were not associated with prohibitive disposal costs (14).

⁽²⁾ Substances tested neat or with purity 90 %

⁽³⁾ The corresponding UN Packing groups are I, II and III, respectively, for the UN GHS Sub-categories 1A, 1B and 1C. NC; Non-corrosive.

PROCEDURE

12. The following paragraphs describe the components and procedures of an artificial membrane barrier test method for corrosivity assessment (7)(15), based on the current VRM, i.e. the commercially available Corrositex[®]. The membrane barrier and the compatibility/indicator and categorisation solutions can be constructed, prepared or obtained commercially such as in the case of the VRM Corrositex[®]. A sample test method protocol for the validated reference test method is available (7). Testing should be performed at ambient temperature (17-25°C) and the components should comply with the following conditions.

Test Chemical Compatibility Test

13. Prior to performing the membrane barrier test, a compatibility test is performed to determine if the test chemical is detectable by the CDS. If the CDS does not detect the test chemical, the membrane barrier test method is not suitable for evaluating the potential corrosivity of that particular test chemical and a different test method should be used. The CDS and the exposure conditions used for the compatibility test should reflect the exposure in the subsequent membrane barrier test.

Test Chemical Timescale Category Test

14. If appropriate for the test method, a test chemical that has been qualified by the compatibility test should be subjected to a timescale category test, i.e. a screening test to distinguish between weak and strong acids or bases. For example, in the validated reference test method a timescale categorisation test

▼M8

is used to indicate which of two timescales should be used based on whether significant acid or alkaline reserve is detected. Two different breakthrough timescales should be used for determining corrosivity and UN GHS skin corrosivity Sub-category, based on the acid or alkali reserve of the test chemical.

MEMBRANE BARRIER TEST METHOD COMPONENTS**Membrane Barrier**

15. The membrane barrier consists of two components: a proteinaceous macromolecular aqueous gel and a permeable supporting membrane. The proteinaceous gel should be impervious to liquids and solids but can be corroded and made permeable. The fully constructed membrane barrier should be stored under pre-determined conditions shown to preclude deterioration of the gel, *e.g.* drying, microbial growth, shifting, cracking, which would degrade its performance. The acceptable storage period should be determined and membrane barrier preparations not used after that period.

16. The permeable supporting membrane provides mechanical support to the proteinaceous gel during the gelling process and exposure to the test chemical. The supporting membrane should prevent sagging or shifting of the gel and be readily permeable to all test chemicals.

17. The proteinaceous gel, composed of protein, *e.g.* keratin, collagen, or mixtures of proteins, forming a gel matrix, serves as the target for the test chemical. The proteinaceous material is placed on the surface of the supporting membrane and allowed to gel prior to placing the membrane barrier over the indicator solution. The proteinaceous gel should be of equal thickness and density throughout, and with no air bubbles or defects that could affect its functional integrity.

Chemical Detection System (CDS)

18. The indicator solution, which is the same solution used for the compatibility test, should respond to the presence of a test chemical. A pH indicator dye or combination of dyes, *e.g.* cresol red and methyl orange that will show a colour change, in response to the presence of the test chemical, should be used. The measurement system can be visual or electronic.

19. Detection systems that are developed for detecting the passage of the test chemical through the barrier membrane should be assessed for their relevance and reliability in order to demonstrate the range of chemicals that can be detected and the quantitative limits of detection.

TEST PERFORMANCE**Assembly of the Test Method Components**

20. The membrane barrier is positioned in a vial (or tube) containing the indicator solution so that the supporting membrane is in full contact with the indicator solution and with no air bubbles present. Care should be taken to ensure that barrier integrity is maintained.

▼M8**Application of the Test Chemical**

21. A suitable amount of the test chemical, *e.g.* 500 µl of a liquid or 500 mg of a finely powdered solid (7), is carefully layered onto the upper surface of the membrane barrier and evenly distributed. An appropriate number of replicates, *e.g.* four (7), is prepared for each test chemical and its corresponding controls (see paragraphs 23 to 25). The time of applying the test chemical to the membrane barrier is recorded. To ensure that short corrosion times are accurately recorded, the application times of the test chemical to the replicate vials are staggered.

Measurement of Membrane Barrier Penetrations

22. Each vial is appropriately monitored and the time of the first change in the indicator solution, *i.e.* barrier penetration, is recorded, and the elapsed time between application and penetration of the membrane barrier determined.

Controls

23. In tests that involve the use of a vehicle or solvent with the test chemical, the vehicle or solvent should be compatible with the membrane barrier system, *i.e.* not alter the integrity of the membrane barrier system, and should not alter the corrosivity of the test chemical. When applicable, solvent (or vehicle) control should be tested concurrently with the test chemical to demonstrate the compatibility of the solvent with the membrane barrier system.
24. A positive (corrosive) control with intermediate corrosivity activity, *e.g.* 110 ± 15 mg sodium hydroxide (UN GHS Corrosive Sub-category 1B) (7), should be tested concurrently with the test chemical to assess if the test system is performing in an acceptable manner. A second positive control that is of the same chemical class as the test chemical may be useful for evaluating the relative corrosivity potential of a corrosive test chemical. Positive control(s) should be selected that are intermediate in their corrosivity (*e.g.* UN GHS Sub-category 1B) in order to detect changes in the penetration time that may be unacceptably longer or shorter than the established reference value, thereby indicating that the test system is not functioning properly. For this purpose, extremely corrosive (UN GHS Sub-category 1A) or non-corrosive chemicals are of limited utility. A corrosive UN GHS Sub-category 1B chemical would allow detection of a too rapid or too slow breakthrough time. A weakly corrosive (UN GHS Sub-category 1C) might be employed as a positive control to measure the ability of the test method to consistently distinguish between weakly corrosive and non-corrosive chemicals. Regardless of the approach used, an acceptable positive control response range should be developed based on the historical range of breakthrough times for the positive control(s) employed, such as the mean \pm 2-3 standard deviations. In each study, the exact breakthrough time should be determined for the positive control so that deviations outside the acceptable range can be detected.
25. A negative (non-corrosive) control, *e.g.* 10 % citric acid, 6 % propionic acid (7), should also be tested concurrently with the test chemical as another quality control measure to demonstrate the functional integrity of the membrane barrier.

▼ **M8****Study Acceptability Criteria**

26. According to the established time parameters for each of the UN GHS corrosivity Sub-categories, the time (in minutes) elapsed between application of a test chemical to the membrane barrier and barrier penetration is used to predict the corrosivity of the test chemical. For a study to be considered acceptable, the concurrent positive control should give the expected penetration response time (e.g. 8-16 min breakthrough time for sodium hydroxide if used as a positive control), the concurrent negative control should not be corrosive, and, when included, the concurrent solvent control should neither be corrosive nor should it alter the corrosivity potential of the test chemical. Prior to routine use of a method that adheres to this test method, laboratories should demonstrate technical proficiency, using the twelve substances recommended in Table 2. For new 'me-too' methods developed under this test method that are structurally and functionally similar to the validated reference method (14) the pre-defined performance standards should be used to demonstrate the reliability and accuracy of the new method prior to its use for regulatory testing (10).

Interpretation of Results and Corrosivity Classification of Test Chemicals

27. The time (in minutes) elapsed between application of the test chemical to the membrane barrier and barrier penetration is used to classify the test chemical in terms of UN GHS corrosive Sub-categories (1) and, if applicable, UN Packing Group (16). Cut-off time values for each of the three corrosive subcategories are established for each proposed test method. Final decisions on cut-off times should consider the need to minimise under-classification of corrosive hazard (*i.e.* false negatives). In the present test guideline, the cut-off times of Corrositex® as described in table 3 should be used as it represents the only test method currently falling within the test guideline (7).

Table 3

Corrositex® prediction model

Mean breakthrough time (min.)		UN GHS prediction ⁽³⁾
Category 1 test chemicals ⁽¹⁾ (determined by the method's categorisation test)	Category 2 test chemicals ⁽²⁾ (determined by the method's categorisation test)	
0-3 min.	0-3 min.	Corrosive optional Sub-category 1A
> 3 to 60 min.	> 3 to 30 min.	Corrosive optional Sub-category 1B
> 60 to 240 min.	> 30 to 60 min.	Corrosive optional Sub-category 1C
> 240 min.	> 60 min.	Non-corrosive

⁽¹⁾ Test chemicals with high acid/alkaline reserve (6)⁽²⁾ Test chemicals with low acid/alkaline reserve (6)⁽³⁾ UN GHS Subcategories 1A, 1B and 1C correspond to UN packing groups I, II and III respectively

▼M8

DATA AND REPORTING

Data

28. The time (in minutes) elapsed between application and barrier penetration for the test chemical and the positive control(s) should be reported in tabular form as individual replicate data, as well as means \pm the standard deviation for each trial.

Test Report

29. The test report should include the following information:

Test Chemical and Control Substances:

- Mono-constituent substance: chemical identification, such as IUPAC or CAS name, CAS number, SMILES or InChI code, structural formula, purity, chemical identity of impurities as appropriate and practically feasible, etc;
- Multi-constituent substance, UVCB and mixture: characterised as far as possible by chemical identity (see above), quantitative occurrence and relevant physicochemical properties of the constituents;
- Physical appearance, water solubility, and additional relevant physicochemical properties;
- Source, lot number if available;
- Treatment of the test chemical/control substance prior to testing, if applicable (e.g. warming, grinding);
- Stability of the test chemical, limit date for use, or date for re-analysis if known;
- Storage conditions.

Vehicle:

- Identification, concentration (where appropriate), volume used;
- Justification for choice of vehicle.

*In vitro membrane barrier model and protocol used, including demonstrated accuracy and reliability**Test Conditions:*

- Description of the apparatus and preparation procedures used;
- Source and composition of the *in vitro* membrane barrier used;
- Composition and properties of the indicator solution;
- Method of detection;
- Test chemical and control substance amounts;
- Number of replicates;
- Description and justification for the timescale categorisation test;

▼ M8

- Method of application;
- Observation times.
- Description of the evaluation and classification criteria applied;
- Demonstration of proficiency in performing the test method before routine use by testing of the proficiency chemicals.

Results:

- Tabulation of individual raw data from individual test and control samples for each replicate;
- Descriptions of other effects observed;
- The derived classification with reference to the prediction model/decision criteria used.

*Discussion of the results**Conclusions***LITERATURE**

- (1) United Nations (UN) (2013). Globally Harmonized System of Classification and Labelling of Chemicals (GHS), Fifth Revised Edition, UN New York and Geneva, 2013. Available at: http://www.unece.org/trans/danger/publi/ghs/ghs_rev05/05files_e.html
- (2) Chapter B.4 of this Annex, Acute Dermal Irritation, Corrosion.
- (3) Chapter B.40bis of this Annex, *In vitro* skin corrosion: reconstructed human epidermis (RHE) test method.
- (4) Chapter B.40 of this Annex, *In Vitro* Skin Corrosion: Transcutaneous Electrical Resistance (TER).
- (5) OECD (2015). Guidance Document on Integrated Approaches to Testing and Assessment of Skin Irritation/Corrosion. Environment, Health and Safety Publications, Series on Testing and Assessment, (No 203). Organisation for Economic Cooperation and Development, Paris.
- (6) Fentem, J.H., Archer, G.E.B., Balls, M., Botham, P.A., Curren, R.D., Earl, L.K., Esdaile, D.J., Holzhutter, H.-G. and Liebsch, M. (1998). The ECVAM International Validation Study on *In Vitro* Tests for Skin Corrosivity. 2. Results and Evaluation by the Management Team. *Toxicology In Vitro* 12, 483-524.
- (7) ICCVAM (1999). Corrositex®. An *In Vitro* Test Method for Assessing Dermal Corrosivity Potential of Chemicals. The Results of an Independent Peer Review Evaluation Coordinated by ICCVAM, NTP and NICEATM. NIEHS, NIH Publication (No 99-4495.)
- (8) Gordon V.C., Harvell J.D. and Maibach H.I. (1994). Dermal Corrosion, the Corrositex® System: A DOT Accepted Method to Predict Corrosivity Potential of Test Materials. *In vitro* Skin Toxicology-Irritation, Photo-toxicity, Sensitization. *Alternative Methods in Toxicology* 10, 37-45.

▼ M8

- (9) OECD (2005). Guidance Document on the Validation and International Acceptance of New or Updated Test Methods for Hazard Assessment. Environmental, Health and Safety Publications. Series on testing and Assessment (No 34).
- (10) OECD (2014). Performance Standards for the Assessment of Proposed Similar or Modified *In Vitro* Membrane Barrier Test Method for Skin Corrosion in Relation to TG 435. Organisation for Economic Cooperation and Development, Paris. Available at: <http://www.oecd.org/chemicalsafety/testing/PerfStand-TG430-June14.pdf>.
- (11) ECVAM (2001). Statement on the Application of the CORROSITEX Assay for Skin Corrosivity Testing. 15th Meeting of ECVAM Scientific Advisory Committee (ESAC), Ispra, Italy. ATLA 29, 96-97.
- (12) U.S. DOT (2002). Exemption DOT-E-10904 (Fifth Revision). (September 20, 2002). Washington, D.C., U.S. DOT.
- (13) Chapter B.46 of this Annex, *In Vitro* Skin Irritation: Reconstructed Human Epidermis Test Method. ICCVAM (2004). ICCVAM Recommended Performance Standards for *In Vitro* Test Methods for Skin Corrosion. NIEHS, NIH Publication No 04-4510. Available at: http://www.ntp.niehs.nih.gov/iccvam/docs/dermal_docs/ps/ps044510.pdf.
- (14) U.S. EPA (1996). Method 1120, Dermal Corrosion. Available at: <http://www.epa.gov/osw/hazard/testmethods/sw846/pdfs/1120.pdf>.
- (15) United Nations (UN) (2013). UN Recommendations on the Transport of Dangerous Goods, Model Regulations, 18th Revised Edition (Part, Chapter 2.8), UN, 2013. Available at: http://www.unece.org/fileadmin/DAM/trans/danger/publi/unrec/rev18/English/Rev18_Volume1_Part2.pdf.

▼M8*Appendix*

DEFINITIONS

Accuracy: The closeness of agreement between test method results and accepted reference values. It is a measure of test method performance and one aspect of relevance. The term is often used interchangeably with 'concordance' to mean the proportion of correct outcomes of a test method (9).

Chemical: A substance or a mixture.

Chemical Detection System (CDS): A visual or electronic measurement system with an indicator solution that responds to the presence of a test chemical, *e.g.* by a change in a pH indicator dye, or combination of dyes, that will show a colour change in response to the presence of the test chemical or by other types of chemical or electrochemical reactions.

Concordance: This is a measure of test method performance for test methods that give a categorical result, and is one aspect of relevance. The term is sometimes used interchangeably with accuracy, and is defined as the proportion of all chemicals tested that are correctly classified as positive or negative. Concordance is highly dependent on the prevalence of positives in the types of test chemical being examined (9).

GHS (Globally Harmonized System of Classification and Labelling of Chemicals): A system proposing the classification of chemicals (substances and mixtures) according to standardised types and levels of physical, health and environmental hazards, and addressing corresponding communication elements, such as pictograms, signal words, hazard statements, precautionary statements and safety data sheets, so that to convey information on their adverse effects with a view to protect people (including employers, workers, transporters, consumers and emergency responders) and the environment (1).

IATA: Integrated Approach on Testing and Assessment.

Mixture: A mixture or solution composed of two or more substances.

Mono-constituent substance: A substance, defined by its quantitative composition, in which one main constituent is present to at least 80 % (w/w).

Multi-constituent substance: A substance, defined by its quantitative composition, in which more than one main constituent is present in a concentration ≥ 10 % (w/w) and < 80 % (w/w). A multi-constituent substance is the result of a manufacturing process. The difference between mixture and multi-constituent substance is that a mixture is obtained by blending of two or more substances without chemical reaction. A multi-constituent substance is the result of a chemical reaction.

NC: Non corrosive.

Performance standards: Standards, based on a validated test method, that provide a basis for evaluating the comparability of a proposed test method that is mechanistically and functionally similar. Included are (i) essential test method components; (ii) a minimum list of Reference Chemicals selected from among the chemicals used to demonstrate the acceptable performance of the validated test method; and (iii) the similar levels of reliability and accuracy, based on what was obtained for the validated test method, that the proposed test method should demonstrate when evaluated using the minimum list of Reference Chemicals (9).

▼ M8

Relevance: Description of relationship of the test method to the effect of interest and whether it is meaningful and useful for a particular purpose. It is the extent to which the test method correctly measures or predicts the biological effect of interest. Relevance incorporates consideration of the accuracy (concordance) of a test method (9).

Reliability: Measures of the extent that a test method can be performed reproducibly within and between laboratories over time, when performed using the same protocol. It is assessed by calculating intra- and inter-laboratory reproducibility (9).

Sensitivity: The proportion of all positive/active chemicals that are correctly classified by the test method. It is a measure of accuracy for a test method that produces categorical results, and is an important consideration in assessing the relevance of a test method (9).

Skin corrosion *in vivo*: The production of irreversible damage of the skin; namely, visible necrosis through the *epidermis* and into the dermis, following the application of a test chemical for up to four hours. Corrosive reactions are typified by ulcers, bleeding, bloody scabs, and, by the end of observation at 14 days, by discoloration due to blanching of the skin, complete areas of alopecia, and scars. Histopathology should be considered to evaluate questionable lesions.

Specificity: The proportion of all negative/inactive chemicals that are correctly classified by the test method. It is a measure of accuracy for a test method that produces categorical results and is an important consideration in assessing the relevance of a test method (9).

Substance: A chemical element and its compounds in the natural state or obtained by any production process, including any additive necessary to preserve its stability and any impurities deriving from the process used, but excluding any solvent which may be separated without affecting the stability of the substance or changing its composition.

Test chemical: Any substance or mixture tested using this test method.

UVCB: Substances of unknown or variable composition, complex reaction products or biological materials.

▼M8**B.66. STABLY TRANSFECTED TRANSACTIVATION *IN VITRO* ASSAYS TO DETECT ESTROGEN RECEPTOR AGONISTS AND ANTAGONISTS**

GENERAL INTRODUCTION

OECD Performance-Based Test Guideline

1. This test method is equivalent to OECD test guideline (TG) 455 (2016). TG 455 is a performance-based test guideline (PBTG), describing the methodology of Stably Transfected Transactivation *In Vitro* Assays to detect Estrogen Receptor Agonists and Antagonists (ER TA assays). It comprises several mechanistically and functionally similar test methods for the identification of estrogen receptor (i.e. ER α , and/or ER β) agonists and antagonists and should facilitate the development of new similar or modified test methods in accordance with the principles for validation set forth in the OECD Guidance Document on the Validation and International Acceptance of New or Updated Test Methods for Hazard Assessment (1). The fully validated reference test methods (Appendix 2 and Appendix 3) that provide the basis for this PBTG are:

— The Stably Transfected TA (STTA) assay (2) using the (h) ER α -HeLa-9903 cell line; and

— The VM7Luc ER TA assay (3) using the VM7Luc4E2 cell line⁽¹⁾ which predominately expresses hER α with some contribution from hER (4)(5).

For the development and validation of similar assays for the same hazard endpoint, performance standards (PS) (6) (7) are available and should be used. They allow for timely amendment of PBTG 455 so that new similar assays can be added to an updated PBTG; however, similar assays will only be added after review and agreement by OECD that performance standards are met. The assays included in TG 455 can be used indiscriminately to address OECD member countries' requirements for test results on estrogen receptor transactivation while benefiting from the OECD Mutual Acceptance of Data.

Background and principles of the assays included in this test method

2. The OECD initiated a high-priority activity in 1998 to revise existing, and to develop new test guidelines for the screening and testing of potential endocrine disrupting chemicals. The OECD conceptual framework (CF) for testing and assessment of potential endocrine disrupting chemicals was

⁽¹⁾ Before June 2016, this cell line was designated as BG1Luc cell line. BG-1 cells were originally described by Geisinger et al. (1998) (35) and were later characterized by researchers at the National Institute of Environmental Health Sciences (NIEHS) (36). Relatively recently, it was discovered that there exist two different variants of BG-1 cells being used by researchers, BG-1 Fr and BG-1 NIEHS. In-depth analysis, including DNA testing, of these two BG-1 variant cell lines carried out by Li and coworkers (2014) (37) showed that the BG-1 Fr was unique and that the BG-1 NIEHS, i.e. the original cell line used to develop the assay, was not the BG1 human ovarian carcinoma cell line, but was instead a variant of the MCF7 human breast cancer cell line. The cell line used in the assay, originally referred to as BG1Luc4E2 (38), will now be designated as VM7Luc4E2 ('V' = variant; 'M7' = MCF7 cells). Likewise, the assay will now be designated as the VM7Luc ER TA. While this changes the origin of the cell line upon which the assay is based, it does not affect published validation studies nor the utility and application of this assay for screening of estrogenic/anti-estrogenic chemicals.

▼ M8

revised in 2012. The original and revised CFs are included as Annexes in the OECD Guidance Document on Standardised Test Guidelines for Evaluating Chemicals for Endocrine Disruption (8). The CF comprises five levels, each level corresponding to a different level of biological complexity. The ER Transactivation (TA) assays described in this test method are level 2, which includes *in vitro* assays providing data about selected endocrine mechanism(s)/ pathway(s). This test method is for *in vitro* Transactivation (TA) assays designed to identify estrogen receptor (ER) agonists and antagonists.

3. The interaction of estrogens with ERs can affect transcription of estrogen-controlled genes, which can lead to the induction or inhibition of cellular processes, including those necessary for cell proliferation, normal fetal development, and reproductive function (9)(10)(11). Perturbation of normal estrogenic systems may have the potential to trigger adverse effects on normal development (ontogenesis), reproductive health and the integrity of the reproductive system.

4. *In vitro* TA assays are based on a direct or indirect interaction of the substances with a specific receptor that regulates the transcription of a reporter gene product. Such assays have been used extensively to evaluate gene expression regulated by specific nuclear receptors, such as ERs (12) (13) (14) (15) (16). They have been proposed for the detection of estrogenic transactivation regulated by the ER (17) (18) (19). There are at least two major subtypes of nuclear ERs, α and β , which are encoded by distinct genes. The respective proteins have different biological functions as well as different tissue distributions and ligand binding affinities (20)(21)(22)(23)(24)(25)(26). Nuclear ER α mediates the classic estrogenic response (27)(28)(29)(30), and therefore most models currently being developed to measure ER activation or inhibition are specific to ER α . The assays are used to identify chemicals that activate (or inhibit) the ER following ligand binding, after which the receptor-ligand complex binds to specific DNA response elements and transactivates a reporter gene, resulting in increased cellular expression of a marker protein. Different reporter responses can be used in these assays. In luciferase based systems, the luciferase enzyme transforms the luciferin substrate to a bioluminescent product that can be quantitatively measured with a luminometer. Other examples of common reporters are fluorescent protein and the *LacZ* gene, which encodes β -galactosidase, an enzyme that can transform the colourless substrate X-gal (5-bromo-4-chloro-indolyl-galactopyranoside) into a blue product that can be quantified with a spectrophotometer. These reporters can be evaluated quickly and inexpensively with commercially available test kits.

5. Validation studies of the STTA and the VM7Luc TA assays have demonstrated their relevance and reliability for their intended purpose (3)(4)(5)(30). Performance standards for luminescence-based ER TA assays using breast cell lines are included in ICCVAM Test Method Evaluation Report on the LUMI-CELL® ER (VM7Luc ER TA) Test Method: An *In Vitro* Assay for Identifying Human Estrogen Receptor Agonist and Antagonist Activity of Chemicals (3). These performance standards have been modified to be applicable to both the STTA and VM7Luc TA assays (2).

6. Definitions and abbreviations used in this test method are described in Appendix 1.

▼M8**Scope and limitations related to the TA assays**

7. These assays are being proposed for screening and prioritisation purposes, but can also provide mechanistic information that can be used in a weight of evidence approach. They address TA induced by chemical binding to the ERs in an *in vitro* system. Thus, results should not be directly extrapolated to the complex signalling and regulation of the intact endocrine system *in vivo*.

8. TA mediated by the ERs is considered one of the key mechanisms of endocrine disruption (ED), although there are other mechanisms through which ED can occur, including (i) interactions with other ED receptors and enzymatic systems within the endocrine system, (ii) hormone synthesis, (iii) metabolic activation and/or inactivation of hormones, (iv) distribution of hormones to target tissues, and (v) clearance of hormones from the body. None of the assays under this test method addresses these modes of action.

9. This test method addresses the ability of chemicals to activate (i.e. act as agonists) and also to suppress (i.e. act as antagonists) ER- dependent transcription. Some chemicals may, in a cell type-dependent manner, display both agonist and antagonist activity and are known as selective estrogen receptor modulators (SERMs). Chemicals that are negative in these assays could be evaluated in an ER binding assay before concluding that the chemical does not bind to the receptor. In addition, the assays are only likely to inform on the activity of the parent molecule bearing in mind the limited metabolising capacities of the *in vitro* cell systems. Considering that only single substances were used during the validation, the applicability to test mixtures has not been addressed. The test method is nevertheless theoretically applicable to the testing of multi-constituent substances, UVCBs and mixtures. Before use of the test method on a multi-constituent substance, UVCB or mixture for generating data for an intended regulatory purpose, it should be considered whether, and if so why, it may provide adequate results for that purpose. Such considerations are not needed, when there is a regulatory requirement for testing of the mixture.

10. For informational purposes, Table 1 provides the agonist test results for the 34 substances that were tested in both of the fully validated reference test methods described in this test method. Of these substances, 26 are classified as definitive ER agonists and 8 negatives based upon published reports, including *in vitro* assays for ER binding and TA, and/or the uterotrophic assay (2)(3)(18)(31)(32)(33)(34). Table 2 provides the antagonist test results for the 15 substances that were tested in both of the fully validated reference test methods described in this test method. Of these substances, 4 are classified as definitive/presumed ER antagonists and 10 negatives based upon published reports, including *in vitro* assays for ER binding and TA (2)(3)(18)(31). In reference to the data summarised in Table 1 and Table 2, there was 100 % agreement between the two reference test methods on the classifications of all the substances except for one substance (Mifepristone) for antagonist assay, and each substance was correctly classified as an ER agonist/antagonist or negative. Supplementary information on this group of chemicals as well as additional chemicals tested in the STTA and VM7Luc ER TA assays during the validation studies is provided in the Performance Standards for the ERTA (6)(7), Appendix 2 (Tables 1, 2 and 3).

Table 1

Overview of the Results from STTA and VM7Luc ER TA Assays for Substances Tested in Both Agonist Assays and Classified as ER Agonists (POS) or Negatives (NEG)

	Substance	CASRN	STTA Assay ⁽¹⁾			VM7Luc ER TA Assay ⁽²⁾		Data Source For Classification ⁽⁴⁾		
			ER TA Activity	PC ₁₀ Value (M)	PC ₅₀ Value ^(b) (M)	ER TA Activity	EC ₅₀ Value ^(b) , ^(c) (M)	Other ER TAs ^(c)	ER Binding	Uterotrophic
1	17β-estradiol ^(a)	50-28-2	POS	<1,00 × 10 ⁻¹¹	<1,00 × 10 ⁻¹¹	POS	5,63 × 10 ⁻¹²	POS (227/227)	POS	POS
2	17α-estradiol ^(a)	57-91-0	POS	7,24 × 10 ⁻¹¹	6,44 × 10 ⁻¹⁰	POS	1,40 × 10 ⁻⁹	POS(11/11)	POS	POS
3	17α-ethinyl estradiol ^(a)	57-63-6	POS	<1,00 × 10 ⁻¹¹	<1,00 × 10 ⁻¹¹	POS	7,31 × 10 ⁻¹²	POS(22/22)	POS	POS
4	17β-trenbolone	10161-33-8	POS	1,78 × 10 ⁻⁸	2,73 × 10 ⁻⁷	POS	4,20 × 10 ⁻⁸	POS (2/2)	NT	NT
5	19-nortestosterone ^(a)	434-22-0	POS	9,64 × 10 ⁻⁹	2,71 × 10 ⁻⁷	POS	1,80 × 10 ⁻⁶	POS(4/4)	POS	POS
6	4-cumylphenol ^(a)	599-64-4	POS	1,49 × 10 ⁻⁷	1,60 × 10 ⁻⁶	POS	3,20 × 10 ⁻⁷	POS(5/5)	POS	NT
7	4-tert-octylphenol ^(a)	140-66-9	POS	1,85 × 10 ⁻⁹	7,37 × 10 ⁻⁸	POS	3,19 × 10 ⁻⁸	POS(21/24)	POS	POS
8	Apigenin ^(a)	520-36-5	POS	1,31 × 10 ⁻⁷	5,71 × 10 ⁻⁷	POS	1,60 × 10 ⁻⁶	POS(26/26)	POS	NT
9	Atrazine ^(a)	1912-24-9	NEG	—	—	NEG	—	NEG (30/30)	NEG	NT
10	Bisphenol A ^(a)	80-05-7	POS	2,02 × 10 ⁻⁸	2,94 × 10 ⁻⁷	POS	5,33 × 10 ⁻⁷	POS(65/65)	POS	POS
11	Bisphenol B ^(a)	77-40-7	POS	2,36 × 10 ⁻⁸	2,11 × 10 ⁻⁷	POS	1,95 × 10 ⁻⁷	POS(6/6)	POS	POS
12	Butylbenzyl phthalate ^(a)	85-68-7	POS	1,14 × 10 ⁻⁶	4,11 × 10 ⁻⁶	POS	1,98 × 10 ⁻⁶	POS(12/14)	POS	NEG

▼ M8

	Substance	CASRN	STTA Assay (1)			VM7Luc ER TA Assay (2)		Data Source For Classification (4)		
			ER TA Activity	PC ₁₀ Value (M)	PC ₅₀ Value (b) (M)	ER TA Activity	EC ₅₀ Value (b), (c) (M)	Other ER TAs (c)	ER Binding	Uterotrophic
13	Corticosterone (a)	50-22-6	NEG	—	—	NEG	—	NEG(6/6)	NEG	NT
14	Coumestrol (a)	479-13-0	POS	1,23 × 10 ⁻⁹	2,00 × 10 ⁻⁸	POS	1,32 × 10 ⁻⁷	POS(30/30)	POS	NT
15	Daidzein (a)	486-66-8	POS	1,76 × 10 ⁻⁸	1,51 × 10 ⁻⁷	POS	7,95 × 10 ⁻⁷	POS(39/39)	POS	POS
16	Diethylstilbestrol (a)	56-53-1	POS	<1,00 × 10 ⁻¹¹	2,04 × 10 ⁻¹¹	POS	3,34 × 10 ⁻¹¹	POS(42/42)	POS	NT
17	Di-n-butyl phthalate	84-74-2	POS	4,09 × 10 ⁻⁶		POS	4,09 × 10 ⁻⁶	POS(6/11)	POS	NEG
18	Ethyl paraben	120-47-8	POS	5,00 × 10 ⁻⁶	(no PC ₅₀)	POS	2,48 × 10 ⁻⁵	POS		NT
19	Estrone (a)	53-16-7	POS	3,02 × 10 ⁻¹¹	5,88 × 10 ⁻¹⁰	POS	2,34 × 10 ⁻¹⁰	POS(26/28)	POS	POS
20	Genistein (a)	446-72-0	POS	2,24 × 10 ⁻⁹	2,45 × 10 ⁻⁸	POS	2,71 × 10 ⁻⁷	POS(100/102)	POS	POS
21	Haloperidol	52-86-8	NEG	—	—	NEG	—	NEG (2/2)	NEG	NT
22	Kaempferol (a)	520-18-3	POS	1,36 × 10 ⁻⁷	1,21 × 10 ⁻⁶	POS	3,99 × 10 ⁻⁶	POS(23/23)	POS	NT
23	Kepone (a)	143-50-0	POS	7,11 × 10 ⁻⁷	7,68 × 10 ⁻⁶	POS	4,91 × 10 ⁻⁷	POS(14/18)	POS	NT
24	Ketoconazole	65277-42-1	NEG	—	—	NEG	—	NEG (2/2)	NEG	NT
25	Linuron (a)	330-55-2	NEG	—	—	NEG	—	NEG (8/8)	NEG	NT
26	meso-Hexestrol (a)	84-16-2	POS	<1,00 × 10 ⁻¹¹	2,75 × 10 ⁻¹¹	POS	1,65 × 10 ⁻¹¹	POS(4/4)	POS	NT
27	Methyl testosterone (a)	58-18-4	POS	1,73 × 10 ⁻⁷	4,11 × 10 ⁻⁶	POS	2,68 × 10 ⁻⁶	POS(5/6)	POS	NT

▼ M8

	Substance	CASRN	STTA Assay ⁽¹⁾			VM7Luc ER TA Assay ⁽²⁾		Data Source For Classification ⁽⁴⁾		
			ER TA Activity	PC ₁₀ Value (M)	PC ₅₀ Value ^(b) (M)	ER TA Activity	EC ₅₀ Value ^{(b), (3)} (M)	Other ER TAs ^(c)	ER Binding	Uterotrophic
28	Morin	480-16-0	POS	5,43 × 10 ⁻⁷	4,16 × 10 ⁻⁶	POS	2,37 × 10 ⁻⁶	POS(2/2)	POS	NT
29	Norethynodrel ^(a)	68-23-5	POS	1,11 × 10 ⁻¹¹	1,50 × 10 ⁻⁹	POS	9,39 × 10 ⁻¹⁰	POS(5/5)	POS	NT
30	<i>p,p'</i> -Methoxychlor ^(a)	72-43-5	POS	1,23 × 10 ⁻⁶	(no PC ₅₀) ^(a)	POS	1,92 × 10 ⁻⁶	POS(24/27)	POS	POS
31	Phenobarbital ^(a)	57-30-7	NEG	—	—	NEG	—	NEG(2/2)	NEG	NT
32	Reserpine	50-55-5	NEG	—	—	NEG	—	NEG(4/4)	NEG	NT
33	Spirolactone ^(a)	52-01-7	NEG	—	—	NEG	—	NEG(4/4)	NEG	NT
34	Testosterone	58-22-0	POS	2,82 × 10 ⁻⁸	9,78 × 10 ⁻⁶	POS	1,75 × 10 ⁻⁵	POS(5/10)	POS	NT

Abbreviations: CASRN = Chemical Abstracts Service Registry Number; M = molar; EC₅₀ = half maximal effective concentration of test substance; NEG = negative; POS = positive; NT = Not tested; PC₁₀ (and PC₅₀) = the concentration of a test substance at which the response is 10 % (or 50 % for PC₅₀) of the response induced by the positive control (E2, 1nM) in each plate.

^(a) Common substances tested in the STTA and VM7Luc ER TA assays that were designated as ER agonists or negatives and used to evaluate accuracy in the VM7Luc ER TA validation study (ICCVAM VM7Luc ER TA Evaluation Report, Table 4-1 (3)).

^(b) Maximum concentration tested in the absence of limitations due to cytotoxicity or insolubility was 1 × 10⁻⁵ M (STTA Assay) and 1 × 10⁻³ M (VM7Luc ER TA Assay).

^(c) Number in parenthesis represents the test results classified as positive (POS) or negative (NEG) over the total number of referenced studies.

⁽¹⁾ Values reported in Draft Report of Pre-validation and Inter-laboratory Validation For Stably Transfected Transcriptional Activation (TA) Assay to Detect Estrogenic Activity - The Human Estrogen Receptor Alpha Mediated Reporter Gene Assay Using hER-HeLa-9903 Cell Line (2)

⁽²⁾ ICCVAM Test Method Evaluation Report on the LUMI-CELL® ER (VM7Luc ER TA) Test Method: An *In Vitro* Method for Identifying ER Agonists and Antagonists (3)

⁽³⁾ Mean EC₅₀ values were calculated with values reported by the laboratories of the VM7Luc ER TA validation study (XDS, ECVAM, and Hiyoshi) (3).

⁽⁴⁾ Classification as an ER agonist or negative was based upon information in the ICCVAM Background Review Documents (BRD) for ER Binding and TA test methods (31) as well as information obtained from publications published and reviewed after the completion of the ICCVAM BRDs (2) (3) (18) (31) (33) (34).

Notes: Each assay within this test method does not have the same measurements. In some situations the EC₅₀ cannot be calculated because a full dose response curve is not generated. Whilst with the STTA assay, the PC₁₀ value is a key measurement, there may also be further examples where a PC_x will provide useful information.

Table 2

Comparison of Results from STTA and VM7Luc ER TA Assays for Substances Tested in Both Antagonist Assays and Classified as ER Antagonists (POS) or Negatives (NEG)

	Substance ^(a)	CASRN	ER STTA assay ⁽¹⁾		VM7Luc ER TA assay ⁽²⁾		ER STTA candidate effects ⁽⁴⁾	ICCVAM ⁽⁵⁾ Consensus Classification	MeSH ⁽⁶⁾ Chemical Class	Product Class ⁽⁷⁾
			ER TA Activity	IC ₅₀ Value ^(b) (M)	ER TA Activity	IC ₅₀ Value ^{(b), (3)} (M)				
1	4-hydroxytamoxifen	68047-06-3	POS	$3,97 \times 10^{-9}$	POS	$2,08 \times 10^{-7}$	moderate POS	POS	Hydrocarbon (Cyclic)	Pharmaceutical
2	Dibenzo[a,h] anthracene	53-70-3	POS	No IC ₅₀	POS	No IC ₅₀	POS	PP	Polycyclic Compound	Laboratory Chemical, Natural Product
3	Mifepristone	84371-65-3	POS	$5,61 \times 10^{-6}$	NEG	—	mild POS	NEG	Steroid	Pharmaceutical
4	Raloxifene HCl	82640-04-8	POS	$7,86 \times 10^{-10}$	POS	$1,19 \times 10^{-9}$	moderate POS	POS	Hydrocarbon (Cyclic)	Pharmaceutical
5	Tamoxifen	10540-29-1	POS	$4,91 \times 10^{-7}$	POS	$8,17 \times 10^{-7}$	POS	POS	Hydrocarbon (Cyclic)	Pharmaceutical
6	17 β -estradiol	50-28-2	NEG	—	NEG	—	PN	PN	Steroid	Pharmaceutical, Veterinary Agent

▼M8

	Substance ^(a)	CASRN	ER STTA assay ⁽¹⁾		VM7Luc ER TA assay ⁽²⁾		ER STTA candidate effects ⁽⁴⁾	ICCVAM ⁽⁵⁾ Consensus Classification	MeSH ⁽⁶⁾ Chemical Class	Product Class ⁽⁷⁾
			ER TAActivity	IC ₅₀ Value ^(b) (M)	ER TAActivity	IC ₅₀ Value ^{(b), (3)} (M)				
7	Apigenin	520-36-5	NEG	—	NEG	—	NEG	NEG	Heterocyclic Compound	Dye, Natural Product, Pharmaceutical Intermediate
8	Atrazine	1912-24-9	NEG	—	NEG	—	NEG	PN	Heterocyclic Compound	Herbicide
9	Di-n-butyl phthalate	84-74-2	NEG	—	NEG	—	NEG	NEG	Ester, Phthalic Acid	Cosmetic Ingredient, Industrial Chemical, Plasticiser
10	Fenarimol	60168-88-9	NEG	—	NEG	—	not tested	PN	Heterocyclic Compound, Pyrimidine	Fungicide
11	Flavone	525-82-6	NEG	—	NEG	—	PN	PN	Flavonoid, Heterocyclic Compound	Natural Product, Pharmaceutical
12	Flutamide	13311-84-7	NEG	—	NEG	—	NEG	PN	Amide	Pharmaceutical, Veterinary Agent
13	Genistein	446-72-0	NEG	—	NEG	—	PN	NEG	Flavonoid, Heterocyclic Compound	Natural Product, Pharmaceutical

▼ M8

	Substance ^(a)	CASRN	ER STTA assay ⁽¹⁾		VM7Luc ER TA assay ⁽²⁾		ER STTA candidate effects ⁽⁴⁾	ICCVAM ⁽⁵⁾ Consensus Classification	MeSH ⁽⁶⁾ Chemical Class	Product Class ⁽⁷⁾
			ER TAActivity	IC ₅₀ Value ^(b) (M)	ER TAActivity	IC ₅₀ Value ^(b) , ⁽³⁾ (M)				
14	p-n-nonylphenol	104-40-5	NEG	—	NEG	—	not tested	NEG	Phenol	Chemical Intermediate
15	Resveratrol	501-36-0	NEG	—	NEG	—	PN	NEG	Hydrocarbon (Cyclic)	Natural Product

Abbreviations: CASRN = Chemical Abstracts Service Registry Number; M = molar; IC₅₀ = half maximal inhibitory concentration of test substance; NEG = negative; PN = presumed negative; POS = positive; PP = presumed positive.

^(a) Common substances tested in the STTA and VM7Luc ER TA assays that were designated as ER antagonists or negatives and used to evaluate accuracy in the VM7Luc ER TA validation study (2) (3).

^(b) Maximum concentration tested in the absence of limitations due to cytotoxicity or insolubility was 1×10^{-3} M (STTA Assay) and 1×10^{-5} M (VM7Luc ER TA Assay).

⁽¹⁾ The Validation Report of the Stably transfected Transcriptional Activation Assay to Detect ER mediated activity, Part B (2)

⁽²⁾ ICCVAM Test Method Evaluation Report on the LUMI-CELL® ER (VM7Luc ER TA) Test Method: An *In Vitro* Method for Identifying ER Agonists and Antagonists (3).

⁽³⁾ Mean IC₅₀ values were calculated with values reported by the laboratories of the VM7Luc ER TA validation study (XDS, ECVAM, and Hiyoshi) (3).

⁽⁴⁾ ER STTA activity assumed from their reported effects known from the CERI historical data of ER receptor binding assay, the uterotrophic assay and information collated from the open literature (2)

⁽⁵⁾ Classification as an ER antagonist or negative was based upon information in the ICCVAM Background Review Documents (BRD) for ER Binding and TA assays (31) as well as information obtained from publications published and reviewed after the completion of the ICCVAM BRDs (2) (3) (18) (31).

⁽⁶⁾ Substances were assigned to one or more chemical classes using the U.S. National Library of Medicine's Medical Subject Headings (MeSH), an internationally recognised standardised classification scheme (available at <http://www.nlm.nih.gov/mesh>).

⁽⁷⁾ Substances were assigned to one or more product classes using the U.S. National Library of Medicine's Hazardous Substances Data Bank (available at <http://toxnet.nlm.nih.gov/cgi-bin/sis/htmlgen?HSDB>).

▼M8**ER TA ASSAY COMPONENTS****Essential Assay Components**

11. This test method applies to assays using a stably transfected or endogenous ER α receptor and stably transfected reporter gene construct under the control of one or more estrogen response elements; however, other receptors such as ER β may be present. These are essential assay components.

Controls

12. The basis for the proposed concurrent reference standards for each of agonist and antagonist assay should be described. Concurrent controls (negative, solvent, and positive), as appropriate, serve as an indication that the assay is operative under the test conditions and provide a basis for experiment-to-experiment comparisons; they are usually part of the acceptability criteria for a given experiment (1).

Standard Quality Control Procedures

13. Standard quality control procedures should be performed as described for each assay to ensure the cell line remains stable through multiple passages, remains mycoplasma-free (i.e. free of bacterial contamination), and retains the ability to provide the expected ER-mediated responses over time. Cell lines should be further checked for their correct identity as well as for other contaminants (e.g. fungi, yeast and viruses).

Demonstration of Laboratory Proficiency

14. Prior to testing unknown chemicals with any of the assays under this test method, each laboratory should demonstrate proficiency in using the assay. To demonstrate proficiency, each laboratory should test the 14 proficiency substances listed in Table 3 for the agonist assay and 10 proficiency substances in Table 4 for the antagonist assay. This proficiency testing will also confirm the responsiveness of the test system. The list of proficiency substances is a subset of the reference substances provided in the Performance Standards for the ER TA assays (6). These substances are commercially available, represent the classes of chemicals commonly associated with ER agonist or antagonist activity, exhibit a suitable range of potency expected for ER agonists/antagonists (i.e. strong to weak) and include negatives. Testing of the proficiency substances should be replicated at least twice, on different days. Proficiency is demonstrated by correct classification (positive/negative) of each proficiency substance. Proficiency testing should be repeated by each technician when learning the assays. Dependent on cell type, some of these proficiency substances may behave as SERMs and display activity as both agonists and antagonists. However, the proficiency substances are classified in Tables 3 and 4 by their known predominant activity which should be used for proficiency evaluation.
15. To demonstrate performance and for quality control purposes each laboratory should compile agonist and antagonist historical databases with reference standard (e.g. 17 β -estradiol and tamoxifen), positive and negative control chemicals and solvent control (e.g. DMSO) data. As a start, the database should be generated from at least 10 independent agonist (e.g. 17 β -estradiol) and 10 independent antagonist (e.g. tamoxifen) runs. Results from future analyses of these reference standards and solvent controls should be added to enlarge the database to ensure consistency and performance of the bioassay by the laboratory over time.

Table 3

List of (14) Proficiency Substances for agonist assay (1)

N ^o (8)	Substance	CASRN	Expected Response (2)	STTA Assay			VM7Luc ER TA Assay		MeSH Chemical Class (6)	Product Class (7)
				PC ₁₀ Value (M) (3)	PC ₅₀ Value (M) (3)	Test Conc. Range (M)	VM7Luc EC ₅₀ Value (M) (4)	Highest Conc. for Range Finder (M) (5)		
14	Diethylstilbestrol	56-53-1	POS	$<1,00 \times 10^{-11}$	$2,04 \times 10^{-11}$	$10^{-14} - 10^{-8}$	$3,34 \times 10^{-11}$	$3,73 \times 10^{-4}$	Hydrocarbon (Cyclic)	Pharmaceutical, Veterinary Agent
12	17 α -estradiol	57-91-0	POS	$4,27 \times 10^{-11}$	$6,44 \times 10^{-10}$	$10^{-11} - 10^{-5}$	$1,40 \times 10^{-9}$	$3,67 \times 10^{-3}$	Steroid	Pharmaceutical, Veterinary Agent
15	<i>meso</i> -Hexestrol	84-16-2	POS	$<1,00 \times 10^{-11}$	$2,75 \times 10^{-11}$	$10^{-11} - 10^{-5}$	$1,65 \times 10^{-11}$	$3,70 \times 10^{-3}$	Hydrocarbon (Cyclic), Phenol	Pharmaceutical, Veterinary Agent
11	4- <i>tert</i> -Octylphenol	140-66-9	POS	$1,85 \times 10^{-9}$	$7,37 \times 10^{-8}$	$10^{-11} - 10^{-5}$	$3,19 \times 10^{-8}$	$4,85 \times 10^{-3}$	Phenol	Chemical Intermediate
9	Genistein	446-72-0	POS	$2,24 \times 10^{-9}$	$2,45 \times 10^{-8}$	$10^{-11} - 10^{-5}$	$2,71 \times 10^{-7}$	$3,70 \times 10^{-4}$	Flavonoid, Heterocyclic Compound	Natural Product, Pharmaceutical
6	Bisphenol A	80-05-7	POS	$2,02 \times 10^{-8}$	$2,94 \times 10^{-7}$	$10^{-11} - 10^{-5}$	$5,33 \times 10^{-7}$	$4,38 \times 10^{-3}$	Phenol	Chemical Intermediate

▼ M8

N° (8)	Substance	CASRN	Expected Response (2)	STTA Assay			VM7Luc ER TA Assay		MeSH Chemical Class (6)	Product Class (7)
				PC ₁₀ Value (M) (3)	PC ₅₀ Value (M) (3)	Test Conc. Range (M)	VM7Luc EC ₅₀ Value (M) (4)	Highest Conc. for Range Finder (M) (5)		
2	Kaempferol	520-18-3	POS	$1,36 \times 10^{-7}$	$1,21 \times 10^{-6}$	$10^{-11} - 10^{-5}$	$3,99 \times 10^{-6}$	$3,49 \times 10^{-3}$	Flavonoid, Heterocyclic Compound	Natural Product
3	Butylbenzyl phthalate	85-68-7	POS	$1,14 \times 10^{-6}$	$4,11 \times 10^{-6}$	$10^{-11} - 10^{-5}$	$1,98 \times 10^{-6}$	$3,20 \times 10^{-4}$	Carboxylic Acid, Ester, Phthalic Acid	Plasticiser, Industrial Chemical
4	<i>p,p'</i> -Methoxychlor	72-43-5	POS	$1,23 \times 10^{-6}$	—	$10^{-11} - 10^{-5}$	$1,92 \times 10^{-6}$	$2,89 \times 10^{-3}$	Hydrocarbon (Halogenated)	Pesticide, Veterinary Agent
1	Ethyl paraben	120-47-8	POS	$5,00 \times 10^{-6}$	—	$10^{-11} - 10^{-5}$	$2,48 \times 10^{-5}$	$6,02 \times 10^{-3}$	Carboxylic Acid, Phenol	Pharmaceutical, Preservative
17	Atrazine	1912-24-9	NEG	—	—	$10^{-10} - 10^{-4}$	—	$4,64 \times 10^{-4}$	Heterocyclic Compound	Herbicide
20	Spirolactone	52-01-7	NEG	—	—	$10^{-11} - 10^{-5}$	—	$2,40 \times 10^{-3}$	Lactone, Steroid	Pharmaceutical
21	Ketoconazole	65277-42-1	NEG	—	—	$10^{-11} - 10^{-5}$	—	$9,41 \times 10^{-5}$	Heterocyclic Compound	Pharmaceutical

▼ M8

N° ⁽⁸⁾	Substance	CASRN	Expected Response ⁽²⁾	STTA Assay			VM7Luc ER TA Assay		MeSH Chemical Class ⁽⁶⁾	Product Class ⁽⁷⁾
				PC ₁₀ Value (M) ⁽³⁾	PC ₅₀ Value (M) ⁽³⁾	Test Conc. Range (M)	VM7Luc EC ₅₀ Value (M) ⁽⁴⁾	Highest Conc. for Range Finder (M) ⁽⁵⁾		
22	Reserpine	50-55-5	NEG	—	—	10 ⁻¹¹ – 10 ⁻⁵	—	1,64 × 10 ⁻³	Heterocyclic Compound, Indole	Pharmaceutical, Veterinary Agent

Abbreviations: CASRN = Chemical Abstracts Service Registry Number; EC₅₀ = half maximal effective concentration of test substance; NEG = negative; POS = positive; PC₁₀ (and PC₅₀) = the concentration of a test substance at which the response is 10 % (or 50 % for PC₅₀) of the response induced by the positive control (E2, 1nM) in each plate.

(1) Classification as positive or negative for ER agonist activity was based upon the ICCVAM Background Review Documents (BRD) for ER Binding and TA assays (31) as well as empirical data and other information obtained from referenced studies published and reviewed after the completion of the ICCVAM BRDs(2) (3) (18) (31) (32) (33) (34).

(2) Values reported in Draft Report of Pre-validation and Inter-laboratory Validation For Stably Transfected Transcriptional Activation (TA) Assay to Detect Estrogenic Activity - The Human Estrogen Receptor Alpha Mediated Reporter Gene Assay Using hER-HeLa-9903 Cell Line (30).

(3) Mean EC₅₀ values were calculated with values reported by the laboratories of the VM7Luc ER TA validation study (XDS, ECVAM, and Hiyoshi) (3).

(4) Concentrations reported were the highest concentrations tested (range finder) during the validation of the VM7Luc ER TA Assay. If concentrations differed between the laboratories, the highest concentration is reported. See table 4-10 of ICCVAM Test Method Evaluation Report; The LUMI-Cell®ER (VM7Luc ER TA) Test Method: An *In Vitro* Assay for Identifying Human Estrogen Receptor Agonist and Antagonist Activity of Chemicals (3).

(5) Substances were assigned into one or more chemical classes using the U.S. National Library of Medicine's Medical Subject Headings (MeSH), an internationally recognised standardised classification scheme (available at <http://www.nlm.nih.gov/mesh>).

(6) Substances were assigned into one or more product classes using the U.S. National Library of Medicine's Hazardous Substances Database (available at: <http://toxnet.nlm.nih.gov/cgi-bin/sis/htmlgen?HSDB>)

(7) From Table 1 (List of Reference Chemicals (22) for Evaluation of ER Agonist Accuracy) of the Performance Standards (6)

(8) If a proficiency substance is no longer commercially available, a substance with the same classification and, comparable potency, mode of action and chemical class can be used.

Table 4

List of (10) Proficiency Substances for antagonist assay

	Substance ⁽³⁾	CASRN	ER STTA assay ⁽¹⁾			VM7Luc ER TA assay ⁽²⁾			ER STTA ⁽¹⁾ Candidate Effects	ICCVAM ⁽⁵⁾ Consensus Classification	MeSH ⁽⁶⁾ Chemical Class	Product Class ⁽⁷⁾
			ER TA Activity	IC ₅₀ (M)	Test Conc. range (M)	ER TA Activity	IC ₅₀ ⁽³⁾ (M)	Highest Conc. for Range Finder (M) ⁽⁴⁾				
1	4-hydroxytamoxifen	68047-06-3	POS	$3,97 \times 10^{-9}$	$10^{-12} - 10^{-7}$	POS	$2,08 \times 10^{-7}$	$2,58 \times 10^{-4}$	moderate POS	POS	Hydrocarbon (Cyclic)	Pharmaceutical
2	Raloxifene HCl	82640-04-8	POS	$7,86 \times 10^{-10}$	$10^{-12} - 10^{-7}$	POS	$1,19 \times 10^{-9}$	$1,96 \times 10^{-4}$	moderate POS	POS	Hydrocarbon (Cyclic)	Pharmaceutical
3	Tamoxifen	10540-29-1	POS	$4,91 \times 10^{-7}$	$10^{-10} - 10^{-5}$	POS	$8,17 \times 10^{-7}$	$2,69 \times 10^{-4}$	POS	POS	Hydrocarbon (Cyclic)	Pharmaceutical
4	17 β -estradiol	50-28-2	NEG	—	$10^{-9} - 10^{-4}$	NEG	—	$3,67 \times 10^{-3}$	to be negative (*)	PN	Steroid	Pharmaceutical, Veterinary Agent
5	Apigenin	520-36-5	NEG	—	$10^{-9} - 10^{-4}$	NEG	—	$3,70 \times 10^{-4}$	NEG	NEG	Heterocyclic Compound	Dye, Natural Product, Phar- maceutical Inter- mediate
6	Di-n-butyl phthalate	84-74-2	NEG	—	$10^{-8} - 10^{-3}$	NEG	—	$3,59 \times 10^{-3}$	NEG	NEG	Ester, Phthalic Acid	Cosmetic Ingredient, Industrial Chemical, Plas- ticiser

▼ M8

	Substance ^(a)	CASRN	ER STTA assay ⁽¹⁾			VM7Luc ER TA assay ⁽²⁾			ER STTA ⁽¹⁾ Candidate Effects	ICCVAM ⁽⁵⁾ Consensus Classification	MeSH ⁽⁶⁾ Chemical Class	Product Class ⁽⁷⁾
			ER TA Activity	IC ₅₀ (M)	Test Conc. range (M)	ER TA Activity	IC ₅₀ ⁽³⁾ (M)	Highest Conc. for Range Finder (M) ⁽⁴⁾				
7	Flavone	525-82-6	NEG	—	10 ⁻⁸ – 10 ⁻³	NEG	—	4,50 × 10 ⁻⁴	to be negative (*)	PN	Flavonoid, Hetero- cyclic Compound	Natural Product, Pharmaceutical
8	Genistein	446-72-0	NEG	—	10 ⁻⁹ – 10 ⁻⁴	NEG	—	3,70 × 10 ⁻⁴	to be negative (*)	NEG	Flavonoid, Hetero- cyclic Compound	Natural Product, Pharmaceutical
9	p-n-nonylphenol	104-40-5	NEG	—	10 ⁻⁹ – 10 ⁻⁴	NEG	—	4,54 × 10 ⁻⁴	not tested	NEG	Phenol	Chemical Inter- mediate
10	Resveratrol	501-36-0	NEG	—	10 ⁻⁸ – 10 ⁻³	NEG	—	4,38 × 10 ⁻⁴	to be negative (*)	NEG	Hydrocarbon (Cyclic)	Natural Product

Abbreviations: CASRN = Chemical Abstracts Service Registry Number; M = molar; IC₅₀ = half maximal inhibitory concentration of test substance; NEG = negative; PN = presumed negative; POS = positive.

(*) classified negative according to literature review (2).

^(a) Common substances tested in the STTA and VM7Luc ER TA assays that were designated as ER antagonists or negatives and used to evaluate accuracy in the VM7Luc ER TA validation study (2) (3).

⁽¹⁾ The Validation Report of the Stably transfected Transcriptional Activation Assay to Detect ER mediated activity, Part B (2)

⁽²⁾ ICCVAM Test Method Evaluation Report on the LUMI-CELL ER (VM7Luc ER TA) Test Method: An *In Vitro* Method for Identifying ER Agonists and Antagonists (3).

⁽³⁾ Mean IC₅₀ values were calculated with values reported by the laboratories of the VM7Luc ER TA validation study (XDS, ECVAM, and Hiyoshi) (3).

⁽⁴⁾ Concentrations reported were the highest concentrations tested (range finder) during the validation of the VM7Luc ER TA Assay. If concentrations differed between the laboratories, the highest concentration is reported. See table 4-11 of ICCVAM Test Method Evaluation Report; The LUMI-Cell®ER (VM7Luc ER TA) Test Method: An *In Vitro* Assay for Identifying Human Estrogen Receptor Agonist and Antagonist Activity of Chemicals (3).

⁽⁵⁾ Classification as an ER antagonist or negative was based upon information in the ICCVAM Background Review Documents (BRD) for ER Binding and TA test methods (31) as well as information obtained from publications published and reviewed after the completion of the ICCVAM BRDs (2) (3) (18) (31).

⁽⁶⁾ Substances were assigned to one or more chemical classes using the U.S. National Library of Medicine's Medical Subject Headings (MeSH), an internationally recognised standardised classification scheme (available at <http://www.nlm.nih.gov/mesh>).

⁽⁷⁾ Substances were assigned to one or more product classes using the U.S. National Library of Medicine's Hazardous Substances Data Bank (available at <http://toxnet.nlm.nih.gov/cgi-bin/sis/htmlgen?HSDB>).

▼ M8**Test Run Acceptability Criteria**

16. Acceptance or rejection of a test run is based on the evaluation of results obtained for the reference standards and controls used for each experiment. Values for the PC₅₀ (EC₅₀) or IC₅₀ for the reference standards should meet the acceptability criteria as provided for the selected assay (for STTA see Appendix 2, for VM7Luc ER TA see Appendix 3), and all positive/negative controls should be correctly classified for each accepted experiment. The ability to consistently conduct the assay should be demonstrated by the development and maintenance of a historical database for the reference standards and controls (see paragraph 15). Standard deviations (SD) or coefficients of variation (CV) for the means of reference standards curve fitting parameters from multiple experiments may be used as a measure of within-laboratory reproducibility. In addition, the following principles regarding acceptability criteria should be met:
- Data should be sufficient for a quantitative assessment of ER activation (for agonist assay) or suppression (for antagonist assay) (i.e. efficacy and potency).
 - The mean reporter activity for the reference concentration of reference estrogen should be at least the minimum specified in the assays relative to that of the vehicle (solvent) control to ensure adequate sensitivity. For the STTA and VM7Luc ER TA assays, this is four times that of the mean vehicle control on each plate.
 - The concentrations tested should remain within the solubility range of the test chemicals and not demonstrate cytotoxicity.

Analysis of data

17. The defined data interpretation procedure for each assay should be used for classifying a positive and negative response.
18. Meeting the acceptability criteria (paragraph 16) indicates the assay is operating properly, but it does not ensure that any particular test run will produce accurate data. Replicating the results of the first run is the best indication that accurate data were produced. If two runs give reproducible results (e.g. both test run results indicate a test chemical is positive), it is not necessary to conduct a third run.
19. If two runs do not give reproducible results (e.g. a test chemical is positive in one run and negative in the other run), or if a higher degree of certainty is required regarding the outcome of this assay, at least three independent runs should be conducted. In this case the classification is based on the two concordant results out of the three.

General Data Interpretation Criteria

20. There is currently no universally agreed method for interpreting ER TA data. However, both qualitative (e.g. positive/negative) and/or quantitative (e.g. EC₅₀, PC₅₀, IC₅₀) assessments of ER-mediated activity should be based on empirical data and sound scientific judgment. Where possible, positive results should be characterised by both the magnitude of the effect as compared to the vehicle (solvent) control or reference estrogen and the concentration at which the effect occurs (e.g. an EC₅₀, PC₅₀, RPC_{Max}, IC₅₀, etc.).

▼ M8**Test Report**

21. The test report should include the following information:

Assay:

- assay used;
- control/Reference standard/Test chemical;
- source, lot number, limit date for use, if available;
- stability of the test chemical itself, if known;
- solubility and stability of the test chemical in solvent, if known;
- measurement of pH, osmolality and precipitate in the culture medium to which the test chemical was added, as appropriate.

Mono-constituent substance:

- physical appearance, water solubility, and additional relevant physico-chemical properties;
- chemical identification, such as IUPAC or CAS name, CAS number, SMILES or InChI code, structural formula, purity, chemical identity of impurities as appropriate and practically feasible, etc.

Multi-constituent substance, UVCBs and mixtures:

- characterised as far as possible by chemical identity (see above), quantitative occurrence and relevant physicochemical properties of the constituents.

Solvent/Vehicle:

- characterisation (nature, supplier and lot);
- justification for choice of solvent/vehicle;
- solubility and stability of the test chemical in solvent/vehicle, if known.

Cells:

- type and source of cells:
 - Is ER endogenously expressed? If not, which receptor(s) were transfected?
 - Reporter construct(s) used (including source species);
 - Transfection method;
 - Selection method for maintenance of stable transfection (where applicable);
 - Is the transfection method relevant for stable lines?
- number of cell passages (from thawing);

▼ M8

- passage number of cells at thawing;
- methods for maintenance of cell cultures.

Test conditions:

- solubility limitations;
- description of the methods of assessing viability applied;
- composition of media, CO₂ concentration;
- concentrations of test chemical;
- volume of vehicle and test chemical added;
- incubation temperature and humidity;
- duration of treatment;
- cell density at the start of - and during treatment;
- positive and negative reference standards;
- reporter reagents (product name, supplier and lot);
- criteria for considering test runs as positive, negative or equivocal.

Acceptability check:

- fold inductions for each assay plate and whether they meet the minimum required by the assay based on historical controls;
- actual values for acceptability criteria, e.g. $\log_{10}EC_{50}$, $\log_{10}PC_{50}$, $\log IC_{50}$ and Hill slope values, for concurrent positive controls/reference standards.

Results:

- raw and normalised data;
- the maximum fold induction level;
- cytotoxicity data;
- if it exists, the lowest effective concentration (LEC);
- RPC_{Max} , PC_{Max} , PC_{50} , IC_{50} and/or EC_{50} values, as appropriate;
- concentration-response relationship, where possible;

▼M8

- statistical analyses, if any, together with a measure of error and confidence (e.g. SEM, SD, CV or 95 % CI) and a description of how these values were obtained.

Discussion of the results

Conclusion

LITERATURE

- (1) OECD (2005). Guidance Document on the Validation and International Acceptance of New or Updated Test Methods for Hazard Assessment. Environment, Health and Safety Publications, Series on Testing and Assessment (No 34.), Organisation for Economic Cooperation and Development, Paris.
- (2) OECD (2015). Report of the Inter-Laboratory Validation for Stably Transfected Transactivation Assay to detect Estrogenic and Anti-estrogenic Activity. Environment, Health and Safety Publications, Series on Testing and Assessment (No 225), Organisation for Economic Cooperation and Development, Paris.
- (3) ICCVAM (2011). ICCVAM Test Method Evaluation Report on the LUMI-CELL® ER (BG1Luc ER TA) Test Method, an *In Vitro* Method for Identifying ER Agonists and Antagonists, National Institute of Environmental Health Sciences: Research Triangle Park, NC.
- (4) Pujol P. *et al.* (1998). Differential Expression of Estrogen Receptor-Alpha and -Beta Messenger RNAs as a Potential Marker of Ovarian Carcinogenesis, *Cancer. Res.*, 58(23): p. 5367-73.
- (5) Rogers J.M. and Denison M.S. (2000). Recombinant Cell Bioassays for Endocrine Disruptors: Development of a Stably Transfected Human Ovarian Cell Line for the Detection of Estrogenic and Anti-Estrogenic Chemicals, *In Vitro and Molecular Toxicology: Journal of Basic and Applied Research*, 13(1): p. 67-82.
- (6) OECD (2012). Performance Standards For Stably Transfected Transactivation *In Vitro* Assay to Detect Estrogen Receptor Agonists (for TG 455). Environment, Health and Safety Publications, Series on Testing and Assessment (No 173.), Organisation for Economic Cooperation and Development, Paris.
- (7) OECD (2015). Performance Standards For Stably Transfected Transactivation *In Vitro* Assay to Detect Estrogen Receptor Antagonists. Environment, Health and Safety Publications, Series on Testing and Assessment (No 174.), Organisation for Economic Cooperation and Development, Paris.
- (8) OECD (2012). Guidance Document on Standardized Test Guidelines for Evaluating Chemicals for Endocrine Disruption. Environment, Health and Safety Publications, Series on Testing and Assessment (No 150.), Organisation for Economic Cooperation and Development, Paris.
- (9) Cavailles V. (2002). Estrogens and Receptors: an Evolving Concept. *Climacteric*, 5 Suppl 2: p. 20- 6.
- (10) Welboren W.J. *et al.* (2009). Genomic Actions of Estrogen Receptor Alpha: What are the Targets and how are they Regulated? *Endocr. Relat. Cancer*, 16(4): p. 1073-89.
- (11) Younes M. and Honma N. (2011). Estrogen Receptor Beta, *Arch. Pathol. Lab. Med.*, 135(1): p. 63- 6.

▼M8

- (12) Jefferson W.N., *et al.* (2002). Assessing Estrogenic Activity of Phytochemicals Using Transcriptional Activation and Immature Mouse Uterotrophic Responses, *Journal of Chromatography B*, 777(1-2): p. 179-189.
- (13) Sonneveld E. *et al.* (2006). Comparison of *In Vitro* and *In Vivo* Screening Models for Androgenic and Estrogenic Activities, *Toxicol. Sci.*, 89(1): p. 173-187.
- (14) Takeyoshi M. *et al.* (2002). The Efficacy of Endocrine Disruptor Screening Tests in Detecting Anti- Estrogenic Effects Downstream of Receptor-Ligand Interactions, *Toxicology Letters*, 126(2): p. 91- 98.
- (15) Combes R.D. (2000). Endocrine Disruptors: a Critical Review of *In Vitro* and *In Vivo* Testing Strategies for Assessing their Toxic Hazard to Humans, *ATLA Alternatives to Laboratory Animals*, 28(1): p. 81-118.
- (16) Escande A. *et al.* (2006). Evaluation of Ligand Selectivity Using Reporter Cell Lines Stably Expressing Estrogen Receptor Alpha or Beta, *Biochem. Pharmacol.*, 71(10): p. 1459-69.
- (17) Gray L.E. Jr. (1998). Tiered Screening and Testing Strategy for Xenoestrogens and Antiandrogens, *Toxicol. Lett.*, 102-103, 677-680.
- (18) EDSTAC (1998). Endocrine Disruptor Screening and Testing Advisory Committee (EDSTAC) Final Report.
- (19) ICCVAM (2003). ICCVAM Evaluation of *In Vitro* Test Methods for Detecting Potential Endocrine Disruptors: Estrogen Receptor and Androgen Receptor Binding and Transcriptional Activation Assays.
- (20) Gustafsson J.Ö. (1999). Estrogen Receptor β - A New Dimension in Estrogen Mechanism of Action, *Journal of Endocrinology*, 163(3): p. 379-383.
- (21) Ogawa S. *et al.* (1998). The Complete Primary Structure of Human Estrogen Receptor β (hERB) and its Heterodimerization with ER *In Vivo* and *In Vitro*, *Biochemical and Biophysical Research Communications*, 243(1): p. 122-126.
- (22) Enmark E. *et al.* (1997). Human Estrogen Receptor β -Gene Structure, Chromosomal Localization, and Expression Pattern, *Journal of Clinical Endocrinology and Metabolism*, 82(12): p. 4258-4265.
- (23) Ball L.J. *et al.* (2009). Cell Type- and Estrogen Receptor-Subtype Specific Regulation of Selective Estrogen Receptor Modulator Regulatory Elements, *Molecular and Cellular Endocrinology*, 299(2): p. 204-211.
- (24) Barkhem T. *et al.* (1998). Differential Response of Estrogen Receptor Alpha and Estrogen Receptor Beta to Partial Estrogen Agonists/Antagonists, *Mol. Pharmacol.*, 54(1): p. 105-12.
- (25) Deroo B.J. and Buensuceso A.V. (2010). Minireview: Estrogen Receptor- β : Mechanistic Insights from Recent Studies, *Molecular Endocrinology*, 24(9): p. 1703-1714.
- (26) Harris D.M. *et al.* (2005). Phytoestrogens Induce Differential Estrogen Receptor Alpha- or Beta- Mediated Responses in Transfected Breast Cancer Cells, *Experimental Biology and Medicine*, 230(8): p. 558-568.
- (27) Anderson J.N. Clark J.H. and Peck E.J.Jr. (1972). The Relationship Between Nuclear Receptor- Estrogen Binding and Uterotrophic Responses, *Biochemical and Biophysical Research Communications*, 48(6): p. 1460-1468.

▼M8

- (28) Toft D. (1972). The Interaction of Uterine Estrogen Receptors with DNA, *Journal of Steroid Biochemistry*, 3(3): p. 515-522.
- (29) Gorski J. *et al.* (1968), Hormone Receptors: Studies on the Interaction of Estrogen with the Uterus, *Recent Progress in Hormone Research*, 24: p. 45-80.
- (30) Jensen E.V. *et al.* (1967), Estrogen-Receptor Interactions in Target Tissues, *Archives d'Anatomie Microscopique et de Morphologie Experimentale*, 56(3):p. 547-569.
- (31) ICCVAM (2002). Background Review Document: Estrogen Receptor Transcriptional Activation (TA) Assay. Appendix D, Substances Tested in the ER TA Assay, NIH Publication Report (No 03-4505.).
- (32) Kanno J. *et al.* (2001). The OECD Program to Validate the Rat Uterotrophic Bioassay to Screen Compounds for *In Vivo* Estrogenic Responses: Phase 1, *Environ. Health Persp.*, 109:785-94.
- (33) Kanno J. *et al.* (2003). The OECD Program to Validate the Rat Uterotrophic Bioassay: Phase Two Dose -Response Studies, *Environ. Health Persp.*, 111:1530-1549.
- (34) Kanno J. *et al.* (2003), The OECD Program to Validate the Rat Uterotrophic Bioassay: Phase Two – Coded Single-Dose Studies, *Environ. Health Persp.*, 111:1550-1558.
- (35) Geisinger *et al.* (1989) Characterization of a human ovarian carcinoma cell line with estrogen and progesterone receptors, *Cancer* 63, 280-288.
- (36) Baldwin *et al.* (1998) BG-1 ovarian cell line: an alternative model for examining estrogen-dependent growth *in vitro*, *In Vitro Cell. Dev. Biol. – Animal*, 34, 649-654.
- (37) Li, Y. *et al.* (2014) Research resource: STR DNA profile and gene expression comparisons of human BG-1 cells and a BG-1/MCF-7 clonal variant, *Mol. Endo.* 28, 2072-2081.
- (38) Rogers, J.M. and Denison, M.S. (2000) Recombinant cell bioassays for endocrine disruptors: development of a stably transfected human ovarian cell line for the detection of estrogenic and anti-estrogenic chemicals, *In Vitro & Molec. Toxicol.* 13, 67-82.

▼M8*Appendix 1*

DEFINITIONS AND ABBREVIATIONS

Acceptability criteria: Minimum standards for the performance of experimental controls and reference standards. All acceptability criteria should be met for an experiment to be considered valid.

Accuracy (concordance): The closeness of agreement between assay results and an accepted reference values. It is a measure of assay performance and one aspect of relevance. The term is often used interchangeably with 'concordance' to mean the proportion of correct outcomes of a assay (1).

Agonist: A substance that produces a response, e.g. transcription, when it binds to a specific receptor.

Antagonist: A type of receptor ligand or chemical that does not provoke a biological response itself upon binding to a receptor, but blocks or dampens agonist-mediated responses.

Anti-estrogenic activity: the capability of a chemical to suppress the action of 17 β -estradiol mediated through estrogen receptors.

Cell morphology: The shape and appearance of cells grown in a monolayer in a single well of a tissue culture plate. Cells that are dying often exhibit abnormal cell morphology.

CF: The OECD Conceptual Framework for the Testing and Evaluation of Endocrine Disrupters.

Charcoal/dextran treatment: Treatment of serum used in cell culture. Treatment with charcoal/dextran (often referred to as 'stripping') removes endogenous hormones and hormone-binding proteins.

Chemical: A substance or a mixture.

Cytotoxicity: Harmful effects to cell structure or function that can ultimately cause cell death and can be reflected by a reduction in the number of cells present in the well at the end of the exposure period or a reduction of the capacity for a measure of cellular function when compared to the concurrent vehicle control.

CV: Coefficient of variation

DCC-FBS: Dextran-coated charcoal treated fetal bovine serum.

DMEM: Dulbecco's Modification of Eagle's Medium

DMSO: Dimethyl sulfoxide

E2: 17 β -estradiol

EC50: The half maximal effective concentration of a test chemical.

ED: Endocrine disruption

hER α : Human estrogen receptor alpha

▼ M8

hERβ: Human estrogen receptor beta

EFM: Estrogen-free medium. Dulbecco's Modification of Eagle's Medium (DMEM) supplemented with 4.5 % charcoal/dextran-treated FBS, 1,9 % L-glutamine, and 0,9 % Pen-Strep.

ER: Estrogen receptor

ERE: Estrogen response element

Estrogenic activity: The capability of a chemical to mimic 17β-estradiol in its ability to bind to and activate estrogen receptors. hERα-mediated estrogenic activity can be detected with this test method.

ERTA: Estrogen Receptor Trans Activation

FBS: Fetal bovine serum

HeLa: An immortal human cervical cell line

HeLa9903: A HeLa cell subclone into which hERα and a luciferase reporter gene have been stably transfected

IC50: The half maximal effective concentration of an inhibitory test chemical.

ICCVAM: The Interagency Coordinating Committee on the Validation of Alternative Methods.

Inter-laboratory reproducibility: A measure of the extent to which different qualified laboratories, using the same protocol and testing the same substances, can produce qualitatively and quantitatively similar results. Interlaboratory reproducibility is determined during the prevalidation and validation processes, and indicates the extent to which an assay can be successfully transferred between laboratories, also referred to as between-laboratory reproducibility (1).

Intra-laboratory reproducibility: A determination of the extent that qualified people within the same laboratory can successfully replicate results using a specific protocol at different times. Also referred to as 'within-laboratory reproducibility' (1).

LEC: Lowest effective concentration is the lowest concentration of test chemical that produces a response (i.e. the lowest test chemical concentration at which the fold induction is statistically different from the concurrent vehicle control).

Me-too test: A colloquial expression for an assay that is structurally and functionally similar to a validated and accepted reference test method. Interchangeably used with similar test method.

MT: Metallothionein

MMTV: Mouse Mammary Tumor Virus

OHT: 4-Hydroxytamoxifen

PBTG: Performance-Based Test Guideline

▼ M8

PC (Positive control): a strongly active substance, preferably 17 β -estradiol that is included in all tests to help ensure proper functioning of the assay.

PC10: the concentration of a test chemical at which the measured activity in an agonist assay is 10 % of the maximum activity induced by the PC (E2 at 1nM for the STTA assay) in each plate.

PC50: the concentration of a test chemical at which the measured activity in an agonist assay is 50 % of the maximum activity induced by the PC (E2 at the reference concentration specified in the test method) in each plate.

PCMax: the concentration of a test chemical inducing the RPCMax

Performance standards: Standards, based on a validated assay, that provide a basis for evaluating the comparability of a proposed assay that is mechanistically and functionally similar. Included are (1) essential assay components; (2) a minimum list of reference chemicals selected from among the chemicals used to demonstrate the acceptable performance of the validated test method; and (3) the comparable levels of accuracy and reliability, based on what was obtained for the validated test method, that the proposed assay should demonstrate when evaluated using the minimum list of reference chemicals (1).

Proficiency substances: A subset of the reference substances included in the Performance Standards that can be used by laboratories to demonstrate technical competence with a standardised test method. Selection criteria for these substances typically include that they represent the range of responses, are commercially available, and have high quality reference data available.

Proficiency: The demonstrated ability to properly conduct an assay prior to testing unknown substances.

Reference estrogen (Positive control, PC): 17 β -estradiol (E2, CAS 50-28-2).

Reference standard: a reference substance used to demonstrate the adequacy of an assay. 17 β -estradiol is the reference standard for the STTA and VM7Luc ER TA assays.

Reference test methods: The assays upon which PBTG 455 is based.

Relevance: Description of relationship of an assay to the effect of interest and whether it is meaningful and useful for a particular purpose. It is the extent to which the assay correctly measures or predicts the biological effect of interest. Relevance incorporates consideration of the accuracy (concordance) of an assay (1).

Reliability: Measure of the extent that an assay can be performed reproducibly within and between laboratories over time, when performed using the same protocol. It is assessed by calculating intra- and inter-laboratory reproducibility.

RLU: Relative Light Units

RNA: Ribonucleic Acid

RPCMax: maximum level of response induced by a test chemical, expressed as a percentage of the response induced by 1 nM E2 on the same plate

▼ M8

RPMI: RPMI 1640 medium supplemented with 0,9 % Pen-Strep and 8.0 % fetal bovine serum (FBS)

Run: An individual experiment that evaluates chemical action on the biological outcome of the assay. Each run is a complete experiment performed on replicate wells of cells plated from a common pool of cells at the same time.

Independent run: A separate, independent experiment that evaluates chemical action on the biological outcome of the assay, using cells from a different pool, freshly diluted chemicals, conducted on different days or on the same day by different staff.

SD: Standard deviation.

Sensitivity: The proportion of all positive/active substances that are correctly classified by the assay. It is a measure of accuracy for an assay that produces categorical results, and is an important consideration in assessing the relevance of an assay (1).

Specificity: The proportion of all negative/inactive substances that are correctly classified by the test. It is a measure of accuracy for an assay that produces categorical results, and is an important consideration in assessing the relevance of an assay (1).

Stable transfection: When DNA is transfected into cultured cells in such a way that it is stably integrated into the cells genome, resulting in the stable expression of transfected genes. Clones of stably transfected cells are selected by stable markers (e.g. resistance to G418).

STTA Assay: Stably Transfected Transactivation Assay, the ER α transcriptional activation assay using the HeLa 9903 Cell Line.

Study: The full range of experimental work performed to evaluate a single, specific substance using a specific assay. A study comprises all steps including tests of dilution of test substance in the test media, preliminary range finding runs, all necessary comprehensive runs, data analyses, quality assurance, cytotoxicity assessments, etc. Completion of a study allows the classification of the test chemical activity on the toxicity target (i.e. active, inactive or inconclusive) that is evaluated by the assay used and an estimate of potency relative to the positive reference chemical.

Substance: Under REACH (1), a substance is defined as a chemical element and its compounds in the natural state or obtained by any manufacturing process, including any additive necessary to preserve its stability and any impurities deriving from the process used, but excluding any solvent which may be separated without affecting the stability of the substance or changing its composition. A very similar definition is used in the context of the UN GHS (1).

TA (Transactivation): The initiation of mRNA synthesis in response to a specific chemical signal, such as a binding of an estrogen to the estrogen receptor

(1) Regulation (EC) No 1907/2006 of the European Parliament and of the Council of 18 December 2006 concerning the Registration, Evaluation, Authorisation and Restriction of Chemicals (Reach), establishing a European Chemicals Agency, amending Directive 1999/45/EC and repealing Council Regulation (EEC) No 793/93 and Commission Regulation (EC) No 1488/94 as well as Council Directive 76/769/EEC and Commission Directives 91/155/EEC, 93/67/EEC, 93/105/EC and 2000/21/EC (OJ L 304, 22.11.2007, p. 1).

▼M8

Assay: Within the context of this test method, an assay is one of the methodologies accepted as valid in meeting the outlined performance criteria. Components of assay include, for example, the specific cell line with associated growth conditions, specific media in which the test is conducted, plate set up conditions, arrangement and dilutions of test chemicals along with any other required quality control measures and associated data evaluation steps.

Test chemical: Any substance or mixture tested using this test method.

Transcription: mRNA synthesis

UVCB: Chemical Substances of Unknown or Variable Composition, Complex Reaction Products and Biological Materials

Validated test method: An assay for which validation studies have been completed to determine the relevance (including accuracy) and reliability for a specific purpose. It is important to note that a validated test method may not have sufficient performance in terms of accuracy and reliability to be found acceptable for the proposed purpose (1).

Validation: The process by which the reliability and relevance of a particular approach, method, assay, process or assessment is established for a defined purpose (1).

VC (Vehicle control): The solvent that is used to dissolve test and control chemicals is tested solely as vehicle without dissolved chemical.

VM7: An immortalised adenocarcinoma cell that endogenously express estrogen receptor.

VM7Luc4E2: The VM7Luc4E2 cell line was derived from VM7 immortalised human-derived adenocarcinoma cells that endogenously express both forms of the estrogen receptor (ER α and ER β) and have been stably transfected with the plasmid pGudLuc7.ERE. This plasmid contains four copies of a synthetic oligonucleotide containing the estrogen response element upstream of the mouse mammary tumor viral (MMTV) promoter and the firefly luciferase gene.

Weak positive control: A weakly active substance selected from the reference chemicals list that is included in all tests to help ensure proper functioning of the assay.

▼ **M8***Appendix 2*

STABLY TRANSFECTED HUMAN ESTROGEN RECEPTOR-A
TRANSACTIVATION ASSAY FOR DETECTION OF ESTROGENIC
AGONIST AND ANTAGONIST ACTIVITY OF CHEMICALS USING THE
HERA-HELA-9903 CELL LINE

INITIAL CONSIDERATIONS AND LIMITATIONS (SEE ALSO
GENERAL INTRODUCTION)

1. This transactivation (TA) assay uses the hER α -HeLa-9903 cell line to detect estrogenic agonist activity mediated through human estrogen receptor alpha (hER α). The validation study of the Stably Transfected Transactivation (STTA) Assay by the Japanese Chemicals Evaluation and Research Institute (CERI) using the hER α -HeLa-9903 cell line to detect estrogenic agonist and antagonist activity mediated through human estrogen receptor alpha (hER α) demonstrated the relevance and reliability of the assay for its intended purpose (1).

2. This assay is specifically designed to detect hER α -mediated TA by measuring chemiluminescence as the endpoint. However, non-receptor-mediated luminescence signals have been reported at phytoestrogen concentrations higher than 1 μ M due to the over-activation of the luciferase reporter gene (2) (3). While the dose-response curve indicates that true activation of the ER system occurs at lower concentrations, luciferase expression obtained at high concentrations of phytoestrogens or similar compounds suspected of producing phytoestrogen-like over-activation of the luciferase reporter gene needs to be examined carefully in stably transfected ER TA assay systems (Appendix 1).

3. The sections 'GENERAL INTRODUCTION' and 'ER TA ASSAY COMPONENTS' should be read before using this assay for regulatory purposes. Definitions and abbreviations used in this TG are described in Appendix 2.1.

PRINCIPLE OF THE ASSAY (SEE ALSO GENERAL INTRODUCTION)

4. The assay is used to signal binding of the estrogen receptor with a ligand. Following ligand binding, the receptor-ligand complex translocates to the nucleus where it binds specific DNA response elements and transactivates a firefly luciferase reporter gene, resulting in increased cellular expression of luciferase enzyme. Luciferin is a substrate that is transformed by the luciferase enzyme to a bioluminescence product that can be quantitatively measured with a luminometer. Luciferase activity can be evaluated quickly and inexpensively with a number of commercially available test kits.

5. The test system utilises the hER α -HeLa-9903 cell line, which is derived from a human cervical tumor, with two stably inserted constructs: (i) the hER α expression construct (encoding the full-length human receptor), and (ii) a firefly luciferase reporter construct bearing five tandem repeats of a vitellogenin Estrogen-Responsive Element (ERE) driven by a mouse metallothionein (MT) promoter TATA element. The mouse MT TATA gene construct has been shown to have the best performance, and so is commonly used. Consequently this hER α -HeLa-9903 cell line can measure the ability of a test chemical to induce hER α -mediated transactivation of luciferase gene expression.

▼M8

6. In case of ER agonist assay, data interpretation is based upon whether or not the maximum response level induced by a test chemical equals or exceeds an agonist response equal to 10 % of that induced by a maximally inducing (1 nM) concentration of the positive control (PC) 17 β -estradiol (E2) (i.e. the PC10). In case of ER antagonist assay, data interpretation is based upon whether or not the response shows at least a 30 % reduction in activity from the response induced by the spike in control (25 pM of E2) without cytotoxicity. Data analysis and interpretation are discussed in detail in paragraphs 34 - 48.

PROCEDURE**Cell Lines**

7. The stably transfected hER α -HeLa-9903 cell line should be used for the assay. The cell line can be obtained from the Japanese Collection of Research Bioresources (JCRB) Cell Bank⁽¹⁾, upon signing a Material Transfer Agreement (MTA).
8. Only cells characterised as mycoplasma-free should be used in testing. RT-PCR (Real Time Polymerase Chain Reaction) is the method of choice for a sensitive detection of mycoplasma infection (4) (5) (6).

Stability of the cell line

9. To monitor the stability of the cell line, E2, 17 α -estradiol, 17 α -methyltestosterone and corticosterone should be used as the reference standards for agonist assay and a complete concentration-response curve in the test concentration range provided in Table 1 should be measured at least once each time the assay is performed, and the results should be in agreement with the results provided in Table 1.
10. In case of antagonist assay, complete concentration curves for two reference standards, tamoxifen and flutamide, should be measured simultaneously with each run. Correct qualitative classification as positive or negative for the two chemicals should be monitored.

Cell Culture and Plating Conditions

11. Cells should be maintained in Eagle's Minimum Essential Medium (EMEM) without phenol red, supplemented with 60 mg/l of antibiotic kanamycine and 10 % dextran-coated-charcoal-treated fetal bovine serum (DCC-FBS), in a CO₂ incubator (5 % CO₂) at 37 \pm 1°C. Upon reaching 75 -90 % confluency, cells can be subcultured at 10 ml of 0,4 x 10⁵ – 1 x 10⁵ cells/ml for 100 mm cell culture dish. Cells should be suspended with 10 % FBS-EMEM (which is the same as EMEM with DCC-FBS) and then plated into wells of a microplate at a density of 1 x 10⁴ cells/(100 μ l x well). Next, the cells should be pre-incubated in a 5 % CO₂ incubator at 37 \pm 1°C for 3 hours before the chemical exposure. The plastic-ware should be free of estrogenic activity.
12. To maintain the integrity of the response, the cells should be grown for more than one passage from the frozen stock in the conditioned media and should not be cultured for more than 40 passages. For the hER α -HeLa-9903 cell line, this will be less than three months. However the performance of cells may be reduced if they are grown in inappropriate culture conditions.

⁽¹⁾ JCRB Cell Bank: National Institute of Biomedical Innovation, 7-6-8 Asagi Saito, Ibaraki-shi, Osaka 567-0085, Japan Fax: +81-72-641-9812

▼M8

13. The DCC-FBS can be prepared as described in Appendix 2.2, or obtained from commercial sources.

Acceptability criteria*Positive and negative reference standards for ER agonist assay*

14. Prior to and during the study, the responsiveness of the test system should be verified using the appropriate concentrations of a strong estrogen: E2, a weak estrogen (17 α -estradiol), a very weak agonist (17 α -methyltestosterone), and a negative substance (corticosterone). Acceptable range values derived from the validation study (1) are given in Table 1. These 4 concurrent reference standards should be included with each experiment and the results should fall within the given acceptable limits. If this is not the case, the cause for the failure to meet the acceptability criteria should be determined (e.g. cell handling, and serum and antibiotics for quality and concentration) and the assay repeated. Once the acceptability criteria have been achieved, to ensure minimum variability of EC₅₀, PC₅₀ and PC₁₀ values, consistent use of materials for cell culturing is essential. The four concurrent reference standards, which should be included in each experiment (conducted under the same conditions including the materials, passage level of cells and technicians), can ensure the sensitivity of the assay because the PC₁₀s of the three positive reference standards should fall within the acceptable range, as should the PC₅₀s and EC₅₀s where they can be calculated (see Table 1).

Table 1

Acceptable range values of the four reference standards for the ER agonist assay

Name	logPC ₅₀	logPC ₁₀	logEC ₅₀	Hill slope	Test range
17 β -estradiol (E2) CAS No: 50-28-2	-11,4~-10,1	<-11	-11,3~-10,1	0,7~1,5	10 ⁻¹⁴ ~10 ⁻⁸ M
17 α -estradiol CAS No: 57-91-0	-9,6~-8,1	-10,7~-9,3	-9,6~-8,4	0,9~2,0	10 ⁻¹² ~10 ⁻⁶ M
Corticosterone CAS No: 50-22-6	—	—	—	—	10 ⁻¹⁰ ~10 ⁻⁴ M
17 α -methyltestosterone CAS No: 58-18-4	-6,0~-5,1	-8,0~-6,2	—	—	10 ⁻¹¹ ~10 ⁻⁵ M

Positive and negative reference standards for ER antagonist assay

15. Prior to and during the study, the responsiveness of the test system should be verified using the appropriate concentrations of a positive substance (Tamoxifen), and a negative substance (Flutamide). Acceptable range values derived from the validation study (1) are given in Table 2. These two concurrent reference standards should be included with each experiment and the results should be judged correct as shown in the criteria. If this is not the case, the cause for the failure to meet the criteria should be determined (e.g. cell handling, and serum and antibiotics for quality and concentration) and the assay repeated. In addition, IC₅₀ values for a positive substance (Tamoxifen) should be calculated and the results should fall within the given acceptable limits. Once the acceptability criteria have been achieved, to ensure minimum variability of IC₅₀ values, consistent use of materials for cell culturing is essential. The two concurrent reference standards, which should be included in each experiment (conducted under the same conditions including the materials, passage level of cells and technicians), can ensure the sensitivity of the assay (see Table 2).

▼ **M8**

Table 2

Criteria and acceptable range values of the two reference standards for the ER antagonist assay

Name	Criteria	LogIC ₅₀	Test range
Tamoxifen CAS No: 10540-29-1	Positive: IC ₅₀ should be calculated	-5,942 ~ -7,596	10-10 ~ 10-5 M
Flutamide CAS No: 13311-84-7	Negative: IC ₃₀ should not be calculated	—	10-10 ~ 10-5 M

Positive and Vehicle Controls

16. The positive control (PC) for ER agonist assay (1 nM of E2) and for ER antagonist assay (10 µM TAM) should be tested at least in triplicate in each plate. The vehicle that is used to dissolve a test chemical should be tested as a vehicle control (VC) at least in triplicate in each plate. In addition to this VC, if the PC uses a different vehicle than the test chemical, another VC should be tested at least in triplicate on the same plate with the PC.

Quality criteria for ER agonist assay

17. The mean luciferase activity of the positive control (1 nM E2) should be at least 4-fold that of the mean VC on each plate. This criterion is established based on the reliability of the endpoint values from the validation study (historically between four- and 30-fold).
18. With respect to the quality control of the assay, the fold-induction corresponding to the PC₁₀ value of the concurrent PC (1 nM E2) should be greater than 1+2SD of the fold-induction value (=1) of the concurrent VC. For prioritisation purposes, the PC₁₀ value can be useful to simplify the data analysis required compared to a statistical analysis. Although a statistical analysis provides information on significance, such an analysis is not a quantitative parameter with respect to concentration-based potential, and so is less useful for prioritisation purposes.

Quality criteria for ER antagonist assay

19. The mean luciferase activity of the spike in control (25 pM E2) should be at least 4-fold that of the mean VC on each plate. This criterion is established based on the reliability of the endpoint values from the validation study.
20. With respect to the quality control of the assay, relative transcriptional activation (RTA) of 1 nM E2 should be greater than 100 %, RTA of 1 µM 4-Hydroxytamoxifen (OHT) should be less than 40,6 % and RTA of 100 µM Digitonin (Dig) should be less than 0 %.

Demonstration of Laboratory Proficiency (see paragraph 14 and Tables 3 and 4 in 'ER TA ASSAY COMPONENTS' of this test method).

Vehicle

21. Dimethyl sulfoxide (DMSO), or appropriate solvent, at the same concentration used for the different positive and negative controls and the test chemicals should be used as the concurrent VC. Test chemicals should be dissolved in a solvent that solubilises that test chemical and is miscible with the cell medium. Water, ethanol (95 % to 100 % purity) and DMSO are suitable vehicles. If DMSO is used, the level should not exceed 0,1 % (v/v). For any vehicle, it should be demonstrated that the maximum volume used is not cytotoxic and does not interfere with assay performance.

▼M8**Preparation of Test Chemicals**

22. Generally, the test chemicals should be dissolved in DMSO or other suitable solvent, and serially diluted with the same solvent at a common ratio of 1:10 in order to prepare solutions for dilution with media.

Solubility and Cytotoxicity: Considerations for Range Finding.

23. A preliminary test should be carried out to determine the appropriate concentration range of chemical to be tested, and to ascertain whether the test chemical may have any solubility and cytotoxicity problems. Initially, chemicals are tested up to the maximum concentration of 1 µl/ml, 1 mg/ml, or 1 mM, whichever is the lowest. Based on the extent of cytotoxicity or lack of solubility observed in the preliminary test, the first definite run should test the chemical at log-serial dilutions starting at the maximum acceptable concentration (e.g. 1 mM, 100µM, 10µM, etc.) and the presence of cloudiness or precipitate or cytotoxicity noted. Concentrations in the second, and if necessary third run should be adjusted as appropriate to better characterise the concentration-response curve and to avoid concentrations which are found to be insoluble or to induce excessive cytotoxicity.
24. For ER agonists and antagonists, the presence of increasing levels of cytotoxicity can significantly alter or eliminate the typical sigmoidal response and should be considered when interpreting the data. Cytotoxicity testing methods that can provide information regarding 80 % cell viability should be used, utilising an appropriate assay based upon laboratory experience.
25. Should the results of the cytotoxicity test show that the concentration of the test chemical has reduced the cell number by 20 % or more, this concentration should be regarded as cytotoxic, and the concentrations at or above the cytotoxic concentration should be excluded from the evaluation.

Chemical Exposure and Assay Plate Organisation

26. The procedure for chemical dilutions (Steps-1 and 2) and exposure to cells (Step-3) can be conducted as follows:

Step-1: Each test chemical should be serially diluted in DMSO, or appropriate solvent, and added to the wells of a microtitre plate to achieve final serial concentrations as determined by the preliminary range finding test (typically in a series of, for example 1 mM, 100 µM, 10 µM, 1µM, 100 nM, 10 nM, 1 nM, 100 pM, and 10 pM (10^{-3} - 10^{-11} M)) for triplicate testing.

Step-2: Chemical dilution: First dilute 1,5 µl of the test chemical in the solvent to a volume of 500 µl of media.

Step-3: Chemical exposure of the cells: Add 50 µl of dilution with media (prepared in Step-2) to an assay well containing 10^4 cells/100 µl/well.

The recommended final volume of media required for each well is 150 µl. Test samples and reference standards can be assigned as shown in Table 3 and Table 4.

▼M8

Table 3

Example of plate concentration assignment of the reference standards in the assay plate in ER agonist assay

Row	17 α -methyltestosterone			Corticosterone			17 α -estradiol			E2		
	1	2	3	4	5	6	7	8	9	10	11	12
A	conc 1 (10 μ M)	→	→	100 μ M	→	→	1 μ M	→	→	10 nM	→	→
B	conc 2 (1 μ M)	→	→	10 μ M	→	→	100 nM	→	→	1 nM	→	→
C	conc 3 (100 nM)	→	→	1 μ M	→	→	10 nM	→	→	100 pM	→	→
D	conc 4 (10 nM)	→	→	100 nM	→	→	1 nM	→	→	10 pM	→	→
E	conc 5 (1 nM)	→	→	10 nM	→	→	100 pM	→	→	1 pM	→	→
F	conc 6 (100 pM)	→	→	1 nM	→	→	10 pM	→	→	0,1 pM	→	→
G	conc 7 (10 pM)	→	→	100 pM	→	→	1 pM	→	→	0,01 pM	→	→
H	VC	→	→	→	→	→	PC	→	→	→	→	→

VC: Vehicle control (0.1 % DMSO); PC: Positive control (1 nM E2)

27. The reference standards (E2, 17 α -estradiol, 17 α -methyl testosterone and corticosterone) should be tested in every run (Table 3). PC wells treated with 1 nM of E2 that can produce maximum induction of E2 and VC wells treated with DMSO (or appropriate solvent) alone should be included in each test assay plate (Table 4). If cells from different sources (e.g. different passage number, different lot, etc.) are used in the same experiment, the reference standards should be tested for each cell source.

Table 4

Example of plate concentration assignment of test and plate control chemicals in the assay plate in ER agonist assay

Row	Test Chemical 1			Test Chemical 2			Test Chemical 3			Test Chemical 4		
	1	2	3	4	5	6	7	8	9	10	11	12
A	conc 1 (10 μ M)	→	→	1 mM	→	→	1 μ M	→	→	10 nM	→	→
B	conc 2 (1 μ M)	→	→	100 μ M	→	→	100 nM	→	→	1 nM	→	→
C	conc 3 (100 nM)	→	→	10 μ M	→	→	10 nM	→	→	100 pM	→	→

▼M8

Row	Test Chemical 1			Test Chemical 2			Test Chemical 3			Test Chemical 4		
	1	2	3	4	5	6	7	8	9	10	11	12
D	conc 4 (10 nM)	→	→	1 µM	→	→	1 nM	→	→	10 pM	→	→
E	conc 5 (1 nM)	→	→	100 nM	→	→	100 pM	→	→	1 pM	→	→
F	conc 6 (100 pM)	→	→	10 nM	→	→	10 pM	→	→	0,1 pM	→	→
G	conc 7 (10 pM)	→	→	1 nM	→	→	1 pM	→	→	0,01 pM	→	→
H	VC	→	→	→	→	→	PC	→	→	→	→	→

VC: Vehicle control (0.1 % DMSO); PC: Positive control (1 nM E2)

Table 5

Example of plate concentration assignment of the reference standards in the assay plate in ER antagonist assay

Row	Tamoxifen			Flutamide			Test Chemical 1			Test Chemical 2		
	1	2	3	4	5	6	7	8	9	10	11	12
A	conc 1 (10 µM)	→	→	10 µM	→	→	10 µM	→	→	10 µM	→	→
B	conc 2 (1 µM)	→	→	1 µM	→	→	1 µM	→	→	1 µM	→	→
C	conc 3 (100 nM)	→	→	100 nM	→	→	100 nM	→	→	100 nM	→	→
D	conc 4 (10 nM)	→	→	10 nM	→	→	10 nM	→	→	10 nM	→	→
E	conc 5 (1 nM)	→	→	1 nM	→	→	1 nM	→	→	1 nM	→	→
F	conc 6 (100 pM)	→	→	100 pM	→	→	100 pM	→	→	100 pM	→	→
G	0.1% DMSO	→	→	→	→	→	1 µM OHT	→	→	100 µM Dig	→	→
H	VC	→	→	→	→	→	PC	→	→	→	→	→

VC: Vehicle control (0.1% DMSO), PC: Positive control (1 nM E2), OHT :4-Hydroxytamoxifen, Dig: Digitonin.

 = spiked with 25pM E2

28. To evaluate the antagonist activity of chemicals, assay wells located in rows from A to G should be spiked with 25pM E2. The reference standards (Tamoxifen and Flutamide) should be tested in every run. PC wells treated with 1 nM of E2 that can be used as quality control of hER α -HeLa-9903 cell line, VC wells treated with DMSO (or appropriate solvent), 0,1 % DMSO wells treated with DMSO addition to the spiked E2 corresponding to 'Spike-in-control', wells treated with final concentration 1 µM OHT and wells treated with 100 µM Dig should be included in each test assay plate (Table 5). Subsequent assay plate should follow the same plate layout without reference standards wells (Table 6). If cells from different sources (e.g. different passage number, different lot, etc.) are used in the same experiment, the reference standards should be tested for each cell source.

▼ **M8**

Table 6

Example of plate concentration assignment of test and plate control chemicals in the assay plate in ER antagonist assay

Row	Test Chemical 1			Test Chemical 2			Test Chemical 3			Test Chemical 4		
	1	2	3	4	5	6	7	8	9	10	11	12
A	conc 1 (10 µM)	→	→	10 µM	→	→	10 µM	→	→	10 µM	→	→
B	conc 2 (1 µM)	→	→	1 µM	→	→	1 µM	→	→	1 µM	→	→
C	conc 3 (100 nM)	→	→	100 nM	→	→	100 nM	→	→	100 nM	→	→
D	conc 4 (10 nM)	→	→	10 nM	→	→	10 nM	→	→	10 nM	→	→
E	conc 5 (1 nM)	→	→	1 nM	→	→	1 nM	→	→	1 nM	→	→
F	conc 6 (100 pM)	→	→	100 pM	→	→	100 pM	→	→	100 pM	→	→
G	0.1% DMSO	→	→	→	→	→	1 µM OHT	→	→	100 µM Dig	→	→
H	VC	→	→	→	→	→	PC	→	→	→	→	→

VC: Vehicle control (0.1% DMSO), PC: Positive control (1 nM E2), OHT: 4-Hydroxytamoxifen, Dig: Digitonin.

 : Spiked with 25pM E2

29. The lack of edge effects should be confirmed, as appropriate, and if edge effects are suspected, the plate layout should be altered to avoid such effects. For example, a plate layout excluding the edge wells can be employed.
30. After adding the chemicals, the assay plates should be incubated in a 5 % CO₂ incubator at 37±1°C for 20-24 hours to induce the reporter gene products.
31. Special considerations will need to be applied to those compounds that are highly volatile. In such cases, nearby control wells may generate false positives and this should be considered in light of expected and historical control values. In the few cases where volatility may be of concern, the use of 'plate sealers' may help to effectively isolate individual wells during testing, and is therefore recommended in such cases.
32. Repeat definitive tests for the same chemical should be conducted on different days, to ensure independence.

Luciferase assay

33. A commercial luciferase assay reagent [e.g. Steady-Glo® Luciferase Assay System (Promega, E2510, or equivalent)] or a standard luciferase assay system (e.g. Promega, E1500, or equivalent) can be used for the assay, as long as the acceptability criteria are met. The assay reagents should be selected based on the sensitivity of the luminometer to be used. When using the standard luciferase assay system, Cell Culture Lysis Reagent (e.g. Promega, E1531, or equivalent) should be used before adding the substrate. The luciferase reagent should be applied following the manufacturers' instructions.

ANALYSIS OF DATA

ER agonist assay

34. In case of ER agonist assay, to obtain the relative transcriptional activity to PC (1 nM of E2), the luminescence signals from the same plate can be analysed according to the following steps (other equivalent mathematical processes are also acceptable):

Step 1. Calculate the mean value for the VC.

▼M8

Step 2. Subtract the mean value of the VC from each well value to normalise the data.

Step 3. Calculate the mean for the normalised PC.

Step 4. Divide the normalised value of each well in the plate by the mean value of the normalised PC (PC=100 %).

The final value of each well is the relative transcriptional activity for that well compared to the PC response.

Step 5. Calculate the mean value of the relative transcriptional activity for each concentration group of the test chemical. There are two dimensions to the response: the averaged transcriptional activity (response) and the concentration at which the response occurs (see following section).

EC₅₀, PC₅₀ and PC₁₀ induction considerations

35. The full concentration-response curve is required for the calculation of the EC₅₀, but this may not always be achievable or practical due to limitations of the test concentration range (for example due to cytotoxicity or solubility problems). However, as the EC₅₀ and maximum induction level (corresponding to the top value of the Hill-equation) are informative parameters, these parameters should be reported where possible. For the calculation of EC₅₀ and maximum induction level, appropriate statistical software should be used (e.g. Graphpad Prism statistical software). If the Hill's logistic equation is applicable to the concentration response data, the EC₅₀ should be calculated by the following equation (7):

$$Y = \text{Bottom} + (\text{Top} - \text{Bottom}) / (1 + 10^{\exp((\log \text{EC}_{50} - X) \times \text{Hill slope})})$$

Where:

X is the logarithm of concentration; and,

Y is the response and Y starts at the Bottom and goes to the Top in a sigmoid curve. Bottom is fixed at zero in the Hill's logistic equation.

36. For each test chemical, the following should be provided:

The RPCMax which is the maximum level of response induced by a test chemical, expressed as a percentage of the response induced by 1 nM E2 on the same plate, as well as the PC_{Max} (concentration associated with the RPCMax); and

For positive chemicals, the concentrations that induce the PC₁₀ and, if appropriate, the PC₅₀.

37. The PC_x value can be calculated by interpolating between 2 points on the X-Y coordinate, one immediately above and one immediately below a PC_x value. Where the data points lying immediately above and below the PC_x value have the coordinates (a,b) and (c,d) respectively, then the PC_x value may be calculated using the following equation:

$$\log[\text{PC}_x] = \log[c] + (x-d)/(d-b)$$

▼ M8

38. Descriptions of PC values are provided in Figure 1 below.

Figure 1

Example of how to derive PC-values. The PC (1 nM of E2) is included on each assay plate

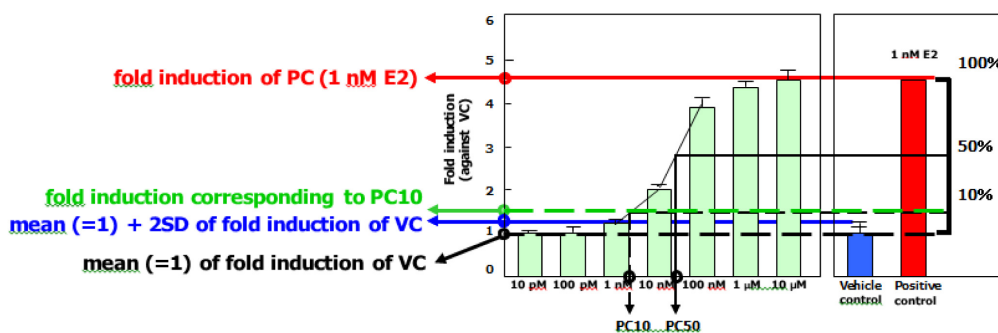

ER antagonist assay

39. In case of ER antagonist assay, to obtain the relative transcriptional activity (RTA) to spike in control (25 pM of E2), the luminescence signals from the same plate can be analysed according to the following steps (other equivalent mathematical processes are also acceptable):

Step 1. Calculate the mean value for the VC.

Step 2. Subtract the mean value of the VC from each well value to normalise the data. Step 3. Calculate the mean for the normalised spike in control.

Step 4. Divide the normalised value of each well in the plate by the mean value of the normalised spike in control (spike in control=100 %).

The final value of each well is the relative transcriptional activity for that well compared to the spike in control response.

Step 5. Calculate the mean value of the relative transcriptional activity for each treatment.

IC₃₀ and IC₅₀ induction considerations

40. For positive chemicals, the concentrations that induce the IC₃₀ and, if appropriate, the IC₅₀ should be provided.

41. The IC_x value can be calculated by interpolating between 2 points on the X-Y coordinate, one immediately above and one immediately below a IC_x value. Where the data points lying immediately above and below the IC_x value have the coordinates (c,d) and (a,b) respectively, then the IC_x value may be calculated using the following equation:

$$\ln IC_x = a - (b - (100 - x)) \cdot (a - c) / (b - d)$$

▼ **M8**

Figure 2

Example of how to derive IC-values. The spike in control (25 pM of E2) is included on each assay plate

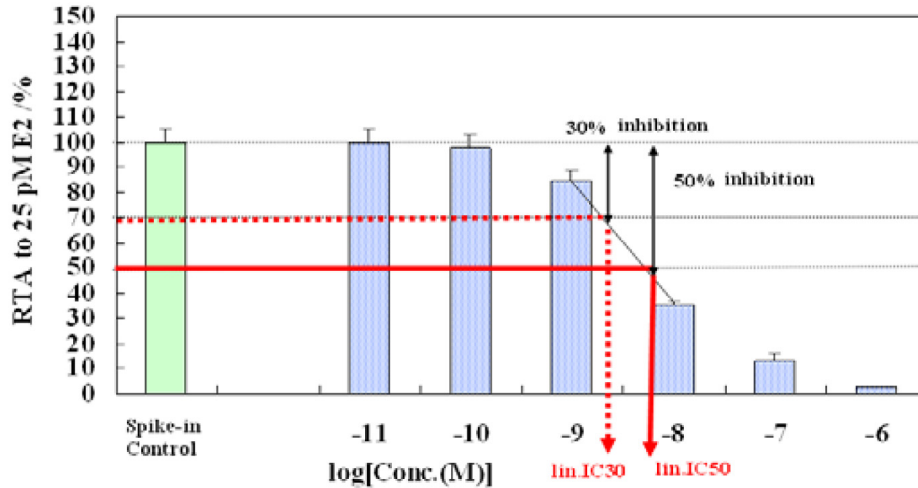

RTA: relative transcriptional activity

42. The results should be based on two (or three) independent runs. If two runs give comparable and therefore reproducible results, it is not necessary to conduct a third run. To be acceptable, the results should:

- Meet the acceptability criteria (see Acceptability criteria para 14-20),
- Be reproducible.

Data Interpretation Criteria

Table 7

Positive and negative decision criteria in ER agonist assay

Positive	If the RPCMax is obtained that is equal to or exceeds 10 % of the response of the positive control in at least two of two or two of three runs.
Negative	If the RPCMax fails to achieve at least 10 % of the response of the positive control in two of two or two of three runs.

Table 8

Positive and negative decision criteria in ER antagonist assay

Positive	If the IC30 is calculated in at least two of two or two of three runs.
Negative	If the IC30 fails to calculate in two of two or two of three runs.

▼M8

43. Data interpretation criteria are shown in Tables 7 and 8. Positive results will be characterised by both the magnitude of the effect and the concentration at which the effect occurs. Expressing results as a concentration at which a 50 % (PC50) or 10 % (PC10) of PC values are reached for the agonist assay, and 50 % (IC50) or 30 % (IC30) of the spike-in control value is inhibited for the antagonist assay, accomplishes both of these goals. However, a test chemical is determined to be positive, if the maximum response induced by the test chemical (RPCMax) is equal to or exceeds 10 % of the response of the PC in at least two of two or two of three runs, while a test chemical is considered negative if the RPCMax fails to achieve at least 10 % of the response of the positive control in two of two or two of three runs.
44. The calculations of PC10, PC50 and PCMax in ER agonist assay and IC30 and IC50 in ER antagonist assay can be made by using a spreadsheet available with the Test Guideline on the OECD public website ⁽¹⁾.
45. It should be sufficient to obtain PC10 or PC50 and IC30 or IC50 values at least twice. However, should the resulting base-line for data in the same concentration range show variability with an unacceptably high coefficient of variation (CV; %) the data may not be considered reliable and the source of the high variability should be identified. The CV of the raw data triplicates (i.e. luminescence intensity data) of the data points that are used for the calculation of PC10 should be less than 20 %.
46. Meeting the acceptability criteria indicates the assay system is operating properly, but it does not ensure that any particular run will produce accurate data. Duplicating the results of the first run is the best insurance that accurate data were produced.
47. In case of ER agonist assay, where more information is required in addition to the screening and prioritisation purposes of this TG for positive test chemicals, particularly for PC10-PC49 chemicals, as well as chemicals suspected to over-stimulate luciferase, it can be confirmed that the observed luciferase-activity is solely an ER α -specific response, using an ER α antagonist (see Appendix 2.1).

TEST REPORT

48. See paragraph 20 of 'ER TA ASSAY COMPONENTS'.

LITERATURE

- (1) OECD (2015). Report of the Inter-Laboratory Validation for Stably Transfected Transactivation Assay to detect Estrogenic and Anti-estrogenic Activity. Environment, Health and Safety Publications, Series on Testing and Assessment (No 225), Organisation for Economic Cooperation and Development, Paris.
- (2) Escande A., *et al.* (2006). Evaluation of Ligand Selectivity Using Reporter Cell Lines Stably Expressing Estrogen Receptor Alpha or Beta, *Biochem. Pharmacol.*, 71, 1459-1469.
- (3) Kuiper G.G., *et al.* (1998). Interaction of Estrogenic Chemicals and Phytoestrogens with Estrogen Receptor Beta, *Endocrinol.*, 139, 4252-4263.

⁽¹⁾ <http://www.oecd.org/env/testguidelines>

▼M8

- (4) Spaepen M., *et al.* (1992). Detection of Bacterial and Mycoplasma Contamination in Cell Cultures by Polymerase Chain Reaction, *FEMS Microbiol. Lett.*, 78(1), 89-94.
- (5) Kobayashi H., *et al.* (1995). Rapid Detection of Mycoplasma Contamination in Cell Cultures by Enzymatic Detection of Polymerase Chain Reaction (PCR) Products, *J. Vet. Med. Sci.*, 57(4), 769- 71.
- (6) Dussurget O. and Roulland-Dussoix D. (1994). Rapid, Sensitive PCR-Based Detection of Mycoplasmas in Simulated Samples of Animal Sera, *Appl. Environ. Microbiol.*, 60(3), 953-9.
- (7) De Lean A., Munson P.J. and Rodbard D. (1978). Simultaneous Analysis of Families of Sigmoidal Curves: Application to Bioassay, Radioligand Assay, and Physiological Dose-Response Curves, *Am. J. Physiol.*, 235, E97-E102.

▼M8*Appendix 2.1***FALSE POSITIVES: ASSESSMENT OF NON-RECEPTOR MEDIATED LUMINESCENCE SIGNALS**

1. False positives in the ER agonist assay might be generated by non-ER-mediated activation of the luciferase gene, or direct activation of the gene product or unrelated fluorescence. Such effects are indicated by an incomplete or unusual dose-response curve. If such effects are suspected, the effect of an ER antagonist (e.g. 4-hydroxytamoxifen (OHT) at non-toxic concentration) on the response should be examined. The pure antagonist ICI 182780 may not be suitable for this purpose as a sufficient concentration of ICI 182780 may decrease the VC value, and this will affect the data analysis.
2. To ensure validity of this approach, the following needs to be tested in the same plate:
 - Agonistic activity of the unknown chemical with / without 10 µM of OHT
 - VC (in triplicate)
 - OHT (in triplicate)
 - 1 nM of E2 (in triplicate) as agonist PC
 - 1 nM of E2 + OHT (in triplicate)

Data interpretation criteria

Note: All wells should be treated with the same concentration of the vehicle.

- If the agonistic activity of the unknown chemical is NOT affected by the treatment with ER antagonist, it is classified as 'Negative'.
- If the agonistic activity of the unknown chemical is completely inhibited, apply the decision criteria.
- If the agonistic activity at the lowest concentration is equal to, or is exceeding, PC10 response the unknown chemical is inhibited equal to or exceeding PC10 response. The difference in the responses between the non-treated and treated wells with the ER antagonist is calculated and this difference should be considered as the true response and should be used for the calculation of the appropriate parameters to enable a classification decision to be made.

Data analysis

Check the performance standard.

Check the CV between wells treated under the same conditions.

1. Calculate the mean of the VC
2. Subtract the mean of VC from each well value **not** treated with OHT
3. Calculate the mean of OHT
4. Subtract the mean of the VC from each well value treated with OHT
5. Calculate the mean of the PC
6. Calculate the relative transcriptional activity of all other wells relative to the PC.

▼M8*Appendix 2.2***PREPARATION OF SERUM TREATED WITH DEXTRAN COATED CHARCOAL (DCC)**

1. The treatment of serum with dextran-coated charcoal (DCC) is a general method for removal of estrogenic compounds from serum that is added to cell medium, in order to exclude the biased response associated with residual estrogens in serum. 500 ml of fetal bovine serum (FBS) can be treated by this procedure.

Components

2. The following materials and equipment will be required:

Materials

Activated charcoal

Dextran

Magnesium chloride hexahydrate (MgCl₂·6H₂O)

Sucrose

1 M HEPES buffer solution (pH 7.4)

Ultrapure water produced from a filter system

Equipment

Autoclaved glass container (size should be adjusted as appropriate) General Laboratory Centrifuge (that can set temperature at 4 °C)

Procedure

3. The following procedure is adjusted for the use of 50 ml centrifuge tubes:

[Day-1] Prepare dextran-coated charcoal suspension with 1 l of ultrapure water containing 1,5 mM of MgCl₂, 0,25 M sucrose, 2,5 g of charcoal, 0,25 g dextran and 5 mM of HEPES and stir it at 4 °C, overnight.

[Day-2] Dispense the suspension in 50 ml centrifuge tubes and centrifuge at 10 000 rpm at 4 °C for 10 minutes. Remove the supernatant and store half of the charcoal sediment at 4 °C for the use on Day-3. Suspend the other half of the charcoal with FBS that has been gently thawed to avoid precipitation, and heat-inactivated at 56 °C for 30 minutes, then transfer into an autoclaved glass container such as an Erlenmeyer flask. Stir this suspension gently at 4 °C, overnight.

[Day-3] Dispense the suspension with FBS into centrifuge tubes for centrifugation at 10 000 rpm at 4 °C for 10 minutes. Collect FBS and transfer into the new charcoal sediment prepared and stored on Day-2. Suspend the charcoal sediment and stir this suspension gently in an autoclaved glass container at 4 °C, overnight.

[Day-4] Dispense the suspension for centrifugation at 10 000 rpm at 4 °C for 10 minutes and sterilise the supernatant by filtration through 0,2 µm sterile filter. This DCC treated FBS should be stored at -20 °C and can be used for up a year.

▼ **M8***Appendix 3***VM7LUC ESTROGEN RECEPTOR TRANSACTIVATION ASSAY FOR IDENTIFYING ESTROGEN RECEPTOR AGONISTS AND ANTAGONISTS****INITIAL CONSIDERATIONS AND LIMITATIONS (SEE ALSO GENERAL INTRODUCTION)**

1. This assay uses the VM7Luc4E2 cell line⁽¹⁾. It has been validated by the National Toxicology Program Interagency Center for the Evaluation of Alternative Toxicological Methods (NICEATM), and the Interagency Coordinating Committee on the Validation of Alternative Methods (ICCVAM) (1). The VM7Luc cell lines predominantly express endogenous ER α and a minor amount of endogenous ER β (2) (3) (4).
2. This assay is applicable to a wide range of substances, provided they can be dissolved in dimethyl sulfoxide (DMSO; CASRN 67-68-5), do not react with DMSO or the cell culture medium, and are not cytotoxic at the concentrations being tested. If use of DMSO is not possible, another vehicle such as ethanol or water may be used (see paragraph 12). The demonstrated performance of the VM7Luc ER TA (ant)agonist assay suggests that data generated with this assay may inform upon ER mediated mechanisms of action and could be considered for prioritisation of substances for further testing.
3. This assay is specifically designed to detect hER and hER β -mediated TA by measuring chemiluminescence as the endpoint. Chemiluminescence use in bioassays is widespread because luminescence has a high signal-to-background ratio (10). However, the activity of firefly luciferase in cell-based assays can be confounded by substances that inhibit the luciferase enzyme, causing both apparent inhibition or increased luminescence due to protein stabilisation (10). In addition, in some luciferase-based ER reporter gene assays, non-receptor-mediated luminescence signals have been reported at phytoestrogen concentrations higher than 1 μ M due to the over-activation of the luciferase reporter gene (9) (11). While the dose-response curve indicates that true activation of the ER system occurs at lower concentrations, luciferase expression obtained at high concentrations of phytoestrogens or similar compounds suspected of producing phytoestrogen-like over-activation of the luciferase reporter gene needs to be examined carefully in stably transfected ER TA assay systems (see Appendix 2).
4. The ‘GENERAL INTRODUCTION’ and ‘ER TA ASSAY COMPONENTS’ should be read before using this assay for regulatory purposes. Definitions and abbreviations used in this test method are described in Appendix 1.

⁽¹⁾ Before June 2016, this cell line was designated as BG1Luc cell line. BG-1 cells were originally described by Geisinger et al. (1998) (12) and were later characterized by researchers at the National Institute of Environmental Health Sciences (NIEHS) (13). Relatively recently, it was discovered that there exist two different variants of BG-1 cells being used by researchers, BG-1 Fr and BG-1 NIEHS. In-depth analysis, including DNA testing, of these two BG-1 variant cell lines carried out by Li and coworkers (2014) (14) showed that the BG-1 Fr was unique and that the BG-1 NIEHS, i.e. the original cell line used to develop the assay, was not the BG1 human ovarian carcinoma cell line, but was instead a variant of the MCF7 human breast cancer cell line. The cell line used in the assay, originally referred to as BG1Luc4E2 (15), will now be designated as VM7Luc4E2 (‘V’ = variant; ‘M7’ = MCF7 cells). Likewise, the assay will now be designated as the VM7Luc ER TA. While this changes the origin of the cell line upon which the assay is based, it does not affect published validation studies nor the utility and application of this assay for screening of estrogenic/anti-estrogenic chemicals.

▼M8

PRINCIPLE OF THE ASSAY (SEE ALSO GENERAL INTRODUCTION)

5. The assay is used to indicate ER ligand binding, followed by translocation of the receptor-ligand complex to the nucleus. In the nucleus, the receptor-ligand complex binds to specific DNA response elements and transactivates the reporter gene (*luc*), resulting in the production of luciferase and the subsequent emission of light, which can be quantified using a luminometer. Luciferase activity can be quickly and inexpensively evaluated with a number of commercially available kits. The VM7Luc ER TA utilises an ER responsive human breast adenocarcinoma cell line, VM7, which has been stably transfected with a firefly *luc* reporter construct under control of four estrogenresponse elements placed upstream of the mouse mammary tumour virus promoter (MMTV), to detect substances with *in vitro* ER agonist or antagonist activity. This MMTV promoter exhibits only minor cross-reactivity with other steroid and non-steroid hormones (8). Criteria for data interpretation are described in detail in paragraph 41. Briefly, a positive response is identified by a concentration-response curve containing at least three points with non-overlapping error bars (mean \pm SD), as well as a change in amplitude (normalised relative light unit [RLU]) of at least 20 % of the maximal value for the reference standard (17-estradiol [E2; CASRN 50-28-2] for the agonist assay, raloxifene HCl [Ral; CASRN 84449-90-1]/E2 for the antagonist assay).

PROCEDURE

Cell Line

6. The stably transfected VM7Luc4E2 cell line should be used for the assay. The cell line is currently only available with a technical licensing agreement from the University of California, Davis, California, USA (1), and from Xenobiotic Detection Systems Inc., Durham, North Carolina, USA (2).

Stability of the Cell Line

7. To maintain the stability and integrity of the cell line, the cells should be grown for more than one passage from the frozen stock in cell maintenance media (see paragraph 9). Cells should not be cultured for more than 30 passages. For the VM7Luc4E2 cell line, 30 passages will be approximately three months.

Cell Culture and Plating Conditions

8. Procedures specified in the Guidance on Good Cell Culture Practice (5) (6) should be followed to assure the quality of all materials and methods in order to maintain the integrity, validity, and reproducibility of any work conducted.
9. VM7Luc4E2 cells are maintained in RPMI 1640 medium supplemented with 0,9 % Pen-Strep and 8,0 % fetal bovine serum (FBS) in a dedicated tissue culture incubator at 37°C \pm 1°C, 90 % \pm 5 % humidity, and 5,0 % \pm 1 % CO₂/air.
10. Upon reaching ~80 % confluence, VM7Luc4E2 cells are subcultured and conditioned to an estrogen-free environment for 48 hours prior to plating the cells in 96-well plates for exposure to test chemicals and analysis of estrogen dependent induction of luciferase activity. The estrogen-free

(1) Michael S. Denison, Ph.D. Professor, Dept. of Environmental Toxicology, 4241 Meyer Hall, One Shields Ave, University of California, Davis, CA 95616, E: msdenison@ucdavis.edu, (530) 754-8649

(2) Xenobiotic Detection Systems Inc. 1601 East Geer Street, Suite S, Durham NC, 27704 USA, email: info@dioxins.com, Telephone: 919-688-4804, Fax: 919-688-4404

▼M8

medium (EFM) contains Dulbecco's Modification of Eagle's Medium (DMEM) without phenol red, supplemented with 4.5 % charcoal/dextran-treated FBS, 1,9 % L-glutamine, and 0,9 % Pen-Strep. All plasticware should be free of estrogenic activity [see detailed protocol (7)].

Acceptability Criteria

11. Acceptance or rejection of a test is based on the evaluation of reference standard and control results from each experiment conducted on a 96-well plate. Each reference standard is tested in multiple concentrations and there are multiple samples of each reference and control concentration. Results are compared to quality controls (QC) for these parameters that were derived from the agonist and antagonist historical databases generated by each laboratory during the demonstration of proficiency. The historical databases are updated with reference standard and control values on a continuous basis. Changes in equipment or laboratory conditions may necessitate generation of updated historical databases.

Agonist Test

Range Finder Test

- Induction: Plate induction should be measured by dividing the average highest E2 reference standard relative light unit (RLU) value by the average DMSO control RLU value. Five-fold induction is usually achieved, but for purpose of acceptance, induction should be greater than or equal to four-fold.
- DMSO control results: Solvent control RLU values should be within 2.5 times the standard deviation of the historical solvent control mean RLU value.
- An experiment that fails either acceptance criterion should be discarded and repeated.

Comprehensive Test

It includes acceptability criteria from the agonist range finder test and the following:

- Reference standard results: The E2 reference standard concentration-response curve should be sigmoidal in shape and have at least three values within the linear portion of the concentration-response curve.
- Positive control results: Methoxychlor control RLU values should be greater than the DMSO mean plus three times the standard deviation from the DMSO mean.
- An experiment that fails any single acceptance criterion should be discarded and repeated.

Antagonist Test

Range Finder Test

- Reduction: Plate reduction is measured by dividing the average highest Ral/E2 reference standard RLU value by the average DMSO control RLU value. Five-fold reduction is usually achieved, but for the purposes of acceptance, reduction should be greater than or equal to three-fold.
- E2 control results: E2 control RLU values should be within 2.5 times the standard deviation of the historical E2 control mean RLU value.

▼ M8

- DMSO control results: DMSO control RLU values should be within 2.5 times the standard deviation of the historical solvent control mean RLU value.
- An experiment that fails any single acceptance criterion will be discarded and repeated.

Comprehensive Test

It includes acceptance criteria from the antagonist range finder test and the following:

- Reference standard results: The Ral/E2 reference standard concentration-response curve should be sigmoidal in shape and have at least three values within the linear portion of the concentration-response curve.
- Positive control results: Tamoxifen/E2 control RLU values should be less than the E2 control mean minus three times the standard deviation from the E2 control mean.
- An experiment that fails any single acceptance criterion will be discarded and repeated.

Reference Standards, Positive, and Vehicle Controls*Vehicle Control (Agonist and Antagonist Assays)*

12. The vehicle that is used to dissolve the test chemicals should be tested as a vehicle control. The vehicle used during the validation of the VM7Luc ER TA assay was 1 % (v/v) dimethylsulfoxide (DMSO, CASRN 67-68-5) (see paragraph 24). If a vehicle other than DMSO is used, all reference standards, controls, and test chemicals should be tested in the same vehicle, if appropriate.

Reference Standard (Agonist Range Finder)

13. The reference standard is E2 (CASRN 50-28-2). For range finder testing, the reference standard is comprised of a serial dilution of four concentrations of E2 (1.84×10^{-10} , 4.59×10^{-11} , 1.15×10^{-11} and 2.87×10^{-12} M), with each concentration tested in duplicate wells.

Reference Standard (Agonist Comprehensive)

14. E2 for comprehensive testing is comprised of a 1:2 serial dilution consisting of 11 concentrations (ranging from 3.67×10^{-10} to 3.59×10^{-13} M) of E2 in duplicate wells.

Reference Standard (Antagonist Range Finder)

15. The reference standard is a combination of Ral (CASRN 84449-90-1) and E2 (CASRN 50-28-2). Ral/E2 for range finder testing is comprised of a serial dilution of three concentrations of Ral (3.06×10^{-9} , 7.67×10^{-10} , and 1.92×10^{-10} M) plus a fixed concentration (9.18×10^{-11} M) of E2 in duplicate wells.

Reference Standard (Antagonist Comprehensive)

16. Ral/E2 for comprehensive testing is comprised of a 1:2 serial dilution of Ral (ranging from 2.45×10^{-8} to 9.57×10^{-11} M) plus a fixed concentration (9.18×10^{-11} M) of E2 consisting of nine concentrations of Ral/E2 in duplicate wells.

Weak Positive Control (Agonist)

17. The weak positive control is 9.06×10^{-6} M *p,p'*-methoxychlor (methoxychlor; CASRN 72-43-5) in EFM.

▼M8*Weak Positive Control (Antagonist)*

18. The weak positive control consists of tamoxifen (CASRN 10540-29-1) 3,36 10^{-6} M with $9,18 \times 10^{-11}$ M E2 in EFM.

E2 Control (Antagonist Assay Only)

19. The E2 control is $9,18 \times 10^{-11}$ M E2 in EFM and used as a base line negative control.

Fold-Induction (Agonist)

20. The induction of luciferase activity of the reference standard (E2) is measured by dividing the average highest E2 reference standard RLU value by the average DMSO control RLU value, and the result should be greater than four-fold.

Fold-Reduction (Antagonist)

21. The mean luciferase activity of the reference standard (Ral/E2) is measured by dividing the average highest Ral/E2 reference standard RLU value by the average DMSO control RLU value and should be greater than three-fold.

Demonstration of Laboratory Proficiency (see paragraph 14 and Tables 3 and 4 in 'ER TA ASSAY COMPONENTS' of this test method)

Vehicle

22. Test chemicals should be dissolved in a solvent that solubilises the test chemical and is miscible with the cell medium. Water, ethanol (95 % to 100 % purity) and DMSO are suitable vehicles. If DMSO is used, the level should not exceed 1 % (v/v). For any vehicle, it should be demonstrated that the maximum volume used is not cytotoxic and does not interfere with the assay performance. Reference standards and controls are dissolved in 100 % solvent and then diluted down to appropriate concentrations in EFM.

Preparation of Test chemicals

23. The test chemicals are dissolved in 100 % DMSO (or appropriate solvent), and then diluted down to appropriate concentrations in EFM. All test chemicals should be allowed to equilibrate to room temperature before being dissolved and diluted. Test chemical solutions should be prepared fresh for each experiment. Solutions should not have noticeable precipitate or cloudiness. Reference standard and control stocks may be prepared in bulk; however, final reference standard, control dilutions and test chemicals should be freshly prepared for each experiment and used within 24 hours of preparation.

Solubility and Cytotoxicity: Considerations for Range Finding

24. Range finder testing consists of seven point - 1:10 serial dilutions run in duplicate. Initially, test chemicals are tested up to the maximum concentration of 1 mg/ml (~1 mM) for agonist testing and 20 µg/ml (~10 M) for antagonist testing. Range finder experiments are used to determine the following:

- Test chemical starting concentrations to be used during comprehensive testing
- Test chemical dilutions (1:2 or 1:5) to be used during comprehensive testing

▼ **M8**

25. An assessment of cell viability/cytotoxicity is included in the agonist and antagonist assay protocols (7) and is incorporated into range finder and comprehensive testing. The cytotoxicity method that was used to assess cell viability during the validation of the VM7Luc ER TA (1) was a scaled qualitative visual observation method; however, a quantitative method for the determination of cytotoxicity can be used (see protocol (7)). Data from test chemical concentrations that cause more than 20 % reduction in viability cannot be used.

Test chemical Exposure and Assay Plate Organisation

26. Cells are counted and plated into 96-well tissue culture plates (2×10^5 cells per well) in EFM and incubated for 24 hours to allow the cells to attach to the plate. The EFM is removed and replaced with test and reference chemicals in EFM and incubated for 19-24 hours. Special considerations will need to be applied to those substances that are highly volatile since nearby control wells may generate false positive results. In such cases, 'plate sealers' may help to effectively isolate individual wells during testing, and are therefore recommended.

Range Finder Tests

27. Range finder testing uses all wells of the 96-well plate to test up to six test chemicals as seven point 1:10 serial dilutions in duplicate (see Figures 1 and 2).

— *Agonist* range finder testing uses four concentrations of E2 in duplicate as the reference standard and four replicate wells for the DMSO control.

— *Antagonist* range finder testing uses three concentrations of Ral/E2 with $9,18 \times 10^{-11}$ M E2 in duplicate as the reference standard, with three replicate wells for the E2 and DMSO controls.

*Figure 1***Agonist Range Finder Test 96-well Plate Layout**

	1	2	3	4	5	6	7	8	9	10	11	12
A	TC1-1	TC1-1	TC2-1	TC2-1	TC3-1	TC3-1	TC4-1	TC4-1	TC5-1	TC5-1	TC6-1	TC6-1
B	TC1-2	TC1-2	TC2-2	TC2-2	TC3-2	TC3-2	TC4-2	TC4-2	TC5-2	TC5-2	TC6-2	TC6-2
C	TC1-3	TC1-3	TC2-3	TC2-3	TC3-3	TC3-3	TC4-3	TC4-3	TC5-3	TC5-3	TC6-3	TC6-3
D	TC1-4	TC1-4	TC2-4	TC2-4	TC3-4	TC3-4	TC4-4	TC4-4	TC5-4	TC5-4	TC6-4	TC6-4
E	TC1-5	TC1-5	TC2-5	TC2-5	TC3-5	TC3-5	TC4-5	TC4-5	TC5-5	TC5-5	TC6-5	TC6-5
F	TC1-6	TC1-6	TC2-6	TC2-6	TC3-6	TC3-6	TC4-6	TC4-6	TC5-6	TC5-6	TC6-6	TC6-6
G	TC1-7	TC1-7	TC2-7	TC2-7	TC3-7	TC3-7	TC4-7	TC4-7	TC5-7	TC5-7	TC6-7	TC6-7
H	E2-1	E2-2	E2-3	E2-4	VC	VC	VC	VC	E2-1	E2-2	E2-3	E2-4

Abbreviations: E2-1 to E2-4 = concentrations of the E2 reference standard (from high to low); TC1-1 to TC1-7 = concentrations (from high to low) of test chemical 1 (TC1); TC2-1 to TC2-7 = concentrations (from high to low) of test chemical 2 (TC2); TC3-1 to TC3-7 = concentrations (from high to low) of test chemical 3 (TC3); TC4-1 to TC4-7 = concentrations (from high to low) of test chemical 4 (TC4); TC5-1 to TC5-7 = concentrations (from high to low) of test chemical 5 (TC5); TC6-1 to TC6-7 = concentrations (from high to low) of test chemical 6 (TC6); VC = vehicle control (DMSO [1 % v/v EFM]).

▼M8

Figure 2

Antagonist Range Finder Test 96-well Plate Layout

	1	2	3	4	5	6	7	8	9	10	11	12
A	TC1-1	TC1-1	TC2-1	TC2-1	TC3-1	TC3-1	TC4-1	TC4-1	TC5-1	TC5-1	TC6-1	TC6-1
B	TC1-2	TC1-2	TC2-2	TC2-2	TC3-2	TC3-2	TC4-2	TC4-2	TC5-2	TC5-2	TC6-2	TC6-2
C	TC1-3	TC1-3	TC2-3	TC2-3	TC3-3	TC3-3	TC4-3	TC4-3	TC5-3	TC5-3	TC6-3	TC6-3
D	TC1-4	TC1-4	TC2-4	TC2-4	TC3-4	TC3-4	TC4-4	TC4-4	TC5-4	TC5-4	TC6-4	TC6-4
E	TC1-5	TC1-5	TC2-5	TC2-5	TC3-5	TC3-5	TC4-5	TC4-5	TC5-5	TC5-5	TC6-5	TC6-5
F	TC1-6	TC1-6	TC2-6	TC2-6	TC3-6	TC3-6	TC4-6	TC4-6	TC5-6	TC5-6	TC6-6	TC6-6
G	TC1-7	TC1-7	TC2-7	TC2-7	TC3-7	TC3-7	TC4-7	TC4-7	TC5-7	TC5-7	TC6-7	TC6-7
H	Ral-1	Ral-2	Ral-3	VC	VC	VC	E2	E2	E2	Ral-1	Ral-2	Ral-3

Abbreviations: E2 = E2 control; Ral-1 to Ral-3 = concentrations of the Raloxifene/E2 reference standard (from high to low); TC1-1 to TC1-7 = concentrations (from high to low) of test chemical 1 (TC1); TC2-1 to TC2-7 = concentrations (from high to low) of test chemical 2 (TC2); TC3-1 to TC3-7 = concentrations (from high to low) of test chemical 3 (TC3); TC4-1 to TC4-7 = concentrations (from high to low) of test chemical 4 (TC4); TC5-1 to TC5-7 = concentrations (from high to low) of test chemical 5 (TC5); TC6-1 to TC6-7 = concentrations (from high to low) of test chemical 6 (TC6); VC = vehicle control (DMSO [1 % v/v EFM.]).

Note: All test chemicals are tested in the presence of $9,18 \times 10^{-11}$ M E2.

28. The recommended final volume of media required for each well is 200 μ l. Only use test plates in which the cells in all wells give a viability of 80 % and above.
29. Determination of starting concentrations for comprehensive *agonist* testing is described in depth in the agonist protocol (7). Briefly, the following criteria are used:
- If there are no points on the test chemical concentration curve that are greater than the mean plus three times the standard deviation of the DMSO control, comprehensive testing will be conducted using an 11-point 1:2 serial dilution starting at the maximum soluble concentration.
 - If there are points on the test chemical concentration curve that are greater than the mean plus three times the standard deviation of the DMSO control, the starting concentration to be used for the 11-point dilution scheme in comprehensive testing should be one log higher than the concentration giving the highest adjusted RLU value in the range finder. The 11-point dilution scheme will be based on either 1:2 or 1:5 dilutions according to the following criteria:

An 11-point 1:2 serial dilution should be used if the resulting concentration range will encompass the full range of responses based on the concentration response curve generated in the range finder test. Otherwise, use a 1:5 dilution.

▼M8

- If a test chemical exhibits a biphasic concentration response curve in the range finder test, both phases should also be resolved in comprehensive testing.
30. Determination of starting concentrations for comprehensive *antagonist* testing is described in depth in the antagonist protocol (7). Briefly, the following criteria are used:

- If there are no points on the test chemical concentration curve that are less than the mean minus three times the standard deviation of the E2 control, comprehensive testing will be conducted using an 11-point 1:2 serial dilution starting at the maximum soluble concentration.
- If there are points on the test chemical concentration curve that are less than the mean minus three times the standard deviation of the E2 control, the starting concentration to be used for the 11-point dilution scheme in comprehensive testing should be one of the following:
 - The concentration giving the lowest adjusted RLU value in the range finder
 - The maximum soluble concentration (See antagonist protocol (7), Figure 14-2)
 - The lowest cytotoxic concentration (See antagonist protocol (7), Figure 14-3 for a related example).
- The 11-point dilution scheme will be based on either a 1:2 or 1:5 serial or dilution according to the following criteria:

An 11-point 1:2 serial dilution should be used if the resulting concentration range will encompass the full range of responses based on the concentration response curve generated in the range finder test. Otherwise a 1:5 dilution should be used.

Comprehensive Tests

31. Comprehensive testing consists of 11-point serial dilutions (either 1:2 or 1:5 serial dilutions based on the starting concentration for comprehensive testing criteria) with each concentration tested in triplicate wells of the 96-well plate (see Figures 3 and 4).
- *Agonist* comprehensive testing uses 11 concentrations of E2 in duplicate as the reference standard. Four replicate wells for the DMSO control and four replicate wells for the methoxychlor control (9.06×10^{-6} M) are included on each plate.
 - *Antagonist* comprehensive testing uses nine concentrations of Ral/E2 with 9.18×10^{-11} M E2 in duplicate as the reference standard, with four replicate wells for the E2 9.18×10^{-11} M control, four replicate wells for DMSO controls, and four replicate wells for tamoxifen 3.36×10^{-6} M.

▼M8

Figure 3

Agonist Comprehensive Test 96-well Plate Layout

	1	2	3	4	5	6	7	8	9	10	11	12
A	TC1-1	TC1-2	TC1-3	TC1-4	TC1-5	TC1-6	TC1-7	TC1-8	TC1-9	TC1-10	TC1-11	VC
B	TC1-1	TC1-2	TC1-3	TC1-4	TC1-5	TC1-6	TC1-7	TC1-8	TC1-9	TC1-10	TC1-11	VC
C	TC1-1	TC1-2	TC1-3	TC1-4	TC1-5	TC1-6	TC1-7	TC1-8	TC1-9	TC1-10	TC1-11	VC
D	TC2-1	TC2-2	TC2-3	TC2-4	TC2-5	TC2-6	TC2-7	TC2-8	TC2-9	TC2-10	TC2-11	VC
E	TC2-1	TC2-2	TC2-3	TC2-4	TC2-5	TC2-6	TC2-7	TC2-8	TC2-9	TC2-10	TC2-11	Meth
F	TC2-1	TC2-2	TC2-3	TC2-4	TC2-5	TC2-6	TC2-7	TC2-8	TC2-9	TC2-10	TC2-11	Meth
G	E2-1	E2-2	E2-3	E2-4	E2-5	E2-6	E2-7	E2-8	E2-9	E2-10	E2-11	Meth
H	E2-1	E2-2	E2-3	E2-4	E2-5	E2-6	E2-7	E2-8	E2-9	E2-10	E2-11	Meth

Abbreviations: TC1-1 to TC1-11 = concentrations (from high to low) of test chemical 1; TC2-1 to TC2-11 = concentrations (from high to low) of test chemical 2; E2-1 to E2-11 = concentrations of the E2 reference standard (from high to low); Meth = p,p' methoxychlor weak positive control; VC = DMSO (1 % v/v) EFM vehicle control

Figure 4

Antagonist Comprehensive Test 96-well Plate Layout

	1	2	3	4	5	6	7	8	9	10	11	12
A	TC1-1	TC1-2	TC1-3	TC1-4	TC1-5	TC1-6	TC1-7	TC1-8	TC1-9	TC1-10	TC1-11	VC
B	TC1-1	TC1-2	TC1-3	TC1-4	TC1-5	TC1-6	TC1-7	TC1-8	TC1-9	TC1-10	TC1-11	VC
C	TC1-1	TC1-2	TC1-3	TC1-4	TC1-5	TC1-6	TC1-7	TC1-8	TC1-9	TC1-10	TC1-11	VC
D	TC2-1	TC2-2	TC2-3	TC2-4	TC2-5	TC2-6	TC2-7	TC2-8	TC2-9	TC2-10	TC2-11	VC
E	TC2-1	TC2-2	TC2-3	TC2-4	TC2-5	TC2-6	TC2-7	TC2-8	TC2-9	TC2-10	TC2-11	Tam
F	TC2-1	TC2-2	TC2-3	TC2-4	TC2-5	TC2-6	TC2-7	TC2-8	TC2-9	TC2-10	TC2-11	Tam
G	Ral-1	Ral-2	Ral-3	Ral-4	Ral-5	Ral-6	Ral-7	Ral-8	Ral-9	E2	E2	Tam
H	Ral-1	Ral-2	Ral-3	Ral-4	Ral-5	Ral-6	Ral-7	Ral-8	Ral-9	E2	E2	Tam

Abbreviations: E2 = E2 control; Ral-1 to Ral-9 = concentrations of the Raloxifene/E2 reference standard (from high to low); Tam = Tamoxifen/E2 weak positive control; TC1-1 to TC1-11 = concentrations (from high to low) of test chemical 1 (TC1); TC2-1 to TC2-11 = concentrations (from high to low) of test chemical 2 (TC2); VC = vehicle control (DMSO [1 % v/v EFM.]).

Note: As noted, all reference and test wells contain a fixed concentration of E2 (9.18×10^{-11} M)

32. Repeat comprehensive tests for the same chemical should be conducted on different days, to ensure independence. At least two comprehensive tests should be conducted. If the results of the tests contradict each other (e.g. one test is positive, the other negative), or if one of the tests is inadequate, a third additional test should be conducted.

Measure of Luminescence

33. Luminescence is measured in the range of 300 to 650 nm, using an injecting luminometer and with software that controls the injection volume and measurement interval (7). Light emission from each well is expressed as RLU per well.

▼M8

ANALYSIS OF DATA

EC₅₀ /IC₅₀ determination

34. The EC₅₀ value (half maximal effective concentration of a test chemical [agonists]) and the IC₅₀ value (half maximal inhibitory concentration of a test chemical [antagonists]) are determined from the concentration-response data. For test chemicals that are positive at one or more concentrations, the concentration of test chemical that causes a half-maximal response (IC₅₀ or EC₅₀) is calculated using a Hill function analysis or an appropriate alternative. The Hill function is a four-parameter logistic mathematical model relating the test chemical concentration to the response (typically following a sigmoidal curve) using the equation below:

$$Y = Bottom + \frac{(Top - Bottom)}{1 + 10^{(lgEC_{50} - X)Hill\ Slope}}$$

Where:

Y = response (i.e. RLUs);

X = the logarithm of concentration;

Bottom = the minimum response;

Top = the maximum response;

lg EC₅₀ (or lg IC₅₀) = the logarithm of X as the response midway between Top and Bottom;

Hillslope = the steepness of the curve.

The model calculates the best fit for the Top, Bottom, Hillslope, and IC₅₀ and EC₅₀ parameters. For the calculation of EC₅₀ and IC₅₀ values, appropriate statistical software should be used (e.g. Graphpad Prism^R statistical software).

Determination of Outliers

35. Good statistical judgment could be facilitated by including (but not limited to) the Q-test (see agonist and antagonist protocols (7) for determining 'unusable' wells that will be excluded from the data analysis.
36. For E2 reference standard replicates (sample size of two), any adjusted RLU value for a replicate at a given concentration of E2 is considered an outlier if its value is more than 20 % above or below the adjusted RLU value for that concentration in the historical database.

Collection and Adjustment of Luminometer Data for Range Finder Testing

37. Raw data from the luminometer should be transferred to a spreadsheet template designed for the assay. It should be determined whether there are outlier data points that need to be removed. (See Test Acceptance Criteria for parameters that are determined in the analyses.) The following calculations should be performed:

Agonist

Step 1 Calculate the mean value for the DMSO vehicle control (VC).

Step 2 Subtract the mean value of the DMSO VC from each well value to normalise the data.

▼M8

Step 3 Calculate the mean fold induction for the reference standard (E2).

Step 4 Calculate the mean EC₅₀ value for the test chemicals.

Antagonist

Step 1 Calculate the mean value for the DMSO VC.

Step 2 Subtract the mean value of the DMSO VC from each well value to normalise the data.

Step 3 Calculate the mean fold reduction for the reference standard (Ral/E2).

Step 4 Calculate the mean value for the E2 reference standard.

Step 5 Calculate the mean IC₅₀ value for the test chemicals.

Collection and Adjustment of Luminometer Data for Comprehensive Testing

38. Raw data from the luminometer should be transferred to a spreadsheet template designed for the assay. It should be determined whether there are outlier data points that need to be removed. (See Test Acceptance Criteria for parameters that are determined in the analyses.) The following calculations are performed:

Agonist

Step 1 Calculate the mean value for the DMSO VC.

Step 2 Subtract the mean value of the DMSO VC from each well value to normalise the data.

Step 3 Calculate the mean fold induction for the reference standard (E2).

Step 4 Calculate the mean EC₅₀ value for E2 and the test chemicals.

Step 5 Calculate the mean adjusted RLU value for methoxychlor.

Antagonist

Step 1 Calculate the mean value for the DMSO VC.

Step 2 Subtract the mean value of the DMSO VC from each well value to normalise the data.

Step 3 Calculate the mean fold induction for the reference standard (Ral/E2).

Step 4 Calculate the mean IC₅₀ value for Ral/E2 and the test chemicals.

Step 5 Calculate the mean adjusted RLU value for tamoxifen.

Step 6 Calculate the mean value for the E2 reference standard.

▼ **M8****Data Interpretation Criteria**

39. The VM7Luc ER TA is intended as part of a weight of evidence approach to help prioritise substances for ED testing *in vivo*. Part of this prioritisation procedure will be the classification of the test chemical as positive or negative for either ER agonist or antagonist activity. The positive and negative decision criteria used in the VM7Luc ER TA validation study are described in Table 1.

Table 1

Positive and Negative Decision Criteria

AGONIST ACTIVITY	
Positive	<ul style="list-style-type: none"> — All test chemicals classified as <i>positive for</i> ER agonist activity should have a concentration–response curve consisting of a baseline, followed by a positive slope, and concluding in a plateau or peak. In some cases, only two of these characteristics (baseline–slope or slope–peak) may be defined. — The line defining the positive slope should contain at least three points with non-overlapping error bars (mean ± SD). Points forming the baseline are excluded, but the linear portion of the curve may include the peak or first point of the plateau. — A positive classification requires a response amplitude, the difference between baseline and peak, of at least 20 % of the maximal value for the reference standard, E2 (i.e. 2000 RLU or more when the maximal response value of the reference standards [E2] is adjusted to 10,000 RLU). — If possible, an EC₅₀ value should be calculated for each positive test chemical.
Negative	The average adjusted RLU for a given concentration is at or below the mean DMSO control RLU value plus three times the standard deviation of the DMSO RLU.
Inadequate	Data that cannot be interpreted as valid for showing either the presence or absence of activity because of major qualitative or quantitative limitations are considered inadequate and cannot be used to determine whether the test chemical is positive or negative. Chemicals should be retested.
ANTAGONIST ACTIVITY	
Positive	<ul style="list-style-type: none"> — Test chemical data produce a concentration–response curve consisting of a baseline, which is followed by a negative slope. — The line defining the negative slope should contain at least three points with non-overlapping error bars; points forming the baseline are excluded but the linear portion of the curve may include the first point of the plateau. — There should be at least a 20 % reduction in activity from the maximal value for the reference standard, Ral/E2 (i.e. 8000 RLU or less when the maximal response value of the reference standard [Ral/E2] is adjusted to 10,000 RLU). — The highest non-cytotoxic concentrations of the test chemical should be less than or equal to 1x10⁻⁵ M. — If possible, an IC₅₀ value should be calculated for each positive test chemical.
Negative	All data points are above the EC ₈₀ value (80 % of the E2 response, or 8000 RLU), at concentrations less than 1,0 10 ⁻⁵ M.
Inadequate	Data that cannot be interpreted as valid for showing either the presence or absence of activity because of major qualitative or quantitative limitations are considered inadequate and cannot be used to determine whether the test chemical is positive or negative. Chemical should be retested.

▼M8

40. Positive results will be characterised by both the magnitude of the effect and the concentration at which the effect occurs, where possible. Examples of positive, negative and inadequate data are shown in Figures 5 and 6.

Figure 5

Agonist Examples: Positive, Negative and Inadequate Data

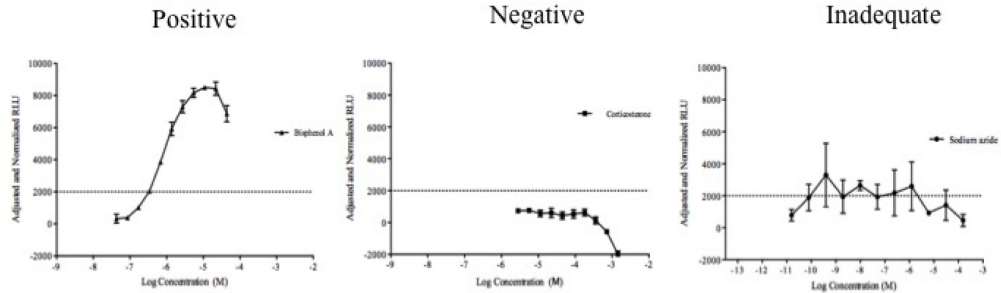

Dashed line indicates 20% of E2 response, 2000 adjusted and normalised RLUs.

Dashed line indicates 20 % of E2 response, 2000 adjusted and normalised RLUs.

Figure 6

Antagonist Examples: Positive, Negative, and Inadequate Data

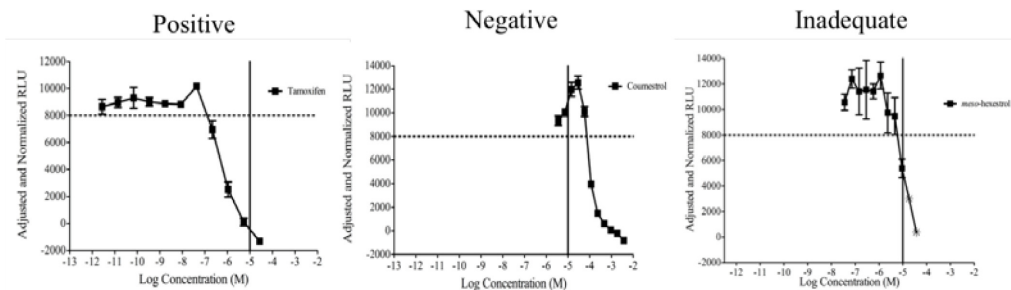

Dashed line indicates 80 % of Ral/E2 response, 8000 adjusted and normalised RLUs.

Solid line indicates 1,00 10⁻⁵ M. For a response to be considered positive, it should be below the 8000 RLU line, and at concentrations less than 1,00 10⁻⁵ M.

Asterisked concentrations in the meso-hexestrol graph indicate viability scores of '2' or greater.

The test results for meso-hexestrol are considered inadequate data because the only response that is below 8,000 RLU occurs at 1,00 10⁻⁵ M.

41. The calculations of EC₅₀ and IC₅₀ can be made using a four-parameter Hill Function (see agonist protocol and antagonist protocol for more details (7)). Meeting the acceptability criteria indicates the system is operating properly, but it does not ensure that any particular run will produce accurate data. Duplicating the results of the first run is the best assurance that accurate data were produced (see paragraph 19 of 'ER TA ASSAY COMPONENTS').

▼ **M8**

TEST REPORT

42. See paragraph 20 of 'ER TA ASSAY COMPONENTS'.

LITERATURE

- (1) ICCVAM. (2011). ICCVAM Test Method Evaluation Report on the LUMI-CELL® ER (BG1Luc ER TA) Test Method: An *In Vitro* Method for Identifying ER Agonists and Antagonists, National Institute of Environmental Health Sciences: Research Triangle Park, NC.
- (2) Monje P., Boland R. (2001). Subcellular Distribution of Native Estrogen Receptor α and β Isoforms in Rabbit Uterus and Ovary, *J. Cell Biochem.*, 82(3): 467-479.
- (3) Pujol P., *et al.* (1998). Differential Expression of Estrogen Receptor-Alpha and -Beta Messenger RNAs as a Potential Marker of Ovarian Carcinogenesis, *Cancer Res.*, 58(23): 5367-5373.
- (4) Weihua Z., *et al.* (2000). Estrogen Receptor (ER) β , a Modulator of ER α in the Uterus, *Proceedings of the National Academy of Sciences of the United States of America* 97(11): 936-941.
- (5) Balls M., *et al.* (2006). The Importance of Good Cell Culture Practice (GCCP), *ALTEX*, 23(Suppl): p. 270-273.
- (6) Coecke S., *et al.* (2005). Guidance on Good Cell Culture Practice: a Report of the Second ECVAM Task Force on Good Cell Culture Practice, *Alternatives to Laboratory Animals*, 33: p. 261-287.
- (7) ICCVAM (2011). ICCVAM Test Method Evaluation Report, The LUMI-CELL® ER (BG1Luc ER TA) Test Method: An *In Vitro* Assay for Identifying Human Estrogen Receptor Agonist and Antagonist Activity of Chemicals, NIH Publication No 11-7850.
- (8) Rogers J.M., Denison M.S. (2000). Recombinant Cell Bioassays for Endocrine Disruptors: Development of a Stably Transfected Human Ovarian Cell Line for the Detection of Estrogenic and Anti-Estrogenic Chemicals, *In Vitro Mol. Toxicol.*, 13(1):67-82.
- (9) Escande A., *et al.* (2006). Evaluation of Ligand Selectivity Using Reporter Cell Lines Stably Expressing Estrogen Receptor Alpha or Beta, *Biochem. Pharmacol.*, 71(10):1459-69.
- (10) Thorne N., Inglese J., Auld D.S. (2010). Illuminating Insights into Firefly Luciferase and Other Bioluminescent Reporters Used in Chemical Biology, *Chemistry and Biology*, 17(6):646-57.
- (11) Kuiper G.G., *et al.* (1998). Interaction of Estrogenic Chemicals and Phytoestrogens with Estrogen Receptor Beta, *Endocrinology*, 139(10):4252-63.
- (12) Geisinger, *et al.* (1989). Characterization of a human ovarian carcinoma cell line with estrogen and progesterone receptors, *Cancer* 63, 280-288.
- (13) Baldwin, *et al.* (1998). BG-1 ovarian cell line: an alternative model for examining estrogen-dependent growth *in vitro*, *In Vitro Cell. Dev. Biol. – Animal*, 34, 649-654.
- (14) Li, Y., *et al.* (2014). Research resource: STR DNA profile and gene expression comparisons of human BG-1 cells and a BG-1/MCF-7 clonal variant, *Mol. Endo.* 28, 2072-2081.
- (15) Rogers, J.M. and Denison, M.S. (2000). Recombinant cell bioassays for endocrine disruptors: development of a stably transfected human ovarian cell line for the detection of estrogenic and anti-estrogenic chemicals, *In Vitro & Molec. Toxicol.* 13, 67-82.

▼ **M8***Appendix 4*

STABLY TRANSFECTED HUMAN ESTROGEN RECEPTOR- α TRANSACTIVATION ASSAY FOR DETECTION OF ESTROGENIC AGONIST AND ANTAGONIST ACTIVITY OF CHEMICALS USING THE ERA CALUX CELL LINE

INITIAL CONSIDERATIONS AND LIMITATIONS (SEE ALSO GENERAL INTRODUCTION)

1. The ER α CALUX transactivation assay uses the human U2OS cell line to detect estrogenic agonist and antagonist activity mediated through human estrogen receptor alpha (hER α). The validation study of the stably transfected ER α CALUX bioassay by BioDetection Systems BV (Amsterdam, the Netherlands) demonstrated the relevance and reliability of the assay for its intended purpose (1). The ER α CALUX cell line expresses stably transfected human ER α only (2) (3).
2. This assay is specifically designed to detect hER α -mediated transactivation by measuring bioluminescence as the endpoint. The use of bioluminescence is commonly used in bioassays because of the high signal-to-noise ratio (4).
3. Phytoestrogen concentrations higher than 1 μ M have been reported to over-activate the luciferase reporter gene, resulting in non-receptor-mediated luminescence (5) (6) (7). Therefore, higher concentrations of phytoestrogens or other similar compounds that can over-activate the luciferase expression, have to be examined carefully in stably transfected ER transactivation assays (see Appendix 2).
4. The 'GENERAL INTRODUCTION' and 'ER TA ASSAY COMPONENTS' should be read before using this assay for regulatory purposes. Definitions and abbreviations used in this test method are described in Appendix 1.

PRINCIPLE OF THE ASSAY (SEE ALSO GENERAL INTRODUCTION)

5. The bioassay is used to assess ER ligand binding and subsequent translocation of the receptor-ligand complex to the nucleus. In the nucleus, the receptor-ligand complex binds specific DNA response elements and transactivates a firefly luciferase reporter gene, resulting in increased cellular expression of the luciferase enzyme. Following the addition of the luciferase substrate luciferine, the luciferine is transformed into a bioluminescent product. The light produced can easily be detected and quantified using a luminometer.
6. The test system utilises stably transfected ER α CALUX cells. ER α CALUX cells originated from the human osteoblastic osteosarcoma U2OS cell line. Human U2OS cells were stably transfected with 3xHRE-TATA-Luc and pSG5-neo-hER α using the calcium phosphate co-precipitation method. The U2OS cell line was selected as the best candidate to serve as the estrogen- (and other steroid hormone) responsive reporter cell line, based on the observation that the U2OS cell line showed little or no endogenous receptor activity. The absence of endogenous receptors was assessed using luciferase reporter plasmids only, showing no activity when receptor ligands were added. Furthermore, this cell line supported strong hormone-mediated responses when cognate receptors were transiently introduced (2) (3) (8).
7. Testing chemicals for estrogenic or anti-estrogenic activity using the ER α CALUX cell line include a prescreen run and comprehensive runs. During the prescreen run, the solubility, cytotoxicity and a refined concentration-range of

▼M8

test chemicals for comprehensive testing are determined. During the comprehensive runs, the refined concentration-ranges of test chemicals are tested in the ER α CALUX bioassays followed by the classification of the test chemicals for agonism or antagonism.

8. Criteria for data interpretation are described in detail in paragraph 59. Briefly, a test chemical is considered positive for agonism in case at least two consecutive concentrations of the test chemical show a response that is equal or higher than 10 % of the maximum response of the reference standard 17 β -estradiol (PC₁₀). A test chemical is considered positive for antagonism in case at least two consecutive concentrations of the test chemical show a response that is equal or lower than 80 % of the maximum response of the reference standard tamoxifen (PC₈₀).

PROCEDURE**Cell lines**

9. The stably transfected U2OS ER α CALUX cell line should be used for the assay. The cell line can be obtained from BioDetection Systems BV, Amsterdam, the Netherlands with a technical licensing agreement.
10. Only mycoplasma free cell cultures should be used. Cell batches used should either be certified negative for mycoplasma contamination, or a mycoplasma test should be performed before use. RT-PCR (Real Time Polymerase Chain Reaction) should be used for sensitive detection of mycoplasma infection (9).

Stability of the cell line

11. To maintain the stability and integrity of the CALUX cells, the cells should be stored in liquid nitrogen (-80°C). Following thawing of cells to start a new culture, cells should be sub-cultured at least twice before being used to assess the estrogenic agonist and antagonist activity of chemicals. Cells should not be sub-cultured for more than 30 passages.
12. To monitor the stability of the cell line over time, the responsiveness of the agonistic and antagonistic test system should be verified by evaluating the EC₅₀ or IC₅₀ of the reference standard. In addition, the relative induction of the positive control sample (PC) and the negative control sample (NC) should be monitored. The results should be in agreement with the acceptance criteria for the agonistic (Table 3C) or antagonistic ER α CALUX bioassay (Table 4C). The reference standards, positive and negative controls are given in Table 1 and Table 2 for the agonistic and antagonistic mode respectively.

Cell Culture and plating conditions

13. The U2OS cells should be cultured in growth medium (DMEM/F12 (1:1) medium with phenol red as pH indicator, supplemented with fetal bovine serum (7.5 %), non-essential amino acids (1 %), 10 Units/ml of penicillin, streptomycin and geneticin (G-418) as selection marker). Cells should be placed in a CO₂ incubator (5 % CO₂) at 37°C and 100 % humidity. When cells reach an 85-95 % confluency, cells should either be subcultured or prepared for seeding in 96-well microtiter plates. In case of the latter, cells should be resuspended at 1x10⁵ cells/ml in estrogen free assay medium (DMEM/F12 (1:1) medium without phenol red, supplemented with Dextran-Coated Charcoal treated fetal bovine serum (5 % v/v), non-essential amino acids (1 % v/v), 10 Units/ml of penicillin and streptomycin) and plated into the wells of the 96-well microtiterplates (100 μ l of homogenised cell suspension). Cells should be pre-incubated in a CO₂ incubator (5 % CO₂, 37°C, 100 % humidity) for 24 hours prior to exposure. Plastic ware should be estrogen free.

▼M8**Acceptability criteria**

14. Agonistic and antagonistic activities of the test chemical(s) are tested in test series. A test series consists of a maximum of 6 microtiter plates. Each test series contains at least 1 full series of dilutions of a reference standard, a positive control sample, a negative control sample and solvent controls. Figures 1 and 2 give the plate setup for agonistic and antagonistic tests series.
15. Each dilution of the reference standards, test chemicals, all solvent controls, and positive and negative controls should be analysed in triplicate. Each of the triplicate analyses should fulfil the requirements given in Table 3A and Table 4A.
16. A complete series of dilutions of the reference standard (17 β -estradiol for agonism; tamoxifen for antagonism) is measured on the first plate in each test series. To be able to compare the analysis results of the remaining 5 microtiter plates with the first microtiter plate containing the complete concentration-response curve of the reference standard, all plates should contain 3 control samples: solvent control, the highest concentration of the reference standard tested, and the approximate EC₅₀ (agonism) or IC₅₀ (antagonism) concentration of the reference standard. The ratio of the average control samples on the first plate and the remaining 5 plates should fulfil the requirements as given in Table 3C (agonism) or Table 4C (antagonism).
17. For each of the microtiter plates within a test series, the z-factor is calculated (10). The z-factor should be calculated using the responses at the highest and lowest concentration of the reference standard. A microtiter plate is considered valid in case it fulfils the requirements as stated in Table 3C (agonism) or Table 4C (antagonism).
18. The reference standard should demonstrate a sigmoidal dose-response curve. The EC₅₀ or IC₅₀ derived from the response of the series of dilutions of the reference standard, should fulfil the requirements as indicated in Table 3C (agonism) or Table 4C (antagonism).
19. Each test series should contain a positive control and negative control sample. The calculated relative induction of both the positive and negative control sample should fulfil the requirements as indicated in Table 3C (agonism) or Table 4C (antagonism).
20. During all measurements, the induction factor of the highest concentration of the reference standard should be measured by dividing the average highest 17 β -estradiol reference standard relative light unit (RLU) response by the average reference solvent control RLU response. This induction factor should fulfil the minimum requirements for the fold induction as indicated in Table 3C (agonism) or Table 4C (antagonism).
21. Only microtiter plates that fulfil all above mentioned acceptance criteria are considered valid and can be used to evaluate the response of test chemicals.
22. The acceptance criteria are applicable to both prescreen and comprehensive runs.

▼ **M8**

Table 1

Concentrations of reference standard, positive control (PC) and negative control (NC) for the agonistic CALUX bioassay

	Substance	CAS RN	Test range (M)
Reference standard	17 β -estradiol	50-28-2	1*10 ⁻¹³ – 1*10 ⁻¹⁰
Positive control (PC)	17 α -methyltestosterone	58-18-4	3*10 ⁻⁶
Negative control (NC)	corticosterone	50-22-6	1*10 ⁻⁸

Table 2

Concentrations of reference standard, positive control (PC) and negative control (NC) for the antagonistic CALUX bioassay

	Substance	CAS RN	Test range (M)
Reference standard	tamoxifen	10540-29-1	3*10 ⁻⁹ – 1*10 ⁻⁵
Positive control (PC)	4-hydroxytamoxifen	68047-06-3	1*10 ⁻⁹
Negative control (NC)	resveratrol	501-36-0	1*10 ⁻⁵

Table 3

Acceptance criteria for the agonistic ER α CALUX bioassay

A - individual samples on a plate			Criterion
1	Maximum %SD of triplicate wells (for NC, PC, each dilution of the test chemical and the reference standard, except C0)		< 15 %
2	Maximum %SD of triplicate wells (for reference standard and test chemical solvent controls (C0, SC))		< 30 %
3	Maximum LDH leakage, as a measure of cytotoxicity.		< 120 %
B - within a single microtiter plate			
4	Ratio of the reference standard solvent control (C0; plate 1) and test chemical solvent control (SC; plates 2 to x)		0,5 to 2,0
5	Ratio of the appr. EC50 and highest reference standard concentrations on plate 1 and the appr. EC50 and highest reference standard concentrations on plates 2 to x (C4, C8)		0,70 to 1,30
6	Z-factor for each plate		>0.6
C - within a single series of analyses (all plates within one series)			
7	Sigmoidal curve of reference standard		Yes (17 β -estradiol)
8	EC50 range reference standard 17 β -estradiol		4*10 ⁻¹² – 4*10 ⁻¹¹ M
9	Minimum fold induction of the highest 17 β -estradiol concentration, with respect to the reference standard solvent control.		5
10	Relative induction (%) PC.		> 30 %
11	Relative induction (%) NC		<10 %

▼M8

Appr.: approximative; PC: positive control; NC: negative control; SC: test chemical solvent control; C0: reference standard solvent control; SD: standard deviation; LDH: lactate dehydrogenase

Table 4

Acceptance criteria for the antagonistic ER α CALUX bioassay

A - individual samples on a plate		Criterion
1	Maximum %SD of triplicate wells (for NC, PC, each dilution of the test chemical and the reference standard, solvent control (C0))	< 15 %
2	Maximum %SD of triplicate wells (for vehicle control (VC) and highest reference standard concentration (C8))	< 30 %
3	Maximum LDH leakage, as a measure of cytotoxicity.	< 120 %
B - within a single microtiter plate		
4	Ratio of the reference standard solvent control (C0; plate 1) and test chemical solvent control (SC; plates 2 to x)	0,70 to 1,30
5	Ratio of the appr. IC50 reference standard concentrations on plate 1 and the appr. IC50 reference standard concentrations on plates 2 to x (C4)	0,70 to 1,30
6	Ratio of the highest reference standard concentrations on plate 1 and the highest reference standard concentrations on plates 2 to x (C8)	0,50 to 2,0
7	Z-factor for each plate	> 0,6
C - within a single series of analyses (all plates within one series)		
8	Sigmoidal curve of reference standard	Yes (Tamoxifen)
9	IC50 range reference standard (Tamoxifen)	$1 \cdot 10^{-8}$ - $1 \cdot 10^{-7}$ M
10	Minimum fold induction of the reference standard solvent control, with respect to the highest Tamoxifen concentration.	2,5
11	Relative induction (%) PC.	< 70 %
12	Relative induction (%) NC	> 85 %

Appr.: approximative; PC: positive control; NC: negative control; VC: vehicle control (solvent control without fixed concentration of agonist reference standard); SC: test chemical solvent control; C0: reference standard solvent control; SD: standard deviation; LDH: lactate dehydrogenase

Solvent/vehicle control, reference standards, positive controls, negative controls

23. For both the prescreen run and comprehensive runs, the same solvent/vehicle control, reference standards, positive controls and negative controls should be used. In addition, the concentration of reference standards, positive controls and negative controls should be the same.

▼ M8*Solvent control*

24. The solvent used to dissolve the test chemicals should be tested as a solvent control. Dimethylsulfoxide (DMSO, 1 % (v/v); CASRN 67-68-5) was used as vehicle during the validation of the ER α CALUX bioassay. If a solvent other than DMSO is used, all reference standards, controls, and test chemicals should be tested in the same vehicle. Please note that the solvent control for antagonistic studies contains a fixed concentration of the agonist reference standard 17 β -estradiol (approximately EC₅₀ concentration). To test the solvent used for antagonistic studies, a vehicle control should be prepared and tested.

Vehicle control (antagonism)

25. For testing antagonism, the assay medium is supplemented with a fixed concentration of the agonist reference standard 17 β -estradiol (approximately EC₅₀ concentration). To test the solvent used to dissolve the test chemicals for antagonism, an assay medium without a fixed concentration of the agonist reference standard 17 β -estradiol should be prepared. This control sample is indicated as the vehicle control. Dimethylsulfoxide (DMSO, 1 % (v/v); CASRN 67-68-5) was used as vehicle during the validation of the ER α CALUX bioassay. If a solvent other than DMSO is used, all reference standards, controls, and test chemicals should be tested in the same vehicle.

Reference standards

26. The agonistic reference standard is 17 β -estradiol (Table 1). The reference standards comprise a series of dilutions of eight concentrations of 17 β -estradiol (1×10^{-13} , 3×10^{-13} , 1×10^{-12} , 3×10^{-12} , 6×10^{-12} , 1×10^{-11} , 3×10^{-11} , 1×10^{-10} M).
27. The antagonistic reference standard is tamoxifen (Table 2). The reference standards comprise a series of dilutions of eight concentrations of tamoxifen (3×10^{-9} , 1×10^{-8} , 3×10^{-8} , 1×10^{-7} , 3×10^{-7} , 1×10^{-6} , 3×10^{-6} , 1×10^{-5} M). Each of the concentrations of the antagonistic reference standard is co-incubated with a fixed concentration of the agonistic reference standard 17 β -estradiol (3×10^{-12} M).

Positive control

28. The positive control for agonistic studies is 17 α -methyltestosterone (Table 1).
29. The positive control for antagonistic studies is 4-hydroxytamoxifen (Table 2). The antagonistic positive control is co-incubated with a fixed concentration of the agonistic reference standard 17 β -estradiol (3×10^{-12} M).

Negative control

30. The negative control for agonistic studies is corticosterone (Table 1).
31. The negative control for antagonistic studies is resveratrol (Table 2). The antagonistic negative control is co-incubated with a fixed concentration of the agonistic reference standard 17 β -estradiol (3×10^{-12} M).

▼M8

Demonstration of laboratory proficiency (see paragraph 14 and Tables 3 and 4 in «ER TA ASSAY COMPONENTS» of this test method)

Vehicle

32. The solvent used to dissolve test chemicals should solubilise the test chemical completely and should be miscible with the cell medium. DMSO, water and ethanol (95 % to 100 % purity) are suitable solvents. In case DMSO is used as solvent, the maximum concentration of DMSO during incubation should not exceed 1 % (v/v). Prior to use, the solvent should be tested for absence of cytotoxicity and interference with the assays performance.

Preparation of reference standards, positive controls, negative controls and test chemicals

33. Reference standards, positive controls, negative controls and test chemicals are dissolved in 100 % DMSO (or an appropriate solvent). Appropriate (serial) dilutions should then be prepared in the same solvent. Before being dissolved, all substances should be allowed to equilibrate to room temperature. Freshly prepared stock solutions of reference standards, positive controls, negative controls and test chemicals should not have noticeable precipitate or cloudiness. Reference standard and control stocks may be prepared in bulk. Stock solutions of test chemicals should be prepared fresh before each experiment. Final dilutions of reference standards, positive controls, negative controls and test chemicals should be prepared for each experiment fresh and used within 24 hours of preparation.

Solubility, cytotoxicity and range finding.

34. During the prescreen run, the solubility of the test chemicals in the solvent of choice is determined. A maximum stock concentration of 0,1 M is prepared. In case this concentration shows solubility problems, lower stock solutions should be prepared until test chemicals are fully solubilised. During the prescreen run, 1:10 serial dilutions of test chemical are tested. The maximum assay concentration for agonist or antagonist testing is 1 mM. Following prescreening, an appropriate refined concentration range for test chemicals is derived that should be tested during the comprehensive runs. The dilutions used for comprehensive testing should be 1x, 3x, 10x, 30x, 100x, 300x, 1000x and 3000x.
35. Cytotoxicity testing is included in the agonist and antagonist assay protocol (11). Cytotoxicity testing is incorporated in both the prescreen run and comprehensive runs. The method used to assess cytotoxicity during the validation of the ER α CALUX bioassay was the lactate dehydrogenase (LDH) leakage test in combination with qualitative visual inspection of cells (see Appendix 4.1) following exposure to test chemicals. However, other quantitative methods for the determination of cytotoxicity (e.g. tetrazolium-based colorimetric (MTT) assay or cytotoxicity CALUX bioassay) can be used. In general, test chemical concentrations that show more than 20 % reduction of cell viability are considered cytotoxic and therefore cannot be used for data evaluation. With respect to the LDH leakage assay, the concentration of the test chemical is regarded cytotoxic when the percentage LDH leakage is higher than 120 %.

▼ **M8****Test chemical exposure and assay plate organisation**

36. Following trypsination of a confluent flask of cultured cells, cells are re-suspended at 1×10^5 cells/ml in estrogen free assay medium. Hundred μ l of re-suspended cells are plated in the inner-wells of a 96-well microtiter plate. The outer wells are filled with 200 μ l of Phosphate Buffered Saline (PBS) (see Figures 1 and 2). The plated cells are pre-incubated for 24 hours in a CO₂ incubator (5 % CO₂, 37°C, 100 % humidity).
37. After pre-incubation, the plates are inspected for visual cytotoxicity (see Appendix 4.1), contamination and confluence. Only plates that show no visual cytotoxicity, contamination and have a minimum of 85 % confluence are used for testing. The medium from the inner wells is carefully removed and replaced by 200 μ l of estrogen free assay medium containing appropriate dilutions series of reference standards, test chemicals, positive controls, negative controls and solvent controls (Table 5: agonist studies; Table 6: antagonist studies). All reference standards, test chemicals, positive controls, negative controls and solvent controls are tested in triplicate. In Figure 1, the plate layout for agonist testing is given. In Figure 2, the plate layout for antagonist testing is given. The plate layout for prescreen testing and comprehensive testing is identical. For antagonist testing, all inner-wells, except for the vehicle control wells (VC), also contain a fixed concentration of agonist reference standard 17 β -estradiol (3×10^{-12} M). Note that reference standards C8 and C4 should be added to each TC plate.
38. Following exposure of the cells to all chemicals, the 96-well microtiter plates should be incubated for another 24 hours in a CO₂ incubator (5 % CO₂, 37°C, 100 % humidity).

*Figure 1***Plate layout of the 96-well microtiter plates for prescreening and assessment of agonistic effect.****Plate 1**

	1	2	3	4	5	6	7	8	9	10	11	12
A												
B		C0	C1	C2	C3	C4	C5	C6	C7	C8	PC	
C		C0	C1	C2	C3	C4	C5	C6	C7	C8	PC	
D		C0	C1	C2	C3	C4	C5	C6	C7	C8	PC	
E		SC	TC1-1	TC1-2	TC1-3	TC1-4	TC1-5	TC1-6	TC1-7	TC1-8	NC	
F		SC	TC1-1	TC1-2	TC1-3	TC1-4	TC1-5	TC1-6	TC1-7	TC1-8	NC	
G		SC	TC1-1	TC1-2	TC1-3	TC1-4	TC1-5	TC1-6	TC1-7	TC1-8	NC	
H												

Subsequent plates

	1	2	3	4	5	6	7	8	9	10	11	12
A												
B		SC	TC2-1	TC2-2	TC2-3	TC2-4	TC2-5	TC2-6	TC2-7	TC2-8	C8 (max)	
C		SC	TC2-1	TC2-2	TC2-3	TC2-4	TC2-5	TC2-6	TC2-7	TC2-8	C8 (max)	
D		SC	TC2-1	TC2-2	TC2-3	TC2-4	TC2-5	TC2-6	TC2-7	TC2-8	C8 (max)	
E		SC	TCx-1	TCx-2	TCx-3	TCx-4	TCx-5	TCx-6	TCx-7	TCx-8	C4 (EC50)	
F		SC	TCx-1	TCx-2	TCx-3	TCx-4	TCx-5	TCx-6	TCx-7	TCx-8	C4 (EC50)	
G		SC	TCx-1	TCx-2	TCx-3	TCx-4	TCx-5	TCx-6	TCx-7	TCx-8	C4 (EC50)	
H												

C0 = reference standard solvent.

C(1-8) = series of dilutions (1-8, low-to-high concentrations) of reference standard.

▼M8

PC = positive control.

NC = negative control.

TCx-(1-8) = dilutions (1-8, low-to-high concentrations) of test chemical for the prescreen run and assessment of agonistic effect of test chemical x.

SC = solvent control of the test chemical (optimally the same solvent as in C0, but possibly from another batch).

Grey cells: = Outer wells, filled up with 200 µl of PBS.

Figure 2

Plate layout of the 96-well microtiter plates for antagonistic prescreening and assessment of antagonistic effect.

Plate 1

	1	2	3	4	5	6	7	8	9	10	11	12
A												
B		C0	C1	C2	C3	C4	C5	C6	C7	C8	VC	
C		C0	C1	C2	C3	C4	C5	C6	C7	C8	VC	
D		C0	C1	C2	C3	C4	C5	C6	C7	C8	VC	
E		NC	TC1-	TC1-2	TC1-3	TC	TC1-5	TC1-	TC1-	TC1-	PC	
F		NC	TC1-	TC1-2	TC1-3	TC	TC1-5	TC1-	TC1-	TC1-	PC	
G		NC	TC1-	TC1-2	TC1-3	TC	TC1-5	TC1-	TC1-	TC1-	PC	
H												

Subsequent plates

	1	2	3	4	5	6	7	8	9	10	11	12
A												
B		SC	TC2-1	TC2-2	TC2-3	TC2-4	TC2-5	TC2-6	TC2-7	TC2-8	C8 (max)	
C		SC	TC2-1	TC2-2	TC2-3	TC2-4	TC2-5	TC2-6	TC2-7	TC2-8	C8 (max)	
D		SC	TC2-1	TC2-2	TC2-3	TC2-4	TC2-5	TC2-6	TC2-7	TC2-8	C8 (max)	
E		C4 (IC50)	TCx-1	TCx-2	TCx-3	TCx-4	TCx-5	TCx-6	TCx-7	TCx-8	C8 (max)	
F		C4 (IC50)	TCx-1	TCx-2	TCx-3	TCx-4	TCx-5	TCx-6	TCx-7	TCx-8	C8 (max)	
G		C4 (IC50)	TCx-1	TCx-2	TCx-3	TCx-4	TCx-5	TCx-6	TCx-7	TCx-8	C8 (max)	
H												

C0 = reference standard solvent.

C(1-8) = series of dilutions (1-8, low-to-high concentrations) of reference standard.

NC = negative control.

PC = positive control.

TCx-(1-8) = dilutions (1-8, low-to-high concentrations) of test chemical for the prescreen run and assessment of agonistic effect of test chemical x.

SC = solvent control of the test chemical (optimally the same solvent as in C0, but possibly from another batch).

VC = vehicle control (solvent control without fixed concentration of agonist reference standard 17β-estradiol).

Grey cells: = Outer wells, filled up with 200 µl of PBS.

Note: all inner-wells, except for the vehicle control wells (VC), also contain a fixed concentration of agonist reference standard 17β-estradiol (3.0*10⁻¹² M)

Measurement of luminescence

39. The measurement of luminescence is described in detail in the agonist and antagonist assay protocol (10). The medium from the wells should be removed and the cells should be lysed following 24 hours of incubation in order to open up the cell membrane and allow measurement of luciferase activity.

▼M8

40. For measuring the luminescence, this procedure requires a luminometer equipped with 2 injectors. The luciferase reaction is started by injection of the substrate luciferin. The reaction is stopped by addition of 0,2 M NaOH. The reaction is stopped to prevent carry over of luminescence from one well to the other.
41. Light emitted from each well is expressed as Relative Light Units (RLUs) per well.

Prescreen run

42. The prescreen analysis results are used to determine a refined concentration-range of test chemicals for comprehensive testing. Evaluation of prescreen analysis results and the determination of the refined concentration-range of test chemicals for comprehensive testing, is described in depth in the agonist and antagonist assay protocol (10). Here, a brief summary of the procedures for determining the concentration range of test chemicals for agonist and antagonist testing, is given. See Tables 5 and 6 for guidance of serial dilution design.

Selection of concentrations for assessment of agonistic effects

43. During the prescreen run, test chemicals should be tested using the series of dilutions as indicated in Tables 5 (agonism) and 6 (antagonism). All concentrations should be tested in triplicate wells according to the plate layout as indicated in Figure 1 (agonism) or 2 (antagonism).
44. Only analysis results that fulfil the acceptance criteria (Table 3) are considered valid and can be used to evaluate the response of test chemicals. In case one or more microtiter plates in an analysis series fail to fulfil the acceptance criteria, the respective microtiterplates should be re-analysed. In case the first plate containing the complete series of dilutions of the reference standard fails the acceptance criteria, the complete test series (6 plates) have to be re-analysed.
45. Initial concentration ranges of test chemicals should be adjusted and the prescreen run should be repeated in case:
- cytotoxicity is observed. The prescreen procedure should be repeated with lower non-cytotoxic concentrations of the test chemical.
 - the prescreen of the test chemical does not show a full dose-response curve because the concentrations tested generate maximum induction. The prescreen run should be repeated using lower concentrations of the test chemical.
46. When a valid dose-related response is observed, the (lowest) concentration at which maximum induction is observed and does not show cytotoxicity, should be selected. The highest concentration of the test chemical to be tested in the comprehensive runs, should be 3-times this selected concentration.
47. A complete refined dilution series of the test chemical should be prepared with dilutions steps as indicated in Table 5, starting with the highest concentration as determined above.

▼M8

48. A test chemical that does not elicit any agonistic effect, should be tested in the comprehensive runs starting with the highest, non-cytotoxic concentration identified during prescreening.

Selection of concentrations for assessment of antagonistic effects

49. Only analysis results that fulfil the acceptance criteria (Table 4) are considered valid and can be used to evaluate the response of test chemicals. In case one or more microtiter plates in an analysis series fail to fulfil the acceptance criteria, the respective microtiterplates should be re-analysed. In case the first plate containing the complete series of dilutions of the reference standard fails the acceptance criteria, the complete test series (6 plates) have to be re-analysed.
50. Initial concentration ranges of test chemicals should be adjusted and the prescreen run should be repeated in case:
- cytotoxicity is observed. The prescreen procedure should be repeated with lower non-cytotoxic concentrations of the test chemical.
 - the prescreen of the test chemical does not show a full dose-response curve because the concentrations tested generate maximum inhibition. The prescreen should be repeated using lower concentrations of the test chemical.
51. When a valid dose-related response is found, the (lowest) concentration at which maximum inhibition is observed and does not show cytotoxicity, should be selected. The highest concentration of the test chemical to be tested in the comprehensive runs, should be 3-times this selected concentration.
52. A complete refined dilution series of the test chemical should be prepared with the dilutions steps as indicated in Table 6, starting with the highest concentration as determined above.
53. Test chemicals that do not elicit any antagonistic effects, should be tested in the comprehensive runs starting with the highest, non-cytotoxic concentration tested during prescreening.

Comprehensive runs

54. Following the selection of the refined concentration ranges, test chemicals should be tested comprehensively using the series of dilutions as indicated in Tables 5 (agonism) and 6 (antagonism). All concentrations should be tested in triplicate wells according to the plate layout as indicated in Figure 1 (agonism) or 2 (antagonism).
55. Only analysis results that fulfil the acceptance criteria (Table 3 and 4) are considered valid and can be used to evaluate the response of test chemicals. In case one or more microtiter plates in an analysis series fail to fulfil the acceptance criteria, the respective microtiterplates should be re-analysed. In case the first plate containing the complete series of dilutions of the reference standard fails the acceptance criteria, the complete test series (6 plates) have to be re-analysed.

▼M8

Table 5

Concentration and dilutions of reference standards, controls and test chemicals used for agonist testing

Reference 17 β -estradiol		TCx - prescreen run		TCx - comprehensive run		Controls	
conc. (M)		dilution		dilution		conc. (M)	
C0	0	TCx-1	10 000 000 x	TCx-1	3 000 x	PC	3*10 ⁻⁶
C1	1*10 ⁻¹³	TCx-2	1 000 000 x	TCx-2	1 000 x	NC	1*10 ⁻⁸
C2	3*10 ⁻¹³	TCx-3	100 000 x	TCx-3	300 x	C0	0
C3	1*10 ⁻¹²	TCx-4	10 000 x	TCx-4	100 x	SC	0
C4	3*10 ⁻¹²	TCx-5	1 000 x	TCx-5	30 x		
C5	6*10 ⁻¹²	TCx-6	100 x	TCx-6	10 x		
C6	1*10 ⁻¹¹	TCx-7	10 x	TCx-7	3 x		
C7	3*10 ⁻¹¹	TCx-8	1 x	TCx-8	1 x		
C8	1*10 ⁻¹⁰						

TCx - test chemical x
PC - positive control (17 α -methyltestosterone)
NC - negative control (corticosterone)
C0 - reference standard solvent control
SC - test chemical solvent control

▼M8

Table 6

Concentration and dilutions of reference standards, controls and test chemicals used for antagonist testing

Reference tamoxifen		TCx - prescreen run		TCx - comprehensive run		Controls	
conc. (M)		dilution		dilution		conc. (M)	
C0	0	TCx-1	10 000 000 x	TCx-1	3 000 x	PC	$1*10^{-9}$
C1	$3*10^{-9}$	TCx-2	1 000 000 x	TCx-2	1 000 x	NC	$1*10^{-5}$
C2	$1*10^{-8}$	TCx-3	100 000 x	TCx-3	300 x	C0	0
C3	$3*10^{-8}$	TCx-4	10 000 x	TCx-4	100 x	SC	0
C4	$1*10^{-7}$	TCx-5	1 000 x	TCx-5	30 x		
C5	$3*10^{-6}$	TCx-6	100 x	TCx-6	10 x	Supplemented agonist	
C6	$1*10^{-6}$	TCx-7	10 x	TCx-7	3 x	conc. (M)	
C7	$3*10^{-6}$	TCx-8	1 x	TCx-8	1 x	17 β -estradiol	$3*10^{-12}$
C8	$1*10^{-5}$						

TCx - test chemical x

PC - positive control (4-hydroxytamoxifen)

NC - negative control (resveratrol)

C0 - reference standard solvent control

SC - test chemical solvent control

VC - vehicle control (does not contain fixed concentration of the agonistic reference standard 17 β -estradiol ($3.0*10^{-12}$ M))

▼ M8**Collection of data and data analysis**

56. Following the prescreen and comprehensive runs, the EC₁₀, EC₅₀, PC₁₀, PC₅₀ and maximum induction (TC_{xmax}) of a test chemical should be determined for agonistic testing. For antagonistic testing, the IC₂₀, IC₅₀, PC₈₀, PC₅₀ and minimum induction (TC_{xmin}) should be calculated. In Figure 3 (agonism) and 4 (antagonism), a graphical representation of these parameters is given. The required parameters are calculated based on the relative induction of each test chemical (relative to the maximum induction of the reference standard (=100 %)). Non-linear regression (variable slope, 4 parameters) should be used for evaluation of data according to the following equation:

$$Y = Bottom + \frac{(Top - Bottom)}{(1 + 10^{(lgEC_{50} - X) \times Hill\ Slope})}$$

Where:

X = Log of dose or concentration

Y = Response (relative induction (%))

Top = Maximum induction (%)

Bottom = Minimum induction (%)

LogEC₅₀ = Log of concentration at which 50 % of maximum response is observed

HillSlope = Slope factor or Hill slope

57. Raw data from the luminometer, expressed as Relative Light Units (RLUs), should be transferred to the data analysis spreadsheet designed for the prescreen and comprehensive runs. Raw data should meet the acceptance criteria as indicated in Table 3A and 3B (agonism) or 4A and 4B (antagonism). In case the raw data meet the acceptance criteria, the following calculation steps are performed to determine the required parameters:

Agonism

- Subtract the average RLU of the reference standard solvent control from each of the raw analysis data of the reference standards.
- Subtract the average RLU for the test chemical solvent control from each of the raw analysis data of the test chemicals.
- Calculate the relative induction of each concentration of the reference standard. Set the induction of the highest concentration of the reference standard at 100 %.
- Calculate the relative induction of each concentration of test chemical compared to the highest concentration of the reference standard as 100 %.
- Evaluate the analysis results following non-linear regression (variable slope, 4 parameters).

▼ M8

- Determine the EC_{50} and EC_{10} of the reference standard.

- Determine the EC_{50} and EC_{10} of the test chemicals.

- Determine the maximum relative induction of the test chemical (TC_{max}).

- Determine the PC_{10} and PC_{50} of the test chemicals.

For test chemicals, a full dose-response curve may not always be achieved due to e.g. cytotoxicity or solubility problems. Hence, the EC_{50} , EC_{10} and PC_{50} cannot be determined. In such case, only the PC_{10} and TC_{max} can be determined.

Antagonism

- Subtract the average RLU of the highest reference standard concentration from each of the raw analysis data of the reference standards.

- Subtract the average RLU of the highest reference standard concentration from each of the raw analysis data of the test chemicals.

- Calculate the relative induction of each concentration of the reference standard. Set the induction of the lowest concentration of the reference standard at 100 %.

- Calculate the relative induction of each concentration of test chemical compared to the lowest concentration of the reference standard as 100 %.

- Evaluate the analysis results following non-linear regression (variable slope, 4 parameters).

- Determine the IC_{50} and IC_{20} of the reference standard.

- Determine the IC_{50} and IC_{20} of the test chemicals.

- Determine the minimum relative induction of the test chemical (TC_{min}).

- Determine the PC_{80} and PC_{50} of the test chemicals.

▼ M8

Figure 3

Overview of parameters determined in the agonist assay

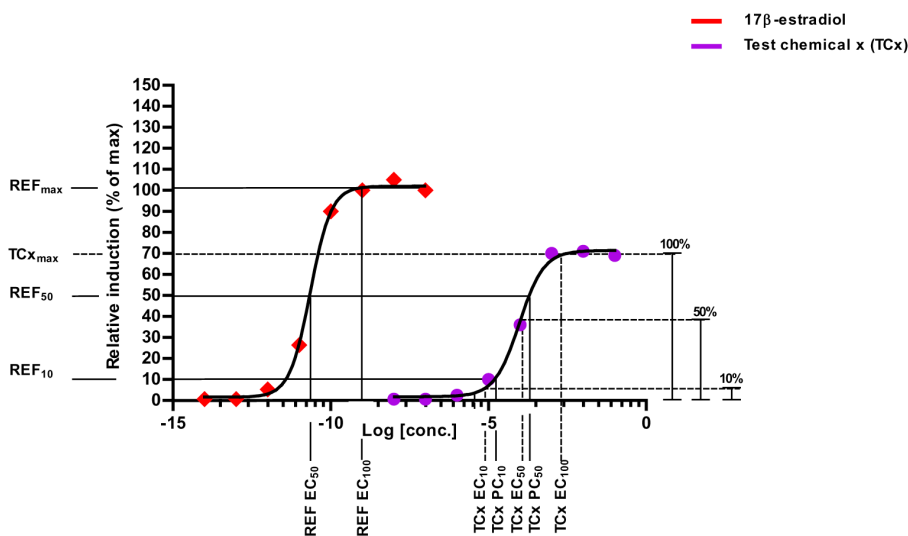

EC_{10} = concentration of a substance at which 10 % of its maximum response is observed.

EC_{50} = concentration of a substance at which 50 % of its maximum response is observed.

PC_{10} = concentration of a test chemical at which its response is equal to the EC_{10} of the reference standard.

PC_{50} = concentration of a test chemical at which its response is equal to the EC_{50} of the reference standard.

TCx_{max} = maximum relative induction of test chemical.

Figure 4

Overview of parameters determined in the antagonist assay

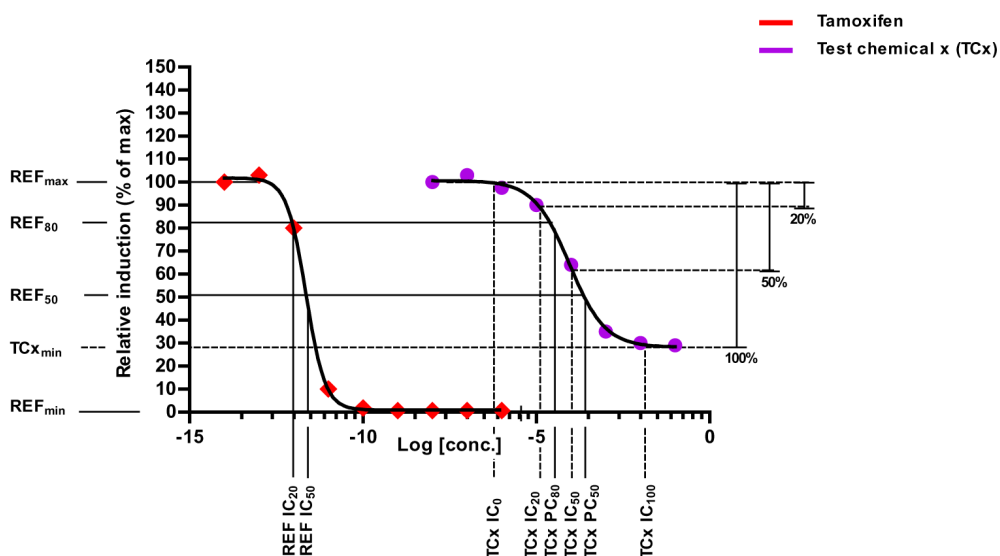

IC_{20} = concentration of a substance at which 80 % of its maximum response is observed (20 % inhibition).

▼M8

IC50 = concentration of a substance at which 50 % of its maximum response is observed (50 % inhibition).

PC80 = concentration of a test chemical at which its response is equal to the IC20 of the reference standard.

PC50 = concentration of a test chemical at which its response is equal to the IC50 of the reference standard.

TCxmin = minimum relative induction of test chemical.

For test chemicals, a full dose-response curve may not always be achieved due to e.g. cytotoxicity or solubility problems. Hence, the IC₅₀, IC₂₀ and PC₅₀ cannot be determined. In such case, only the PC₂₀ and TC_{min} can be determined.

58. The results should be based on two (or three) independent runs. If two runs give comparable and therefore reproducible results, it is not necessary to conduct a third run. To be acceptable, the results should:

- Meet the acceptability criteria (see Acceptability criteria paragraphs 14-22),
- Be reproducible.

Data interpretation criteria

59. For the interpretation of data and the decision whether a test chemical is considered positive or negative, the following criteria are to be used:

Agonism

For each comprehensive run, a test chemical is considered **positive** in case:

- 1 The TC_{max} is equal or exceeds 10 % of the maximum response of the reference standard (REF₁₀).
- 2 At least 2 consecutive concentrations of the test chemical are equal to or exceed the REF₁₀.

For each comprehensive run, a test chemical is considered **negative** in case:

- 1 The TC_{max} does not exceed 10 % of the maximum response of the reference standard (REF₁₀).
- 2 Less than 2 concentrations of the test chemical are equal to or exceed the REF₁₀.

Antagonism

For each comprehensive run, a test chemical is considered **positive** in case:

- 1 The TC_{min} is equal or lower than 80 % of the maximum response of the reference standard (REF₈₀ = 20 % inhibition).
- 2 At least 2 consecutive concentrations of the test chemical are equal to or lower than the REF₈₀.

▼M8

For each comprehensive run, a test chemical is considered **negative** in case:

- 1 The TC_{min} exceeds 80 % of the maximum response of the reference standard (REF80 = 20 % inhibition).
 - 2 Less than 2 concentrations of the test chemical are equal to or lower than the REF80.
60. To characterise the potency of the positive response of a test chemical, the magnitude of the effect (agonism: TC_{max}; antagonism: TC_{min}) and the concentration at which the effect occurs (agonism: EC₁₀, EC₅₀, PC₁₀, PC₅₀; antagonism: IC₂₀, IC₅₀, PC₈₀, PC₅₀) should be reported.

TEST REPORT

61. See paragraph 20 of 'ER TA ASSAY COMPONENTS'

LITERATURE

- (1) OECD (2016). Draft Validation report of the (anti-) ER α CALUX bioassay - transactivation bioassay for the detection of compounds with (anti)estrogenic potential. Environmental Health and Safety Publications, Series on Testing and Assessment (No 240). Organisation for Economic Cooperation and Development, Paris
- (2) Sonneveld E, Jansen HJ, Riteco JA, Brouwer A, van der Burg B. (2005). Development of androgen- and estrogen-responsive bioassays, members of a panel of human cell line-based highly selective steroid-responsive bioassays. *Toxicol. Sci.* 83(1), 136-148.
- (3) Quaedackers ME, van den Brink CE, Wissink S, Schreurs RHMM, Gustafsson JA, van der Saag PT, and van der Burg B. (2001). 4-Hydroxytamoxifen trans-represses nuclear factor-kB Activity in human osteoblastic U2OS cells through estrogen receptor (ER) α and not through ER β . *Endocrinology* 142(3), 1156-1166.
- (4) Thorne N, Inglese J and Auld DS. (2010). Illuminating Insights into Firefly Luciferase and Other Bioluminescent Reporters Used in Chemical Biology, *Chemistry and Biology* 17(6):646-57.
- (5) Escande A, Pillon A, Servant N, Cravedi JP, Larrea F, Muhn P, Nicolas JC, Cavaillès V and Balaguer P. (2006). Evaluation of ligand selectivity using reporter cell lines stably expressing estrogen receptor alpha or beta. *Biochem. Pharmacol.*, 71, 1459-1469.
- (6) Kuiper GG, Lemmen JG, Carlsson B, Corton JC, Safe SH, van der Saag PT, van der Burg B and Gustafsson JA. (1998). Interaction of estrogenic chemicals and phytoestrogens with estrogen receptor beta. *Endocrinol.*, 139, 4252-4263.
- (7) Sotoca AM, Bovee TFH, Brand W, Velikova N, Boeren S, Murk AJ, Vervoort J, Rietjens IMCM. (2010). Superinduction of estrogen receptor mediated gene expression in luciferase based reporter gene assays is mediated by a post-transcriptional mechanism. *J. Steroid. Biochem. Mol. Biol.*, 122, 204–211.
- (8) Sonneveld E, Riteco JAC, Jansen HJ, Pieterse B, Brouwer A, Schoonen WG, and van der Burg B. (2006). Comparison of *in vitro* and *in vivo* screening models for androgenic and estrogenic activities. *Toxicol. Sci.*, 89(1), 173–187.

▼M8

- (9) Kobayashi H, Yamamoto K, Eguchi M, Kubo M, Nakagami S, Wakisaka S, Kaizuka M and Ishii H. (1995). Rapid detection of mycoplasma contamination in cell cultures by enzymatic detection of polymerase chain reaction (PCR) products. *J. Vet. Med. Sci.*, 57(4), 769-771.
- (10) Zhang J-H, Chung TDY, and Oldenburg KR. (1999). A simple statistical parameter for use in evaluation and validation of high throughput screening assays. *J. Biomol. Scr.*, 4, 67-73
- (11) Besselink H, Middelhof I, and Felzel, E. (2014). Transactivation assay for the detection of compounds with (anti)estrogenic potential using ER α CALUX cells. BioDetection Systems BV (BDS). Amsterdam, the Netherlands.

▼ **M8***Appendix 4.1*

VISUAL INSPECTION OF CELL VIABILITY

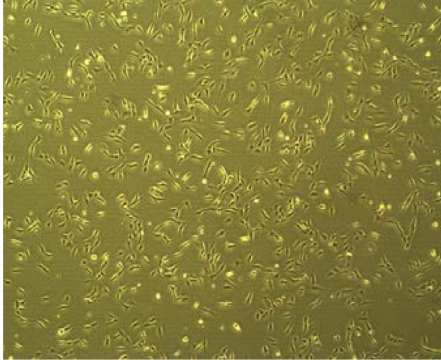

< 5 % confluency. Cells have just been seeded. 100 % cell viability. Classification: 'no cytotoxicity'

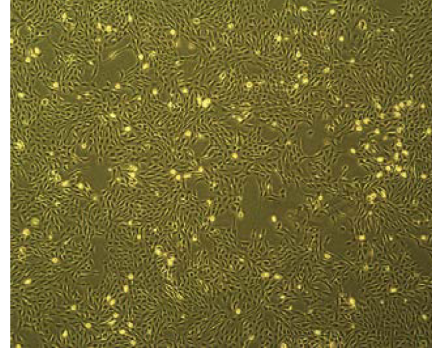

> 85 % confluency. At this stage, cells are exposed to test chemicals. > 95 % cell viability. Classification: 'no cytotoxicity'

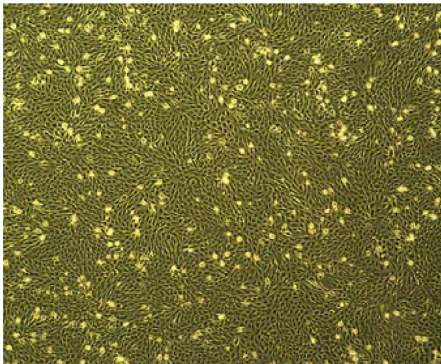

> 95 % confluency. Cells are densely packed and start to overgrow. > 95 % cell viability. Classification: 'no cytotoxicity'

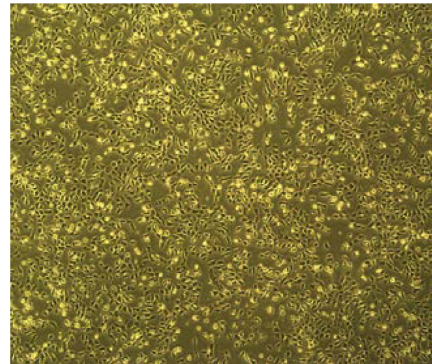

< 25 % cell viability. Cells become detached and contact between cells decreases. Cells are rounded. Classification: 'cytotoxicity'

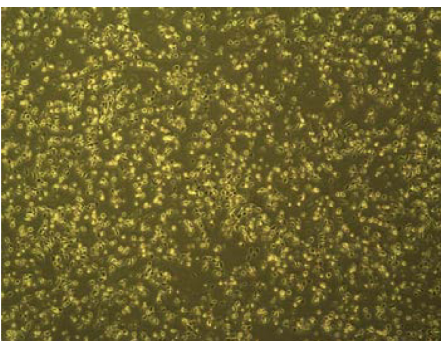

< 5 % cell viability. Cells are fully detached and contact between cells is broken. Cells are rounded. Classification: 'cytotoxicity'

▼ **M8****B.67. *IN VITRO* MAMMALIAN CELL GENE MUTATION TESTS USING THE THYMIDINE KINASE GENE**

INTRODUCTION

1. This test method (TM) is equivalent to the OECD test guideline 490 (2016). Test methods are periodically reviewed and revised in the light of scientific progress, regulatory needs and animal welfare. The mouse lymphoma assay (MLA) and TK6 test using the thymidine kinase (TK) locus were originally contained in test method B.17. Subsequently, the MLA Expert Workgroup of the International Workshop for Genotoxicity Testing (IWGT) has developed internationally harmonised recommendations for assay acceptance criteria and data interpretation for the MLA (1)(2)(3)(4)(5), and these recommendations are incorporated into this new test method B.67. This test method is written for the MLA and, because it also utilises the TK locus, the TK6 test. While the MLA has been widely used for regulatory purposes, the TK6 has been used much less frequently. It should be noted that in spite of the similarity between the endpoints the two cell lines are not interchangeable and regulatory programs may validly express a preference for one over the other for a particular regulatory use. For instance, the validation of the MLA demonstrated its appropriateness for detecting not only gene mutation, but also, the ability of a test chemical to induce structural chromosomal damage. This test method is part of a series of test methods on genetic toxicology. A document that provides succinct information on genetic toxicology testing and an overview of the recent changes that were made to genetic toxicity OECD test guidelines has been developed by OECD (6).

2. The purpose of the *in vitro* mammalian cell gene mutation tests is to detect gene mutations induced by chemicals. The cell lines used in these tests measure forward mutations in reporter genes, specifically the endogenous thymidine kinase gene (*TK* for human cells and *Tk* for rodent cells, collectively referred to as *TK* in this test method). This test method is intended for use with two cell lines: the L5178Y $TK^{+/-}$ -3.7.2C mouse lymphoma cell line (generally called L5178Y) and the TK6 human lymphoblastoid cell line (generally called TK6). Although the two cell lines vary because of their origin, cell growth, p53-status, etc., the *TK* gene mutation tests can be conducted in a similar way in both cell types as described in this test method.

3. The autosomal and heterozygous nature of the thymidine kinase gene enables the detection of viable colonies whose cells are deficient in the enzyme thymidine kinase following mutation from $TK^{+/-}$ to $TK^{-/-}$. This deficiency can result from genetic events affecting the *TK* gene including both gene mutations (point mutations, frame-shift mutations, small deletions, etc.) and chromosomal events (large deletions, chromosome rearrangements and mitotic recombination). The latter events are expressed as loss of heterozygosity, which is a common genetic change of tumor suppressor genes in human tumorigenesis. Theoretically, loss of the entire chromosome carrying the *TK* gene resulting from spindle impairment and/or mitotic non-disjunction can be detected in the MLA. Indeed, a combination of cytogenetic and molecular analysis clearly shows that some MLA TK mutants are the result of nondisjunction. However, the weight of evidence shows that the *TK* gene mutation tests cannot reliably detect aneugens when applying standard cytotoxicity criteria (as described in this test method) and therefore, it is not appropriate to use these tests to detect aneugens (7)(8)(9).

▼M8

4. In the *TK* gene mutation tests, two distinct phenotypic classes of *TK* mutants are generated; the normal growing mutants that grow at the same rate as the *TK* heterozygous cells, and slow growing mutants which grow with prolonged doubling times. The normal growing and slow growing mutants are recognised as large colony and small colony mutants in the MLA and as early appearing colony and late appearing colony mutants in the TK6. The molecular and cytogenetic nature of both large and small colony MLA mutants has been explored in detail (8)(10)(11)(12)(13). The molecular and cytogenetic nature of the early appearing and late appearing TK6 mutants has also been extensively investigated (14)(15)(16)(17). Slow growing mutants for both cell types have suffered genetic damage that involves putative growth regulating gene(s) near the *TK* locus which results in prolonged doubling times and the formation of late appearing or small colonies (18). The induction of slow growing mutants has been associated with chemicals that induce gross structural changes at the chromosomal level. Cells whose damage does not involve the putative growth regulating gene(s) near the *TK* locus grow at rates similar to the parental cells and become normal growing mutants. The induction of primarily normal growing mutants is associated with chemicals primarily acting as point mutagens. Consequently it is essential to count both slow growing and normal growing mutants in order to recover all of the mutants and to provide some insight into the type(s) of damage (mutagens vs. clastogens) induced by the test chemical (10)(12)(18)(19).
5. The test method is organised so as to provide general information that applies to both MLA and TK6 and specialised guidance for the individual tests.
6. Definitions used are provided in Appendix 1.

INITIAL CONSIDERATIONS AND LIMITATIONS

7. Tests conducted *in vitro* generally require the use of an exogenous source of metabolic activation. The exogenous metabolic activation system does not entirely mimic *in vivo* conditions.
8. Care should be taken to avoid conditions that could lead to artefactual positive results (i.e. possible interaction with the test system) not caused by interaction between the test chemical and the genetic material of the cell; such conditions include changes in pH or osmolality, interaction with the medium components (20)(21), or excessive levels of cytotoxicity (22)(23)(24). Cytotoxicity exceeding the recommended top cytotoxicity levels as defined in paragraph 28 is considered excessive for the MLA and TK6. In addition, it should be noted that test chemicals that are thymidine analogues, or behave like thymidine analogues can increase the mutant frequency by selective growth of the spontaneous background mutants during cell treatment and require additional test methods for adequate evaluation (25).
9. For manufactured nanomaterials, specific adaptations of this test method may be needed but are not described in this test method.
10. Before using the test method for testing a mixture to generate data for an intended regulatory purpose, it should be considered whether, and if so why, it may provide adequate results for that purpose. Such considerations are not needed, when there is a regulatory requirement for testing the mixture.

▼M8

11. Mutant cells deficient in thymidine kinase enzyme activity because of a mutation $TK^{+/-}$ to $TK^{-/-}$ are resistant to the cytostatic effects of the pyrimidine analogue trifluorothymidine (TFT). The TK proficient cells are sensitive to TFT, which causes the inhibition of cellular metabolism and halts further cell division. Thus, mutant cells are able to proliferate in the presence of TFT and form visible colonies, whereas cells containing the TK enzyme are not.

PRINCIPLE OF THE TEST

12. Cells in suspension are exposed to the test chemical, both with and without an exogenous source of metabolic activation (see paragraph 19), for a suitable period of time (see paragraph 33), and then sub-cultured to determine cytotoxicity and to allow phenotypic expression prior to mutant selection. Cytotoxicity is determined by relative total growth (RTG—see paragraph 25) for the MLA and by relative survival (RS—see paragraph 26) for TK6. The treated cultures are maintained in growth medium for a sufficient period of time, characteristic of each cell type (see paragraph 37), to allow near-optimal phenotypic expression of induced mutations. Following phenotypic expression, mutant frequency is determined by seeding known numbers of cells in medium containing the selective agent to detect mutant colonies, and in medium without selective agent to determine the cloning efficiency (viability). After a suitable incubation time, colonies are counted. Mutant frequency is calculated based on the number of mutant colonies corrected by the cloning efficiency at the time of mutant selection.

DESCRIPTION OF THE METHOD

Preparations*Cells*

13. For MLA: Because the MLA was developed and characterised using the $TK^{+/-}$ -3.7.2C subline of L5178Y cells, this specific subline has to be used for the MLA. The L5178Y cell line was derived from a methylcholanthrene-induced thymic lymphoma from a DBA-2 mouse (26). Clive and co-workers treated L5178Y cells (designated by Clive as $TK^{+/+}$ -3) with ethylmethane sulfonate and isolated a $TK^{-/-}$ (designated as $TK^{-/-}$ -3.7) clone using bromodeoxyuridine as the selective agent. From the $TK^{-/-}$ clone a spontaneous $TK^{+/-}$ clone (designated as $TK^{+/-}$ -3.7.2.) and a subclone (designated as $TK^{+/-}$ -3.7.2C) were isolated and characterised for use in the MLA (27). The karyotype for the cell line has been published (28)(29)(30)(31). The modal chromosome number is 40. There is one meta-centric chromosome (t12;13) that should be counted as one chromosome. The mouse TK locus is located on the distal end of chromosome 11. The L5178Y $TK^{+/-}$ -3.7.2C cell line has mutations in both p53 alleles and produces mutant-p53 protein (32) (33). The p53 status of the $TK^{+/-}$ -3.7.2C cell line is likely responsible for the ability of the test to detect large-scale damage (17).

14. For TK6: The TK6 is a human lymphoblastoid cell line. The parent cell line is an Epstein-Barr virus-transformed cell line, WI-L2, which was originally derived from a 5-year-old male with hereditary spherocytosis. The first isolated clone, HH4, was mutagenised with ICR191 and a TK heterozygous cell line, TK6, was generated (34). TK6 cells are nearly diploid and the representative karyotype is 47, XY, 13+, t(14; 20), t(3; 21) (35). The human TK locus is located on the long arm of chromosome 17. The TK6 is a p53-competent cell line, because it has a wild-type p53 sequence in both alleles and expresses only wild-type p53 protein (36).

▼M8

15. For both the MLA and the TK6, when first establishing or replenishing a master stock, it is advisable for the testing laboratory to assure the absence of *Mycoplasma* contamination, karyotype the cells or paint the chromosomes harboring the *TK* locus, and to check population doubling times. The normal cell cycle time for the cells used in the testing laboratory should be established and should be consistent with published cell characteristics (16)(19)(37). This master stock should be stored at -150° C or below and used to prepare all working cell stocks.

16. Either prior to establishing a large number of cryopreserved working stocks or just prior to use in an experiment, the culture may need to be cleansed of pre-existing mutant cells [unless the solvent control mutant frequency (MF) is already within the acceptable range—see Table 2 for the MLA)]. This is accomplished using methotrexate (aminopterin) to select against TK-deficient cells and adding thymidine, hypoxanthine and glycine (L5178Y) or 2'-deoxycytidine (TK6) to the culture to ensure optimal growth of the TK-competent cells (19)(38)(39), and (40) for TK6). General advice on good practice for the maintenance of cell cultures as well as specific advice for L5178Y and TK6 cells can be found in (19)(31)(37)(39)(41). For laboratories requiring master cell stocks to initiate either the MLA or TK6 or to obtain new master cell stocks, a cell repository of well characterised cells is available (37).

Media and culture conditions

17. For both tests, appropriate culture medium and incubation conditions (e.g. culture vessels, humidified atmosphere of 5 % CO₂, incubation temperature of 37°C) should be used for maintaining cultures. Cell cultures should always be maintained under conditions that ensure that they are growing in log phase. It is particularly important to choose media and culture conditions that ensure optimal growth of cells during the expression period and cloning for both mutant and non-mutant cells. For the MLA and the TK6, it is also important that the culture conditions ensure optimal growth of both the large colony/early appearing and the small colony/late appearing TK mutants. More culture details, including the need to properly heat inactivate horse serum if RPMI medium is used during mutant selection can be found in (19)(31)(38)(39)(40)(42).

Preparation of cultures

18. Cells are propagated from stock cultures, seeded in culture medium at a density such that the suspension cultures will continue to grow exponentially through the treatment and expression periods.

Metabolic activation

19. Exogenous metabolising systems should be used when employing L5178Y and TK6 cells because they have inadequate endogenous metabolic capacity. The most commonly used system that is recommended by default unless otherwise justified, is a co-factor-supplemented post-mitochondrial fraction (S9) prepared from the livers of rodents (generally rats) treated with enzyme-inducing agents such as Aroclor 1254 (43)(44)(45) or a combination of phenobarbital and β-naphthoflavone (46)(47)(48)(49)(50)(51). The latter combination does not conflict with the Stockholm Convention on Persistent

▼ M8

Organic Pollutants (52) and has been shown to be as effective as Aroclor 1254 for inducing mixed-function oxidases (45)(46)(47)(48)(49). The S9 fraction typically is used at concentrations ranging from 1-2 % but may be increased to 10 % (v/v) in the final test medium. The choice of type and concentration of exogenous metabolic activation system or metabolic inducer employed may be influenced by the class of test chemicals.

Test chemical preparations

20. Solid test chemicals should be prepared in appropriate solvents and diluted, if appropriate, prior to treatment of the cells (see paragraph 21). Liquid test chemicals may be added directly to the test system and/or diluted prior to treatment of the test system. Gaseous or volatile test chemicals should be tested by appropriate modifications to the standard protocols, such as treatment in sealed culture vessels (53)(54)(55). Preparations of the test chemical should be made just prior to treatment unless stability data demonstrate the acceptability of storage.

TEST CONDITIONS

Solvents

21. The solvent should be chosen to optimise the solubility of the test chemical without adversely impacting the conduct of the test, e.g. changing cell growth, affecting the integrity of the test chemical, reacting with culture vessels, impairing the metabolic activation system. It is recommended that, wherever possible, the use of an aqueous solvent (or culture medium) should be considered first. Well established solvents are water or dimethyl sulfoxide. Generally organic solvents should not exceed 1 % (v/v) and aqueous solvents (saline or water) should not exceed 10 % (v/v) in the final treatment medium. If other than well-established solvents are used (e.g. ethanol or acetone), their use should be supported by data indicating their compatibility with the test chemicals, the test system and their lack of genetic toxicity at the concentration used. In the absence of that supporting data, it is important to add untreated controls (see Appendix 1, Definitions) to demonstrate that no deleterious or mutagenic effects are induced by the chosen solvent.

MEASURING CYTOTOXICITY AND CHOOSING TREATMENT CONCENTRATIONS

22. When determining the highest test chemical concentration, concentrations that have the capability of producing artefactual positive responses, such as those producing excessive cytotoxicity (see paragraph 28), precipitation (see paragraph 29) in the culture medium, or marked changes in pH or osmolality (see paragraph 8), should be avoided. If the test chemical causes a marked change in the pH of the medium at the time of addition, the pH might be adjusted by buffering the final treatment medium so as to avoid artefactual positive results and to maintain appropriate culture conditions.
23. Concentration selection is based on cytotoxicity and other considerations (see paragraphs 27-30). While the evaluation of cytotoxicity in an initial test may be useful to better define the concentrations to be used in the main experiment, an initial test is not required. Even if an initial cytotoxicity evaluation is performed, the measurement of cytotoxicity for each culture is still required in the main experiment. If a range finding experiment is conducted, it should cover a wide range of concentrations and can either be terminated at day 1 after treatment or carried through the 2 day expression and to mutant selection (should it appear that the concentrations used are appropriate).

▼M8

24. Cytotoxicity should be determined for each individual test culture and control culture: methods for MLA (2) and the TK6 (15) are defined by internationally agreed practice.

25. For both the agar and microwell versions of the MLA: Cytotoxicity should be evaluated using relative total growth (RTG) which was originally defined by Clive and Spector in 1975 (2). This measure includes the relative suspension growth (RSG: test culture vs. solvent control) during the cell treatment, the expression time and the relative cloning efficiency (RCE: test culture vs. solvent control) at the time that mutants are selected (2). It should be noted that the RSG includes any cell loss occurring in the test culture during treatment (See Appendix 2 for formulae).

26. For TK6: Cytotoxicity should be evaluated using relative survival (RS) i.e. cloning efficiency of cells plated immediately after treatment, adjusted for any cell loss during treatment, based on cell count as compared to the negative control (assigned a survival of 100 %) (See Appendix 2 for the formula).

27. At least four test concentrations (not including the solvent and positive controls) that meet the acceptability criteria (appropriate cytotoxicity, number of cells, etc) should be evaluated. While the use of duplicate cultures is advisable, either replicate or single treated cultures may be used at each concentration tested. The results obtained for replicate cultures at a given concentration should be reported separately but can be pooled for the data analysis (55). For test chemicals demonstrating little or no cytotoxicity, concentration intervals of approximately 2 to 3 fold will usually be appropriate. Where cytotoxicity occurs, concentrations should be selected to cover the cytotoxicity range from that producing cytotoxicity as described in paragraph 28 and including concentrations at which there is moderate and little or no cytotoxicity. Many test chemicals exhibit steep concentration response curves and in order to cover the whole range of cytotoxicity or to study the concentration response in detail, it may be necessary to use more closely spaced concentrations and more than four concentrations, in particular in situations where a repeat experiment is required (see paragraph 70). The use of more than 4 concentrations may be particularly important when using single cultures.

28. If the maximum concentration is based on cytotoxicity, the highest concentration should aim to achieve between 20 and 10 % RTG for the MLA, and between 20 and 10 % RS for the TK6 (paragraph 67).

29. For poorly soluble test chemicals that are not cytotoxic at concentrations below the lowest insoluble concentration, the highest concentration analysed should produce turbidity or a precipitate visible by eye or with the aid of an inverted microscope at the end of the treatment with the test chemical. Even if cytotoxicity occurs above the lowest insoluble concentration, it is advisable to test at only one concentration producing turbidity or with a visible precipitate because artifactual effects may result from the precipitate. Because the MLA and TK6 use suspension cultures, particular care should be taken to assure that the precipitate does not interfere with the conduct of the test. The determination of solubility in the culture medium prior to the experiment may also be useful.

▼M8

30. If no precipitate or limiting cytotoxicity is observed, the highest test concentration should correspond to 10 mM, 2 mg/ml or 2 µl/ml, whichever is the lowest (57)(58). When the test chemical is not of defined composition e.g. substance of unknown or variable composition, complex reaction products or biological materials [i.e. Chemical Substances of unknown or Variable Composition (UVCBs)], environmental extracts etc., the top concentration, may need to be higher (e.g. 5 mg/ml), in the absence of sufficient cytotoxicity, to increase the concentration of each of the components. It should be noted however that these requirements may differ for human pharmaceuticals (59).

Controls

31. Concurrent negative controls (see paragraph 21), consisting of the solvent alone in the treatment medium and handled in the same way as the treatment cultures, should be included for every experimental condition.
32. Concurrent positive controls are needed to demonstrate the ability of the laboratory to identify mutagens under the conditions of the test protocol used, the effectiveness of the exogenous metabolic activation system (when applicable), and to demonstrate adequate detection of both small/late appearing and large/early appearing *TK* mutants. Examples of positive controls are given in the table 1 below. Alternative positive control substances can be used, if justified. Because *in vitro* mammalian cell tests for genetic toxicity are sufficiently standardised for short-term treatments (3-4 hours) done concurrently with and without metabolic activation using the same treatment duration, the use of positive controls may be confined to a mutagen requiring metabolic activation. In this case, this single positive control response will demonstrate both the activity of the metabolic activation system and the responsiveness of the test system. If used, long term treatment (i.e. 24 hours without S9) should however have its own positive control, as the treatment duration will differ from the test using metabolic activation. Each positive control should be used at one or more concentrations expected to give reproducible and detectable increases over background in order to demonstrate the sensitivity of the test system, and the response should not be compromised by cytotoxicity exceeding the limits specified in this TM (see paragraph 28).

Table 1

Reference substances recommended for assessing laboratory proficiency and for selection of positive controls

Category	Substance	CASRN
1. Mutagens active without metabolic activation		
	Methyl methanesulphonate	66-27-3
	Mitomycin C	50-07-7
	4-Nitroquinoline-N-Oxide	56-57-5
2. Mutagens requiring metabolic activation		
	Benzo(a)pyrene	50-32-8
	Cyclophosphamide (monohydrate)	50-18-0(6055-19-2)
	7,12-Dimethylbenzanthracene	57-97-6
	3-Methylcholanthrene	56-49-5

▼ M8**PROCEDURE****Treatment with test chemical**

33. Proliferating cells are treated with the test chemical in the presence and absence of a metabolic activation system. Exposure should be for a suitable period of time (usually 3 to 4 hours is adequate). It should be noted however that these requirements may differ for human pharmaceuticals (59). For MLA, in cases where the short-term treatment yields negative results, and there is information suggesting the need for longer treatment [e.g. nucleoside analogs, poorly soluble chemicals, (5)(59)], consideration should be given to conducting the test with longer treatment, i.e. 24 hours without S9.

34. The minimum number of cells used for each test (control and treated) culture at each stage in the test should be based on the spontaneous mutant frequency. A general guide is to treat and passage sufficient cells in each experimental culture so as to maintain at least 10 but ideally 100 spontaneous mutants in all phases of the test (treatment, phenotypic expression and mutant selection) (56).

35. For MLA the recommended acceptable spontaneous mutant frequency is between $35-140 \times 10^{-6}$ (agar version) and $50-170 \times 10^{-6}$ (microwell version) (see Table 2). To have at least 10 and ideally 100 spontaneous mutants surviving treatment for each test culture, it is necessary to treat at least 6×10^6 cells. Treating this number of cells, and maintaining sufficient cells during expression and cloning for mutant selection, provides for a sufficient number of spontaneous mutants (10 or more) during all phases of the experiment, even for the cultures treated at concentrations that result in 90 % cytotoxicity (as measured by an RTG of 10 %) (19)(38)(39).

36. For the TK6, the spontaneous mutant frequency is generally between 2 and 10×10^{-6} . To have at least 10 spontaneous mutants surviving treatment for each culture, it is necessary to treat at least 20×10^6 cells. Treating this number of cells provides for a sufficient number of spontaneous mutants (10 or more) even for the cultures treated at concentrations that cause 90 % cytotoxicity during treatment (10 % RS). In addition a sufficient number of cells must be cultured during the expression period and plated for mutant selection (60).

Phenotypic expression time and measurement of cytotoxicity and mutant frequency

37. At the end of the treatment period, cells are cultured for a defined time to allow near optimal phenotypic expression of newly induced mutants; specific to each cell line. For the MLA, the phenotypic expression period is 2 days. For the TK6, the phenotypic expression period is 3-4 days. If a 24 hr treatment is used, the expression period begins after the end of treatment.

38. During the phenotypic expression period, cells are enumerated on a daily basis. For the MLA the daily cell counts are used to calculate the daily suspension growth (SG). Following the 2 day expression period, cells are suspended in medium with and without selective agent for the determination of the numbers of mutants (selection plates) and for cloning efficiency (viability plates), respectively. For MLA there are two equally acceptable methods for mutant selection cloning; one using soft agar and the other using liquid medium in 96-well plates (19) (38) (39). Cloning in the TK6 is conducted using liquid media and 96-well plates (16).

▼ M8

39. Trifluorothymidine (TFT) is the only recommended selective agent for *TK* mutants (61).

40. For the MLA, agar plates and microwell plates are counted after 10-12 days incubation. For the TK6, colonies in microwell plates are scored after 10-14 days for the early appearing mutants. In order to recover the slow growing (late appearing) TK6 mutants, it is necessary to re-feed the cells with growth medium and TFT after counting the early appearing mutants and then to incubate the plates for an additional 7-10 days (62). See paragraphs 42 & 44 for a discussion concerning the enumeration of the slow and normal growth *TK* mutants.

41. The appropriate calculations for the two tests including the two methods (agar and microwell) for the MLA are in Appendix 2. For the agar method of the MLA, colonies are counted and the number of mutant colonies adjusted by the cloning efficiency to calculate a MF. For the microwell version of the MLA and the TK6, cloning efficiency both for the selection and cloning efficiency plates is determined according to the Poisson distribution (63). The MF is calculated from these two cloning efficiencies.

Mutant Colony characterisation

42. For the MLA, if the test chemical is positive (see paragraphs 62-63), colony characterisation by colony sizing or growth should be performed on at least one of the test cultures (generally the highest acceptable positive concentration) and on the negative and positive controls. If the test chemical is negative (see paragraph 64), mutant colony characterisation should be performed on the negative and positive controls. For the microwell method of the MLA, small colony mutants are defined as those covering less than 25 % of the well's diameter and large colony mutants as those that cover more than 25 % of the well's diameter. For the agar method, an automatic colony counter is used to enumerate the mutant colonies and for colony sizing. Approaches to colony sizing are detailed in the literature (19)(38)(40). Colony characterisation on the negative and positive control is needed to demonstrate that the studies are adequately conducted.

43. The test chemical cannot be determined to be negative if the both the large and small colony mutants are not adequately detected in the positive control. Colony characterisation can be used to provide general information concerning the ability of the test chemical to cause point mutations and/or chromosomal events (paragraph 4).

44. TK6: Normal growing and slow growing mutants are differentiated by a difference in incubation time (see paragraph 40). For the TK6 generally both the early and late appearing mutants are scored for all of the cultures including the negative and positive controls. Colony characterisation of the negative and positive control is needed to demonstrate that the studies are adequately conducted. The test chemical cannot be determined to be negative if both the early appearing and late appearing mutants are not adequately detected in the positive control. Colony characterisation can be used to provide general information concerning the ability of the test chemical to cause point mutations and/or chromosomal events (paragraph 4).

▼M8**Proficiency of the laboratory**

45. In order to demonstrate sufficient experience with the test prior to using it for routine testing, the laboratory should have performed a series of experiments with reference positive substances acting via different mechanisms (at least one active with and one active without metabolic activation selected from the substances listed in Table 1) and various negative controls (including untreated cultures and various solvents/vehicles). These positive and negative control responses should be consistent with the literature. This requirement is not applicable to laboratories that have experience, i.e. that have an historical data base available as defined in paragraphs 47-50. For the MLA the values obtained for both positive and negative controls should be consistent with the IWGT recommendations (see Table 2).
46. A selection of positive control substances (see Table 1) should be investigated with short and long treatments (if using long treatments) in the absence of metabolic activation, and also with short treatment in the presence of metabolic activation, in order to demonstrate proficiency to detect mutagenic chemicals, to determine the effectiveness of the metabolic activation system and to demonstrate the appropriateness of the cell growth conditions during treatment, phenotypic expression and mutant selection and of the scoring procedures. A range of concentrations of the selected substances should be chosen so as to give reproducible and concentration-related increases above the background in order to demonstrate the sensitivity and dynamic range of the test system.

Historical control data

47. The laboratory should establish:
- A historical positive control range and distribution,
 - A historical negative (untreated, solvent) control range and distribution.
48. When first acquiring data for an historical negative control distribution, concurrent negative controls should be consistent with published negative control data. As more experimental data are added to the control distribution, concurrent negative controls should ideally be within the 95 % control limits of that distribution (64)(65).
49. The laboratory's historical negative control database should initially be built with a minimum of 10 experiments but would preferably consist of at least 20 experiments conducted under comparable experimental conditions. Laboratories should use quality control methods, such as control charts (e.g. C-charts or X-bar charts (65), to identify how variable their positive and negative control data are, and to show that the methodology is 'under control' in their laboratory (66). Further details and recommendations on how to build and use the historical data can be found in the literature (64).
50. Negative control data should consist of mutant frequencies from single or preferably replicate cultures as described in paragraph 27. Concurrent negative controls should ideally be within the 95 % control limits of the distribution of the laboratory's historical negative control database. Where negative control data fall outside the 95 % control limit they may be acceptable for inclusion in the historical control distribution as long as these data are not extreme outliers, there is evidence that the test system is 'under control' (see paragraph 49) and there is evidence of no technical or human failure.

▼M8

51. Any changes to the experimental protocol should be considered in terms of the consistency of the data with the laboratory's existing historical control databases. Any major inconsistencies should result in the establishment of a new historical control database.

DATA AND REPORTING

Presentation of the results

52. The presentation of data for both the MLA and TK6 should include, for both treated and control cultures, data required for the calculation of cytotoxicity (RTG or RS, respectively) and mutant frequencies, as described below.
53. For MLA, individual culture data should be provided for RSG, RTG, the cloning efficiency at the time of mutant selection and the number of mutant colonies (for agar version) or number of empty wells (for microwell version). MF should be expressed as number of mutant cells per million surviving cells. If the response is positive, small and large colony MFs (and/or percentage of the total MF) should be given for at least one concentration of the test chemical (generally the highest positive concentration) and the negative and positive controls. In the case of a negative response, the small and large colony MF should be given for the negative control and the positive control.
54. For TK6, individual culture data should be provided for RS, the cloning efficiency at the time of mutant selection and the number of empty wells for early appearing and late appearing mutants. MF should be expressed as number of mutant cells per number of surviving cells, and should include the total MF as well as the MF (and/or percentage of the total MF) of the early and late appearing mutants.

Acceptability Criteria

55. For both the MLA and the TK6 the following criteria should be met before determining the overall results for a specific test chemical:
 - Two experimental conditions (short treatment with and without metabolic activation see paragraph 33) were conducted unless one resulted in positive results.
 - Adequate number of cells and concentrations should be analysable (see paragraphs 27, 34-36).
 - The criteria for the selection of top concentration are consistent with those described in paragraphs 28-30.

Acceptability criteria for negative and positive controls

56. The IWGT Expert MLA Workgroup analysis of an extensive amount of MLA data resulted in international consensus for specific acceptability criteria for the MLA (1)(2)(3)(4)(5). Therefore, this test method provides specific recommendations for determining the acceptability of negative and positive controls and for evaluating individual substance results in the MLA. The TK6 has a much smaller database and has not undergone evaluation by a workgroup.

▼M8

57. For MLA, every experiment should be evaluated as to whether the untreated/solvent control meets the IWGT MLA Workgroup acceptance criteria ((4) and Table 2, below) for the: (1) MF (note that the IWGT acceptable MFs are different for the agar and microwell versions of the MLA), (2) cloning efficiency (CE) at the time of mutant selection and (3) suspension growth (SG) for the solvent control (see Appendix 2 for formulae).

Table 2

Acceptability criteria for the MLA

Parameter	Soft Agar Method	Microwell Method
Mutant Frequency	$35 - 140 \times 10^{-6}$	$50 - 170 \times 10^{-6}$
Cloning Efficiency	65 – 120 %	65 – 120 %
Suspension Growth	8 – 32 fold (3-4 hour treatment)32 – 180 fold (24 hour treatment, if conducted)	8 – 32 fold (3-4 hour treatment)32 – 180 fold (24 hour treatment, if conducted)

58. For MLA, every test should also be evaluated as to whether the positive control(s) meets at least one of the following two acceptance criteria developed by the IWGT workgroup:

— The positive control should demonstrate an absolute increase in total MF, that is, an increase above the spontaneous background MF [an induced MF (IMF)] of at least 300×10^{-6} . At least 40 % of the IMF should be reflected in the small colony MF.

— The positive control has an increase in the small colony MF of at least 150×10^{-6} above that seen in the concurrent untreated/solvent control (a small colony IMF of 150×10^{-6}).

59. For the TK6, a test will be acceptable if the concurrent negative control is considered acceptable for addition to the laboratory historical negative control database as described in paragraphs 48-49. In addition, the concurrent positive controls (see paragraph 32) should induce responses that are compatible with those generated in the historical positive control data base and produce a statistically significant increase compared with the concurrent negative control.

60. For both tests, the upper limit of cytotoxicity observed in the positive control culture should be the same as of the experimental cultures. That is, the RTG/RS should not be less than 10 %. It is sufficient to use a single concentration (or one of the concentrations of the positive control cultures if more than one concentration is used) to demonstrate that the acceptance criteria for the positive control have been satisfied. Further, the MF of the positive control must be within the acceptable range established for the laboratory.

Evaluation and interpretation of results

61. For the MLA, significant work on biological relevance and criteria for a positive response has been conducted by The Mouse Lymphoma Expert Workgroup of the IWGT (4). Therefore, this test method provides specific recommendations for the interpretation of test chemical results from the

▼M8

MLA (see paragraphs 62-64). The TK6 has a much smaller database and has not undergone evaluation by a workgroup. Therefore, the recommendations for the interpretation of data for the TK6 are given in more general terms (see paragraphs 65-66). Additional recommendations apply to both tests (see paragraphs 67-71).

MLA

62. An approach for defining positive and negative responses is recommended to assure that the increased MF is biologically relevant. In place of statistical analysis generally used for other tests, it relies on the use of a predefined induced mutant frequency (i.e. increase in MF above concurrent control), designated the Global Evaluation Factor (GEF), which is based on the analysis of the distribution of the negative control MF data from participating laboratories (4). For the agar version of the MLA the GEF is 90×10^{-6} and for the microwell version of the MLA the GEF is 126×10^{-6} .
63. Providing that all acceptability criteria are fulfilled, a test chemical is considered to be clearly positive if, in any of the experimental conditions examined (see paragraph 33), the increase in MF above the concurrent background exceeds the GEF and the increase is concentration related (e.g. using a trend test). The test chemical is then considered able to induce mutation in this test system.
64. Providing that all acceptability criteria are fulfilled, a test chemical is considered to be clearly negative if, in all experimental conditions examined (see paragraph 33) there is no concentration related response or, if there is an increase in MF, it does not exceed the GEF. The test chemical is then considered unable to induce mutations in this test system.

TK6

65. Providing that all acceptability criteria are fulfilled, a test chemical is considered to be clearly positive if, in any of the experimental conditions examined (see paragraph 33):
- at least one of the test concentrations exhibits a statistically significant increase compared with the concurrent negative control
 - the increase is concentration-related when evaluated with an appropriate trend test (see paragraph 33)
 - any of the results are outside the distribution of the historical negative control data (e.g. Poisson-based 95 % control limit; see paragraph 48).

When all of these criteria are met, the test chemical is then considered able to induce mutation in this test system. Recommendations for the most appropriate statistical methods can be found in the literature (66)(67).

66. Providing that all acceptability criteria are fulfilled, a test chemical is considered clearly negative if, in all experimental conditions examined (see paragraph 33):
- none of the test concentrations exhibits a statistically significant increase compared with the concurrent negative control,
 - there is no concentration-related increase when evaluated with an appropriate trend test

▼M8

- all results are inside the distribution of the historical negative control data (e.g. Poisson-based 95 % control limit; see paragraph 48).

The test chemical is then considered unable to induce mutations in this test system.

For both the MLA and TK6:

67. If the maximum concentration is based on cytotoxicity, the highest concentration should aim to achieve between 20 and 10 % RTG/RS. The consensus is that care should be taken when interpreting positive results only found between 20 and 10 % RTG/RS and a result would not be considered positive if the increase in MF occurred only at or below 10 % RTG/RS (if evaluated) (2)(59).
68. There are some circumstances under which additional information may assist in determining that a test chemical is not mutagenic when there is no culture showing an RTG value between 10-20 % RTG/RS. These situations are outlined as follows: (1) There is no evidence of mutagenicity (e.g. no dose response, no mutant frequencies above those seen in the concurrent negative control or historical background ranges, etc.) in a series of data points within 100 % to 20 % RTG/RS and there is at least one data point between 20 and 25 % RTG/RS. (2) There is no evidence of mutagenicity (e.g. no dose response, no mutant frequencies above those seen in the concurrent negative control or historical background ranges, etc.) in a series of data points between 100 % to 25 % RTG/RS and there is also a negative data point slightly below 10 % RTG/RS. In both of these situations the test chemical can be concluded to be negative.
69. There is no requirement for verification of a clearly positive or negative response.
70. In cases when the response is neither clearly negative nor clearly positive as described above and/or in order to assist in establishing the biological relevance of a result the data should be evaluated by expert judgement and/or further investigations. Performing a repeat experiment possibly using modified experimental conditions [e.g. concentration spacing to increase the probability of attaining data points within the 10-20 % RTG/RS range, using other metabolic activation conditions (i.e. S9 concentration or S9 origin) and duration of treatment] could be useful.
71. In rare cases, even after further investigations, the data set will preclude making a conclusion of positive or negative results. Therefore the test chemical response should be concluded to be equivocal (interpreted as equally likely to be positive or negative).

TEST REPORT

72. The test report should include the following information:

Test chemical:

- source, lot number, limit date for use, if available;
- stability of the test chemical itself, if known;
- solubility and stability of the test chemical in solvent, if known;

▼M8

- measurement of pH, osmolality, and precipitate in the culture medium to which the test chemical was added, as appropriate.

Mono-constituent substance:

- physical appearance, water solubility, and additional relevant physico-chemical properties;
- chemical identification, such as IUPAC or CAS name, CAS number, SMILES or InChI code, structural formula, purity, chemical identity of impurities as appropriate and practically feasible, etc.

Multi-constituent substance, UVCBs and mixtures:

- characterised as far as possible by chemical identity (see above), quantitative occurrence and relevant physicochemical properties of the constituents.

Solvent:

- justification for choice of solvent;
- percentage of solvent in the final culture medium.

Cells:

For Laboratory master cultures:

- type and source of cells, and history in the testing laboratory;
- karyotype features and/or modal number of chromosomes;
- methods for maintenance of cell cultures;
- absence of mycoplasma;
- cell doubling times.

Test conditions:

- rationale for selection of concentrations and number of cell cultures; including e.g. cytotoxicity data and solubility limitations;
- composition of media, CO₂ concentration, humidity level;
- concentration of test chemical expressed as final concentration in the culture medium (e.g. µg or mg/ml or mM of culture medium);
- concentration (and/or volume) of solvent and test chemical added in the culture medium;
- incubation temperature;
- incubation time;
- duration of treatment;
- cell density during treatment;

▼M8

- type and composition of metabolic activation system (source of S9, method of preparation of the S9 mix, the concentration or volume of S9 mix and S9 in the final culture medium, quality controls of S9);
- positive and negative control substances, final concentrations for each conditions of treatment;
- length of expression period (including number of cells seeded, and subcultures and feeding schedules, if appropriate);
- identity of the selective agent and its concentration;
- for the MLA, the version used (agar or microwell) should be indicated
- criteria for acceptability of the tests;
- methods used to enumerate numbers of viable and mutant cells;
- methods used for the measurements of cytotoxicity;
- any supplementary information relevant to cytotoxicity and method used;
- duration of incubation times after plating;
- definition of colonies of which size and type are considered (including criteria for ‘small’ and ‘large’ colonies, as appropriate);
- criteria for considering studies as positive, negative or equivocal;
- methods used to determine pH, osmolality, if performed and precipitation if relevant.

Results:

- number of cells treated and number of cells sub-cultured for each culture;
- toxicity parameters (RTG for MLA and RS for TK6);
- signs of precipitation and time of the determination;
- number of cells plated in selective and non-selective medium;
- number of colonies in non-selective medium and number of resistant colonies in selective medium and related mutant frequencies;
- colony sizing for the negative and positive controls and if the test chemical is positive, at least one concentration, and related mutant frequencies;
- concentration-response relationship, where possible;
- concurrent negative (solvent) and positive control data (concentrations and solvents);
- historical negative (solvent) and positive control data (concentrations and solvents) with ranges, means and standard deviations; number of tests upon which the historical controls are based;

▼M8

- statistical analyses (for individual cultures and pooled replicates if appropriate), and p-values if any; and for the MLA, the GEF evaluation.

*Discussion of the results**Conclusion***LITERATURE**

- (1) Moore, M.M., Honma, M., Clements, J. (Rapporteur), Awogi, T., Bolcsfoldi, G., Cole, J., Gollapudi, B., Harrington-Brock, K., Mitchell, A., Muster, W., Myhr, B., O'Donovan, M., Ouldelhkim, M-C., San, R., Shimada, H. and Stankowski, L.F. Jr. (2000). Mouse Lymphoma Thymidine Kinase Locus (TK) Gene Mutation Assay: International Workshop on Genotoxicity Test Procedures (IWGTP) Workgroup Report, *Environ. Mol. Mutagen.*, 35 (3): 185-190.
- (2) Moore, M.M., Honma, M., Clements, J., Harrington-Brock, K., Awogi, T., Bolcsfoldi, G., Cifone, M., Collard, D., Fellows, M., Flanders, K., Gollapudi, B., Jenkinson, P., Kirby, P., Kirchner, S., Kraycer, J., McEnaney, S., Muster, W., Myhr, B., O'Donovan, M., Oliver, Ouldelhkim, M-C., Pant, K., Preston, R., Riach, C., San, R., Shimada, H. and Stankowski, L.F. Jr. (2002). Mouse Lymphoma Thymidine Kinase Locus Gene Mutation Assay: Follow-Up International Workshop on Genotoxicity Test Procedures, New Orleans, Louisiana, (April 2000), *Environ. Mol. Mutagen.*, 40 (4): 292-299.
- (3) Moore, M.M., Honma, M., Clements, J., Bolcsfoldi, G., Cifone, M., Delongchamp, R., Fellows, M., Gollapudi, B., Jenkinson, P., Kirby, P., Kirchner, S., Muster, W., Myhr, B., O'Donovan, M., Ouldelhkim, M-C., Pant, K., Preston, R., Riach, C., San, R., Stankowski, L.F. Jr., Thakur, A., Wakuri, S. and Yoshimura, I. (2003). Mouse Lymphoma Thymidine Kinase Locus Gene Mutation Assay: International Workshop (Plymouth, UK) on Genotoxicity Test Procedures Workgroup Report, *Mutation Res.*, 540: 127-140.
- (4) Moore, M.M., Honma, M., Clements, J., Bolcsfoldi, G., Burlinson, B., Cifone, M., Clarke, J., Delongchamp, R., Durward, R., Fellows, M., Gollapudi, B., Hou, S., Jenkinson, P., Lloyd, M., Majeska, J., Myhr, B., O'Donovan, M., Omori, T., Riach, C., San, R., Stankowski, L.F. Jr., Thakur, A.K., Van Goethem, F., Wakuri, S. and Yoshimura, I. (2006). Mouse Lymphoma Thymidine Kinase Gene Mutation Assay: Follow-Up Meeting of the International Workshop on Genotoxicity Tests – Aberdeen, Scotland, 2003 – Assay Acceptance Criteria, Positive Controls, and Data Evaluation, *Environ. Mol. Mutagen.*, 47 (1): 1-5.
- (5) Moore, M.M., Honma, M., Clements, J., Bolcsfoldi, G., Burlinson, B., Cifone, M., Clarke, J., Clay, P., Doppalapudi, R., Fellows, M., Gollapudi, B., Hou, S., Jenkinson, P., Muster, W., Pant, K., Kidd, D.A., Lorge, E., Lloyd, M., Myhr, B., O'Donovan, M., Riach, C., Stankowski, L.F. Jr., Thakur A.K. and Van Goethem, F. (2007). Mouse Lymphoma Thymidine Kinase Mutation Assay: Meeting of the International Workshop on Genotoxicity Testing, San Francisco, 2005, Recommendations for 24-h Treatment, *Mutation. Res.*, 627 (1): 36-40.
- (6) OECD (2016). Overview of the set of OECD Genetic Toxicology Test Guidelines and updates performed in 2014-2015. ENV Publications. Series on Testing and Assessment, No 234, OECD, Paris.
- (7) Fellows M.D., Luker, T., Cooper, A. and O'Donovan, M.R. (2012). Unusual Structure-Genotoxicity Relationship in Mouse Lymphoma Cells Observed with a Series of Kinase Inhibitors. *Mutation, Res.*, 746 (1): 21-28.
- (8) Honma, M., Momose, M., Sakamoto, H., Sofuni, T. and Hayashi, M. (2001). Spindle Poisons Induce Allelic Loss in Mouse Lymphoma Cells Through Mitotic Non-Disjunction. *Mutation Res.*, 493 (1-2): 101-114.

▼M8

- (9) Wang, J., Sawyer, J.R., Chen, L., Chen, T., Honma, M., Mei, N. and Moore, M.M. (2009). The Mouse Lymphoma Assay Detects Recombination, Deletion, and Aneuploidy, *Toxicol. Sci.*, 109 (1): 96-105.
- (10) Applegate, M.L., Moore, M.M., Broder, C.B., Burrell, A., and Hozier, J.C. (1990). Molecular Dissection of Mutations at the Heterozygous Thymidine Kinase Locus in Mouse Lymphoma Cells. *Proc. National Academy. Sci. USA*, 87 (1): 51-55.
- (11) Hozier, J., Sawyer, J., Moore, M., Howard, B. and Clive, D. (1981). Cytogenetic Analysis of the L5178Y/TK^{+/-} Leads to TK^{-/-} Mouse Lymphoma Mutagenesis Assay System, *Mutation Res.*, 84 (1): 169-181.
- (12) Hozier, J., Sawyer, J., Clive, D. and Moore, M.M. (1985). Chromosome 11 Aberrations in Small Colony L5178Y TK^{-/-} Mutants Early in their Clonal History, *Mutation Res.*, 147 (5): 237-242.
- (13) Moore, M.M., Clive, D., Hozier, J.C., Howard, B.E., Batson, A.G., Turner, N.T. and Sawyer, J. (1985). Analysis of Trifluorothymidine-Resistant (TFT^r) Mutants of L5178Y/TK^{+/-} Mouse Lymphoma Cells. *Mutation Res.*, 151 (1): 161-174.
- (14) Liber H.L., Call K.M. and Little J.B. (1987). Molecular and Biochemical Analyses of Spontaneous and X-Ray-Induced Mutants in Human Lymphoblastoid Cells. *Mutation Res.*, 178 (1): 143-153.
- (15) Li C.Y., Yandell D.W. and Little J.B. (1992). Molecular Mechanisms of Spontaneous and Induced Loss of Heterozygosity in Human Cells *In Vitro*. *Somat. Cell Mol. Genet.*, 18 (1): 77-87.
- (16) Honma M., Hayashi M. and Sofuni T. (1997). Cytotoxic and Mutagenic Responses to X-Rays and Chemical Mutagens in Normal and P53-Mutated Human Lymphoblastoid Cells. *Mutation. Res.*, 374 (1): 89-98.
- (17) Honma, M., Momose, M., Tanabe, H., Sakamoto, H., Yu, Y., Little, J.B., Sofuni, T. and Hayashi, M. (2000). Requirement of Wild-Type P53 Protein for Maintenance of Chromosomal Integrity. *Mol. Carcinogen.*, 28 (4): 203-14.
- (18) Amundson S.A. and Liber H.L. (1992). A Comparison of Induced Mutation at Homologous Alleles of the TK Locus in Human Cells. II. Molecular Analysis of Mutants. *Mutation Res.*, 267 (1): 89-95.
- (19) Schisler M.R., Moore M.M. and Gollapudi B.B. (2013). *In Vitro* Mouse Lymphoma (L5178Y TK^{+/-} -3.7.2C) Forward Mutation Assay. In *Protocols in Genotoxicity Assessment A. Dhawan and M. Bajpayee (Eds.), Springer Protocols, Humana Press: 27-50.*
- (20) Long, L.H., Kirkland, D., Whitwell, J. and Halliwell, B. (2007). Different Cytotoxic and Clastogenic Effects of Epigallocatechin Gallate in Various Cell-Culture Media Due to Variable Rates of its Oxidation in the Culture Medium, *Mutation Res.*, 634 (1-2): 177-183.
- (21) Nesslany, F., Simar-Meintieres, S., Watzinger, M., Talahari, I. and Marzin, D. (2008). Characterization of the Genotoxicity of Nitrotriacetic Acid. *Environ. Mol. Mutagen.*, 49 (6): 439-452.
- (22) Brusick D. (1986). Genotoxic Effects in Cultured Mammalian Cells Produced by Low pH Treatment Conditions and Increased Ion Concentrations. *Environ. Mutagen.*, 8 (6): 879-886.
- (23) Morita, T., Nagaki, T., Fukuda, I. and Okumura, K. (1992). Clastogenicity of Low pH to Various Cultured Mammalian Cells. *Mutation Res.*, 268 (2): 297-305.

▼M8

- (24) Scott, D., Galloway, S.M., Marshall, R.R., Ishidate, M.Jr, Brusick, D., Ashby, J. and Myhr, B.C. (1991). Genotoxicity under Extreme Culture Conditions. A report from ICPEMC Task Group 9. *Mutation Res.*, 257: 147-204.
- (25) Wang J., Heflich R.H. and Moore M.M. (2007). A Method to Distinguish Between the *De Novo* Induction of Thymidine Kinase Mutants and the Selection of Pre-Existing Thymidine Kinase Mutants in the Mouse Lymphoma Assay. *Mutation Res.*, 626 (1-2): 185-190.
- (26) Fischer, G.A. (1958). Studies on the Culture of Leukemic Cells *In Vitro*. *Ann. N.Y. Academy Sci.*, 76: 673-680.
- (27) Clive, D., Johnson, K.O., Spector, J.F.S., Batson, A.G. and Brown, M.M.M. (1979). Validation and Characterization of the L5178Y/TK+/- Mouse Lymphoma Mutagen Assay System. *Mutation Res.*, 59(1): 61-108.
- (28) Sawyer, J., Moore, M.M., Clive, D. and Hozier, J. (1985). Cytogenetic Characterization of the L5178Y TK^{+/-} 3.7.2C Mouse Lymphoma Cell Line, *Mutation Res.*, 147 (5): 243-253.
- (29) Sawyer J.R., Moore M.M. and Hozier J.C. (1989). High-Resolution Cytogenetic Characterization of the L5178Y TK^{+/-} Mouse Lymphoma Cell Line, *Mutation Res.*, 214 (2): 181-193.
- (30) Sawyer, J.R., Binz, R.L., Wang, J. and Moore, M.M. (2006). Multicolor Spectral Karyotyping of the L5178Y TK^{+/-}-3.7.2C Mouse Lymphoma Cell Line, *Environ. Mol. Mutagen.*, 47 (2): 127-131.
- (31) Fellows, M.D., McDermott, A., Clare, K.R., Doherty, A. and Aardema, M.J. (2014). The Spectral Karyotype of L5178Y TK^{+/-} Mouse Lymphoma Cells Clone 3.7.2C and Factors Affecting Mutant Frequency at the Thymidine Kinase (TK) Locus in the Microtitre Mouse Lymphoma Assay, *Environ. Mol. Mutagen.*, 55 (1): 35-42.
- (32) Storer, R.D., Jraynak, A.R., McKelvey, T.W., Elia, M.C., Goodrow, T.L. and DeLuca, J.G. (1997). The Mouse Lymphoma L5178Y TK^{+/-} Cell Line is Heterozygous for a Codon 170 Mutation in the P53 Tumor Suppressor Gene. *Mutation. Res.*, 373 (2): 157-165.
- (33) Clark L.S., Harrington-Brock, K., Wang, J., Sargent, L., Lowry, D., Reynolds, S.H. and Moore, M.M. (2004). Loss of P53 Heterozygosity is not Responsible for the Small Colony Thymidine Kinase Mutant Phenotype in L5178Y Mouse Lymphoma Cells. *Mutagen.*, 19 (4): 263-268.
- (34) Skopek T.R., Liber, H.L., Penman, B.W. and Thilly, W.G. (1978). Isolation of a Human Lymphoblastoid Line Heterozygous at the Thymidine Kinase Locus: Possibility for a Rapid Human Cell Mutation Assay. *Biochem. Biophys. Res. Commun.*, 84 (2): 411-416.
- (35) Honma M. (2005). Generation of Loss of Heterozygosity and its Dependency on P53 Status in Human Lymphoblastoid Cells. *Environ. Mol. Mutagen.*, 45 (2-3): 162-176.
- (36) Xia, F., Wang, X., Wang, Y.H., Tsang, N.M., Yandell, D.W., Kelsey, K.T. and Liber, H.L. (1995). Altered P53 Status Correlates with Differences in Sensitivity to Radiation-Induced Mutation and Apoptosis in Two Closely Related Human Lymphoblast Lines. *Cancer. Res.*, 55 (1): 12-15.

▼M8

- (37) Lorge, E., M. Moore, J. Clements, M. O Donovan, M. Honma, A. Kohara, J. van Benthem, S. Galloway, M.J. Armstrong, V. Thybaud, B. Gollapudi, M. Aardema, J. Kim, A. Sutter, D.J. Kirkland (2015). Standardized Cell Sources and Recommendations for Good Cell Culture Practices in Genotoxicity Testing. (Manuscript in preparation).
- (38) Lloyd M. and Kidd D. (2012). The Mouse Lymphoma Assay. Springer Protocols: Methods in Molecular Biology 817, Genetic Toxicology Principles and Methods, ed. Parry and Parry, Humana Press. ISBN, 978-1-61779-420-9, 35-54.
- (39) Mei N., Guo X. and Moore M.M. (2014). Methods for Using the Mouse Lymphoma Assay to Screen for Chemical Mutagenicity and Photo-Mutagenicity. In: Optimization in Drug Discover: *In Vitro* Methods: Yan Z and Caldwell(Eds), 2nd Edition, GW; Humana Press, Totowa, NJ.
- (40) Liber H.L. and Thilly W.G. (1982). Mutation Assay at the Thymidine Kinase Locus in Diploidhuman Lymphoblasts. *Mutation Res.*, 94 (2): 467-485.
- (41) Coecke, S., Balls, M., Bowe, G., Davis, J., Gstraunthaler, G., Hartung, T., Hay, R., Merten, OW., Price, A., Schechtman, L., Stacey, G. and Stokes, W. (2005). Guidance on Good Cell Culture Practice. A Report of the Second ECVAM Task Force on Good Cell Culture Practice. *ATLA*, 33 (3): 261-287.
- (42) Moore M.M. and Howard B.E. (1982). Quantitation of Small Colony Trifluorothymidine-Resistant Mutants of L5178Y/TK+/- Mouse Lymphoma Cells in RPMI-1640 Medium, *Mutation Res.*, 104 (4-5): 287-294.
- (43) Ames B.N., McCann J. and Yamasaki E. (1975). Methods for Detecting Carcinogens and Mutagens with the Salmonella/Mammalian Microsome Mutagenicity Test. *Mutation Res.*, 31 (6): 347-364.
- (44) Maron D.M. and Ames B.N. (1983). Revised Methods for the Salmonella Mutagenicity Test. *Mutation Res.*, 113 (3-4): 173-215.
- (45) Natarajan, A.T., Tates, A.D, Van Buul, P.P.W., Meijers, M. and De Vogel, N. (1976). Cytogenetic Effects of Mutagens/Carcinogens After Activation in a Microsomal System *In Vitro*, I. Induction of Chromosomal Aberrations and Sister Chromatid Exchanges by Diethylnitrosamine (DEN) and Dimethylnitrosamine (DMN) in CHO Cells in the Presence of Rat-Liver Microsomes. *Mutation Res.*, 37 (1): 83-90.
- (46) Matsuoka A., Hayashi M. and Ishidate M. Jr. (1979). Chromosomal Aberration Tests on 29 Chemicals Combined with S9 Mix *In Vitro*. *Mutation Res.*, 66 (3): 277-290.
- (47) Ong T.M., *et al.* (1980). Differential Effects of Cytochrome P450-Inducers on Promutagen Activation Capabilities and Enzymatic Activities of S-9 from Rat Liver, *J. Environ. Pathol. Toxicol.*, 4 (1): 55-65
- (48) Elliott, B.M., Combes, R.D., Elcombe, C.R., Gatehouse, D.G., Gibson, G.G., Mackay, J.M. and Wolf, R.C. (1992). Report of UK Environmental Mutagen Society Working Party. Alternatives to Aroclor 1254-Induced S9 in *In Vitro* Genotoxicity Assays. *Mutagen.*, 7 (3): 175-177.
- (49) Matsushima, T., Sawamura, M., Hara, K. and Sugimura, T. (1976). A Safe Substitute for Polychlorinated Biphenyls as an Inducer of Metabolic Activation Systems. In: *In Vitro* Metabolic Activation in Mutagenesis Testing. de Serres F.J., *et al.* (Eds, Elsevier, North-Holland, pp. 85-88.

▼M8

- (50) Galloway S.M., *et al.* (1994). Report from Working Group on *In Vitro* Tests for Chromosomal Aberrations. *Mutation Res.*, 312 (3): 241-261.
- (51) Johnson T.E., Umbenhauer D.R. and Galloway S.M. (1996). Human Liver S-9 Metabolic Activation: Proficiency in Cytogenetic Assays and Comparison with Phenobarbital/Beta-Naphthoflavone or Aroclor 1254 Induced Rat S-9, *Environ. Mol. Mutagen.*, 28 (1): 51-59.
- (52) UNEP (2001). Stockholm Convention on Persistent Organic Pollutants, United Nations Environment Programme (UNEP).
- (53) Krahn D.F., Barsky F.C. and McCooey K.T. (1982). CHO/HGPRT Mutation Assay: Evaluation of Gases and Volatile Liquids. In: *Genotoxic Effects of Airborne Agents* Tice R.R., Costa D.L. and Schaich K.M. (Eds.). New York, Plenum, pp. 91-103.
- (54) Zamora, P.O., Benson, J.M., Li, A.P. and Brooks, A.L. (1983). Evaluation of an Exposure System Using Cells Grown on Collagen Gels for Detecting Highly Volatile Mutagens in the CHO/HGPRT Mutation Assay. *Environ. Mutagen.*, 5 (6): 795-801.
- (55) Asakura M., Sasaki T., Sugiyama T., Arito H., Fukushima, S. and Matsushima, T. (2008). An Improved System for Exposure of Cultured Mammalian Cells to Gaseous Compounds in the Chromosomal Aberration Assay. *Mutation Res.*, 652 (2): 122-130.
- (56) Arlett C.F., *et al.* (1989). Mammalian Cell Gene Mutation Assays Based upon Colony Formation. In: *Statistical Evaluation of Mutagenicity Test Data*, Kirkland, D.J. (Ed.), Cambridge University Press, pp. 66-101.
- (57) Morita T., Honma M. and Morikawa K. (2012). Effect of Reducing the Top Concentration Used in the *In Vitro* Chromosomal Aberration Test in CHL Cells on the Evaluation of Industrial Chemical Genotoxicity. *Mutation Res.*, 741 (1-2): 32-56.
- (58) Brookmire L., Chen J.J. and Levy D.D. (2013). Evaluation of the Highest Concentrations Used in the *In Vitro* Chromosome Aberrations Assay. *Environ. Mol. Mutagen.*, 54 (1): 36-43.
- (59) USFDA (2012). International Conference on Harmonisation (ICH) Guidance S2 (R1) on Genotoxicity Testing and Data Interpretation for Pharmaceuticals Intended For Human Use. Available at: [<https://www.federalregister.gov/a/2012-13774>].
- (60) Honma M. and Hayashi M. (2011). Comparison of *In Vitro* Micro-nucleus and Gene Mutation Assay Results for P53-Competent Versus P53-Deficient Human Lymphoblastoid Cells. *Environ. Mol. Mutagen.*, 52 (5): 373-384.
- (61) Moore-Brown, M.M., Clive, D., Howard, B.E., Batson, A.G. and Johnson, K.O. (1981). The Utilization of Trifluorothymidine (TFT) to Select for Thymidine Kinase-Deficient (TK^{-/-}) Mutants from L5178Y/TK^{+/-} Mouse Lymphoma Cells, *Mutation Res.*, 85 (5): 363-378.
- (62) Liber H.L., Yandell D.W. and Little J.B. (1989). A Comparison of Mutation Induction at the TK and HRPT Loci in Human Lymphoblastoid Cells; Quantitative Differences are Due to an Additional Class of Mutations at the Autosomal TK locus. *Mutation Res.*, 216 (1): 9-17.
- (63) Furth E.E., Thilly, W.G., Penman, B.W., Liber, H.L. and Rand, W.M. (1981). Quantitative Assay for Mutation in Diploid Human Lymphoblasts Using Microtiter Plates. *Anal. Biochem.*, 110 (1): 1-8.
- (64) Hayashi, M., Dearfield, K., Kasper, P., Lovell, D., Martus, H. J. and Thybaud, V. (2011). Compilation and Use of Genetic Toxicity Historical Control Data, *Mutation Res.*, 723 (2): 87-90.

▼M8

- (65) Ryan T.P. (2000). *Statistical Methods for Quality Improvement*. John Wiley and Sons, New York 2nd Edition.
- (66) OECD (2014). *Statistical analysis supporting the revision of the genotoxicity Test Guidelines*. Environmental, Health and Safety Publications, Series on Testing and Assessment (No 199.), Organisation for Economic Cooperation and Development, Paris.
- (67) Fleiss J.L., Levin B. and Paik M.C. (2003). *Statistical Methods for Rates and Proportions*, Third Edition, New York: John Wiley & Sons.

▼ M8*Appendix 1*

DEFINITIONS

Aneugen: Any chemical or process that, by interacting with the components of the mitotic and meiotic cell division cycle, leads to aneuploidy in cells or organisms.

Aneuploidy: Any deviation from the normal diploid (or haploid) number of chromosomes by a single chromosome or more than one, but not by entire set(s) of chromosomes (polyploidy).

Base-pair-substitution mutagens: Chemicals that cause substitution of base pairs in the DNA.

Chemical: A substance or a mixture.

Cloning efficiency: The percentage of cells plated at a low density that are able to grow into a colony that can be counted.

Clastogen: Any chemical or process which causes structural chromosomal aberrations in populations of cells or organisms.

Cytotoxicity: For the assays covered in this test method, cytotoxicity is identified as a reduction in relative total growth (RTG) or relative survival (RS) for the MLA and TK6, respectively.

Forward mutation: A gene mutation from the parental type to the mutant form which gives rise to an alteration or a loss of the enzymatic activity or the function of the encoded protein.

Frameshift mutagens: Chemicals which cause the addition or deletion of single or multiple base pairs in the DNA molecule.

Genotoxic: A general term encompassing all types of DNA or chromosomal damage, including DNA breakage, adducts, rearrangements, mutations, chromosome aberrations, and aneuploidy. Not all types of genotoxic effects result in mutations or stable chromosomal damage.

Mitotic recombination: During mitosis, recombination between homologous chromatids possibly resulting in the induction of DNA double strand breaks or in a loss of heterozygosity.

Mutagenic: Produces a heritable change of DNA base-pair sequences(s) in genes or of the structure of chromosomes (chromosome aberrations).

Mutant frequency (MF): The number of mutant cells observed divided by the number of viable cells.

Phenotypic expression time: The time after treatment during which the genetic alteration is fixed within the genome and any pre-existing gene products are depleted to the point that the phenotypic trait is altered.

Relative survival (RS): RS is used as the measure of treatment-related cytotoxicity in the TK6. It is the relative cloning efficiency (CE) of cells plated immediately after the cell treatment adjusted by any loss of cells during treatment as compared with the cloning efficiency of the negative control.

▼ M8

Relative suspension growth (RSG): For the MLA, the relative total two day suspension growth of the test culture compared to the total two-day suspension growth of the negative/solvent control (Clive and Spector, 1975). The RSG should include the relative growth of the test culture compared to the negative/solvent control during the treatment period.

Relative total growth (RTG): RTG is used as the measure of treatment-related cytotoxicity in the MLA. It is a measure of relative (to the vehicle control) growth of test cultures during the treatment, two-day expression and mutant selection cloning phases of the test. The RSG of each test culture is multiplied by the relative cloning efficiency of the test culture at the time of mutant selection and expressed relative to the cloning efficiency of the negative/solvent control (Clive and Spector, 1975).

S9 liver fractions: Supernatant of liver homogenate after 9 000g centrifugation, i.e. raw liver extract

S9 mix: Mix of the liver S9 fraction and cofactors necessary for metabolic enzyme activity.

Suspension growth (SG): The fold-increase in the number of cells over the course of the treatment and expression phases of the MLA. The SG is calculated by multiplying the fold-increase on day 1 by the fold-increase on day 2 for the short (3 or 4 hr) treatment. If a 24 hr treatment is used the SG is the fold-increase during the 24 hr treatment multiplied by the fold increases on expression days 1 and 2.

Solvent control: General term to define the control cultures receiving the solvent alone used to dissolve the test chemical.

Test chemical: Any substance or mixture tested using this test method.

Untreated controls: Untreated controls are cultures that receive no treatment (i.e. neither test chemical nor solvent) but are processed the same way as the cultures receiving the test chemical.

▼M8*Appendix 2*

FORMULAS

Cytotoxicity

For both versions (agar and microwell) of the MLA

Cytotoxicity is defined as the Relative Total Growth (RTG) which includes the Relative Suspension Growth (RSG) during the 2 day expression period and the Relative Cloning Efficiency (RCE) obtained at the time of mutant selection. RTG, RSG and RCE are all expressed as a percentage.

Calculation of RSG: Suspension Growth one (SG_1) is the growth rate between day 0 and day 1 (cell concentration at day 1 / cell concentration at day 0) and Suspension Growth two (SG_2) is the growth rate between day 1 and day 2 (cell concentration at day 2 / cell concentration at day 1). The RSG is the total SG ($SG_1 \times SG_2$) for the treated culture compared to the untreated/solvent control. That is: $RSG = [SG_{1(test)} \times SG_{2(test)}] / [SG_{1(control)} \times SG_{2(control)}]$ The SG_1 should be calculated from the initial cell concentration used at the beginning of cell treatment. This accounts for any differential cytotoxicity that occurs in the test culture(s) during the cell treatment.

RCE is the relative cloning efficiency of the test culture compared to the relative cloning efficiency of the untreated/solvent control obtained at the time of mutant selection.

Relative Total Growth (RTG): $RTG = RSG \times RCE$

TK6

Relative Survival (RS):

Cytotoxicity is evaluated by relative survival, i.e. cloning efficiency (CE) of cells plated immediately after treatment adjusted by any loss of cells during treatment as compared with cloning efficiency in the negative controls (assigned a survival of 100 %). The adjustment for cell loss during treatment can be calculated as:

$$\text{Adjusted CE} = \text{CE} \times \frac{\text{Number of cells at the end of treatment}}{\text{Number of cells at the beginning of treatment}}$$

The RS for a culture treated by a test chemical is calculated as:

$$RS = \frac{\text{Adjusted CE in the treated culture}}{\text{Adjusted CE in the solvent control}} \times 100$$

Mutant frequency for both the MLA and TK6

Mutant frequency (MF) is the cloning efficiency of mutant colonies in selective medium (CE_M) adjusted by the cloning efficiency in non-selective medium at the time of mutant selection (CE_V). That is, $MF = CE_M / CE_V$. The calculation of these two cloning efficiencies is described below for the agar and microwell cloning methods.

▼ M8

MLA Agar Version: In the soft agar version of the MLA, the number of colonies on the mutant selection plate (C_M) and number of colonies on the unselected or cloning efficiency (viable count) plate (C_V) are obtained by directly counting the clones. When 600 cells are plated for cloning efficiency (CE) for the mutant selection (CE_M) plates and the unselected or cloning efficiency (viable count) plates (CE_V) and 3×10^6 cells are used for mutant selection,

$$CE_M = C_M / (3 \times 10^6) = (C_M / 3) \times 10^{-6}$$

$$CE_V = C_V / 600$$

MLA and TK6 Microwell Version: In the microwell version of the MLA, C_M and C_V are determined as the product of the total number of microwells (TW) and the probable number of colonies per well (P) on microwell plates.

$$C_M = P_M \times TW_M$$

$$C_V = P_V \times TW_V$$

From the zero term of the Poisson distribution (Furth et al., 1981), the P is given by

$$P = -\ln (EW / TW)$$

Where, EW is empty wells and TW is total wells. Therefore,

$$CE_M = C_M / T_M = (P_M \times TW_M) / T_M$$

$$CE_V = C_V / T_V = (P_V \times TW_V) / T_V$$

For the microwell version of the MLA, small and large colony mutant frequencies will be calculated in an identical manner, using the relevant number of empty wells for small and large colonies.

For TK6, small and large colony mutant frequencies are based on the early appearing and late appearing mutants.

▼M8**B.68. SHORT TIME EXPOSURE IN VITRO TEST METHOD FOR IDENTIFYING i) CHEMICALS INDUCING SERIOUS EYE DAMAGE AND ii) CHEMICALS NOT REQUIRING CLASSIFICATION FOR EYE IRRITATION OR SERIOUS EYE DAMAGE**

INTRODUCTION

1. This test method (TM) is equivalent to OECD test guideline (TG) 491 (2017). The Short Time Exposure (STE) test method is an *in vitro* method that can be used under certain circumstances and with specific limitations for hazard classification and labelling of chemicals (substances and mixtures) that induce serious eye damage as well as those that do not require classification for either serious eye damage or eye irritation, as defined by the United Nations (UN) Globally Harmonized System of Classification and Labelling of Chemicals (GHS) (1) and the European Union (EU) Regulation 1272/2008 on Classification, Labelling and Packaging of Substances and Mixtures (CLP) (1).
2. For many years, the eye hazard potential of chemicals has been evaluated primarily using an *in vivo* rabbit eye test (TM B.5 (8), equivalent to OECD TG 405). It is generally accepted that, in the foreseeable future, no single *in vitro* alternative test will be able to fully replace the *in vivo* rabbit eye test to predict across the full range of serious eye damage/eye irritation responses for different chemical classes. However, strategic combinations of alternative test methods used in a (tiered) testing strategy may well be able to fully replace the rabbit eye test (2). The top-down approach is designed for the testing of chemicals that can be expected, based on existing information, to have a high irritancy potential or induce serious eye damage. Conversely, the bottom-up approach is designed for the testing of chemicals that can be expected, based on existing information, not to cause sufficient eye irritation to require a classification. While the STE test method is not considered to be a complete replacement for the *in vivo* rabbit eye test, it is suitable for use as part of a tiered testing strategy for regulatory classification and labelling, such as the top-down/bottom-up approach, to identify without further testing (i) chemicals inducing serious eye damage (UN GHS/CLP Category 1) and (ii) chemicals (excluding highly volatile substances and all solid chemicals other than surfactants) that do not require classification for eye irritation or serious eye damage (UN GHS/CLP No Category) (1)(2). However, a chemical that is neither predicted to cause serious eye damage (UN GHS/CLP Category 1) nor UN GHS/CLP No Category (does not induce either serious eye damage or eye irritation) by the STE test method would require additional testing to establish a definitive classification. Furthermore, the appropriate regulatory authorities should be consulted before using the STE in a bottom-up approach under classification schemes other than the UN GHS/CLP. The choice of the most appropriate test method and the use of this test method should be seen in the context of the OECD Guidance Document on an Integrated Approaches on Testing and Assessment for Serious Eye Damage and Eye irritation (14).
3. The purpose of this test method is to describe the procedures used to evaluate the eye hazard potential of a test chemical based on its ability to induce cytotoxicity in the Short Time Exposure Test method. The cytotoxic

(1) Regulation (EC) No 1272/2008 of the European Parliament and of the Council of 16 December 2008 on classification, labelling and packaging of substances and mixtures, amending and repealing Directives 67/548/EEC and 1999/45/EC, and amending Regulation (EC) No 1907/2006, OJ L 353/1, 31.12.2008

▼M8

effect of chemicals on corneal epithelial cells is an important mode of action (MOA) leading to corneal epithelium damage and eye irritation. Cell viability in the STE test method is assessed by the quantitative measurement, after extraction from cells, of blue formazan salt produced by the living cells by enzymatic conversion of the vital dye MTT (3-(4,5-Dimethylthiazol-2-yl)-2,5-diphenyltetrazolium bromide), also known as Thiazolyl Blue Tetrazolium Bromide (3). The obtained cell viability is compared to the solvent control (relative viability) and used to estimate the potential eye hazard of the test chemical. A test chemical is classified as UN GHS/CLP Category 1 when both the 5 % and 0,05 % concentrations result in a cell viability smaller than or equal to (\leq) 70 %. Conversely, a chemical is predicted as UN GHS/CLP No Category when both 5 % and 0,05 % concentrations result in a cell viability higher than ($>$) 70 %.

4. The term ‘test chemical’ is used in this test method to refer to what is tested and is not related to the applicability of the STE test method to the testing of substances and/or mixtures. Definitions are provided in the Appendix.

INITIAL CONSIDERATIONS AND LIMITATIONS

5. This test method is based on a protocol developed by Kao Corporation (4), which was the subject of two different validation studies: one by the Validation Committee of the Japanese Society for Alternative to Animal Experiments (JSAAE) (5) and another by the Japanese Center for the Validation of Alternative Methods (JaCVAM) (6). A peer review was conducted by NICEATM/ICCVAM based on the validation study reports and background review documents on the test method (7).
6. When used to identify chemicals (substances and mixtures) inducing serious eye damage (UN GHS/CLP Category 1 (1)), data obtained with the STE test method on 125 chemicals (including both substances and mixtures), showed an overall accuracy of 83 % (104/125), a false positive rate of 1 % (1/86), and a false negative rate of 51 % (20/39) as compared to the *in vivo* rabbit eye test (7). The false negative rate obtained is not critical in the present context, since all test chemicals that induce a cell viability of \leq 70 % at a 5 % concentration and $>$ 70 % at 0,05 % concentration would be subsequently tested with other adequately validated *in vitro* test methods or, as a last option, in the *in vivo* rabbit eye test, depending on regulatory requirements and in accordance with the sequential testing strategy and weight-of-evidence approaches currently recommended (1) (8). Mainly mono-constituent substances were tested, although a limited amount of data also exist on the testing of mixtures. The test method is nevertheless technically applicable to the testing of multi-constituent substances and mixtures. However, before use of this test method on a mixture for generating data for an intended regulatory purpose, it should be considered whether, and if so why, it may provide adequate results for that purpose. Such considerations are not needed when there is a regulatory requirement for testing of the mixture. The STE test method showed no other specific shortcomings when used to identify test chemicals as UN GHS/CLP Category 1. Investigators could consider using this test method on test chemicals, whereby cell viability \leq 70 % at both 5 % and 0,05 % concentration should be accepted as indicative of a response inducing serious eye damage that should be classified as UN GHS/CLP Category 1 without further testing.

▼M8

7. When used to identify chemicals (substances and mixtures) not requiring classification for eye irritation and serious eye damage (i.e. UN GHS/CLP No Category), data obtained with the STE test method on 130 chemicals (including both substances and mixtures), showed an overall accuracy of 85 % (110/130), a false negative rate of 12 % (9/73), and a false positive rate of 19 % (11/57) as compared to the *in vivo* rabbit eye test (7). If highly volatile substances and solid substances other than surfactants are excluded from the dataset, the overall accuracy improves to 90 % (92/102), the false negative rate to 2 % (1/54), and the false positive to 19 % (9/48) (7). As a consequence, the potential shortcomings of the STE test method when used to identify test chemicals not requiring classification for eye irritation and serious eye damage (UN GHS/CLP No Category) are a high false negative rate for i) highly volatile substances with a vapor pressure over 6 kPa and ii) Solid chemicals (substances and mixtures) other than surfactants and mixtures composed only of surfactants. Such chemicals are excluded from the applicability domain of the STE test method (7).

8. In addition to the chemicals mentioned in paragraphs 6 and 7, the STE test method generated dataset also contains in-house data on 40 mixtures, which when compared to the *in vivo* Draize eye test, showed an accuracy of 88 % (35/40), a false positive rate of 50 % (5/10), and a false negative rate of 0 % (0/30) for predicting mixtures that do not require classification under the UN GHS/CLP classification systems (9). The STE test method can therefore be applied to identify mixtures as UN GHS/CLP No Category in a bottom-up approach with the exception of solid mixtures other than those composed only of surfactants as an extension of its limitation to solid substances. Furthermore, mixtures containing substances with vapour pressure higher than 6kPa should be evaluated with care to avoid potential under-predictions, and should be justified on a case-by-case basis.

9. The STE test method cannot be used for the identification of test chemicals as UN GHS/CLP Category 2, or UN GHS Category 2A (eye irritation) or 2B (mild eye irritation), due to the considerable number of UN GHS/CLP Category 1 chemicals under-predicted as Category 2, 2A, or 2B and UN GHS/CLP No Category chemicals over-predicted as Category 2, 2A, or 2B (7). For this purpose, further testing with another suitable method may be required.

10. The STE test method is suitable for test chemicals that are dissolved or uniformly suspended for at least 5 minutes in physiological saline, 5 % dimethyl sulfoxide (DMSO) in saline, or mineral oil. The STE test method is not suitable for test chemicals that are insoluble or cannot be uniformly suspended for at least 5 minutes in physiological saline, 5 % DMSO in saline, or mineral oil. The use of mineral oil in the STE test method is possible because of the short-time exposure. Therefore, the STE test method is suitable for predicting the eye hazard potential of water-insoluble test chemicals (*e.g.*, long-chain fatty alcohols or ketones) provided that they are miscible in at least one of the three above proposed solvents (4).

▼ **M8**

11. The term ‘test chemical’ is used in this test method to refer to what is being tested ⁽¹⁾ and is not related to the applicability of the STE test method to the testing of substances and/or mixtures.

PRINCIPLE OF THE TEST

12. The STE test method is a cytotoxicity-based *in vitro* assay that is performed on a confluent monolayer of Statens Seruminstitut Rabbit Cornea (SIRC) cells, cultured on a 96-well polycarbonate microplate (4). After five-minute exposure to a test chemical, the cytotoxicity is quantitatively measured as the relative viability of SIRC cells using the MTT assay (4). Decreased cell viability is used to predict potential adverse effects leading to ocular damage.
13. It has been reported that 80 % of a solution dropped into the eye of a rabbit is excreted through the conjunctival sac within three to four minutes, while greater than 80 % of a solution dropped into the human eye is excreted within one to two minutes (10). The STE test method attempts to approximate these exposure times and makes use of cytotoxicity as an endpoint to assess the extent of damage to SIRC cells following a five-minute exposure to the test chemical.

DEMONSTRATION OF PROFICIENCY

14. Prior to routine use of the STE test method described in this test method, laboratories should demonstrate technical proficiency by correctly classifying the eleven substances recommended in Table 1. These substances were selected to represent the full range of responses for serious eye damage or eye irritation based on results of *in vivo* rabbit eye tests (TG 405) and the UN GHS/CLP classification system (1). Other selection criteria included that the substances should be commercially available, that high-quality *in vivo* reference data should be available, and that high-quality *in vitro* data from the STE test method should be available (3). In situations where a listed substance is unavailable or where justifiable, another substance for which adequate *in vivo* and *in vitro* reference data are available could be used provided that the same criteria as described here are used.

Table 1

List of Proficiency Substances

Substance	CASRN	Chemical class ⁽¹⁾	Physical state	<i>In Vivo</i> UN GHS/CLP Cat. ⁽²⁾	Solvent in STE test	STE UN GHS/CLP Cat.
Benzalkonium chloride(10 %, aqueous)	8 001-54-5	Onium compound	Liquid	Category 1	Saline	Category 1
Triton X-100 (100 %)	9 002-93-1	Ether	Liquid	Category 1	Saline	Category 1

⁽¹⁾ In June 2013, the Joint Meeting agreed that where possible, a more consistent use of the term ‘test chemical’ describing what is being tested should now be applied in new and updated test methods.

▼M8

Substance	CASRN	Chemical class ⁽¹⁾	Physical state	<i>In Vivo</i> UN GHS/CLP Cat. ⁽²⁾	Solvent in STE test	STE UN GHS/CLP Cat.
Acid Red 92	18 472-87-2	Heterocyclic compound; Bromine compound; Chlorine compound	Solid	Category 1	Saline	Category 1
Sodium hydroxide	1 310-73-2	Alkali; Inorganic chemical	Solid	Category 1 ⁽³⁾	Saline	Category 1
Butyrolactone	96-48-0	Lactone; Heterocyclic compound	Liquid	Category 2A (Category 2 in CLP)	Saline	No prediction can be made
1-Octanol	111-87-5	Alcohol	Liquid	Category 2A/ B ⁽⁴⁾ (Category 2 in CLP)	Mineral Oil	No prediction can be made
Cyclopentanol	96-41-3	Alcohol; Hydrocarbon, cyclic	Liquid	Category 2A/ B ⁽⁵⁾ (Category 2 in CLP)	Saline	No prediction can be made
2-Ethoxyethyl acetate	111-15-9	Alcohol; Ether	Liquid	No Category	Saline	No Category
Dodecane	112-40-3	Hydrocarbon, acyclic	Liquid	No Category	Mineral Oil	No Category
Methyl isobutyl ketone	108-10-1	Ketone	Liquid	No Category	Mineral Oil	No Category

▼M8

Substance	CASRN	Chemical class ⁽¹⁾	Physical state	<i>In Vivo</i> UN GHS/CLP Cat. ⁽²⁾	Solvent in STE test	STE UN GHS/CLP Cat.
1,1-Dimethylguanidine sulfate	598-65-2	Amidine; Sulfur compound	Solid	No Category	Saline	No Category

⁽¹⁾ Chemical classes were assigned using information obtained from previous NICEATM publications and if not available, using the National Library of Medicine's Medical Subject Headings (MeSH[®]) (via ChemIDplus[®] [National Library of Medicine], available at <http://chem.sis.nlm.nih.gov/chemidplus/>) and structure determinations made by NICEATM.

⁽²⁾ Based on results from the *in vivo* rabbit eye test (OECD TG 405) and using the UN GHS/CLP (1).

⁽³⁾ Classification as Cat.1 is based on skin corrosive potential of 100 % sodium hydroxide (listed as a proficiency chemical with skin corrosive potential in OECD TG 435) and the criterion for UN GHS/CLP category 1 (1).

⁽⁴⁾ Classification as 2A or 2B depends on the interpretation of the UN GHS criterion for distinguishing between these two categories, i.e., 2 out of 6 vs 4 out of 6 animals with effects at day 7 necessary to generate a Category 2A classification. The *in vivo* dataset included 2 studies with 3 animals each. In one study two out of three animals showed effects at day 7 warranting a Cat. 2A classification (11), whereas in the second study all endpoints in all three animals recovered to a score of zero by day 7 warranting a Cat. 2B classification (12).

⁽⁵⁾ Classification as 2A or 2B depends on the interpretation of the UN GHS criterion for distinguishing between these two categories, i.e., 1 out of 3 vs 2 out of 3 animals with effects at day 7 necessary to generate a Category 2A classification. The *in vivo* study included 3 animals. All endpoints apart from corneal opacity and conjunctivae redness in one animal recovered to a score of zero by day 7 or earlier. The one animal that did not fully recover by day 7 had a corneal opacity score of 1 and a conjunctivae redness of 1 (at day 7) that fully recovered at day 14 (11).

Abbreviations: CAS RN = Chemical Abstracts Service Registry Number

PROCEDURE

Preparation of the Cellular Monolayer

15. The rabbit cornea cell line, SIRC should be used for performing the STE test method. It is recommended that SIRC cells are obtained from a well-qualified cell bank, such as American Type Culture Collection CCL60.

16. SIRC cells are cultured at 37° C under 5 % CO₂ and humidified atmosphere in a culture flask containing a culture medium comprising Eagle's minimum essential medium (MEM) supplemented with 10 % fetal bovine serum (FBS), 2 mM L-glutamine, 50–100 units/ml penicillin and 50–100 µg/ml streptomycin. Cells that have become confluent in the culture flask should be separated using trypsin-ethylenediaminetetraacetic acid solution, with or without the use of a cell scraper. Cells are propagated (e.g. 2 to 3 passages) in a culture flask before being employed for routine testing, and should undergo no more than 25 passages from thawing.

17. Cells ready to be used for the STE test are then prepared at the appropriate density and seeded into 96-well plates. The recommended cell seeding density is $6,0 \times 10^3$ cells per well when cells are used four days after seeding, or $3,0 \times 10^3$ cells per well when cells are used five days after seeding, at a culture volume of 200 µl. Cells used for the STE test that are seeded in a culture medium at the appropriate density will reach a confluence of more than 80 % at the time of testing, i.e., four or five days after seeding.

Application of the Test Chemicals and Control Substances

18. The first choice of solvent for dissolving or suspending test chemicals is physiological saline. If the test chemical demonstrates low solubility or cannot be dissolved or suspended uniformly for at least five minutes in saline, 5 % DMSO (CAS#67-68-5) in saline is used as a second choice

▼M8

solvent. For test chemicals that cannot be dissolved or suspended uniformly for at least five minutes in either saline or 5 % DMSO in saline, mineral oil (CAS#8 042-47-5) is used as a third choice solvent.

19. Test chemicals are dissolved or suspended uniformly in the selected solvent at 5 % (w/w) concentration and further diluted by serial 10-fold dilution to 0,5 % and 0,05 % concentration. Each test chemical is to be tested at both 5 % and 0,05 % concentrations. Cells cultured in the 96-well plate are exposed to 200 µl/well of either a 5 % or a 0,05 % concentration of the test chemical solution (or suspension), for five minutes at room temperature. Test chemicals (mono-constituent substances or multi-constituent substances or mixtures) are considered as neat substances and diluted or suspended according to the method, regardless of their purity.
20. The culture medium described in paragraph 16 is used as a medium control in each plate of each repetition. Furthermore, cells are to be exposed also to solvent control samples in each plate of each repetition. The solvents listed in paragraph 18 have been confirmed to have no adverse effects on the viability of SIRC cells.
21. In the STE test method, 0,01 % Sodium lauryl sulfate (SLS) in saline is to be used as a positive control in each plate of each repetition. In order to calculate cell viability of the positive control, each plate of each repetition has to also include a saline solvent control.
22. A blank is necessary to determine compensation for optical density and should be performed on wells containing only phosphate buffered saline, but no calcium and magnesium (PBS-) or cells.
23. Each sample (test chemical at 5 % and 0,05 %, medium control, solvent control, and positive control) should be tested in triplicate in each repetition by exposing the cells to 200 µl of the appropriate test or control chemical for five minutes at room temperature.
24. Benchmark substances are useful for evaluating the ocular irritancy potential of unknown chemicals of a specific chemical or product class, or for evaluating the relative irritancy potential of an ocular irritant within a specific range of irritant responses.

Cell Viability Measurement

25. After exposure, cells are washed twice with 200 µl of PBS and 200 µl of MTT solution (0.5 mg MTT/ml of culture medium) is added. After a two-hour reaction time in an incubator (37° C, 5 % CO₂), the MTT solution is decanted, MTT formazan is extracted by adding 200 µl of 0,04 N hydrochloric acid-isopropanol for 60 minutes in the dark at room temperature, and the absorbance of the MTT formazan solution is measured at 570 nm with a plate reader. Interference of test chemicals with the MTT assay (by colorants or direct MTT reducers) only occurs if significant amount of test chemical is retained in the test system following rinsing after exposure which is the case for 3D Reconstructed human cornea or Reconstructed human epidermis tissues but is not relevant for the 2D cell cultures used for the STE test method.

▼ **M8****Interpretation of Results and Prediction Model**

26. The optical density (OD) values obtained for each test chemical are then used to calculate cell viability relative to the solvent control, which is set at 100 %. The relative cell viability is expressed as a percentage and obtained by dividing the OD of test chemical by the OD of the solvent control after subtracting the OD of blank from both values.

$$\text{Cell viability}(\%) = \frac{(OD_{570} \text{ of test chemical}) - (OD_{570} \text{ of blank})}{(OD_{570} \text{ of solvent control}) - (OD_{570} \text{ of blank})} \times 100$$

Similarly, the relative cell viability of each solvent control is expressed as a percentage and obtained by dividing the OD of each solvent control by the OD of the medium control after subtracting the OD of blank from both values.

27. Three independent repetitions, each containing three replicate wells (*i.e.*, $n=9$), should be performed. The arithmetic mean of the three wells for each test chemical and solvent control in each independent repetition is used to calculate the arithmetic mean of relative cell viability. The final arithmetic mean of the cell viability is calculated from the three independent repetitions.
28. The cell viability cut-off values for identifying test chemicals inducing serious eye damage (UN GHS/CLP Category 1) and test chemicals not requiring classification for eye irritation or serious eye damage (UN GHS/CLP No Category) are given hereafter.

Table 2

Prediction model of the STE test method

Cell viability		UN GHS/CLP Classification	Applicability
At 5 %	At 0,05 %		
> 70 %	> 70 %	No Category	Substances and mixtures, with the exception of: i) highly volatile substances with a vapor pressure over 6 kPa ⁽¹⁾ and ii) Solid chemicals (substances and mixtures) other than surfactants and mixtures composed only of surfactants
≤ 70 %	> 70 %	No prediction can be made	Not applicable
≤ 70 %	≤ 70 %	Category 1	Substances and mixtures ⁽²⁾

⁽¹⁾ Mixtures containing substances with vapour pressure higher than 6kPa should be evaluated with care to avoid potential under-predictions, and should be justified on a case-by-case basis.

⁽²⁾ Based on results obtained mainly with mono-constituent substances, although a limited amount of data also exist on the testing of mixtures. The test method is nevertheless technically applicable to the testing of multi-constituent substances and mixtures. Before use of this test method on a mixture for generating data for an intended regulatory purpose, it should be considered whether, and if so why, it may provide adequate results for that purpose. Such considerations are not needed, when there is a regulatory requirement for testing of the mixture.

▼M8**Acceptance Criteria**

29. Test results are judged to be acceptable when the following criteria are all satisfied:

- a) Optical density of the medium control (exposed to culture medium) should be 0,3 or higher after subtraction of blank optical density.
- b) Viability of the solvent control should be 80 % or higher relative to the medium control. If multiple solvent controls are used in each repetition, each of those controls should show cell viability greater than 80 % to qualify the test chemicals tested with those solvents.
- c) The cell viability obtained with the positive control (0.01 % SLS) should be within two standard deviations of the historical mean. The upper and lower acceptance boundaries for the positive control should be frequently updated i.e., every three months, or each time an acceptable test is conducted in laboratories where tests are conducted infrequently (i.e., less than once a month). Where a laboratory does not complete a sufficient number of experiments to establish a statistically robust positive control distribution, it is acceptable that the upper and lower acceptance boundaries established by the method developer are used, i.e., between 21.1 % and 62.3 % according to its laboratory historical data, while an internal distribution is built during the first routine tests.
- d) Standard deviation of the final cell viability derived from three independent repetitions should be less than 15 % for both 5 % and 0,05 % concentrations of the test chemical.

If one or several of these criteria is not met, the results should be discarded and another three independent repetitions should be conducted.

DATA AND REPORTING**Data**

30. Data for each individual well (e.g., cell viability values) of each repetition as well as overall mean, SD, and classification are to be reported.

Test Report

31. The test report should include the following information:

Test Chemical and Control Substances

- Mono-constituent substance: chemical identification, such as IUPAC or CAS name(s), CAS registry number(s), SMILES or InChI code, structural formula, and/or other identifiers;
- Multi-constituent substance, UVCB and mixture: Characterisation as far as possible by e.g., chemical identity (see above), purity, quantitative occurrence and relevant physicochemical properties (see above) of the constituents, to the extent available;
- Physical state, volatility, pH, LogP, molecular weight, chemical class, and additional relevant physicochemical properties relevant to the conduct of the study, to the extent available;

▼M8

- Purity, chemical identity of impurities as appropriate and practically feasible, etc;
- Treatment prior to testing, if applicable (e.g., warming, grinding);
- Storage conditions and stability to the extent available.

Test Method Conditions and Procedures

- Name and address of the sponsor, test facility and study director;
- Description of the test method used;
- Cell line used, its source, passage number and confluence of cells used for testing;
- Details of test procedure used;
- Number of repetitions and replicates used;
- Test chemical concentrations used (if different than the ones recommended);
- Justification for choice of solvent for each test chemical;
- Duration of exposure to the test chemical (if different than the one recommended);
- Description of any modifications of the test procedure;
- Description of evaluation and decision criteria used;
- Reference to historical positive control mean and Standard Deviation (SD);
- Demonstration of proficiency of the laboratory in performing the test method (e.g. by testing of proficiency substances) or demonstration of reproducible performance of the test method over time.

Results

- For each test chemical and control substance, and each tested concentration, tabulation should be given for the individual OD values per replicate well, the arithmetic mean OD values for each independent repetition, the % cell viability for each independent repetition, and the final arithmetic mean % cell viability and SD over the three repetitions;
- Results for the medium, solvent and positive control demonstrating suitable study acceptance criteria;
- Description of other effects observed;
- The overall derived classification with reference to the prediction model/ decision criteria used.

▼ **M8***Discussion of the Results**Conclusions***LITERATURE**

- (1) United Nations UN (2013). Globally Harmonized System of Classification and Labelling of Chemicals (GHS). Fifth revised edition. New York & Geneva: United Nations Publications. ISBN: 978-92-1-1170 06-1. Available at: http://www.unece.org/trans/danger/publi/ghs/ghs_rev05/05files_e.html
- (2) Scott L, *et al.* (2010). A proposed Eye Irritation Testing Strategy to Reduce and Replace *in vivo* Studies Using Bottom-Up and Top-Down Approaches. *Toxicol. In Vitro* 24, 1-9.
- (3) Mosmann T. (1983). Rapid Colorimetric Assay for Cellular Growth and Survival: Application to 7 Proliferation and Cytotoxicity Assays. *J. Immunol. Methods* 65, 55-63.
- (4) Takahashi Y, *et al.* (2008). Development of the Short Time Exposure (STE) Test: an *In Vitro* Eye Irritation Test Using SIRC Cells. *Toxicol. In Vitro* 22,760-770.
- (5) Sakaguchi H, *et al.* (2011). Validation Study of the Short Time Exposure (STE) Test to Assess the Eye Irritation Potential of Chemicals. *Toxicol. In Vitro* 25,796-809.
- (6) Kojima H, *et al.* (2013). Second-Phase Validation of Short Time Exposure Tests for Assessment of Eye Irritation Potency of Chemicals. *Toxicol. In Vitro* 27, pp.1 855-1 869.
- (7) ICCVAM (2013). Short Time Exposure (STE) Test Method Summary Review Document, NIH. Available at: [http://www.ntp.niehs.nih.gov/iccvam/docs/ocutox_docs/STE-SRD-NICEATM-508.pdf].
- (8) Chapter B.5 of this Annex, Acute Eye Irritation/Corrosion.
- (9) Saito K, *et al.* (2015). Predictive Performance of the Short Time Exposure Test for Identifying Eye Irritation Potential of Chemical Mixtures.
- (10) Mikkelsen TJ, Chrai SS and Robinson JR. (1973). Altered Bioavailability of Drugs in the Eye Due to Drug-Protein Interaction. *J. Pharm. Sci.* 1 648-1 653.
- (11) ECETOC (1998). Eye Irritation Reference Chemicals Data Bank. Technical Report (No 48. (2)), Brussels, Belgium.
- (12) Gautheron P, *et al.* (1992). Bovine Corneal Opacity and Permeability Test: an *In Vitro* Assay of Ocular Irritancy. *Fundam Appl Toxicol.* 18, 442-449.
- (13) OECD (2005). Guidance Document on the Validation and International Acceptance of New or Updated Test Methods for Hazard Assessment. Environmental, Health and Safety Publications, Series on Testing and Assessment (No 34). Organisation for Economic Cooperation and Development, Paris.
- (14) OECD (2017). Guidance Document on an Integrated Approaches on Testing and Assessment for Serious Eye Damage and Eye irritation. Environmental, Health and Safety Publications, Series on Testing and Assessment (No 263). Organisation for Economic Cooperation and Development, Paris.

▼ M8*Appendix*

DEFINITIONS

Accuracy: The closeness of agreement between test method results and accepted reference values. It is a measure of test method performance and one aspect of relevance. The term is often used interchangeably with concordance to mean the proportion of correct outcomes of a test method (13).

Benchmark substance: A substance used as a standard for comparison to a test chemical. A benchmark substance should have the following properties; (i) a consistent and reliable source(s); (ii) structural and functional similarity to the class of substances being tested; (iii) known physical/chemical characteristics; (iv) supporting data on known effects, and (v) known potency in the range of the desired response.

Bottom-Up Approach: A step-wise approach used for a test chemical suspected of not requiring classification for eye irritation or serious eye damage, which starts with the determination of chemicals not requiring classification (negative outcome) from other chemicals (positive outcome)

Chemical: A substance or mixture.

Eye irritation: Production of change in the eye following the application of a test chemical to the anterior surface of the eye, which are fully reversible within 21 days of application. Interchangeable with 'reversible effects on the eye' and with UN GHS/CLP Category 2

False negative rate: The proportion of all positive chemicals falsely identified by a test method as negative. It is one indicator of test method performance.

False positive rate: The proportion of all negative chemicals that are falsely identified by a test method as positive. It is one indicator of test method performance.

Hazard: Inherent property of an agent or situation having the potential to cause adverse effects when an organism, system or (sub) population is exposed to that agent.

Medium control: An untreated replicate containing all components of a test system. This sample is processed with test chemical-treated samples and other control samples to determine whether the solvent interacts with the test system.

Mixture: A mixture or a solution composed of two or more substances.

Mono-constituent substance: A substance, defined by its quantitative composition, in which one main constituent is present to at least 80 % (w/w).

MTT: 3-(4,5-Dimethylthiazol-2-yl)-2,5-diphenyltetrazolium bromide; Thiazolyl blue tetrazolium bromide.

Multi-constituent substance: A substance, defined by its quantitative composition, in which more than one main constituent is present in a concentration $\geq 10\%$ (w/w) and $< 80\%$ (w/w). A multi-constituent substance is the result of a manufacturing process. The difference between mixture and multi-constituent substance is that a mixture is obtained by blending of two or more substances without chemical reaction. A multi-constituent substance is the result of a chemical reaction.

▼ M8

OD: Optical Density.

Positive control: A replicate containing all components of a test system and treated with a substance known to induce a positive response. To ensure that variability in the positive control response across time can be assessed, the magnitude of the positive response should not be excessive.

Relevance: Description of relationship of the test to the effect of interest and whether it is meaningful and useful for a particular purpose. It is the extent to which the test correctly measures or predicts the biological effect of interest. Relevance incorporates consideration of the accuracy (concordance) of a test method (10).

Reliability: Measures of the extent that a test method can be performed reproducibly within and between laboratories over time, when performed using the same protocol. It is assessed by calculating intra- and inter-laboratory reproducibility and intra-laboratory repeatability (13).

Sensitivity: The proportion of all positive/active chemicals that are correctly classified by the test. It is a measure of accuracy for a test method that produces categorical results, and is an important consideration in assessing the relevance of a test method (10).

Serious eye damage: Production of tissue damage in the eye, or serious physical decay of vision, following application of a test chemical to the anterior surface of the eye, which is not fully reversible within 21 days of application. Interchangeable with 'irreversible effects on the eye' and with UN GHS/CLP Category 1.

Solvent/vehicle control: An untreated sample containing all components of a test system, including the solvent or vehicle that is processed with the test chemical-treated and other control samples to establish the baseline response for the samples treated with the test chemical dissolved in the same solvent or vehicle. When tested with a concurrent medium control, this sample also demonstrates whether the solvent or vehicle interacts with the test system.

Specificity: The proportion of all negative/inactive chemicals that are correctly classified by the test. It is a measure of accuracy for a test method that produces categorical results and is an important consideration in assessing the relevance of a test method (13).

Substance: A chemical element and its compounds in the natural state or obtained by any production process, including any additive necessary to preserve its stability and any impurities deriving from the process used, but excluding any solvent which may be separated without affecting the stability of the substance or changing its composition.

Surfactant: Also called surface-active agent, this is a chemical such as a detergent, that can reduce the surface tension of a liquid and thus allow it to foam or penetrate solids; it is also known as a wetting agent.

Test chemical: Any substance or mixture tested using this Test Method.

▼M8

Tiered testing strategy: A stepwise testing strategy where all existing information on a test chemical is reviewed, in a specified order, using a weight of evidence process at each tier to determine if sufficient information is available for a hazard classification decision, prior to progression to the next tier. If the irritancy potential of a test chemical can be assigned based on the existing information, no additional testing is required. If the irritancy potential of a test chemical cannot be assigned based on the existing information, a step-wise sequential animal testing procedure is performed until an unequivocal classification can be made.

Top-Down Approach: step-wise approach used for a test chemical suspected of causing serious eye damage, which starts with the determination of chemicals inducing serious eye damage (positive outcome) from other chemicals (negative outcome).

United Nations Globally Harmonized System of Classification and Labelling of Chemicals (UN GHS): A system proposing the classification of chemicals (substances and mixtures) according to standardized types and levels of physical, health and environmental hazards, and addressing corresponding communication elements, such as pictograms, signal words, hazard statements, precautionary statements and safety data sheets, so that to convey information on their adverse effects with a view to protect people (including employers, workers, transporters, consumers and emergency responders) and the environment (1).

UN GHS/CLP Category 1: See 'Serious eye damage'.

UN GHS/CLP Category 2: See 'Eye irritation'.

UN GHS/CLP No Category: Chemicals that are not classified as UN GHS/CLP Category 1 or 2 (or UN GHS Category 2A or 2B).

UVCB: substances of unknown or variable composition, complex reaction products or biological materials.

▼M8**B.69. RECONSTRUCTED HUMAN CORNEA-LIKE EPITHELIUM (RhCE) TEST METHOD FOR IDENTIFYING CHEMICALS NOT REQUIRING CLASSIFICATION AND LABELLING FOR EYE IRRITATION OR SERIOUS EYE DAMAGE**

INTRODUCTION

1. This test method (TM) is equivalent to OECD test guideline (TG) 492 (2017). *Serious eye damage* refers to the production of tissue damage in the eye, or serious physical decay of vision, following application of a test chemical to the anterior surface of the eye, which is not fully reversible within 21 days of application, as defined by the United Nations Globally Harmonized System of Classification and Labelling of Chemicals (UN GHS) (1) and the European Union (EU) Regulation 1272/2008 on Classification, Labelling and Packaging of Substances and Mixtures (CLP) (1). Also according to UN GHS and CLP, *eye irritation* refers to the production of changes in the eye following the application of a test chemical to the anterior surface of the eye, which are fully reversible within 21 days of application. Test chemicals inducing serious eye damage are classified as UN GHS and CLP Category 1, while those inducing eye irritation are classified as UN GHS and CLP Category 2. Test chemicals not classified for eye irritation or serious eye damage are defined as those that do not meet the requirements for classification as UN GHS and CLP Category 1 or 2 (2A or 2B) i.e., they are referred to as UN GHS and CLP No Category.
2. The assessment of serious eye damage/eye irritation has typically involved the use of laboratory animals (TM B.5 (2)). The choice of the most appropriate test method and the use of this test method should be seen in the context of the OECD Guidance Document on an Integrated Approaches on Testing and Assessment for Serious Eye Damage and Eye irritation (39).
3. This test method describes an *in vitro* procedure allowing the identification of chemicals (substances and mixtures) not requiring classification and labelling for eye irritation or serious eye damage in accordance with UN GHS and CLP. It makes use of reconstructed human cornea-like epithelium (RhCE) which closely mimics the histological, morphological, biochemical and physiological properties of the human corneal epithelium. Four other *in vitro* test methods have been validated, considered scientifically valid and adopted as TM B.47 (3), B.48 (4), B.61 (5) and B.68 (6) to address the human health endpoint serious eye damage/eye irritation.
4. Two validated tests using commercially available RhCE models are included in this test method. Validation studies for assessing eye irritation/serious eye damage have been conducted (7)(8)(9)(10)(11)(12)(13) using the EpiOcular™ Eye Irritation Test (EIT) and the SkinEthic™ Human Corneal Epithelium (HCE) Eye Irritation Test (EIT). Each of these tests makes use of commercially available RhCE tissue constructs as test system, which are referred to in the following text as the Validated Reference Methods – VRM 1 and VRM2, respectively. From these validation studies and their

(1) Regulation (EC) No 1272/2008 of the European Parliament and of the Council of 16 December 2008 on classification, labelling and packaging of substances and mixtures, amending and repealing Directives 67/548/EEC and 1999/45/EC, and amending Regulation (EC) No 1907/2006, OJ L 353/1, 31.12.2008

▼M8

independent peer review (9)(12) it was concluded that the EpiOcular™ EIT and SkinEthic™ HCE EIT are able to correctly identify chemicals (both substances and mixtures) not requiring classification and labelling for eye irritation or serious eye damage according to UN GHS, and the tests were recommended as scientifically valid for that purpose (13).

5. It is currently generally accepted that, in the foreseeable future, no single *in vitro* test method will be able to fully replace the *in vivo* Draize eye test (2)(14) to predict across the full range of serious eye damage/eye irritation responses for different chemical classes. However, strategic combinations of several alternative test methods within (tiered) testing strategies such as the Bottom-Up/Top-Down approach may be able to fully replace the Draize eye test (15). The Bottom-Up approach (15) is designed to be used when, based on existing information, a chemical is expected not to cause sufficient eye irritation to require a classification, while the Top-Down approach (15) is designed to be used when, based on existing information, a chemical is expected to cause serious eye damage. The EpiOcular™ EIT and SkinEthic™ HCE EIT are recommended to identify chemicals that do not require classification for eye irritation or serious eye damage according to UN GHS/CLP (No Category) without further testing, within a testing strategy such as the Bottom-Up/Top-Down approach suggested by Scott *et al.* e.g. as an initial step in a Bottom-Up approach or as one of the last steps in a Top-Down approach (15). However, the EpiOcular™ EIT and SkinEthic™ HCE EIT are not intended to differentiate between UN GHS/CLP Category 1 (serious eye damage) and UN GHS/CLP Category 2 (eye irritation). This differentiation will need to be addressed by another tier of a test strategy (15). A test chemical that is identified as requiring classification for eye irritation/serious eye damage with EpiOcular™ EIT or SkinEthic™ HCE EIT will thus require additional testing (*in vitro* and/or *in vivo*) to reach a definitive conclusion (UN GHS/CLP No Category, Category 2 or Category 1), using e.g. TM B.47, B.48, B.61 or B.68.

6. The purpose of this test method is to describe the procedure used to evaluate the eye hazard potential of a test chemical based on its ability to induce cytotoxicity in a RhCE tissue construct, as measured by the MTT assay (16) (see paragraph 21). The viability of the RhCE tissue following exposure to a test chemical is determined in comparison to tissues treated with the negative control substance (% viability), and is then used to predict the eye hazard potential of the test chemical.

7. Performance standards (17) are available to facilitate the validation of new or modified *in vitro* RhCE-based tests similar to EpiOcular™ EIT and SkinEthic™ HCE EIT, in accordance with the principles of the OECD Guidance Document No 34 (18), and allow for timely amendment of OECD TG 492 for their inclusion. Mutual Acceptance of Data (MAD) according to the OECD agreement will only be guaranteed for tests validated according to the performance standards, if these tests have been reviewed and included in the corresponding test guideline by the OECD.

DEFINITIONS

8. Definitions are provided in Appendix 1.

▼M8

INITIAL CONSIDERATIONS AND LIMITATIONS

9. This test method is based on commercial three-dimensional RhCE tissue constructs that are produced using either primary human epidermal keratinocytes (i.e., EpiOcular™ OCL-200) or human immortalised corneal epithelial cells (i.e., SkinEthic™ HCE/S). The EpiOcular™ OCL-200 and SkinEthic™ HCE/S RhCE tissue constructs are similar to the *in vivo* corneal epithelium three-dimensional structure and are produced using cells from the species of interest (19)(20). Moreover, the tests directly measure cytotoxicity resulting from penetration of the chemical through the cornea and production of cell and tissue damage; the cytotoxic response then determines the overall *in vivo* serious eye damage/eye irritation outcome. Cell damage can occur by several modes of action (see paragraph 20), but cytotoxicity plays an important, if not the primary, mechanistic role in determining the overall serious eye damage/eye irritation response of a chemical, manifested *in vivo* mainly by corneal opacity, iritis, conjunctival redness and/or conjunctival chemosis, regardless of the physicochemical processes underlying tissue damage.

10. A wide range of chemicals, covering a large variety of chemical types, chemical classes, molecular weights, LogPs, chemical structures, etc., have been tested in the validation study underlying this test method. The EpiOcular™ EIT validation database contained 113 chemicals in total, covering 95 different organic functional groups according to an OECD QSAR toolbox analysis (8). The majority of these chemicals represented mono-constituent substances, but several multi-constituent substances (including 3 homopolymers, 5 copolymers and 10 quasi polymers) were also included in the study. In terms of physical state and UN GHS/CLP Categories, the 113 tested chemicals were distributed as follows: 13 Category 1 liquids, 15 Category 1 solids, 6 Category 2A liquids, 10 Category 2A solids, 7 Category 2B liquids, 7 Category 2B solids, 27 No Category liquids and 28 No Category solids (8). The SkinEthic™ HCE EIT validation database contained 200 chemicals in total, covering 165 different organic functional groups (8)(10)(11). The majority of these chemicals represented mono-constituent substances, but several multi-constituent substances (including 10 polymers) were also included in the study. In terms of physical state and UN GHS/CLP Categories, the 200 tested chemicals were distributed as follows: 27 Category 1 liquids, 24 Category 1 solids, 19 Category 2A liquids, 10 Category 2A solids, 9 Category 2B liquids, 8 Category 2B solids, 50 No Category liquids and 53 No Category solids (10)(11).

11. This testmethod is applicable to substances and mixtures, and to solids, liquids, semi-solids and waxes. The liquids may be aqueous or non-aqueous; solids may be soluble or insoluble in water. Whenever possible, solids should be ground to a fine powder before application; no other pre-treatment of the sample is required. Gases and aerosols have not been assessed in a validation study. While it is conceivable that these can be tested using RhCE technology, the current test method does not allow testing of gases and aerosols.

12. Test chemicals absorbing light in the same range as MTT formazan (naturally or after treatment) and test chemicals able to directly reduce the vital dye MTT (to MTT formazan) may interfere with the tissue viability measurements and need the use of adapted controls for corrections. The type of adapted controls that may be required will vary depending on the type of interference produced by the test chemical and the procedure used to quantify MTT formazan (see paragraphs 36-42).

▼M8

13. Results generated in pre-validation (21)(22) and full validation (8)(10)(11) studies have demonstrated that both EpiOcular™ EIT and SkinEthic™ HCE EIT are transferable to laboratories considered to be naïve in the conduct of the assays and also to be reproducible within- and between laboratories. Based on these studies, the level of reproducibility in terms of concordance of predictions that can be expected from EpiOcular™ EIT from data on 113 chemicals is in the order of 95 % within laboratories and 93 % between laboratories. The level of reproducibility in terms of concordance of predictions that can be expected from SkinEthic™ HCE EIT from data on 120 chemicals is in the order of 92 % within laboratories and 95 % between laboratories.

14. The EpiOcular™ EIT can be used to identify chemicals that do not require classification for eye irritation or serious eye damage according to the UN GHS and CLP classification system. Considering the data obtained in the validation study (8), the EpiOcular™ EIT has an overall accuracy of 80 % (based on 112 chemicals), sensitivity of 96 % (based on 57 chemicals), false negative rate of 4 % (based on 57 chemicals), specificity of 63 % (based on 55 chemicals) and false positive rate of 37 % (based on 55 chemicals), when compared to reference *in vivo* rabbit eye test data (TM B.5) (2)(14) classified according to the UN GHS and CLP classification system. A study where 97 liquid agrochemical formulations were tested with EpiOcular™ EIT demonstrated a similar performance of the test method for this type of mixtures as obtained in the validation study (23). The 97 formulations were distributed as follows: 21 Category 1, 19 Category 2A, 14 Category 2B and 43 No Category, classified according to the UN GHS classification system based on reference *in vivo* rabbit eye test data (TM B.5) (2)(14). An overall accuracy of 82 % (based on 97 formulations), sensitivity of 91 % (based on 54 formulations), false negative rate of 9 % (based on 54 formulations), specificity of 72 % (based on 43 formulations) and false positive rate of 28 % (based on 43 formulations) were obtained (23).

15. The SkinEthic™ HCE EIT can be used to identify chemicals that do not require classification for eye irritation or serious eye damage according to the UN GHS and CLP classification system. Considering the data obtained in the validation study (10)(11), the SkinEthic™ HCE EIT has an overall accuracy of 84 % (based on 200 chemicals), sensitivity of 95 % (based on 97 chemicals), false negative rate of 5 % (based on 97 chemicals), specificity of 72 % (based on 103 chemicals) and false positive rate of 28 % (based on 103 chemicals), when compared to reference *in vivo* rabbit eye test data (TM B.5) (2)(14) classified according to the UN GHS and CLP classification system.

16. The false negative rates obtained with both RhCE tests, with either substances or mixtures, fall within the 12 % overall probability that chemicals are identified as either UN GHS and CLP Category 2 or UN GHS and CLP No Category by the *in vivo* Draize eye test, in repeated tests; this is due to the method's inherent within-test variability (24). The false positive rates obtained with both RhCE test methods with either substances or mixtures are not critical in the context of this test method since all test chemicals that produce a tissue viability equal or lower than the established cut-offs (see paragraph 44) will require further testing with other *in vitro* test methods, or as a last option in rabbits, depending on regulatory requirements, using a sequential testing strategy in a weight-of-evidence approach. These test methods can be used for all types of

▼M8

chemicals, whereby a negative result should be accepted for not classifying a chemical for eye irritation and serious eye damage (UN GHS and CLP No Category). The appropriate regulatory authorities should be consulted before using the EpiOcular™ EIT and SkinEthic™ HCE EIT under classification schemes other than UN GHS/CLP.

17. A limitation of this test method is that it does not allow discrimination between eye irritation/reversible effects on the eye (Category 2) and serious eye damage/irreversible effects on the eye (Category 1) as defined by UN GHS and CLP, nor between eye irritants (optional Category 2A) and mild eye irritants (optional Category 2B), as defined by UN GHS (1). For these purposes, further testing with other *in vitro* test methods is required.
18. The term ‘test chemical’ is used in this test method to refer to what is being tested⁽¹⁾ and is not related to the applicability of the RhCE test method to the testing of substances and/or mixtures.

PRINCIPLE OF THE TEST

19. The test chemical is applied topically to a minimum of two three-dimensional RhCE tissue constructs and tissue viability is measured following exposure and a post-treatment incubation period. The RhCE tissues are reconstructed from primary human epidermal keratinocytes or human immortalised corneal epithelial cells, which have been cultured for several days to form a stratified, highly differentiated squamous epithelium morphologically similar to that found in the human cornea. The EpiOcular™ RhCE tissue construct consists of at least 3 viable layers of cells and a non-keratinised surface, showing a cornea-like structure analogous to that found *in vivo*. The SkinEthic™ HCE RhCE tissue construct consists of at least 4 viable layers of cells including columnar basal cells, transitional wing cells and superficial squamous cells similar to that of the normal human corneal epithelium (20)(26).
20. Chemical-induced serious eye damage/eye irritation, manifested *in vivo* mainly by corneal opacity, iritis, conjunctival redness and/or conjunctival chemosis, is the result of a cascade of events beginning with penetration of the chemical through the cornea and/or conjunctiva and production of damage to the cells. Cell damage can occur by several modes of action, including: cell membrane lysis (e.g. by surfactants, organic solvents); coagulation of macromolecules (particularly proteins) (e.g. by surfactants, organic solvents, alkalis and acids); saponification of lipids (e.g. by alkalis); and alkylation or other covalent interactions with macromolecules (e.g. by bleaches, peroxides and alkylators) (15)(27)(28). However, it has been shown that cytotoxicity plays an important, if not the primary, mechanistic role in determining the overall serious eye damage/eye irritation response of a chemical regardless of the physicochemical processes underlying tissue damage (29)(30). Moreover, the serious eye damage/eye irritation potential of a chemical is principally determined by the extent of initial injury (31), which correlates with the extent of cell death (29) and with the extent of the subsequent responses and eventual outcomes (32). Thus, slight irritants

⁽¹⁾ In June 2013, the OECD Joint Meeting agreed that where possible, a more consistent use of the term ‘test chemical’ describing what is being tested should now be applied in new and updated OECD test guidelines.

▼ **M8**

generally only affect the superficial corneal epithelium, the mild and moderate irritants damage principally the epithelium and superficial stroma and the severe irritants damage the epithelium, deep stroma and at times the corneal endothelium (30)(33). The measurement of viability of the RhCE tissue construct after topical exposure to a test chemical to identify chemicals not requiring classification for serious eye damage/eye irritancy (UN GHS and CLP No Category) is based on the assumption that all chemicals inducing serious eye damage or eye irritation will induce cytotoxicity in the corneal epithelium and/or conjunctiva.

21. RhCE tissue viability is classically measured by enzymatic conversion of the vital dye MTT [3-(4,5-Dimethylthiazol-2-yl)-2,5-diphenyltetrazolium bromide; Thiazolyl blue tetrazolium bromide; CAS number 298-93-1] by the viable cells of the tissue into a blue MTT formazan salt that is quantitatively measured after extraction from tissues (16). Chemicals not requiring classification and labelling according to UN GHS/CLP (No Category) are identified as those that do not decrease tissue viability below a defined threshold (i.e., tissue viability > 60 %, in EpiOcular™ EIT and SkinEthic™ HCE EITL⁽¹⁾, or > 50 %, in SkinEthic™ HCE EITS⁽²⁾) (see paragraph 44).

DEMONSTRATION OF PROFICIENCY

22. Prior to routine use of RhCE tests for regulatory purposes, laboratories should demonstrate technical proficiency by correctly predicting the fifteen proficiency chemicals listed in Table 1. These chemicals were selected from the chemicals used in the validation studies of the VRMs (8)(10)(11). The selection includes, to the extent possible, chemicals that: (i) cover different physical states; (ii) cover the full range of *in vivo* serious eye damage/eye irritation responses based on high quality results obtained in the reference *in vivo* rabbit eye test (TM B.5) (2)(14) and the UN GHS classification system (i.e., Categories 1, 2A, 2B, or No Category) (1) and CLP classification system (i.e., Categories 1, 2 or No Category); (iii) cover the various *in vivo* drivers of classification (24)(25); (iv) are representative of the chemical classes used in the validation study (8)(10)(11); (v) cover a good and wide representation of organic functional groups (8)(10)(11); (vi) have chemical structures that are well-defined (8)(10)(11); (vii) are coloured and/or direct MTT reducers; (viii) produced reproducible results in RhCE test methods during their validations; (ix) were correctly predicted by RhCE test methods during their validation studies; (x) cover the full range of *in vitro* responses based on high quality RhCE test methods data (0 to 100 % viability); (xi) are commercially available; and (xii) are not associated with prohibitive acquisition and/or disposal costs. In situations where a listed chemical is unavailable or cannot be used for other justified reasons, another chemical fulfilling the criteria described above, e.g. from the chemicals used in the validation of the VRM, could be used. Such deviations should however be justified.

⁽¹⁾ EITL: EIT for liquids in the case of SkinEthic™ HCE

⁽²⁾ EITS: EIT for solids in the case of SkinEthic™ HCE

▼M8

Table 1

List of proficiency chemicals

Chemical Name	CASRN	Organic Functional Group (1)	Physical State	VRM1 viability (%) (2)	VRM2 viability (%) (3)	VRM Prediction	MTT Reducer	Colour interf.
---------------	-------	------------------------------	----------------	------------------------	------------------------	----------------	-------------	----------------

In Vivo Category 1 (4)

Methylthioglycolate	2 365-48-2	Carboxylic acid ester; Thioalcohol	L	10,9±6,4	5,5±7,4	No prediction can be made	Y(strong)	N
Hydroxyethyl acrylate	818-61-1	Acrylate; Alcohol	L	7,5±4,7 (5)	1,6±1,0	No prediction can be made	N	N
2,5-Dimethyl-2,5-hexanediol	110-03-2	Alcohol	S	2,3±0,2	0,2±0,1	No prediction can be made	N	N
Sodium oxalate	62-76-0	Oxocarboxylic acid	S	29,0±1,2	5,3±4,1	No prediction can be made	N	N

In Vivo Category 2A (4)

2,4,11,13-Tetraazatetradecane-diimidamide, N,N"-bis(4-chlorophenyl)-3,12-diimino-, di-D-gluconate(20 %, aqueous) (6)	18 472-51-0	Aromatic heterocyclic halide; Aryl halide; Dihydroxyl group; Guanidine	L	4,0±1,1	1,3±0,6	No prediction can be made	N	Y(weak)
Sodium benzoate	532-32-1	Aryl; Carboxylic acid	S	3,5±2,6	0,6±0,1	No prediction can be made	N	N

In Vivo Category 2B (4)

Diethyl toluamide	134-62-3	Benzamide	L	15,6±6,3	2,8±0,9	No prediction can be made	N	N
2,2-Dimethyl-3-methylenebicyclo [2.2.1] heptane	79-92-5	Alkane, branched with tertiary carbon; Alkene; Bicycloheptane; Bridged-ring carbocycles; Cycloalkane	S	4,7±1,5	15,8±1,1	No prediction can be made	N	N

In Vivo No Category (4)

1-Ethyl-3-methylimidazolium ethylsulphate	3425 73-75-5	Alkoxy; Ammonium salt; Aryl; Imidazole; Sulphate	L	79,9±6,4	79,4±6,2	No Cat	N	N
---	--------------	--	---	----------	----------	--------	---	---

▼M8

Chemical Name	CASRN	Organic Functional Group (1)	Physical State	VRM1 viability (%) (2)	VRM2 viability (%) (3)	VRM Prediction	MTT Reducer	Colour interf.
Dicaprylyl ether	629-82-3	Alkoxy; Ether	L	97,8±4,3	95,2±3,0	No Cat	N	N
Piperonyl butoxide	51-03-6	Alkoxy; Benzodioxole; Benzyl; Ether	L	104,2±4,2	96,5±3,5	No Cat	N	N
Polyethylene glycol (PEG-40) hydrogenated castor oil	61 788-85-0	Acylal; Alcohol; Allyl; Ether	Viscous	77,6±5,4	89,1±2,9	No Cat	N	N
1-(4-Chlorophenyl)-3-(3,4-dichlorophenyl) urea	101-20-2	Aromatic heterocyclic halide; Aryl halide; Urea derivatives	S	106,7±5,3	101,9±6,6	No Cat	N	N
2,2'-Methylene-bis-(6-(2H-benzotriazol-2-yl)-4-(1,1,3,3-tetramethylbutyl)-phenol)	1035 97-45-1	Alkane branched with quaternary carbon; Fused carbocyclic aromatic; Fused saturated heterocycles; Precursors quinoid compounds; tert-Butyl	S	102,7±13,4	97,7±5,6	No Cat	N	N
Potassium tetrafluoroborate	14 075-53-7	Inorganic Salt	S	88,6±3,3	92,9±5,1	No Cat	N	N

Abbreviations:

CASRN = Chemical Abstracts Service Registry Number; VRM1 = Validated Reference Method, EpiOcular™ EIT; VRM2 = Validated Reference Method, SkinEthic™ HCE EIT; Colour interf. = colour interference with the standard absorbance (Optical Density (OD)) measurement of MTT formazan.

(1) Organic functional group assigned according to an OECD Toolbox 3,1 nested analysis (8).

(2) Based on results obtained with EpiOcular™ EIT in the EURL ECVAM/Cosmetics Europe Eye Irritation Validation Study (EIVS) (8).

(3) Based on results obtained with SkinEthic™ HCE EIT in the validation study (10)(11).

(4) Based on results from the *in vivo* rabbit eye test (TM B.5/OECD TG 405) (2)(14) and using the UN GHS.

(5) Based on results obtained in the CEFIC CONsortium for *in vitro* Eye Irritation testing strategy (CON4EI) Study.

(6) Classification as 2A or 2B depends on the interpretation of the UN GHS criterion for distinguishing between these two categories, i.e., 1 out of 3 vs 2 out of 3 animals with effects at day 7 necessary to generate a Category 2A classification. The *in vivo* study included 3 animals. All endpoints apart from corneal opacity in one animal recovered to a score of zero by day 7 or earlier. The one animal that did not fully recover by day 7 had a corneal opacity score of 1 (at day 7) that fully recovered at day 9.

23. As part of the proficiency testing, it is recommended that users verify the barrier properties of the tissues after receipt as specified by the RhCE tissue construct producer (see paragraphs 25, 27 and 30). This is particularly important if tissues are shipped over long distance / time periods. Once a test has been successfully established and proficiency in its use has been acquired and demonstrated, such verification will not be necessary on a routine basis. However, when using a test routinely, it is recommended to continue to assess the barrier properties at regular intervals.

▼ M8

PROCEDURE

24. The tests currently covered by this test method are the scientifically valid EpiOcular™ EIT and SkinEthic™ HCE EIT (9)(12)(13), referred to as the Validated Reference Method (VRM1 and VRM2, respectively). The Standard Operating Procedures (SOP) for the RhCE test methods are available and should be employed when implementing and using the test methods in a laboratory (34)(35). The following paragraphs and Appendix 2 describe the main components and procedures of the RhCE tests.

RHCE TEST METHOD COMPONENTS

General conditions

25. Relevant human-derived cells should be used to reconstruct the cornea-like epithelium three-dimensional tissue, which should be composed of progressively stratified but not cornified cells. The RhCE tissue construct is prepared in inserts with a porous synthetic membrane through which nutrients can pass to the cells. Multiple layers of viable, non-keratinised epithelial cells should be present in the reconstructed cornea-like epithelium. The RhCE tissue construct should have the epithelial surface in direct contact with air so as to allow for direct topical exposure of test chemicals in a fashion similar to how the corneal epithelium would be exposed *in vivo*. The RhCE tissue construct should form a functional barrier with sufficient robustness to resist rapid penetration of cytotoxic benchmark substances, e.g. Triton X-100 or sodium dodecyl sulphate (SDS). The barrier function should be demonstrated and may be assessed by determination of either the exposure time required to reduce tissue viability by 50 % (ET₅₀) upon application of a benchmark substance at a specified, fixed concentration (e.g. 100 µl of 0,3 % (v/v) Triton X-100), or the concentration at which a benchmark substance reduces the viability of the tissues by 50 % (IC₅₀) following a fixed exposure time (e.g. 30 minutes treatment with 50 µl SDS) (see paragraph 30). The containment properties of the RhCE tissue construct should prevent the passage of test chemical around the edge of the viable tissue, which could lead to poor modelling of corneal exposure. The human-derived cells used to establish the RhCE tissue construct should be free of contamination by bacteria, viruses, mycoplasma, and fungi. The sterility of the tissue construct should be checked by the supplier for absence of contamination by fungi and bacteria.

Functional conditions*Viability*

26. The assay used for quantifying tissue viability is the MTT assay (16). Viable cells of the RhCE tissue construct reduce the vital dye MTT into a blue MTT formazan precipitate, which is then extracted from the tissue using isopropanol (or a similar solvent). The extracted MTT formazan may be quantified using either a standard absorbance (Optical Density (OD)) measurement or an HPLC/UPLC-spectrophotometry procedure (36). The OD of the extraction solvent alone should be sufficiently small, i.e. OD < 0.1. Users of the RhCE tissue construct should ensure that each batch of the RhCE tissue construct used meets defined criteria for the negative control. Acceptability ranges for the negative control OD values for the VRMs are given in Table 2. An HPLC/UPLC-spectrophotometry user should use the negative control OD ranges provided in Table 2 as the acceptance criterion for the negative control. It should be documented in the test report that the tissues treated with the negative control substance are stable in culture (provide similar tissue viability measurements) for the duration of the test exposure period. A similar procedure should be followed

▼ M8

by the tissue producer as part of the quality control tissue batch release, but in this case different acceptance criteria than those specified in Table 2 may apply. An acceptability range (upper and lower limit) for the negative control OD values (in the QC test method conditions) should be established by the RhCE tissue construct developer/supplier.

Table 2

Acceptability ranges for negative control OD values (for the test users)

Test	Lower acceptance limit	Upper acceptance limit
EpiOcular™ EIT (OCL-200) – VRM1(for both the liquids and the solids protocols)	> 0.8 ⁽¹⁾	< 2,5
SkinEthic™ HCE EIT (HCE/S) – VRM2(for both the liquids and the solids protocols)	> 1.0	≤ 2,5

⁽¹⁾ This acceptance limit considers the possibility of extended shipping/storage time (e.g. > 4 days), which has been shown not to impact on the performance of the test method (37).

Barrier function

27. The RhCE tissue construct should be sufficiently thick and robust to resist the rapid penetration of cytotoxic benchmark substances, as estimated e.g. by ET_{50} (Triton X-100) or by IC_{50} (SDS) (Table 3). The barrier function of each batch of the RhCE tissue construct used should be demonstrated by the RhCE tissue construct developer/vendor upon supply of the tissues to the end user (see paragraph 30).

Morphology

28. Histological examination of the RhCE tissue construct should demonstrate human cornea-like epithelium structure (including at least 3 layers of viable epithelial cells and a non-keratinised surface). For the VRMs, appropriate morphology has been established by the developer/supplier and therefore does not need to be demonstrated again by a test method user for each tissue batch used.

Reproducibility

29. The results of the positive and negative controls of the test method should demonstrate reproducibility over time.

Quality control (QC)

30. The RhCE tissue construct should only be used if the developer/supplier demonstrates that each batch of the RhCE tissue construct used meets defined production release criteria, among which those for viability (paragraph 26) and barrier function (see paragraph 27) are the most relevant. An acceptability range (upper and lower limits) for the barrier functions as measured by the ET_{50} or IC_{50} (see paragraphs 25 and 26) should be established by the RhCE tissue construct developer/supplier. The ET_{50} and IC_{50} acceptability range used as QC batch release criterion by the developer/supplier of the RhCE tissue constructs (used in the VRMs) is given in Table 3. Data demonstrating compliance with all production release criteria should be provided by the RhCE tissue construct developer/supplier to the test method users so that they are able to include this information in the test report. Only results produced with tissues fulfilling all of these production release criteria can be accepted for reliable prediction of chemicals not requiring classification and labelling for eye irritation or serious eye damage in accordance with UN GHS/CLP.

▼ **M8**

Table 3

QC batch release criterion

Test	Lower acceptance limit	Upper acceptance limit
EpiOcular™ EIT (OCL-200) – VRM1(100 µl of 0,3 % (v/v) Triton X-100)	ET ₅₀ = 12,2 min	ET ₅₀ = 37,5 min
SkinEthic™ HCE EIT (HCE/S) – VRM2 (30 minutes treatment with 50 µl SDS)	IC ₅₀ = 1 mg/ml	IC ₅₀ = 3,2 mg/ml

Application of the Test Chemical and Control Substances

31. At least two tissue replicates should be used for each test chemical and each control substance in each run. Two different treatment protocols are used, one for liquid test chemicals and one for solid test chemicals (34)(35). For both methods and protocols, the tissue construct surface should be moistened with calcium and magnesium-free Dulbecco's Phosphate Buffered Saline (Ca²⁺/Mg²⁺-free DPBS) before application of test chemicals, to mimic the wet conditions of human eye. The treatment of the tissues is initiated with exposure to the test chemical(s) and control substances. For both treatment protocols in both VRMs, a sufficient amount of test chemical or control substance should be applied to uniformly cover the epithelial surface while avoiding an infinite dose (see paragraphs 32 and 33) (Appendix 2).
32. Test chemicals that can be pipetted at 37°C or lower temperatures (using a positive displacement pipette, if needed) are treated as liquids in the VRMs, otherwise they should be treated as solids (see paragraph 33). In the VRMs, liquid test chemical are evenly spread over the tissue surface (i.e. a minimum of 60 µl/cm² application) (see Appendix 2, (33)(34)). Capillary effects (surface tension effects) that may occur due to the low volumes applied to the insert (on the tissue surface) should be avoided to the extent possible to guarantee the correct dosing of the tissue. Tissues treated with liquid test chemicals are incubated for 30 min at standard culture conditions (37±2°C, 5±1 % CO₂, ≥95 % RH). At the end of the exposure period, the liquid test chemical and the control substances should be carefully removed from the tissue surface by extensive rinsing with Ca²⁺/Mg²⁺-free DPBS at room temperature. This rinsing step is followed by a post-exposure immersion in fresh medium at room temperature (to remove any test chemical absorbed into the tissue) for a pre-defined period of time that varies depending on the VRM used. For VMR1 only, a post-exposure incubation in fresh medium at standard culture conditions is applied prior to performing the MTT assay (see Appendix 2, (34)(35)).
33. Test chemicals that cannot be pipetted at temperatures up to 37°C are treated as solids in the VRMs. The amount of test chemical applied should be sufficient to cover the entire surface of the tissue, i.e. a minimum of 60 mg/cm² application should be used (Appendix 2). Whenever possible, solids should be tested as a fine powder. Tissues treated with solid test chemicals are incubated for a pre-defined period of time (depending on the VRM used) at standard culture conditions (see Appendix 2, (34) (35)). At the end of the exposure period, the solid test chemical and the control

▼ M8

substances should be carefully removed from the tissue surface by extensive rinsing with $\text{Ca}^{2+}/\text{Mg}^{2+}$ -free DPBS at room temperature. This rinsing step is followed by a post-exposure immersion in fresh medium at room temperature (to remove any test chemical absorbed into the tissue) for a pre-defined period of time that varies depending on the VRM used, and a post-exposure incubation in fresh medium at standard culture conditions, prior to performing the MTT assay (see Appendix 2, (34)(35)).

34. Concurrent negative and positive controls should be included in each run to demonstrate that the viability (determined with the negative control) and the sensitivity (determined with the positive control) of the tissues are within acceptance ranges defined based on historical data. The concurrent negative control also provides the baseline (100 % tissue viability) to calculate the relative percent viability of the tissues treated with the test chemical ($\% \text{Viability}_{\text{test}}$). The recommended positive control substance to be used with the VRMs is neat methyl acetate (CAS No 79-20-9, commercially available from e.g. Sigma-Aldrich, Cat# 45 997; liquid). The recommended negative control substances to be used with the VRM1 and VRM2 are ultrapure H_2O and $\text{Ca}^{2+}/\text{Mg}^{2+}$ -free DPBS, respectively. These were the control substances used in the validation studies of the VRMs and are those for which most historical data exist. The use of suitable alternative positive or negative control substances should be scientifically and adequately justified. Negative and positive controls should be tested with the same protocol(s) as the one(s) used for the test chemicals included in the run (i.e. for liquids and/or solids). This application should be followed by the treatment exposure, rinsing, a post-exposure immersion, and post-exposure incubation where applicable, as described for controls run concurrently to liquid test chemicals (see paragraph 32) or for controls run concurrently to solid test chemicals (see paragraph 33), prior to performing the MTT assay (see paragraph 35) (34)(35). One single set of negative and positive controls is sufficient for all test chemicals of the same physical state (liquids or solids) included in the same run.

Tissue Viability Measurements

35. The MTT assay is a standardised quantitative method (16) that should be used to measure tissue viability under this test method. It is compatible with use in a three-dimensional tissue construct. The MTT assay is performed immediately following the post-exposure incubation period. In the VRMs, the RhCE tissue construct sample is placed in 0,3 ml of MTT solution at 1 mg/ml for 180 ± 15 min at standard culture conditions. The vital dye MTT is reduced into a blue MTT formazan precipitate by the viable cells of the RhCE tissue construct. The precipitated blue MTT formazan product is then extracted from the tissue using an appropriate volume of isopropanol (or a similar solvent) (34)(35). Tissues tested with liquid test chemicals should be extracted from both the top and the bottom of the tissues, while tissues tested with solid test chemicals and coloured liquids should be extracted from the bottom of the tissue only (to minimise any potential contamination of the isopropanol extraction solution with any test chemical that may have remained on the tissue). Tissues tested with liquid test chemicals that are not readily washed off may also be extracted from the bottom of the tissue only. The concurrently tested negative and positive control substances should be treated similarly to the tested chemical. The extracted MTT formazan may be quantified either by a standard absorbance (OD) measurement at 570 nm using a filter band pass of maximum ± 30 nm or by using an HPLC/UPLC-spectrophotometry procedure (see paragraph 42) (11)(36).

▼ **M8**

36. Optical properties of the test chemical or its chemical action on MTT may interfere with the measurement of MTT formazan leading to a false estimate of tissue viability. Test chemicals may interfere with the measurement of MTT formazan by direct reduction of the MTT into blue MTT formazan and/or by colour interference if the test chemical absorbs, naturally or due to treatment procedures, in the same OD range as MTT formazan (i.e., around 570 nm). Pre-checks should be performed before testing to allow identification of potential direct MTT reducers and/or colour interfering chemicals and additional controls should be used to detect and correct for potential interference from such test chemicals (see paragraphs 37-41). This is especially important when a specific test chemical is not completely removed from the RhCE tissue construct by rinsing or when it penetrates the cornea-like epithelium and is therefore present in the RhCE tissue constructs when the MTT assay is performed. For test chemicals absorbing light in the same range as MTT formazan (naturally or after treatment), which are not compatible with the standard absorbance (OD) measurement of MTT formazan due to too strong interference, i.e., strong absorption at 570 ± 30 nm, an HPLC/UPLC-spectrophotometry procedure to measure MTT formazan may be employed (see paragraphs 41 and 42) (11)(36). A detailed description of how to detect and correct for direct MTT reduction and interferences by colouring agents is available in the VRMs SOPs (34)(35). Illustrative flowcharts providing guidance on how to identify and handle direct MTT-reducers and/or colour interfering chemicals for VRM1 and VRM2 are also provided in Appendices III and IV, respectively.
37. To identify potential interference by test chemicals absorbing light in the same range as MTT formazan (naturally or after treatment) and decide on the need for additional controls, the test chemical is added to water and/or isopropanol and incubated for an appropriate time at room temperature (see Appendix 2, (34)(35)). If the test chemical in water and/or isopropanol absorbs sufficient light in the range of 570 ± 20 nm for VRM1 (see Appendix 3), or if a coloured solution is obtained when mixing the test chemical with water for VRM2 (see Appendix 4), the test chemical is presumed to interfere with the standard absorbance (OD) measurement of MTT formazan and further colourant controls should be performed or, alternatively, an HPLC/UPLC-spectrophotometry procedure should be used in which case these controls are not required (see paragraphs 41 and 42 and Appendices III and IV)(34)(35). When performing the standard absorbance (OD) measurement, each interfering test chemical should be applied on at least two viable tissue replicates, which undergo the entire testing procedure but are incubated with medium instead of MTT solution during the MTT incubation step, to generate a non-specific colour in living tissues (NSC_{living}) control (34)(35). The NSC_{living} control needs to be performed concurrently to the testing of the coloured test chemical and, in case of multiple testing, an independent NSC_{living} control needs to be conducted with each test performed (in each run) due to the inherent biological variability of living tissues. True tissue viability is calculated as: the percent tissue viability obtained with living tissues exposed to the interfering test chemical and incubated with MTT solution ($\%Viability_{\text{test}}$) minus the percent non-specific colour obtained with living tissues exposed to the interfering test chemical and incubated with medium without MTT, run concurrently to the test being corrected ($\%NSC_{\text{living}}$), i.e., True tissue viability = $[\%Viability_{\text{test}}] - [\%NSC_{\text{living}}]$.
38. To identify direct MTT reducers, each test chemical should be added to freshly prepared MTT solution. An appropriate amount of test chemical is added to a MTT solution and the mixture is incubated for approximately 3 hours at standard culture conditions (see Appendices III and IV)(34)(35). If the MTT mixture containing the test chemical (or suspension for insoluble

▼ **M8**

test chemicals) turns blue/purple, the test chemical is presumed to directly reduce MTT and a further functional check on non-viable RhCE tissue constructs should be performed, independently of using the standard absorbance (OD) measurement or an HPLC/UPLC-spectrophotometry procedure. This additional functional check employs killed tissues that possess only residual metabolic activity but absorb and retain the test chemical in a similar way as viable tissues. Killed tissues of VRM1 are prepared by exposure to low temperature ('freeze-killed'). Killed tissues of VRM2 are prepared by prolonged incubation (e.g. at least 24±1 hours) in water followed by storage to low temperature ('water-killed'). Each MTT reducing test chemical is applied on at least two killed tissue replicates, which undergo the entire testing procedure, to generate a non-specific MTT reduction (NSMTT) control (34)(35). A single NSMTT control is sufficient per test chemical regardless of the number of independent tests/runs performed. True tissue viability is calculated as: the percent tissue viability obtained with living tissues exposed to the MTT reducer (%Viability_{test}) minus the percent non-specific MTT reduction obtained with the killed tissues exposed to the same MTT reducer, calculated relative to the negative control run concurrently to the test being corrected (%NSMTT), i.e., True tissue viability = [%Viability_{test}] - [%NSMTT].

39. Test chemicals that are identified as producing both colour interference (see paragraph 37) and direct MTT reduction (see paragraph 38) will also require a third set of controls when performing the standard absorbance (OD) measurement, apart from the NSMTT and NSC_{living} controls described in the previous paragraphs. This is usually the case with darkly coloured test chemicals absorbing light in the range of 570±30 nm (e.g. blue, purple, black) because their intrinsic colour impedes the assessment of their capacity to directly reduce MTT as described in paragraph 38. This forces the use of NSMTT controls, by default, together with the NSC_{living} controls. Test chemicals for which both NSMTT and NSC_{living} controls are performed may be absorbed and retained by both living and killed tissues. Therefore, in this case, the NSMTT control may not only correct for potential direct MTT reduction by the test chemical, but also for colour interference arising from the absorption and retention of the test chemical by killed tissues. This could lead to double correction for colour interference since the NSC_{living} control already corrects for colour interference arising from the absorption and retention of the test chemical by living tissues. To avoid a possible double correction for colour interference, a third control for non-specific colour in killed tissues (NSC_{killed}) needs to be performed (see Appendices III and IV)(34)(35). In this additional control, the test chemical is applied on at least two killed tissue replicates, which undergo the entire testing procedure but are incubated with medium instead of MTT solution during the MTT incubation step. A single NSC_{killed} control is sufficient per test chemical regardless of the number of independent tests/runs performed, but should be performed concurrently to the NSMTT control and with the same tissue batch. True tissue viability is calculated as: the percent tissue viability obtained with living tissues exposed to the test chemical (%Viability_{test}) minus %NSMTT minus %NSC_{living} plus the percent non-specific colour obtained with killed tissues exposed to the interfering test chemical and incubated with medium without MTT, calculated relative to the negative control run concurrently to the test being corrected (%NSC_{killed}), i.e., True tissue viability = [%Viability_{test}] - [%NSMTT] - [%NSC_{living}] + [%NSC_{killed}].

▼ M8

40. It is important to note that non-specific MTT reduction and non-specific colour interferences may increase the OD (when performing standard absorbance measurements) of the tissue extract above the linearity range of the spectrophotometer and that non-specific MTT reduction can also increase the MTT formazan peak area (when performing HPLC/UPLC-spectrophotometry measurements) of the tissue extract above the linearity range of the spectrophotometer. On this basis, it is important for each laboratory to determine the OD/peak area linearity range of their spectrophotometer with e.g. MTT formazan (CAS # 57 360-69-7), commercially available from e.g. Sigma-Aldrich (Cat# M2003), before initiating the testing of test chemicals for regulatory purposes.
41. The standard absorbance (OD) measurement using a spectrophotometer is appropriate to assess direct MTT-reducers and colour interfering test chemicals, when the observed interference with the measurement of MTT formazan is not too strong (i.e., the ODs of the tissue extracts obtained with the test chemical without any correction for direct MTT reduction and/or colour interference are within the linear range of the spectrophotometer). Nevertheless, results for test chemicals producing %NSMTT and/or %NSC_{living} ≥ 60 % (VRM1, and VRM2 for liquids' protocol) or 50 % (VRM2 for solids' protocol) of the negative control should be taken with caution as this is the established cut-off used in the VRMs to distinguish classified from not classified chemicals (see paragraph 44). Standard absorbance (OD) can however not be measured when the interference with the measurement of MTT formazan is too strong (i.e., leading to uncorrected ODs of the test tissue extracts falling outside of the linear range of the spectrophotometer). Coloured test chemicals or test chemicals that become coloured in contact with water or isopropanol that interfere too strongly with the standard absorbance (OD) measurement of MTT formazan may still be assessed using HPLC/UPLC-spectrophotometry (see Appendices III and IV). This is because the HPLC/UPLC system allows for the separation of the MTT formazan from the chemical before its quantification (36). For this reason, NSC_{living} or NSC_{killed} controls are never required when using HPLC/UPLC-spectrophotometry, independently of the chemical being tested. NSMTT controls should nevertheless be used if the test chemical is suspected to directly reduce MTT (following the procedure described in paragraph 38). NSMTT controls should also be used with test chemicals having a colour (intrinsic or appearing when in water) that impedes the assessment of their capacity to directly reduce MTT as described in paragraph 38. When using HPLC/UPLC-spectrophotometry to measure MTT formazan, the percent tissue viability is calculated as percent MTT formazan peak area obtained with living tissues exposed to the test chemical relative to the MTT formazan peak obtained with the concurrent negative control. For test chemicals able to directly reduce MTT, true tissue viability is calculated as: %Viability_{test} minus %NSMTT, as described in the last sentence of paragraph 38. Finally, it should be noted that direct MTT-reducers or direct MTT-reducers that are also colour interfering, which are retained in the tissues after treatment and reduce MTT so strongly that they lead to ODs (using standard OD measurement) or peak areas (using UPLC/HPLC-spectrophotometry) of the tested tissue extracts that fall outside of the linearity range of the spectrophotometer cannot be assessed with RhCE test methods, although these are expected to occur in only very rare situations.
42. HPLC/UPLC-spectrophotometry may be used with all types of test chemicals (coloured, non-coloured, MTT-reducers and non-MTT reducers) for measurement of MTT formazan (11)(36). Due to the diversity of HPLC/UPLC-spectrophotometry systems, it is not feasible for each user to

▼M8

establish the exact same system conditions. As such, qualification of the HPLC/UPLC-spectrophotometry system should be demonstrated before its use to quantify MTT formazan from tissue extracts by meeting the acceptance criteria for a set of standard qualification parameters based on those described in the U.S. Food and Drug Administration guidance for industry on bioanalytical method validation (36)(38). These key parameters and their acceptance criteria are shown in Appendix 5. Once the acceptance criteria defined in Appendix 5 have been met, the HPLC/UPLC-spectrophotometry system is considered qualified and ready to measure MTT formazan under the experimental conditions described in this test method.

Acceptance Criteria

43. For each run using RhCE tissue batches that met the quality control (see paragraph 30), tissues treated with the negative control substance should exhibit OD reflecting the quality of the tissues that followed shipment, receipt steps and all protocol processes and should not be outside the historically established boundaries described in Table 2 (see paragraph 26). Similarly, tissues treated with the positive control substance, i.e., methyl acetate, should show a mean tissue viability < 50 % relative to the negative control in the VRM1 with either the liquids' or the solids' protocols, and ≤ 30 % (liquids' protocol) or ≤ 20 % (solids' protocol) relative to the negative control in the VRM2, thus reflecting the ability of the tissues to respond to an irritant test chemical under the conditions of the test method (34)(35). The variability between tissue replicates of test chemicals and control substances should fall within the accepted limits (i.e., the difference of viability between two tissue replicates should be less than 20 % or the standard deviation (SD) between three tissue replicates should not exceed 18 %). If either the negative control or positive control included in a run is outside of the accepted ranges, the run is considered 'non-qualified' and should be repeated. If the variability between tissue replicates of a test chemical is outside of the accepted range, the test must be considered 'non-qualified' and the test chemical should be re-tested.

Interpretation of Results and Prediction Model

44. The OD values/peak areas obtained with the replicate tissue extracts for each test chemical should be used to calculate the mean percent tissue viability (mean between tissue replicates) normalised to the negative control, which is set at 100 %. The percentage tissue viability cut-off value for identifying test chemicals not requiring classification for eye irritation or serious eye damage (UN GHS and CLP No Category) is given in Table 4. Results should thus be interpreted as follows:

- The test chemical is identified as not requiring classification and labelling according to UN GHS and CLP (No Category) if the mean percent tissue viability after exposure and post-exposure incubation is more than (>) the established percentage tissue viability cut-off value, as shown in Table 4. In this case no further testing in other test methods is required.

▼M8

- If the mean percent tissue viability after exposure and post-exposure incubation is less than or equal (\leq) to the established percentage tissue viability cut-off value, no prediction can be made, as shown in Table 4. In this case, further testing with other test methods will be required because RhCE test methods show a certain number of false positive results (see paragraphs 14-15) and cannot resolve between UN GHS and CLP Categories 1 and 2 (see paragraph 17).

Table 4

Prediction Models according to UN GHS and CLP classification

VRM	No Category	No prediction can be made
VRM 1 - EpiOcular™ EIT (for both protocols)	Mean tissue viability > 60 %	Mean tissue viability \leq 60 %
VRM 2 - SkinEthic™ HCE EIT (for the liquids' protocol)	Mean tissue viability > 60 %	Mean tissue viability \leq 60 %
VRM2 - SkinEthic™ HCE EIT (for the solids' protocol)	Mean tissue viability > 50 %	Mean tissue viability \leq 50 %

45. A single test composed of at least two tissue replicates should be sufficient for a test chemical when the result is unequivocal. However, in cases of borderline results, such as non-concordant replicate measurements and/or mean percent tissue viability equal to 60 ± 5 % (VRM1, and VRM2 for liquids' protocol) or 50 ± 5 % (VRM2 for solids' protocol), a second test should be considered, as well as a third one in case of discordant results between the first two tests.
46. Different percentage tissue viability cut-off values distinguishing classified from non-classified test chemicals may be considered for specific types of mixtures, where appropriate and justifiable, in order to increase the overall performance of the test method for those types of mixtures (see paragraph 14). Benchmark chemicals may be useful for evaluating the serious eye damage/eye irritation potential of unknown test chemicals or product class, or for evaluating the relative ocular toxicity potential of a classified chemical within a specific range of positive responses.

DATA AND REPORTING**Data**

47. Data from individual replicate tissues in a run (e.g. OD values/MTT formazan peak areas and calculated percent tissue viability data for the test chemical and controls, and the final RhCE test method prediction) should be reported in tabular form for each test chemical, including data from repeat tests, as appropriate. In addition, mean percent tissue viability and difference of viability between two tissue replicates (if $n=2$ replicate tissues) or SD (if $n\geq 3$ replicate tissues) for each individual test chemical and control should be reported. Any observed interferences of a test chemical with the measurement of MTT formazan through direct MTT reduction and/or coloured interference should be reported for each tested chemical.

Test Report

48. The test report should include the following information:

▼M8*Test Chemical*

Mono-constituent substance

- Chemical identification, such as IUPAC or CAS name(s), CAS registry number(s), SMILES or InChI code, structural formula, and/or other identifiers;
- Physical state, volatility, pH, LogP, molecular weight, chemical class, and additional relevant physicochemical properties relevant to the conduct of the study, to the extent available;
- Purity, chemical identity of impurities as appropriate and practically feasible, *etc.*;
- Treatment prior to testing, if applicable (e.g. warming, grinding);
- Storage conditions and stability to the extent available.

Multi-constituent substance, UVCB and mixture

- Characterisation as far as possible by e.g. chemical identity (see above), purity, quantitative occurrence and relevant physicochemical properties (see above) of the constituents, to the extent available;
- Physical state and additional relevant physicochemical properties relevant to the conduct of the study, to the extent available;
- Purity, chemical identity of impurities as appropriate and practically feasible, *etc.*;
- Treatment prior to testing, if applicable (e.g. warming, grinding);
- Storage conditions and stability to the extent available.

Positive and Negative Control Substances

- Chemical identification, such as IUPAC or CAS name(s), CAS registry number(s), SMILES or InChI code, structural formula, and/or other identifiers;
- Physical state, volatility, molecular weight, chemical class, and additional relevant physicochemical properties relevant to the conduct of the study, to the extent available;
- Purity, chemical identity of impurities as appropriate and practically feasible, *etc.*;
- Treatment prior to testing, if applicable (e.g. warming, grinding);
- Storage conditions and stability to the extent available;
- Justification for the use of a different negative control than ultrapure H₂O or Ca²⁺/Mg²⁺-free DPBS, if applicable;
- Justification for the use of a different positive control than neat methyl acetate, if applicable;
- Reference to historical positive and negative control results demonstrating suitable run acceptance criteria.

Information Concerning the Sponsor and the Test Facility

- Name and address of the sponsor, test facility and study director.
- *RhCE Tissue Construct and Protocol Used (providing rationale for the choices, if applicable)*

▼ M8*Test Method Conditions*

- RhCE tissue construct used, including batch number;

- Wavelength and band pass (if applicable) used for quantifying MTT formazan, and linearity range of measuring device (e.g. spectrophotometer);

- Description of the method used to quantify MTT formazan;

- Description of the HPLC/UPLC-spectrophotometry system used, if applicable;

- Complete supporting information for the specific RhCE tissue construct used including its performance. This should include, but is not limited to:
 - i) Viability quality control (supplier)

 - ii) Viability under test method conditions (user);

 - iii) Barrier function quality control;

 - iv) Morphology, if available;

 - v) Reproducibility and predictive capacity;

 - vi) Other quality controls (QC) of the RhCE tissue construct, if available;

- Reference to historical data of the RhCE tissue construct. This should include, but is not limited to: Acceptability of the QC data with reference to historical batch data;

- Statement that the testing facility has demonstrated proficiency in the use of the test method before routine use by testing of the proficiency chemicals;

Run and Test Acceptance Criteria

- Positive and negative control means and acceptance ranges based on historical data;

- Acceptable variability between tissue replicates for positive and negative controls;

- Acceptable variability between tissue replicates for the test chemical;

Test Procedure

- Details of the test procedure used;

- Doses of test chemical and control substances used;

- Duration and temperature of exposure, post-exposure immersion and post-exposure incubation periods (where applicable);

- Description of any modifications to the test procedure;

▼M8

- Indication of controls used for direct MTT-reducers and/or colouring test chemicals, if applicable;

- Number of tissue replicates used per test chemical and controls (positive control, negative control, NSMTT, NSCliving and NSCKilled, if applicable);

Results

- Tabulation of data from individual test chemicals and control substances for each run (including repeat experiments where applicable) and each replicate measurement, including OD value or MTT formazan peak area, percent tissue viability, mean percent tissue viability, Difference between tissue replicates or SD, and final prediction;

- If applicable, results of controls used for direct MTT-reducers and/or coloured test chemicals, including OD value or MTT formazan peak area, %NSMTT, %NSCliving, %NSCKilled, Difference between tissue replicates or SD, final correct percent tissue viability, and final prediction;

- Results obtained with the test chemical(s) and control substances in relation to the define run and test acceptance criteria;

- Description of other effects observed, e.g. coloration of the tissues by a coloured test chemical;

*Discussion of the Results**Conclusion***LITERATURE**

- (1) UN (2015). United Nations Globally Harmonized System of Classification and Labelling of Chemicals (GHS). ST/SG/AC.10/30/Rev.6, Sixth Revised Edition, New York and Geneva: United Nations. Available at: http://www.unece.org/fileadmin/DAM/trans/danger/publi/ghs/ghs_rev06/English/ST-SG-AC10-30-Rev6e.pdf

- (2) Chapter B.5 of this Annex, Acute Eye Irritation/Corrosion.

- (3) Chapter B.47 of this Annex, Bovine Corneal Opacity and Permeability Test Method for Identifying i) Chemicals Inducing Serious Eye Damage and ii) Chemicals Not Requiring Classification for Eye Irritation or Serious Eye Damage.

- (4) Chapter B.48 of this Annex, Isolated Chicken Eye Test Method for Identifying i) Chemicals Inducing Serious Eye Damage and ii) Chemicals Not Requiring Classification.

- (5) Chapter B.61 of this Annex, Fluorescein Leakage Test Method for Identifying Ocular Corrosives and Severe Irritants.

▼M8

- (6) Chapter B.68 of this Annex, Short Time Exposure *In Vitro* Test Method for Identifying i) Chemicals Inducing Serious Eye Damage and ii) Chemicals Not Requiring Classification for Eye Irritation or Serious Eye Damage.
- (7) Freeman, S.J., Alépée N., Barroso, J., Cole, T., Compagnoni, A., Rubingh, C., Eskes, C., Lammers, J., McNamee, P., Pfannenbecker, U., Zuang, V. (2010). Prospective Validation Study of Reconstructed Human Tissue Models for Eye Irritation Testing. *ALTEX* 27, Special Issue 2010, 261-266.
- (8) EC EURL ECVAM (2014). The EURL ECVAM - Cosmetics Europe prospective validation study of Reconstructed human Cornea-like Epithelium (RhCE)-based test methods for identifying chemicals not requiring classification and labelling for serious eye damage/eye irritation: Validation Study Report. EUR 28 125 EN; doi:10.2787/41680. Available at: <http://publications.jrc.ec.europa.eu/repository/handle/JRC100280>
- (9) EURL ECVAM Science Advisory Committee (2014). ESAC Opinion on the EURL ECVAM Eye Irritation Validation Study (EIVS) on EpiOcular™ EIT and SkinEthic™ HCE and a related Cosmetics Europe study on HPLC/UPLC-spectrophotometry as an alternative endpoint detection system for MTT-formazan. ESAC Opinion No 2014-03 of 17 November 2014; EUR 28 173 EN; doi: 10.2787/0436 97. Available at: <http://publications.jrc.ec.europa.eu/repository/handle/JRC103702>
- (10) Alépée, N., Leblanc, V., Adriaens, E., Grandidier, M.H., Lelièvre, D., Meloni, M., Nardelli, L., Roper, C.S, Santirocco, E., Toner, F., Van Rompay, A., Vinall, J., Cotovio, J. (2016). Multi-laboratory validation of SkinEthic HCE test method for testing serious eye damage/eye irritation using liquid chemicals. *Toxicol. In Vitro* 31, 43-53.
- (11) Alépée, N., Adriaens, E., Grandidier, M.H., Meloni, M., Nardelli, L., Vinall, C.J., Toner, F., Roper, C.S, Van Rompay, A.R., Leblanc, V., Cotovio, J. (2016). Multi-laboratory evaluation of SkinEthic HCE test method for testing serious eye damage/eye irritation using solid chemicals and overall performance of the test method with regard to solid and liquid chemicals testing. *Toxicol. In Vitro* 34, 55-70.
- (12) URL ECVAM Science Advisory Committee (2016). ESAC Opinion on the SkinEthic™ Human Corneal Epithelium (HCE) Eye Irritation Test (EIT). ESAC Opinion No 2016-02 of 24 June 2016; EUR 28 175 EN; doi: 10.2787/3903 90. Available at: <http://publications.jrc.ec.europa.eu/repository/handle/JRC103704>
- (13) EC EURL ECVAM (2016). Recommendation on the Use of the Reconstructed human Cornea-like Epithelium (RhCE) Test Methods for Identifying Chemicals not Requiring Classification and Labelling for Serious Eye Damage/Eye Irritation According to UN GHS. (Manuscript in Preparation).
- (14) Draize, J.H., Woodard, G., Calvery, H.O. (1944). Methods for the Study of Irritation and Toxicity of Substances Applied Topically to the Skin and Mucous Membranes. *Journal of Pharmacol. and Exp. Therapeutics* 82, 377-390.
- (15) Scott, L., Eskes, C., Hoffmann, S., Adriaens, E., Alépée, N., Bufo, M., Clothier, R., Facchini, D., Faller, C., Guest, R., Harbell, J., Hartung, T., Kamp, H., Le Varlet, B., Meloni, M., McNamee, P., Osborne, R., Pape, W., Pfannenbecker, U., Prinsen, M., Seaman, C., Spielman, H., Stokes, W., Trouba, K., Van den Berghe, C., Van Goethem, F., Vassallo, M., Vinardell, P., Zuang, V. (2010). A Proposed Eye Irritation Testing Strategy to Reduce and Replace *In Vivo* Studies Using Bottom-Up and Top-Down Approaches. *Toxicol. In Vitro* 24, 1-9.

▼ M8

- (16) Mosmann, T. (1983). Rapid Colorimetric Assay for Cellular Growth and Survival: Application to Proliferation and Cytotoxicity Assays. *J. Immunol. Methods* 65, 55-63.
- (17) OECD (2016). Series on Testing and Assessment No 216: Performance Standards for the Assessment of Proposed Similar or Modified *In Vitro* Reconstructed Human Cornea-Like Epithelium (RhCE) Test Methods for Identifying Chemicals not Requiring Classification and Labelling for Eye Irritation or Serious Eye Damage, Based on the Validated Reference Methods EpiOcular™ EIT and SkinEthic™ HCE EIT described in TG 492. Organisation for Economic Cooperation and Development, Paris.
- (18) OECD (2005). Series on Testing and Assessment No 34: Guidance Document on the Validation and International Acceptance of New or Updated Test Methods for Hazard Assessment. Organisation for Economic Cooperation and Development, Paris.
- (19) Kaluzhny, Y., Kandárová, H., Hayden, P., Kubilus, J., d'Argembeau-Thornton, L., Klausner, M. (2011). Development of the EpiOcular™ Eye Irritation Test for Hazard Identification and Labelling of Eye Irritating Chemicals in Response to the Requirements of the EU Cosmetics Directive and REACH Legislation. *Altern. Lab. Anim.* 39, 339-364.
- (20) Nguyen, D.H., Beuerman, R.W., De Wever, B., Rosdy, M. (2003). Three-dimensional construct of the human corneal epithelium for *in vitro* toxicology. In: Salem, H., Katz, S.A. (Eds), *Alternative Toxicological Methods*, CRC Press, pp. 147-159.
- (21) Pfannenbecker, U., Bessou-Touya, S., Faller, C., Harbell, J., Jacob, T., Raabe, H., Tailhardat, M., Alépée, N., De Smedt, A., De Wever, B., Jones, P., Kaluzhny, Y., Le Varlet, B., McNamee, P., Marrec-Fairley, M., Van Goethem, F. (2013). Cosmetics Europe multi-laboratory pre-validation of the EpiOcular™ reconstituted Human Tissue Test Method for the Prediction of Eye Irritation. *Toxicol. In Vitro* 27, 619-626.
- (22) Alépée, N., Bessou-Touya, S., Cotovio, J., de Smedt, A., de Wever, B., Faller, C., Jones, P., Le Varlet, B., Marrec-Fairley, M., Pfannenbecker, U., Tailhardat, M., van Goethem, F., McNamee, P. (2013). Cosmetics Europe Multi-Laboratory Pre-Validation of the SkinEthic™ Reconstituted Human Corneal Epithelium Test Method for the Prediction of Eye Irritation. *Toxicol. In Vitro* 27, 1 476-1 488.
- (23) Kolle, S.N., Moreno, M.C.R., Mayer, W., van Cott, A., van Ravenzwaay, B., Landsiedel, R. (2015). The EpiOcular™ Eye Irritation Test is the Method of Choice for *In Vitro* Eye Irritation Testing of Agrochemical Formulations: Correlation Analysis of EpiOcular™ Eye Irritation Test and BCOP Test Data to UN GHS, US EPA and Brazil ANIVSA Classifications. *Altern. Lab. Anim.* 43, 1-18.
- (24) Adriaens, E., Barroso, J., Eskes, C., Hoffmann, S., McNamee, P., Alépée, N., Bessou-Touya, S., De Smedt, A., De Wever, B., Pfannenbecker, U., Tailhardat, M., Zuang, V. (2014). Retrospective Analysis of the Draize Test for Serious Eye Damage/Eye Irritation: Importance of Understanding the *In Vivo* Endpoints Under UN GHS/EU CLP for the Development and Evaluation of *In Vitro* Test Methods. *Arch. Toxicol.* 88, 701-723.
- (25) Barroso, J., Pfannenbecker, U., Adriaens, E., Alépée, N., Cluzel, M., De Smedt, A., Hibatallah, J., Klaric, M., Mewes, K.R., Millet, M., Templier, M., McNamee, P. (2017). Cosmetics Europe compilation of historical serious eye damage/eye irritation *in vivo* data analysed by drivers of classification to support the selection of chemicals for development and evaluation of alternative methods/strategies: the Draize eye test Reference Database (DRD). *Arch. Toxicol.* 91, 521-547.
- (26) Meloni, M., De Servi, B., Marasco, D., Del Prete, S. (2011). Molecular mechanism of ocular surface damage: Application to an *in vitro* dry eye model on human corneal epithelium. *Molecular Vision* 17, 113-126.

▼ M8

- (27) Hackett, R.B., McDonald, T.O. (1991). Eye Irritation. In *Advances in Modern Toxicology: Dermatoxicology* Marzulli F.N. and Maibach H.I. (Eds.), 4th Edition, pp. 749–815. Washington, DC, USA: Hemisphere Publishing Corporation.
- (28) Fox, D.A., Boyes, W.K. (2008). Toxic Responses of the Ocular and Visual System. In Cassaret and Doull's *Toxicology: The Basic Science of Poisons* Klaassen C.D.(Ed.), 7th Edition, pp. 665–697. Withby, ON, Canada: McGraw-Hill Ryerson.
- (29) Jester, J.V., Li, H.F., Petroll, W.M., Parker, R.D., Cavanagh, H.D., Carr, G.J., Smith, B., Maurer, J.K. (1998). Area and Depth of Surfactant Induced Corneal Injury Correlates with Cell Death. *Invest. Ophthalmol. Vis. Sci.* 39, 922–936.
- (30) Maurer, J.K., Parker, R.D., Jester, J.V. (2002). Extent of Corneal Injury as the Mechanistic Basis for Ocular Irritation: Key Findings and Recommendations for the Development of Alternative Assays. *Reg. Tox. Pharmacol.* 36, 106-117.
- (31) Jester, J.V., Li, L., Molai, A., Maurer, J.K. (2001). Extent of Corneal Injury as a Mechanistic Basis for Alternative Eye Irritation Tests. *Toxicol. In Vitro* 15, 115–130.
- (32) Jester, J.V., Petroll, W.M., Bean, J., Parker, R.D., Carr, G.J., Cavanagh, H.D., Maurer, J.K. (1998). Area and Depth of Surfactant-Induced Corneal Injury Predicts Extent of Subsequent Ocular Responses. *Invest. Ophthalmol. Vis. Sci.* 39, 2 610–2 625.
- (33) Jester, J.V. (2006). Extent of Corneal Injury as a Biomarker for Hazard Assessment and the Development of Alternative Models to the Draize Rabbit Eye Test. *Cutan. Ocul. Toxicol.* 25, 41–54.
- (34) EpiOcular™ EIT SOP, Version 8 (March 05, 2013). EpiOcular™ EIT for the Prediction of Acute Ocular Irritation of Chemicals. Available at: [<https://ecvam-dbalm.jrc.ec.europa.eu/beta/index.cfm/methodsAndProtocols/index>].
- (35) SkinEthic™ HCE EIT SOP, Version 1. (July 20, 2015). SkinEthic™ HCE Eye Irritation Test (EITL for Liquids, EITS for Solids) for the Prediction of Acute Ocular Irritation of Chemicals. Available at: <https://ecvam-dbalm.jrc.ec.europa.eu/beta/index.cfm/methodsAndProtocols/index>
- (36) Alépée, N., Barroso, J., De Smedt, A., De Wever, B., Hibatallah, J., Klaric, M., Mewes, K.R., Millet, M., Pfannenbecker, U., Tailhardat, M., Templier, M., McNamee, P. (2015). Use of HPLC/UPLC-Spectrophotometry for Detection of Formazan in *In Vitro* Reconstructed Human Tissue (RhT)-Based Test Methods Employing the MTT-Reduction Assay to Expand their Applicability to Strongly Coloured Test Chemicals. *Toxicol. In Vitro* 29, 741-761.
- (37) Kaluzhny, Y., Kandárová, H., Handa, Y., DeLuca, J., Truong, T., Hunter, A., Kearney, P., d'Argembeau-Thornton, L., Klausner, M. (2015). EpiOcular™ Eye Irritation Test (EIT) for Hazard Identification and Labeling of Eye Irritating Chemicals: Protocol Optimization for Solid Materials and Extended Shipment Times. *Altern. Lab Anim.* 43, 101-127.
- (38) US FDA (2001). Guidance for Industry: Bioanalytical Method Validation. U.S. Department of Health and Human Services, Food and Drug Administration. May 2001. Available at: <http://www.fda.gov/downloads/Drugs/Guidances/ucm070107.pdf>
- (39) OECD (2017). Guidance Document on an Integrated Approaches on Testing and Assessment for Serious Eye Damage and Eye irritation. Series on Testing and Assessment No 263. ENV Publications, Organisation for Economic Cooperation and Development, Paris.

▼M8*Appendix 1*

DEFINITIONS

Accuracy: The closeness of agreement between test method results and accepted reference values. It is a measure of test method performance and one aspect of 'relevance.' The term is often used interchangeably with 'concordance', to mean the proportion of correct outcomes of a test method (18).

Benchmark chemical: A chemical used as a standard for comparison to a test chemical. A benchmark chemical should have the following properties: (i) consistent and reliable source(s) for its identification and characterisation; (ii) structural, functional and/or chemical or product class similarity to the chemical(s) being tested; (iii) known physicochemical characteristics; (iv) supporting data on known effects; and (v) known potency in the range of the desired response.

Bottom-Up approach: Step-wise approach used for a test chemical suspected of not requiring classification and labelling for eye irritation or serious eye damage, which starts with the determination of chemicals not requiring classification and labelling (negative outcome) from other chemicals (positive outcome).

Chemical: A substance or mixture.

Concordance: See 'Accuracy'.

Cornea: The transparent part of the front of the eyeball that covers the iris and pupil and admits light to the interior.

CV: Coefficient of Variation.

Dev: Deviation.

EIT: Eye Irritation Test.

EURL ECVAM: European Union Reference Laboratory for Alternatives to Animal Testing.

Eye irritation: Production of changes in the eye following the application of a test chemical to the anterior surface of the eye, which are fully reversible within 21 days of application. Interchangeable with 'Reversible effects on the eye' and with 'UN GHS/CLP Category 2'.

ET₅₀: Exposure time required to reduce tissue viability by 50 % upon application of a benchmark chemical at a specified, fixed concentration.

False negative rate: The proportion of all positive substances falsely identified by a test method as negative. It is one indicator of test method performance.

False positive rate: The proportion of all negative substances that are falsely identified by a test method as positive. It is one indicator of test method performance.

Hazard: Inherent property of an agent or situation having the potential to cause adverse effects when an organism, system or (sub) population is exposed to that agent.

HCE: SkinEthic™ Human Corneal Epithelium.

▼M8

HPLC: High Performance Liquid Chromatography.

IC₅₀: Concentration at which a benchmark chemical reduces the viability of the tissues by 50 % following a fixed exposure time (e.g. 30 minutes treatment with SDS).

Infinite dose: Amount of test chemical applied to the RhCE tissue construct exceeding the amount required to completely and uniformly cover the epithelial surface.

Irreversible effects on the eye: See ‘Serious eye damage’.

LLOQ: Lower Limit of Quantification.

LogP: Logarithm of the octanol-water partitioning coefficient

Mixture: A mixture or a solution composed of two or more substances.

Mono-constituent substance: A substance, defined by its quantitative composition, in which one main constituent is present to at least 80 % (w/w).

Multi-constituent substance: A substance, defined by its quantitative composition, in which more than one main constituent is present in a concentration ≥ 10 % (w/w) and < 80 % (w/w). A multi-constituent substance is the result of a manufacturing process. The difference between mixture and multi-constituent substance is that a mixture is obtained by blending of two or more substances without chemical reaction. A multi-constituent substance is the result of a chemical reaction.

MTT: 3-(4,5-Dimethylthiazol-2-yl)-2,5-diphenyltetrazolium bromide; Thiazolyl blue tetrazolium bromide.

Negative control: A sample containing all components of a test system and treated with a substance known not to induce a positive response in the test system. This sample is processed with test chemical-treated samples and other control samples and is used to determine 100 % tissue viability.

Not Classified: Chemicals that are not classified for Eye irritation (UN GHS/CLP Category 2, UN GHS Category 2A or 2B) or Serious eye damage (UN GHS/CLP Category 1). Interchangeable with ‘UN GHS/CLP No Category’.

NSC_{killed}: Non-Specific Colour in killed tissues.

NSC_{living}: Non-Specific Colour in living tissues.

NSMTT: Non-Specific MTT reduction.

OD: Optical Density.

Performance standards: Standards, based on a validated test method which was considered scientifically valid, that provide a basis for evaluating the comparability of a proposed test method that is mechanistically and functionally similar. Included are: (i) essential test method components; (ii) a minimum list of Reference Chemicals selected from among the chemicals used to demonstrate the acceptable performance of the validated test method; and (iii) the comparable levels of accuracy and reliability, based on what was obtained for the validated test method, that the proposed test method should demonstrate when evaluated using the minimum list of Reference Chemicals (18).

▼ M8

Positive control: A sample containing all components of a test system and treated with a substance known to induce a positive response in the test system. This sample is processed with test chemical-treated samples and other control samples. To ensure that variability in the positive control response across time can be assessed, the magnitude of the positive response should not be excessive.

Relevance: Description of relationship of the test to the effect of interest and whether it is meaningful and useful for a particular purpose. It is the extent to which the test correctly measures or predicts the biological effect of interest. Relevance incorporates consideration of the accuracy (concordance) of a test method (18).

Reliability: Measures of the extent that a test method can be performed reproducibly within and between laboratories over time, when performed using the same protocol. It is assessed by calculating intra- and inter-laboratory reproducibility and intra-laboratory repeatability (18).

Replacement test: A test which is designed to substitute for a test that is in routine use and accepted for hazard identification and/or risk assessment, and which has been determined to provide equivalent or improved protection of human or animal health or the environment, as applicable, compared to the accepted test, for all possible testing situations and chemicals (18).

Reproducibility: The agreement among results obtained from repeated testing of the same test chemical using the same test protocol (See 'Reliability') (18).

Reversible effects on the eye: See 'Eye irritation'.

RhCE: Reconstructed human Cornea-like Epithelium.

Run: A run consists of one or more test chemicals tested concurrently with a negative control and with a positive control.

SD: Standard Deviation.

Sensitivity: The proportion of all positive/active test chemicals that are correctly classified by the test. It is a measure of accuracy for a test method that produces categorical results, and is an important consideration in assessing the relevance of a test method (18).

▼M8

Serious eye damage: Production of tissue damage in the eye, or serious physical decay of vision, following application of a test substance to the anterior surface of the eye, which is not fully reversible within 21 days of application. Interchangeable with 'Irreversible effects on the eye' and with 'UN GHS and CLP Category 1'.

Standard Operating Procedures (SOP): Formal, written procedures that describe in detail how specific routine, and test-specific, laboratory operations should be performed. They are required by GLP.

Specificity: The proportion of all negative/inactive test chemicals that are correctly classified by the test. It is a measure of accuracy for a test method that produces categorical results and is an important consideration in assessing the relevance of a test method (18).

Substance: A chemical element and its compounds in the natural state or obtained by any production process, including any additive necessary to preserve its stability and any impurities deriving from the process used, but excluding any solvent which may be separated without affecting the stability of the substance or changing its composition.

Test: A single test chemical concurrently tested in a minimum of two tissue replicates as defined in the corresponding SOP.

Tissue viability: Parameter measuring total activity of a cell population in a reconstructed tissue as their ability to reduce the vital dye MTT, which, depending on the endpoint measured and the test design used, correlates with the total number and/or vitality of living cells.

Top-Down approach: Step-wise approach used for a chemical suspected of causing serious eye damage, which starts with the determination of chemicals inducing serious eye damage (positive outcome) from other chemicals (negative outcome).

Test chemical: Any substance or mixture tested using this test method.

Tiered testing strategy: A stepwise testing strategy, which uses test methods in a sequential manner. All existing information on a test chemical is reviewed at each tier, using a weight-of-evidence process, to determine if sufficient information is available for a hazard classification decision, prior to progression to the next tier in the strategy. If the hazard potential/potency of a test chemical can be assigned based on the existing information at a given tier, no additional testing is required (18).

ULOQ: Upper Limit of Quantification.

United Nations Globally Harmonized System of Classification and Labelling of Chemicals (UN GHS): A system proposing the classification of chemicals (substances and mixtures) according to standardised types and levels of physical, health and environmental hazards, and addressing corresponding communication elements, such as pictograms, signal words, hazard statements, precautionary statements and safety data sheets, so that to convey information on their adverse effects with a view to protect people (including employers, workers, transporters, consumers and emergency responders) and the environment (1).

UN GHS and CLP Category 1: See 'Serious eye damage'.

UN GHS and CLP Category 2: See 'Eye irritation'.

UN GHS and CLP No Category: Chemicals that do not meet the requirements for classification as UN GHS/CLP Category 1 or 2 (or UN GHS Category 2A or 2B). Interchangeable with 'Not Classified'.

UPLC: Ultra-High Performance Liquid Chromatography.

▼ M8

UVCB: substances of unknown or variable composition, complex reaction products or biological materials.

Valid test method: A test method considered to have sufficient relevance and reliability for a specific purpose and which is based on scientifically sound principles. A test method is never valid in an absolute sense, but only in relation to a defined purpose (18).

Validated test method: A test method for which validation studies have been completed to determine the relevance (including accuracy) and reliability for a specific purpose. It is important to note that a validated test method may not have sufficient performance in terms of accuracy and reliability to be found acceptable for the proposed purpose (18).

VRM: Validated Reference Method.

VRM1: EpiOcular™ EIT is referred as the Validated Reference Method 1.

VRM2: SkinEthic™ HCE EIT is referred to as the Validated Reference Method 2.

Weight-of-evidence: The process of considering the strengths and weaknesses of various pieces of information in reaching and supporting a conclusion concerning the hazard potential of a test substance.

Appendix 2

MAIN TEST COMPONENTS OF THE RHCE TESTS VALIDATED FOR IDENTIFYING CHEMICALS NOT REQUIRING CLASSIFICATION AND LABELLING FOR EYE IRRITATION OR SEERIOUS EYE DAMAGE

Test Components	EpiOcular™ EIT (VRM 1)		SkinEthic™ HCE EIT (VRM 2)	
	Liquids (pipetteable at 37±1 °C or lower temperatures for 15 min)	Solids (not pipetteable)	Liquids and viscous (pipetteable)	Solids (not pipetteable)
Model surface	0,6 cm ²	0,6 cm ²	0,5 cm ²	0,5 cm ²
Number of tissue replicates	At least 2	At least 2	At least 2	At least 2
Pre-check for colour interference	<p>50 µl + 1 ml H₂O for 60 min at 37±2 °C, 5±1 % CO₂, ≥95 % RH (non-coloured test chemicals), or</p> <p>50 µl + 2 ml isopropanol mixed for 2-3h at RT (coloured test chemicals)</p> <p>→ if the OD of the test chemical at 570±20 nm, after subtraction of the OD for isopropanol or water is > 0.08 (which corresponds to approximately 5 % of the mean OD of the negative control), living adapted controls should be performed.</p>	<p>50 mg + 1 ml H₂O for 60 min at 37±2 °C, 5±1 % CO₂, ≥95 % RH (non-coloured test chemicals)</p> <p>and/or</p> <p>50 mg + 2 ml isopropanol mixed for 2-3h at RT (colored and non-colored test chemicals)</p> <p>→ if the OD of the test chemical at 570±20 nm after subtraction of the OD for isopropanol or water is > 0.08 (which corresponds to approximately 5 % of the mean OD of the negative control), living adapted controls should be performed.</p>	<p>10 µl + 90 µl H₂O mixed for 30±2 min at Room Temperature (RT, 18-28 °C)</p> <p>→ if test chemical is coloured, living adapted controls should be performed</p>	<p>10 mg + 90 µl H₂O mixed for 30±2 min at RT</p> <p>→ if test chemical is coloured, living adapted controls should be performed</p>

▼ M8

Test Components	EpiOcular™ EIT (VRM 1)		SkinEthic™ HCE EIT (VRM 2)	
Pre-check for direct MTT reduction	50 µl + 1 ml MTT 1 mg/ml solution for 180±15 min at 37±2 °C, 5±1 % CO ₂ , ≥95 % RH → if solution turns blue/purple, freeze-killed adapted controls should be performed (50 µl of sterile deionised water in MTT solution is used as negative control)	50 mg + 1 ml MTT 1 mg/ml solution for 180±15 min at 37±2 °C, 5±1 % CO ₂ , ≥95 % RH → if solution turns blue/purple, freeze-killed adapted controls should be performed (50 µl of sterile deionised water in MTT solution is used as negative control)	30 µl + 300 µl MTT 1 mg/ml solution for 180±15 min at 37±2 °C, 5±1 % CO ₂ , ≥95 % RH → if solution turns blue/purple, water-killed adapted controls should be performed (30 µl of sterile deionised water in MTT solution is used as negative control)	30 mg + 300 µl MTT 1 mg/ml solution for 180±15 min at 37±2 °C, 5±1 % CO ₂ , ≥95 % RH → if solution turns blue/purple, water-killed adapted controls should be performed (30 µl of sterile deionised water in MTT solution is used as negative control)
Pre-treatment	20 µl Ca ²⁺ /Mg ²⁺ -free DPBS for 30 ± 2 min at 37±2 °C, 5±1 % CO ₂ , ≥95 % RH, protected from light.	20 µl Ca ²⁺ /Mg ²⁺ -free DPBS for 30±2 min at 37±2 °C, 5±1 % CO ₂ , ≥95 % RH, protected from light.	—	—
Treatment doses and application	50 µl (83,3 µl/cm ²)	50 mg (83,3 mg/cm ²) using a calibrated tool (e.g. a levelled spoonful calibrated to hold 50 mg of sodium chloride).	10 µl Ca ²⁺ /Mg ²⁺ -free DPBS + 30 ± 2 µl (60 µl/cm ²) For viscous, use a nylon mesh	30 µl Ca ²⁺ /Mg ²⁺ -free DPBS + 30 ± 2 mg (60 mg/cm ²)
Exposure time and temperature	30 min (± 2 min) in culture medium at 37±2 °C, 5±1 % CO ₂ , ≥95 % RH	6 hours (± 0.25 h) in culture medium at 37±2 °C, 5±1 % CO ₂ , ≥95 % RH	30 min (± 2 min) in culture medium at 37±2 °C, 5±1 % CO ₂ , ≥95 % RH	4 hours (± 0.1 h) in culture medium at 37±2 °C, 5±1 % CO ₂ , ≥95 % RH
Rinsing at room temperature	3 times in 100 ml of Ca ²⁺ /Mg ²⁺ -free DPBS	3 times in 100 ml of Ca ²⁺ /Mg ²⁺ -free DPBS	20 ml Ca ²⁺ /Mg ²⁺ -free DPBS	25 ml Ca ²⁺ /Mg ²⁺ -free DPBS
Post-exposure immersion	12 min (± 2 min) at RT in culture medium	25 min (± 2 min) at RT in culture medium	30 min (± 2 min) at 37 °C, 5 % CO ₂ , 95 % RH in culture medium	30 min (± 2 min) at RT in culture medium

▼ M8

Test Components	EpiOcular™ EIT (VRM 1)		SkinEthic™ HCE EIT (VRM 2)	
	Post-exposure incubation	120 min (\pm 15 min) in culture medium at 37 \pm 2 °C, 5 \pm 1 % CO ₂ , \geq 95 % RH	18 h (\pm 0,25 h) in culture medium at 37 \pm 2 °C, 5 \pm 1 % CO ₂ , \geq 95 % RH	none
Negative control	50 μ l H ₂ O Tested concurrently	50 μ l H ₂ O Tested concurrently	30 \pm 2 μ l Ca ²⁺ /Mg ²⁺ -free DPBS Tested concurrently	30 \pm 2 μ l Ca ²⁺ /Mg ²⁺ -free DPBS Tested concurrently
Positive control	50 μ l Methyl acetate Tested concurrently	50 μ l Methyl acetate Tested concurrently	30 \pm 2 μ l Methyl acetate Tested concurrently	30 \pm 2 μ l Methyl acetate Tested concurrently
MTT solution	300 μ l 1 mg/ml	300 μ l 1 mg/ml	300 μ l 1 mg/ml	300 μ l 1 mg/ml
MTT incubation time and temperature	180 min (\pm 15 min) at 37 \pm 2 °C, 5 \pm 1 % CO ₂ , \geq 95 % RH	180 min (\pm 15 min) at 37 \pm 2 °C, 5 \pm 1 % CO ₂ , \geq 95 % RH	180 min (\pm 15 min) at 37 \pm 2 °C, 5 \pm 1 % CO ₂ , \geq 95 % RH	180 min (\pm 15 min) at 37 \pm 2 °C, 5 \pm 1 % CO ₂ , \geq 95 % RH
Extraction solvent	2 ml isopropanol (extraction from top and bottom of insert by piercing the tissue)	2 ml isopropanol (extraction from bottom of insert by piercing the tissue)	1.5 ml isopropanol (extraction from top and bottom of insert)	1.5 ml isopropanol (extraction from bottom of insert)
Extraction time and temperature	2-3 h with shaking (~120 rpm) at RT or overnight at 4-10 °C	2-3 h with shaking (~120 rpm) at RT or overnight at 4-10 °C	4 h with shaking (~120 rpm) at RT or at least overnight without shaking at 4-10 °C	At least 2 h with shaking (~120 rpm) at RT
OD reading	570 nm (550 - 590 nm) without reference filter	570 nm (550 - 590 nm) without reference filter	570 nm (540 - 600 nm) without reference filter	570 nm (540 - 600 nm) without reference filter
Tissue Quality Control	Treatment with 100 μ l of 0,3 % (v/v) Triton X-100 12.2 min \leq ET ₅₀ \leq 37,5 min	Treatment with 100 μ l of 0,3 % (v/v) Triton X-100 12.2 min \leq ET ₅₀ \leq 37,5 min	30 min treatment with SDS (50 μ l) 1,0 mg/ml \leq IC ₅₀ \leq 3,5 mg/ml	30 min treatment with SDS (50 μ l) 1,0 mg/ml \leq IC ₅₀ \leq 3,2 mg/ml

▼ M8

Test Components	EpiOcular™ EIT (VRM 1)		SkinEthic™ HCE EIT (VRM 2)	
Acceptance Criteria	<ol style="list-style-type: none"> 1. Mean OD of the tissue replicates treated with the negative control should be > 0,8 and < 2,5 2. Mean viability of the tissue replicates exposed for 30 min with the positive control, expressed as % of the negative control, should be < 50 % 3. The difference of viability between two tissue replicates should be less than 20 %. 	<ol style="list-style-type: none"> 1. Mean OD of the tissue replicates treated with the negative control should be > 0.8 and < 2.5 2. Mean viability of the tissue replicates exposed for 6 hours with the positive control, expressed as % of the negative control, should be < 50 % 3. The difference of viability between two tissue replicates should be less than 20 %. 	<ol style="list-style-type: none"> 1. Mean OD of the tissue replicates treated with the negative control should be > 1.0 and ≤ 2.5 2. Mean viability of the tissue replicates exposed for 30 min with the positive control, expressed as % of the negative control, should be ≤ 30 % 3. The difference of viability between two tissue replicates should be less than 20 %. 	<ol style="list-style-type: none"> 1. Mean OD of the tissue replicates treated with the negative control should be > 1.0 and ≤ 2.5 2. Mean viability of the tissue replicates exposed for 4 hours with the positive control, expressed as % of the negative control, should be ≤ 20 % 3. The difference of viability between two tissue replicates should be less than 20 %.

▼ M8

Appendix 3

ILLUSTRATIVE FLOWCHART PROVIDING GUIDANCE ON HOW TO IDENTIFY AND HANDLE DIRECT MTT-REDUCERS AND/OR COLOUR INTERFERING CHEMICALS, BASED ON THE VRM1 SOP

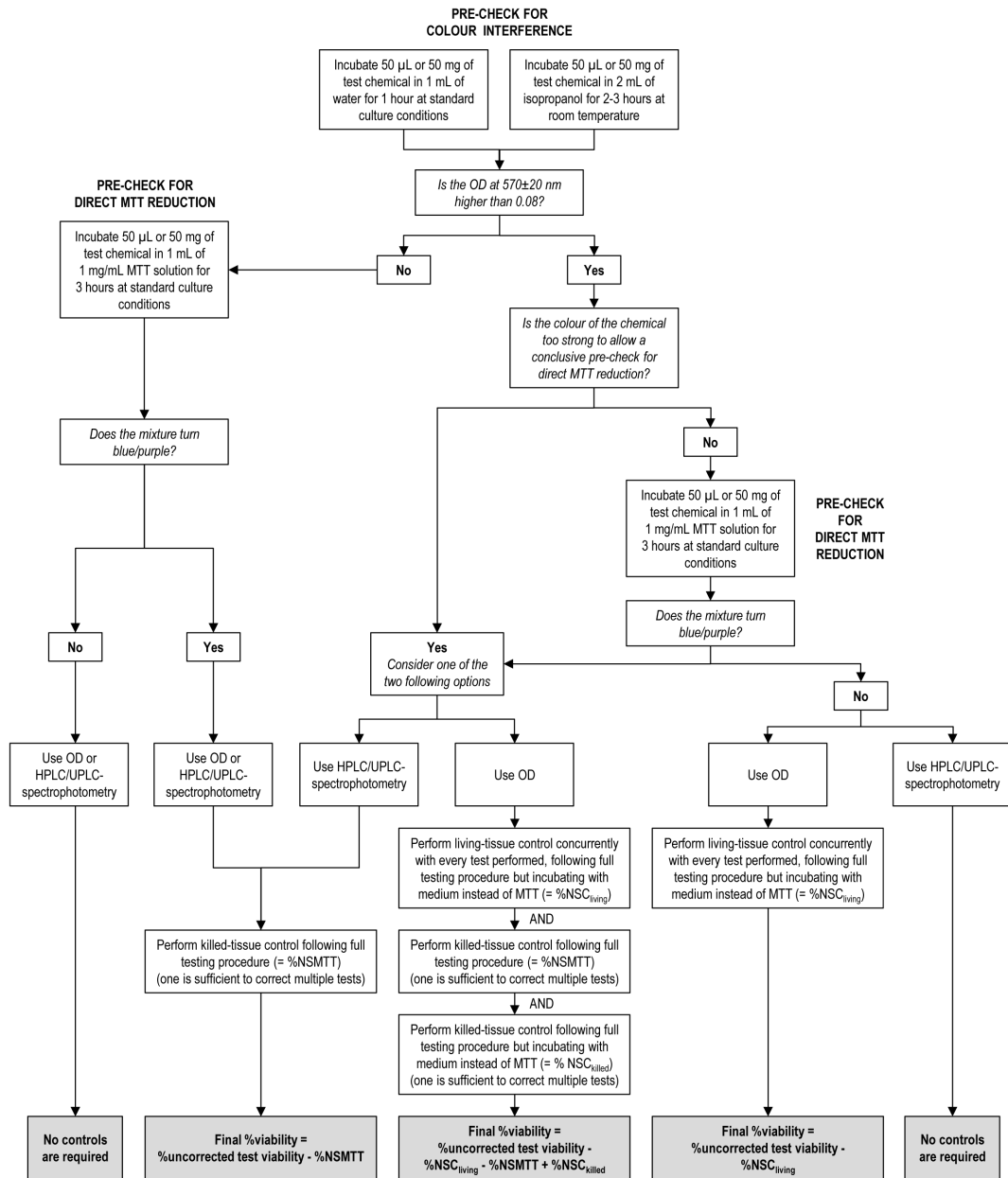

▼ M8

Appendix 4

ILLUSTRATIVE FLOWCHART PROVIDING GUIDANCE ON HOW TO IDENTIFY AND HANDLE DIRECT MTT-REDUCERS AND/OR COLOUR INTERFERING CHEMICALS, BASED ON THE VRM2 SOP

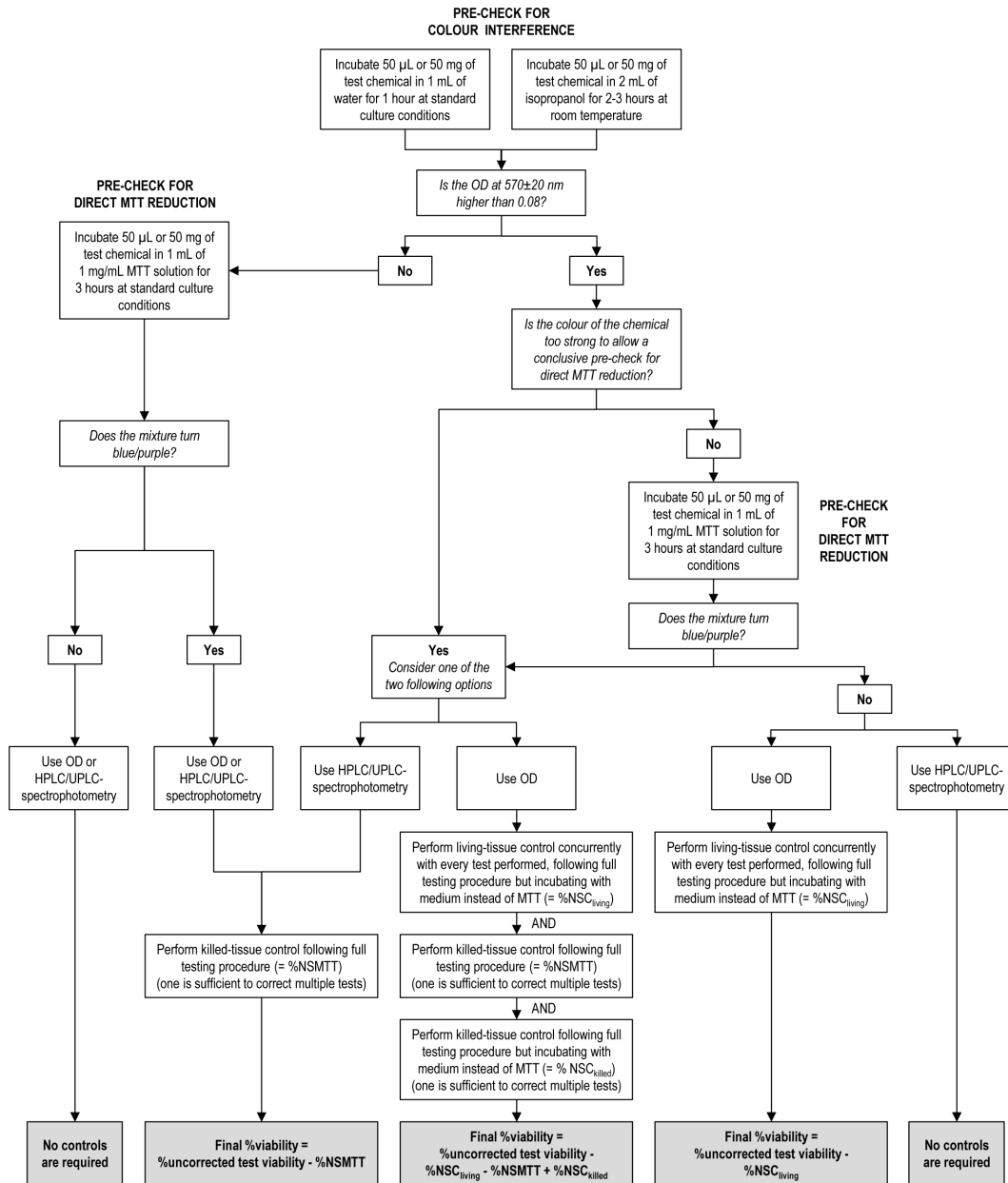

▼ M8

Appendix 5

KEY PARAMETERS AND ACCEPTANCE CRITERIA FOR QUALIFICATION OF AN HPLC/UPLC-SPECTROPHOTOMETRY SYSTEM FOR MEASUREMENT OF MTT FORMAZAN EXTRACTED FROM RHCE TISSUE CONSTRUCTS

Parameter	Protocol Derived from FDA Guidance (36)(38)	Acceptance Criteria
Selectivity	Analysis of isopropanol, living blank (isopropanol extract from living RhCE tissue constructs without any treatment), dead blank (isopropanol extract from killed RhCE tissue constructs without any treatment), and of a dye (e.g. methylene blue)	$\text{Area}_{\text{interference}} \leq 20 \% \text{ of } \text{Area}_{\text{LLOQ}}^{(1)}$
Precision	Quality Controls (i.e., MTT formazan at 1,6 µg/ml, 16 µg/ml and 160 µg/ml) in isopropanol (n=5)	$\text{CV} \leq 15 \% \text{ or } \leq 20 \% \text{ for the LLOQ}$
Accuracy	Quality Controls in isopropanol (n=5)	$\% \text{Dev} \leq 15 \% \text{ or } \leq 20 \% \text{ for LLOQ}$
Matrix Effect	Quality Controls in living blank (n=5)	$85 \% \leq \% \text{Matrix Effect} \leq 115 \%$
Carryover	Analysis of isopropanol after an ULOQ ⁽²⁾ standard	$\text{Area}_{\text{interference}} \leq 20 \% \text{ of } \text{Area}_{\text{LLOQ}}$
Reproducibility (intra-day)	3 independent calibration curves (based on 6 consecutive 1/3 dilutions of MTT formazan in isopropanol starting at ULOQ, i.e., 200 µg/ml); Quality Controls in isopropanol (n=5)	Calibration Curves: $\% \text{Dev} \leq 15 \% \text{ or } \leq 20 \% \text{ for LLOQ}$ Quality Controls: $\% \text{Dev} \leq 15 \% \text{ and } \text{CV} \leq 15 \%$
Reproducibility (inter-day)	Day 1: 1 calibration curve and Quality Controls in isopropanol (n=3) Day 2: 1 calibration curve and Quality Controls in isopropanol (n=3) Day 3: 1 calibration curve and Quality Controls in isopropanol (n=3)	
Short Term Stability of MTT Formazan in RhCE Tissue Extract	Quality Controls in living blank (n=3) analysed the day of the preparation and after 24 hours of storage at room temperature	$\% \text{Dev} \leq 15 \%$
Long Term Stability of MTT Formazan in RhCE Tissue Extract, if required	Quality Controls in living blank (n=3) analysed the day of the preparation and after several days of storage at -20 °C	$\% \text{Dev} \leq 15 \%$

(1) LLOQ: Lower Limit of Quantification, defined to cover 1-2 % tissue viability, i.e., 0,8 µg/ml.

(2) ULOQ: Upper Limit of Quantification, defined to be at least two times higher than the highest expected MTT formazan concentration in isopropanol extracts from negative controls (~70 µg/ml in the VRM), i.e., 200 µg/ml.

▼ M8**B.70. HUMAN RECOMBINANT ESTROGEN RECEPTOR (hrER) *IN VITRO* ASSAYS TO DETECT CHEMICALS WITH ER BINDING AFFINITY**

GENERAL INTRODUCTION

OECD Performance-Based Test Guideline

1. This test method is equivalent to OECD test guideline (TG) 493 (2015). TG 493 is a performance-based test guideline (PBTG), describing the methodology for human recombinant *in vitro* assays to detect substances with estrogen receptor binding affinity (hrER binding assays). It comprises two mechanistically and functionally similar assays for the identification of estrogen receptor (i.e. ER α) binders and should facilitate the development of new similar or modified assays in accordance with the principles for validation set forth in the OECD Guidance Document on the Validation and International Acceptance of New or Updated Test Methods for Hazard Assessment (1). The fully validated reference test methods (Appendix 2 and Appendix 3) that provide the basis for this PBTG are:

— The Freyberger-Wilson (FW) *In Vitro* Estrogen Receptor (ER) Binding Assay Using a Full Length Human Recombinant ER α (2), and

— The Chemical Evaluation and Research Institute (CERI) *In Vitro* Estrogen Receptor Binding Assay Using a Human Recombinant Ligand Binding Domain Protein (2).

Performance standards (PS) (3) are available to facilitate the development and validation of similar test methods for the same hazard endpoint and allow for timely amendment of PBTG 493 so that new similar assays can be added to an updated PBTG. However, similar test assays will only be added after review and agreement by OECD that performance standards are met. The assays included in TG 493 can be used indiscriminately to address OECD member countries' requirements for test results on estrogen receptor binding while benefiting from the OECD Mutual Acceptance of Data.

Background and principles of the assays included in this test method

2. The OECD initiated a high-priority activity in 1998 to revise existing, and to develop new test guidelines for the screening and testing of potential endocrine disrupting chemicals. The OECD conceptual framework (CF) for testing and assessment of potential endocrine disrupting chemicals was revised in 2012. The original and revised CFs are included as Annexes in the Guidance Document on Standardised Test Guidelines for Evaluating Chemicals for Endocrine Disruption (4). The CF comprises five levels, each level corresponding to a different level of biological complexity. The ER binding assays described in this test method are level 2, which includes '*in vitro* assays providing data about selected endocrine mechanism(s)/ pathway(s)'. This test method is for *in vitro* receptor binding assays designed to identify ligands for the human estrogen receptor alpha (ER α).

▼M8

3. The relevance of the *in vitro* ER binding assay to biological functions has been clearly demonstrated. ER binding assays are designed to identify chemicals that have the potential to disrupt the estrogen hormone pathway, and have been used extensively during the past two decades to characterise ER tissue distribution as well as to identify ER agonists/antagonists. These assays reflect the ligand-receptor interaction which is the initial step of the estrogen signalling pathway and essential for reproduction function in all vertebrates.
4. The interaction of estrogens with ERs can affect transcription of estrogen-controlled genes and induce non-genomic effects, which can lead to the induction or inhibition of cellular processes, including those necessary for cell proliferation, normal foetal development, and reproductive function (5) (6) (7). Perturbation of normal estrogenic systems may have the potential to trigger adverse effects on normal development (ontogenesis), reproductive health and the integrity of the reproductive system. Inappropriate ER signalling can lead to effects such as increased risk of hormone dependent cancer, impaired fertility, and alterations in foetal growth and development (8).
5. *In vitro* binding assays are based on a direct interaction of a substance with a specific receptor ligand binding site that regulates the gene transcription. The key component of the human recombinant estrogen receptor alpha (hrER α) binding assay measures the ability of a radiolabelled ligand ($[^3\text{H}]17\beta$ -estradiol) to bind with the ER in the presence of increasing concentrations of a test chemical (i.e. competitor). Test chemicals that possess a high affinity for the ER compete with the radiolabelled ligand at a lower concentration as compared with those chemicals with lower affinity for the receptor. This assay consists of two major components: a saturation binding experiment to characterise receptor-ligand interaction parameters and document ER specificity, followed by a competitive binding experiment that characterises the competition between a test chemical and a radiolabelled ligand for binding to the ER.
6. Validation studies of the CERI and the FW binding assays have demonstrated their relevance and reliability for their intended purpose (2).
7. Definitions and abbreviations used in this test method are described in Appendix 1.

Scope and limitations related to the receptor binding assays

8. These assays are being proposed for screening and prioritisation purposes, but can also provide information for a molecular initiation event (MIE) that can be used in a weight of evidence approach. They address chemical binding to the ER α ligand binding domain in an *in vitro* system. Thus, results should not be directly extrapolated to the complex signalling and regulation of the intact endocrine system *in vivo*.

▼M8

9. Binding of the natural ligand, 17 β -estradiol, is the initial step of a series of molecular events that activates the transcription of target genes and ultimately, culminates with a physiological change (9). Thus binding to the ER α ligand binding domain is considered one of the key mechanisms of ER mediated endocrine disruption (ED), although there are other mechanisms through which ED can occur, including (i) interactions with sites of ER α other than the ligand binding pocket, (ii) interactions with other receptors relevant for estrogen signalling, ER β and G-protein coupled estrogen receptor, other receptors and enzymatic systems within the endocrine system, (iii) hormone synthesis, (iv) metabolic activation and/or inactivation of hormones, (v) distribution of hormones to target tissues, and (vi) clearance of hormones from the body. None of the assays under this test method address these modes of action.

10. This test method addresses the ability of substances to bind to human ER α and does not distinguish between ER α agonists or antagonists. These assays does not address either further downstream events such as gene transcription or physiological changes. Considering that only single mono-constituent substances were used during the validation, the applicability to test mixtures has not been addressed. The assays are nevertheless theoretically applicable to the testing of multi-constituent substances and mixtures. Before use of the test method on a mixture for generating data for an intended regulatory purpose, it should be considered whether, and if so why, it may provide adequate results for that purpose. Such considerations are not needed, when there is a regulatory requirement for testing of the mixture.

11. The cell free receptor systems have no intrinsic metabolic capability and they were not validated in combination with metabolic enzyme systems. However, it might be possible to incorporate metabolic activity in a study design but this would require further validation efforts.

12. Chemicals that may denature the protein (i.e. receptor protein), such as surfactant or chemicals that can change the pH of the assay buffer, may not be tested or may only be tested at concentrations devoid of such interactions. Otherwise, the concentration range that can be tested in the assays for a test chemical is limited by its solubility in the assay buffer.

13. For informational purposes, Table 1 provides the test results for the 24 substances that were tested in both of the fully validated assays described in this test method. Of these substances, 17 are classified as ER binders and 6 as non-binders based upon published reports, including *in vitro* assays for ER transcriptional activation and/or the uterotrophic assay (9) (10) (11) (12) (13) (14) (15). In reference to the data summarised in Table 1, there was almost 100 % agreement between the two assays on the classifications of all the substances up to 10⁻⁴M, and each substance was correctly classified as an ER binder or non-binder. Supplementary information on this group of substances as well as additional substances tested in the ER binding assays during the validation studies is provided in the Performance Standards for the hrER binding assay (3), Appendix 2 (Tables 1, 2 and 3).

Table 1

Classification of substances as ER binders or non-binders when tested in the FW and CERl hrER Binding Assays with comparison with expected response

	Substance Name	CAS RN	Expected Response	FW Assay		CERl Assay		MESH Chemical Class	Product Class
				Concentration Range (M)	Classification	Concentration Range (M)	Classification		
1	17 β -Estradiol	50-28-2	<i>Binder</i>	1x10 ⁻¹¹ – 1x10 ⁻⁶	Binder	1x10 ⁻¹¹ – 1x10 ⁻⁶	Binder	Steroid	Pharmaceutical, Veterinary Agent
2	Norethynodrel	68-23-5	<i>Binder</i>	3x10 ⁻⁹ – 30x10 ⁻⁴	Binder	3x10 ⁻⁹ – 30x10 ⁻⁴	Binder	Steroid	Pharmaceutical, Veterinary Agent
3	Norethindrone	68-22-4	<i>Binder</i>	3x10 ⁻⁹ – 30x10 ⁻⁴	Binder	3x10 ⁻⁹ – 30x10 ⁻⁴	Binder	Steroid	Pharmaceutical, Veterinary Agent
4	Di- <i>n</i> -butyl phthalate	84-74-2	<i>Non-binder</i> (*)	1x10 ⁻¹⁰ – 1x10 ⁻⁴	Non-Binder (**)(⁺)	1x10 ⁻¹⁰ – 1x10 ⁻⁴	Non-Binder (**)(⁺)	Hydrocarbon (cyclic), Ester	Plasticiser, Chemical Intermediate
5	DES	56-53-1	<i>Binder</i>	1x10 ⁻¹⁰ – 1x10 ⁻³	Binder	1x10 ⁻¹⁰ – 1x10 ⁻³	Binder	Hydrocarbon (Cyclic), Phenol	Pharmaceutical, Veterinary Agent
6	17 α -ethynylestradiol	57-63-6	<i>Binder</i>	1x10 ⁻¹⁰ – 1x10 ⁻³	Binder	1x10 ⁻¹⁰ – 1x10 ⁻³	Binder	Steroid	Pharmaceutical, Veterinary Agent
7	Meso-Hexestrol	84-16-2	<i>Binder</i>	1x10 ⁻¹⁰ – 1x10 ⁻³	Binder	1x10 ⁻¹⁰ – 1x10 ⁻³	Binder	Hydrocarbon (Cyclic), Phenol	Pharmaceutical, Veterinary Agent
8	Genistein	446-72-0	<i>Binder</i>	1x10 ⁻¹⁰ – 1x10 ⁻³	Binder	1x10 ⁻¹⁰ – 1x10 ⁻³	Binder	Hydrocarbon (hetero-cyclic), Flavonoid	Natural Product

▼ M8

	Substance Name	CAS RN	Expected Response	FW Assay		CERI Assay		MESH Chemical Class	Product Class
				Concentration Range (M)	Classification	Concentration Range (M)	Classification		
9	Equol	531-95-3	<i>Binder</i>	$1 \times 10^{-10} - 1 \times 10^{-3}$	Binder	$1 \times 10^{-10} - 1 \times 10^{-3}$	Binder	Phytoestrogen Metabolite	Natural Product
10	Butyl paraben (<i>n</i> butyl-4-hydroxybenzoate)	94-26-8	<i>Binder</i>	$1 \times 10^{-10} - 1 \times 10^{-3}$	Binder	$1 \times 10^{-10} - 1 \times 10^{-3}$	Binder	Paraben	Preservative
11	Nonylphenol (mixture)	84852-15-3	<i>Binder</i>	$1 \times 10^{-10} - 1 \times 10^{-3}$	Binder	$1 \times 10^{-10} - 1 \times 10^{-3}$	Binder	Alkylphenol	Intermediate Compound
12	<i>o,p'</i> -DDT	789-02-6	<i>Binder</i>	$1 \times 10^{-10} - 1 \times 10^{-3}$	Binder	$1 \times 10^{-10} - 1 \times 10^{-3}$	Binder	Organochlorine	Insecticide
13	Corticosterone	50-22-6	<i>Non-binder (*)</i>	$1 \times 10^{-10} - 1 \times 10^{-4}$	Non-binder	$1 \times 10^{-10} - 1 \times 10^{-4}$	Non-Binder	Steroid	Natural Product
14	Zearalenone	17924-92-4	<i>Binder</i>	$1 \times 10^{-10} - 1 \times 10^{-3}$	Binder	$1 \times 10^{-10} - 1 \times 10^{-3}$	Binder	Hydrocarbon (heterocyclic), Lactone	Natural Product
15	Tamoxifen	10540-29-1	<i>Binder</i>	$1 \times 10^{-10} - 1 \times 10^{-3}$	Binder	$1 \times 10^{-10} - 1 \times 10^{-3}$	Binder	Hydrocarbon, (Cyclic)	Pharmaceutical, Veterinary Agent
16	5 α -dihydrotestosterone	521-18-6	<i>Binder</i>	$1 \times 10^{-10} - 1 \times 10^{-3}$	Binder	$1 \times 10^{-10} - 1 \times 10^{-3}$	Binder	Steroid, Nonphenolic	Natural Product
17	Bisphenol A	80-05-7	<i>Binder</i>	$1 \times 10^{-10} - 1 \times 10^{-3}$	Binder	$1 \times 10^{-10} - 1 \times 10^{-3}$	Binder	Phenol	Chemical Intermediate
18	4- <i>n</i> -heptylphenol	1987-50-4	<i>Binder</i>	$1 \times 10^{-10} - 1 \times 10^{-3}$	Equivocal (a)	$1 \times 10^{-10} - 1 \times 10^{-3}$	Binder	Alkylphenol	Intermediate

▼ M8

	Substance Name	CAS RN	Expected Response	FW Assay		CERI Assay		MESH Chemical Class	Product Class
				Concentration Range (M)	Classification	Concentration Range (M)	Classification		
19	Kepone (Chlordecone)	143-50-0	<i>Binder</i>	$1 \times 10^{-10} - 1 \times 10^{-3}$	Binder	$1 \times 10^{-10} - 1 \times 10^{-3}$	Binder	Hydrocarbon, (Halogenated)	Pesticide
20	Benz(a)anthracene	56-55-3	<i>Non-Binder</i>	$1 \times 10^{-10} - 1 \times 10^{-3}$	Non-Binder ^(b)	$1 \times 10^{-10} - 1 \times 10^{-3}$	Non-Binder ^(b)	Aromatic Hydrocarbon	Intermediate
21	Enterolactone	78473-71-9	<i>Binder</i>	$1 \times 10^{-10} - 1 \times 10^{-3}$	Binder	$1 \times 10^{-10} - 1 \times 10^{-3}$	Binder	Phytoestrogen	Natural Product
22	Progesterone	57-83-0	<i>Non-binder (*)</i>	$1 \times 10^{-10} - 1 \times 10^{-4}$	Non-Binder	$1 \times 10^{-10} - 1 \times 10^{-4}$	Non-Binder	Steroid	Natural Product
23	Octyltriethoxysilane	2943-75-1	<i>Non-binder</i>	$1 \times 10^{-10} - 1 \times 10^{-3}$	Non-Binder	$1 \times 10^{-10} - 1 \times 10^{-3}$	Non-Binder	Silane	Surface Modifier
24	Atrazine	1912-24-9	<i>Non-binder (*)</i>	$1 \times 10^{-10} - 1 \times 10^{-4}$	Non-Binder	$1 \times 10^{-10} - 1 \times 10^{-4}$	Non-Binder	Heterocyclic compound	Herbicide

(*) Limit of solubility $< 1 \times 10^{-4}$ M.

(**) The use and classification of di-*n*-butyl phthalate (DBP) as a non-binder was based on testing up to 10^{-4} M because the substance had been observed to be insoluble at 10^{-3} M (e.g. turbidity) in some laboratories during the pre-validation studies.

(†) During the validation study, di-*n*-butyl phthalate (DBP) was tested as a coded test substance at concentrations up to 10^{-3} M. Under these conditions, some laboratories observed either a decrease in radioligand binding at the highest concentration (10^{-3} M) and/or an ambiguous curve fit. For these runs, DBP was classified as ‘equivocal’ or ‘binder’ in 3/5 laboratories using the CERI assay and 5/6 laboratories using the FW assay (see Reference (2), Sections IV.B.3a,b and VI.A).

(^a) Classification was not consistent with expected classification. Classification of 4-*n*-heptylphenol as ‘equivocal’ or ‘non-binder’ by 3/5 labs resulted in an average classification of equivocal. Closer inspection revealed that this was due to chemical solubility limitations that prevented the production of a full binding curve.

(^b) During the validation study, benz(a)anthracene was reclassified as a non-binder (i.e. negative) based on published literature demonstrating that the *in vitro* estrogenic activity reported for this substance is primarily dependent upon its metabolic activation. Enzymatic metabolic activation of the substance would not be anticipated in the cell free hER binding assays as used in this inter-laboratory validation study. Thus, the correct classification for this substance is a ‘non-binder’ when used under the experimental conditions for the FW and CERI assays.

▼M8**hrER BINDING ASSAY COMPONENTS****Essential Assay Components**

14. This test method applies to assays using an ER receptor and a suitably strong ligand to the receptor that can be used as a marker/tracer for the assay and can be displaced with increasing concentrations of a test chemical. Binding assays contain the following two major components: 1) saturation binding and 2) competitive binding. The saturation binding assay is used to confirm the specificity and activity of the receptor preparations, while the competitive binding experiment is used to evaluate the ability of a test chemical to bind to hrER.

Controls

15. The basis for the proposed concurrent reference estrogen and controls should be described. Concurrent controls (solvent (vehicle), positive (ER binder; strong and weak affinity), negative (non-binder)), as appropriate, serve as an indication that the assay is operative under the test conditions and provide a basis for experiment-to-experiment comparisons; they are usually part of the acceptability criteria for a given experiment (1). Full concentration curves for the reference estrogen and controls (i.e. weak binder and non-binder) should be used in one plate during each run. All other plates should contain: 1) a high- (approximately full displacement of radiolabelled ligand) and medium- (approximately the IC_{50}) concentration each of E2 and weak binder in triplicate; 2) solvent control and non-specific binding, each in triplicate.

Standard Quality Control Procedures

16. Standard quality control procedures should be performed as described for each assay to ensure active receptors, the correct chemical concentrations, tolerance bounds remain stable through multiple replications, and retain the ability to provide the expected ER-binding responses over time.

Demonstration of Laboratory Proficiency

17. Prior to testing unknown chemicals with any of the assays under this test method, each laboratory should demonstrate proficiency in using the assay by performing saturation assays to confirm specificity and activity of the ER preparation, and competitive binding assays with the reference estrogen and controls (weak binder and non-binder). A historical database with results for the reference estrogen and controls generated from 3-5 independent experiments conducted on different days should be established by the laboratory. These experiments will be the foundation for the reference estrogen and historical controls for the laboratory and will be used as a partial assessment of assay acceptability for future runs.
18. The responsiveness of the test system will also be confirmed by testing the proficiency substances listed in Table 2. The list of proficiency substances is a subset of the reference substances provided in the Performance Standards for the ER binding assays (3). These substances are commercially available, represent the classes of chemicals commonly associated with ER binding activity, exhibit a suitable range of potency expected for ER binders (i.e. strong to weak) and non-binders (i.e. negatives). For each proficiency substance, concentrations tested should cover the range provided in Table 2. At least three experiments should be performed for each substance and results should be in concordance with expected chemical activity. Each experiment should be conducted independently (i.e. with fresh dilutions of receptor, chemicals, and reagent), with three replicates for each concentration. Proficiency is demonstrated by correct classification (positive/negative) of each proficiency substance. Proficiency testing should be performed by each technician when learning the assays.

Table 2

List of controls and proficiency substances for the hrER competitive binding assays (1)

No	Substance Name	CAS RN (2)	Expected Response (3) (4)	Test concentration range (M)	MeSH chemical class (5)	Product class (6)
Controls (Reference estrogen, weak binder, non-binder)						
1	17β-estradiol	50-28-2	Binder	1x10 ⁻¹¹ – 1x10 ⁻⁶	Steroid	Pharmaceutical, Veterinary agent
2	Norethynodrel (or) Norethindrone	68-23-5 (or)68-22-4	Binder	3x10 ⁻⁹ – 30x10 ⁻⁶	Steroid	Pharmaceutical, Veterinary agent
3	Octyltriethoxysilane	2943-75-1	Non-binder	1x10 ⁻¹⁰ – 1x10 ⁻³	Silane	Surface modifier
Proficiency substances (6)						
4	Diethylstilbestrol	56-53-1	Binder	1x10 ⁻¹¹ – 1x10 ⁻⁶	Hydrocarbon (cyclic), Phenol	Pharmaceutical, Veterinary agent
5	17α-ethynylestradiol	57-63-6	Binder	1x10 ⁻¹¹ – 1x10 ⁻⁶	Steroid	Pharmaceutical, Veterinary agent
6	meso-Hexestrol	84-16-2	Binder	1x10 ⁻¹¹ – 1x10 ⁻⁶	Hydrocarbon (cyclic), Phenol	Pharmaceutical, Veterinary agent
7	Tamoxifen	10540-29-1	Binder	1x10 ⁻¹¹ – 1x10 ⁻⁶	Hydrocarbon (cyclic)	Pharmaceutical, Veterinary agent
8	Genistein	446-72-0	Binder	1x10 ⁻¹⁰ – 1x10 ⁻³	Heterocyclic compound, Flavonoid,	Natural product
9	Bisphenol A	80-05-7	Binder	1x10 ⁻¹⁰ – 1x10 ⁻³	Phenol	Chemical intermediate
10	Zearalonone	17924-92-4	Binder	1x10 ⁻¹¹ – 1x10 ⁻³	Heterocyclic compound, Lactone	Natural Product

▼ M8

No	Substance Name	CAS RN ⁽²⁾	Expected Response ⁽³⁾ ⁽⁴⁾	Test concentration range (M)	MeSH chemical class ⁽⁵⁾	Product class ⁽⁶⁾
11	Butyl paraben	94-26-8	Binder	1x10 ⁻¹¹ – 1x10 ⁻³	Carboxylic acid, Phenol	Preservative
12	Atrazine	1912-24-9	Non-binder	1x10 ⁻¹¹ – 1x10 ⁻⁶	Heterocyclic compound	Herbicide
13	Di-n-butylphthalate (DBP) ⁽⁷⁾	84-74-2	Non-binder ⁽⁸⁾	1x10 ⁻¹⁰ – 1x10 ⁻⁴	Hydrocarbon (cyclic), Ester	Plasticiser, Chemical intermediate
14	Corticosterone	50-22-6	Non-binder	1x10 ⁻¹¹ – 1x10 ⁻⁴	Steroid	Natural product

⁽¹⁾ If a proficiency substance is no longer commercially available, a substance with the same ER binding classification, comparable potency, and chemical class can be used.

⁽²⁾ Abbreviations: CAS RN = Chemical Abstracts Service Registry Number.

⁽³⁾ Classification as an ER α Binder or Non-binder during the validation study for the CER1 and FW hrER Binding Assays (2).

⁽⁴⁾ ER binding activity was based upon the ICCVAM Background Review Documents (BRD) for ER Binding and TA assays (9) as well as empirical data and other information obtained from referenced studies published and reviewed (10) (11) (12) (13) (14) (15).

⁽⁵⁾ Substances were assigned into one or more chemical classes using the U.S. National Library of Medicine's Medical Subject Headings (MeSH), an internationally recognised standardised classification scheme (available at: <http://www.nlm.nih.gov/mesh>).

⁽⁶⁾ Substances were assigned into one or more product classes using the U.S. National Library of Medicine's Hazardous Substances Database (available at: <http://toxnet.nlm.nih.gov/cgi-bin/sis/htmlgen?HSDB>)

⁽⁷⁾ DBP can be used as an alternate control non-binder tested with maximum concentration of 10⁻⁴ M.

⁽⁸⁾ Limit of solubility for this substance is 10⁻⁴ M. The use and classification of di-n-butyl phthalate (DBP) as a non-binder has been based on testing up to 10⁻⁴ M because the substance had been observed to be insoluble at 10⁻³ M (e.g. turbidity) in some laboratories during the pre-validation studies.

▼M8**Solubility Testing and Concentration Range Finding for Test Chemicals**

19. A preliminary test should be conducted to determine the limit of solubility for each test chemical and to identify the appropriate concentration range to use when conducting the test. The limit of solubility of each test chemical is to be initially determined in the solvent and further confirmed under assay conditions. The final concentration tested in the assay should not exceed 1 mM. Range finder testing consists of a solvent control along with eight, log serial dilutions, starting at the maximum acceptable concentration (e.g. 1 mM or lower, based upon the limit of solubility), and the presence of cloudiness or precipitate noted. Concentrations in the second and third experiments should be adjusted as appropriate to better characterise the concentration-response curve.

Test Run Acceptability Criteria

20. Acceptance or rejection of a test run is based on the evaluation of results obtained for the reference estrogen and control used for each experiment. First, for plate 1, the full concentration curves for the reference controls from each experiment should meet the measures of performance with curve-fit parameters (e.g. IC_{50} and Hillslope) based upon the results reported for the respective protocols for the CER1 and FW assays (Appendix 2 and 3), and the historical control data from the laboratory conducting the test. All controls (reference estrogen, weak binder, and non-binder) should be correctly classified for each experiment. Secondly, the controls on all subsequent plates need to be assessed for consistency with plate 1. A sufficient range of concentrations of the test chemical should be used to clearly define the top of the competitive binding curve. Variability among replicates at each concentration of the test chemical as well as among the three independent runs should be reasonable and scientifically defensible. The ability to consistently conduct the assay should be demonstrated by the development and maintenance of a historical database for the reference estrogen and controls. Standard deviations (SD) or coefficients of variation (CV) for the means of reference estrogen and control weak binder curves fitting parameters from multiple experiments may be used as a measure of within-laboratory reproducibility. Professional judgment should be applied when reviewing the plate control results from each run as well as for each test chemical.

In addition, the following principles regarding acceptability criteria should be met:

- Data should be sufficient for a quantitative assessment of ER binding

- The concentrations tested should remain within the solubility range of the test chemical.

Analysis of data

21. The defined data analysis procedure for saturation and competitive binding data should adhere to the key principles for characterising receptor-ligand interactions. Typically, saturation binding data are analysed using a non-linear regression model that accounts for total and non-specific binding. A correction for ligand depletion (e.g. Swillens, 1995 (19)) may be needed when determining B_{max} and K_d . Data from competitive binding assays are typically transformed (e.g. percent specific binding and concentration of test chemical (log M)). Estimates of log (IC_{50}) for each test chemical

▼ M8

should be determined using an appropriate nonlinear curve fitting software to fit a four parameter Hill equation. Following an initial analysis, the curve fit parameters and a visual review of how well the binding data fit the generated competitive binding curve should be conducted. In some cases, additional analysis may be needed to obtain the best curve fit (e.g. constraining top and/or bottom of curve, use of 10 % rule, see Appendix 4 and Reference 2 (Section III.A.2)).

22. Meeting the acceptability criteria (paragraph 20) indicates the assay system is operating properly, but it does not ensure that any particular test will produce accurate data. Replicating the correct results of the first test is the best indication that accurate data were produced.

General Data Interpretation Criteria

23. There is currently no universally agreed method for interpreting ER binding data. However, both qualitative (e.g. binder/non-binder) and/or quantitative (e.g. $\log IC_{50}$, Relative Binding Affinity (RBA), etc.) assessments of hrER-mediated activity should be based on empirical data and sound scientific judgment.

Test Report

24. The test report should include the following information:

Assay:

- assay used;

Control/Reference/Test chemical

- source, lot number, limit date for use, if available
- stability of the test chemical itself, if known;
- solubility and stability of the test chemical in solvent, if known.
- measurement of pH, osmolality and precipitate in the culture medium to which the test chemical was added, as appropriate.

Mono-constituent substance:

- physical appearance, water solubility, and additional relevant physico-chemical properties;
- chemical identification, such as IUPAC or CAS name, CAS number, SMILES or InChI code, structural formula, purity, chemical identity of impurities as appropriate and practically feasible, etc.

Multi-constituent substance, UVCBs and mixtures:

- characterised as far as possible by chemical identity (see above), quantitative occurrence and relevant physicochemical properties of the constituents.

▼M8*Solvent/Vehicle:*

- characterisation (nature, supplier and lot);
- justification for choice of solvent/vehicle;
- solubility and stability of the test chemical in solvent/vehicle, if known;

Receptors:

- source of receptors (supplier, catalog No, lot, species of receptor, active receptor concentration provided from supplier, certification from supplier)
- characterisation of receptors (including saturation binding results): K_d , B_{max} ,
- storage of receptors
- radiolabelled ligand:
- supplier, catalog No., lot, specific activity

Test conditions:

- solubility limitations under assay conditions;
- composition of binding buffer;
- concentration of receptor;
- concentration of tracer (i.e. radiolabelled ligand);
- concentrations of test chemical;
- percent vehicle in final assay;
- incubation temperature and time;
- method of bound/free separation;
- positive and negative controls/reference substances;
- criteria for considering tests as positive, negative or equivocal;

Acceptability check:

- actual IC_{50} and Hill slope values for concurrent positive controls/reference substances;

Results:

- raw and bound/free data;
- denaturing confirmation check, if appropriate;
- if it exists, the lowest effective concentration (LEC);
- RBA and/or IC_{50} values, as appropriate;
- concentration-response relationship, where possible;
- statistical analyses, if any, together with a measure of error and confidence (e.g. SEM, SD, CV or 95 % CI) and a description of how these values were obtained;

▼M8*Discussion of the results:*

— application of 10 % rule

*Conclusion***LITERATURE**

- (1) OECD (2005). Guidance Document on the Validation and International Acceptance of New or Updated Test Methods for Hazard Assessment. Environmental, Health and Safety Publications, Series on Testing and Assessment (No 34), Organisation for Economic Cooperation and Development, Paris.
- (2) OECD (2015). Integrated Summary Report: Validation of Two Binding Assays Using Human Recombinant Estrogen Receptor Alpha (hrER α), Health and Safety Publications, Series on Testing and Assessment (No 226), Organisation for Economic Cooperation and Development, Paris.
- (3) OECD (2015). Performance Standards for Binding Assays Using Human Recombinant Estrogen Receptor Alpha (hrER α), Health and Safety Publications, Series on Testing and Assessment (No 222), Organisation for Economic Cooperation and Development, Paris.
- (4) OECD (2012). Guidance Document on Standardized Test Guidelines for Evaluating Chemicals for Endocrine Disruption. Environmental, Health and Safety Publications, Series on Testing and Assessment (No 150), Organisation for Economic Cooperation and Development, Paris.
- (5) Cavaillès V. (2002). Estrogens and Receptors: an Evolving Concept, *Climacteric*, 5 Suppl 2: p.20-6.
- (6) Welboren W.J., *et al.* (2009). Genomic Actions of Estrogen Receptor Alpha: What are the Targets and How are they Regulated? *Endocr. Relat. Cancer.*, 16(4): p. 1073-89.
- (7) Younes M. and Honma N. (2011). Estrogen Receptor Beta, *Arch. Pathol. Lab. Med.*, 135(1): p. 63-6.
- (8) Diamanti-Kandarakis *et al.* (2009). Endocrine-Disrupting Chemicals: an Endocrine Society Sci. Statement, *Endo Rev* 30(4):293-342.
- (9) ICCVAM (2002). Background Review Document. Current Status of Test Methods for Detecting Endocrine Disruptors: *In Vitro* Estrogen Receptor Binding Assays. (NIH Publication No 03-4504). National Institute of Environmental Health Sciences, Research Triangle Park, NC.
- (10) ICCVAM (2003). ICCVAM Evaluation of *In Vitro* Test Methods for Detecting Potential Endocrine Disruptors: Estrogen Receptor and Androgen Receptor Binding and Transcriptional Activation Assays.
- (11) ICCVAM (2006). ICCVAM Evaluation of *In Vitro* Test Methods for Detecting Potential Endocrine Disruptors: Estrogen Receptor and Androgen Receptor Binding and Transcriptional Activation Assays.
- (12) Akahori Y. *et al.* (2008). Relationship Between the Results of *In Vitro* Receptor Binding Assay to Human Estrogen Receptor Alpha and *In Vivo* Uterotrophic Assay: Comparative Study with 65 Selected Chemicals, *Toxicol. In Vitro*, 22(1): 225-231.
- (13) OECD (2007). Additional Data Supporting the Test Guideline on the Uterotrophic Bioassay in Rodents, Environment, Health and Safety Publications, Series on Testing and Assessment (No 67), Organisation for Economic Cooperation and Development, Paris.

▼M8

- (14) Takeyoshi, M. (2006). Draft Report of Pre-validation and Inter-laboratory Validation For Stably Transfected Transcriptional Activation (TA) Assay to Detect Estrogenic Activity - The Human Estrogen Receptor Alpha Mediated Reporter Gene Assay Using hER-HeLa-9903 Cell Line, Chemicals Evaluation and Research Institute (CERI): Japan. p. 1-188.
- (15) Yamasaki, K; Noda, S; Imatanaka, N; Yakabe, Y. (2004). Comparative Study of the Uterotrophic Potency of 14 Chemicals in a Uterotrophic Assay and their Receptor-Binding Affinity, *Toxicol. Letters*, 146: 111-120.
- (16) Kummer V; Maskova, J; Zraly, Z; Neca, J; Simeckova, P; Vondracek, J; Machala, M. (2008). Estrogenic Activity of Environmental Polycyclic Aromatic Hydrocarbons in Uterus of Immature Wistar Rats. *Toxicol. Letters*, 180: 213-221.
- (17) Gozgit, JM; Nestor, KM; Fasco, MJ; Pentecost, BT; Arcaro, KF. (2004). Differential Action of Polycyclic Aromatic Hydrocarbons on Endogenous Estrogen-Responsive Genes and on a Transfected Estrogen-Responsive Reporter in MCF-7 Cells. *Toxicol. and Applied Pharmacol.*, 196: 58-67.
- (18) Santodonato, J. (1997). Review of the Estrogenic and Antiestrogenic Activity of Polycyclic Aromatic Hydrocarbons: Relationship to Carcinogenicity. *Chemosphere*, 34: 835-848.
- (19) Swillens S (1995). Interpretation of Binding Curves Obtained with High Receptor Concentrations: Practical Aid for Computer Analysis, *Mol Pharmacol* 47(6):1197-1203.

▼M8*Appendix 1*

DEFINITIONS AND ABBREVIATIONS

10 % Rule: Option to exclude from the analyses data points where the mean of the replicates for the percent [³H]17β-estradiol specific bound is 10 % or more above that observed for the mean value at a lower concentration (see Appendix 4).

Acceptability criteria: Minimum standards for the performance of experimental controls and reference standards. All acceptability criteria should be met for an experiment to be considered valid.

Accuracy (concordance): The closeness of agreement between assay results and an accepted reference values. It is a measure of assay performance and one aspect of relevance. The term is often used interchangeably with ‘concordance’ to mean the proportion of correct outcomes of an assay (1).

CF: The OECD Conceptual Framework for the Testing and Evaluation of Endocrine Disrupters.

Chemical: A substance or a mixture.

CV: Coefficient of variation

E2: 17β-estradiol

ED: Endocrine disruption

hERα: Human estrogen receptor alpha

ER: Estrogen receptor

Estrogenic activity: The capability of a chemical to mimic 17β-estradiol in its ability to bind estrogen receptors. Binding to the hERα can be detected with this test method.

IC50: The half maximal effective concentration of an inhibitory test chemical.

ICCVAM: The Interagency Coordinating Committee on the Validation of Alternative Methods.

Inter-laboratory reproducibility: A measure of the extent to which different qualified laboratories, using the same protocol and testing the same substances, can produce qualitatively and quantitatively similar results. Interlaboratory reproducibility is determined during the prevalidation and validation processes, and indicates the extent to which an assay can be successfully transferred between laboratories, also referred to as between-laboratory reproducibility (1).

Intra-laboratory reproducibility: A determination of the extent that qualified people within the same laboratory can successfully replicate results using a specific protocol at different times. Also referred to as ‘within-laboratory reproducibility’ (1).

LEC: Lowest effective concentration is the lowest concentration of test chemical that produces a response (*i.e.* the lowest test chemical concentration at which the fold induction is statistically different from the concurrent vehicle control).

▼ M8

Me-too test: A colloquial expression for an assay that is structurally and functionally similar to a validated and accepted reference test method. Interchangeably used with similar test method

PBTG: Performance-Based Test Guideline

Performance standards: Standards, based on a validated test method, that provide a basis for evaluating the comparability of a proposed assay that is mechanistically and functionally similar. Included are (1) essential assay components; (2) a minimum list of reference chemicals selected from among the chemicals used to demonstrate the acceptable performance of the validated test method; and (3) the comparable levels of accuracy and reliability, based on what was obtained for the validated test method, that the proposed assay should demonstrate when evaluated using the minimum list of reference chemicals (1).

Proficiency substances: A subset of the Reference substances included in the Performance Standards that can be used by laboratories to demonstrate technical competence with a standardised assay. Selection criteria for these substances typically include that they represent the range of responses, are commercially available, and have high quality reference data available.

Proficiency: The demonstrated ability to properly conduct an assay prior to testing unknown substances.

Reference estrogen: 17 β -estradiol (E2, CAS 50-28-2).

Reference test methods: The assays upon which PBTG 493 is based.

RBA: Relative Binding Affinity. The RBA of a substance is calculated as a percent of the log (IC₅₀) for the substance relative to the log (IC₅₀) for 17 β -estradiol

Relevance: Description of relationship of an assay to the effect of interest and whether it is meaningful and useful for a particular purpose. It is the extent to which the assay correctly measures or predicts the biological effect of interest. Relevance incorporates consideration of the accuracy (concordance) of an assay (1).

Reliability: Measure of the extent that an assay can be performed reproducibly within and between laboratories over time, when performed using the same protocol. It is assessed by calculating intra- and inter-laboratory reproducibility.

SD: Standard deviation.

Test chemical: Any substance or mixture tested using this test method.

Validated test method: An assay for which validation studies have been completed to determine the relevance (including accuracy) and reliability for a specific purpose. It is important to note that a validated test method may not have sufficient performance in terms of accuracy and reliability to be found acceptable for the proposed purpose (1).

Validation: The process by which the reliability and relevance of a particular approach, method, assay, process or assessment is established for a defined purpose (1).

▼M8*Appendix 2*THE FREYBERGER-WILSON IN VITRO ESTROGEN RECEPTOR (ER α) SATURATION AND COMPETITIVE BINDING ASSAYS USING FULL LENGTH RECOMBINANT ER α

INITIAL CONSIDERATIONS AND LIMITATIONS (SEE ALSO GENERAL INTRODUCTION)

1. This *in vitro* Estrogen Receptor (ER α) saturation and competitive binding assay uses full length human receptor ER α (hrER α) that is produced in and isolated from baculovirus-infected insect cells. The protocol, developed by Freyberger and Wilson, underwent an international multi-laboratory validation study (2) which has demonstrated its relevance and reliability for the intended purpose of the assay.
2. This assay is a screening procedure for identifying substances that can bind to the full length hrER α . It is used to determine the ability of a test chemical to compete with 17 β -estradiol for binding to hrER α . Quantitative assay results may include the IC₅₀ (a measure of the concentration of test chemical needed to displace half of the [³H]-17 β -estradiol from the hrER α) and the relative binding affinities of test chemicals for the hrER α compared to 17 β -estradiol. For chemical screening purposes, acceptable qualitative assay results may include classifications of test chemicals as either hrER α binders, non-binders, or equivocal based upon criteria described for the binding curves.
3. The assay uses a radioactive ligand that requires a radioactive materials license for the laboratory. All procedures with radioisotopes and hazardous chemicals should follow the regulations and procedures as described by national legislation.
4. The ‘GENERAL INTRODUCTION’ and ‘hrER BINDING ASSAY COMPONENTS’ should be read before using this assay for regulatory purposes. Definitions and abbreviations used in this TG are described in Appendix 1.

PRINCIPLES OF THE ASSAY (SEE ALSO GENERAL INTRODUCTION)

5. The hrER α binding assay measures the ability of a radiolabelled ligand ([³H]17 β -estradiol) to bind with the ER in the presence of increasing concentrations of a test chemical (i.e. competitor). Test chemicals that possess a high affinity for the ER compete with the radiolabelled ligand at a lower concentration as compared with those chemicals with lower affinity for the receptor.
6. This assay consists of two major components: a saturation binding experiment to characterise receptor-ligand interaction parameters, followed by a competitive binding experiment that characterises the competition between a test chemical and a radiolabelled ligand for binding to the ER.
7. The purpose of the saturation binding experiment is to characterise a particular batch of receptors for binding affinity and number in preparation for the competitive binding experiment. The saturation binding experiment measures, under equilibrium conditions, the affinity of a fixed concentration of the estrogen receptor for its natural ligand (represented by the dissociation constant, K_d), and the concentration of active receptor sites (B_{max}).

▼ **M8**

8. The competitive binding experiment measures the affinity of a substance to compete with [3H]17 β -estradiol for binding to the ER. The affinity is quantified by the concentration of test chemical that, at equilibrium, inhibits 50 % of the specific binding of the [3H]17 β -estradiol (termed the 'inhibitory concentration 50 %' or IC₅₀). This can also be evaluated using the relative binding affinity (RBA, relative to the IC₅₀ of estradiol measured separately in the same run). The competitive binding experiment measures the binding of [3H]17 β -estradiol at a fixed concentration in the presence of a wide range (eight orders of magnitude) of test chemical concentrations. The data are then fit, where possible, to a form of the Hill equation (Hill, 1910) that describes the displacement of the radioligand by a one-site competitive binder. The extent of displacement of the radiolabelled estradiol at equilibrium is used to characterise the test chemical as a binder, non-binder, or generating an equivocal response.

PROCEDURE**Demonstration of Acceptable hrER α Protein Performance**

9. Prior to routinely conducting the saturation and competitive binding assays, each new batch of hrER α should be shown to be performing correctly in the laboratory in which it will be used. A two-step process should be used to demonstrate performance. These steps are the following:
- Conduct a saturation [³H]-17 β -estradiol binding assay to demonstrate hrER α specificity and saturation. Nonlinear regression analysis of these data (e.g. BioSoft; McPherson, 1985; Motulsky, 1995) and the subsequent Scatchard plot should document hrER α binding affinity of the [³H]-17 β -estradiol (K_d) and the number of receptors (B_{max}) for each batch of hrER α .
 - Conduct a competitive binding assay using the control substances (reference estrogen (17 β -estradiol)), a weak binder (e.g. norethynodrel or norethindrone), and a non-binder (octyltriethoxysilane, OTES). Each laboratory should establish an historical database to document the consistency of IC₅₀ and other relevant values for the reference estrogen and weak binder among experiments and different batches of hrER α . The parameters of the competitive binding curves for the control substances should be within the limits of the 95 % confidence interval (see Table 1) that were developed using data from laboratories that participated in the validation study for this assay (2).

*Table 1***Performance criteria developed for the reference estrogen and weak binder, FW hrER Binding Assay**

Substance	Parameter	Mean ^(a)	Standard Deviation (n)	95 % Confidence Intervals ^(b)	
				Lower Limit	Upper Limit
17β-estradiol	Top (%)	100,44	10,84 (67)	97,8	103,1
	Bottom (%)	0,29	1,25 (67)	-0,01	0,60
	Hill Slope	-1,06	0,20 (67)	-1,11	-1,02
	LogIC ₅₀ (M)	-8,92 ^(c)	0,18 (67)	-8,97	-8,88

▼ **M8**

Substance	Parameter	Mean ^(a)	Standard Deviation (n)	95 % Confidence Intervals ^(b)	
				Lower Limit	Upper Limit
Norethynodrel	Top (%)	99,42	8,90 (68)	97,27	101,60
	Bottom (%)	2,02	3,42 (68)	1,19	2,84
	Hill Slope	-1,01	0,38 (68)	-1,10	-0,92
	Log IC ₅₀ (M)	-6,39	0,27 (68)	-6,46	-6,33
Norethindrone ^(c)	Top (%)	96,14	8,44 (27)	92,80	99,48
	Bottom (%)	2,38	5,02 (27)	0,40	4,37
	Hill Slope	-1,41	0,32 (27)	-1,53	-1,28
	LogIC ₅₀ (M)	-5,73	0,27 (27)	-5,84	-5,62

^(a) Mean (n) ± Standard Deviation (SD) were calculated using curve fit parameter estimates (4-parameter Hill Equation) for control runs conducted in four laboratories during the validation study (see Annex N of Reference 2).

^(b) The 95 % confidence intervals are provided as a guide for acceptability criteria.

^(c) Testing of norethindrone was optional for Subtask 4 during validation study (see Reference 2, see Subtask 4). Thus, the mean ± SD (n) were calculated using curve fit estimates (4-parameter Hill equation) for control runs conducted in two laboratories.

The range for the IC₅₀ will be dependent upon the K_d of the receptor preparation and concentration of radiolabelled ligand used within each laboratory. Appropriate adjustment for the range of the IC₅₀ based upon the conditions used to conduct the assay will be acceptable.

Demonstration of laboratory proficiency

- See paragraphs 17 and 18 and Table 2 in 'hrER BINDING ASSAY COMPONENTS' of this test method. Each assay (saturation and competitive binding) should consist of three independent runs (i.e. with fresh dilutions of receptor, chemicals, and reagents) on different days, and each run should contain three replicates.

Determination of Receptor (hrER α) Concentration

- The concentration of active receptor varies slightly by batch and storage conditions. For this reason, the concentration of active receptor as received from the supplier should be determined. This will yield the appropriate concentration of active receptor at the time of the run.
- Under conditions corresponding to competitive binding (i.e. 1 nM [³H]-estradiol), nominal concentrations of 0,25, 0,5, 0,75, and 1 nM receptor should be incubated in the absence (total binding) and presence (non-specific binding) of 1 μ M unlabelled estradiol. Specific binding, calculated as the difference of total and non-specific binding, is plotted against the nominal receptor concentration. The concentration of receptor that gives specific binding values corresponding to 20 % of added radiolabel is related to the corresponding nominal receptor concentration, and this receptor concentration should be used for saturation and competitive binding experiments. Frequently, a final hrER concentration of 0,5 nM will comply with this condition.

▼M8

13. If the 20 % criterion repeatedly cannot be met, the experimental set up should be checked for potential errors. Failure to achieve the 20 % criterion may indicate that there is very little active receptor in the recombinant batch, and the use of another receptor batch should then be considered.

Saturation assay

14. Eight increasing concentrations of [³H]17β-estradiol should be evaluated in triplicate, under the following three conditions (see Table 2):

- In the absence of unlabelled 17β-estradiol and presence of ER. This is the determination of total binding by measure of the radioactivity in the wells that have only [3H]17β-estradiol.
- In the presence of a 1 000- fold excess concentration of unlabelled 17β-estradiol over labelled 17β-estradiol and presence of ER. The intent of this condition is to saturate the active binding sites with unlabelled 17β-estradiol, and by measuring the radioactivity in the wells, determine the non-specific binding. Any remaining hot estradiol that can bind to the receptor is considered to be binding at a non-specific site as the cold estradiol should be at such a high concentration that it is bound to all of the available specific sites on the receptor.
- In the absence of unlabelled 17β-estradiol and absence of ER (determination of total radioactivity)

Preparation of [³H]-17β-estradiol and unlabelled 17β-estradiol solutions

15. Dilutions of [³H]-17β-estradiol should be prepared by adding assay buffer to a 12 nM stock solution of [³H]-17β-estradiol to obtain concentrations initially ranging from 0,12nM to 12 nM. By adding 40 µl of these solutions to the respective assay wells of a 96-well microtiter plate (in a final volume of 160 µl), the final assay concentrations, ranging from 0,03 to 3,0 nM, will be obtained. Preparation of assay buffer, [³H]-17β-estradiol stock solution and dilutions and determination of the concentrations are described in depth in the FW protocol (2).
16. Dilutions of ethanolic 17β-estradiol solutions should be prepared by adding assay buffer to achieve eight increasing concentrations initially ranging from 0,06 µM to 6 µM. By adding 80 µl of these solutions to the respective assay wells of a 96-well microtiter plate (in a final volume of 160 µl), the final assay concentrations, ranging from 0,03µM to 3µM, will be obtained. The final concentration of unlabelled 17β-estradiol in the individual non-specific binding assay wells should be 1 000-fold of the labelled [³H]-17β- estradiol concentration. Preparation of unlabelled 17β-estradiol dilutions is described in depth in the FW protocol (2).
17. The nominal concentration of receptor that gives specific binding of 20±5 % should be used (see paragraphs 12-13). The hrERα solution should be prepared immediately prior to use.
18. The 96-well microtiter plates are prepared as illustrated in Table 2, with 3 replicates per concentration. Example of plate concentration and volume assignment of [³H]-17β-estradiol, unlabelled 17β-estradiol, buffer and receptor are provided in Appendix 2.2.

▼M8

Table 2

Saturation Binding Assay Microtiter Plate Layout

	1	2	3	4	5	6	7	8	9	10	11	12	
A	0,03 nM [3H] E2 + ER			0,06 nM [3H] E2 + ER			0,08 nM [3H] E2 + ER			0,10 nM [³ H] E2 + ER			Total Binding (Solvent)
B	0,30 nM [3H] E2 + ER			0,60 nM [3H] E2 + ER			1,0 nM [3H] E2 + ER			3,0 nM [3H] E2 + ER			
C													
D	0,03 nM [3H] E2 + ER + 0,03 µM E2			0,06 nM [3H] E2 + ER + 0,06 µM E2			0,08 nM [3H] E2 + ER + 0,08 µM E2			0,10 nM [3H] E2 + ER + 0,10 µM E2			Non-Specific Binding
E	0,30 nM [3H] E2 + ER + 0,30 µM E2			0,60 nM [3H] E2 + ER + 0,60 µM E2			1,0 nM [3H] E2 + ER + 1,0 µM E2			3,0 nM [3H] E2 + ER + 3,0 µM E2			
F													
G													
H													

[3H] E2: [3H]-17β-estradiol
ER: estrogen receptor
E2: unlabelled 17β-estradiol

19. Assay microtiter plates should be incubated at 2° to 8°C for 16 to 20 hours and placed on a rotator during the incubation period.

Measurement of [3H]-17β-Estradiol bound to hrERα

20. [³H]-17β-Estradiol bound to hrERα should be separated from free [³H]-17β-Estradiol by adding 80 µl of cold DCC suspension to each well, shaking the microtiter plates for 10 minutes and centrifugating for 10 minutes at about 2 500 RPM. To minimise dissociation of bound [³H]-17β-estradiol from the hrERα during this process, it is extremely important that the buffers and assay wells be kept between 2 and 8°C and that each step be conducted quickly. A shaker for microtiter plates is necessary to process plates efficiently and quickly.
21. 50 µl of supernatant containing the hrERα-bound [³H]-17β-estradiol should then be taken with extreme care, to avoid any contamination of the wells by touching DCC, and should be placed on a second microtiter plate.
22. 200 µl of scintillation fluid, capable of converting the kinetic energy of nuclear emissions into light energy, should then be added to each well (A1-B12 and D1 to E12). Wells G1-H12 (identified as total dpms) represent serial dilutions of the [³H]-17β-estradiol (40 µl) that should be delivered directly into the scintillation fluid in the wells of the measurement plate as indicated in Table 3, i.e. these wells contain only 200 µl of scintillation fluid and the appropriate dilution of [3H]-17β-estradiol. These measures demonstrate how much [³H]-17β-estradiol in dpms was added to each set of wells for the total binding and non-specific binding.

▼M8

Table 3

Saturation Binding Assay Microtiter Plate Layout, Radioactivity Measurement

	1	2	3	4	5	6	7	8	9	10	11	12	
A	0,03 nM [3H] E2 + ER			0,06 nM [3H] E2 + ER			0,08 nM [3H] E2 + ER			0,10 nM [3H] E2 + ER			Total Binding (Solvent)
B	0,30 nM [3H] E2 + ER			0,60 nM [3H] E2 + ER			1,0 nM [3H] E2 + ER			3,0 nM [3H] E2 + ER			
C													
D	0,03 nM [3H] E2 + ER + 0,03 µM E2			0,06 nM [3H] E2 + ER + 0,06 µM E2			0,08 nM [3H] E2 + ER + 0,08 µM E2			0,10 nM [3H] E2 + ER + 0,10 µM E2			Non-Specific Binding
E	0,30 nM [3H] E2 + ER + 0,30 µM E2			0,60 nM [3H] E2 + ER + 0,60 µM E2			1,0 nM [3H] E2 + ER + 1,0 µM E2			3,0 nM [3H] E2 + ER + 3,0 µM E2			
F													
G	0,03 nM [3H] E2 (total dpms)			0,06 nM [3H] E2			0,08 nM [3H] E2			0,10 nM [3H] E2			Total dpms (*)
H	0,30 nM [3H] E2			0,60 nM [3H] E2			1,0 nM [3H] E2			3,0 nM [3H] E2			

[3H] E2: [3H]-17β-estradiol

ER: estrogen receptor

E2: unlabelled 17β-estradiol

dpms: disintegrations per minute

(*) The hot serial dilutions of [3H]-labelled estradiol here should be directly added into 200 µl of scintillation fluid in wells G1 – H12.

23. Measurement should start with a delay of at least 2 hours and counting time should be 40 minutes per well. A microtiter plate scintillation counter should be used for determination of dpm/well with quench correction. Alternatively, if a scintillation counter for a microtiter plate is not available, samples may be measured in a conventional counter. Under these conditions, a reduction of counting time may be considered.

Competitive binding assay

24. The competitive binding assay measures the binding of a single concentration of [3H]-17β-estradiol in the presence of increasing concentrations of a test chemical. Three concurrent replicates should be used at each concentration within one run. In addition, three non-concurrent runs should be performed for each chemical tested. The assay should be set up in one or more 96-well microtiter plates

Controls

25. When performing the assay, concurrent solvent and controls (i.e. reference estrogen, weak binder, and non-binder) should be included in each experiment. Full concentration curves for the reference estrogen and controls (i.e. weak binder and non-binder) should be used in one plate during each run. All other plates should contain (i) a high- (maximum displacement) and medium- (approximately the IC₅₀) concentration each of E2 and weak binder in triplicate; (ii) solvent control and non-specific binding, each at least in triplicate. Procedures for the preparation of assay buffer, controls, [3H]-17β-estradiol, hrERα and test chemical solutions are described in Reference 2 (Annex K, see FW Assay Protocol).

▼ M8*Solvent control:*

26. The solvent control indicates that the solvent does not interact with the test system and also measures total binding (TB). Ethanol is the preferred solvent. Alternatively, if the highest concentration of the test chemical is not soluble in ethanol, DMSO may be used. The concentration of ethanol or DMSO, if used, in the final assay wells is 1,5 % and may not exceed 2 %.

Buffer control:

27. The buffer control (BC) should contain neither solvent nor test chemical, but all of the other components of the assay. The results of the buffer control are compared to the solvent control to verify that the solvent used does not affect the assay system.

Strong binder (reference estrogen)

28. 17 β -estradiol (CAS 50-28-2) is the endogenous ligand and binds with high affinity to the ER, alpha subtype. A standard curve using unlabelled 17 β -estradiol should be prepared for each hrER α competitive binding assay, to allow for an assessment of variability when conducting the assay over time within the same laboratory. Eight solutions of unlabelled 17 β -estradiol should be prepared in ethanol, with concentrations in the assay wells ranging from 100 nM – 10 pM (-7[logM] to -11[logM]), spaced as follows: (-7[logM], -8[logM], -8.5[logM], -9[logM], -9,5[logM], -10[logM], -11[logM]). The highest concentration of unlabelled 17 β -estradiol (1 μ M) also serves as the non-specific binding indicator. This concentration is distinguished by the label 'NSB' in Table 4 even though it is also part of the standard curve.

Weak binder

29. A weak binder (norethynodrel (CAS68-23-5) or norethindrone (CAS 68-22-4)) should be included to demonstrate the sensitivity of each experiment and to allow an assessment of variability when conducting the assay over time. Eight solutions of the weak binder should be prepared in ethanol, with concentrations in the assay wells ranging from 3 nM to 30 μ M (-8.5[logM] to -4.5[logM]), spaced as follows: -4.5[logM], -5[logM], -5.5[logM], -6[logM], -6.5[logM], -7[logM], -7.5[logM], -8.5[logM].

Non binder

30. Octyltriethoxysilane (OTES, CAS 2 943-75-1) should be used as the negative control (non-binder). It provides assurance that the assay as run, will detect when test chemicals do not bind to the hrER α . Eight solutions of the non-binder should be prepared in ethanol, with concentrations in the assay wells ranging from 0,1nM to 1 000 μ M (-10[logM] to -3[logM]), in log increments. Di-*n*-butyl phtalate (DBP) can be used as an alternate control non-binder. Its maximum solubility has been shown to be -4[logM].

hrER α concentration

31. The amount of receptor that gives specific binding of 20 \pm 5 % of 1 nM radioligand should be used (see paragraphs 12-13 of Appendix 2). The hrER α solution should be prepared immediately prior to use.

[3H]-17 β -estradiol

32. The concentration of [³H]-17 β -estradiol in the assay wells should be of 1,0 nM.

▼ M8*Test Chemicals*

33. In the first instance, it is necessary to conduct a solubility test to determine the limit of solubility for each test chemical and to identify the appropriate concentration range to use when conducting the test protocol. The limit of solubility of each test chemical is to be initially determined in the solvent and further confirmed under assay conditions. The final concentration tested in the assay should not exceed 1 mM. Range finder testing consists of a solvent control along with 8 log serial dilutions, starting at the maximum acceptable concentration (e.g. 1 mM or lower, based upon the limit of solubility), and the presence of cloudiness or precipitate noted (see also paragraph 35). The test chemical should be tested using 8 log concentration spaced curves as defined by the preceding range finding test. Concentrations in the second and third experiments should be adjusted as appropriate to better characterise the concentration-response curve.

34. Dilutions of the test chemical should be prepared in the appropriate solvent (see paragraph 26 of Appendix 2). If the highest concentration of the test chemical is not soluble in either ethanol or DMSO, and adding more solvent would cause the solvent concentration in the final tube to be greater than the acceptable limit, the highest concentration may be reduced to the next lower concentration. In this case, an additional concentration may be added at the low end of the concentration series. Other concentrations in the series should remain unchanged.

35. The test chemical solutions should be closely monitored when added to the assay well, as the test chemical may precipitate upon addition to the assay well. The data for all wells that contain precipitate should be excluded from curve-fitting, and the reason for exclusion of the data noted.

36. If there is prior existing information from other sources that provide a $\log(\text{IC}_{50})$ of a test chemical, it may be appropriate to geometrically space the dilutions (i.e. 0,5 log units around the expected $\log(\text{IC}_{50})$). The final result should reflect sufficient spread of concentrations on either side of the $\log(\text{IC}_{50})$, including the 'top' and 'bottom', such that the binding curve can be adequately characterised.

Assay plate organisation

37. Labelled microtiter plates should be prepared considering sextuple incubations with codes for the solvent control, the highest concentration of the reference estrogen which also serves as the non-specific binding (NSB) indicator, and the buffer control and considering triplicate incubations with codes for each of the eight concentrations of the non-binding control (octyl-triethoxysilane), the 7 lower concentrations for the reference estrogen, the eight concentrations dose levels of the weak binder, and the 8 concentrations of each test chemical (TC). An example layout of the plate diagram for the full concentration curves for the reference estrogen and control is given below in Table 4. Additional microtiter plates are used for the test chemicals and should include plate controls, i.e. 1) a high- (maximum displacement) and medium- (approximately the IC_{50}) concentration each of E2 and weak binder in triplicate; 2) solvent control and non-specific binding, each in sextuple (Table 5). An example of a competitive assay microtiter plate layout worksheet using three unknown test chemicals is provided in

▼M8

Appendix 2.3. The concentrations indicated in Tables 4 and 5 are the final concentrations of the assay. The maximum concentration for E2 should be 1×10^{-7} M and for the weak binder, the highest concentration used for the weak binder on plate 1 should be used. The IC_{50} concentration has to be determined by the laboratory based on their historical control database. It is expected that this value would be similar to that observed in the validation studies (see Table 1).

Table 4

Competitive Binding Assay Microtiter Plate Layout, Full Concentration Curves for Reference Estrogen and Controls (Plate 1)

	1	2	3	4	5	6	7	8	9	10	11	12
A	TB (Solvent only)			TB (Solvent only)			NSB			NSB		
B	E2 (1×10^{-7})			E2 (1×10^{-8})			E2 ($1 \times 10^{-8,5}$)			E2 (1×10^{-9})		
C	E2 ($1 \times 10^{-9,5}$)			E2 (1×10^{-10})			E2 (1×10^{-11})			Blank (*)		
D	NE ($1 \times 10^{-4,5}$)			NE (1×10^{-5})			NE ($1 \times 10^{-5,5}$)			NE (1×10^{-6})		
E	NE ($1 \times 10^{-6,5}$)			NE (1×10^{-7})			NE ($1 \times 10^{-7,5}$)			NE ($1 \times 10^{-8,5}$)		
F	OTES (1×10^{-3})			OTES (1×10^{-4})			OTES (1×10^{-5})			OTES (1×10^{-6})		
G	OTES (1×10^{-7})			OTES (1×10^{-8})			OTES (1×10^{-9})			OTES (1×10^{-10})		
H	Blank (for hot) (**)			Blank (for hot) (**)			Buffer control			Buffer control		

In this example, the weak binder is norethinodrel (NE)

(*) real blank, well not used

(**) blank not used during the incubation, but used to confirm the total radioactivity added.

Table 5

Competitive Binding Assay Microtiter Plate Layout, Full Concentration Curves for Test Chemicals and Plate Controls

	1	2	3	4	5	6	7	8	9	10	11	12
A	TB (Solvent only)			TB (Solvent only)			NSB			NSB		
B	TC1 (1×10^{-3})			TC1 (1×10^{-4})			TC1 (1×10^{-5})			TC1 (1×10^{-6})		
C	TC1 (1×10^{-7})			TC1 (1×10^{-8})			TC1 (1×10^{-9})			TC1 (1×10^{-10})		
D	TC2 (1×10^{-3})			TC2 (1×10^{-4})			TC2 (1×10^{-5})			TC2 (1×10^{-6})		
E	TC2 (1×10^{-7})			TC2 (1×10^{-8})			TC2 (1×10^{-9})			TC2 (1×10^{-10})		
F	TC3 (1×10^{-3})			TC3 (1×10^{-4})			TC3 (1×10^{-5})			TC3 (1×10^{-6})		
G	TC3 (1×10^{-7})			TC3 (1×10^{-8})			TC3 (1×10^{-9})			TC3 (1×10^{-10})		
H	NE (IC_{50})			NE ($1 \times 10^{-4,5}$)			E2 (IC_{50})			E2 (1×10^{-7})		

In this example, the weak binder is norethinodrel (NE)

▼M8*Completion of competitive binding assay*

38. As shown in Table 6, 80 µl of the solvent control, buffer control, reference estrogen, weak binder, non-binder, and test chemicals prepared in assay buffer should be added to the wells. Then, 40 µl of a 4 nM [³H]-17β-estradiol solution should be added to each well. After gentle rotation for 10 to 15 minutes between 2° to 8°C, 40 µl of hrERα solution should be added. Assay microtiter plates should be incubated at 2° to 8°C for 16 to 20 hours, and placed on a rotator during the incubation period.

Table 6

Volume of Assay Components for hrER Competitive Binding Assay, Microtiter Plates

Volume (µl)	Constituent
80	Unlabelled 17β-estradiol, norethynodrel, OTES, test chemicals, solvent or buffer
40	4 nM [³ H]-17β-estradiol solution
40	hrERα solution, concentration as determined
160	Total volume in each assay well

39. The quantification of [³H]-17β-Estradiol bound to hrERα, following separation of [³H]-17β-Estradiol bound to hrERα from free [³H]-17β-Estradiol by adding 80 µl of cold DCC suspension to each well, should then be performed as described in paragraphs 20-23 for the saturation binding assay.
40. Wells H1-6 (identified as blank (for hot) in table 4) represent the dpms of the [³H]-labelled-estradiol in 40 µl. The 40 µl aliquot should be delivered directly into the scintillation fluid in wells H1 – H6.

Acceptability criteria*Saturation binding assay*

41. The specific binding curve should reach a plateau as increasing concentrations of [³H]-17β-estradiol were used, indicating saturation of hrERα with ligand.
42. The specific binding at 1 nM of [3H]-17β-estradiol should be inside the acceptable range 15 % to 25 % of the average measured total radioactivity added across runs. Occasional slight excursions outside of this range are acceptable, but if runs are consistently outside this range or a particular run is significantly outside this range, the protein concentration should be adjusted and the saturation assay repeated.
43. The data should produce a linear Scatchard plot.
44. The non-specific binding should not be excessive. The value for non-specific binding should typically be <35 % of the total binding. However, the ratio might occasionally exceed this limit when measuring very low dpm for the lowest concentration of radiolabelled 17β-Estradiol tested.

▼M8*Competitive binding assay*

45. Increasing concentrations of unlabelled 17 β -estradiol should displace [³H]-17 β -estradiol from the receptor in a manner consistent with a one-site competitive binding.

46. The IC₅₀ value for the reference estrogen (i.e. 17 β -estradiol) should be approximately equal to the molar concentration of [³H]-17 β -estradiol plus the K_d determined from the saturation binding assay.

47. The total specific binding should be consistently within the acceptable range of 20 \pm 5 % when the average measured concentration of total radioactivity added to each well was 1 nM across runs. Occasional slight excursions outside of this range are acceptable, but if runs are consistently outside this range or a particular run is significantly outside this range, the protein concentration should be adjusted.

48. The solvent should not alter the sensitivity or reproducibility of the assay. The results of the solvent control (TB wells) are compared to the buffer control to verify that the solvent used does not affect the assay system. The results of the TB and Buffer control should be comparable if there is no effect of the solvent on the assay.

49. The non-binder should not displace more than 25 % of the [³H]-17 β -estradiol from the hrER α when tested up to 10⁻³ M (OTES) or 10⁻⁴ M (DBP).

50. Performance criteria were developed for the reference estrogen and two weak binders (e.g. norethynodrel, norethindrone) using data from the validation study of the FW hrER Binding Assay (Annex N of Reference 2). 95 % confidence intervals are provided for the mean (n) \pm SD for all control runs across the laboratories participating in the validation study. 95 % confidence intervals were calculated for the curve fit parameters (i.e. top, bottom, Hill slope, logIC₅₀) for the reference estrogen and weak binders and for the log₁₀RBA of the weak binders relative to the reference estrogen and are provided as performance criteria for the positive controls. Table 1 provides expected ranges for the curve fit parameters that can be used as performance criteria. In practice, the range of the IC₅₀ may vary slightly based upon the K_d of receptor preparation and ligand concentration.

51. No performance criteria was developed for curve fit parameters for the test chemicals because of the wide array of existing potential test chemicals and variation in potential affinities and outcomes (e.g. Full curve, partial curve, no curve fit). However, professional judgment should be applied when reviewing results from each run for a test chemical. A sufficient range of concentrations of the test chemical should be used to clearly define the top (e.g. 90 - 100 % of binding) of the competitive curve. Variability among replicates at each concentration of test chemical as well as among the 3 non-concurrent runs should be reasonable and scientifically defensible. Controls from each run for a test chemical should approach the measures of performance reported for this FW assay and be consistent historical control data from each respective laboratory.

▼ M8

ANALYSIS OF DATA

Saturation binding assay

52. Both total and non-specific binding are measured. From these values, specific binding of increasing concentrations of [³H]-17β-estradiol under equilibrium conditions is calculated by subtracting non-specific from total. A graph of specific binding versus [³H]-17β-estradiol concentration should reach a plateau for maximum specific binding indicative of saturation of the hrERα with the [³H]-17β-estradiol. In addition, analysis of the data should document the binding of the [³H]-17β-estradiol to a single, high-affinity binding site. Non-specific, total, and specific binding should be displayed on a saturation binding curve. Further analysis of these data should use a non-linear regression analysis (e.g. BioSoft; McPherson, 1985; Motulsky, 1995) with a final display of the data as a Scatchard plot.
53. The data analysis should determine Bmax and Kd from the total binding data alone, using the assumption that non-specific binding is linear, unless justification is given for using a different method. In addition, robust regression should be used when determining the best fit unless justification is given. The method chosen for robust regression should be stated. Correction for ligand depletion (e.g. using the method of Swillens 1995) should always be used when determining Bmax and Kd from saturation binding data.

Competitive binding assay

54. The competitive binding curve is plotted as specific [³H]-17β-estradiol binding versus the concentration (log10 units) of the competitor. The concentration of the test chemical that inhibits 50 % of the maximum specific [³H]-17β-estradiol binding is the IC₅₀ value.
55. Estimates of log(IC₅₀) values for the positive controls (e.g. reference estrogen and weak binder) should be determined using an appropriate nonlinear curve fitting software to fit a four parameter Hill equation (e.g. BioSoft; McPherson, 1985; Motulsky, 1995). The top, bottom, slope, and log(IC₅₀) should generally be left unconstrained when fitting these curves. Robust regression should be used when determining the best fit unless justification is given. Correction for ligand depletion should not be used. Following the initial analysis, each binding curve should be reviewed to ensure appropriate fit to the model. The relative binding affinity (RBA) for the weak binder should be calculated as a percent of the log (IC₅₀) for the weak binder relative to the log (IC₅₀) for 17β-estradiol. Results from the positive controls and the non-binder control should be evaluated using the measures of the assay performance in paragraphs 45-50 in this Appendix 2.
56. Data for all test chemicals should be analysed using a step-wise approach to ensure that data are appropriately analysed and that each competitive binding curve is properly classified. It is recommended that each run for a test chemical initially undergo a standardised data analysis that is identical to that used for the reference estrogen and weak binder controls (see paragraph 55 above). Once completed, a technical review of the curve fit parameters as well as a visual review of how well the data fit the generated competitive binding curve for each run should be conducted. During this technical review, the observations of a concentration dependent decrease in the percent [³H]-17β-estradiol specifically bound, low variability among the technical replicates at each chemical concentration, and consistency in fit parameters among the three runs are a good indication that the assay and data analyses were conducted appropriately.

▼ M8

Data interpretation

57. Providing that all acceptability criteria are fulfilled, a test chemical is considered to be a binder for the hrER α if a binding curve can be fit and the lowest point on the response curve within the range of the data is less than 50 % (Figure 1).
58. Providing that all acceptability criteria are fulfilled, a test chemical is considered to be a non-binder for the hrER α if:
- A binding curve can be fit and the lowest point on the fitted response curve within the range of the data is above 75 %, or
 - A binding curve cannot be fit and the lowest unsmoothed average percent binding among the concentration groups in the data is above 75 %.
59. Test chemicals are considered equivocal if none of the above conditions are met (e.g. the lowest point on the fitted response curve is between 76 – 51 %).

Table 7

Criteria for assigning classification based upon competitive binding curve for a test chemical

Classification	Criteria
Binder ^a	A binding curve can be fit. The lowest point on the response curve within the range of the data is less than 50 % .
Non-binder ^b	If a binding curve can be fit, the lowest point on the fitted response curve within the range of the data is above 75 % . If a binding curve cannot be fit, the lowest unsmoothed average percent binding among the concentration groups in the data is above 75 % .
Equivocal ^c	Any testable run that is neither a binder nor a non-binder (e.g. The lowest point on the fitted response curve is between 76 – 51 %).

Figure 1

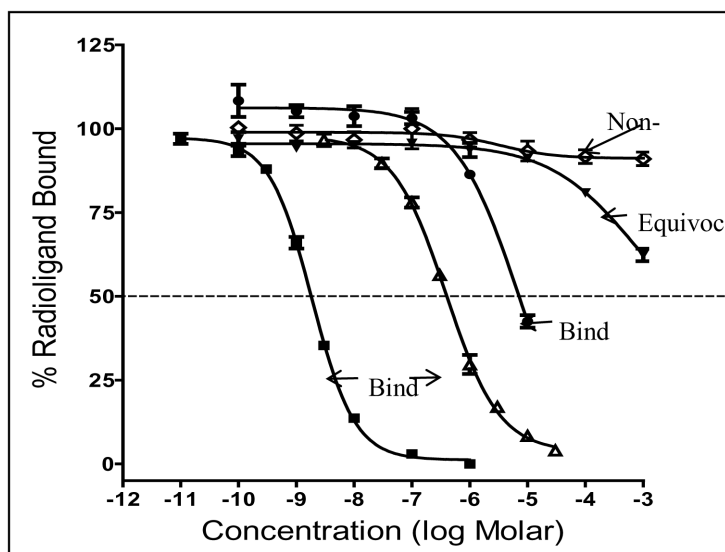
Examples of test chemical classification using competitive binding curve

▼M8

60. Multiple runs conducted within a laboratory for a test chemical are combined by assigning numeric values to each run and averaging across the runs as shown in Table 8. Results for the combined runs within each laboratory are compared with the expected classification for each test chemical.

*Table 8***Method for classification of test chemical using multiple runs within a laboratory**

To assign value to each run:	
Classification	Numeric Value
Binder	2
Equivocal	1
Non-binder	0
To classify average of numeric value across runs:	
Classification	Numeric Value
Binder	Average $\geq 1,5$
Equivocal	$0,5 \leq \text{Average} < 1,5$
Non-binder	Average $< 0,5$

TEST REPORT

61. See paragraph 24 of 'hrER BINDING ASSAY COMPONENTS' of this test method.

▼ M8*Appendix 2.1*

LIST OF TERMS

[³H]E2: 17β-Estradiol radiolabelled with tritium

DCC: Dextran-coated charcoal

E2: Unlabelled 17β-estradiol (inert)

Assay buffer: 10 mM Tris, 10 mg Bovine Serum Albumin /ml, 2 mM DTT, 10 % glycerol, 0,2 mM leupeptin, pH 7.5

hrERα: Human recombinant estrogen receptor alpha

Replicate: One of multiple wells that contain the same contents at the same concentrations and are assayed concurrently within a single run. In this protocol, each concentration of test chemical is tested in triplicate; that is, there are three replicates that are assayed simultaneously at each concentration of test chemical.

Run: A complete set of concurrently-run microtiter plate assay wells that provides all the information necessary to characterise binding of a test chemical to the hrERα (viz., total [³H]-17β-estradiol added to the assay well, maximum binding of [³H]-17β-estradiol to the hrERα, nonspecific binding, and total binding at various concentrations of test chemical). A run could consist of as few as one assay well (i.e. replicate) per concentration, but since this protocol requires assaying in triplicate, one run consists of three assay wells per concentration. In addition, this protocol requires three independent (i.e. non-concurrent) runs per chemical.

▼M8

Appendix 2.2

TYPICAL [³H]-17B-ESTRADIOL SATURATION ASSAY WITH THREE REPLICATE WELLS

Typical [³ H]-17β-Estradiol Saturation Assay with Three Replicate Wells											
Position	Replicate	Well Type Code	Hot E2 Initial Concentration (nM)	Hot E2 Volume (μl)	Hot E2 Final Concentration (nM)	Cold E2 Initial Concentration (μM)	Cold E2 Volume (μl)	Cold E2 Final Concentration (μM)	Buffer Volume (μl)	Receptor Volume (μl)	Total volume in wells
A1	1	H	0,12	40	0,03	—	—	—	80	40	160
A2	2	H	0,12	40	0,03	—	—	—	80	40	160
A3	3	H	0,12	40	0,03	—	—	—	80	40	160
A4	1	H	0,24	40	0,06	—	—	—	80	40	160
A5	2	H	0,24	40	0,06	—	—	—	80	40	160
A6	3	H	0,24	40	0,06	—	—	—	80	40	160
A7	1	H	0,32	40	0,08	—	—	—	80	40	160
A8	2	H	0,32	40	0,08	—	—	—	80	40	160
A9	3	H	0,32	40	0,08	—	—	—	80	40	160
A10	1	H	0,40	40	0,10	—	—	—	80	40	160
A11	2	H	0,40	40	0,10	—	—	—	80	40	160
A12	3	H	0,40	40	0,10	—	—	—	80	40	160
B1	1	H	1,20	40	0,30	—	—	—	80	40	160
B2	2	H	1,20	40	0,30	—	—	—	80	40	160
B3	3	H	1,20	40	0,30	—	—	—	80	40	160
B4	1	H	2,40	40	0,60	—	—	—	80	40	160
B5	2	H	2,40	40	0,60	—	—	—	80	40	160
B6	3	H	2,40	40	0,60	—	—	—	80	40	160
B7	1	H	4,00	40	1,00	—	—	—	80	40	160
B8	2	H	4,00	40	1,00	—	—	—	80	40	160

▼M8

Typical [3H]-17 β -Estradiol Saturation Assay with Three Replicate Wells

Position	Replicate	Well Type Code	Hot E2 Initial Concentration (nM)	Hot E2 Volume (μ l)	Hot E2 Final Concentration (nM)	Cold E2 Initial Concentration (μ M)	Cold E2 Volume (μ l)	Cold E2 Final Concentration (μ M)	Buffer Volume (μ l)	Receptor Volume (μ l)	Total volume in wells
B9	3	H	4,00	40	1,00	—	—	—	80	40	160
B10	1	H	12,00	40	3,00	—	—	—	80	40	160
B11	2	H	12,00	40	3,00	—	—	—	80	40	160
B12	3	H	12,00	40	3,00	—	—	—	80	40	160
D1	1	HC	0,12	40	0,03	0,06	80	0,03	—	40	160
D2	2	HC	0,12	40	0,03	0,06	80	0,03	—	40	160
D3	3	HC	0,12	40	0,03	0,06	80	0,03	—	40	160
D4	1	HC	0,24	40	0,06	0,12	80	0,06	—	40	160
D5	2	HC	0,24	40	0,06	0,12	80	0,06	—	40	160
D6	3	HC	0,24	40	0,06	0,12	80	0,06	—	40	160
D7	1	HC	0,32	40	0,08	0,16	80	0,08	—	40	160
D8	2	HC	0,32	40	0,08	0,16	80	0,08	—	40	160
D9	3	HC	0,32	40	0,08	0,16	80	0,08	—	40	160
D10	1	HC	0,40	40	0,10	0,2	80	0,1	—	40	160
D11	2	HC	0,40	40	0,10	0,2	80	0,1	—	40	160
D12	3	HC	0,40	40	0,10	0,2	80	0,1	—	40	160
E1	1	HC	1,20	40	0,30	0,6	80	0,3	—	40	160
E2	2	HC	1,20	40	0,30	0,6	80	0,3	—	40	160
E3	3	HC	1,20	40	0,30	0,6	80	0,3	—	40	160
E4	1	HC	2,40	40	0,60	1,2	80	0,6	—	40	160
E5	2	HC	2,40	40	0,60	1,2	80	0,6	—	40	160
E6	3	HC	2,40	40	0,60	1,2	80	0,6	—	40	160

▼M8

Typical [³H]-17β-Estradiol Saturation Assay with Three Replicate Wells

Position	Replicate	Well Type Code	Hot E2 Initial Concentration (nM)	Hot E2 Volume (µl)	Hot E2 Final Concentration (nM)	Cold E2 Initial Concentration (µM)	Cold E2 Volume (µl)	Cold E2 Final Concentration (µM)	Buffer Volume (µl)	Receptor Volume (µl)	Total volume in wells
E7	1	HC	4,00	40	1,00	2	80	1	—	40	160
E8	2	HC	4,00	40	1,00	2	80	1	—	40	160
E9	3	HC	4,00	40	1,00	2	80	1	—	40	160
E10	1	HC	12,00	40	3,00	6	80	3	—	40	160
E11	2	HC	12,00	40	3,00	6	80	3	—	40	160
E12	3	HC	12,00	40	3,00	6	80	3	—	40	160
G1	1	Hot	0,12	40	0,03	—	—	—	—	—	40
G2	2	Hot	0,12	40	0,03	—	—	—	—	—	40
G3	3	Hot	0,12	40	0,03	—	—	—	—	—	40
G4	1	Hot	0,24	40	0,06	—	—	—	—	—	40
G5	2	Hot	0,24	40	0,06	—	—	—	—	—	40
G6	3	Hot	0,24	40	0,06	—	—	—	—	—	40
G7	1	Hot	0,32	40	0,08	—	—	—	—	—	40
G8	2	Hot	0,32	40	0,08	—	—	—	—	—	40
G9	3	Hot	0,32	40	0,08	—	—	—	—	—	40
G10	1	Hot	0,40	40	0,10	—	—	—	—	—	40
G11	2	Hot	0,40	40	0,10	—	—	—	—	—	40
G12	3	Hot	0,40	40	0,10	—	—	—	—	—	40

▼ M8

Typical [3H]-17 β -Estradiol Saturation Assay with Three Replicate Wells

Position	Replicate	Well Type Code	Hot E2 Initial Concentration (nM)	Hot E2 Volume (μ l)	Hot E2 Final Concentration (nM)	Cold E2 Initial Concentration (μ M)	Cold E2 Volume (μ l)	Cold E2 Final Concentration (μ M)	Buffer Volume (μ l)	Receptor Volume (μ l)	Total volume in wells
H1	1	Hot	1,20	40	0,30	—	—	—	—	—	40
H2	2	Hot	1,20	40	0,30	—	—	—	—	—	40
H3	3	Hot	1,20	40	0,30	—	—	—	—	—	40
H4	1	Hot	2,40	40	0,60	—	—	—	—	—	40
H5	2	Hot	2,40	40	0,60	—	—	—	—	—	40
H6	3	Hot	2,40	40	0,60	—	—	—	—	—	40
H7	1	Hot	4,00	40	1,00	—	—	—	—	—	40
H8	2	Hot	4,00	40	1,00	—	—	—	—	—	40
H9	3	Hot	4,00	40	1,00	—	—	—	—	—	40
H10	1	Hot	12,00	40	3,00	—	—	—	—	—	40
H11	2	Hot	12,00	40	3,00	—	—	—	—	—	40
H12	3	Hot	12,00	40	3,00	—	—	—	—	—	40

Note that the 'hot' wells are empty during incubation. The 40 μ l are added only for scintillation counting.

▼M8

Appendix 2.3

COMPETITIVE BINDING ASSAY WELL LAYOUT

Plate	Position	Replicate	Well type	Well code	Concentration code	Competitor Initial Concentration (M)	hrER stock (µl)	Buffer Volume (µl)	Tracer (Hot E2) Volume (µL)	Volume from dilution plate (µL)	Final Volume (µl)	Competitor Final Concentration (M)
S	A1	1	total binding	TB	TB1	—	40		40	80	160	—
S	A2	2	total binding	TB	TB2	—	40		40	80	160	—
S	A3	3	total binding	TB	TB3	—	40		40	80	160	—
S	A4	1	total binding	TB	TB4	—	40		40	80	160	—
S	A5	2	total binding	TB	TB5	—	40		40	80	160	—
S	A6	3	total binding	TB	TB6	—	40		40	80	160	—
S	A7	1	cold E2 (high)	NSB	S0	2,00E-06	40	—	40	80	160	1,0E-06
S	A8	2	cold E2 (high)	NSB	S0	2,00E-06	40	—	40	80	160	1,0E-06
S	A9	3	cold E2 (high)	NSB	S0	2,00E-06	40	—	40	80	160	1,0E-06
S	A10	1	cold E2 (high)	NSB	S0	2,00E-06	40	—	40	80	160	1,0E-06
S	A11	2	cold E2 (high)	NSB	S0	2,00E-06	40	—	40	80	160	1,0E-06
S	A12	3	cold E2 (high)	NSB	S0	2,00E-06	40	—	40	80	160	1,0E-06
S	B1	1	cold E2	S	S1	2,00E-07	40	—	40	80	160	1,0E-07
S	B2	2	cold E2	S	S1	2,00E-07	40	—	40	80	160	1,0E-07
S	B3	3	cold E2	S	S1	2,00E-07	40	—	40	80	160	1,0E-07
S	B4	1	cold E2	S	S2	2,00E-08	40	—	40	80	160	1,0E-08

▼ M8

Plate	Position	Replicate	Well type	Well code	Concentration code	Competitor Initial Concentration (M)	hr-ER stock (μ l)	Buffer Volume (μ l)	Tracer (Hot E2) Volume (μ L)	Volume from dilution plate (μ L)	Final Volume (μ l)	Competitor Final Concentration (M)
S	B5	2	cold E2	S	S2	2,00E-08	40	—	40	80	160	1,0E-08
S	B6	3	cold E2	S	S2	2,00E-08	40	—	40	80	160	1,0E-08
S	B7	1	cold E2	S	S3	6,00E-09	40	—	40	80	160	3,0E-09
S	B8	2	cold E2	S	S3	6,00E-09	40	—	40	80	160	3,0E-09
S	B9	3	cold E2	S	S3	6,00E-09	40	—	40	80	160	3,0E-09
S	B10	1	cold E2	S	S4	2,00E-09	40	—	40	80	160	1,0E-09
S	B11	2	cold E2	S	S4	2,00E-09	40	—	40	80	160	1,0E-09
S	B12	3	cold E2	S	S4	2,00E-09	40	—	40	80	160	1,0E-09
S	C1	1	cold E2	S	S5	6,00E-10	40	—	40	80	160	3,0E-10
S	C2	2	cold E2	S	S5	6,00E-10	40	—	40	80	160	3,0E-10
S	C3	3	cold E2	S	S5	6,00E-10	40	—	40	80	160	3,0E-10
S	C4	1	cold E2	S	S6	2,00E-10	40	—	40	80	160	1,0E-10
S	C5	2	cold E2	S	S6	2,00E-10	40	—	40	80	160	1,0E-10
S	C6	3	cold E2	S	S6	2,00E-10	40	—	40	80	160	1,0E-10
S	C7	1	cold E2	S	S7	2,00E-11	40	—	40	80	160	1,0E-11
S	C8	2	cold E2	S	S7	2,00E-11	40	—	40	80	160	1,0E-11

▼M8

Plate	Position	Replicate	Well type	Well code	Concentration code	Competitor Initial Concentration (M)	hr-ER stock (µl)	Buffer Volume (µl)	Tracer (Hot E2) Volume (µL)	Volume from dilution plate (µL)	Final Volume (µl)	Competitor Final Concentration (M)
S	C9	3	cold E2	S	S7	2,00E-11	40	—	40	80	160	1,0E-11
S	C10	1	blank	blank	B1	—	—	160	—	—	160	—
S	C11	2	blank	blank	B2	—	—	160	—	—	160	—
S	C12	3	blank	blank	B3	—	—	160	—	—	160	—
S	D1	1	norethy- nodrel	NE	WP1	6,00E-05	40	—	40	80	160	3,0E-05
S	D2	1	norethy- nodrel	NE	WP1	6,00E-05	40	—	40	80	160	3,0E-05
S	D3	1	norethy- nodrel	NE	WP1	6,00E-05	40	—	40	80	160	3,0E-05
S	D4	1	norethy- nodrel	NE	WP2	2,00E-05	40	—	40	80	160	1,0E-05
S	D5	1	norethy- nodrel	NE	WP2	2,00E-05	40	—	40	80	160	1,0E-05
S	D6	1	norethy- nodrel	NE	WP2	2,00E-05	40	—	40	80	160	1,0E-05
S	D7	1	norethy- nodrel	NE	WP3	6,00E-06	40	—	40	80	160	3,0E-06
S	D8	1	norethy- nodrel	NE	WP3	6,00E-06	40	—	40	80	160	3,0E-06
S	D9	1	norethy- nodrel	NE	WP3	6,00E-06	40	—	40	80	160	3,0E-06
S	D10	1	norethy- nodrel	NE	WP4	2,00E-06	40	—	40	80	160	1,0E-06
S	D11	1	norethy- nodrel	NE	WP4	2,00E-06	40	—	40	80	160	1,0E-06
S	D12	1	norethy- nodrel	NE	WP4	2,00E-06	40	—	40	80	160	1,0E-06
S	E1	1	norethy- nodrel	NE	WP	6,00E-07	40		40	80	160	3,0E-07
S	E2	2	norethy- nodrel	NE	WP	6,00E-07	40		40	80	160	3,0E-07
S	E3	3	norethy- nodrel	NE	WP	6,00E-07	40		40	80	160	3,0E-07
S	E4	1	norethy- nodrel	NE	WP	2,00E-07	40		40	80	160	1,0E-07
S	E5	2	norethy- nodrel	NE	WP	2,00E-07	40		40	80	160	1,0E-07
S	E6	3	norethy- nodrel	NE	WP	2,00E-07	40		40	80	160	1,0E-07
S	E7	1	norethy- nodrel	NE	WP	6,00E-08	40	—	40	80	160	3,0E-08

▼ M8

Plate	Position	Replicate	Well type	Well code	Concentration code	Competitor Initial Concentration (M)	hrER stock (µl)	Buffer Volume (µl)	Tracer (Hot E2) Volume (µL)	Volume from dilution plate (µL)	Final Volume (µl)	Competitor Final Concentration (M)
S	E8	2	norethy- nodrel	NE	WP	6,00E-08	40	—	40	80	160	3,0E-08
S	E9	3	norethy- nodrel	NE	WP	6,00E-08	40	—	40	80	160	3,0E-08
S	E10	1	norethy- nodrel	NE	WP	6,00E-09	40	—	40	80	160	3,0E-09
S	E11	2	norethy- nodrel	NE	WP	6,00E-09	40	—	40	80	160	3,0E-09
S	E12	3	norethy- nodrel	NE	WP	6,00E-09	40	—	40	80	160	3,0E-09
S	F1	1	OTES	N	OTES	2,00E-03	40	—	40	80	160	1,0E-03
S	F2	2	OTES	N	OTES	2,00E-03	40	—	40	80	160	1,0E-03
S	F3	3	OTES	N	OTES	2,00E-03	40	—	40	80	160	1,0E-03
S	F4	1	OTES	N	OTES	2,00E-04	40	—	40	80	160	1,0E-04
S	F5	2	OTES	N	OTES	2,00E-04	40	—	40	80	160	1,0E-04
S	F6	3	OTES	N	OTES	2,00E-04	40	—	40	80	160	1,0E-04
S	F7	1	OTES	N	OTES	2,00E-05	40	—	40	80	160	3,0E-05
S	F8	2	OTES	N	OTES	2,00E-05	40	—	40	80	160	3,0E-05
S	F9	3	OTES	N	OTES	2,00E-05	40	—	40	80	160	3,0E-05
S	F10	1	OTES	N	OTES	2,00E-06	40	—	40	80	160	1,0E-06
S	F11	2	OTES	N	OTES	2,00E-06	40	—	40	80	160	1,0E-06
S	F12	3	OTES	N	OTES	2,00E-06	40	—	40	80	160	1,0E-06
S	G1	1	OTES	N	OTES	2,00E-07	40	—	40	80	160	3,0E-07
S	G2	2	OTES	N	OTES	2,00E-07	40	—	40	80	160	3,0E-07
S	G3	3	OTES	N	OTES	2,00E-07	40	—	40	80	160	3,0E-07
S	G4	1	OTES	N	OTES	2,00E-08	40	—	40	80	160	1,0E-08
S	G5	2	OTES	N	OTES	2,00E-08	40	—	40	80	160	1,0E-08

▼ M8

Plate	Position	Replicate	Well type	Well code	Concentration code	Competitor Initial Concentration (M)	hr-ER stock (µl)	Buffer Volume (µl)	Tracer (Hot E2) Volume (µL)	Volume from dilution plate (µL)	Final Volume (µl)	Competitor Final Concentration (M)
S	G6	3	OTES	N	OTES	2,00E-08	40	—	40	80	160	1,0E-08
S	G7	1	OTES	N	OTES	2,00E-09	40	—	40	80	160	1,0E-09
S	G8	2	OTES	N	OTES	2,00E-09	40	—	40	80	160	1,0E-09
S	G9	3	OTES	N	OTES	2,00E-09	40	—	40	80	160	1,0E-09
S	G10	1	OTES	N	OTES	2,00E-10	40	—	40	—	160	1,0E-10
S	G11	2	OTES	N	OTES	2,00E-10	40	—	40	—	160	1,0E-10
S	G12	3	OTES	N	OTES	2,00E-10	40	—	40	—	160	1,0E-10
S	H1	1	hot	H	H	—	—	—	40	—	40	—
S	H2	1	hot	H	H	—	—	—	40	—	40	—
S	H3	1	hot	H	H	—	—	—	40	—	40	—
S	H4	1	hot	H	H	—	—	—	40	—	40	—
S	H5	1	hot	H	H	—	—	—	40	—	40	—
S	H6	1	hot	H	H	—	—	—	40	—	40	—
S	H7	1	buffer control	BC	BC	—	40	80	40	—	160	—
S	H8	1	buffer control	BC	BC	—	40	80	40	—	160	—
S	H9	1	buffer control	BC	BC	—	40	80	40	—	160	—
S	H10	1	buffer control	BC	BC	—	40	80	40	—	160	—
S	H11	1	buffer control	BC	BC	—	40	80	40	—	160	—
S	H12	1	buffer control	BC	BC	—	40	80	40	—	160	—

Note that the 'hot' wells are empty during incubation. The 40 µl are added only for scintillation counting.

▼M8

Competitive Binding Assay Well Layout												
Plate	Position	Replicate	Well type	Well Code	Concentration Code	Competitor Initial Concentration (M)	hrER stock (µL)	Buffer Volume (µL)	Tracer (Hot E2) Volume (µL)	Volume from dilution plate (µL)	Final Volume (µL)	Competitor Final Concentration (M)
P1	A1	1	total binding	TB	TBB1B1	—	40	—	40	80	160	—
P1	A2	2	total binding	TB	TB2	—	40	—	40	80	160	—
P1	A3	3	total binding	TB	TB3	—	40	—	40	80	160	—
P1	A4	1	total binding	TB	TB4	—	40	—	40	80	160	—
P1	A5	2	total binding	TB	TB5	—	40	—	40	80	160	—
P1	A6	3	total binding	TB	TB6	—	40	—	40	80	160	—
P1	A7	1	cold E2 (high)	NSB	S0	2,00E-06	40	—	40	80	160	1,0E-06
P1	A8	2	cold E2 (high)	NSB	S0	2,00E-06	40	—	40	80	160	1,0E-06
P1	A9	3	cold E2 (high)	NSB	S0	2,00E-06	40	—	40	80	160	1,0E-06
P1	A10	1	cold E2 (high)	NSB	S0	2,00E-06	40	—	40	80	160	1,0E-06
P1	A11	2	cold E2 (high)	NSB	S0	2,00E-06	40	—	40	80	160	1,0E-06
P1	A12	3	cold E2 (high)	NSB	S0	2,00E-06	40	—	40	80	160	1,0E-06
P1	B1	1	Test Chemical 1	TC1	1	2,00E-03	40	0	40	80	160	1,0E-03
P1	B2	2	Test Chemical 1	TC1	1	2,00E-03	40	0	40	80	160	1,0E-03
P1	B3	3	Test Chemical 1	TC1	1	2,00E-03	40	0	40	80	160	1,0E-03
P1	B4	1	Test Chemical 1	TC1	2	2,00E-04	40	0	40	80	160	1,0E-04
P1	B5	2	Test Chemical 1	TC1	2	2,00E-04	40	0	40	80	160	1,0E-04
P1	B6	3	Test Chemical 1	TC1	2	2,00E-04	40	0	40	80	160	1,0E-04
P1	B7	1	Test Chemical 1	TC1	3	2,00E-05	40	0	40	80	160	1,0E-05
P1	B8	2	Test Chemical 1	TC1	3	2,00E-05	40	0	40	80	160	1,0E-05
P1	B9	3	Test Chemical 1	TC1	3	2,00E-05	40	0	40	80	160	1,0E-05
P1	B10	1	Test Chemical 1	TC1	4	2,00E-06	40	0	40	80	160	1,0E-06
P1	B11	2	Test Chemical 1	TC1	4	2,00E-06	40	0	40	80	160	1,0E-06
P1	B12	3	Test Chemical 1	TC1	4	2,00E-06	40	0	40	80	160	1,0E-06

▼M8

Competitive Binding Assay Well Layout													
Plate	Position	Replicate	Well type	Well Code	Concentration Code	Competitor Initial Concentration (M)	hrER stock (µL)	Buffer Volume (µL)	Tracer (Hot E2) Volume (µL)	Volume from dilution plate (µL)	Final Volume (µL)	Competitor Final Concentration (M)	
P1	C1	1	Test Chemical 1	TC1	5	2,00E-07	40	0	40	80	160	1,0E-07	
P1	C2	2	Test Chemical 1	TC1	5	2,00E-07	40	0	40	80	160	1,0E-07	
P1	C3	3	Test Chemical 1	TC1	5	2,00E-07	40	0	40	80	160	1,0E-07	
P1	C4	1	Test Chemical 1	TC1	6	2,00E-08	40	0	40	80	160	1,0E-08	
P1	C5	2	Test Chemical 1	TC1	6	2,00E-08	40	0	40	80	160	1,0E-08	
P1	C6	3	Test Chemical 1	TC1	6	2,00E-08	40	0	40	80	160	1,0E-08	
P1	C7	1	Test Chemical 1	TC1	7	2,00E-09	40	0	40	80	160	1,0E-09	
P1	C8	2	Test Chemical 1	TC1	7	2,00E-09	40	0	40	80	160	1,0E-09	
P1	C9	3	Test Chemical 1	TC1	7	2,00E-09	40	0	40	80	160	1,0E-09	
P1	C10	1	Test Chemical 1	TC1	8	2,00E-10	40	0	40	80	160	1,0E-10	
P1	C11	2	Test Chemical 1	TC1	8	2,00E-10	40	0	40	80	160	1,0E-10	
P1	C12	3	Test Chemical 1	TC1	8	2,00E-10	40	0	40	80	160	1,0E-10	
P1	D1	1	Test Chemical 2	TC2	1	2,00E-03	40	0	40	80	160	1,0E-03	
P1	D2	2	Test Chemical 2	TC2	1	2,00E-03	40	0	40	80	160	1,0E-03	
P1	D3	3	Test Chemical 2	TC2	1	2,00E-03	40	0	40	80	160	1,0E-03	
P1	D4	1	Test Chemical 2	TC2	2	2,00E-04	40	0	40	80	160	1,0E-04	
P1	D5	2	Test Chemical 2	TC2	2	2,00E-04	40	0	40	80	160	1,0E-04	
P1	D6	3	Test Chemical 2	TC2	2	2,00E-04	40	0	40	80	160	1,0E-04	
P1	D7	1	Test Chemical 2	TC2	3	2,00E-05	40	0	40	80	160	1,0E-05	
P1	D8	2	Test Chemical 2	TC2	3	2,00E-05	40	0	40	80	160	1,0E-05	
P1	D9	3	Test Chemical 2	TC2	3	2,00E-05	40	0	40	80	160	1,0E-05	
P1	D10	1	Test Chemical 2	TC2	4	2,00E-06	40	0	40	80	160	1,0E-06	
P1	D11	2	Test Chemical 2	TC2	4	2,00E-06	40	0	40	80	160	1,0E-06	
P1	D12	3	Test Chemical 2	TC2	4	2,00E-06	40	0	40	80	160	1,0E-06	

▼M8

Competitive Binding Assay Well Layout													
Plate	Position	Replicate	Well type	Well Code	Concentration Code	Competitor Initial Concentration (M)	hrER stock (µL)	Buffer Volume (µL)	Tracer (Hot E2) Volume (µL)	Volume from dilution plate (µL)	Final Volume (µL)	Competitor Final Concentration (M)	
P1	E1	1	Test Chemical 2	TC2	5	2,00E-07	40	0	40	80	160	1,0E-07	
P1	E2	2	Test Chemical 2	TC2	5	2,00E-07	40	0	40	80	160	1,0E-07	
P1	E3	3	Test Chemical 2	TC2	5	2,00E-07	40	0	40	80	160	1,0E-07	
P1	E4	1	Test Chemical 2	TC2	6	—	40	0	40	80	160	1,0E-08	
P1	E5	2	Test Chemical 2	TC2	6	—	40	0	40	80	160	1,0E-08	
P1	E6	3	Test Chemical 2	TC2	6	—	40	0	40	80	160	1,0E-08	
P1	E7	1	Test Chemical 2	TC2	7	2,00E-06	40	0	40	80	160	1,0E-09	
P1	E8	2	Test Chemical 2	TC2	7	2,00E-06	40	0	40	80	160	1,0E-09	
P1	E9	3	Test Chemical 2	TC2	7	2,00E-06	40	0	40	80	160	1,0E-09	
P1	E10	1	Test Chemical 2	TC2	8	2,00E-06	40	0	40	80	160	1,0E-10	
P1	E11	2	Test Chemical 2	TC2	8	2,00E-06	40	0	40	80	160	1,0E-10	
P1	E12	3	Test Chemical 2	TC2	8	2,00E-06	40	0	40	80	160	1,0E-10	
P1	F1	1	Test Chemical 3	TC3	1	2,00E-03	40	0	40	80	160	1,0E-03	
P1	F2	2	Test Chemical 3	TC3	1	2,00E-03	40	0	40	80	160	1,0E-03	
P1	F3	3	Test Chemical 3	TC3	1	2,00E-03	40	0	40	80	160	1,0E-03	
P1	F4	1	Test Chemical 3	TC3	2	2,00E-04	40	0	40	80	160	1,0E-04	
P1	F5	2	Test Chemical 3	TC3	2	2,00E-04	40	0	40	80	160	1,0E-04	
P1	F6	3	Test Chemical 3	TC3	2	2,00E-04	40	0	40	80	160	1,0E-04	
P1	F7	1	Test Chemical 3	TC3	3	2,00E-05	40	0	40	80	160	1,0E-05	
P1	F8	2	Test Chemical 3	TC3	3	2,00E-05	40	0	40	80	160	1,0E-05	
P1	F9	3	Test Chemical 3	TC3	3	2,00E-05	40	0	40	80	160	1,0E-05	
P1	F10	1	Test Chemical 3	TC3	4	2,00E-06	40	0	40	80	160	1,0E-06	
P1	F11	2	Test Chemical 3	TC3	4	2,00E-06	40	0	40	80	160	1,0E-06	
P1	F12	3	Test Chemical 3	TC3	4	2,00E-06	40	0	40	80	160	1,0E-06	

▼M8

Competitive Binding Assay Well Layout													
Plate	Position	Replicate	Well type	Well Code	Concentration Code	Competitor Initial Concentration (M)	hrER stock (µL)	Buffer Volume (µL)	Tracer (Hot E2) Volume (µL)	Volume from dilution plate (µL)	Final Volume (µl)	Competitor Final Concentration (M)	
P1	G1	1	Test Chemical 3	TC3	5	2,00E-07	40	0	40	80	160	1,0E-07	
P1	G2	2	Test Chemical 3	TC3	5	2,00E-07	40	0	40	80	160	1,0E-07	
P1	G3	3	Test Chemical 3	TC3	5	2,00E-07	40	0	40	80	160	1,0E-07	
P1	G4	1	Test Chemical 3	TC3	6	2,00E-08	40	0	40	80	160	1,0E-08	
P1	G5	2	Test Chemical 3	TC3	6	2,00E-08	40	0	40	80	160	1,0E-08	
P1	G6	3	Test Chemical 3	TC3	6	2,00E-08	40	0	40	80	160	1,0E-08	
P1	G7	1	Test Chemical 3	TC3	7	2,00E-09	40	0	40	80	160	1,0E-09	
P1	G8	2	Test Chemical 3	TC3	7	2,00E-09	40	0	40	80	160	1,0E-09	
P1	G9	3	Test Chemical 3	TC3	7	2,00E-09	40	0	40	80	160	1,0E-09	
P1	G10	1	Test Chemical 3	TC3	8	2,00E-10	40	0	40	80	160	1,0E-10	
P1	G11	2	Test Chemical 3	TC3	8	2,00E-10	40	0	40	80	160	1,0E-10	
P1	G12	3	Test Chemical 3	TC3	8	2,00E-10	40	0	40	80	160	1,0E-10	
P1	H1	1	norethynodrel	NE		IC50	40	0	40	80	160		
P1	H2	2	norethynodrel	NE		IC50	40	0	40	80	160		
P1	H3	3	norethynodrel	NE		IC50	40	0	40	80	160		
P1	H4	1	norethynodrel	NE		1,00E-4,5	40	0	40	80	160		
P1	H5	2	norethynodrel	NE		1,00E-4,5	40	0	40	80	160		
P1	H6	3	norethynodrel	NE		1,00E-4,5	40	0	40	80	160		
P1	H7	1	cold E2 S			IC50	40	0	40	80	160		
P1	H8	2	cold E2 S			IC50	40	0	40	80	160		
P1	H9	3	cold E2 S			IC50	40	0	40	80	160		
P1	H10	1	cold E2 S			1,00E-7	40	0	40	80	160		
P1	H11	2	cold E2 S			1,00E-7	40	0	40	80	160		
P1	H12	3	cold E2 S			1,00E-7	40	0	40	80	160		

▼M8*Appendix 3*

THE CHEMICAL EVALUATION AND RESEARCH INSTITUTE (CERI) IN VITRO ESTROGEN RECEPTOR BINDING ASSAY USING A HUMAN RECOMBINANT ERA LIGAND BINDING DOMAIN PROTEIN

INITIAL CONSIDERATIONS AND LIMITATIONS (SEE ALSO GENERAL INTRODUCTION)

1. This *in vitro* Estrogen Receptor (ER α) saturation and competitive binding assay uses a ligand binding domain (LBD) of the human ER α (hrER α). This protein construct was produced by the Chemicals Evaluation Research Institute (CERI), Japan, and exists as a glutathione-S-transferase (GST) fusion protein, and is expressed in *E. coli*. The CERI protocol underwent an international multi-laboratory validation study (2) which has demonstrated its relevance and reliability for the intended purpose of the assay.
2. This assay is a screening procedure for identifying substances that can bind to the hrER α . It is used to determine the ability of a test chemical to compete with 17 β -estradiol for binding to hrER α -LBD. Quantitative assay results may include the IC₅₀ (a measure of the concentration of test chemical needed to displace half of the [³H]-17 β -estradiol from the hrER α) and the relative binding affinities of test chemicals for the hrER α compared to 17 β -estradiol. For chemical screening purposes, acceptable qualitative assay results may include classifications of test chemicals as either hrER α binders, non-binders, or equivocal based upon criteria described for the binding curves.
3. The assay uses a radioactive ligand that requires a radioactive materials license for the laboratory. All procedures with radioisotopes and hazardous chemicals should follow the regulations and procedures as described by national legislation.
4. The ‘GENERAL INTRODUCTION’ and ‘hrER BINDING ASSAY COMPONENTS’ should be read before using this assay for regulatory purposes. Definitions and abbreviations used in this TG are described in Appendix 1.

PRINCIPLES OF THE ASSAY (SEE ALSO GENERAL INTRODUCTION)

5. The hrER α binding assay measures the ability of a radiolabelled ligand ([³H]17 β -estradiol) to bind with the ER in the presence of increasing concentrations of a test chemical (i.e. competitor). Test chemicals that possess a high affinity for the ER compete with the radiolabelled ligand at a lower concentration as compared with those chemicals with lower affinity for the receptor.
6. This assay consists of two major components: a saturation binding experiment to characterise receptor-ligand interaction parameters, followed by a competitive binding experiment that characterises the competition between a test chemical and a radiolabelled ligand for binding to the ER.

▼ **M8**

7. The purpose of the saturation binding experiment is to characterise a particular batch of receptors for binding affinity and number in preparation for the competitive binding experiment. The saturation binding experiment measures, under equilibrium conditions, the affinity of a fixed concentration of the estrogen receptor for its natural ligand (represented by the dissociation constant, K_d), and the concentration of active receptor sites (B_{max}).
8. The competitive binding experiment measures the affinity of a substance to compete with [3H]17 β -estradiol for binding to the ER. The affinity is quantified by the concentration of test chemical that, at equilibrium, inhibits 50 % of the specific binding of the [3H]17 β -estradiol (termed the 'inhibitory concentration 50 %' or IC_{50}). This can also be evaluated using the relative binding affinity (RBA, relative to the IC_{50} of estradiol measured separately in the same run). The competitive binding experiment measures the binding of [3H]17 β -estradiol at a fixed concentration in the presence of a wide range (eight orders of magnitude) of test chemical concentrations. The data are then fit, where possible, to a form of the Hill equation (Hill, 1910) that describes the displacement of the radioligand by a one-site competitive binder. The extent of displacement of the radiolabelled estradiol at equilibrium is used to characterise the test chemical as a binder, non-binder, or generating an equivocal response.

PROCEDURE

Demonstration of Acceptable hrER α Protein Performance

9. Prior to routinely conducting the saturation and competitive binding assays, each new batch of hrER α should be shown to be performing correctly in the laboratory in which it will be used. A two-step process should be used to demonstrate performance. These steps are the following:
 - Conduct a saturation [3H]-17 β -estradiol binding assay to demonstrate hrER α specificity and saturation. Nonlinear regression analysis of these data (e.g. BioSoft; McPherson, 1985; Motulsky, 1995) and the subsequent Scatchard plot should document hrER α binding affinity of the [3H]-17 β -estradiol (K_d) and the number of receptors (B_{max}) for a particular batch of hrER α .
 - Conduct a competitive binding assay using the control substances (reference estrogen (17 β -estradiol), a weak binder (e.g. norethynodrel or norethindrone), and a non-binder (octyltriethoxysilane, OTES). Each laboratory should establish an historical database to document the consistency of IC_{50} and the relevant values for the reference estrogen and weak binder among experiments and different batches of hrER α . In addition, the parameters of the competitive binding curves for the control substances should be within the limits of the 95 % confidence interval (see Table 1) that were developed using data from laboratories that participated in the validation study for this assay (2).

Table 1

Performance criteria developed for the reference estrogen and weak binder, CERI hrER Binding Assay

Substance	Parameter	Mean (°)	Standard Deviation(n)	95 % Confidence Intervals (°)	
				Lower Limit	Upper Limit
17β-estradiol	Top	104,74	13,12 (70)	101,6	107,9
	Bottom	0,85	2,41 (70)	0,28	1,43

▼M8

Substance	Parameter	Mean ^(a)	Standard Deviation(n)	95 % Confidence Intervals ^(b)	
				Lower Limit	Upper Limit
	HillSlope	-1,22	0,20 (70)	-1,27	-1,17
	LogIC ₅₀	-8,93	0,23 (70)	-8,98	-8,87
Norethynodrel	Top	101,31	10,55 (68)	98,76	103,90
	Bottom	2,39	5,01 (68)	1,18	3,60
	HillSlope	-1,04	0,21 (68)	-1,09	-0,99
	LogIC ₅₀	-6,19	0,40 (68)	-6,29	-6,10
Norethindrone ^(c)	Top	92,27	7,79 (23)	88,90	95,63
	Bottom	16,52	10,59 (23)	11,94	21,10
	Hill Slope	-1,18	0,32 (23)	-1,31	-1,04
	LogIC ₅₀	-6,01	0,54 (23)	-6,25	-5,78

^(a) Mean ± Standard Deviation (SD) with (sample size (n) were calculated using curve fit estimates (4-parameter Hill equation) for control runs conducted in four laboratories during the validation study (see Annex N of reference 2).

^(b) The 95 % confidence are provided as a guide for acceptability criteria.

^(c) Testing of norethindrone was optional for Subtask 4 during validation study (see Reference 2, see Subtask 4). Thus, the mean ± SD (n) were calculated using curve fit estimates (4-parameter Hill equation) for control runs conducted in two laboratories. The range for the IC₅₀ will be dependent upon the K_d of the receptor preparation and concentration of radiolabelled ligand used within each laboratory. Appropriate adjustment for the range of the IC₅₀ based upon the conditions used to conduct the assay will be acceptable.

Demonstration of laboratory proficiency

- See paragraphs 17 and 18 and Table 2 in 'hrER BINDING ASSAY COMPONENTS' of this test method. Each assay (saturation and competitive binding) should consist of three independent runs (i.e. with fresh dilutions of receptor, chemicals, and reagents) on different days, and each run should contain three replicates.

Determination of Receptor (hrER α) Concentration

- The concentration of active receptor varies slightly by batch and storage conditions. For this reason, the concentration of active receptor as received from the supplier should be determined. This will yield the appropriate concentration of active receptor at the time of the run.
- Under conditions corresponding to competitive binding (i.e. 0,5 nM [³H]-estradiol), nominal concentrations of 0,1, 0,2, 0,4 and 0,6 nM receptor should be incubated in the absence (total binding) and presence (non-specific binding) of 1 μ M unlabelled estradiol. Specific binding, calculated as the difference of total and non-specific binding, is plotted against the

▼M8

nominal receptor concentration. The concentration of receptor that gives specific binding values corresponding to 40 % of added radiolabel is related to the corresponding receptor concentration, and this receptor concentration should be used for saturation and competitive binding experiments. Frequently, a final hrER concentration of 0,2 nM will comply with this condition.

13. If the 40 % criterion repeatedly cannot be met, the experimental set up should be checked for potential errors. Failure to achieve the 40 % criterion may indicate that there is very little active receptor in the recombinant batch, and the use of another receptor batch should then be considered.

Saturation assay

14. Eight increasing concentrations of [³H]17β-estradiol should be evaluated in triplicate, under the following three conditions (see Table 2):
 - a. In the absence of unlabelled 17β-estradiol and presence of ER. This is the determination of total binding by measure of the radioactivity in the wells that have only [³H]17β-estradiol.
 - b. In the presence of a 2000- fold excess concentration of unlabelled 17β-estradiol over labelled 17β-estradiol and presence of ER. The intent of this condition is to saturate the active binding sites with unlabelled 17β-estradiol, and by measuring the radioactivity in the wells, determine the non-specific binding. Any remaining hot estradiol that can bind to the receptor is considered to be binding at a non-specific site as the cold estradiol should be at such a high concentration that it is bound to all of the available specific sites on the receptor.
 - c. In the absence of unlabelled 17β-estradiol and absence of ER (determination of total radioactivity)

Preparation of [³H]-17β-estradiol, unlabelled 17β-estradiol solutions and hrERα

15. A 40 nM solution of [³H]-17β-estradiol should be prepared from a 1 μM stock solution of [³H]-17β-estradiol in DMSO, by adding DMSO (to prepare 200 nM) and assay buffer at room temperature (to prepare 40 nM). Using this 40 nM solution, the series of [³H]-17β-estradiol dilutions prepared, ranging from 0,313 nM to 40 nM with assay buffer at room temperature (as represented in lane 12 of Table 2). The final assay concentrations, ranging from 0,0313 to 4,0 nM, will be obtained by adding 10 μl of these solutions to the respective assay wells of a 96-well microtiter plate (see Tables 2 and 3). Preparation of assay buffer, calculation of the original [³H]-17β-estradiol stock solution based on its specific activity, preparation of dilutions and determination of the concentrations are described in depth in the CER1 protocol (2).
16. Dilutions of unlabelled 17β-estradiol solutions should be prepared from a 1 nM 17β-estradiol stock solution by adding assay buffer to achieve eight increasing concentrations initially ranging from 0,625 μM to 80 μM. The final assay concentrations, ranging from 0,0625 to 8 μM, will be obtained by adding 10 μl of these solutions to the respective assay wells of a 96-well microtiter plate dedicated to the measurement of non-specific binding (see Tables 2 and 3). Preparation of unlabelled 17β-estradiol dilutions is described in depth in the CER1 protocol (2).

▼M8

17. The concentration of receptor that gives 40±10 % specific binding should be used (see paragraphs 12-13). The hrER α solution should be prepared with ice-cold assay buffer immediately prior to use, i.e. after all wells for total binding, non-specific binding and hot ligand alone have been prepared.
18. The 96-well microtiter plates are prepared as illustrated in Table 2, with 3 replicates per [3 H]-17 β -estradiol concentration. Volume assignment of [3 H]-17 β -estradiol, unlabelled 17 β -estradiol, buffer and receptor are provided in Table 3.

Table 2
Saturation Binding Assay Microtiter Plate Layout

	1 (*)	2 (*)	3 (*)	4 (*)	5 (*)	6 (*)	7 (*)	8 (*)	9 (*)	10	11 (**)	12 (**)
	For measurement of TB			For measurement of NSB			For determination of hot ligand alone				Unlabelled E2 dilutions for plate column 4-6	[3 H]E2 dilutions for plate column 1-9
A	0,0313 nM [3 H] E2+ ER			0,0313 nM [3 H] E2+ 0,0625 μ M E2+ ER			0,0313 nM				0,625 μ M	0,313 nM
B	0,0625 nM [3 H] E2+ ER			0,0625 nM [3 H] E2+ 0,125 μ M E2+ ER			0,0625 nM				1,25 μ M	0,625 nM
C	0,125 nM [3 H] E2+ ER			0,125 nM [3 H] E2+ 0,25 μ M E2+ ER			0,125 nM				2,5 μ M	1,25 nM
D	0,250 nM [3 H] E2+ ER			0,250 nM [3 H] E2+ 0,5 μ M E2+ ER			0,250 nM				5 μ M	2,5 nM
E	0,50 nM [H] E2+ ER			0,50 nM [3 H] E2+ 1 μ M E2+ ER			0,50 nM				10 μ M	5 nM
F	1,00 nM [3 H] E2+ ER			1,00 nM [3 H] E2+ 2 μ M E2+ ER			1,00 nM				20 μ M	10 nM
G	2,00 nM [3 H] E2+ ER			2,00 nM [3 H] E2+ 4 μ M E2+ ER			2,00 nM				40 μ M	20 nM
H	4,00 nM [3 H] E2+ ER			4,00 nM [3 H] E2+ 8 μ M E2+ ER			4,00 nM				80 μ M	40 nM

TB- total binding.

NSB- non-specific binding

[3 H] E2- [3 H]17 β -estradiol

E2- unlabelled 17 β -estradiol

(*) The indicated concentrations here are the final concentrations in each well

(**) The dilutions of unlabelled E2 and [3 H]E2 can be prepared in a different plate.

▼M8

Table 3
Reagent Volumes for Saturation Microtiter Plate

Lane Number		1	2	3	4	5	6	7 (*)	8 (*)	9 (*)
Preparation Steps		TB Wells			NSB Wells			Hot Ligand Alone		
Volume of components for reaction wells above and order to add	Buffer	60 µl			50 µl			90 µl		
	unlabelled E2 from lane 11 in Table2	—			10 µl			—		
	[3H]E2 from lane12 in Table2	10 µl			10 µl			10 µl		
	hrERα	30 µl			30 µl			—		
Total reaction volume		100 µl			100 µl			100 µl		
Incubation		FOLLOWING 2 HOUR INCUBATION REACTION						Quantification of the radioactivity just after the preparation. No incubation		
Treatment with 0,4 % DCC		Yes			Yes			No		
Volume of 0,4 % DCC		100 µl			100 µl			—		
Filtration		Yes			Yes			No		
MEASURING THE DPMS										
Quantification volume added to scintillation cocktail		100 µl (**)			100 µl (**)			50 µl		

(*) If an LSC for microplates is used for measuring dpms, the preparation of hot ligand alone in the same assay plate of TB and NSB wells is not appropriate. The hot ligand alone should be prepared in a different plate.

(**) If centrifugation is used to separate DCC, the 50 µl of supernatant should be measured by LSC in order to avoid contamination of DCC.

19. Assay microtiter plates for the determination of total binding and non-specific binding should be incubated at room temperature (22°C to 28°C) for two hours.

Measurement of [³H]-17β-Estradiol bound to hrERα

20. Following the two hour incubation period, [³H]-17β-Estradiol bound to hrERα should be separated from free [³H]-17β-Estradiol by adding 100µl an ice cold 0,4 % DCC suspension to the wells. The plates should then be placed on ice for 10 minutes and the reaction mixture and DCC suspension should be filtered, by transfer to a microtiter plate filter, to remove DCC. A 100 µl of the filtrate should then be added to scintillation fluid in LSC vials for determination of disintegration per minute (dpms) per vial by liquid scintillation counting.

▼M8

21. Alternatively, if a microplate filter is not available, removal of DCC can be obtained by centrifugation. A 50 µl of supernatant containing the hrERα-bound [³H]-17β-estradiol should then be taken with extreme care, to avoid any contamination of the wells by touching DCC, and should be used for scintillation counting.

22. The hot ligand alone condition is used for determining the disintegration per minute (dpm) of [³H]-17β-estradiol added to the assay wells. The radioactivity should be quantified just after preparation. These wells should not be incubated and should not be treated with DCC suspension but their content should be delivered directly into the scintillation fluid. These measures demonstrate how much [³H]-17β-estradiol in dpms was added to each set of wells for the total binding and non-specific binding.

Competitive binding assay

23. The competitive binding assay measures the binding of a single concentration of [³H]-17β-estradiol in the presence of increasing concentrations of a test chemical. Three concurrent replicates should be used at each concentration within one run. In addition, three non-concurrent runs should be performed for each chemical tested. The assay should be set up in one or more 96-well microtiter plates.

Controls

24. When performing the assay, concurrent solvent and controls (i.e. reference estrogen, weak binder, and non-binder) should be included in each experiment. Full concentration curves for the reference estrogen and controls (i.e. weak binder and non-binder) should be used in one plate during each run. All other plates should contain (i) a high- (maximum displacement i.e. approximately full displacement of radiolabelled ligand) and medium- (approximately, the IC₅₀) concentration of E2 and weak binder in triplicate; (ii) solvent control and non-specific binding, each in triplicate. Procedures for the preparation of assay buffer, [³H]-17β-estradiol, hrERα and test chemical solutions are described in depth in the CERI protocol (2).

Solvent control:

25. The solvent control indicates that the solvent does not interact with the test system and also measures total binding (TB). DMSO is the preferred solvent. Alternatively, if the highest concentration of the test chemical is not soluble in DMSO, ethanol may be used. The concentration of DMSO in the final assay wells should be 2,05 % and could be increased up to 2,5 % in case of lack of solubility of the test chemical. Concentrations of DMSO above 2,5 % should not be used because of interference of higher solvent concentrations with the assay. For test chemicals that are not soluble in DMSO, but are soluble in ethanol, a maximum of 2 % ethanol may be used in the assay without interference.

Buffer control:

26. The buffer control (BC) should contain neither solvent nor test chemical, but all of the other components of the assay. The results of the buffer control are compared to the solvent control to verify that the solvent used does not affect the assay system.

▼ **M8***Strong binder (reference estrogen)*

27. 17 β -estradiol (CAS 50-28-2) is the endogenous ligand and binds with high affinity to the ER, alpha subtype. A standard curve using unlabelled 17 β -estradiol should be prepared for each hrER α competitive binding assay, to allow for an assessment of variability when conducting the assay over time within the same laboratory. Eight solutions of unlabelled 17 β -estradiol should be prepared in DMSO and assay buffer, with final concentrations in the assay wells to be used for the standard curve spaced as follows: 10⁻⁶, 10⁻⁷, 10⁻⁸, 10^{-8.5}, 10⁻⁹, 10^{-9.5}, 10⁻¹⁰, 10⁻¹¹ M. The highest concentration of unlabelled 17 β -estradiol (1 μ M) should serve as the non-specific binding indicator. This concentration is distinguished by the label 'NSB' in Table 4 even though it is also part of the standard curve.

Weak binder

28. A weak binder (norethynodrel (CAS68-23-5), or alternate, norethindrone (CAS 68-22-4)) should be included to demonstrate the sensitivity of each experiment and to allow an assessment of variability when conducting the assay over time. Eight solutions of the weak binder should be prepared in DMSO and assay buffer, with final concentrations in the assay wells as follows: 10^{-4.5}, 10^{-5.5}, 10⁻⁶, 10^{-6.5}, 10⁻⁷, 10^{-7.5}, 10⁻⁸ and 10⁻⁹ M.

Non binder

29. Octytriethoxysilane (OTES, CAS 2943-75-1) should be used as the negative control (non-binder). It provides assurance that the assay as run, will detect test chemicals that do not bind to the hrER α . Eight solutions of the non-binder should be prepared in DMSO and assay buffer, with final concentrations in the assay wells as follows: 10⁻³, 10⁻⁴, 10⁻⁵, 10⁻⁶, 10⁻⁷, 10⁻⁸, 10⁻⁹, 10⁻¹⁰ M. Di-n-butyl phthalate (DBP, CAS 84-72-2) can be used as an alternative non-binder, but only tested up to 10⁻⁴M. The maximum solubility of DBP in the assay has been demonstrated to be 10⁻⁴M.

hrER α concentration

30. The amount of receptor that gives specific binding of 40 \pm 10 % should be used (see paragraphs 12-13 of Appendix 3). The hrER α solution should be prepared by dilution of the functional hrER α into ice cold assay buffer, immediately prior to use.

[³H]-17 β -estradiol

31. The final concentration of [³H]-17 β -estradiol in the assay wells should be of 0,5 nM.

Test Chemicals

32. In the first instance, it is necessary to conduct a solubility test to determine the limit of solubility for each test chemical and to identify the appropriate concentration range to use when conducting the test protocol. The limit of solubility of each test chemical is to be initially determined in the solvent and then further confirmed under assay conditions. The final concentration tested in the assay should not exceed 1mM. Range finder testing includes a solvent control along with at least 8 log serial dilutions, starting at maximum acceptable concentration (e.g. 1 mM or lower, based upon the limit of solubility), and the presence of cloudiness or precipitate noted (see also paragraph 35 of Appendix 3). Once the concentration range for testing has been determine, a test chemical should be tested using 8 log concentrations

▼M8

- spaced appropriately as defined in the preceding range finding test. Concentrations tested in the second and third experiments should be further adjusted as appropriate to better characterise the concentration response curve, if necessary.
33. Dilutions of the test chemical should be prepared in the appropriate solvent (see paragraph 25 of Appendix 3). If the highest concentration of the test chemical is not soluble in either DMSO or ethanol, and adding more solvent would cause the solvent concentration in the final tube to be greater than the acceptable limit, the highest concentration may be reduced to the next lower concentration. In this case, an additional concentration may be added at the low end of the concentration series. Other concentrations in the series should remain unchanged.
34. The test chemical solutions should be closely monitored when added to the assay well, as the test chemical may precipitate upon addition to the assay well. The data for all wells that contain precipitate should be excluded from curve-fitting, and the reason for exclusion of the data noted.
35. If there is prior existing information from other sources that provide a $\log(\text{IC}_{50})$ of a test chemical, it may be appropriate to geometrically space the dilutions more closely around the expected $\log(\text{IC}_{50})$ (i.e. 0,5 log units). The final results should show enough sufficient spread of concentrations on either side of the $\log(\text{IC}_{50})$, including the 'top' and 'bottom', such that the binding curve can be adequately characterised.

Assay plate organisation

36. Labelled microtiter plates should be prepared using sextuple incubations for the solvent control, the highest concentration the reference estrogen (E2) which also serves as the non-specific binding (NSB) indicator, the buffer control, and triplicate incubations for each of the eight concentrations of the non-binding control (octyltriethoxysilane), the seven lower concentrations for the reference estrogen (E2), the eight concentrations of the weak binder (norethynodrel or norethindrone), and the eight concentrations of each test chemical (TC). An example layout of the plate layout diagram for the full concentration curves for the reference estrogen and controls is give below in Table 4. Additional microtiter plates are used for the test chemical and should contain plate controls (i.e. (i) a high- (maximum displacement) and medium- (approximately, the IC_{50}) concentration of E2 and weak binder in triplicate; (ii) solvent control (as total binding) and non-specific binding, each in sextuple (Table 5). An example of a competitive assay microtiter plate layout worksheet using three unknown test chemicals is provided in Appendix 3.3. The concentrations indicated in the worksheet as well as in Tables 4 and 5 refer to the final concentrations used in each assay well. The maximum concentration for E2 should be 1×10^{-7} M and for the weak binder, the highest concentration used for the weak binder on plate 1 should be used. The IC_{50} concentration has to be determined by the laboratory based on their historical control database. The expectation is that this value would be similar to that observed in the validation studies (see table 1).

▼M8

Table 4

Competitive Binding Assay Microtiter Plate Layout ⁽¹⁾, ⁽²⁾, Full Concentration Curves for Reference Estrogen and Controls (Plate 1)

	1	2	3	4	5	6	7	8	9	10	11	12
	Buffer Control and Positive Control (E2)			Weak Positive (Norethynodrel)			Negative Control (OTES)			TB and NSB		
A	Blank (*)			1×10 ⁻⁹ M			1×10 ⁻¹⁰ M			TB (solvent control) (2,05 % DMSO)		
B	E2 (1×10 ⁻¹¹ M)			1×10 ⁻⁸ M			1×10 ⁻⁹ M					
C	E2 (1×10 ⁻¹⁰ M)			1×10 ^{-7.5} M			1×10 ⁻⁸ M			NSB (10 ⁻⁶ M E2)		
D	E2 (1×10 ^{-9.5} M)			1×10 ⁻⁷ M			1×10 ⁻⁷ M					
E	E2 (1×10 ⁻⁹ M)			1×10 ^{-6.5} M			1×10 ⁻⁶ M			Buffer control		
F	E2 (1×10 ^{-8.5} M)			1×10 ⁻⁶ M			1×10 ⁻⁵ M					
G	E2 (1×10 ⁻⁸ M)			1×10 ^{-5.5} M			1×10 ⁻⁴ M			Blank (for hot) (**)		
H	E2 (1×10 ⁻⁷ M)			1×10 ^{-4.5} M			1×10 ⁻³ M					

⁽¹⁾ Sample set up for the standards microtiter plate to be run with each experiment.

⁽²⁾ Note that this microtiter plate is made using the dilutions made in the dilution plate described for the standards in the previous sections.

In this example, the weak binder is norethinodrel (NE)

(*) real blank, well not used

(**) blank, not used during the incubation, but used to confirm the total radioactivity added.

Table 5

Competitive Binding Assay Microtiter Plate Layout, Additional Plates for Test Chemicals (TC) and Plate Controls

	1	2	3	4	5	6	7	8	9	10	11	12
	Test Chemical-1 (TC-1)			Test Chemical-2 (TC-2)			Test Chemical-3 (TC-3)			Controls		
A	TC-1 (1×10 ⁻¹⁰ M)			TC-2 (1×10 ⁻¹⁰ M)			TC-3 (1×10 ⁻¹⁰ M)			E2 (1×10 ⁻⁷ M)		
B	TC-1 (1×10 ⁻⁹ M)			TC-2 (1×10 ⁻⁹ M)			TC-3 (1×10 ⁻⁹ M)			E2 (IC ₅₀)		
C	TC-1 (1×10 ⁻⁸ M)			TC-2 (1×10 ⁻⁸ M)			TC-3 (1×10 ⁻⁸ M)			NE (1×10 ^{-4.5} M)		
D	TC-1 (1×10 ⁻⁷ M)			TC-2 (1×10 ⁻⁷ M)			TC-3 (1×10 ⁻⁷ M)			NE (IC ₅₀)		
E	TC-1 (1×10 ⁻⁶ M)			TC-2 (1×10 ⁻⁶ M)			TC-3 (1×10 ⁻⁶ M)			NSB (10 ⁻⁶ M E2)		
F	TC-1 (1×10 ⁻⁵ M)			TC-2 (1×10 ⁻⁵ M)			TC-3 (1×10 ⁻⁵ M)					
G	TC-1 (1×10 ⁻⁴ M)			TC-2 (1×10 ⁻⁴ M)			TC-3 (1×10 ⁻⁴ M)			TB (Solvent control)		
H	TC-1 (1×10 ⁻³ M)			TC-2 (1×10 ⁻³ M)			TC-3 (1×10 ⁻³ M)					

In this example, the weak binder is norethinodrel (NE)

▼ **M8***Completion of competitive binding assay*

37. Excepting wells for total binding and blanks (for hot), as shown in Table 6, 50 µl of the assay buffer should be placed in each well, and should be mixed with 10 µl of the solvent control, reference estrogen (E2), weak binder, non-binder, and test chemicals, respectively, 10 µl of a 5 nM [3H]-17β-estradiol solution. Then, 30µl of ice cold receptor solution was added to each plate and mixed gently. The hrERα solution should be the last reagent to be added. Assay microtiter plates should be incubated at room temperature (22° to 28°C) for 2 hours.

Table 6

Volume of Assay Components for hrER Competitive Binding Assay, Microtiter Plates

Preparation Steps		Other than TB wells	TB wells	Blank (for hot)
Volume of components for reaction wells above and order to add	Room Temperature assay Buffer	50 µl	60 µl	90 µl
	Unlabelled E2, weak binder, non-binder, solvent and test chemicals (*)	10 µl	—	—
	[3H]-17β-estradiol to yield final concentration of 0,5 nM (i.e. 5 nM)	10 µl	10 µl	10 µl
	hrERα concentration as determined (see paragraphs 12-13)	30 µl	30 µl	—
Total volume in each assay well		100 µl	100 µl	100 µl

(*) properly prepared to obtain final concentration within the acceptable solvent concentration

38. The quantification of [3H]-17β-Estradiol bound to hrERα, following separation of [3H]-17β-Estradiol bound to hrERα from free [3H]-17β-Estradiol by adding 100 µl of ice-cold DCC suspension to each well, should then be performed as described in paragraphs 21-23 of Appendix 3 for the saturation binding assay.
39. Wells G10-12 and H10-12 (identified as blank (for hot) in Table 4) represent the dpms of the [3H]-labelled-estradiol in 10 µl. The 10 µl aliquot should be delivered directly into the scintillation fluid.

Acceptability criteria*Saturation binding assay*

40. The specific binding curve should reach a plateau as increasing concentrations of [3H]-17β-estradiol were used, indicating saturation of hrERα with ligand.
41. The specific binding at 0,5 nM of [3H]-17β-estradiol should be inside the acceptable range 30 % to 50 % of the average measured total radioactivity added across runs. Occasional slight excursions outside of this range are acceptable, but if runs are consistently outside this range or a particular run is significantly outside this range, the protein concentration should be adjusted and the saturation assay repeated.

▼ M8

42. The data should produce a linear Scatchard plot.
43. The non-specific binding should not be excessive. The value for non-specific binding should typically be <35 % of the total binding. However, the ratio might occasionally exceed this limit when measuring very low dpm for the lowest concentration of radiolabelled 17 β -estradiol tested.

Competitive binding assay

44. Increasing concentrations of unlabelled 17 β -estradiol should displace [³H]-17 β -estradiol from the receptor in a manner consistent with a one-site competitive binding.
45. The IC₅₀ value for the reference estrogen (i.e. 17 β -estradiol) should be approximately equal to the molar concentration of [³H]-17 β -estradiol plus the K_d determined from the saturation binding assay.
46. The total specific binding should be consistently within the acceptable range of 40 \pm 10 % when the average measured concentration of total radioactivity added to each well was 0,5 nM across runs. Occasional slight excursions outside of this range are acceptable, but if runs are consistently outside this range or a particular run is significantly outside this range, the protein concentration should be adjusted.
47. The solvent should not alter the sensitivity or reproducibility of the assay. The results of the solvent control (TB wells) are compared to the buffer control to verify that the solvent used does not affect the assay system. The results of the TB and Buffer control should be comparable if there is no effect of the solvent on the assay.
48. The non-binder should not displace more than 25 % of the [³H]-17 β -estradiol from the hrER α when tested up to 10⁻³ M (OTES) or 10⁻⁴ M (DBP).
49. Performance criteria were developed for the reference estrogen and two weak binders (e.g. norethynodrel, norethindrone) using data from the validation study for the CERI hrER Binding Assay (Annex N of reference 2). 95 % confidence intervals are provided for the mean \pm SD (n) of all control runs across four laboratories that participated in the validation study. 95 % confidence intervals were calculated for the curve fit parameters (i.e. top, bottom, Hillslope and Log IC₅₀) for the reference estrogen and weak binders, and the Log₁₀RBA of the weak binders relative to the reference estrogen. Table 1 provides expected ranges for the curve fit parameters that can be used as performance criteria. In practice, the range of the IC₅₀ may vary slightly based upon the experimentally derived K_d of the receptor preparation and ligand concentration used for the assay.
50. No performance criteria were developed for curve fit parameters for the test chemicals because of the wide array of existing potential test chemicals and variation in potential affinities and outcomes (e.g. Full curve, partial curve, no curve fit). However, professional judgment should be applied when reviewing results from each run for a test chemical. A sufficient range of

▼M8

concentrations of the test chemical should be used to clearly define the top (e.g. 90 - 100 % of binding) of the competitive curve. Variability among replicates at each concentration of test chemical as well as among the 3 non-concurrent runs should be reasonable and scientifically defensible. Controls from each run for a test chemical should approach the measures of performance reported for this CERi assay and be consistent historical control data from each respective laboratory.

ANALYSIS OF DATA**Saturation binding assay**

51. Both total and non-specific binding are measured. From these values, specific binding of increasing concentrations of [³H]-17 β -estradiol under equilibrium conditions is calculated by subtracting non-specific from total. A graph of specific binding versus [³H]-17 β -estradiol concentration should reach a plateau for maximum specific binding indicative of saturation of the hrER α with the [³H]-17 β -estradiol. In addition, analysis of the data should document the binding of the [³H]-17 β -estradiol to a single, high-affinity binding site. Non-specific, total, and specific binding should be displayed on a saturation binding curve. Further analysis of these data should use a non-linear regression analysis (e.g. BioSoft; McPherson, 1985; Motulsky, 1995) with a final display of the data as a Scatchard plot.

52. The data analysis should determine Bmax and Kd from the total binding data alone, using the assumption that non-specific binding is linear, unless justification is given for using a different method. In addition, robust regression should be used when determining the best fit unless justification is given. The method chosen for robust regression should be stated. Correction for ligand depletion (e.g. using the method of Swillens 1995) should always be used when determining Bmax and Kd from saturation binding data.

Competitive binding assay

53. The competitive binding curve is plotted as specific [³H]-17 β -estradiol binding versus the concentration (log₁₀ units) of the competitor. The concentration of the test chemical that inhibits 50 % of the maximum specific [³H]-17 β -estradiol binding is the IC₅₀ value.

54. Estimates of log(IC₅₀) values for the positive controls (e.g. reference estrogen and weak binder) should be determined using an appropriate nonlinear curve fitting software to fit a four parameter Hill equation (e.g. BioSoft; McPherson, 1985; Motulsky, 1995). The top, bottom, slope, and log(IC₅₀) should generally be left unconstrained when fitting these curves. Robust regression should be used when determining the best fit unless justification is given. Correction for ligand depletion should not be used. Following the initial analysis, each binding curve should be reviewed to ensure appropriate fit to the model. The relative binding affinity (RBA) for the weak binder should be calculated as a percent of the log (IC₅₀) for the weak binder relative to the log (IC₅₀) for 17 β -estradiol. Results from the positive controls and the non-binder control should be evaluated using the measures of the assay performance in paragraphs 44-49 of this Appendix 3.

▼ **M8**

55. Data for all test chemicals should be analysed using a step-wise approach to ensure that data are appropriately analysed and that each competitive binding curve is properly classified. It is recommended that each run for a test chemical initially undergo a standardised data analysis that is identical to that used for the reference estrogen and weak binder controls (see paragraph 54 of this Appendix 3). Once completed, a technical review of the curve fit parameters as well as a visual review of how well the data fit the generated competitive binding curve for each run should be conducted. During this technical review, the observations of a concentration dependent decrease in the percent [³H]-17β-estradiol specifically bound, low variability among the technical replicates at each test chemical concentration, and consistency in fit parameters among the three runs are a good indication that the assay and data analyses were conducted appropriately.

Data interpretation

56. Providing that all acceptability criteria are fulfilled, a test chemical is considered to be a binder for the hrERα if a binding curve can be fit and the lowest point on the response curve within the range of the data is less than 50 % (Figure 1).

57. Providing that all acceptability criteria are fulfilled, a test chemical is considered to be a non-binder for the hrERα if:

- A binding curve can be fit and the lowest point on the fitted response curve within the range of the data is above 75 %, or
- A binding curve cannot be fit and the lowest unsmoothed average percent binding among the concentration groups in the data is above 75 %.

58. Test chemicals are considered equivocal if none of the above conditions are met (e.g. the lowest point on the fitted response curve is between 76 – 51 %).

Table 7

Criteria for assigning classification based upon competitive binding curve for a test chemical

Classification	Criteria
Binder ^a	A binding curve can be fit. The lowest point on the response curve within the range of the data is less than 50 % .
Non-binder ^b	If a binding curve can be fit, the lowest point on the fitted response curve within the range of the data is above 75 % . If a binding curve cannot be fit, the lowest unsmoothed average percent binding among the concentration groups in the data is above 75 % .
Equivocal ^c	Any testable run that is neither a binder nor a non-binder (e.g. The lowest point on the fitted response curve is between 76 – 51 %).

▼ **M8**

Figure 1

Examples of test chemical classification using competitive binding curve.

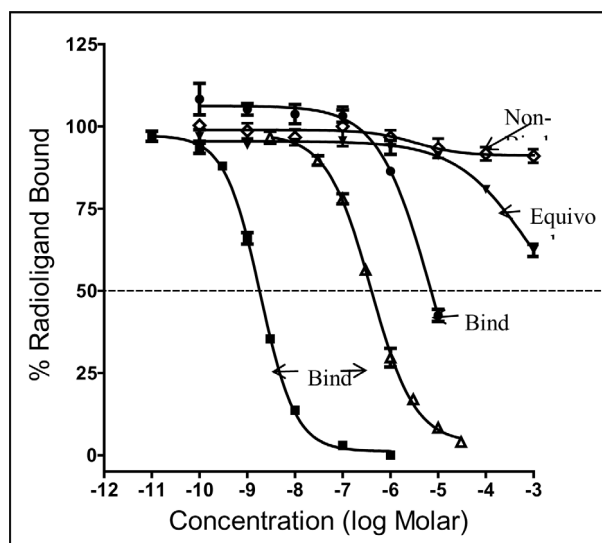

59. Multiple runs conducted within a laboratory for a test chemical are combined by assigning numeric values to each run and averaging across the runs as shown in Table 8. Results for the combined runs within each laboratory are compared with the expected classification for each test chemical.

Table 8

Method for classification of test chemical using multiple runs within a laboratory

To assign value to each run:	
Classification	Numeric Value
Binder	2
Equivocal	1
Non-binder	0
To classify average of numeric value across runs:	
Classification	Numeric Value
Binder	Average $\geq 1,5$
Equivocal	$0,5 \leq \text{Average} < 1,5$
Non-binder	Average $< 0,5$

TEST REPORT

60. See paragraph 24 of 'hrER BINDING ASSAY COMPONENTS' of this test method.

▼ M8*Appendix 3.1*

LIST OF TERMS

[³H]E2: 17β-Estradiol radiolabelled with tritium

DCC: Dextran-coated charcoal

E2: Unlabelled 17β-estradiol (inert)

Assay buffer: 10 mM Tris-HCl, pH 7.4, containing 1 mM EDTA, 1mM EGTA, 1 mM NaVO₃, 10 % Glycerol, 0,2 mM Leupeptin, 1 mM Dithiothreitol and 10 mg/ml Bovine Serum Albumin

hrERα: Human recombinant estrogen receptor alpha (ligand binding domain)

Replicate: One of multiple wells that contain the same contents at the same concentrations and are assayed concurrently within a single run. In this protocol, each concentration of test chemical is tested in triplicate; that is, there are three replicates that are assayed simultaneously at each concentration of test chemical.

Run: A complete set of concurrently-run microtiter plate assay wells that provides all the information necessary to characterise binding of a test chemical to the hrERα (viz., total [³H]-17β-estradiol added to the assay well, maximum binding of [³H]-17β-estradiol to the hrERα, nonspecific binding, and total binding at various concentrations of test chemical). A run could consist of as few as one assay well (i.e. replicate) per concentration, but since this protocol requires assaying in triplicate, one run consists of three assay wells per concentration. In addition, this protocol requires three independent (i.e. non-concurrent) runs per chemical.

▼ **M8**

Appendix 3.2

COMPETITIVE BINDING ASSAY WELL LAYOUT

Plate	Position	Replicate	Well type	Well Code	Concentration Code	Competitor Initial Concentration (M)	hrER stock (µl)	Buffer Volume (µl)	Tracer (Hot E2) Volume (µL)	Volume from dilution plate (µL)	Final Volume (µl)	Competitor Final Concentration (M)
S	A1	1	Blank	BK	BK1	—	—	—	—	—	—	—
S	A2	2	Blank	BK	BK2	—	—	—	—	—	—	—
S	A3	3	Blank	BK	BK3	—	—	—	—	—	—	—
S	B1	1	cold E2	S	S1	1,00E-10	30	50	10	10	100	1,0E-11
S	B2	2	cold E2	S	S1	1,00E-10	30	50	10	10	100	1,0E-11
S	B3	3	cold E2	S	S1	1,00E-10	30	50	10	10	100	1,0E-11
S	C1	1	cold E2	S	S2	1,00E-09	30	50	10	10	100	1,0E-10
S	C2	2	cold E2	S	S2	1,00E-09	30	50	10	10	100	1,0E-10
S	C3	3	cold E2	S	S2	1,00E-09	30	50	10	10	100	1,0E-10
S	D1	1	cold E2	S	S3	3,16E-09	30	50	10	10	100	3,2E-10
S	D2	2	cold E2	S	S3	3,16E-09	30	50	10	10	100	3,2E-10
S	D3	3	cold E2	S	S3	3,16E-09	30	50	10	10	100	3,2E-10
S	E1	1	cold E2	S	S4	1,00E-08	30	50	10	10	100	1,0E-09
S	E2	2	cold E2	S	S4	1,00E-08	30	50	10	10	100	1,0E-09
S	E3	3	cold E2	S	S4	1,00E-08	30	50	10	10	100	1,0E-09
S	F1	1	cold E2	S	S5	3,16E-08	30	50	10	10	100	3,2E-09
S	F2	2	cold E2	S	S5	3,16E-08	30	50	10	10	100	3,2E-09
S	F3	3	cold E2	S	S5	3,16E-08	30	50	10	10	100	3,2E-09
S	G1	1	cold E2	S	S6	1,00E-07	30	50	10	10	100	1,0E-08

▼ M8

Plate	Position	Replicate	Well type	Well Code	Concentration Code	Competitor Initial Concentration (M)	hrER stock (µl)	Buffer Volume (µl)	Tracer (Hot E2) Volume (µL)	Volume from dilution plate (µL)	Final Volume (µl)	Competitor Final Concentration (M)
S	G2	2	cold E2	S	S6	1,00E-07	30	50	10	10	100	1,0E-08
S	G3	3	cold E2	S	S6	1,00E-07	30	50	10	10	100	1,0E-08
S	H1	1	cold E2	S	S7	1,00E-06	30	50	10	10	100	1,0E-07
S	H2	2	cold E2	S	S7	1,00E-06	30	50	10	10	100	1,0E-07
S	H3	3	cold E2	S	S7	1,00E-06	30	50	10	10	100	1,0E-07
S	A4	1	norethynodrel	NE	WP1	1,00E-08	30	50	10	10	100	1,0E-09
S	A5	2	norethynodrel	NE	WP1	1,00E-08	30	50	10	10	100	1,0E-09
S	A6	3	norethynodrel	NE	WP1	1,00E-08	30	50	10	10	100	1,0E-09
S	B4	1	norethynodrel	NE	WP2	1,00E-07	30	50	10	10	100	1,0E-08
S	B5	2	norethynodrel	NE	WP2	1,00E-07	30	50	10	10	100	1,0E-08
S	B6	3	norethynodrel	NE	WP2	1,00E-07	30	50	10	10	100	1,0E-08
S	C4	1	norethynodrel	NE	WP3	3,16E-07	30	50	10	10	100	3,2E-08
S	C5	2	norethynodrel	NE	WP3	3,16E-07	30	50	10	10	100	3,2E-08
S	C6	3	norethynodrel	NE	WP3	3,16E-07	30	50	10	10	100	3,2E-08
S	D4	1	norethynodrel	NE	WP4	1,00E-06	30	50	10	10	100	1,0E-07
S	D5	2	norethynodrel	NE	WP4	1,00E-06	30	50	10	10	100	1,0E-07
S	D6	3	norethynodrel	NE	WP4	1,00E-06	30	50	10	10	100	1,0E-07
S	E4	1	norethynodrel	NE	WP5	3,16E-06	30	50	10	10	100	3,2E-07
S	E5	2	norethynodrel	NE	WP5	3,16E-06	30	50	10	10	100	3,2E-07
S	E6	3	norethynodrel	NE	WP5	3,16E-06	30	50	10	10	100	3,2E-07

▼ M8

Plate	Position	Replicate	Well type	Well Code	Concentration Code	Competitor Initial Concentration (M)	hrER stock (µl)	Buffer Volume (µl)	Tracer (Hot E2) Volume (µL)	Volume from dilution plate (µL)	Final Volume (µl)	Competitor Final Concentration (M)
S	F4	1	norethynodrel	NE	WP6	1,00E-05	30	50	10	10	100	1,0E-06
S	F5	2	norethynodrel	NE	WP6	1,00E-05	30	50	10	10	100	1,0E-06
S	F6	3	norethynodrel	NE	WP6	1,00E-05	30	50	10	10	100	1,0E-06
S	G4	1	norethynodrel	NE	WP7	3,16E-05	30	50	10	10	100	3,2E-06
S	G5	2	norethynodrel	NE	WP7	3,16E-05	30	50	10	10	100	3,2E-06
S	G6	3	norethynodrel	NE	WP7	3,16E-05	30	50	10	10	100	3,2E-06
S	H4	1	norethynodrel	NE	WP8	3,16E-04	30	50	10	10	100	3,2E-05
S	H5	2	norethynodrel	NE	WP8	3,16E-04	30	50	10	10	100	3,2E-05
S	H6	3	norethynodrel	NE	WP8	3,16E-04	30	50	10	10	100	3,2E-05
S	A7	1	OTES	N	OTES1	1,00E-09	30	50	10	10	100	1,0E-10
S	A8	2	OTES	N	OTES1	1,00E-09	30	50	10	10	100	1,0E-10
S	A9	3	OTES	N	OTES1	1,00E-09	30	50	10	10	100	1,0E-10
S	B7	1	OTES	N	OTES2	1,00E-08	30	50	10	10	100	1,0E-09
S	B8	2	OTES	N	OTES2	1,00E-08	30	50	10	10	100	1,0E-09
S	B9	3	OTES	N	OTES2	1,00E-08	30	50	10	10	100	1,0E-09
S	C7	1	OTES	N	OTES3	1,00E-07	30	50	10	10	100	1,0E-08
S	C8	2	OTES	N	OTES3	1,00E-07	30	50	10	10	100	1,0E-08
S	C9	3	OTES	N	OTES3	1,00E-07	30	50	10	10	100	1,0E-08
S	D7	1	OTES	N	OTES4	1,00E-06	30	50	10	10	100	1,0E-07
S	D8	2	OTES	N	OTES4	1,00E-06	30	50	10	10	100	1,0E-07
S	D9	3	OTES	N	OTES4	1,00E-06	30	50	10	10	100	1,0E-07
S	E7	1	OTES	N	OTES5	1,00E-05	30	50	10	10	100	1,0E-06
S	E8	2	OTES	N	OTES5	1,00E-05	30	50	10	10	100	1,0E-06
S	E9	3	OTES	N	OTES5	1,00E-05	30	50	10	10	100	1,0E-06

▼ M8

Plate	Position	Replicate	Well type	Well Code	Concentration Code	Competitor Initial Concentration (M)	hrER stock (µl)	Buffer Volume (µl)	Tracer (Hot E2) Volume (µL)	Volume from dilution plate (µL)	Final Volume (µl)	Competitor Final Concentration (M)
S	F7	1	OTES	N	OTES6	1,00E-04	30	50	10	10	100	1,0E-05
S	F8	2	OTES	N	OTES6	1,00E-04	30	50	10	10	100	1,0E-05
S	F9	3	OTES	N	OTES6	1,00E-04	30	50	10	10	100	1,0E-05
S	G7	1	OTES	N	OTES7	1,00E-03	30	50	10	10	100	1,0E-04
S	G8	2	OTES	N	OTES7	1,00E-03	30	50	10	10	100	1,0E-04
S	G9	3	OTES	N	OTES7	1,00E-03	30	50	10	10	100	1,0E-04
S	H7	1	OTES	N	OTES8DB-P7	1,00E-02	30	50	10	10	100	1,0E-03
S	H8	2	OTES	N	OTES88	1,00E-02	30	50	10	10	100	1,0E-03
S	H9	3	OTES	N	OTES8	1,00E-02	30	50	10	10	100	1,0E-03
S	A10	1	total binding	TB	TB1	—	30	60	10	—	100	—
S	A11	2	total binding	TB	TB2	—	30	60	10	—	100	—
S	A12	3	total binding	TB	TB3	—	30	60	10	—	100	—
S	B10	4	total binding	TB	TB4	—	30	60	10	—	100	-
S	B11	5	total binding	TB	TB5	—	30	60	10	—	100	—
S	B12	6	total binding	TB	TB6	—	30	60	10	—	100	—
S	C10	1	cold E2 (high)	NSB	S1	1,00E-05	30	50	10	10	100	1,0E-06
S	C11	2	cold E2 (high)	NSB	S2	1,00E-05	30	50	10	10	100	1,0E-06
S	C12	3	cold E2 (high)	NSB	S3	1,00E-05	30	50	10	10	100	1,0E-06
S	D10	4	cold E2 (high)	NSB	S4	1,00E-05	30	50	10	10	100	1,0E-06
S	D11	5	cold E2 (high)	NSB	S5	1,00E-05	30	50	10	10	100	1,0E-06

▼ **M8**

Plate	Position	Replicate	Well type	Well Code	Concentration Code	Competitor Initial Concentration (M)	hrER stock (µl)	Buffer Volume (µl)	Tracer (Hot E2) Volume (µL)	Volume from dilution plate (µL)	Final Volume (µl)	Competitor Final Concentration (M)
S	D12	6	cold E2 (high)	NSB	S6	1,00E-05	30	50	10	10	100	1,0E-06
S	E10	1	Buffer control	BC	BC1	—	—	100	—	—	100	—
S	E11	2	Buffer control	BC	BC2	—	—	100	—	—	100	—
S	E12	3	Buffer control	BC	BC3	—	—	100	—	—	100	—
S	F10	4	Buffer control	BC	BC4	—	—	100	—	—	100	—
S	F11	5	Buffer control	BC	BC5	—	—	100	—	—	100	—
S	F12	6	Buffer control	BC	BC6	—	—	100	—	—	100	—
S	G10 (*)	1	Blank (for hot)	Hot	H1	—	90	—	10	—	100	—
S	G11 (*)	2	Blank (for hot)	Hot	H2	—	90	—	10	—	100	—
S	G12 (*)	3	Blank (for hot)	Hot	H3	—	90	—	10	—	100	—
S	H10 (*)	4	Blank (for hot)	Hot	H4	—	90	—	10	—	100	—

▼M8

Plate	Position	Replicate	Well type	Well Code	Concentration Code	Competitor Initial Concentration (M)	hrER stock (µl)	Buffer Volume (µl)	Tracer (Hot E2) Volume (µL)	Volume from dilution plate (µL)	Final Volume (µl)	Competitor Final Concentration (M)
S	H11 (*)	5	Blank (for hot)	Hot	H5	—	90	—	10	—	100	—
S	H12	6	Blank (for hot)	Hot	H6	—	90	—	10	—	100	—
P1	A1	1	Unknown 1	U1	1	1,00E-09	30	50	10	10	100	1,0E-10
P1	A2	2	Unknown 1	U1	1	1,00E-09	30	50	10	10	100	1,0E-10
P1	A3	3	Unknown 1	U1	1	1,00E-09	30	50	10	10	100	1,0E-10
P1	B1	1	Unknown 1	U1	2	1,00E-08	30	50	10	10	100	1,0E-09
P1	B2	2	Unknown 1	U1	2	1,00E-08	30	50	10	10	100	1,0E-09
P1	B3	3	Unknown 1	U1	2	1,00E-08	30	50	10	10	100	1,0E-09
P1	C1	1	Unknown 1	U1	3	1,00E-07	30	50	10	10	100	1,0E-08
P1	C2	2	Unknown 1	U1	3	1,00E-07	30	50	10	10	100	1,0E-08
P1	C3	3	Unknown 1	U1	3	1,00E-07	30	50	10	10	100	1,0E-08
P1	D1	1	Unknown 1	U1	4	1,00E-06	30	50	10	10	100	1,0E-07
P1	D2	2	Unknown 1	U1	4	1,00E-06	30	50	10	10	100	1,0E-07
P1	D3	3	Unknown 1	U1	4	1,00E-06	30	50	10	10	100	1,0E-07
P1	E1	1	Unknown 1	U1	5	1,00E-05	30	50	10	10	100	1,0E-06
P1	E2	2	Unknown 1	U1	5	1,00E-05	30	50	10	10	100	1,0E-06
P1	E3	3	Unknown 1	U1	5	1,00E-05	30	50	10	10	100	1,0E-06
P1	F1	1	Unknown 1	U1	6	1,00E-04	30	50	10	10	100	1,0E-05
P1	F2	2	Unknown 1	U1	6	1,00E-04	30	50	10	10	100	1,0E-05
P1	F3	3	Unknown 1	U1	6	1,00E-04	30	50	10	10	100	1,0E-05
P1	G1	1	Unknown 1	U1	7	1,00E-03	30	50	10	10	100	1,0E-04
P1	G2	2	Unknown 1	U1	7	1,00E-03	30	50	10	10	100	1,0E-04
P1	G3	3	Unknown 1	U1	7	1,00E-03	30	50	10	10	100	1,0E-04
P1	H1	1	Unknown 1	U1	8	1,00E-02	30	50	10	10	100	1,0E-03
P1	H2	2	Unknown 1	U1	8	1,00E-02	30	50	10	10	100	1,0E-03

▼M8

Plate	Position	Replicate	Well type	Well Code	Concentration Code	Competitor Initial Concentration (M)	hrER stock (µl)	Buffer Volume (µl)	Tracer (Hot E2) Volume (µL)	Volume from dilution plate (µL)	Final Volume (µl)	Competitor Final Concentration (M)
P1	H3	3	Unknown 1	U1	8	1,00E-02	30	50	10	10	100	1,0E-03
P1	A4	1	Unknown 2	U2	1	1,00E-09	30	50	10	10	100	1,0E-10
P1	A5	2	Unknown 2	U2	1	1,00E-09	30	50	10	10	100	1,0E-10
P1	A6	3	Unknown 2	U2	1	1,00E-09	30	50	10	10	100	1,0E-10
P1	B4	1	Unknown 2	U2	2	1,00E-08	30	50	10	10	100	1,0E-09
P1	B5	2	Unknown 2	U2	2	1,00E-08	30	50	10	10	100	1,0E-09
P1	B6	3	Unknown 2	U2	2	1,00E-08	30	50	10	10	100	1,0E-09
P1	C4	1	Unknown 2	U2	3	1,00E-07	30	50	10	10	100	1,0E-08
P1	C5	2	Unknown 2	U2	3	1,00E-07	30	50	10	10	100	1,0E-08
P1	C6	3	Unknown 2	U2	3	1,00E-07	30	50	10	10	100	1,0E-08
P1	D4	1	Unknown 2	U2	4	1,00E-06	30	50	10	10	100	1,0E-07
P1	D5	2	Unknown 2	U2	4	1,00E-06	30	50	10	10	100	1,0E-07
P1	D6	3	Unknown 2	U2	4	1,00E-06	30	50	10	10	100	1,0E-07
P1	E4	1	Unknown 2	U2	5	1,00E-05	30	50	10	10	100	1,0E-06
P1	E5	2	Unknown 2	U2	5	1,00E-05	30	50	10	10	100	1,0E-06
P1	E6	3	Unknown 2	U2	5	1,00E-05	30	50	10	10	100	1,0E-06
P1	F4	1	Unknown 2	U2	6	1,00E-04	30	50	10	10	100	1,0E-05
P1	F5	2	Unknown 2	U2	6	1,00E-04	30	50	10	10	100	1,0E-05
P1	F6	3	Unknown 2	U2	6	1,00E-04	30	50	10	10	100	1,0E-05
P1	G4	1	Unknown 2	U2	7	1,00E-03	30	50	10	10	100	1,0E-04
P1	G5	2	Unknown 2	U2	7	1,00E-03	30	50	10	10	100	1,0E-04
P1	G6	3	Unknown 2	U2	7	1,00E-03	30	50	10	10	100	1,0E-04
P1	H4	1	Unknown 2	U2	8	1,00E-02	30	50	10	10	100	1,0E-03
P1	H5	2	Unknown 2	U2	8	1,00E-02	30	50	10	10	100	1,0E-03
P1	H6	3	Unknown 2	U2	8	1,00E-02	30	50	10	10	100	1,0E-03
P1	A7	1	Unknown 3	U3	1	1,00E-09	30	50	10	10	100	1,0E-10
P1	A8	2	Unknown 3	U3	1	1,00E-09	30	50	10	10	100	1,0E-10

▼ M8

Plate	Position	Replicate	Well type	Well Code	Concentration Code	Competitor Initial Concentration (M)	hrER stock (µl)	Buffer Volume (µl)	Tracer (Hot E2) Volume (µL)	Volume from dilution plate (µL)	Final Volume (µl)	Competitor Final Concentration (M)
P1	A9	3	Unknown 3	U3	1	1,00E-09	30	50	10	10	100	1,0E-10
P1	B7	1	Unknown 3	U3	2	1,00E-08	30	50	10	10	100	1,0E-09
P1	B8	2	Unknown 3	U3	2	1,00E-08	30	50	10	10	100	1,0E-09
P1	B9	3	Unknown 3	U3	2	1,00E-08	30	50	10	10	100	1,0E-09
P1	C7	1	Unknown 3	U3	3	1,00E-07	30	50	10	10	100	1,0E-08
P1	C8	2	Unknown 3	U3	3	1,00E-07	30	50	10	10	100	1,0E-08
P1	C9	3	Unknown 3	U3	3	1,00E-07	30	50	10	10	100	1,0E-08
P1	D7	1	Unknown 3	U3	4	1,00E-06	30	50	10	10	100	1,0E-07
P1	D8	2	Unknown 3	U3	4	1,00E-06	30	50	10	10	100	1,0E-07
P1	D9	3	Unknown 3	U3	4	1,00E-06	30	50	10	10	100	1,0E-07
P1	E7	1	Unknown 3	U3	5	1,00E-05	30	50	10	10	100	1,0E-06
P1	E8	2	Unknown 3	U3	5	1,00E-05	30	50	10	10	100	1,0E-06
P1	E9	3	Unknown 3	U3	5	1,00E-05	30	50	10	10	100	1,0E-06
P1	F7	1	Unknown 3	U3	6	1,00E-04	30	50	10	10	100	1,0E-05
P1	F8	2	Unknown 3	U3	6	1,00E-04	30	50	10	10	100	1,0E-05
P1	F9	3	Unknown 3	U3	6	1,00E-04	30	50	10	10	100	1,0E-05
P1	G7	1	Unknown 3	U3	7	1,00E-03	30	50	10	10	100	1,0E-04
P1	G8	2	Unknown 3	U3	7	1,00E-03	30	50	10	10	100	1,0E-04
P1	G9	3	Unknown 3	U3	7	1,00E-03	30	50	10	10	100	1,0E-04
P1	H7	1	Unknown 3	U3	8	1,00E-02	30	50	10	10	100	1,0E-03
P1	H8	2	Unknown 3	U3	8	1,00E-02	30	50	10	10	100	1,0E-03
P1	H9	3	Unknown 3	U3	8	1,00E-02	30	50	10	10	100	1,0E-03
P1	A10	1	Control E2 (max)	S	E2max1	1,00E-06	30	50	10	10	100	1,00E-07
P1	A11	2	Control E2 (max)	S	E2max2	1,00E-06	30	50	10	10	100	1,00E-07
P1	A12	3	Control E2 (max)	S	E2max3	1,00E-06	30	50	10	10	100	1,00E-07
P1	B10	1	Control E2 (IC50)	S	E2IC501	E2IC50x10	30	50	10	10	100	E2IC50

▼ M8

Plate	Position	Replicate	Well type	Well Code	Concentration Code	Competitor Initial Concentration (M)	hrER stock (µl)	Buffer Volume (µl)	Tracer (Hot E2) Volume (µL)	Volume from dilution plate (µL)	Final Volume (µl)	Competitor Final Concentration (M)
P1	B11	2	Control E2 (IC50)	S	E2IC502	E2IC50x10	30	50	10	10	100	E2IC50
P1	B12	3	Control E2 (IC50)	S	E2IC503	E2IC50x10	30	50	10	10	100	E2IC50
P1	C10	1	Control NE (max)	S	Nemax1	1,00E-3,5	30	50	10	10	100	1,00E-4,5
P1	C11	2	Control NE (max)	S	Nemax2	1,00E-3,5	30	50	10	10	100	1,00E-4,5
P1	C12	3	Control NE (max)	S	Nemax3	1,00E-3,5	30	50	10	10	100	1,00E-4,5
P1	D10	1	Control NE (IC50)	S	NEIC501	NEIC50 x10	30	50	10	10	100	NEIC50
P1	D11	2	Control NE (IC50)	S	NEIC502	NEIC50 x10	30	50	10	10	100	NEIC50
P1	D12	3	Control NE (IC50)	S	NEIC503	NEIC50 x10	30	50	10	10	100	NEIC50
P1	E10	1	cold E2 (high)	NSB	S1	1,00E-05	30	50	10	10	100	1,0E-06
P1	E11	2	cold E2 (high)	NSB	S2	1,00E-05	30	50	10	10	100	1,0E-06
P1	E12	3	cold E2 (high)	NSB	S3	1,00E-05	30	50	10	10	100	1,0E-06
P1	F10	4	cold E2 (high)	NSB	S4	1,00E-05	30	50	10	10	100	1,0E-06
P1	F11	5	cold E2 (high)	NSB	S5	1,00E-05	30	50	10	10	100	1,0E-06
P1	F12	6	cold E2 (high)	NSB	S6	1,00E-05	30	50	10	10	100	1,0E-06
P1	G10	1	total binding	TB	TB1	—	30	60	10	—	100	—
P1	G11	2	total binding	TB	TB2	—	30	60	10	—	100	—
P1	G12	3	total binding	TB	TB3	—	30	60	10	—	100	—

▼ **M8**

Plate	Position	Replicate	Well type	Well Code	Concentration Code	Competitor Initial Concentration (M)	hrER stock (µl)	Buffer Volume (µl)	Tracer (Hot E2) Volume (µL)	Volume from dilution plate (µL)	Final Volume (µl)	Competitor Final Concentration (M)
P1	H10	4	total binding	TB	TB4	—	30	60	10	—	100	—
P1	H11	5	total binding	TB	TB5	—	30	60	10	—	100	—
P1	H12	6	total binding	TB	TB6	—	30	60	10	—	100	—

(*) Note that the 'hotspace' wells are empty during incubation. The 10 µl are added only for scintillation counting.

▼ M8

Appendix 4

CONSIDERATIONS FOR THE ANALYSIS OF DATA FROM THE HRER COMPETITIVE BINDING ASSAY

1. The hrER α competitive binding assay measures the binding of a single concentration of [3 H]-17 β -estradiol in the presence of increasing concentrations of a test chemical. The competitive binding curve is plotted as specific [3 H]-17 β -estradiol binding versus the concentration (log₁₀ units) of the competitor. The concentration of the test chemical that inhibits 50 % of the maximum specific [3 H]-17 β -estradiol binding is the IC₅₀.

Data Analysis for the Reference Estrogen and Weak Binder (1)

2. Data from the control runs are transformed (i.e. percent [3 H]-17 β -estradiol specific binding and the log concentration of the control chemical) for further analysis. Estimates of log(IC₅₀) values for the positive controls (e.g. reference estrogen and weak binder) should be determined using an appropriate nonlinear curve fitting software to fit a four parameter Hill equation (e.g. BioSoft; GraphPad Prism) (2). The top, bottom, slope, and log(IC₅₀) can typically be left unconstrained when fitting these curves. Robust regression should be used when determining the best fit unless justification is given. The method chosen for robust regression should be stated. Correction for ligand depletion was not needed for the FW or CERI hrER assays, but may be considered if needed. Following the initial analysis, each binding curve should be reviewed to ensure an appropriate fit to the model. The relative binding affinity (RBA) for the weak binder can be calculated as a percent of the log (IC₅₀) for the weak binder relative to the log (IC₅₀) for 17 β -estradiol. Results for the positive controls and the non-binder control should be evaluated using measures of assay performance and acceptability criteria as described in this test method (paragraph 20), Appendix 2 (FW Assay, paragraphs 41-51) and Appendix 3 (CERI Assay, paragraphs 41-51). Examples of 3 runs for the reference estrogen and weak binder are shown in Figure 1.

Figure 1

Examples of the competitive binding curves for the reference estrogen and the control weak binder

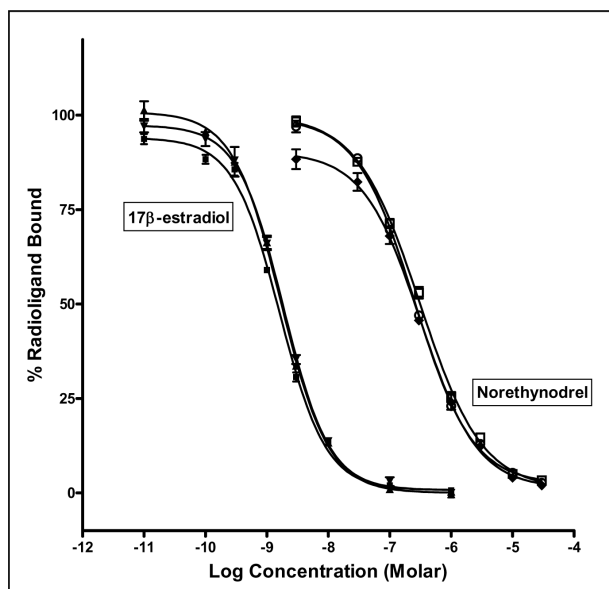

▼ M8

Data Analysis for Test Chemicals

3. Data for all test chemicals should be analysed using a step-wise approach to ensure that data are appropriately analysed and that each competitive binding curve is properly classified. Each run for a test chemical should initially undergo a standardised data analysis that is identical to that used for the reference estrogen and weak binder controls. Once completed, a technical review of the curve fit parameters as well as a visual review of how well the data fit the generated competitive binding curve for each run should be conducted. During this technical review, the observations of a concentration dependent decrease in the percent [^3H]-17 β -estradiol specifically bound, low variability among the technical replicates at each chemical concentration, and consistency in fit parameters among the three runs are a good indication that the assay and data analyses were conducted appropriately. Professional judgment should be applied when reviewing results from each run for a test chemical, and the data used to classify each test chemical as a binder or non-binder should be scientifically defensible.
4. Occasionally, there may be examples of data that require additional attention in order to appropriately analyse and interpret the hrER binding data. Previous studies had shown cases where the analysis and interpretation of competitive receptor binding data can be complicated by an upturn of the percent specific binding when testing chemicals at the highest concentrations (Figure 2). This is a well-known issue that has been encountered when using protocols for a number of competitive receptor binding assays (3). In these cases, a concentration dependent response is observed at lower concentrations, but as the concentration of the test chemical approaches the limit of solubility, the displacement of [^3H]-17 β -estradiol no longer decreases. In these cases, data for the higher concentrations indicate that the biological limit of the assay has been reached. For example, this phenomenon is many times associated with chemical insolubility and precipitation at high concentrations, or may also be a reflection of exceeding the capacity of the dextran-coated charcoal to trap the unbound radiolabelled ligand during the separation procedure at the highest chemical concentrations. Leaving such data points in when fitting competitive binding data to a sigmoid curve can sometimes lead to a misclassification of the ER binding potential for a test chemical (Figure 2). To avoid this, the protocol for the FW and CER1 hrER binding assays includes an option to exclude data points where the mean of the replicates for the percent [^3H]-17 β -estradiol specific bound is 10 % or more above the mean observed at a lower concentration (i.e. This is commonly referred to as the 10 % rule). This rule can only be used once for a given curve, and there must be data remaining for at least 6 concentrations such that the curve can be correctly classified.

Figure 2

Examples, Competitive Binding Curves with and without Use of the 10 % Rule

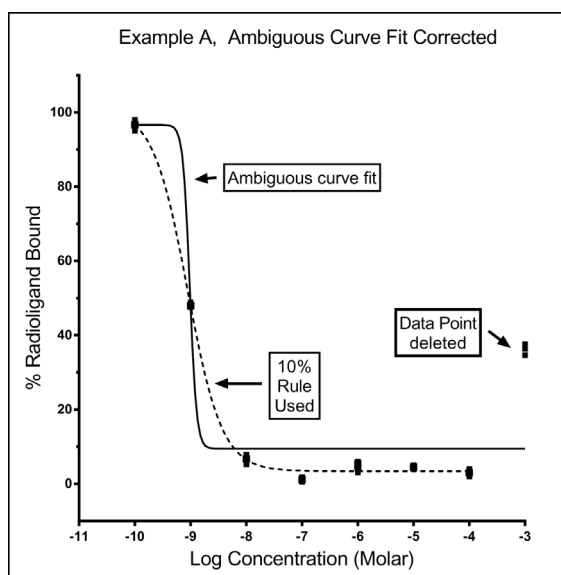

▼ **M8**

5. The appropriate use of the 10 % rule to correct these curves should be carefully considered and reserved for those cases where there is a strong indication of a hrER binder. During the conduct of experiments for the validation study of the FW hrER Binding Assay, it was observed that the 10 % rule sometimes had an unintended and unforeseen consequence. Chemicals that did not interact with the receptor (i.e. true non-binders) often showed variability around 100 % radioligand binding that was greater than 10 % across the range of concentrations tested. If the lowest value happened to be at a low concentration, the data from all higher concentrations could potentially be deleted from the analysis by using the 10 % rule, even though those concentrations could be useful in establishing that the chemical is a non-binder. Figure 3 show examples where the use of the 10 % rule is not appropriate.

Figure 3

Examples, Competitive Binding Data Where Use of the 10 % Rule is Not Appropriate.

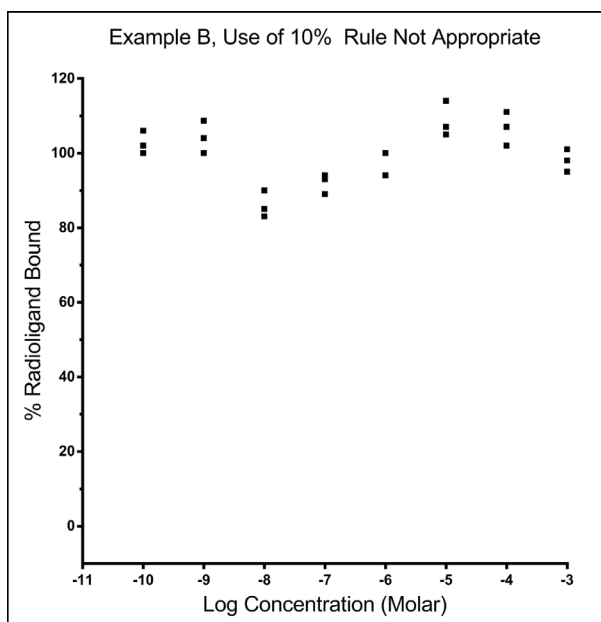
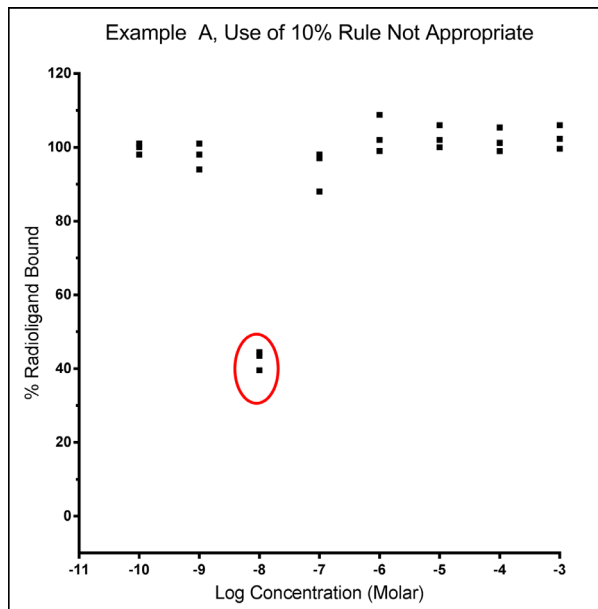

▼ M8**References**

- (1) OECD (2015). *Integrated Summary Report: Validation of Two Binding Assays Using Human Recombinant Estrogen Receptor Alpha (hrERα)*, Health and Safety Publications, Series on Testing and Assessment (No 226), Organisation for Economic Cooperation and Development, Paris.
- (2) Motulsky H. and Christopoulos A. (2003). *The law of mass action, In Fitting Models to Biological Data Using Linear and Non-linear Regression*. GraphPad Software Inc., San Diego, CA, pp 187-191. www.graphpad.com/manuals/Prism4/RegressionBook.pdf
- (3) Laws SC, Yavanxay S, Cooper RL, Eldridge JC. (2006). *Nature of the Binding Interaction for 50 Structurally Diverse Chemicals with Rat Estrogen Receptors*. *Toxicological Sci.* 94(1):46-56.

▼M8**B.71. *IN VITRO* SKIN SENSITISATION ASSAYS ADDRESSING THE KEY EVENT ON ACTIVATION OF DENDRITIC CELLS ON THE ADVERSE OUTCOME PATHWAY (AOP) FOR SKIN SENSITISATION**

GENERAL INTRODUCTION

Activation of dendritic cells key event based test method

1. A skin sensitiser refers to a substance that will lead to an allergic response following skin contact as defined by the United Nations Globally Harmonized System of Classification and Labelling of Chemicals (UN GHS) (1) and the European Union (EU) Regulation 1272/2008 on Classification, Labelling and Packaging of Substances and Mixtures (CLP) (1). There is general agreement on the key biological events underlying skin sensitisation. The current knowledge of the chemical and biological mechanisms associated with skin sensitisation has been summarised as an Adverse Outcome Pathway (AOP) under the OECD AOP programme (2), starting with the molecular initiating event through intermediate events to the adverse effect, namely allergic contact dermatitis. In this instance, the molecular initiating event (i.e. the first key event) is the covalent binding of electrophilic substances to nucleophilic centres in skin proteins. The second key event in this AOP takes place in the keratinocytes and includes inflammatory responses as well as changes in gene expression associated with specific cell signalling pathways such as the antioxidant/electrophile response element (ARE)-dependent pathways. The third key event is the activation of dendritic cells (DC), typically assessed by expression of specific cell surface markers, chemokines and cytokines. The fourth key event is T-cell activation and proliferation, which is indirectly assessed in the murine Local Lymph Node Assay (LLNA) (3).
2. This test method (TM) is equivalent to OECD test guideline (TG) 442E (2017). It describes *in vitro* assays that address mechanisms described under the key event on activation of dendritic cells of the AOP for skin sensitisation (2). The TM comprises tests to be used for supporting the discrimination between skin sensitisers and non-sensitisers in accordance with the UN GHS and CLP.

The tests described in this TM are:

- Human Cell Line Activation Test (h-CLAT)
- U937 cell line activation Test (U-SENSTM)
- Interleukin-8 Reporter Gene Assay (IL-8 Luc assay)

3. The tests included in this test method and the corresponding OECD TG may differ in relation to the procedure used to generate the data and the readouts measured but can be used indiscriminately to address countries' requirements for test results on the Key Event on activation of dendritic cells of the AOP for skin sensitisation while benefiting from the OECD Mutual Acceptance of Data.

(1) Regulation (EC) No 1272/2008 of the European Parliament and of the Council of 16 December 2008 on classification, labelling and packaging of substances and mixtures, amending and repealing Directives 67/548/EEC and 1999/45/EC, and amending Regulation (EC) No 1907/2006, OJ L 353/1, 31.12.2008

▼ M8**Background and principles of the tests included in the key event based test method**

4. The assessment of skin sensitisation has typically involved the use of laboratory animals. The classical methods that use guinea-pigs, the Guinea Pig Maximisation Test (GPMT) of Magnusson and Kligman, and the Buehler Test (TM B.6) (4), assess both the induction and elicitation phases of skin sensitisation. The murine tests, the LLNA (TM B.42) (3) and its two non-radioactive modifications, LLNA: DA (TM B.50) (5) and LLNA: BrdU-ELISA (TM B.51) (6), all assess the induction response exclusively, and have also gained acceptance, since they provide an advantage over the guinea pig tests in terms of animal welfare together with an objective measurement of the induction phase of skin sensitisation.

5. Recently mechanistically-based *in chemico* and *in vitro* test methods addressing the first key event (TM B.59; Direct Peptide Reactivity Assay (7)), and second key event (TM B.60; ARE-Nrf2 Luciferase Test Method (8)) of the skin sensitisation AOP have been adopted for contributing to the evaluation of the skin sensitisation hazard potential of chemicals.

6. Tests described in this test method either quantify the change in the expression of cell surface marker(s) associated with the process of activation of monocytes and DC following exposure to sensitisers (e.g. CD54, CD86) or the changes in IL-8 expression, a cytokine associated with the activation of DC. Skin sensitisers have been reported to induce the expression of cell membrane markers such as CD40, CD54, CD80, CD83, and CD86 in addition to induction of proinflammatory cytokines, such as IL-1 β and TNF- α , and several chemokines including IL-8 (CXCL8) and CCL3 (9) (10) (11) (12), associated with DC activation (2).

7. However, as DC activation represents only one key event of the skin sensitisation AOP (2) (13), information generated with tests measuring markers of DC activation alone may not be sufficient to conclude on the presence or absence of skin sensitisation potential of chemicals. Therefore data generated with the tests described in this test method are proposed to support the discrimination between skin sensitisers (i.e. UN GHS/CLP Category 1) and non-sensitisers when used within Integrated Approaches to Testing and Assessment (IATA), together with other relevant complementary information, e.g. derived from *in vitro* assays addressing other key events of the skin sensitisation AOP as well as non-testing methods, including read-across from chemical analogues (13). Examples of the use of data generated with these tests within Defined Approaches, i.e. approaches standardised both in relation to the set of information sources used and in the procedure applied to the data to derive predictions, have been published (13) and can be employed as useful elements within IATA.

8. The tests described in this test method cannot be used on their own, neither to sub-categorise skin sensitisers into subcategories 1A and 1B as defined by UN GHS/CLP, for authorities implementing these two optional subcategories, nor to predict potency for safety assessment decisions. However, depending on the regulatory framework, positive results generated with these methods may be used on their own to classify a chemical into UN GHS/CLP category 1.

▼ M8

9. The term ‘test chemical’ is used in this test method to refer to what is being tested⁽¹⁾ and is not related to the applicability of the tests to the testing of mono-constituent substances, multi-constituent substances and/or mixtures. Limited information is currently available on the applicability of the tests to multi-constituent substances/mixtures (14) (15). The tests are nevertheless technically applicable to the testing of multi-constituent substances and mixtures. However, before use of this test method on a mixture for generating data for an intended regulatory purpose, it should be considered whether, and if so why, it may provide adequate results for that purpose⁽²⁾. Such considerations are not needed when there is a regulatory requirement for the testing of the mixture. Moreover, when testing multi-constituent substances or mixtures, consideration should be given to possible interference of cytotoxic constituents with the observed responses.

LITERATURE

- (1) United Nations UN (2015). Globally Harmonized System of Classification and Labelling of Chemicals (GHS). Sixth revised edition. New York & Geneva: United Nations Publications. ISBN: 978-92-1-117006-1. Available at: https://www.unece.org/trans/danger/publi/ghs/ghs_rev06/06files_e.html
- (2) OECD (2012). The Adverse Outcome Pathway for Skin Sensitisation Initiated by Covalent Binding to Proteins. Part 1: Scientific Evidence. Series on Testing and Assessment No. 168. Available at: [http://www.oecd.org/officialdocuments/publicdisplaydocumentpdf/?cote=ENV/JM/MONO\(2012\)10/PART1&docLanguage=En](http://www.oecd.org/officialdocuments/publicdisplaydocumentpdf/?cote=ENV/JM/MONO(2012)10/PART1&docLanguage=En)
- (3) Chapter B.42 of this Annex: The Local Lymph Node Assay.
- (4) Chapter B.6 of this Annex: Skin Sensitisation.
- (5) Chapter B.50 of this Annex: Skin Sensitisation: Local Lymph Node Assay: DA.
- (6) Chapter B.51 of this Annex: Skin sensitisation: Local Lymph Node Assay: BrdU-ELISA.
- (7) Chapter B.59 of this Annex: In Chemico Skin Sensitisation: Direct Peptide Reactivity Assay (DPRA).
- (8) Chapter B.60 of this Annex: *In Vitro* Skin Sensitisation: ARE-Nrf2 Luciferase Test Method.
- (9) Steinman RM. (1991). The dendritic cell system and its role in immunogenicity. *Annu Rev Immunol* 9:271-96.
- (10) Caux C, Vanbervliet B, Massacrier C, Azuma M, Okumura K, Lanier LL, and Banchereau J. (1994). B70/B7-2 is identical to CD86 and is the major functional ligand for CD28 expressed on human dendritic cells. *J Exp Med* 180:1841-7.
- (11) Aiba S, Terunuma A, Manome H, and Tagami H. (1997). Dendritic cells differently respond to haptens and irritants by their production of cytokines and expression of co-stimulatory molecules. *Eur J Immunol* 27:3031-8.

⁽¹⁾ In June 2013, the OECD Joint Meeting agreed that where possible, a more consistent use of the term ‘test chemical’ describing what is being tested should be applied in new and updated OECD test guidelines.

⁽²⁾ This sentence was proposed and agreed at the April 2014 WNT meeting

▼M8

- (12) Aiba S, Manome H, Nakagawa S, Mollah ZU, Mizuashi M, Ohtani T, Yoshino Y, and Tagami. H. (2003). p38 mitogen-activated protein kinase and extracellular signal-regulated kinases play distinct roles in the activation of dendritic cells by two representative haptens, NiCl₂ and DNCB. *J Invest Dermatol* 120:390-8.
- (13) OECD (2016). Series on Testing & Assessment No 256: Guidance Document On The Reporting Of Defined Approaches And Individual Information Sources To Be Used Within Integrated Approaches To Testing And Assessment (IATA) For Skin Sensitisation, Annex 1 and Annex 2. ENV/JM/HA(2016)29. Organisation for Economic Cooperation and Development, Paris. Available at: <https://community.oecd.org/community/iatass>.
- (14) Ashikaga T, Sakaguchi H, Sono S, Kosaka N, Ishikawa M, Nukada Y, Miyazawa M, Ito Y, Nishiyama N, Itagaki H. (2010). A comparative evaluation of *in vitro* skin sensitisation tests: the human cell-line activation test (h-CLAT) versus the local lymph node assay (LLNA). *Altern. Lab. Anim.* 38, 275-284.
- (15) Piroird, C., Ovigne, J.M., Rousset, F., Martinozzi-Teissier, S., Gomes, C., Cotovio, J., Alépée, N. (2015). The Myeloid U937 Skin Sensitization Test (U-SENS) addresses the activation of dendritic cell event in the adverse outcome pathway for skin sensitization. *Toxicol. In Vitro* 29, 901-916.

▼M8*Appendix 1*

IN VITRO SKIN SENSITISATION: HUMAN CELL LINE ACTIVATION TEST (H-CLAT)?

INITIAL CONSIDERATIONS AND LIMITATIONS

1. The h-CLAT quantifies changes in the expression of cell surface markers associated with the process of activation of monocytes and dendritic cells (DC) (i.e. CD86 and CD54), in the human monocytic leukaemia cell line THP-1, following exposure to sensitisers (1)(2). The measured expression levels of CD86 and CD54 cell surface markers are then used for supporting the discrimination between skin sensitisers and non-sensitisers.
2. The h-CLAT has been evaluated in a European Union Reference Laboratory for Alternatives to Animal Testing (EURL ECVAM)-coordinated validation study and subsequent independent peer review by the EURL ECVAM Scientific Advisory Committee (ESAC). Considering all available evidence and input from regulators and stakeholders, the h-CLAT was recommended by EURL ECVAM (3) to be used as part of an IATA to support the discrimination between sensitisers and non-sensitisers for the purpose of hazard classification and labelling. Examples of the use of h-CLAT data in combination with other information are reported in the literature (4)(5)(6)(7)(8)(9)(10)(11).
3. The h-CLAT proved to be transferable to laboratories experienced in cell culture techniques and flow cytometry analysis. The level of reproducibility in predictions that can be expected from the test is in the order of 80 % within and between laboratories (3)(12). Results generated in the validation study (13) and other published studies (14) overall indicate that, compared with LLNA results, the accuracy in distinguishing skin sensitisers (i.e. UN GHS/CLP Cat.1) from non-sensitisers is 85 % (N=142) with a sensitivity of 93 % (94/101) and a specificity of 66 % (27/41) (based on a re-analysis by EURL ECVAM (12) considering all existing data and not considering negative results for chemicals with a Log Kow greater than 3.5 as described in paragraph 4). False negative predictions with the h-CLAT are more likely to concern chemicals showing a low to moderate skin sensitisation potency (i.e. UN GHS/CLP subcategory 1B) than chemicals showing a high skin sensitisation potency (i.e. UN GHS/CLP subcategory 1A) (4)(13)(15). Taken together, this information indicates the usefulness of the h-CLAT method to contribute to the identification of skin sensitisation hazards. However, the accuracy values given here for the h-CLAT as a stand-alone test are only indicative, since the test should be considered in combination with other sources of information in the context of an IATA and in accordance with the provisions of paragraphs 7 and 8 in the General introduction. Furthermore, when evaluating non-animal methods for skin sensitisation, it should be kept in mind that the LLNA test as well as other animal tests may not fully reflect the situation in humans.
4. On the basis of the data currently available, the h-CLAT method was shown to be applicable to test chemicals covering a variety of organic functional groups, reaction mechanisms, skin sensitisation potency (as determined in *in vivo* studies) and physicochemical properties (3)(14)(15). The h-CLAT method is applicable to test chemicals soluble or that form a stable dispersion (i.e. a colloid or suspension in which the test chemical does not settle or separate from the solvent/vehicle into different phases) in an appropriate solvent/vehicle (see paragraph 14). Test chemicals with a Log Kow greater than 3.5 tend to produce false negative results (14). Therefore negative results with test chemicals with a Log Kow greater than 3.5 should not be considered. However, positive results obtained with test chemicals with a Log Kow greater than 3.5 could still be used to support the identification of the test chemical as a skin sensitiser. Furthermore,

▼M8

because of the limited metabolic capability of the cell line used (16) and because of the experimental conditions, pro-haptens (i.e. substances requiring enzymatic activation for example via P450 enzymes) and pre-haptens (i.e. substances activated by oxidation) in particular with a slow oxidation rate may also provide negative results in the h-CLAT (15). Fluorescent test chemicals can be assessed with the h-CLAT (17), nevertheless, strong fluorescent test chemicals emitting at the same wavelength as fluorescein isothiocyanate (FITC) or as propidium iodide (PI), will interfere with the flow cytometric detection and thus cannot be correctly evaluated using FITC-conjugated antibodies or PI. In such a case, other fluorochrome-tagged antibodies or other cytotoxicity markers, respectively, can be used as long as it can be shown they provide similar results as the FITC-tagged antibodies (see paragraph 24) or PI (see paragraph 18) e.g. by testing the proficiency substances in Appendix 1-2. In the light of the above, negative results should be interpreted in the context of the stated limitations and together with other information sources within the framework of IATA. In cases where there is evidence demonstrating the non-applicability of the h-CLAT method to other specific categories of test chemicals, it should not be used for those specific categories.

5. As described above, the h-CLAT method supports the discrimination between skin sensitisers from non-sensitisers. However, it may also potentially contribute to the assessment of sensitising potency (4)(5)(9) when used in integrated approaches such as IATA. Nevertheless, further work, preferably based on human data, is required to determine how h-CLAT results may possibly inform potency assessment.

6. Definitions are provided in Appendix 1.1.

PRINCIPLE OF THE TEST

7. The h-CLAT method is an *in vitro* assay that quantifies changes of cell surface marker expression (i.e. CD86 and CD54) on a human monocytic leukemia cell line, THP-1 cells, following 24 hours exposure to the test chemical. These surface molecules are typical markers of monocytic THP-1 activation and may mimic DC activation, which plays a critical role in T-cell priming. The changes of surface marker expression are measured by flow cytometry following cell staining with fluorochrome-tagged antibodies. Cytotoxicity measurement is also conducted concurrently to assess whether upregulation of surface marker expression occurs at sub-cytotoxic concentrations. The relative fluorescence intensity of surface markers compared to solvent/vehicle control are calculated and used in the prediction model (see paragraph 26), to support the discrimination between sensitisers and non-sensitisers

DEMONSTRATION OF PROFICIENCY

8. Prior to routine use of the test described in this Appendix to test method B.71, laboratories should demonstrate technical proficiency, using the 10 proficiency substances listed in Appendix 1.2. Moreover, test users should maintain an historical database of data generated with the reactivity checks (see paragraph 11) and with the positive and solvent/vehicle controls (see paragraphs 20-22), and use these data to confirm the reproducibility of the test in their laboratory is maintained over time.

▼ M8**PROCEDURE**

9. This test is based on the h-CLAT DataBase service on ALternative Methods to animal experimentation (DB-ALM) protocol no 158 (18) which represents the protocol used for the EURL ECVAM-coordinated validation study. It is recommended that this protocol is used when implementing and using the h-CLAT method in the laboratory. The following is a description of the main components and procedures for the h-CLAT method, which comprises two steps: *dose finding assay* and *CD86/CD54 expression measurement*.

Preparation of cells

10. The human monocytic leukaemia cell line, THP-1, should be used for performing the h-CLAT method. It is recommended that cells (TIB-202™) are obtained from a well-qualified cell bank, such as the American Type Culture Collection.

11. THP-1 cells are cultured, at 37°C under 5 % CO₂ and humidified atmosphere, in RPMI-1640 medium supplemented with 10 % foetal bovine serum (FBS), 0,05 mM 2-mercaptoethanol, 100 units/ml penicillin and 100 µg/ml streptomycin. The use of penicillin and streptomycin in the culture medium can be avoided. However, in such a case users should verify that the absence of antibiotics in the culture medium has no impact on the results, for example by testing the proficiency substances listed in Appendix 1.2. In any case, in order to minimise the risk of contamination, good cell culture practices should be followed independently of the presence or not of antibiotics in the cell culture medium. THP-1 cells are routinely seeded every 2-3 days at the density of 0,1 to 0,2 × 10⁶ cells/ml. They should be maintained at densities from 0,1 to 1,0 × 10⁶ cells/ml. Prior to using them for testing, the cells should be qualified by conducting a reactivity check. The reactivity check of the cells should be performed using the positive controls, 2,4-dinitrochlorobenzene (DNCB) (CAS no 97-00-7, ≥ 99 % purity) and nickel sulfate (NiSO₄) (CAS no 10101-97-0, ≥ 99 % purity) and the negative control, lactic acid (LA) (CAS no 50-21-5, ≥ 85 % purity), two weeks after thawing. Both DNCB and NiSO₄ should produce a positive response of both CD86 and CD54 cell surface markers, and LA should produce a negative response of both CD86 and CD54 cell surface markers. Only the cells which passed the reactivity check are to be used for the assay. Cells can be propagated up to two months after thawing. Passage number should not exceed 30. The reactivity check should be performed according to the procedures described in paragraphs 20-24.

12. For testing, THP-1 cells are seeded at a density of either 0,1 × 10⁶ cells/ml or 0,2 × 10⁶ cells/ml, and pre-cultured in culture flasks for 72 hours or for 48 hours, respectively. It is important that the cell density in the culture flask just after the pre-culture period be as consistent as possible in each experiment (by using one of the two pre-culture conditions described above), because the cell density in the culture flask just after pre-culture could affect the CD86/CD54 expression induced by allergens (19). On the day of testing, cells harvested from culture flask are resuspended with fresh culture medium at 2 × 10⁶ cells/ml. Then, cells are distributed into a 24 well flat-bottom plate (500 µl, 1 × 10⁶ cells/well) or a 96-well flat-bottom plate (80 µl, 1,6 × 10⁵ cells/well).

Dose finding assay

13. A *dose finding assay* is performed to determine the CV75, being the test chemical concentration that results in 75 % cell viability (CV) compared to the solvent/vehicle control. The CV75 value is used to determine the concentration of test chemicals for the *CD86/CD54* expression measurement (see paragraphs 20-24).

▼M8*Preparation of test chemicals and control substances*

14. The test chemicals and control substances are prepared on the day of testing. For the h-CLAT method, test chemicals are dissolved or stably dispersed (see also paragraph 4) in saline or medium as first solvent/vehicle options or dimethyl sulfoxide (DMSO, 99 % purity) as a second solvent/vehicle option if the test chemical is not soluble or does not form a stable dispersion in the previous two solvents/vehicles, to final concentrations of 100 mg/ml (in saline or medium) or 500 mg/ml (in DMSO). Other solvents/vehicles than those described above may be used if sufficient scientific rationale is provided. Stability of the test chemical in the final solvent/vehicle should be taken into account.

15. Starting from the 100 mg/ml (in saline or medium) or 500 mg/ml (in DMSO) stock solutions of the test chemicals, the following dilution steps should be taken:
 - For saline or medium as solvent/vehicle: Eight stock solutions (eight concentrations) are prepared, by two-fold serial dilutions using the corresponding solvent/vehicle. These stock solutions are then further diluted 50-fold into culture medium (working solutions). If the top final concentration in the plate of 1 000 µg/ml is non-toxic, the maximum concentration should be re-determined by performing a new cytotoxicity test. The final concentration in the plate should not exceed 5 000 µg/ml for test chemicals dissolved or stably dispersed in saline or medium.

 - For DMSO as solvent/vehicle: Eight stock solutions (eight concentrations) are prepared, by two-fold serial dilutions using the corresponding solvent/vehicle. These stock solutions are then further diluted 250-fold into culture medium (working solutions). The final concentration in plate should not exceed 1 000 µg/ml even if this concentration is non-toxic.

The working solutions are finally used for exposure by adding an equal volume of working solution to the volume of THP-1 cell suspension in the plate (see also paragraph 17) to achieve a further two-fold dilution (usually, the final range of concentrations in the plate is 7,81–1 000 µg/ml).

16. The solvent/vehicle control used in the h-CLAT method is culture medium (for test chemicals solubilised or stably dispersed (see paragraph 4) either with medium or saline) or DMSO (for test chemicals solubilised or stably dispersed in DMSO) tested at a single final concentration in the plate of 0,2 %. It undergoes the same dilution as described for the working solutions in paragraph 15.

Application of test chemicals and control substances

17. The culture medium or working solutions described in paragraphs 15 and 16 are mixed 1:1 (v/v) with the cell suspensions prepared in the 24-well or 96-well flat-bottom plate (see paragraph 12). The treated plates are then incubated for 24±0,5 hours at 37°C under 5 % CO₂. Care should be taken to avoid evaporation of volatile test chemicals and cross-contamination between wells by test chemicals, e.g. by sealing the plate prior to the incubation with the test chemicals (20).

▼ M8*Propidium iodide (PI) staining*

18. After 24±0.5 hours of exposure, cells are transferred into sample tubes and collected by centrifugation. The supernatants are discarded and the remaining cells are resuspended with 200 µl (in case of 96-well) or 600 µl (in case of 24-well) of a phosphate buffered saline containing 0,1 % bovine serum albumin (staining buffer). 200 µl of cell suspension is transferred into 96-well round-bottom plate (in case of 96-well) or micro tube (in case of 24-well) and washed twice with 200 µl (in case of 96-well) or 600 µl (in case of 24-well) of staining buffer. Finally, cells are resuspended in staining buffer (e.g. 400 µl) and PI solution (e.g. 20 µl) is added (for example, final concentration of PI is 0,625 µg/ml). Other cytotoxicity markers, such as 7-Aminoactinomycin D (7-AAD), Trypan blue or others may be used if the alternative stains can be shown to provide similar results as PI, for example by testing the proficiency substances in Appendix 1.2.

Cytotoxicity measurement by flow cytometry and estimation of CV75 value

19. The PI uptake is analysed using flow cytometry with the acquisition channel FL-3. A total of 10 000 living cells (PI negative) are acquired. The cell viability can be calculated using the following equation by the cytometer analysis program. When the cell viability is low, up to 30 000 cells including dead cells should be acquired. Alternatively, data can be acquired for one minute after the initiation of the analysis.

$$\text{Cell viability} = \frac{\text{Number of living cells}}{\text{Total Number of aquired cells}} \times 100$$

The CV75 value (see paragraph 13), i.e. a concentration showing 75 % of THP-1 cell survival (25 % cytotoxicity), is calculated by log-linear interpolation using the following equation:

$$\text{Log CV75} = \frac{(75 - c) \times \text{Log}(b) - (75 - a) \times \text{Log}(d)}{a - c}$$

Where:

a is the minimum value of cell viability over 75 %

c is the maximum value of cell viability below 75 %

b and d are the concentrations showing the value of cell viability a and c respectively

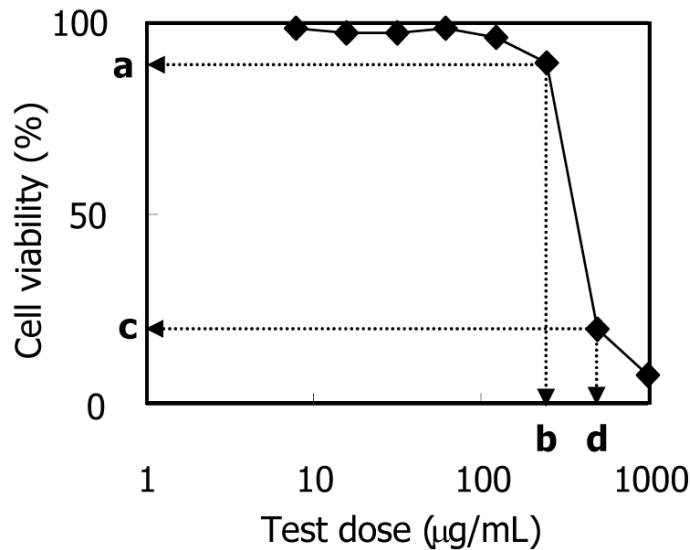
▼ M8

Other approaches to derive the CV75 can be used as long as it is demonstrated that this has no impact on the results (e.g. by testing the proficiency substances).

CD86/CD54 expression measurement

Preparation of the test chemicals and control substances

20. The appropriate solvent/vehicle (saline, medium or DMSO; see paragraph 14) is used to dissolve or stably disperse the test chemicals. The test chemicals are first diluted to the concentration corresponding to 100-fold (for saline or medium) or 500-fold (for DMSO) of the $1.2 \times CV75$ determined in the *dose finding assay* (see paragraph 19). If the CV75 cannot be determined (i.e. if sufficient cytotoxicity is not observed in the *dose finding assay*), the highest soluble or stably dispersed concentration of test chemical prepared with each solvent/vehicle should be used as starting concentration. Please note that the final concentration in the plate should not exceed 5 000 µg/ml (in case of saline or medium) or 1 000 µg/ml (in case of DMSO). Then, 1.2-fold serial dilutions are made using the corresponding solvent/vehicle to obtain the stock solutions (eight concentrations ranging from $100 \times 1.2 \times CV75$ to $100 \times 0.335 \times CV75$ (for saline or medium) or from $500 \times 1.2 \times CV75$ to $500 \times 0.335 \times CV75$ (for DMSO)) to be tested in the h-CLAT method (see DB-ALM protocol N_O. 158 for an example of dosing scheme). The stock solutions are then further diluted 50-fold (for saline or medium) or 250-fold (for DMSO) into the culture medium (working solutions). These working solutions are finally used for exposure with a further final two-fold dilution factor in the plate. If the results do not meet the acceptance criteria described in the paragraphs 29 and 30 regarding cell viability, the *dose finding assay* may be repeated to determine a more precise CV75. Please note that only 24-well plates can be used for CD86/CD54 expression measurement.
21. The solvent/vehicle control is prepared as described in paragraph 16. The positive control used in the h-CLAT method is DNCB (see paragraph 11), for which stock solutions are prepared in DMSO and diluted as described for the stock solutions in paragraph 20. DNCB should be used as the positive control for *CD86/CD54 expression measurement* at a final single concentration in the plate (typically 4,0 µg/ml). To obtain a 4,0 µg/ml concentration of DNCB in the plate, a 2 mg/ml stock solution of DNCB in DMSO is

▼ M8

prepared and further diluted 250-fold with culture medium to a 8 µg/ml working solution. Alternatively, the CV75 of DNCB, which is determined in each test facility, could be also used as the positive control concentration. Other suitable positive controls may be used if historical data are available to derive comparable run acceptance criteria. For positive controls, the final single concentration in the plate should not exceed 5 000 µg/ml (in case of saline or medium) or 1 000 µg/ml (in case of DMSO). The run acceptance criteria are the same as those described for the test chemical (see paragraph 29), except for the last acceptance criterion since the positive control is tested at a single concentration.

Application of test chemicals and control substances

22. For each test chemical and control substance, one experiment is needed to obtain a prediction. Each experiment consists of at least two independent runs for *CD86/CD54 expression measurement* (see paragraphs 26-28). Each independent run is performed on a different day or on the same day provided that for each run: a) independent fresh stock solutions and working solutions of the test chemical and antibody solutions are prepared and b) independently harvested cells are used (i.e. cells are collected from different culture flasks); however, cells may come from the same passage. Test chemicals and control substances prepared as working solutions (500 µl) are mixed with 500 µl of suspended cells (1×10^6 cells) at 1:1 ratio, and cells are incubated for 24 ± 0.5 hours as described in paragraphs 20 and 21. In each run, a single replicate for each concentration of the test chemical and control substance is sufficient because a prediction is obtained from at least two independent runs.

Cell staining and analysis

23. After 24 ± 0.5 hours of exposure, cells are transferred from 24 well plate into sample tubes, collected by centrifugation and then washed twice with 1ml of staining buffer (if necessary, additional washing steps may be done). After washing, cells are blocked with 600 µl of blocking solution (staining buffer containing 0,01 % (w/v) globulin (Cohn fraction II, III, human; SIGMA, #G2388-10G or equivalent)) and incubated at 4°C for 15 min. After blocking, cells are split in three aliquots of 180 µl into a 96-well round-bottom plate or micro tube.
24. After centrifugation, cells are stained with 50 µl of FITC-labelled anti-CD86, anti-CD54 or mouse IgG1 (isotype) antibodies at 4°C for 30 min. The antibodies described in the h-CLAT DB-ALM protocol no 158 (18) should be used by diluting 3:25 v/v (for CD86 (BD-PharMingen, #555657; Clone: Fun-1)) or 3:50 v/v (for CD54 (DAKO, #F7143; Clone: 6.5B5) and IgG1 (DAKO, #X0927)) with staining buffer. These antibody dilution factors were defined by the test developers as those providing the best signal-to-noise ratio. Based on the experience of the test developers, the fluorescence intensity of the antibodies is usually consistent between different lots. However, users may consider titrating the antibodies in their own laboratory's conditions to define the best concentrations for use. Other fluorochrome-tagged anti-CD86 and/or anti-CD54 antibodies may be used if they can be shown to provide similar results as FITC-conjugated antibodies, for example by testing the proficiency substances in Appendix 1.2. It should

▼ M8

be noted that changing the clone or supplier of the antibodies as described in the h-CLAT DB-ALM protocol no 158 (18) may affect the results. After washing twice or more with 150 µl of staining buffer, cells are resuspended in staining buffer (e.g. 400 µl), and the PI solution (e.g. 20 µl to obtain a final concentration of 0,625 µg/ml) or another cytotoxicity marker's solution (see paragraph 18) is added. The expression levels of CD86 and CD54, and cell viability are analysed using flow cytometry.

DATA AND REPORTING**Data evaluation**

25. The expression of CD86 and CD54 is analysed with flow cytometry with the acquisition channel FL-1. Based on the geometric mean fluorescence intensity (MFI), the relative fluorescence intensity (RFI) of CD86 and CD54 for positive control (ctrl) cells and chemical-treated cells are calculated according to the following equation:

$$RFI = \frac{MFI \text{ of chemical-treated cell} - MFI \text{ of chemical-treated isotype control cells}}{MFI \text{ of solvent/vehicle-treated ctrl cells} - MFI \text{ of solvent/vehicle-treated isotype ctrl cells}} \times 100$$

The cell viability from the isotype control (ctrl) cells (which are stained with mouse IgG1 (isotype) antibodies) is also calculated according to the equation described in paragraph 19.

Prediction model

26. For *CD86/CD54* expression measurement, each test chemical is tested in at least two independent runs to derive a single prediction (POSITIVE or NEGATIVE). An h-CLAT prediction is considered POSITIVE if at least one of the following conditions is met in 2 of 2 or in at least 2 of 3 independent runs, otherwise the h-CLAT prediction is considered NEGATIVE (Figure 1):
- The RFI of CD86 is equal to or greater than 150 % at any tested concentration (with cell viability \geq 50 %);
 - The RFI of CD54 is equal to or greater than 200 % at any tested concentration (with cell viability \geq 50 %).
27. Based on the above, if the first two runs are both positive for CD86 and/or are both positive for CD54, the h-CLAT prediction is considered POSITIVE and a third run does not need to be conducted. Similarly, if the first two runs are negative for both markers, the h-CLAT prediction is considered NEGATIVE (with due consideration of the provisions of paragraph 30) without the need for a third run. If however, the first two runs are not concordant for at least one of the markers (CD54 or CD86), a third run is needed and the final prediction will be based on the majority result of the three individual runs (i.e. 2 out of 3). In this respect, it should be noted that if two independent runs are conducted and one is only positive for CD86 (hereinafter referred to as P₁) and the other is only positive for CD54 (hereinafter referred to as P₂), a third run is required. If this third run is negative for both markers (hereinafter referred to as N), the h-CLAT prediction is considered NEGATIVE. On the other hand, if the third run is positive for either marker (P₁ or P₂) or for both markers (hereinafter referred to as P₁₂), the h-CLAT prediction is considered POSITIVE.

▼ M8

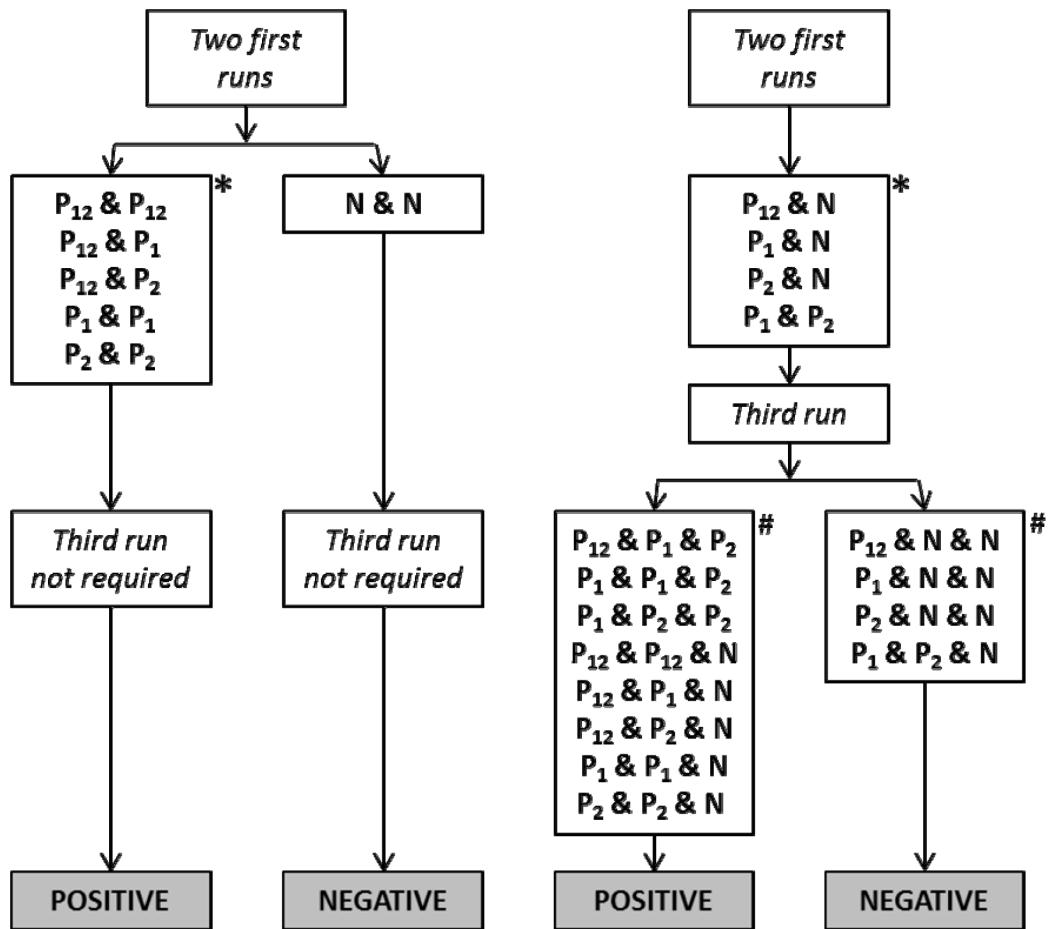

Figure 1: Prediction model used in the h-CLAT method. An h-CLAT prediction should be considered in the framework of an IATA and in accordance with the provision of paragraphs 7 and 8 in the General introduction.

P₁: run with only CD86 positive; P₂: run with only CD54 positive; P₁₂: run with both CD86 and CD54 positive; N: run with neither CD86 nor CD54 positive.

* The boxes show the relevant combinations of results from the first two runs, independently of the order in which they may be obtained.

The boxes show the relevant combinations of results from the three runs on the basis of the results obtained in the first two runs shown in the box above, but do not reflect the order in which they may be obtained.

28. For the test chemicals predicted as POSITIVE with the h-CLAT, optionally, two Effective Concentrations (EC) values, the EC₁₅₀ for CD86 and EC₂₀₀ for CD54, i.e. the concentration at which the test chemicals induced a RFI of 150 or 200, may be determined. These EC values potentially could contribute to the assessment of sensitising potency (9) when used in integrated approaches such as IATA (4) (5) (6) (7) (8). They can be calculated by the following equations:

▼M8

$$EC\ 150\ (for\ CD86) = B_{conc} + [(150 - B_{RFI})/A_{RFI} - B_{RFI}] \times (A_{conc} - B_{conc})$$

$$EC\ 200\ (for\ CD86) = B_{conc} + [(200 - B_{RFI})/A_{RFI} - B_{RFI}] \times (A_{conc} - B_{conc})$$

where

A_{conc} is the lowest concentration in $\mu\text{g/ml}$ with $RFI > 150$ (CD86) or 200 (CD54)

B_{conc} is the highest concentration in $\mu\text{g/ml}$ with $RFI < 150$ (CD86) or 200 (CD54)

A_{RFI} is the RFI at the lowest concentration with $RFI > 150$ (CD86) or 200 (CD54)

B_{RFI} is the RFI at the highest concentration with $RFI < 150$ (CD86) or 200 (CD54)

For the purpose of more precisely deriving the EC150 and EC200 values, three independent runs for *CD86/CD54 expression measurement* may be required. The final EC150 and EC200 values are then determined as the median value of the ECs calculated from the three independent runs. When only two of three independent runs meet the criteria for positivity (see paragraphs 26-27), the higher EC150 or EC200 of the two calculated values is adopted.

Acceptance criteria

29. The following acceptance criteria should be met when using the h-CLAT method (22) (27).
- The cell viabilities of medium and solvent/vehicle controls should be higher than 90 %.
 - In the solvent/vehicle control, RFI values of both CD86 and CD54 should not exceed the positive criteria (CD86 RFI 150 % and CD54 RFI 200 %). RFI values of the solvent/vehicle control are calculated by using the formula described in paragraph 25 ('MFI of chemical' should be replaced with 'MFI of solvent/vehicle', and 'MFI of solvent/vehicle' should be replaced with 'MFI of (medium) control').
 - For both medium and solvent/vehicle controls, the MFI ratio of both CD86 and CD54 to isotype control should be $> 105\ %$.
 - In the positive control (DNCB), RFI values of both CD86 and CD54 should meet the positive criteria (CD86 RFI 150 and CD54 RFI 200) and cell viability should be more than 50 %.
 - For the test chemical, the cell viability should be more than 50 % in at least four tested concentrations in each run.
30. Negative results are acceptable only for test chemicals exhibiting a cell viability of less than 90 % at the highest concentration tested (i.e. $1,2 \times CV75$ according to the serial dilution scheme described in paragraph 20). If the cell viability at $1,2 \times CV75$ is equal or above 90 % the negative result should be discarded. In such a case it is recommended to try to refine the dose selection by repeating the CV75 determination. It should be noted that when 5 000 $\mu\text{g/ml}$ in saline (or medium or other solvents/vehicles), 1 000 $\mu\text{g/ml}$ in DMSO or the highest soluble concentration is used as the maximal test concentration of a test chemical, a negative result is acceptable even if the cell viability is above 90 %.

▼M8**Test report**

31. The test report should include the following information.

Test chemical

Mono-constituent substance

- Chemical identification, such as IUPAC or CAS name(s), CAS number(s), SMILES or InChI code, structural formula, and/or other identifiers;
- Physical appearance, Log K_{ow}, water solubility, DMSO solubility, molecular weight, and additional relevant physicochemical properties, to the extent available;
- Purity, chemical identity of impurities as appropriate and practically feasible, etc.;
- Treatment prior to testing, if applicable (e.g. warming, grinding);
- Concentration(s) tested;
- Storage conditions and stability to the extent available;
- Justification for choice of solvent/vehicle for each test chemical.

Multi-constituent substance, UVCB and mixture

- Characterisation as far as possible by e.g. chemical identity (see above), purity, quantitative occurrence and relevant physicochemical properties (see above) of the constituents, to the extent available;
- Physical appearance, water solubility, DMSO solubility and additional relevant physicochemical properties, to the extent available;
- Molecular weight or apparent molecular weight in case of mixtures/polymers of known compositions or other information relevant for the conduct of the study;
- Treatment prior to testing, if applicable (e.g. warming, grinding);
- Concentration(s) tested;
- Storage conditions and stability to the extent available;
- Justification for choice of solvent/vehicle for each test chemical.

Controls

Positive control

- Chemical identification, such as IUPAC or CAS name(s), CAS number(s), SMILES or InChI code, structural formula, and/or other identifiers;
- Physical appearance, Log K_{ow}, water solubility, DMSO solubility, molecular weight, and additional relevant physicochemical properties, to the extent available and where applicable;
- Purity, chemical identity of impurities as appropriate and practically feasible, etc.;

▼M8

- Treatment prior to testing, if applicable (e.g. warming, grinding);
- Concentration(s) tested;
- Storage conditions and stability to the extent available;
- Reference to historical positive control results demonstrating suitable run acceptance criteria, if applicable.

Negative and solvent/vehicle control

- Chemical identification, such as IUPAC or CAS name(s), CAS number(s), SMILES or InChI code, structural formula, and/or other identifiers;
- Purity, chemical identity of impurities as appropriate and practically feasible, etc.;
- Physical appearance, molecular weight, and additional relevant physico-chemical properties in the case other control solvent/vehicle than those mentioned in the Test Guideline are used and to the extent available;
- Storage conditions and stability to the extent available;
- Justification for choice of solvent/vehicle for each test chemical.

Test conditions

- Name and address of the sponsor, test facility and study director;
- Description of test used;
- Cell line used, its storage conditions and source (e.g. the facility from which they were obtained);
- Flow cytometry used (e.g. model), including instrument settings, globulin, antibodies and cytotoxicity marker used;
- The procedure used to demonstrate proficiency of the laboratory in performing the test by testing of proficiency substances, and the procedure used to demonstrate reproducible performance of the test over time, e.g. historical control data and/or historical reactivity checks' data.

Test acceptance criteria

- Cell viability, MFI and RFI values obtained with the solvent/vehicle control in comparison to the acceptance ranges;
- Cell viability and RFI values obtained with the positive control in comparison to the acceptance ranges;
- Cell viability of all tested concentrations of the tested chemical.

▼M8*Test procedure*

- Number of runs used;
- Test chemical concentrations, application and exposure time used (if different than the one recommended)
- Description of evaluation and decision criteria used;
- Description of any modifications of the test procedure.

Results

- Tabulation of the data, including CV75 (if applicable), individual geometric MFI, RFI, cell viability values, EC150/EC200 values (if applicable) obtained for the test chemical and for the positive control in each run, and an indication of the rating of the test chemical according to the prediction model;
- Description of any other relevant observations, if applicable.

Discussion of the results

- Discussion of the results obtained with the h-CLAT method;
- Consideration of the test results within the context of an IATA, if other relevant information is available.

*Conclusions***LITERATURE**

- (1) Ashikaga T, Yoshida Y, Hirota M, Yoneyama K, Itagaki H, Sakaguchi H, Miyazawa M, Ito Y, Suzuki H, Toyoda H. (2006). Development of an *in vitro* skin sensitization test using human cell lines: The human Cell Line Activation Test (h-CLAT) I. Optimization of the h-CLAT protocol. *Toxicol. In Vitro* 20, 767–773.
- (2) Miyazawa M, Ito Y, Yoshida Y, Sakaguchi H, Suzuki H. (2007). Phenotypic alterations and cytokine production in THP-1 cells in response to allergens. *Toxicol. In Vitro* 21, 428-437.
- (3) EC EURL-ECVAM (2013). Recommendation on the human Cell Line Activation Test (h-CLAT) for skin sensitisation testing. Accessible at: <https://eurl-ecvam.jrc.ec.europa.eu/eurl-ecvam-recommendations>
- (4) Takenouchi O, Fukui S, Okamoto K, Kurotani S, Imai N, Fujishiro M, Kyotani D, Kato Y, Kasahara T, Fujita M, Toyoda A, Sekiya D, Watanabe S, Seto H, Hirota M, Ashikaga T, Miyazawa M. (2015). Test battery with the human cell line activation test, direct peptide reactivity assay and DEREK based on a 139 chemical data set for predicting skin sensitizing potential and potency of chemicals. *J Appl Toxicol.* 35, 1318-1332.
- (5) Hirota M, Fukui S, Okamoto K, Kurotani S, Imai N, Fujishiro M, Kyotani D, Kato Y, Kasahara T, Fujita M, Toyoda A, Sekiya D, Watanabe S, Seto H, Takenouchi O, Ashikaga T, Miyazawa M. (2015). Evaluation of combinations of *in vitro* sensitization test descriptors for the artificial neural network-based risk assessment model of skin sensitization. *J Appl Toxicol.* 35, 1333-1347.
- (6) Bauch C, Kolle SN, Ramirez T, Fabian E, Mehling A, Teubner W, van Ravenzwaay B, Landsiedel R. (2012). Putting the parts together: combining *in vitro* methods to test for skin sensitizing potentials. *Regul Toxicol Pharmacol.* 63, 489-504.

▼ **M8**

- (7) Van der Veen JW, Rorije E, Emter R, Natch A, van Loveren H, Ezendam J. (2014). Evaluating the performance of integrated approaches for hazard identification of skin sensitizing chemicals. *Regul Toxicol Pharmacol.* 69, 371-379.
- (8) Urbisch D, Mehling A, Guth K, Ramirez T, Honarvar N, Kolle S, Landsiedel R, Jaworska J, Kern PS, Gerberick F, Natsch A, Emter R, Ashikaga T, Miyazawa M, Sakaguchi H. (2015). Assessing skin sensitization hazard in mice and men using non-animal test methods. *Regul Toxicol Pharmacol.* 71, 337-351.
- (9) Jaworska JS, Natsch A, Ryan C, Strickland J, Ashikaga T, Miyazawa M. (2015). Bayesian integrated testing strategy (ITS) for skin sensitization potency assessment: a decision support system for quantitative weight of evidence and adaptive testing strategy. *Arch Toxicol.* 89, 2355-2383.
- (10) Strickland J, Zang Q, Kleinstreuer N, Paris M, Lehmann DM, Choksi N, Matheson J, Jacobs A, Lowit A, Allen D, Casey W. (2016). Integrated decision strategies for skin sensitization hazard. *J Appl Toxicol.* DOI 10.1002/jat.3281.
- (11) Nukada Y, Ashikaga T, Miyazawa M, Hirota M, Sakaguchi H, Sasa H, Nishiyama N. (2012). Prediction of skin sensitization potency of chemicals by human Cell Line Activation Test (h-CLAT) and an attempt at classifying skin sensitization potency. *Toxicol. In Vitro* 26, 1150-60.
- (12) EC EURL ECVAM (2015). Re-analysis of the within and between laboratory reproducibility of the human Cell Line Activation Test (h-CLAT). Accessible at: <https://eurl-ecvam.jrc.ec.europa.eu/eurl-ecvam-recommendations/eurl-ecvam-recommendation-on-the-human-cell-line-activation-test-h-clat-for-skin-sensitisation-testing>
- (13) EC EURL ECVAM (2012). human Cell Line Activation Test (h-CLAT) Validation Study Report Accessible at: <https://eurl-ecvam.jrc.ec.europa.eu/eurl-ecvam-recommendations>
- (14) Takenouchi O, Miyazawa M, Saito K, Ashikaga T, Sakaguchi H. (2013). Predictive performance of the human Cell Line Activation Test (h-CLAT) for lipophilic with high octanol-water partition coefficients. *J. Toxicol. Sci.* 38, 599-609.
- (15) Ashikaga T, Sakaguchi H, Sono S, Kosaka N, Ishikawa M, Nukada Y, Miyazawa M, Ito Y, Nishiyama N, Itagaki H. (2010). A comparative evaluation of *in vitro* skin sensitisation tests: the human cell-line activation test (h-CLAT) versus the local lymph node assay (LLNA). *Altern. Lab. Anim.* 38, 275-284.
- (16) Fabian E., Vogel D., Blatz V., Ramirez T., Kolle S., Eltze T., van Ravenzwaay B., Oesch F., Landsiedel R. (2013). Xenobiotic metabolizing enzyme activities in cells used for testing skin sensitization *in vitro*. *Arch Toxicol* 87, 1683-1969.
- (17) Okamoto K, Kato Y, Kosaka N, Mizuno M, Inaba H, Sono S, Ashikaga T, Nakamura T, Okamoto Y, Sakaguchi H, Kishi M, Kuwahara H, Ohno Y. (2010). The Japanese ring study of a human Cell Line Activation Test (h-CLAT) for predicting skin sensitization potential (6th report): A study for evaluating oxidative hair dye sensitization potential using h-CLAT. *AATEX* 15, 81-88.
- (18) DB-ALM (INVITTOX) (2014). Protocol 158: human Cell Line Activation Test (h-CLAT), 23pp. Accessible at: <http://ecvam-dbal.m.jrc.ec.europa.eu/>

▼M8

- (19) Mizuno M, Yoshida M, Kodama T, Kosaka N, Okamoto K, Sono S, Yamada T, Hasegawa S, Ashikaga T, Kuwahara H, Sakaguchi H, Sato J, Ota N, Okamoto Y, Ohno Y. (2008). Effects of pre-culture conditions on the human Cell Line Activation Test (h-CLAT) results; Results of the 4th Japanese inter-laboratory study. AATEX 13, 70-82.
- (20) Sono S, Mizuno M, Kosaka N, Okamoto K, Kato Y, Inaba H,, Nakamura T, Kishi M, Kuwahara H, Sakaguchi H, Okamoto Y, Ashikaga T, Ohno Y. (2010). The Japanese ring study of a human Cell Line Activation Test (h-CLAT) for predicting skin sensitization potential (7th report): Evaluation of volatile, poorly soluble fragrance materials. AATEX 15, 89-96.
- (21) OECD (2005). Guidance Document No 34 on The Validation and International Acceptance of New or Updated Test Methods for Hazard Assessment. OECD Series on Testing and Assessment. Organization for Economic Cooperation and Development, Paris, France, 2005, 96 pp.
- (22) OECD (2012). The Adverse Outcome Pathway for Skin Sensitisation Initiated by Covalent Binding to Proteins. Part 1: Scientific Evidence. Series on Testing and Assessment No 168. Available at: [http://www.oecd.org/officialdocuments/publicdisplaydocumentpdf/?cote=ENV/JM/MONO\(2012\)10/PART1&docLanguage=En](http://www.oecd.org/officialdocuments/publicdisplaydocumentpdf/?cote=ENV/JM/MONO(2012)10/PART1&docLanguage=En)
- (23) United Nations UN (2013). Globally Harmonized System of Classification and Labelling of Chemicals (GHS). Fifth revised edition. New York & Geneva: United Nations Publications. ISBN: 978-92-1-117006-1. Available at: http://www.unece.org/trans/danger/publi/ghs/ghs_rev05/05files_e.html
- (24) ECETOC (2003). Contact sensitization: Classification according to potency. European Centre for Ecotoxicology & Toxicology of Chemicals (Technical Report No 87).
- (25) Ashikaga T, Sakaguchi H, Okamoto K, Mizuno M, Sato J, Yamada T, Yoshida M, Ota N, Hasegawa S, Kodama T, Okamoto Y, Kuwahara H, Kosaka N, Sono S, Ohno Y. (2008). Assessment of the human Cell Line Activation Test (h-CLAT) for Skin Sensitization; Results of the First Japanese Inter-laboratory Study. AATEX 13, 27-35.

▼M8*Appendix 1.1*

DEFINITIONS

Accuracy: The closeness of agreement between test results and accepted reference values. It is a measure of test performance and one aspect of relevance. The term is often used interchangeably with concordance to mean the proportion of correct outcomes of a test (21).

AOP (Adverse Outcome Pathway): sequence of events from the chemical structure of a target chemical or group of similar chemicals through the molecular initiating event to an *in vivo* outcome of interest (22).

Chemical: A substance or a mixture.

CV75: The estimated concentration showing 75 % cell viability.

EC150: the concentrations showing the RFI values of 150 in CD86 expression

EC200: the concentrations showing the RFI values of 200 in CD54 expression

Flow cytometry: a cytometric technique in which cells suspended in a fluid flow one at a time through a focus of exciting light, which is scattered in patterns characteristic to the cells and their components; cells are frequently labeled with fluorescent markers so that light is first absorbed and then emitted at altered frequencies.

Hazard: Inherent property of an agent or situation having the potential to cause adverse effects when an organism, system or (sub) population is exposed to that agent.

IATA (Integrated Approach to Testing and Assessment): A structured approach used for hazard identification (potential), hazard characterisation (potency) and/or safety assessment (potential/potency and exposure) of a chemical or group of chemicals, which strategically integrates and weights all relevant data to inform regulatory decision regarding potential hazard and/or risk and/or the need for further targeted and therefore minimal testing.

Medium control: An untreated replicate containing all components of a test system. This sample is processed with test chemical-treated samples and other control samples to determine whether the solvent/vehicle interacts with the test system.

Mixture: A mixture or a solution composed of two or more substances.

Mono-constituent substance: A substance, defined by its quantitative composition, in which one main constituent is present to at least 80 % (w/w).

Multi-constituent substance: A substance, defined by its quantitative composition, in which more than one main constituent is present in a concentration ≥ 10 % (w/w) and < 80 % (w/w). A multi-constituent substance is the result of a manufacturing process. The difference between mixture and multi-constituent substance is that a mixture is obtained by blending of two or more substances without chemical reaction. A multi-constituent substance is the result of a chemical reaction.

▼ M8

Positive control: A replicate containing all components of a test system and treated with a substance known to induce a positive response. To ensure that variability in the positive control response across time can be assessed, the magnitude of the positive response should not be excessive.

Pre-haptens: chemicals which become sensitisers through abiotic transformation

Pro-haptens: chemicals requiring enzymatic activation to exert skin sensitisation potential

Relative fluorescence intensity (RFI): Relative values of geometric mean fluorescence intensity (MFI) in chemical-treated cells compared to MFI in solvent/vehicle-treated cells.

Relevance: Description of relationship of the test to the effect of interest and whether it is meaningful and useful for a particular purpose. It is the extent to which the test correctly measures or predicts the biological effect of interest. Relevance incorporates consideration of the accuracy (concordance) of a test (21).

Reliability: Measures of the extent that a test can be performed reproducibly within and between laboratories over time, when performed using the same protocol. It is assessed by calculating intra- and inter-laboratory reproducibility and intra-laboratory repeatability (21).

Run: A run consists of one or more test chemicals tested concurrently with a solvent/vehicle control and with a positive control.

Sensitivity: The proportion of all positive/active chemicals that are correctly classified by the test. It is a measure of accuracy for a test that produces categorical results, and is an important consideration in assessing the relevance of a test(21).

Staining buffer: A phosphate buffered saline containing 0,1 % bovine serum albumin.

Solvent/vehicle control: An untreated sample containing all components of a test system except of the test chemical, but including the solvent/vehicle that is used. It is used to establish the baseline response for the samples treated with the test chemical dissolved or stably dispersed in the same solvent/vehicle. When tested with a concurrent medium control, this sample also demonstrates whether the solvent/vehicle interacts with the test system.

Specificity: The proportion of all negative/inactive chemicals that are correctly classified by the test. It is a measure of accuracy for a test that produces categorical results and is an important consideration in assessing the relevance of a test (21).

Substance: A chemical element and its compounds in the natural state or obtained by any production process, including any additive necessary to preserve its stability and any impurities deriving from the process used, but excluding any solvent which may be separated without affecting the stability of the substance or changing its composition.

Test chemical: Any substance or mixture tested using this method.

▼M8

United Nations Globally Harmonized System of Classification and Labelling of Chemicals (UN GHS): A system proposing the classification of chemicals (substances and mixtures) according to standardised types and levels of physical, health and environmental hazards, and addressing corresponding communication elements, such as pictograms, signal words, hazard statements, precautionary statements and safety data sheets, so that to convey information on their adverse effects with a view to protect people (including employers, workers, transporters, consumers and emergency responders) and the environment (23).

UVCB: substances of unknown or variable composition, complex reaction products or biological materials.

Valid test: A test considered to have sufficient relevance and reliability for a specific purpose and which is based on scientifically sound principles. A test is never valid in an absolute sense, but only in relation to a defined purpose (21).

▼M8

Appendix 1.2

PROFICIENCY SUBSTANCES

Prior to routine use of the test described in this Appendix to test method B.71, laboratories should demonstrate technical proficiency by correctly obtaining the expected h-CLAT prediction for the 10 substances recommended in Table 1 and by obtaining CV75, EC150 and EC200 values that fall within the respective reference range for at least 8 out of the 10 proficiency substances. Proficiency substances were selected to represent the range of responses for skin sensitisation hazards. Other selection criteria were that the substances are commercially available, and that high-quality *in vivo* reference data as well as high quality *in vitro* data generated with the h-CLAT method are available. Also, published reference data are available for the h-CLAT method (3) (14).

Table 1

Recommended substances for demonstrating technical proficiency with the h-CLAT method

Proficiency substances	CASRN	Physical state	<i>In vivo</i> prediction ⁽¹⁾	CV75 Reference Range in µg/ml ⁽²⁾	h-CLAT results for CD86 (EC150 Reference Range in µg/ml) ⁽²⁾	h-CLAT results for CD54 (EC200 Reference Range in µg/ml) ⁽²⁾
2,4-Dinitrochlorobenzene	97-00-7	Solid	Sensitiser(extreme)	2-12	Positive(0.5-10)	Positive(0.5-15)
4-Phenylenediamine	106-50-3	Solid	Sensitiser(strong)	5-95	Positive(<40)	Negative(>1,5) ⁽³⁾
Nickel sulfate	10101-97-0	Solid	Sensitiser(moderate)	30-500	Positive(<100)	Positive(10-100)
2-Mercaptbenzothiazole	149-30-4	Solid	Sensitiser(moderate)	30-400	Negative(>10) ⁽³⁾	Positive(10-140)
R(+)-Limonene	5989-27-5	Liquid	Sensitiser(weak)	>20	Negative(>5) ⁽³⁾	Positive(<250)
Imidazolidinyl urea	39236-46-9	Solid	Sensitiser(weak)	25-100	Positive(20-90)	Positive(20-75)
Isopropanol	67-63-0	Liquid	Non-sensitiser	>5000	Negative(>5000)	Negative(>5000)
Glycerol	56-81-5	Liquid	Non-sensitiser	>5000	Negative(>5000)	Negative(>5000)
Lactic acid	50-21-5	Liquid	Non-sensitiser	1500-5000	Negative(>5000)	Negative(>5000)
4-Aminobenzoic acid	150-13-0	Solid	Non-sensitiser	>1000	Negative(>1000)	Negative(>1000)

Abbreviations: CAS RN = Chemical Abstracts Service Registry Number

⁽¹⁾ The *in vivo* hazard (and potency) prediction is based on LLNA data (3) (14). The *in vivo* potency is derived using the criteria proposed by ECETOC (24).

⁽²⁾ Based on historical observed values (13) (25).

⁽³⁾ Historically, a majority of negative results have been obtained for this marker and therefore a negative result is mostly expected. The range provided was defined on the basis of the few historical positive results observed. In case a positive result is obtained, the EC value should be within the reported reference range.

▼ M8*Appendix 2**IN VITRO* SKIN SENSITISATION: U937 CELL LINE ACTIVATION TEST (U-SENS™)

INITIAL CONSIDERATIONS AND LIMITATIONS

1. The U-SENS™ test quantifies the change in the expression of a cell surface marker associated with the process of activation of monocytes and dendritic cells (DC) (i.e. CD86), in the human histiocytic lymphoma cell line U937, following exposure to sensitisers (1). The measured expression levels of CD86 cell surface marker in the cell line U937 is then used for supporting the discrimination between skin sensitisers and non-sensitisers.
2. The U-SENS™ test has been evaluated in a validation study (2) coordinated by L’Oreal and subsequently independent peer reviewed by the European Union Reference Laboratory for Alternatives to Animal Testing (EURL ECVAM) Scientific Advisory Committee (ESAC) (3). Considering all available evidence and input from regulators and stakeholders, the U-SENS™ was recommended by EURL ECVAM (4) to be used as part of an IATA to support the discrimination between sensitisers and non-sensitisers for the purpose of hazard classification and labelling. In its guidance document on the reporting of structured approaches to data integration and individual information sources used within IATA for skin sensitisation, the OECD currently discusses a number of case studies describing different testing strategies and prediction models. One of the different defined approaches is based on the U-SENS assay (5). Examples of the use of U-SENS™ data in combination with other information, including historical data and existing valid human data (6), are also reported elsewhere in the literature (4) (5) (7).
3. The U-SENS™ test proved to be transferable to laboratories experienced in cell culture techniques and flow cytometry analysis. The level of reproducibility in predictions that can be expected from the test is in the order of 90 % and 84 % within and between laboratories, respectively (8). Results generated in the validation study (8) and other published studies (1) overall indicate that, compared with LLNA results, the accuracy in distinguishing skin sensitisers (i.e. UN GHS/CLP Cat.1) from non-sensitisers is 86 % (N=166) with a sensitivity of 91 % (118/129) and a specificity of 65 % (24/37). Compared with human results, the accuracy in distinguishing skin sensitisers (i.e. UN GHS/CLP Cat.1) from non-sensitisers is 77 % (N=101) with a sensitivity of 100 % (58/58) and a specificity of 47 % (20/43). False negative predictions compared to LLNA with the U-SENS™ are more likely to concern chemicals showing a low to moderate skin sensitisation potency (i.e. UN GHS/CLP subcategory 1B) than chemicals showing a high skin sensitisation potency (i.e. UN GHS/CLP subcategory 1A) (1) (8) (9). Taken together, this information indicates the usefulness of the U-SENS™ test to contribute to the identification of skin sensitisation hazards. However, the accuracy values given here for the U-SENS™ as a stand-alone test are only indicative, since the test should be considered in combination with other sources of information in the context of an IATA and in accordance with the provisions of paragraphs 7 and 8 in the General introduction. Furthermore, when evaluating non-animal methods for skin sensitisation, it should be kept in mind that the LLNA test as well as other animal tests may not fully reflect the situation in humans.

▼M8

4. On the basis of the data currently available, the U-SENS™ test was shown to be applicable to test chemicals (including cosmetics ingredients e.g. preservatives, surfactants, actives, dyes) covering a variety of organic functional groups, of physicochemical properties, skin sensitisation potency (as determined in *in vivo* studies) and the spectrum of reaction mechanisms known to be associated with skin sensitisation (i.e. Michael acceptor, Schiff base formation, acyl transfer agent, substitution nucleophilic bi-molecular [SN₂], or nucleophilic aromatic substitution [S_NAr]) (1) (8) (9) (10). The U-SENS™ test is applicable to test chemicals that are soluble or that form a stable dispersion (i.e. a colloid or suspension in which the test chemical does not settle or separate from the solvent/vehicle into different phases) in an appropriate solvent/vehicle (see paragraph 13). Chemicals in the dataset reported to be pre-haptens (i.e. substances activated by oxidation) or pro-haptens (i.e. substances requiring enzymatic activation for example via P450 enzymes) were correctly predicted by the U-SENS™ (1) (10). Membrane disrupting substances can lead to false positive results due to a non-specific increase of CD86 expression, as 3 out of 7 false positives relative to the *in vivo* reference classification were surfactants (1). As such positive results with surfactants should be considered with caution whereas negative results with surfactants could still be used to support the identification of the test chemical as a non-sensitiser. Fluorescent test chemicals can be assessed with the U-SENS™ (1), nevertheless, strong fluorescent test chemicals emitting at the same wavelength as fluorescein isothiocyanate (FITC) or as propidium iodide (PI), will interfere with the flow cytometric detection and thus cannot be correctly evaluated using FITC-conjugated antibodies (potential false negative) or PI (viability not measurable). In such a case, other fluorochrome-tagged antibodies or other cytotoxicity markers, respectively, can be used as long as it can be shown they provide similar results as the FITC-tagged antibodies or PI (see paragraph 18) e.g. by testing the proficiency substances in Appendix 2.2. In the light of the above, positive results with surfactants and negative results with strong fluorescent test chemicals should be interpreted in the context of the stated limitations and together with other information sources within the framework of IATA. In cases where there is evidence demonstrating the non-applicability of the U-SENS™ test to other specific categories of test chemicals, it should not be used for those specific categories.
5. As described above, the U-SENS™ test supports the discrimination between skin sensitisers from non-sensitisers. However, it may also potentially contribute to the assessment of sensitising potency when used in integrated approaches such as IATA. Nevertheless, further work, preferably based on human data, is required to determine how U-SENS™ results may possibly inform potency assessment.
6. Definitions are provided in Appendix 2.1.

PRINCIPLE OF THE TEST

7. The U-SENS™ test is an *in vitro* assay that quantifies changes of CD86 cell surface marker expression on a human histiocytic lymphoma cell line, U937 cells, following 45±3 hours exposure to the test chemical. The CD86 surface marker is one typical marker of U937 activation. CD86 is known to be a co-stimulatory molecule that may mimic monocytic activation, which plays a critical role in T-cell priming. The changes of CD86 cell surface marker expression are measured by flow cytometry following cell staining typically with fluorescein isothiocyanate (FITC)-labelled antibodies. Cytotoxicity measurement is also conducted (e.g. by using PI) concurrently to

▼M8

assess whether upregulation of CD86 cell surface marker expression occurs at sub-cytotoxic concentrations. The stimulation index (S.I.) of CD86 cell surface marker compared to solvent/vehicle control is calculated and used in the prediction model (see paragraph 19), to support the discrimination between sensitisers and non-sensitisers.

DEMONSTRATION OF PROFICIENCY

8. Prior to routine use of the test described in this Appendix to test method B.71, laboratories should demonstrate technical proficiency, using the 10 Proficiency Substances listed in Appendix 2.2 in compliance with the Good *in vitro* Method Practices (11). Moreover, test users should maintain a historical database of data generated with the reactivity checks (see paragraph 11) and with the positive and solvent/vehicle controls (see paragraphs 15-16), and use these data to confirm the reproducibility of the test in their laboratory is maintained over time.

PROCEDURE

9. This test is based on the U-SENS™ DataBase service on ALternative Methods to animal experimentation (DB-ALM) protocol no 183 (12). The Standard Operating Procedures (SOP) should be employed when implementing and using the U-SENS™ test in the laboratory. An automated system to run the U-SENS™ can be used if it can be shown to provide similar results, for example by testing the proficiency substances in Appendix 2.2. The following is a description of the main components and procedures for the U-SENS™ test.

Preparation of cells

10. The human histiocytic lymphoma cell line, U937 (13) should be used for performing the U-SENS™ test. Cells (clone CRL1593.2) should be obtained from a well-qualified cell bank such as the American Type Culture Collection.
11. U937 cells are cultured, at 37 °C under 5 % CO₂ and humidified atmosphere, in RPMI-1 640 medium supplemented with 10 % foetal calf serum (FCS), 2 mM L-glutamine, 100 units/ml penicillin and 100 µg/ml streptomycin (complete medium). U937 cells are routinely passaged every 2-3 days at the density of 1,5 or 3 × 10⁵ cells/ml, respectively. The cell density should not exceed 2 × 10⁶ cells/ml and the cell viability measured by trypan blue exclusion should be ≥ 90 % (not to be applied at the first passage after thawing). Prior to using them for testing, every batch of cells, FCS or antibodies should be qualified by conducting a reactivity check. The reactivity check of the cells should be performed using the positive control, picrylsulfonic acid (2,4,6-Trinitro-benzene-sulfonic acid: TNBS) (CASRN 2 508-19-2, ≥ 99 % purity) and the negative control lactic acid (LA) (CASRN 50-21-5, ≥ 85 % purity), at least one week after thawing. For the reactivity check, six final concentrations should be tested for each of the 2 controls (TNBS: 1, 12.5, 25, 50, 75, 100µg/ml and LA: 1, 10, 20, 50, 100, 200µg/ml). TNBS solubilised in complete medium should produce a positive and concentration-related response of CD86 (e.g. when a positive concentration, CD86 S.I. ≥ 150, is followed by a concentration with an increasing CD86 S.I.), and LA solubilised in complete medium should produce negative response of CD86 (see paragraph 21). Only the batch of cells which passed the reactivity check 2 times should be used for the assay. Cells can be propagated up to seven weeks after thawing. Passage number should not exceed 21. The reactivity check should be performed according to the procedures described in paragraphs 18-22.

▼M8

12. For testing, U937 cells are seeded at a density of either 3×10^5 cells/ml or 6×10^5 cells/ml, and pre-cultured in culture flasks for 2 days or 1 day, respectively. Other pre-cultured conditions than those described above may be used if sufficient scientific rationale is provided and if it can be shown to provide similar results, for example by testing the proficiency substances in Appendix 2.2. In the day of testing, cells harvested from culture flask are resuspended with fresh culture medium at 5×10^5 cells/ml. Then, cells are distributed into a 96-well flat-bottom plate with 100 μ l (final cell density of $0,5 \times 10^5$ cells/well).

Preparation of test chemicals and control substances

13. Assessment of solubility is conducted prior to testing. For this purpose, test chemicals are dissolved or stably dispersed at a concentration of 50 mg/ml in complete medium as first solvent option or dimethyl sulfoxide (DMSO, 99 % purity) as a second solvent/vehicle option if the test chemical is not soluble in the complete medium solvent/vehicle. For the testing, the test chemical is dissolved to a final concentration of 0,4 mg/ml in complete medium if the chemical is soluble in this solvent/vehicle. If the chemical is soluble only in DMSO, the chemical is dissolved at a concentration of 50 mg/ml. Other solvents/vehicles than those described above may be used if sufficient scientific rationale is provided. Stability of the test chemical in the final solvent/vehicle should be taken into account.

14. The test chemicals and control substances are prepared on the day of testing. Because a dose finding assay is not conducted, for the first run, 6 final concentrations should be tested (1, 10, 20, 50, 100 and 200 μ g/ml) into the corresponding solvent/vehicle either in complete medium or in 0,4 % DMSO in medium. For the subsequent runs, starting from the 0,4 mg/ml in complete medium or 50 mg/ml in DMSO, solutions of the test chemicals, at least 4 working solutions (i.e. at least 4 concentrations), are prepared using the corresponding solvent/vehicle. The working solutions are finally used for treatment by adding an equal volume of U937 cell suspension (see paragraph 11 above) to the volume of working solution in the plate to achieve a further 2-fold dilution (12). The concentrations (at least 4 concentrations) for any further run are chosen based on the individual results of all previous runs (8). The usable final concentrations are 1, 2, 3, 4, 5, 7.5, 10, 12.5, 15, 20, 25, 30, 35, 40, 45, 50, 60, 70, 80, 90, 100, 120, 140, 160, 180 and 200 μ g/ml. The maximum final concentration is 200 μ g/ml. In the case of a CD86 positive value at 1 μ g/ml is observed, then 0,1 μ g/ml is evaluated in order to find the concentration of the test chemical that doesnot induce CD86 above the positive threshold. For each run, the EC150 (concentration at which a chemical reaches the CD86 positive threshold of 150 %, see paragraph 19) is calculated if a CD86 positive concentration-response is observed. Where the test chemical induces a positive CD86 response not concentration related, the calculation of the EC150 might not be relevant as described in the U-SENS™ DB-ALM protocol no 183 (12). For each run, CV70 (concentration at which a chemical reaches the cytotoxicity threshold of 70 %, see paragraph 19) is calculated whenever possible (12). To investigate the concentration response effect of CD86 increase, any concentrations from the usable concentrations should be chosen evenly spread between the EC150 (or the highest CD86 negative non cytotoxic concentration) and the CV70 (or the highest concentration allowed i.e. 200 μ g/ml). A minimum of 4 concentrations should be tested per run with at least 2 concentrations being common with the previous run(s), for comparison purposes.

▼ M8

15. The solvent/vehicle control used in the U-SENS™ test is complete medium (for test chemicals solubilised or stably dispersed in complete medium) (see paragraph 4) or 0,4 % DMSO in complete medium (for test chemicals solubilised or stably dispersed in DMSO).

16. The positive control used in the U-SENS™ test is TNBS (see paragraph 11), prepared in complete medium. TNBS should be used as the positive control for CD86 expression measurement at a final single concentration in plate (50 µg/ml) yielding > 70 % of cell viability. To obtain a 50 µg/ml concentration of TNBS in plate, a 1 M (i.e. 293 mg/ml) stock solution of TNBS in complete medium is prepared and further diluted 2 930-fold with complete medium to a 100 µg/ml working solution. Lactic acid (LA, CAS 50-21-5) should be used as the negative control at 200 µg/ml solubilised in complete medium (from a 0,4 mg/ml stock solution). In each plate of each run, three replicates of complete medium untreated control, solvent/vehicle control, negative and positive controls are prepared (12). Other suitable positive controls may be used if historical data are available to derive comparable run acceptance criteria. The run acceptance criteria are the same as described for the test chemical (see paragraph 12).

Application of test chemicals and control substances

17. The solvent/vehicle control or working solutions described in paragraphs 14-16 are mixed 1:1 (v/v) with the cell suspensions prepared in the 96-well flat-bottom plate (see paragraph 12). The treated plates are then incubated for 45±3 hours at 37 °C under 5 % CO₂. Prior to incubation, plates are sealed with semi permeable membrane, to avoid evaporation of volatile test chemicals and cross-contamination between cells treated with test chemicals (12).

Cell staining

18. After 45±3 hours of exposure, cells are transferred into V-shaped microtiter plate and collected by centrifugation. Solubility interference is defined as crystals or drops observed under the microscope at 45 ± 3 hours post treatment (before the cell staining). The supernatants are discarded and the remaining cells are washed once with 100 µl of an ice-cold phosphate buffered saline (PBS) containing 5 % foetal calf serum (staining buffer). After centrifugation, cells are re-suspended with 100 µl of staining buffer and stained with 5 µl (e.g. 0,25 µg) of FITC-labelled anti-CD86 or mouse IgG1 (isotype) antibodies at 4 °C for 30 min protected from light. The antibodies described in the U-SENS™ DB-ALM protocol no 183 (12) should be used (for CD86: BD-PharMingen #5556 57 Clone: Fun-1, or Caltag/Invitrogen # MHCD8601 Clone: BU63; and for IgG1: BD-PharMingen #5557 48, or Caltag/Invitrogen # GM4992). Based on the experience of the test developers, the fluorescence intensity of the antibodies is usually consistent between different lots. Other clones or supplier of the antibodies which passed the reactivity check may be used for the assay (see paragraph 11). However, users may consider titrating the antibodies in their own laboratory's conditions to define the best concentration for use. Other detection system e.g. fluorochrome-tagged anti-CD86 antibodies may be used if they can be shown to provide similar results as FITC-conjugated antibodies, for

▼ M8

example by testing the proficiency substances in Appendix 2.2. After washing with 100 µl of staining buffer two times and once with 100 µl of an ice-cold PBS, cells are resuspended in ice-cold PBS (e.g. 125 µl for samples being analysed manually tube by tube, or 50 µl using an auto-sampler plate) and PI solution is added (final concentration of 3 µg/ml). Other cytotoxicity markers, such as 7-Aminoactinomycin D (7-AAD) or Trypan blue may be used if the alternative stains can be shown to provide similar results as PI, for example by testing the proficiency substances in Appendix 2.2.

Flow cytometry analysis

19. Expression level of CD86 and cell viability are analysed using flow cytometry. Cells are displayed within a size (FSC) and granularity (SSC) dot plot set to log scale in order to clearly identify the population in a first gate R1 and eliminate the debris. A targeting total of 10 000 cells in gate R1 are acquired for each well. Cells from the same R1 gate are displayed within a FL3 or FL4 / SSC dot plot. Viable cells are delineated by placing a second gate R2 selecting the population of propidium iodide-negative cells (FL3 or FL4 channel). The cell viability can be calculated using the following equation by the cytometer analysis program. When the cell viability is low, up to 20 000 cells including dead cells could be acquired. Alternatively, data can be acquired for one minute after the initiation of the analysis.

$$\text{Cell viability} = \frac{\text{Number of living cells}}{\text{Total Number of aquired cells}} \times 100$$

Percentage of FL1-positive cells is then measured among these viable cells gated on R2 (within R1). Cell surface expression of CD86 is analysed in a FL1 / SSC dot plot gated on viable cells (R2).

For the complete medium / IgG1 wells, the analysis marker is set close to the main population so that the complete medium controls have IgG1 within the target zone of 0,6 to 0,9 %.

Colour interference is defined as a shift of the FITC-labelled IgG1 dot-plot (IgG1 FL1 Geo Mean S.I. \geq 150 %).

The stimulation index (S.I.) of CD86 for controls cells (untreated or in 0,4 % DMSO) and chemical-treated cells are calculated according to the following equation:

$$S.I. = \frac{\% \text{ of } CD86^{+} \text{ treated cells} - \% \text{ of } IgG1^{+} \text{ treated cells}}{\% \text{ of } CD86^{+} \text{ control cells} - \% \text{ of } IgG1^{+} \text{ control cells}} \times 100$$

% of IgG1⁺ untreated control cells: referred to as percentage of FL1-positive IgG1 cells defined with the analysis marker (accepted range of \geq 0,6 % and $<$ 1,5 %, see paragraph 22) among the viable untreated cells.

% of IgG1⁺/CD86⁺ control/treated cells: referred to as percentage of FL1-positive IgG1/CD86 cells measured without moving the analysis marker among the viable control/treated cells.

▼ **M8****DATA AND REPORTING****Data evaluation**

20. The following parameters are calculated in the U-SENS™ test: CV70 value, i.e. a concentration showing 70 % of U937 cell survival (30 % cytotoxicity) and the EC150 value, i.e. the concentration at which the test chemicals induced a CD86 stimulation index (S.I.) of 150 %.

CV70 is calculated by log-linear interpolation using the following equation:

$$CV70 = C1 + [(V1 - 70) / (V1 - V2) * (C2 - C1)]$$

Where:

V1 is the minimum value of cell viability over 70 %

V2 is the maximum value of cell viability below 70 %

C1 and C2 are the concentrations showing the value of cell viability V1 and V2 respectively.

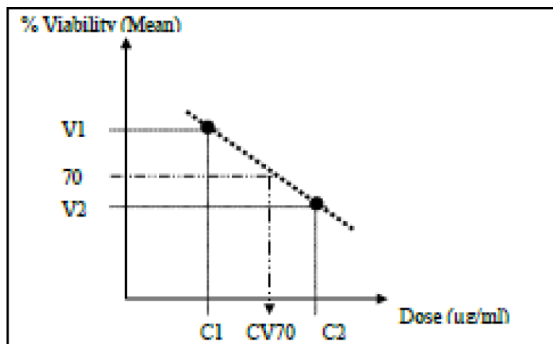

Other approaches to derive the CV70 can be used as long as it is demonstrated that this has no impact on the results (e.g. by testing the proficiency substances).

EC150 is calculated by log-linear interpolation using the following equation:

$$EC150 = C1 + [(150 - S.I.1) / (S.I.2 - S.I.1) * (C2 - C1)]$$

Where:

C1 is the highest concentration in µg/ml with a CD86 S.I. < 150 % (S.I. 1)

C2 is the lowest concentration in µg/ml with a CD86 S.I. ≥ 150 % (S.I. 2).

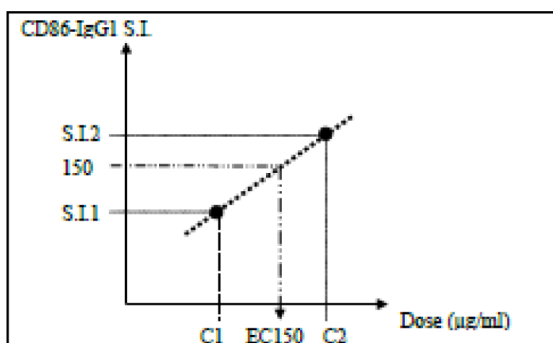

▼M8

The EC150 and CV70 values are calculated

- for each run: the individual EC150 and CV70 values are used as tools to investigate the concentration response effect of CD86 increase (see paragraph 14),
- based on the average viabilities, the overall CV70 is determined (12),
- based on the average S.I. of CD86 values, the overall EC150 is determined for the test chemical predicted as POSITIVE with the U-SENSTM (see paragraph 21) (12).

Prediction model

21. For CD86 expression measurement, each test chemical is tested in at least four concentrations and in at least two independent runs (performed on a different day) to derive a single prediction (NEGATIVE or POSITIVE).

- The individual conclusion of an U-SENSTM run is considered Negative (hereinafter referred to as N) if the S.I. of CD86 is less than 150 % at all non-cytotoxic concentrations (cell viability \geq 70 %) and if no interference is observed (cytotoxicity, solubility: see paragraph 18 or colour: see paragraph 19 regardless of the non-cytotoxic concentrations at which the interference is detected). In all other cases: S.I. of CD86 higher or equal to 150 % and/or interferences observed, the individual conclusion of an U-SENSTM run is considered Positive (hereinafter referred to as P).
- An U-SENSTM prediction is considered NEGATIVE if at least two independent runs are negative (N) (Figure 1). If the first two runs are both negative (N), the U-SENSTM prediction is considered NEGATIVE and a third run does not need to be conducted.
- An U-SENSTM prediction is considered POSITIVE if at least two independent runs are positive (P) (Figure 1). If the first two runs are both positive (P), the U-SENSTM prediction is considered POSITIVE and a third run does not need to be conducted.
- Because a dose finding assay is not conducted, there is an exception if, in the first run, the S.I. of CD86 is higher or equal to 150 % at the highest non-cytotoxic concentration only. The run is then considered to be NOT CONCLUSIVE (NC), and additional concentrations (between the highest non cytotoxicity concentration and the lowest cytotoxicity concentration - see paragraph 20) should be tested in additional runs. In case a run is identified as NC, at least 2 additional runs should be conducted, and a fourth run in case runs 2 and 3 are not concordant (N and/or P independently) (Figure 1). Follow up runs will be considered positive even if only one non cytotoxic concentration gives a CD86 equal or above 150 %, since the concentration setting has been adjusted for the specific test chemical. The final prediction will be based on the majority result of the three or four individual runs (i.e. 2 out of 3 or 2 out of 4) (Figure 1).

▼ M8

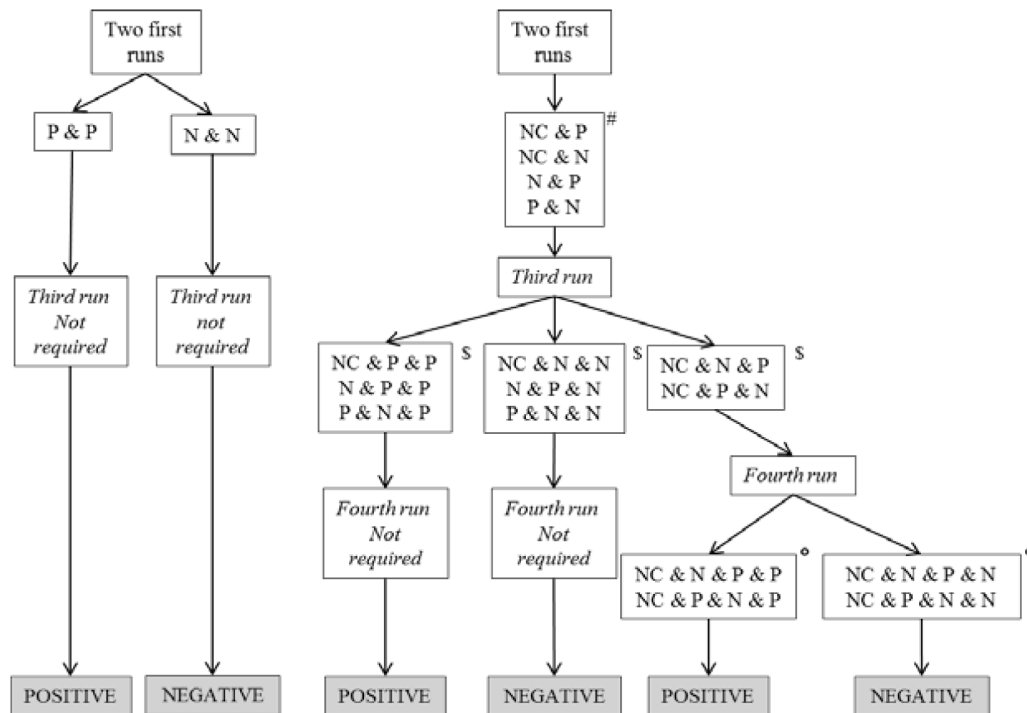

Figure 1: Prediction model used in the U-SENS™ test. An U-SENS™ prediction should be considered in the framework of an IATA and in accordance with the provision of paragraph 4 and of the General introduction paragraphs 7, 8 and 9.

N: Run with no CD86 positive or interference observed;

P: Run with CD86 positive and/or interference(s) observed;

NC: Not Conclusive. First run with No Conclusion when CD86 is positive at the highest non-cytotoxic concentration only;

#: A Not Conclusive (NC) individual conclusion attributed only to the first run conducts automatically to the need of a third run to reach a majority of Positive (P) or Negative (N) conclusions in at least 2 of 3 independent runs.

§: The boxes show the relevant combinations of results from the three runs on the basis of the results obtained in the first two runs shown in the box above.

°: The boxes show the relevant combinations of results from the four runs on the basis of the results obtained in the first three runs shown in the box above.

Acceptance criteria

22. The following acceptance criteria should be met when using the U-SENS™ test (12).

— At the end of the 45±3 hours exposure period, the mean viability of the triplicate untreated U937 cells had to be > 90 % and no drift in CD86 expression is observed. The CD86 basal expression of untreated U937 cells had to be comprised within the range of ≥ 2 % and ≤ 25 %.

▼M8

- When DMSO is used as a solvent, the validity of the DMSO vehicle control is assessed by calculating a DMSO S.I. compared to untreated cells, and the mean viability of the triplicate cells had to be > 90 %. The DMSO vehicle control is valid if the mean value of its triplicate CD86 S.I. was smaller than 250 % of the mean of the triplicate CD86 S.I. of untreated U937 cells.
- The runs are considered valid if at least two out of three IgG1 values of untreated U937 cells fell within the range of $\geq 0,6$ % and < 1,5 %.
- The concurrent tested negative control (lactic acid) is considered valid if at least two out of the three replicates were negative (CD86 S.I. < 150 %) and non-cytotoxic (cell viability ≥ 70 %).
- The positive control (TNBS) was considered as valid if at least two out of the three replicates were positive (CD86 S.I. ≥ 150 %) and non-cytotoxic (cell viability ≥ 70 %).

Test report

23. The test report should include the following information.

Test Chemical

Mono-constituent substance

- Chemical identification, such as IUPAC or CAS name(s), CAS number(s), SMILES or InChI code, structural formula, and/or other identifiers;
- Physical appearance, complete medium solubility, DMSO solubility, molecular weight, and additional relevant physicochemical properties, to the extent available;
- Purity, chemical identity of impurities as appropriate and practically feasible, etc.;
- Treatment prior to testing, if applicable (e.g. warming, grinding);
- Concentration(s) tested;
- Storage conditions and stability to the extent available;
- Justification for choice of solvent/vehicle for each test chemical.

Multi-constituent substance, UVCB and mixture:

- Characterisation as far as possible by e.g. chemical identity (see above), purity, quantitative occurrence and relevant physicochemical properties (see above) of the constituents, to the extent available;
- Physical appearance, complete medium solubility, DMSO solubility and additional relevant physicochemical properties, to the extent available;
- Molecular weight or apparent molecular weight in case of mixtures/polymers of known compositions or other information relevant for the conduct of the study;
- Treatment prior to testing, if applicable (e.g. warming, grinding);
- Concentration(s) tested;
- Storage conditions and stability to the extent available;
- Justification for choice of solvent/vehicle for each test chemical.

▼ M8*Controls*

Positive control

- Chemical identification, such as IUPAC or CAS name(s), CAS number(s), SMILES or InChI code, structural formula, and/or other identifiers;
- Physical appearance, DMSO solubility, molecular weight, and additional relevant physicochemical properties, to the extent available and where applicable;
- Purity, chemical identity of impurities as appropriate and practically feasible, etc.;
- Treatment prior to testing, if applicable (e.g. warming, grinding);
- Concentration(s) tested;
- Storage conditions and stability to the extent available;
- Reference to historical positive control results demonstrating suitable run acceptance criteria, if applicable.

Negative and solvent/vehicle control

- Chemical identification, such as IUPAC or CAS name(s), CAS number(s), SMILES or InChI code, structural formula, and/or other identifiers;
- Purity, chemical identity of impurities as appropriate and practically feasible, etc.;
- Physical appearance, molecular weight, and additional relevant physicochemical properties in the case other control solvent/vehicle than those mentioned in the Test Guideline are used and to the extent available;
- Storage conditions and stability to the extent available;
- Justification for choice of solvent/vehicle for each test chemical.

Test Conditions

- Name and address of the sponsor, test facility and study director;
- Description of test used;
- Cell line used, its storage conditions and source (e.g. the facility from which they were obtained);
- Flow cytometry used (e.g. model), including instrument settings, antibodies and cytotoxicity marker used;
- The procedure used to demonstrate proficiency of the laboratory in performing the test by testing of proficiency substances, and the procedure used to demonstrate reproducible performance of the test over time, e.g. historical control data and/or historical reactivity checks' data.

Test Acceptance Criteria

- Cell viability and CD86 S.I values obtained with the solvent/vehicle control in comparison to the acceptance ranges;

▼M8

- Cell viability and S.I. values obtained with the positive control in comparison to the acceptance ranges;
- Cell viability of all tested concentrations of the tested chemical.

Test procedure

- Number of runs used;
- Test chemical concentrations, application and exposure time used (if different than the one recommended)
- Duration of exposure;
- Description of evaluation and decision criteria used;
- Description of any modifications of the test procedure.

Results

- Tabulation of the data, including CV70 (if applicable), S.I., cell viability values, EC150 values (if applicable) obtained for the test chemical and for the positive control in each run, and an indication of the rating of the test chemical according to the prediction model;
- Description of any other relevant observations, if applicable.

Discussion of the Results

- Discussion of the results obtained with the U-SENS™ test;
- Consideration of the test results within the context of an IATA, if other relevant information is available.

*Conclusions***LITERATURE**

- (1) Piroird, C., Ovigne, J.M., Rousset, F., Martinozzi-Teissier, S., Gomes, C., Cotovio, J., Alépée, N. (2015). The Myeloid U937 Skin Sensitization Test (U-SENS) addresses the activation of dendritic cell event in the adverse outcome pathway for skin sensitization. *Toxicol. In Vitro* 29, 901-916.
- (2) EURL ECVAM (2017). The U-SENS™ test method Validation Study Report. Accessible at: http://ihcp.jrc.ec.europa.eu/our_labs/eurl-ecvam/eurl-ecvam-recommendations
- (3) EC EURL ECVAM (2016). ESAC Opinion No 2016-03 on the L'Oréal-coordinated study on the transferability and reliability of the U-SENS™ test method for skin sensitisation testing. EUR 28 178 EN; doi 10.2787/8157 37. Available at: [<http://publications.jrc.ec.europa.eu/repository/handle/JRC103705>].
- (4) EC EURL ECVAM (2017). EURL ECVAM Recommendation on the use of non-animal approaches for skin sensitisation testing. EUR 28 553 EN; doi 10.2760/5889 55. Available at: <https://ec.europa.eu/jrc/en/publication/eur-scientific-and-technical-research-reports/eurl-ecvam-recommendation-use-non-animal-approaches-skin-sensitisation-testing>.
- (5) Steiling, W. (2016). Safety Evaluation of Cosmetic Ingredients Regarding their Skin Sensitization Potential. doi:10.3390/cosmetics3020014. *Cosmetics* 3, 14.

▼M8

- (6) OECD (2016). Guidance Document on The Reporting of Defined Approaches and Individual Information Sources to be Used Within Integrated Approaches to Testing and Assessment (IATA) For Skin Sensitisation, Series on Testing & Assessment No 256, ENV/JM/MONO(2016)29. Organisation for Economic Cooperation and Development, Paris. Available at: [<http://www.oecd.org/env/ehs/testing/series-testing-assessment-publications-number.htm>].
- (7) Urbisch, D., Mehling, A., Guth, K., Ramirez, T., Honarvar, N., Kolle, S., Landsiedel, R., Jaworska, J., Kern, P.S., Gerberick, F., Natsch, A., Emter, R., Ashikaga, T., Miyazawa, M., Sakaguchi, H. (2015). Assessing skin sensitization hazard in mice and men using non-animal test methods. *Regul. Toxicol. Pharmacol.* 71, 337-351.
- (8) Alépée, N., Piroird, C., Aujoulat, M., Dreyfuss, S., Hoffmann, S., Hohenstein, A., Meloni, M., Nardelli, L., Gerbeix, C., Cotovio, J. (2015). Prospective multicentre study of the U-SENS test method for skin sensitization testing. *Toxicol In Vitro* 30, 373-382.
- (9) Reisinger, K., Hoffmann, S., Alépée, N., Ashikaga, T., Barroso, J., Elcombe, C., Gellatly, N., Galbiati, V., Gibbs, S., Groux, H., Hibatallah, J., Keller, D., Kern, P., Klaric, M., Kolle, S., Kuehnl, J., Lambrechts, N., Lindstedt, M., Millet, M., Martinozzi-Teissier, S., Natsch, A., Petersohn, D., Pike, I., Sakaguchi, H., Schepky, A., Tailhardat, M., Templier, M., van Vliet, E., Maxwell, G. (2014). Systematic evaluation of non-animal test methods for skin sensitisation safety assessment. *Toxicol. In Vitro* 29, 259-270.
- (10) Fabian, E., Vogel, D., Blatz, V., Ramirez, T., Kolle, S., Eltze, T., van Ravenzwaay, B., Oesch, F., Landsiedel, R. (2013). Xenobiotic metabolizing enzyme activities in cells used for testing skin sensitization *in vitro*. *Arch. Toxicol.* 87, 1 683-1 696.
- (11) OECD. (2018). Draft Guidance document: Good *In Vitro* Method Practices (GIVIMP) for the Development and Implementation of *In Vitro* Methods for Regulatory Use in Human Safety Assessment. Organisation for Economic Cooperation and Development, Paris. Available at: http://www.oecd.org/env/ehs/testing/OECD_Final_Draft_GIVIMP.pdf.
- (12) DB-ALM (2016). Protocol no 183: Myeloid U937 Skin Sensitization Test (U-SENS™), 33pp. Accessible at: [<http://ecvam-dbalm.jrc.ec.europa.eu/>].
- (13) Sundström, C., Nilsson, K. (1976). Establishment and characterization of a human histiocytic lymphoma cell line (U-937). *Int. J. Cancer* 17, 565-577.
- (14) OECD (2005). Series on Testing and Assessment No. 34: Validation and International Acceptance of New or Updated Test Methods for Hazard Assessment. Organisation for Economic Cooperation and Development, Paris. Available at: <http://www.oecd.org/env/ehs/testing/series-testing-assessment-publications-number.htm>.
- (15) United Nations UN (2015). Globally Harmonized System of Classification and Labelling of Chemicals (GHS). ST/SG/AC.10/30/Rev.6, Sixth Revised Edition, New York & Geneva: United Nations Publications. Available at: http://www.unece.org/fileadmin/DAM/trans/danger/publi/ghs/ghs_rev06/English/ST-SG-AC10-30-Rev6e.pdf.
- (16) OECD (2012). Series on Testing and Assessment No 168: The Adverse Outcome Pathway for Skin Sensitisation Initiated by Covalent Binding to Proteins. Part 1: Scientific Evidence. Organisation for Economic Cooperation and Development, Paris. Available at: <http://www.oecd.org/env/ehs/testing/series-testing-assessment-publications-number.htm>.
- (17) ECETOC (2003). Technical Report No 87: Contact sensitization: Classification according to potency. European Centre for Ecotoxicology & Toxicology of Chemicals, Brussels. Available at: https://ftp.cdc.gov/pub/Documents/OEL/06.%20Dotson/References/ECETOC_2003-TR87.pdf.

▼M8*Appendix 2.1*

DEFINITIONS

Accuracy: The closeness of agreement between test results and accepted reference values. It is a measure of test performance and one aspect of relevance. The term is often used interchangeably with concordance to mean the proportion of correct outcomes of a test (14).

AOP (Adverse Outcome Pathway): sequence of events from the chemical structure of a target chemical or group of similar chemicals through the molecular initiating event to an *in vivo* outcome of interest (15).

CD86 Concentration response: There is concentration-dependency (or concentration response) when a positive concentration (CD86 S.I. ≥ 150) is followed by a concentration with an increasing CD86 S.I.

Chemical: A substance or a mixture.

CV70: The estimated concentration showing 70 % cell viability.

Drift: A drift is defined by i) the corrected %CD86⁺ value of the untreated control replicate 3 is less than 50 % of the mean of the corrected %CD86⁺ value of untreated control replicates 1 and 2; and ii) the corrected %CD86⁺ value of the negative control replicate 3 is less than 50 % of mean of the corrected %CD86⁺ value of negative control replicates 1 and 2.

EC150: the estimated concentrations showing the 150 % S.I. of CD86 expression.

Flow cytometry: a cytometric technique in which cells suspended in a fluid flow one at a time through a focus of exciting light, which is scattered in patterns characteristic to the cells and their components; cells are frequently labeled with fluorescent markers so that light is first absorbed and then emitted at altered frequencies.

Hazard: Inherent property of an agent or situation having the potential to cause adverse effects when an organism, system or (sub) population is exposed to that agent.

IATA (Integrated Approach to Testing and Assessment): A structured approach used for hazard identification (potential), hazard characterisation (potency) and/or safety assessment (potential/potency and exposure) of a chemical or group of chemicals, which strategically integrates and weights all relevant data to inform regulatory decision regarding potential hazard and/or risk and/or the need for further targeted and therefore minimal testing.

Mixture: A mixture or a solution composed of two or more substances.

Mono-constituent substance: A substance, defined by its quantitative composition, in which one main constituent is present to at least 80 % (w/w).

Multi-constituent substance: A substance, defined by its quantitative composition, in which more than one main constituent is present in a concentration ≥ 10 % (w/w) and < 80 % (w/w). A multi-constituent substance is the result of a manufacturing process. The difference between mixture and multi-constituent substance is that a mixture is obtained by blending of two or more substances without chemical reaction. A multi-constituent substance is the result of a chemical reaction.

▼ M8

Positive control: A replicate containing all components of a test system and treated with a substance known to induce a positive response. To ensure that variability in the positive control response across time can be assessed, the magnitude of the positive response should not be excessive.

Pre-haptens: chemicals which become sensitisers through abiotic transformation, e.g. through oxidation.

Pro-haptens: chemicals requiring enzymatic activation to exert skin sensitisation potential.

Relevance: Description of relationship of the test to the effect of interest and whether it is meaningful and useful for a particular purpose. It is the extent to which the test correctly measures or predicts the biological effect of interest. Relevance incorporates consideration of the accuracy (concordance) of a test (14).

Reliability: Measures of the extent that a test can be performed reproducibly within and between laboratories over time, when performed using the same protocol. It is assessed by calculating intra- and inter-laboratory reproducibility and intra-laboratory repeatability (14).

Run: A run consists of one or more test chemicals tested concurrently with a solvent/vehicle control and with a positive control.

Sensitivity: The proportion of all positive/active chemicals that are correctly classified by the test. It is a measure of accuracy for a test that produces categorical results, and is an important consideration in assessing the relevance of a test (14).

S.I.: Stimulation Index. Relative values of geometric mean fluorescence intensity in chemical-treated cells compared to solvent-treated cells.

Solvent/vehicle control: An untreated sample containing all components of a test system except of the test chemical, but including the solvent/vehicle that is used. It is used to establish the baseline response for the samples treated with the test chemical dissolved or stably dispersed in the same solvent/vehicle. When tested with a concurrent medium control, this sample also demonstrates whether the solvent/vehicle interacts with the test system.

Specificity: The proportion of all negative/inactive chemicals that are correctly classified by the test. It is a measure of accuracy for a test that produces categorical results and is an important consideration in assessing the relevance of a test (14).

Staining buffer: A phosphate buffered saline containing 5 % foetal calf serum.

Substance: A chemical element and its compounds in the natural state or obtained by any production process, including any additive necessary to preserve its stability and any impurities deriving from the process used, but excluding any solvent which may be separated without affecting the stability of the substance or changing its composition.

Test chemical: Any substance or mixture tested using this test.

▼M8

United Nations Globally Harmonized System of Classification and Labelling of Chemicals (UN GHS): A system proposing the classification of chemicals (substances and mixtures) according to standardized types and levels of physical, health and environmental hazards, and addressing corresponding communication elements, such as pictograms, signal words, hazard statements, precautionary statements and safety data sheets, so that to convey information on their adverse effects with a view to protect people (including employers, workers, transporters, consumers and emergency responders) and the environment (16).

UVCB: substances of unknown or variable composition, complex reaction products or biological materials.

Valid test: A test considered to have sufficient relevance and reliability for a specific purpose and which is based on scientifically sound principles. A test is never valid in an absolute sense, but only in relation to a defined purpose (14).

▼ M8

Appendix 2.2

PROFICIENCY SUBSTANCES

Prior to routine use of the test described in this Appendix to test method B.71, laboratories should demonstrate technical proficiency by correctly obtaining the expected U-SENSTM prediction for the 10 substances recommended in Table 1 and by obtaining CV70 and EC150 values that fall within the respective reference range for at least 8 out of the 10 proficiency substances. Proficiency substances were selected to represent the range of responses for skin sensitisation hazards. Other selection criteria were that the substances are commercially available, and that high-quality *in vivo* reference data as well as high quality *in vitro* data generated with the U-SENSTM test are available. Also, published reference data are available for the U-SENSTM test (1) (8).

Table 1

Recommended substances for demonstrating technical proficiency with the U-SENSTM test

Proficiency substances	CASRN	Physical state	<i>In vivo</i> prediction (1)	U-SENS TM Solvent/Vehicle	U-SENS TM CV70 Reference Range in µg/ml (2)	U-SENS TM EC150 Reference Range in µg/ml (2)
4-Phenylenediamine	106-50-3	Solid	Sensitiser (strong)	Complete medium (3)	<30	Positive(≤10)
Picryl sulfonic acid	2508-19-2	Liquid	Sensitizer (strong)	Complete medium	>50	Positive(≤50)
Diethyl maleate	141-05-9	Liquid	Sensitiser (moderate)	DMSO	10-100	Positive(≤20)
Resorcinol	108-46-3	Solid	Sensitiser (moderate)	Complete medium	>100	Positive(≤50)
Cinnamic alcohol	104-54-1	Solid	Sensitiser(weak)	DMSO	>100	Positive(10-100)
4-Allylanisole	140-67-0	Liquid	Sensitiser(weak)	DMSO	>100	Positive(<200)
Saccharin	81-07-2	Solid	Non-sensitiser	DMSO	>200	Negative(>200)
Glycerol	56-81-5	Liquid	Non-sensitiser	Complete medium	>200	Negative(>200)
Lactic acid	50-21-5	Liquid	Non-sensitiser	Complete medium	>200	Negative(>200)
Salicylic acid	69-72-7	Solid	Non-sensitiser	DMSO	>200	Negative(>200)

Abbreviations: CAS RN = Chemical Abstracts Service Registry Number

(1) The *in vivo* hazard and (potency) prediction is based on LLNA data (1) (8). The *in vivo* potency is derived using the criteria proposed by ECETOC (17).

(2) Based on historical observed values (1) (8).

(3) Complete medium: RPMI-1640 medium supplemented with 10 % foetal calf serum, 2 mM L-glutamine, 100 units/ml penicillin and 100 µg/ml streptomycin (8).

▼ **M8***Appendix 3**IN VITRO SKIN SENSITISATION: IL-8 LUC ASSAY*

INITIAL CONSIDERATIONS AND LIMITATIONS

1. In contrast to assays analysing the expression of cell surface markers, the IL-8-Luc assay quantifies changes in IL-8 expression, a cytokine associated with the activation of dendritic cells (DC). In the THP-1-derived IL-8 reporter cell line (THP-G8, established from the human acute monocytic leukemia cell line THP-1), IL-8 expression is measured following exposure to sensitisers (1). The expression of luciferase is then used to aid discrimination between skin sensitisers and non-sensitisers.
2. The IL-8 Luc assay has been evaluated in a validation study (2) conducted by the Japanese Centre for the Validation of Alternatives Methods (JaCVAM), the **Ministry of Economy, Trade and Industry (METI)**, and the Japanese Society for Alternatives to Animal Experiments (**JSAAE**) and subsequently subjected to independent peer review (3) under the auspices of JaCVAM and the Ministry of Health, Labour and Welfare (MHLW) with the support of the **International Cooperation on Alternative Test Methods (ICATM)**. Considering all available evidence and input from regulators and stakeholders, the IL-8 Luc assay is considered useful as part of IATA to discriminate sensitisers from non-sensitisers for the purpose of hazard classification and labelling. Examples of the use of IL-8 Luc assay data in combination with other information are reported in the literature (4) (5) (6).
3. The IL-8 Luc assay proved to be transferable to laboratories experienced in cell culture and luciferase measurement. Within and between laboratory reproducibilities were 87,7 % and 87,5 %, respectively (2). Data generated in the validation study (2) and other published work (1) (6) show that versus the LLNA, the IL-8 Luc assay judged 118 out of 143 chemicals as positive or negative and judged 25 chemicals as inconclusive and the accuracy of the IL-8 Luc assay in distinguishing skin sensitisers (UN GHS/CLP Cat. 1) from non-sensitisers (UN GHS/CLP No Cat.) is 86 % (101/118) with a sensitivity of 96 % (92/96) and specificity of 41 % (9/22). Excluding substances outside the applicability domain described below (paragraph 5), the IL-8 Luc assay judged 113 out of 136 chemicals as positive or negative and judged 23 chemicals as inconclusive and the accuracy of the IL-8 Luc assay is 89 % (101/113) with sensitivity of 96 % (92/96) and specificity of 53 % (9/17). Using human data cited in Urbisch et al. (7), the IL-8 Luc assay judged 76 out of 90 chemicals as positive or negative and judged 14 chemicals as inconclusive and the accuracy is 80 % (61/76), sensitivity is 93 % (54/58) and specificity is 39 % (7/18). Excluding substances outside the applicability domain, the IL-8 Luc assay judged 71 out of 84 chemicals as positive or negative and judged 13 chemicals as inconclusive and the accuracy is 86 % (61/71) with sensitivity of 93 % (54/58) and specificity of 54 % (7/13). False negative predictions with the IL-8 Luc assay are more likely to occur with chemicals showing low/moderate skin sensitisation potency (UN GHS/CLP subcategory 1B) than those with high potency (UN GHS/CLP subcategory 1A) (6). Together,

▼M8

the information supports a role for the IL-8 Luc assay in the identification of skin sensitisation hazards. The accuracy given for the IL-8 Luc assay as a standalone test is only for guidance, as the test should be considered in combination with other sources of information in the context of an IATA and in accordance with the provisions of paragraphs 7 and 8 in the General introduction. Furthermore, when evaluating non-animal tests for skin sensitisation, it should be remembered that the LLNA and other animal tests may not fully reflect the situation in humans.

4. On the basis of the data currently available, the IL-8 Luc assay was shown to be applicable to test chemicals covering a variety of organic functional groups, reaction mechanisms, skin sensitisation potency (as determined in *in vivo* studies) and physicochemical properties (2) (6).

5. Although the IL-8 Luc assay uses X-VIVO™ 15 as a solvent, it correctly evaluated chemicals with a Log K_{ow} >3.5 and those with a water solubility of around 100 µg/ml as calculated by EPI Suite™ and its performance to detect sensitisers with poor water solubility is better than that of the IL-8 Luc assay using dimethyl sulfoxide (DMSO) as a solvent (2). However, negative results for test chemicals that are not dissolved at 20 mg/ml may produce false negative results due to their inability to dissolve in X-VIVO™ 15. Therefore, negative results for these chemicals should not be considered. A high false negative rate for anhydrides was seen in the validation study. Furthermore, because of the limited metabolic capability of the cell line (8) and the experimental conditions, pro-haptens (substances requiring metabolic activation) and pre-haptens (substances activated by air oxidation) might give negative results in the assay. However, although negative results for suspected pre/prohaptens should be interpreted with caution, the IL-8 Luc assay correctly judged 11 out of 11 pre-haptens, 6/6 pro-haptens, and 6/8 pre/pro-haptens in the IL-8 Luc assay data set (2). Based on the recent comprehensive review on three non-animal tests (the DPRA, the KeratinoSens™ and the h-CLAT) to detect pre and prohaptens (9), and based on the fact that THP-G8 cells used in the IL-8 Luc assay is a cell line derived from THP-1 that is used in the h-CLAT, the IL-8 Luc assay may also contribute to increase the sensitivity of non-animal tests to detect pre and pro-haptens in the combination of other tests. Surfactants tested so far gave (false) positive results irrespective of their type (e.g. cationic, anionic or non-ionic). Finally, chemicals that interfere with luciferase can confound its activity/measurement, causing apparent inhibition or increased luminescence (10). For example, phytoestrogen concentrations higher than 1µM were reported to interfere with luminescence signals in other luciferase-based reporter gene assays due to over-activation of the luciferase reporter gene. Consequently, luciferase expression obtained at high concentrations of phytoestrogens or compounds suspected of producing phytoestrogen-like activation of the luciferase reporter gene needs to be examined carefully (11). Based on the above, surfactants, anhydrides and chemicals interfering with luciferase are outside the applicability domain of this assay. In cases where there is evidence demonstrating the non-applicability of the IL-8 Luc assay to other specific categories of test chemicals, the test should not be used for those specific categories.

6. As described above, the IL-8 Luc assay supports discrimination of skin sensitisers from non-sensitisers. Further work, preferably based on human data, is required to determine whether IL-8 Luc results can contribute to potency assessment when considered in combination with other information sources.

▼ **M8**

7. Definitions are provided in Appendix 3.1.

PRINCIPLE OF THE TEST

8. The IL-8 Luc assay makes use of a human monocytic leukemia cell line THP-1 that was obtained from the American Type Culture Collection (Manassas, VA, USA). Using this cell line, the Dept. of Dermatology, Tohoku University School of Medicine, established a THP-1-derived IL-8 reporter cell line, THP-G8, that harbours the Stable Luciferase Orange (SLO) and Stable Luciferase Red (SLR) luciferase genes under the control of the IL-8 and glyceraldehyde 3-phosphate dehydrogenase (GAPDH) promoters, respectively (1). This allows quantitative measurement of luciferase gene induction by detecting luminescence from well-established light producing luciferase substrates as an indicator of the activity of the IL-8 and GAPDH in cells following exposure to sensitising chemicals.
9. The dual-colour assay system comprises an orange-emitting luciferase (SLO; max = 580 nm) (12) for the gene expression of the IL-8 promoter as well as a red-emitting luciferase (SLR; max = 630 nm) (13) for the gene expression of the internal control promoter, GAPDH. The two luciferases emit different colours upon reacting with firefly d-luciferin and their luminescence is measured simultaneously in a one-step reaction by dividing the emission from the assay mixture using an optical filter (14) (Appendix 3.2).
10. THP-G8 cells are treated for 16 hours with the test chemical, after which SLO luciferase activity (SLO-LA) reflecting IL-8 promoter activity and SLR luciferase activity (SLR-LA) reflecting GAPDH promoter activity are measured. To make the abbreviations easy to understand, SLO-LA and SLR-LA are designated as IL8LA and GAPLA, respectively. Table 1 gives a description of the terms associated with luciferase activity in the IL-8 Luc assay. The measured values are used to calculate the normalised IL8LA (nIL8LA), which is the ratio of IL8LA to GAPLA; the induction of nIL8LA (Ind-IL8LA), which is the ratio of the arithmetic means of quadruple-measured values of the nIL8LA of THP-G8 cells treated with a test chemical and the values of the nIL8LA of untreated THP-G8 cells; and the inhibition of GAPLA (Inh-GAPLA), which is the ratio of the arithmetic means of quadruple-measured values of the GAPLA of THP-G8 cells treated with a test chemical and the values of the GAPLA of untreated THP-G8 cells, and used as an indicator for cytotoxicity.

*Table 1***Description of terms associated with the luciferase activity in the IL-8 Luc assay**

Abbreviations	Definition
GAPLA	SLR luciferase activity reflecting GAPDH promoter activity
IL8LA	SLO luciferase activity reflecting IL-8 promoter activity
nIL8LA	IL8LA / GAPLA
Ind-IL8LA	nIL8LA of THP-G8 cells treated with chemicals / nIL8LA of untreated cells

▼ **M8**

Abbreviations	Definition
Inh-GAPLA	GAPLA of THP-G8 treated with chemicals / GAPLA of untreated cells
CV05	The lowest concentration of the chemical at which Inh-GAPLA becomes < 0,05.

11. Performance standards (PS) (15) are available to facilitate the validation of modified *in vitro* IL-8 luciferase tests similar to the IL-8 Luc assay and allow for timely amendment of OECD Test Guideline 442E for their inclusion. OECD Mutual Acceptance of Data (MAD) will only be guaranteed for tests validated according to the PS, if these tests have been reviewed and included in Test Guideline 442E by the OECD (16).

DEMONSTRATION OF PROFICIENCY

12. Prior to routine use of the test described in this Appendix to test method B.71, laboratories should demonstrate technical proficiency, using the 10 Proficiency Substances listed in Appendix 3.3 in compliance with the Good *in vitro* Method Practices (17). Moreover, test users should maintain a historical database of data generated with the reactivity checks (see paragraph 15) and with the positive and solvent/vehicle controls (see paragraphs 21-24), and use these data to confirm the reproducibility of the test in their laboratory is maintained over time.

PROCEDURE

13. The Standard Operating Procedure (SOP) for the IL-8 Luc assay is available and should be employed when performing the test (18). Laboratories willing to perform the test can obtain the recombinant THP-G8 cellline from GPC Lab. Co. Ltd., Tottori, Japan, upon signing a Material Transfer Agreement (MTA) in line with the conditions of the OECD template. The following paragraphs provide a description of the main components and procedures of the assay.

Preparation of cells

14. The THP-G8 cell line from GPC Lab. Co. Ltd., Tottori, Japan, should be used for performing the IL-8 Luc assay (see paragraphs 8 and 13). On receipt, cells are propagated (2-4 passages) and stored frozen as a homogeneous stock. Cells from this stock can be propagated up to a maximum of 12 passages or a maximum of 6 weeks. The medium used for propagation is the RPMI-1640 culture medium containing 10 % foetal bovine serum (FBS), antibiotic/antimycotic solution (100U/ml of penicillin G, 100µg/ml of streptomycin and 0,25µg/ml of amphotericin B in 0,85 % saline) (e.g. GIBCO Cat#15 240-062), 0,15µg/ml Puromycin (e.g. CAS:58-58-2) and 300µg/ml G418 (e.g. CAS:1083 21-42-2).
15. Prior to use for testing, the cells should be qualified by conducting a reactivity check. This check should be performed 1-2 weeks or 2-4 passages after thawing, using the positive control, 4-nitrobenzyl bromide (4-NBB) (CAS:100-11-8, ≥ 99 % purity) and the negative control, lactic acid (LA) (CAS:50-21-5, ≥85 % purity). 4-NBB should produce a positive response to Ind-IL8LA (≥1.4), while LA should produce a negative response to Ind-IL8LA (<1.4). Only cells that pass the reactivity check are used for the assay. The check should be performed according to the procedures described in paragraphs 22-24.

▼M8

16. For testing, THP-G8 cells are seeded at a density of 2 to 5×10^5 cells/ml, and pre-cultured in culture flasks for 48 to 96 hours. On the day of the test, cells harvested from the culture flask are washed with RPMI-1 640 containing 10 % FBS without any antibiotics, and then, resuspended with RPMI-1 640 containing 10 % FBS without any antibiotics at 1×10^6 cells/ml. Then, cells are distributed into a 96-well flat-bottom black plate (e.g. Costar Cat#3 603) with 50 μ l (5×10^4 cells/well).

Preparation of the test chemical and control substances

17. The test chemical and control substances are prepared on the day of testing. For the IL-8 Luc assay, test chemicals are dissolved in X-VIVO™ 15, a commercially available serum-free medium (Lonza, 04-418Q), to the final concentration of 20 mg/ml. X-VIVO™ 15 is added to 20 mg of test chemical (regardless of the chemical's solubility) in a microcentrifuge tube and brought to a volume of 1ml and then vortexed vigorously and shaken on a rotor at a maximum speed of 8 rpm for 30 min at an ambient temperature of about 20°C. Furthermore, if solid chemicals are still insoluble, the tube is sonicated until the chemical is dissolved completely or stably dispersed. For test chemicals soluble in X-VIVO™ 15, the solution is diluted by a factor of 5 with X-VIVO™ 15 and used as an X-VIVO™ 15 stock solution of the test chemical (4 mg/ml). For test chemicals not soluble in X-VIVO™ 15, the mixture is rotated again for at least 30 min, then centrifuged at 15,000 rpm ($\approx 20\,000$ g) for 5 min; the resulting supernatant is used as an X-VIVO™ 15 stock solution of the test chemical. A scientific rationale should be provided for the use of other solvents, such as DMSO, water, or the culture medium. The detailed procedure for dissolving chemicals is shown in Appendix 3.5. The X-VIVO™ 15 solutions described in paragraphs 18-23 are mixed 1:1 (v/v) with the cell suspensions prepared in a 96-well flat-bottom black plate (see paragraph 16).
18. The first test run is aimed to determine the cytotoxic concentration and to examine the skin sensitising potential of chemicals. Using X-VIVO™ 15, serial dilutions of the X-VIVO™ 15 stock solutions of the test chemicals are made at a dilution factor of two (see Appendix 3.5) using a 96-well assay block (e.g. Costar Cat#EW-01 729-03). Next, 50 μ l/well of diluted solution is added to 50 μ l of the cell suspension in a 96-well flat-bottom black plate. Thus for test chemicals that are soluble in X-VIVO™ 15, the final concentrations of the test chemicals range from 0,002 to 2 mg/ml (Appendix 3.5). For test chemicals that are not soluble in X-VIVO™ 15 at 20 mg/ml, only dilution factors that range from 2 to 2^{10} , are determined, although the actual final concentrations of the test chemicals remain uncertain and are dependent on the saturated concentration of the test chemicals in the X-VIVO™ 15 stock solution.
19. In subsequent test runs (i.e. the second, third, and fourth replicates), the X-VIVO™ 15 stock solution is made at the concentration 4 times higher than the concentration of cell viability 05 (CV05; the lowest concentration at which the Inh-GAPLA becomes <0.05) in the first experiment. If Inh-GAPLA does not decrease below 0,05 at the highest concentration in the first run, the X-VIVO™ 15 stock solution is made at the first run highest concentration. The concentration of CV05 is calculated by dividing the concentration of the stock solution in the first run by dilution factor for CV05 (X) (dilution factor CV05 (X)); the dilution factor required to dilute stock solution to CV05) (see Appendix 3.5). For test substances not soluble in X-VIVO at 20 mg/ml, CV05 is determined by the concentration of the stock solution $\times 1/X$. For run 2 to 4, a second stock solution is prepared as 4 \times CV05 (Appendix 3.5).

▼M8

20. Serial dilutions of the X-VIVO™ 15 second stock solutions are made at a dilution factor of 1,5 using a 96-well assay block. Next, 50 µl/well of diluted solution is added to 50 µl of the cell suspension in the wells of a 96-well flat-bottom black plate. Each concentration of each test chemical should be tested in 4 wells. The samples are then mixed on a plate shaker and incubated for 16 hours at 37 °C and 5 % CO₂, after which the luciferase activity is measured as described below.

21. The solvent control is the mixture of 50 µl/well of X-VIVO™ 15 and 50 µl/well of cell suspension in RPMI-1 640 containing 10 % FBS.

22. The recommended positive control is 4-NBB. 20 mg of 4-NBB is prepared in a 1,5-ml microfuge tube, to which X-VIVO™ 15 is added up to 1 ml. The tube is vortexed vigorously and shaken on a rotor at a maximum speed of 8 rpm for at least 30 min. After centrifugation at 20 000g for 5 min, the supernatant is diluted by a factor of 4 with X-VIVO™ 15, and 500 µl of the diluted supernatant is transferred to a well in a 96-well assay block. The diluted supernatant is further diluted with X-VIVO™ 15 at factors of 2 and 4, and 50 µl of the solution is added to 50 µl of THP-G8 cell suspension in the wells of a 96-well flat-bottom black plate (Appendix 3.6). Each concentration of the positive control should be tested in 4 wells. The plate is agitated on a plate shaker, and incubated in a CO₂ incubator for 16 hours (37 °C, 5 % CO₂), after which the luciferase activity is measured as described in paragraph 29.

23. The recommended negative control is LA. 20 mg of LA prepared in a 1,5-ml microfuge tube, to which X-VIVO™ 15 is added up to 1 ml (20 mg/ml). Twenty mg/ml of LA solution is diluted by a factor of 5 with X-VIVO™ 15 (4 mg/ml); 500 µl of this 4 mg/ml LA solution is transferred to a well of a 96-well assay block. This solution is diluted by a factor of 2 with X-VIVO™ 15 and then diluted again by a factor of 2 to produce 2 mg/ml and 1 mg/ml solutions. 50 µl of these 3 solutions and vehicle control (X-VIVO™ 15) are added to 50 µl of THP-G8 cell suspension in the wells of a 96-well flat-bottom black plate. Each concentration of the negative control is tested in 4 wells. The plate is agitated on a plate shaker and incubated in a CO₂ incubator for 16 hours (37 °C, 5 % CO₂), after which the luciferase activity is measured as described in paragraph 29.

24. Other suitable positive or negative controls may be used if historical data are available to derive comparable run acceptance criteria.

25. Care should be taken to avoid evaporation of volatile test chemicals and cross-contamination between wells by test chemicals, e.g. by sealing the plate prior to the incubation with the test chemicals.

26. The test chemicals and solvent control require 2 to 4 runs to derive a positive or negative prediction (see Table 2). Each run is performed on a different day with fresh X-VIVO™ 15 stock solution of test chemicals and independently harvested cells. Cells may come from the same passage.

▼ M8**Luciferase activity measurements**

27. Luminescence is measured using a 96-well microplate luminometer equipped with optical filters, e.g. Phelios (ATTO, Tokyo, Japan), Tristan 941 (Berthold, Bad Wildbad, Germany) and the ARVO series (PerkinElmer, Waltham, MA, USA). The luminometer must be calibrated for each test to ensure reproducibility (19). Recombinant orange and red emitting luciferases are available for this calibration.

28. 100µl of pre-warmed Tripluc® Luciferase assay reagent (Tripluc) is transferred to each well of the plate containing the cell suspension treated with or without chemical. The plate is shaken for 10 min at an ambient temperature of about 20 °C. The plate is placed in the luminometer to measure the luciferase activity. Bioluminescence is measured for 3 sec each in the absence (F0) and presence (F1) of the optical filter. Justification should be provided for the use of alternative settings, e.g. depending on the model of luminometer used.

29. Parameters for each concentration are calculated from the measured values, e.g. IL8LA, GAPLA, nIL8LA, Ind-IL8LA, Inh-GAPLA, the mean ±SD of IL8LA, the mean ±SD of GAPLA, the mean ±SD of nIL8LA, the mean ±SD of Ind-IL8LA, the mean ±SD of Inh-GAPLA, and the 95 % confidence interval of Ind-IL8LA. Definitions of the parameters used in this paragraph are provided in Appendices 3.1 and 3.4.

30. Prior to measurement, colour discrimination in multi-colour reporter assays is generally achieved using detectors (luminometer and plate reader) equipped with optical filters, such as sharp-cut (long-pass or short-pass) filters or band-pass filters. The transmission coefficients of the filters for each bioluminescence signal colour should be calibrated prior to testing, per Appendix 3.2.

DATA AND REPORTING**Data evaluation**

31. Criteria for a positive/negative decision require that in each run:
 - an IL-8 Luc assay prediction is judged positive if a test chemical has a Ind-IL8LA 1.4 and the lower limit of the 95 % confidence interval of Ind-IL8LA 1.0

 - an IL-8 Luc assay prediction is judged negative if a test chemical has a Ind-IL8LA < 1.4 and/or the lower limit of the 95 % confidence interval of Ind-IL8LA < 1.0

Prediction model

32. Test chemicals that provide two positive results from among the 1st, 2nd, 3rd or 4th runs are identified as positives whereas those that give three negative results from among the 1st, 2nd, 3rd or 4th runs are identified as supposed negative (Table 2). Among supposed negative chemicals, chemicals that are dissolved at 20 mg/ml of X-VIVO™ 15 are judged as negative, while chemicals that are not dissolved at 20 mg/ml of X-VIVO™ 15 should not be considered (Figure 1).

▼ **M8**

Table 2
Criteria for identifying positive and supposed negative

1st run	2nd run	3rd run	4th run	Final prediction
Positive	Positive	—	—	Positive
	Negative	Positive	—	Positive
		Negative	Positive	Positive
		Negative	Negative	Supposed negative
Negative	Positive	Positive	—	Positive
		Negative	Positive	Positive
		Negative	Negative	Supposed negative
	Negative	Positive	Positive	Positive
		Negative	Negative	Supposed negative
		Negative	—	Supposed negative

Figure 1
Prediction model for final judgment

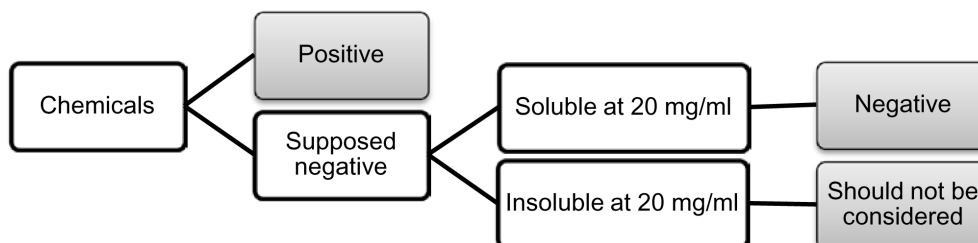
**Acceptance criteria**

33. The following acceptance criteria should be met when using the IL-8 Luc assay:
- Ind-IL8LA should be more than 5.0 at least in one concentration of the positive control, 4-NBB, in each run.
 - Ind-IL8LA should be less than 1.4 at any concentration of the negative control, lactic acid, in each run.
 - Data from plates for which the GAPLA of control wells with cells and Tripluc but without chemicals is less than 5 times of that of well containing test medium only (50 µl/well of RPMI-1 640 containing 10 % FBS and 50 µl/well of X-VIVO™ 15) should be rejected.
 - Data from plates for which the Inh-GAPLA of all concentrations of the test or control chemicals is less than 0,05 should be rejected. In this case, the first test should be repeated so the highest final concentration of the repeated test is the lowest final concentration of the previous test.

▼M8**Test report**

34. The test report should include the following information:

Test chemicals

Mono-constituent substance:

- Chemical identification, such as IUPAC or CAS name(s), CAS number(s), SMILES or InChI code, structural formula, and/or other identifiers;
- Physical appearance, water solubility, molecular weight, and additional relevant physicochemical properties, to the extent available;
- Purity, chemical identity of impurities as appropriate and practically feasible, etc.;
- Treatment prior to testing, if applicable (e.g. warming, grinding);
- Solubility in X-VIVOTM 15. For chemicals that are insoluble in X-VIVOTM 15, whether precipitation or flotation are observed after centrifugation;
- Concentration(s) tested;
- Storage conditions and stability to the extent available;
- Justification for choice of solvent/vehicle for each test chemical if X-VIVOTM 15 has not been used.

Multi-constituent substance, UVCB and mixture:

- Characterisation as far as possible by e.g. chemical identity (see above), purity, quantitative occurrence and relevant physicochemical properties (see above) of the constituents, to the extent available;
- Physical appearance, water solubility, and additional relevant physicochemical properties, to the extent available;
- Molecular weight or apparent molecular weight in case of mixtures/polymers of known compositions or other information relevant for the conduct of the study;
- Treatment prior to testing, if applicable (e.g. warming, grinding);
- Solubility in X-VIVOTM 15. For chemicals that are insoluble in X-VIVOTM 15, whether precipitation or flotation are observed after centrifugation;
- Concentration(s) tested;
- Storage conditions and stability to the extent available.
- Justification for choice of solvent/vehicle for each test chemical, if X-VIVOTM 15 has not been used.

Controls

Positive control:

- Chemical identification, such as IUPAC or CAS name(s), CAS number(s), SMILES or InChI code, structural formula, and/or other identifiers;
- Physical appearance, water solubility, molecular weight, and additional relevant physicochemical properties, to the extent available and where applicable;

▼M8

- Purity, chemical identity of impurities as appropriate and practically feasible, etc;
- Treatment prior to testing, if applicable (e.g. warming, grinding);
- Concentration(s) tested;
- Storage conditions and stability to the extent available;
- Reference to historical positive control results demonstrating suitable acceptance criteria, if applicable.

Negative control:

- Chemical identification, such as IUPAC or CAS name(s), CAS number(s), and/or other identifiers;
- Purity, chemical identity of impurities as appropriate and practically feasible, etc;
- Physical appearance, molecular weight, and additional relevant physico-chemical properties in the case other negative controls than those mentioned in the Test Guideline are used and to the extent available;
- Storage conditions and stability to the extent available;
- Justification for choice of solvent for each test chemical.

Test conditions

- Name and address of the sponsor, test facility and study director;
- Description of test used;
- Cell line used, its storage conditions, and source (e.g. the facility from which it was obtained);
- Lot number and origin of FBS, supplier name, lot number of 96-well flat-bottom black plate, and lot number of Tripluc reagent;
- Passage number and cell density used for testing;
- Cell counting method used for seeding prior to testing and measures taken to ensure homogeneous cell number distribution;
- Luminometer used (e.g. model), including instrument settings, luciferase substrate used, and demonstration of appropriate luminescence measurements based on the control test described in Appendix 3.2;
- The procedure used to demonstrate proficiency of the laboratory in performing the test (e.g. by testing of proficiency substances) or to demonstrate reproducible performance of the test over time.

Test procedure

- Number of replicates and runs performed;
- Test chemical concentrations, application procedure and exposure time (if different from those recommended);

▼M8

- Description of evaluation and decision criteria used;
- Description of study acceptance criteria used;
- Description of any modifications of the test procedure.

Results

- Measurements of IL8LA and GAPLA;
- Calculations for nIL8LA, Ind-IL8LA, and Inh-GAPLA;
- The 95 % confidence interval of Ind-IL8LA;
- A graph depicting dose-response curves for induction of luciferase activity and viability;
- Description of any other relevant observations, if applicable.

Discussion of the results

- Discussion of the results obtained with the IL-8 Luc assay;
- Consideration of the assay results in the context of an IATA, if other relevant information is available.

*Conclusion***LITERATURE**

- (1) Takahashi T, Kimura Y, Saito R, Nakajima Y, Ohmiya Y, Yamasaki K, and Aiba S. (2011). An *in vitro* test to screen skin sensitizers using a stable THP-1-derived IL-8 reporter cell line, THP-G8. *Toxicol Sci* 124:359-69.
- (2) OECD (2017). Validation report for the international validation study on the IL-8 Luc assay as a test evaluating the skin sensitizing potential of chemicals conducted by the IL-8 Luc Assay. Series on Testing and Assessment No 267, ENV/JM/MONO(2017)19. Organisation for Economic Cooperation and Development, Paris. Available at: <http://www.oecd.org/env/ehs/testing/series-testing-assessment-publications-number.htm>.
- (3) OECD (2017). Report of the Peer Review Panel for the IL-8 Luciferase (IL-8 Luc) Assay for *in vitro* skin sensitisation. Series on Testing and Assessment No 258, ENV/JM/MONO(2017)20. Organisation for Economic Cooperation and Development, Paris. Available at: <http://www.oecd.org/env/ehs/testing/series-testing-assessment-publications-number.htm>.
- (4) OECD (2016) Guidance Document On The Reporting Of Defined Approaches And Individual Information Sources To Be Used Within Integrated Approaches To Testing And Assessment (IATA) For Skin Sensitisation, Series on Testing & Assessment No 256, ENV/JM/MONO(2016)29. Organisation for Economic Cooperation and Development, Paris. Available at: <http://www.oecd.org/env/ehs/testing/series-testing-assessment-publications-number.htm>.
- (5) van der Veen JW, Rorije E, Emter R, Natsch A, van Loveren H, and Ezendam J. (2014). Evaluating the performance of integrated approaches for hazard identification of skin sensitizing chemicals. *Regul Toxicol Pharmacol* 69:371-9.
- (6) Kimura Y, Fujimura C, Ito Y, Takahashi T, Nakajima Y, Ohmiya Y, and Aiba S. (2015). Optimization of the IL-8 Luc assay as an *in vitro* test for skin sensitization. *Toxicol In Vitro* 29:1 816-30.

▼M8

- (7) Urbisch D, Mehling A, Guth K, Ramirez T, Honarvar N, Kolle S, Landsiedel R, Jaworska J, Kern PS, Gerberick F, et al. (2015). Assessing skin sensitization hazard in mice and men using non-animal test methods. *Regul Toxicol Pharmacol* 71:337-51.
- (8) Ashikaga T, Sakaguchi H, Sono S, Kosaka N, Ishikawa M, Nukada Y, Miyazawa M, Ito Y, Nishiyama N, and Itagaki H. (2010). A comparative evaluation of *in vitro* skin sensitisation tests: the human cell-line activation test (h-CLAT) versus the local lymph node assay (LLNA). *Alternatives to laboratory animals: ATLA* 38:275-84.
- (9) Patlewicz G, Casati S, Basketter DA, Asturiol D, Roberts DW, Lepoittevin J-P, Worth A and Aschberger K (2016) Can currently available non-animal methods detect pre and pro haptens relevant for skin sensitisation? *Regul Toxicol Pharmacol*, 82:147-155.
- (10) Thorne N, Inglese J, and Auld DS. (2010). Illuminating insights into firefly luciferase and other bioluminescent reporters used in chemical biology. *Chem Biol* 17:646-57.
- (11) OECD (2016). Test No 455: Performance-Based Test Guideline for Stably Transfected Transactivation *In Vitro* Assays to Detect Estrogen Receptor Agonists and Antagonists, OECD Publishing, Paris. <http://dx.doi.org/10.1787/9789264265295-en>.
- (12) Viviani V, Uchida A, Suenaga N, Ryufuku M, and Ohmiya Y. (2001). Thr226 is a key residue for bioluminescence spectra determination in beetle luciferases. *Biochem Biophys Res Commun* 280:1 286-91.
- (13) Viviani VR, Bechara EJ, and Ohmiya Y. (1999). Cloning, sequence analysis, and expression of active *Phrixothrix* railroad-worms luciferases: relationship between bioluminescence spectra and primary structures. *Biochemistry* 38:8 271-9.
- (14) Nakajima Y, Kimura T, Sugata K, Enomoto T, Asakawa A, Kubota H, Ikeda M, and Ohmiya Y. (2005). Multicolor luciferase assay system: one-step monitoring of multiple gene expressions with a single substrate. *Biotechniques* 38:891-4.
- (15) OECD (2017). To be published - Performance Standards for the assessment of proposed similar or modified *in vitro* skin sensitisation IL-8 luc test methods. OECD Environment, Health and Safety Publications, Series on Testing and Assessment. OECD, Paris, France
- (16) OECD (2005). Guidance Document the Validation and International Acceptance of New or Updated Test Methods for Hazard Assessment. OECD Environment, Health and Safety publications, OECD Series on Testing and Assessment No 34. OECD, Paris, France.
- (17) OECD (2018). Draft Guidance document: Good *In Vitro* Method Practices (GIVIMP) for the Development and Implementation of *In Vitro* Methods for Regulatory Use in Human Safety Assessment. Organisation for Economic Cooperation and Development, Paris. Available at: http://www.oecd.org/env/ehs/testing/OECD_Final_Draft_GIVIMP.pdf.
- (18) JaCVAM (2016). IL-8 Luc assay protocol, Available at. http://www.jacvam.jp/en_effort/effort02.html.
- (19) Niwa K, Ichino Y, Kumata S, Nakajima Y, Hiraishi Y, Kato D, Viviani VR, and Ohmiya Y. (2010). Quantum yields and kinetics of the firefly bioluminescence reaction of beetle luciferases. *Photochem Photobiol* 86:1 046-9.

▼M8

- (20) OECD (2012). The Adverse Outcome Pathway for Skin Sensitisation Initiated by Covalent Binding to Proteins, Part 1: Scientific Evidence. OECD Environment, Health and Safety Publications, Series on Testing and Assessment No 168. OECD, Paris, France.
- (21) United Nations (2015). Globally Harmonized System of Classification and Labelling of Chemicals (GHS). Sixth revised edition. New York & Geneva: United Nations Publications. ISBN: 978-92-1-117006-1. Available at: http://www.unece.org/trans/danger/publi/ghs/ghs_rev05/05files_e.html.

▼M8*Appendix 3.1*

DEFINITIONS

Accuracy: The closeness of agreement between test results and accepted reference values. It is a measure of test performance and one aspect of relevance. The term is often used interchangeably with concordance to mean the proportion of correct outcomes of a test (16).

AOP (Adverse Outcome Pathway): Sequence of events from the chemical structure of a target chemical or group of similar chemicals through the molecular initiating event to an *in vivo* outcome of interest (20).

Chemical: A substance or a mixture.

CV05: Cell viability 05, i.e. minimum concentration at which chemicals show less than 0,05 of Inh-GAPLA.

FInSLO-LA: Abbreviation used in the validation report and in previous publications regarding the IL-8 Luc assay to refer to Ind-IL8LA. See Ind-IL8LA for definition.

GAPLA: Luciferase Activity of Stable Luciferase Red (SLR) (max = 630 nm), regulated by GAPDH promoter and demonstrates cell viability and viable cell number.

Hazard: Inherent property of an agent or situation having the potential to cause adverse effects when an organism, system or (sub) population is exposed to that agent.

IATA (Integrated Approach to Testing and Assessment): A structured approach used for hazard identification (potential), hazard characterisation (potency) and/or safety assessment (potential/potency and exposure) of a chemical or group of chemicals, which strategically integrates and weights all relevant data to inform regulatory decision regarding potential hazard and/or risk and/or the need for further targeted and therefore minimal testing.

II-SLR-LA: Abbreviation used in the validation report and in previous publications regarding the IL-8 Luc assay to refer to Inh-GAPLA. See Inh-GAPLA for definition

IL-8 (Interleukin-8): A cytokine derived from endothelial cells, fibroblasts, keratinocytes, macrophages, and monocytes that causes chemotaxis of neutrophils and T-cell lymphocytes.

IL8LA: Luciferase Activity of Stable Luciferase Orange (SLO) (max = 580 nm), regulated by IL-8 promoter.

Ind-IL8LA: Fold induction of nIL8LA. It is obtained by dividing the nIL8LA of THP-G8 cells treated with chemicals by that of non-stimulated THP-G8 cells and represents the induction of IL-8 promoter activity by chemicals.

Inh-GAPLA: Inhibition of GAPLA. It is obtained by dividing GAPLA of THP-G8 treated with chemicals with GAPLA of non-treated THP-G8 and represents cytotoxicity of chemicals.

Minimum induction threshold (MIT): the lowest concentration at which a chemical satisfies the positive criteria

▼ M8

Mixture: A mixture or a solution composed of two or more substances.

Mono-constituent substance: A substance, defined by its quantitative composition, in which one main constituent is present to at least 80 % (w/w).

Multi-constituent substance: A substance, defined by its quantitative composition, in which more than one of the main constituents is present in a concentration ≥ 10 % (w/w) and < 80 % (w/w). A multi-constituent substance is the result of a manufacturing process. The difference between mixture and multi-constituent substance is that a mixture is obtained by blending of two or more substances without chemical reaction. A multi-constituent substance is the result of a chemical reaction.

nIL8LA: The SLO luciferase activity reflecting IL-8 promoter activity (IL8LA) normalised by the SLR luciferase activity reflecting GAPDH promoter activity (GAPLA). It represents IL-8 promoter activity after considering cell viability or cell number.

nSLO-LA: Abbreviation used in the validation report and in previous publications regarding the IL-8 Luc assay to refer to nIL8LA. See nIL8LA for definition.

Positive control: A replicate containing all components of a test system and treated with a substance known to induce a positive response. To ensure that variability in the positive control response across time can be assessed, the magnitude of the positive response should not be excessive.

Pre-haptens: Chemicals which become sensitisers through abiotic transformation.

Pro-haptens: Chemicals requiring enzymatic activation to exert skin sensitisation potential.

Relevance: Description of relationship of the test to the effect of interest and whether it is meaningful and useful for a particular purpose. It is the extent to which the test correctly measures or predicts the biological effect of interest. Relevance incorporates consideration of the accuracy (concordance) of a test (16).

Reliability: Measures of the extent that a test can be performed reproducibly within and between laboratories over time, when performed using the same protocol. It is assessed by calculating intra- and inter-laboratory reproducibility and intra-laboratory repeatability (16).

Run: A run consists of one or more test chemicals tested concurrently with a solvent/vehicle control and with a positive control.

Sensitivity: The proportion of all positive/active chemicals that are correctly classified by the test. It is a measure of accuracy for a test that produces categorical results, and is an important consideration in assessing the relevance of a test (16).

SLO-LA: Abbreviation used in the validation report and in previous publications regarding the IL-8 Luc assay to refer to IL8LA. See IL8LA for definition.

SLR-LA: Abbreviation used in the validation report and in previous publications regarding the IL-8 Luc assay to refer to GAPLA. See GAPLA for definition.

▼ M8

Solvent/vehicle control: An untreated sample containing all components of a test system except of the test chemical, but including the solvent/vehicle that is used. It is used to establish the baseline response for the samples treated with the test chemical dissolved or stably dispersed in the same solvent/vehicle. When tested with a concurrent medium control, this sample also demonstrates whether the solvent/vehicle interacts with the test system.

Specificity: The proportion of all negative/inactive chemicals that are correctly classified by the test. It is a measure of accuracy for a test that produces categorical results and is an important consideration in assessing the relevance of a test (16).

Substance: A chemical elements and its compounds in the natural state or obtained by any production manufacturing process, including any additive necessary to preserve the its stability of the product and any impurities deriving from the process used, but excluding any solvent which may be separated without affecting the stability of the substance or changing its composition.

Surfactant: Also called surface-active agent, this is a substance, such as a detergent, that can reduce the surface tension of a liquid and thus allow it to foam or penetrate solids; it is also known as a wetting agent. (TG437)

Test chemical: Any substance or mixture tested using this method.

THP-G8: An IL-8 reporter cell line used in IL-8 Luc assay. The human macrophage-like cell line THP-1 was transfected the SLO and SLR luciferase genes under the control of the IL-8 and GAPDH promoters, respectively.

United Nations Globally Harmonized System of Classification and Labeling of Chemicals (UN GHS): A system proposing the classification of chemicals (substances and mixtures) according to standardised types and levels of physical, health and environmental hazards, and addressing corresponding communication elements, such as pictograms, signal words, hazard statements, precautionary statements and safety data sheets, so that to convey information on their adverse effects with a view to protect people (including employers, workers, transporters, consumers and emergency responders) and the environment (21).

UVCB: substances of unknown or variable composition, complex reaction products or biological materials.

Valid test method: A test considered to have sufficient relevance and reliability for a specific purpose and which is based on scientifically sound principles. A test is never valid in an absolute sense, but only in relation to a defined purpose.

▼ **M8***Appendix 3.2***PRINCIPLE OF MEASUREMENT OF LUCIFERASE ACTIVITY AND DETERMINATION OF THE TRANSMISSION COEFFICIENTS OF OPTICAL FILTER FOR SLO AND SLR**

MultiReporter Assay System -Tripluc- can be used with a microplate-type luminometer with a multi-colour detection system, which can equip an optical filter (e.g. Phelios AB-2350 (ATTO), ARVO (PerkinElmer), Tristar LB941 (Berthold)). The optical filter used in measurement is 600–620 nm long or short pass filter, or 600–700 nm band pass filter.

Measurement of two-colour luciferases with an optical filter

This is an example using Phelios AB-2350 (ATTO). This luminometer is equipped with a 600 nm long pass filter (R60 HOYA Co., 600 nm LP, Filter 1) for splitting SLO (max = 580 nm) and SLR (max = 630 nm) luminescence.

To determine transmission coefficients of the 600 nm LP, first, using purified SLO and SLR luciferase enzymes, measure i) the SLO and SLR bioluminescence intensity without filter (F0), ii) the SLO and SLR bioluminescence intensity that passed through 600 nm LP (Filter 1), and iii) calculate the transmission coefficients of 600 nm LP for SLO and SLR listed below.

Transmission coefficients		Abbreviation	Definition
SLO	Filter 1 Transmission coefficients	κO_{R60}	The filter's transmission coefficient for the SLO
SLR	Filter 1 Transmission coefficients	κR_{R60}	The filter's transmission coefficient for the SLR

When the intensity of SLO and SLR in test sample are defined as O and R, respectively, i) the intensity of light without filter (all optical) F0 and ii) the intensity of light that transmits through 600 nm LP (Filter 1) F1 are described as below.

$$F0=O+R$$

$$F1=\kappa O_{R60} \times O + \kappa R_{R60} \times R$$

These formulas can be rephrased as follows:

$$\begin{pmatrix} F0 \\ F1 \end{pmatrix} = \begin{pmatrix} 1 & 1 \\ \kappa O_{R60} & \kappa R_{R60} \end{pmatrix} \begin{pmatrix} O \\ R \end{pmatrix}$$

Then using calculated transmittance factors (κO_{R60} and κR_{R60}) and measured F0 and F1, you can calculate O and R-value as follows:

$$\begin{pmatrix} O \\ R \end{pmatrix} = \begin{pmatrix} 1 & 1 \\ \kappa O_{R60} & \kappa R_{R60} \end{pmatrix}^{-1} \begin{pmatrix} F0 \\ F1 \end{pmatrix}$$

▼ M8**Materials and methods for determining transmittance factor**(1) *Reagents*

Single purified luciferase enzymes:

Lyophilised purified SLO enzyme

Lyophilised purified SLR enzyme

(which for the validation work were obtained from GPC Lab. Co. Ltd., Tottori, Japan with THP-G8 cell line)

Assay reagent:

Tripluc® Luciferase assay reagent (for example from TOYOBO Cat#MRA-301)

Medium: for luciferase assay (30 ml, stored at 2 – 8°C)

Reagent	Conc.	Final conc. in medium	Required amount
RPMI-1640	—	—	27 ml
FBS	—	10 %	3 ml

(2) *Preparation of enzyme solution*

Dissolve lyophilised purified luciferase enzyme in tube by adding 200 µl of 10 ~ 100 mM Tris/HCl or Hepes/HCl (pH 7.5 ~ 8.0) supplemented with 10 % (w/v) glycerol, divide the enzyme solution into 10 µl aliquots in 1,5 ml disposable tubes and store them in a freezer at -80°C. The frozen enzyme solution can be used for up to 6 months. When used, add 1 ml of medium for luciferase assay (RPMI-1640 with 10 % FBS) to each tube containing the enzyme solutions (diluted enzyme solution) and keep them on ice to prevent deactivation.

(3) *Bioluminescence measurement*

Thaw Tripluc® Luciferase assay reagent (Tripluc) and keep it at room temperature either in a water bath or at ambient air temperature. Power on the luminometer 30 min before starting the measurement to allow the photomultiplier to stabilise. Transfer 100 µl of the diluted enzyme solution to a black 96 well plate (flat bottom) (the SLO reference sample to #B1, #B2, #B3, the SLR reference sample to #D1, #D2, #D3). Then, transfer 100 µl of pre-warmed Tripluc to each well of the plate containing the diluted enzyme solution using a pipetman. Shake the plate for 10 min at room temperature (about 25°C) using a plate shaker. Remove bubbles from the solutions in wells if they appear. Place the plate in the luminometer to measure the luciferase activity. Bioluminescence is measured for 3 sec each in the absence (F0) and presence (F1) of the optical filter.

Transmission coefficient of the optical filter was calculated as follows:

Transmission coefficient (SLO (κ_{R60})) = (#B1 of F1+ #B2 of F1+ #B3 of F1) / (#B1 of F0+ #B2 of F0+ #B3 of F0)

▼M8

Transmission coefficient (SLR (κ_{R60}))= (#D1 of F1+ #D2 of F1+ #D3 of F1) / (#D1 of F0+ #D2 of F0+ #D3 of F0)

Calculated transmittance factors are used for all the measurements executed using the same luminometer.

Quality control of equipment

The procedures described in the IL-8 Luc protocol should be used (18).

▼ M8

Appendix 3.3

PROFICIENCY SUBSTANCES

Prior to routine use of the test described in this Appendix to test method B.71, laboratories should demonstrate technical proficiency by obtaining the expected IL-8 Luc assay prediction for the 9 substances recommended in Table 1 and by obtaining values that fall within the respective reference range for at least 8 out of the 9 proficiency substances (selected to represent the range of responses for skin sensitisation hazards). Other selection criteria were that the substances are commercially available, and that high-quality *in vivo* reference data as well as high quality *in vitro* data generated with the IL-8 Luc assay are available. Also, published reference data are available for the IL-8 Luc assay (6) (1).

Table 1

Recommended substances for demonstrating technical proficiency with the IL-8 Luc assay

Proficiency substances	CAS no.	State	Solubility in X-VIVO15 at 20 mg/ml	<i>In vivo</i> prediction (1)	IL-8 Luc prediction (2)	Reference range (µg/ml) (3)	
						CV05 (4)	IL-8 Luc MIT (5)
2,4-Dinitrochlorobenzene	97-00-7	Solid	Insoluble	Sensitiser(Extreme)	Positive	2.3-3.9	0.5-2.3
Formaldehyde	50-00-0	Liquid	Soluble	Sensitiser(Strong)	Positive	9-30	4-9
2-Mercaptobenzothiazole	149-30-4	Solid	Insoluble	Sensitiser(Moderate)	Positive	250-290	60-250
Ethylenediamine	107-15-3	Liquid	Soluble	Sensitiser(Moderate)	Positive	500-700	0.1-0.4
Ethyleneglycol dimethylacrylate	97-90-5	Liquid	Insoluble	Sensitiser(Weak)	Positive	> 2000	0.04-0.1
4-Allylanisole (Estragol)	140-67-0	Liquid	Insoluble	Sensitiser(Weak)	Positive	> 2000	0.01-0.07
Streptomycin sulphate	3810-74-0	Solid	Soluble	Non-sensitiser	Negative	> 2000	> 2000
Glycerol	56-81-5	Liquid	Soluble	Non-sensitiser	Negative	> 2000	> 2000
Isopropanol	67-63-0	Liquid	Soluble	Non-sensitiser	Negative	> 2000	> 2000

Abbreviations: CAS no. = Chemical Abstracts Service Registry Number

(1) The *in vivo* potency is derived using the criteria proposed by ECETOC (19).

(2) Based on historical observed values (1) (6).

(3) CV05 and IL-8 Luc MIT were calculated using water solubility given by EPI SuiteTM.

(4) CV05: the minimum concentration at which chemicals show less than 0,05 of Inh-GAPLA.

(5) MIT: the lowest concentrations at which a chemical satisfies the positive criteria.

▼ M8*Appendix 3.4*

INDEXES AND JUDGMENT CRITERIA

nIL8LA (nSLO-LA)

The j-th repetition ($j = 1-4$) of the i-th concentration ($i = 0-11$) is measured for IL8LA (SLO-LA) and GAPLA (SLR-LA) respectively. The normalised IL8LA, referred to as nIL8LA (nSLO-LA), and is defined as:

$$\text{nIL8LA}_{ij} = \text{IL8LA}_{ij} / \text{GAPLA}_{ij}$$

This is the basic unit of measurement in this assay.

Ind-IL8LA (FInSLO-LA)

The fold increase of the averaged nIL8LA (nSLO-LA) for the repetition on the i-th concentration compared with it at the 0 concentration, Ind-IL8LA, is the primary measure of this assay. This ratio is written by the following formula:

$$\text{Ind-IL8LA}_i = \left\{ (1/4) \times \sum_j \text{nIL8LA}_{ij} \right\} / \left\{ (1/4) \times \sum_j \text{nIL8LA}_{0j} \right\}$$

The lead laboratory has proposed that a value of 1.4 corresponds to a positive result for the tested chemical. This value is based on the investigation of the historical data of the lead laboratory. Data management team then used this value through all the phases of validation study. The primary outcome, Ind-IL8LA, is the ratio of 2 arithmetic means as shown in equation.

95 % confidence interval (95 % CI)

The 95 % confidence interval (95 % CI) based on the ratio can be estimated to show the precision of this primary outcome measure. The lower limit of the 95 % CI ≥ 1 indicates that the nIL8LA with the i-th concentration is significantly greater than that with solvent control. There are several ways to construct the 95 % CI. We used the method known as Fieller's theorem in this study. This 95 % confidence interval theorem is obtained from the following formula:

$$\left[\frac{-B - \sqrt{B^2 - 4AC}}{2A}, \frac{-B + \sqrt{B^2 - 4AC}}{2A} \right],$$

Where

$$A = \bar{x}_0^2 - t_{0.975(v)}^2 \times \frac{\text{sd}_0^2}{n_0},$$

$$B = -2 \times \bar{x} \times \bar{y},$$

$$C = \bar{y}_i^2 - t_{0.975(v)}^2 \times \frac{\text{sd}_{yi}^2}{n_{yi}}, \text{ and } n_0 = 4,$$

$$\bar{x}_0 = (1/n_0) \times \sum_j \text{nIL8LA}_{0j},$$

▼ M8

$$sd_0^2 = \{1/(n_0 - 1)\} \times \sum_j (nIL8LA_{0j} - \bar{x}_0)^2,$$

$$n_{yi} = 4,$$

$$\bar{y}_i = (1/n_{yi}) \times \sum_j (nIL8LA_{ij}),$$

$$sd_{yi}^2 = \{1/(n_{yj} - 1)\} \times \sum_j (nIL8LA_{ij} - \bar{y}_i)^2.$$

$t_{0,975(v)}$ is 97.5 percentile of the central t distribution with the v of the degree of freedom, where

$$v = \left(\frac{sd_0^2}{n_0} + \frac{sd_{yi}^2}{n_{yi}} \right) / \left\{ \left(\frac{sd_0^2}{n_0} \right)^2 / (n_0 - 1) + \left(\frac{sd_{yi}^2}{n_{yi}} \right) / (n_{yi} - 1) \right\}.$$

Inh-GAPLA (II-SLR-LA)

The Inh-GAPLA is a ratio of the averaged GAPLA (SLR-LA) for the repetition of the i -th concentration compared with that with solvent control, and this is written by

$$Inh - GAPLA_i = \left\{ (1/4) \times \sum_j GAPLA_{ij} \right\} / \left\{ (1/4) \times \sum_j GAPLA_{0j} \right\}.$$

Since the GAPLA is the denominator of the nIL8LA, an extremely small value causes large variation in the nIL8LA. Therefore, Ind-IL8LA values with an extremely small value of Inh-GAPLA (less than 0,05) might be considered poor precision.

▼ **M8**

Appendix 3.5

THE SCHEME OF THE METHODS TO DISSOLVE CHEMICALS FOR THE IL-8 LUC ASSAY.

(a) For chemicals dissolved in X-VIVO™ 15 at 20 mg/ml

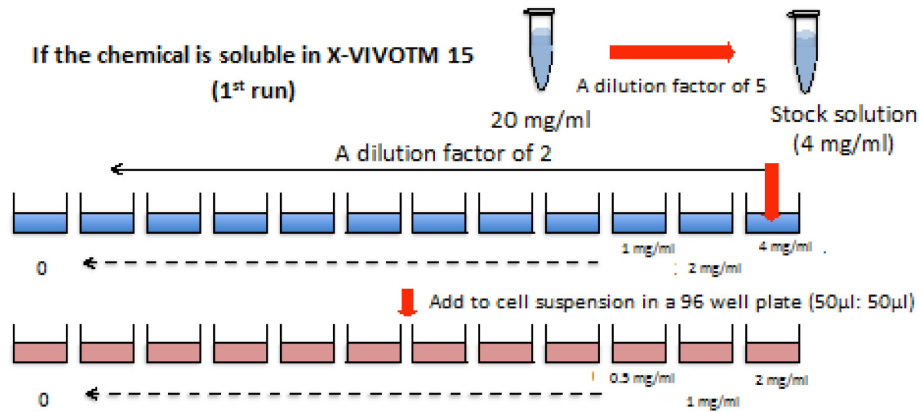

Determine the highest concentration of the following experiments

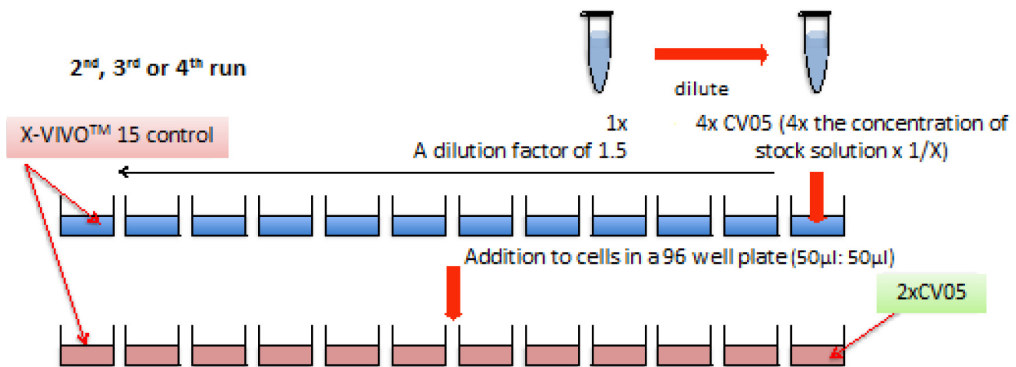
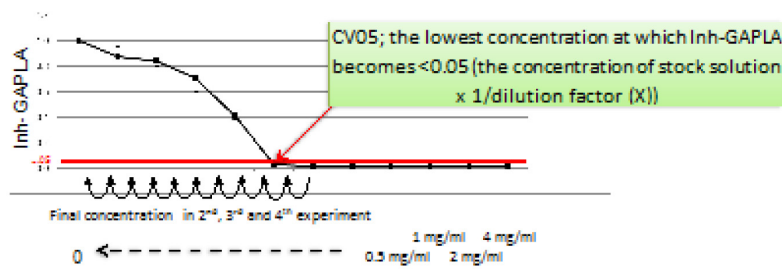

▼ **M8**

(b) For chemicals insoluble in X-VIVOTM 15 at 20 mg/ml

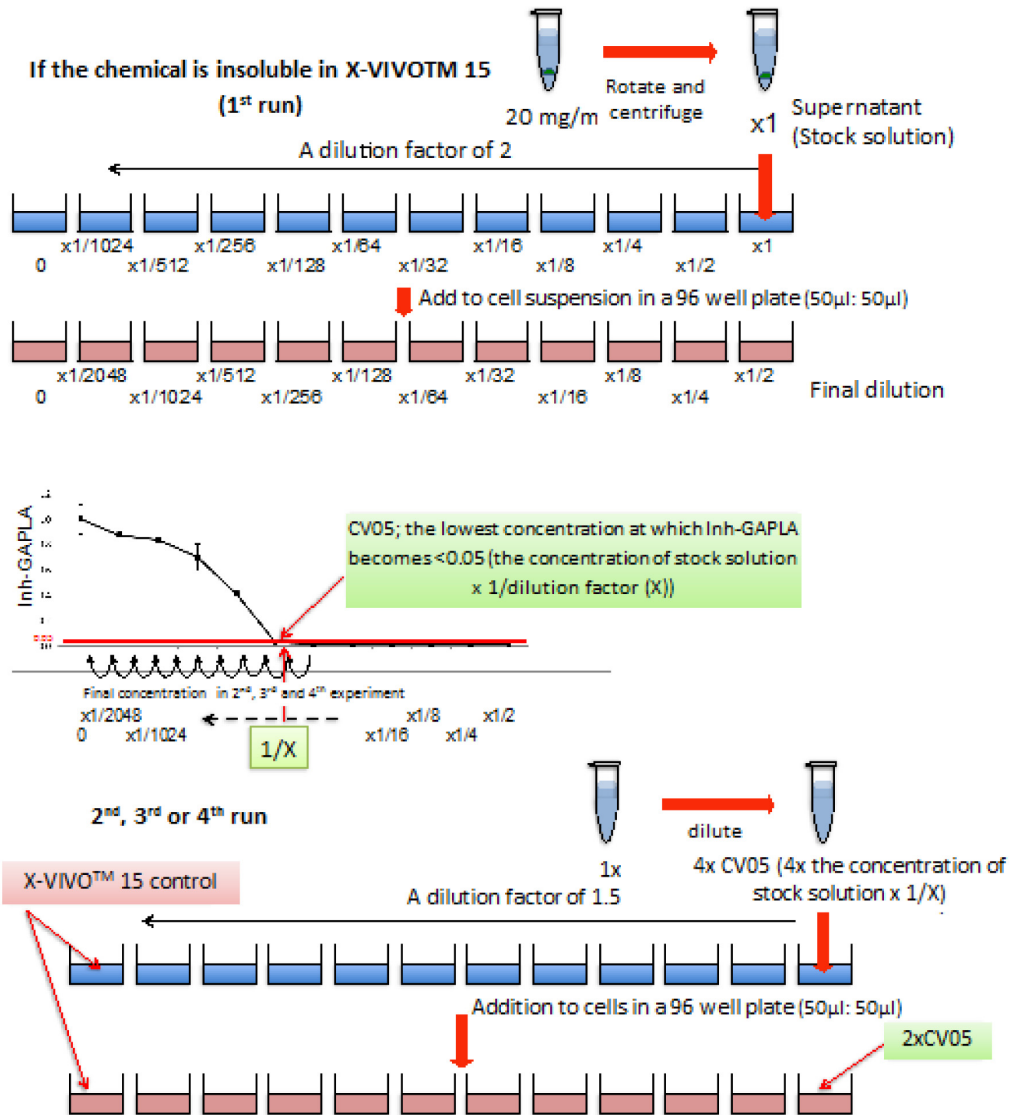

▼ **M8***Appendix 3.6*

THE SCHEME OF THE METHOD TO DISSOLVE 4-NBB FOR THE POSITIVE CONTROL OF THE IL-8 LUC ASSAY

The positive control : 4-NBB (insoluble in X-VIVO™ 15)

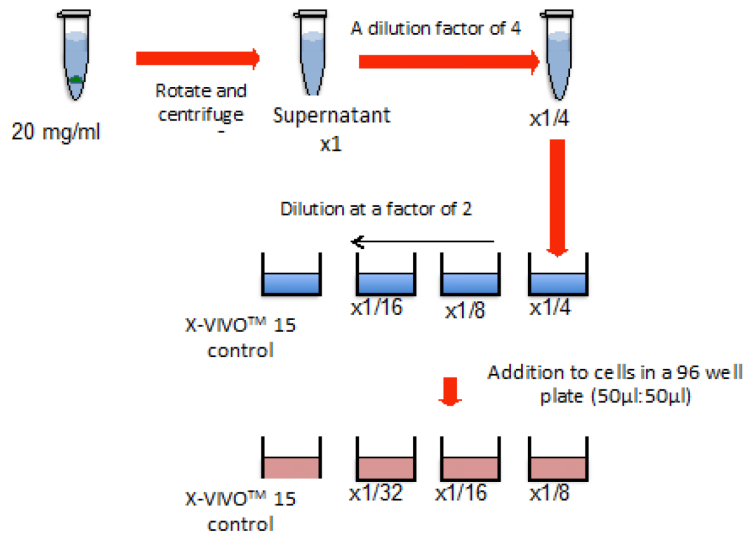

▼B**PART C: METHODS FOR THE DETERMINATION OF ECOTOXICITY**

TABLE OF CONTENTS

C.1.	ACUTE TOXICITY FOR FISH
C.2.	<i>DAPHNIA</i> SP. ACUTE IMMOBILISATION TEST
C.3.	FRESHWATER ALGA AND CYANOBACTERIA, GROWTH INHIBITION TEST
C.4.	DETERMINATION OF 'READY' BIODEGRADABILITY
PART I.	GENERAL CONSIDERATIONS
PART II.	DOC DIE-AWAY TEST (Method C.4-A)
PART III.	MODIFIED OECD SCREENING TEST (Method C.4-B)
PART IV.	CO ₂ EVOLUTION TEST (Method C.4-C)
PART V.	MANOMETRIC RESPIROMETRY TEST (Method C.4-D)
PART VI.	CLOSED BOTTLE TEST (Method C.4-E)
PART VII.	M.I.T.I. TEST (Method C.4-F)
C.5.	DEGRADATION — BIOCHEMICAL OXYGEN DEMAND
C.6.	DEGRADATION — CHEMICAL OXYGEN DEMAND
C.7.	DEGRADATION — ABIOTIC DEGRADATION: HYDROLYSIS AS A FUNCTION OF PH
C.8.	TOXICITY FOR EARTHWORMS
C.9.	BIODEGRADATION — ZAHN-WELLENS TEST
C.10.	SIMULATION TESTAEROBIC SEWAGE TREATMENT: C.10-A: ACTIVATED SLUDGE UNITS — C.10-B: BIOFILMS
C.11.	ACTIVATED SLUDGE, RESPIRATION INHIBITION TEST (CARBON AND AMMONIUM OXIDATION)
C.12.	BIODEGRADATION — MODIFIED SCAS TEST
C.13.	BIOACCUMULATION IN FISH: AQUEOUS AND DIETARY EXPOSURE
C.14.	FISH JUVENILE GROWTH TEST
C.15.	FISH, SHORT-TERM TOXICITY TEST ON <i>EMBRYO</i> AND SAC-FRY STAGES
C.16.	HONEYBEES — ACUTE ORAL TOXICITY TEST
C.17.	HONEYBEES — ACUTE CONTACT TOXICITY TEST
C.18.	ADSORPTION/DESORPTION USING A BATCH EQUILIBRIUM METHOD

▼B

- C.19. ESTIMATION OF THE ADSORPTION COEFFICIENT (K_{oc}) ON SOIL AND ON SEWAGE SLUDGE USING HIGH PERFORMANCE LIQUID CHROMATOGRAPHY (HPLC)
- C.20. *DAPHNIA MAGNA* REPRODUCTION TEST
- C.21. SOIL MICROORGANISMS: NITROGEN TRANSFORMATION TEST
- C.22. SOIL MICROORGANISMS: CARBON TRANSFORMATION TEST
- C.23. AEROBIC AND ANAEROBIC TRANSFORMATION IN SOIL
- C.24. AEROBIC AND ANAEROBIC TRANSFORMATION IN AQUATIC SEDIMENT SYSTEMS
- C.25. AEROBIC MINERALISATION IN SURFACE WATER — SIMULATION BIODEGRADATION TEST
- C.26. LEMNA SPECIES GROWTH INHIBITION TEST
- C.27. SEDIMENT-WATER CHIRONOMID TOXICITY TEST USING SPIKED SEDIMENT
- C.28. SEDIMENT-WATER CHIRONOMID TOXICITY TEST USING SPIKED WATER
- C.29. READY BIODEGRADABILITY — CO₂ IN SEALED VESSELS (HEADSPACE TEST)
- C.30. BIOACCUMULATION IN TERRESTRIAL OLIGOCHAETES
- C.31. TERRESTRIAL PLANT TEST: SEEDLING EMERGENCE AND SEEDLING GROWTH TEST
- C.32. ENCHYTRAEID REPRODUCTION TEST
- C.33. EARTHWORM REPRODUCTION TEST (*EISENIA FETIDA*/*EISENIA ANDREI*)
- C.34. DETERMINATION OF THE INHIBITION OF THE ACTIVITY OF ANAEROBIC BACTERIA — REDUCTION OF GAS PRODUCTION FROM ANAEROBICALLY DIGESTING (SEWAGE) SLUDGE
- C.35. SEDIMENT-WATER *LUMBRICULUS* TOXICITY TEST USING SPIKED SEDIMENT
- C.36. PREDATORY MITE (*HYPQASPIS* (*GEOLAEELAPS*) *ACULEIFER*) REPRODUCTION TEST IN SOIL
- C.37. 21-DAY FISH ASSAY: A SHORT-TERM SCREENING FOR OESTROGENIC AND ANDROGENIC ACTIVITY, AND AROMATASE INHIBITION
- C.38. THE AMPHIBIAN METAMORPHOSIS ASSAY
- C.39. COLLEMBOLAN REPRODUCTION TEST IN SOIL

▼B

- C.40. SEDIMENT-WATER CHIRONOMID LIFE-CYCLE TOXICITY TEST USING SPIKED WATER OR SPIKED SEDIMENT
- C.41. FISH SEXUAL DEVELOPMENT TEST
- C.42. BIODEGRADABILITY IN SEAWATER
- C.43. ANAEROBIC BIODEGRADABILITY OF ORGANIC SUBSTANCES IN DIGESTED SLUDGE: BY MEASUREMENT OF GAS PRODUCTION
- C.44. LEACHING IN SOIL COLUMNS
- C.45. ESTIMATION OF EMISSIONS FROM PRESERVATIVE — TREATED WOOD TO THE ENVIRONMENT: LABORATORY METHOD FOR WOODEN COMMODITIES THAT ARE NOT COVERED AND ARE IN CONTACT WITH FRESH WATER OR SEAWATER
- C.46. BIOACCUMULATION IN SEDIMENT-DWELLING BENTHIC OLIGOCHAETES
- C.47. FISH, EARLY-LIFE STAGE TOXICITY TEST
- C.48. FISH SHORT TERM REPRODUCTION ASSAY
- C.49. FISH EMBRYO ACUTE TOXICITY (FET) TEST
- C.50. SEDIMENT-FREE *MYRIOPHYLLUM SPICATUM* TOXICITY TEST
- C.51. WATER-SEDIMENT *MYRIOPHYLLUM SPICATUM* TOXICITY TEST
- C.52. MEDAKA EXTENDED ONE GENERATION REPRODUCTION TEST (MEOGRT)
- C.53. THE LARVAL AMPHIBIAN GROWTH AND DEVELOPMENT ASSAY (LAGDA)

▼B**C.1. ACUTE TOXICITY FOR FISH****1. METHOD****1.1. INTRODUCTION**

The purpose of this test is to determine the acute lethal toxicity of a substance to fish in fresh water. It is desirable to have, as far as possible, information on the water solubility, vapour pressure, chemical stability, dissociation constants and biodegradability of the substance to help in the selection of the most appropriate test method (static, semi-static or flow-through) for ensuring satisfactorily constant concentrations of the test substance over the period of the test.

Additional information (for instance structural formula, degree of purity, nature and percentage of significant impurities, presence and amounts of additives, and n-octanol/water partition coefficient) should be taken into consideration in both the planning of the test and interpretation of the results.

1.2. DEFINITIONS AND UNITS

Acute toxicity is the discernible adverse effect induced in an organism within a short time (days) of exposure to a substance. In the present test, acute toxicity is expressed as the median lethal concentration (LC_{50}) that is the concentration in water which kills 50 % of a test batch of fish within a continuous period of exposure which must be stated.

All concentrations of the test substance are given in weight by volume (milligrams per litre). They may also be expressed as weight by weight (mg/kg^{-1}).

1.3. REFERENCE SUBSTANCES

A reference substance may be tested as a means of demonstrating that under the laboratory test conditions the response of tested species have not changed significantly.

No reference substances are specified for this test.

1.4. PRINCIPLE OF THE TEST METHOD

A limit test may be performed at 100 mg per litre in order to demonstrate that the LC_{50} is greater than this concentration.

The fish are exposed to the test substance added to water at a range of concentrations for a period of 96 hours. Mortalities are recorded at least at 24-hour intervals, and the concentrations killing 50 % of the fish (LC_{50}) at each observation time are calculated where possible.

1.5. QUALITY CRITERIA

The quality criteria shall apply to the limit test as well as the full test method.

The mortality in the controls must not exceed 10 % (or one fish if less than ten are used) by the end of the test.

The dissolved oxygen concentration must have been more than 60 % of the air-saturation value throughout.

▼ B

The concentrations of the test substance shall be maintained to within 80 % of the initial concentrations throughout the duration of the test.

For substances which dissolve easily in the test medium, yielding stable solutions i.e. those which will not to any significant extent volatilise, degrade, hydrolyze or adsorb, the initial concentration can be taken as being equivalent to the nominal concentration. Evidence shall be presented that the concentrations have been maintained throughout the test and that the quality criteria have been satisfied.

For substances that are:

- (i) poorly soluble in the test medium, or
- (ii) capable of forming stable emulsions or dispersions, or
- (iii) not stable in aqueous solutions,

the initial concentration shall be taken as the concentration measured in solution (or, if technically not possible, measured in the water column) at the start of the test. The concentration shall be determined after a period of equilibration but before the introduction of the test fish.

In any of these cases, further measurements must be made during the test to confirm the actual exposure concentrations or that the quality criteria have been met.

The pH should not vary by more than 1 unit.

1.6. DESCRIPTION OF THE TEST METHOD

Three types of procedure can be used:

Static test:

Toxicity test in which no flow of test solution occurs. (Solutions remain unchanged throughout the duration of the test.)

Semi-static test:

Test without flow of test solution, but with regular batchwise renewal of test solutions after prolonged periods (e.g. 24 hours).

Flow-through test:

Toxicity test in which the water is renewed constantly in the test chambers, the chemical under test being transported with the water used to renew the test medium.

1.6.1. Reagents

1.6.1.1. Solutions of test substances

Stock solutions of the required strength are prepared by dissolving the substance in deionised water or water according to 1.6.1.2.

The chosen test concentrations are prepared by dilution of the stock solution. If high concentrations are tested, the substance may be dissolved in the dilution water directly.

▼B

The substances should normally only be tested up to the limit of solubility. For some substances (e.g. substances having low solubility in water, or high P_{ow} , or those forming stable dispersion rather than true solution in water), it is acceptable to run a test concentration above the solubility limit of the substance to ensure that the maximum soluble/stable concentration has been obtained. It is important, however, that this concentration will not otherwise disturb the test system (e.g. film of the substance on the water surface preventing the oxygenation of the water, etc.).

Ultrasonic dispersion, organic solvents, emulsifiers or dispersants may be used as an aid to prepare stock solutions of substances with low aqueous solubility or to help to disperse these substances in the test medium. When such auxiliary substances are used, all test concentrations should contain the same amount of auxiliary substance, and additional control fish should be exposed to the same concentration of the auxiliary substance as that used in the test series. The concentration of such auxiliaries should be minimised, but in no case should exceed 100 mg per litre in the test medium.

The test should be carried out without adjustment of the pH. If there is evidence of marked change in the pH, it is advised that the test should be repeated with pH adjustment and the results reported. In that case, the pH value of the stock solution should be adjusted to the pH value of the dilution water unless there are specific reasons not to do so. HCl and NaOH are preferred for this purpose. This pH adjustment should be made in such a way that the concentration of test substance in the stock solution is not changed to any significant extent. Should any chemical reaction or physical precipitation of the test compound be caused by the adjustment, this should be reported.

1.6.1.2. *Holding and dilution water*

Orinking-water supply (uncontaminated by potentially harmful concentrations of chlorine, heavy metals or other substances), good-quality natural water or reconstituted water (See Appendix 1) may be used. Waters with a total hardness of between 10 and 250 mg per litre (as $CaCO_3$) and with a pH from 6,0 to 8,5 are preferred.

1.6.2. **Apparatus**

All apparatus must be made of chemically inert material:

— automatic dilution system (for flow-through test),

— oxygen meter,

— equipment for determination of hardness of water,

— adequate apparatus for temperature control,

— pH meter.

1.6.3. **Test fish**

The fish should be in good health and free from any apparent malformation.

▼ B

The species used should be selected on the basis of practical criteria, such as their ready availability throughout the year, ease of maintenance, convenience for testing, relative sensitivity to chemicals, and any economic, biological or ecological factors which have any bearing. The need for comparability of the data obtained and existing international harmonisation (reference 1) should also be borne in mind when selecting the fish species.

A list of fish species which are recommended for the performance of this test is given in Appendix 2; Zebra fish and rainbow trout are the preferred species.

1.6.3.1. Holding

Test fish should preferably come from a single stock of similar length and age. The fish must be held for at least 12 days, in the following conditions:

loading:

appropriate to the system (recirculation or flow-through) and the fish species,

water:

see 1.6.1.2,

light:

12 to 16 hours illumination daily,

dissolved oxygen concentration:

at least 80 % of air-saturation value,

feeding:

three times per week or daily, ceasing 24 hours before the start of the test.

1.6.3.2. Mortality

Following a 48-hour settling-in period, mortalities are recorded and the following criteria applied:

— greater than 10 % of population in seven days:

rejection of entire batch,

— between 5 and 10 % of population:

holding period continued for seven additional days.

If no further mortalities occur, the batch is acceptable, otherwise it must be rejected,

— less than 5 % of population:

acceptance of the batch.

1.6.4. Adaptation

All fish must be exposed to water of the quality and the temperature to be used in the test for at least seven days before they are used.

▼B**1.6.5. Test procedure**

A range-finding test can precede a definitive test, in order to obtain information about the range of concentrations to be used in the main test.

One control without the test substance is run and, if relevant, one control containing the auxiliary substance is also run, in addition to the test series.

Depending on the physical and chemical properties of the test compound, a static, semi-static, or a flow-through test should be selected as appropriate, to fulfil the quality criteria.

Fish are exposed to the substance as described below:

- duration: 96 hours,
- number of animals: at least seven per concentration,
- tanks: of suitable capacity in relation to the recommended loading,
- loading: maximum loading of 1 g per litre for static and semi-static tests is recommended; for flow-through systems, higher loading is acceptable,
- test concentration: At least five concentrations differing by a constant factor not exceeding 2,2 and as far as possible spanning the range of 0 to 100 % mortality,
- water: see 1.6.1.2,
- light: 12 to 16 hours illumination daily,
- temperature: appropriate to the species (Appendix 2) but within ± 1 °C within any particular test,
- dissolved oxygen concentration: not less than 60 % of the air-saturation value at the selected temperature,
- feeding: none.

The fish are inspected after the first two to four hours and at least at 24-hour intervals. Fish are considered dead if touching of the caudal peduncle produces no reaction, and no breathing movements are visible. Dead fish are removed when observed and mortalities are recorded. Records are kept of visible abnormalities (e.g. loss of equilibrium, changes in swimming behaviour, respiratory function, pigmentation, etc.).

Measurements of pH, dissolved oxygen and temperature must be carried out daily.

Limit test

Using the procedures described in this test method, a limit test may be performed at 100 mg per litre in order to demonstrate that the LC_{50} is greater than this concentration.

If the nature of the substance is such that a concentration of 100 mg per litre in the test water cannot be attained, the limit test should be performed at a concentration equal to the solubility of the substance (or the maximum concentration forming a stable dispersion) in the medium used (see also point 1.6.1.1).

▼ B

The limit test should be performed using seven to 10 fish, with the same number in the control(s). (Binomial theory dictates that when 10 fish are used with zero mortality, there is a 99,9 % confidence that the LC_{50} is greater than the concentration used in the limit test. With 7, 8 or 9 fish, the absence of mortality provides at least 99 % confidence that the LC_{50} is greater than the concentration used.)

If mortalities occur, a full study must be carried out. If sublethal effects are observed, these should be recorded.

2. DATA AND EVALUATION

For each period where observations were recorded (24, 48, 72 and 96 hours), plot percentage mortality for each recommended exposure period against concentration on logarithmic-probability paper.

When possible and for each observation time, the LC_{50} and the confidence limits ($p = 0,05$) should be estimated using standard procedures; these values should be rounded off to one, or at most two significant figures (examples of rounding off to two figures: 170 for 173,5; 0,13 for 0,127; 1,2 for 1,21).

In those cases where the slope of the concentration/percentage response curve is too steep to permit calculation of the LC_{50} , a graphical estimate of this value is sufficient.

When two consecutive concentrations, at a ratio of 2,2 give only 0 and 100 % mortality, these two values are sufficient to indicate the range within which the LC_{50} falls.

If it is observed that the stability or homogeneity of the test substance cannot be maintained, this should be reported and care should be taken in the interpretation of the results.

3. REPORTING

The test report shall, if possible, include the following information:

- information about test fish (scientific name, strain, supplier, any pretreatment, size and number used in each test concentration),
- dilution-water source and major chemical characteristics (pH, hardness, temperature),
- in the case of a substance of low aqueous solubility, the method of preparation of stock and test solutions,
- concentration of any auxiliary substances,
- list of the concentrations used and any available information on the stability at the concentrations of the tested chemical in the test solution,
- if chemical analyses are performed, methods used and results obtained,
- results of the limit test if conducted,
- reasons for the choice and details of the test procedure used (e.g. static, semi-static, dosing rate, flow-through rate, whether aerated, fish loading, etc.),

▼ B

- description of test equipment,
- lighting regime,
- dissolved oxygen concentrations, pH values and temperatures of the test solutions every 24 hours,
- evidence that the quality criteria have been fulfilled,
- a table showing the cumulative mortality at each concentration and the control (and control with the auxiliary substance if required) at each of the recommended observation times,
- graph of the concentration/percentage response curve at the end of the test,
- if possible, the LC₅₀ values at each of the recommended observation times (with 95 % confidence limits),
- statistical procedures used for determining the LC₅₀ values,
- if a reference substance is used, the results obtained,
- highest test concentration causing no mortality within the period of the test,
- lowest test concentration causing 100 % mortality within the period of the test.

4. **REFERENCES**

- (1) OECD, Paris, 1981, Test Guideline 203, Decision of the Council C(81) 30 final and updates.
- (2) AFNOR — Determination of the acute toxicity of a substance to *Brachydanio rerio* — Static and Flow Through methods — NFT 90-303 June 1985.
- (3) AFNOR- Determination of the acute toxicity of a substance to *Salmo gairdneri* — Static and Flow — Through methods — NFT 90-305 June 1985.
- (4) ISO 7346/1,2 and/3 — Water Quality — Determination of the acute lethal toxicity of substances to a fresh water fish (*Brachydanio rerio* Hamilton-Buchanan-Teleostei, Cyprinidae). Part 1: Static method. Part 2: Semi-static method. Part 3: Flow-through method.
- (5) Eidgenössisches Department des Innern, Schweiz: Richtlinien für Probenahme und Normung von Wasseruntersuchungsmethoden -Part II 1974.
- (6) DIN Testverfahren mit Wasserorganismen, 38 412 (11) und 1 (15).
- (7) JIS K 0102, Acute toxicity test for fish.
- (8) NEN 6506- Water -Bepaling van de akute toxiciteit met behulp van *Poecilia reticulata*, 1980.
- (9) Environmental Protection Agency, Methods for the acute toxicity tests with fish, macroinvertebrates and amphibians. The Committee on Methods for Toxicity Tests with Aquatic Organisms, Ecological Research Series EPA-660-75-009, 1975.
- (10) Environmental Protection Agency, Environmental monitoring and support laboratory, Office of Research and Development, EPA-600/4-78-012, January 1978.

▼ B

- (11) Environmental Protection Agency, Toxic Substance Control, Part IV, 16 March 1979.
- (12) Standard methods for the examination of water and wastewater, fourteen edition, APHA-AWWA-WPCF, 1975.
- (13) Commission of the European Communities, Inter-laboratory test programme concerning the study of the ecotoxicity of a chemical substance with respect to the fish. EEC Study D.8368, 22 March 1979.
- (14) Verfahrensvorschlag des Umweltbundesamtes zum akuten Fisch-Test. Rudolph, P. und Boje, R. Okotoxikologie, Grundlagen für die okotoxikologische Bewertung von Umweltchemikalien nach dem Chemikaliengesetz, ecomed 1986.
- (15) Litchfield, J. T. and Wilcoxon, F., A simplified method for evaluating dose effects experiments, J. Pharm. tExp. Therap., 1949, vol. 96,99.
- (16) Finney, D.J. Statistical Methods in Biological Assay. Griffin, Weycombe, U.K., 1978.
- (17) Sprague, J.B. Measurement of pollutant toxicity to fish. Bioassay methods for acute toxicity. Water Res., 1969, vol. 3,793-821.
- (18) Sprague, J.B. Measurement of pollutant toxicity to fish. II Utilising and applying bioassay results. Water Res. 1970, vol. 4, 3-32.
- (19) Stephan, C.E. Methods for calculating an LC₅₀. In Aquatic Toxicology and Hazard Evaluation (edited by F.I. Mayer and J.L. Hamelink). American Society for Testing and Materials, ASTM STP 634, 1977, 65-84.
- (20) Stephan, C.E., Busch, K.A., Smith, R., Burke, J. and Andrews, R.W. A computer program for calculating an LC₅₀. US EPA.

▼ B*Appendix 1***Reconstituted water***Example of a suitable dilution water*

All chemicals must be of analytical grade.

The water should be good-quality distilled water, or deionised water with a conductivity of less than $5 \mu\text{Scm}^{-1}$.

Apparatus for distillation of water must not contain any parts made of copper.

Stock solutions

$\text{CaCl}_2 \cdot 2\text{H}_2\text{O}$ (calcium chloride dihydrate): 11,76 g

Dissolve in, and make up to 1 litre with water.

$\text{MgSO}_4 \cdot 7\text{H}_2\text{O}$ (magnesium sulphate heptahydrate): 4,93 g

Dissolve in, and make up to 1 litre with water.

NaHCO_3 (sodium hydrogen carbonate): 2,59 g

Dissolve in, and make up to 1 litre with water.

KCl (potassium chloride): 0,23 g

Dissolve in, and make up to 1 litre with water.

Reconstituted dilution water

Mix 25 ml of each of the four stock solutions and make up to 1 litre with water.

Aerate until the dissolved oxygen concentration equals the air-saturation value.

The pH should be $7,8 \pm 0,2$.

If necessary adjust the pH with NaOH (sodium hydroxide) or HCl (hydrochloric acid).

The dilution water so prepared is set aside for about 12 hours and must not be further aerated.

The sum of the Ca and Mg ions in this solution is 2,5 mmol per litre. The ratio of Ca:Mg ions is 4:1 and of Na:K ions is 10:1. The total alkalinity of this solution is 0,8 mmol per litre.

Any deviation in the preparation of the dilution water must not change the composition or properties of the water.

▼ B*Appendix 2***Fish species recommended for testing**

Recommended species	Recommended range of test temperature (°C)	Recommended total length of test animal (cm)
<i>Brachydanio rerio</i> (<i>Teleostei, Cyprinidae</i>) (Hamilton-Buchanan) Zebra-fish	20 to 24	3,0 ± 0,5
<i>Pimephales promelas</i> (<i>Teleostei, Cyprinidae</i>) (Rafinesque) Fathead minnow	20 to 24	5,0 ± 2,5
<i>Cyprinus carpio</i> (<i>Teleostei, Cyprinidae</i>) (Linnaeus 1758) Common carp	20 to 24	6,0 ± 2,0
<i>Oryzias latipes</i> (<i>Teleostei, Poeciliidae</i>) Cyprinodontidae (Tomminck and Schlege 1850) Red killifish	20 to 24	3,0 ± 1,0
<i>Poecilia reticulata</i> (<i>Teleostei, Poeciliidae</i>) (Peters 1859) Guppy	20 to 24	3,0 ± 1,0
<i>Lepomis macrochirus</i> (<i>Teleostei, Centrarchidae</i>) (Rafinesque Linnaeus 1758) Bluegill	20 to 24	5,0 ± 2,0
<i>Onchorhynchus mykiss</i> (<i>Teleostei, Salmonidae</i>) (Walbaum 1988) Rainbow trout	12 to 17	6,0 ± 2,0
<i>Leuciscus idus</i> (<i>Teleostei, Cyprinidae</i>) (Linnaeus 1758) Golden Orfe	20 to 24	6,0 ± 2,0

Collection

The fish listed above are easy to rear and/or are widely available throughout the year. They are capable of being bred and cultivated either in fish farms or in the laboratory, under disease — and parasite — controlled conditions, so that the test animal will be healthy and of known parentage. These fish are available in many parts of the world.

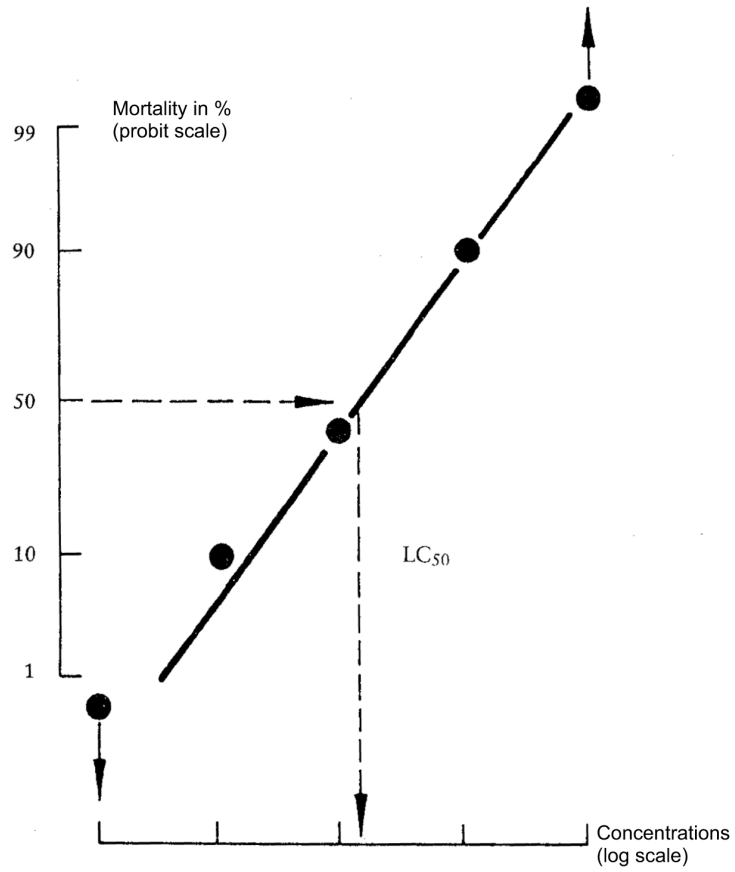
▼ B*Appendix 3***Example of concentration: percentage mortality**Example of determination of LC_{50} using log-probit paper

▼ B**C.2. DAPHNIA SP. ACUTE IMMOBILISATION TEST****1. METHOD**

This acute immobilisation testing method is equivalent to the OECD TG 202 (2004).

1.1. INTRODUCTION

This method describes an acute toxicity test to assess effects of chemicals towards daphnids. Existing test methods were used to the extent possible (1)(2)(3).

1.2. DEFINITIONS

In the context of this method, the following definitions are used:

EC₅₀: is the concentration estimated to immobilise 50 % of the daphnids within a stated exposure period. If another definition is used, this must be reported, together with its reference.

Immobilisation: those animals that are not able to swim within 15 seconds, after gentle agitation of the test vessel are considered to be immobilised (even if they can still move their antennae).

1.3. PRINCIPLE OF THE TEST METHOD

Young daphnids, aged less than 24 hours at the start of the test, are exposed to the test substance at a range of concentrations for a period of 48 hours. Immobilisation is recorded at 24 hours and 48 hours and compared with control values. The results are analysed in order to calculate the EC₅₀ at 48h (see Section 1.2 for definitions). Determination of the EC₅₀ at 24h is optional.

1.4. INFORMATION ON THE TEST SUBSTANCE

The water solubility and the vapour pressure of the test substance should be known and a reliable analytical method for the quantification of the substance in the test solutions with reported recovery efficiency, and limit of determination should be available. Useful information includes the structural formula, purity of the substance, stability in water or light, P_{ow} and results of a test for ready biodegradability (see method C.4).

Note: guidance for testing substances with physical chemical properties that made them difficult to test is provided in (4).

1.5. REFERENCE SUBSTANCES

A reference substance may be tested for EC₅₀ as a means of assuring that the test conditions are reliable. Toxicants used in international ring-tests (1)(5) are recommended for this purpose (1). Test(s) with a reference substance should be done preferably every month and at least twice a year.

(1) The results of these inter laboratory tests and a Technical Corrigendum to ISO 6341 give an EC₅₀ — 24 h of the potassium dichromate (K₂Cr₂O₇) within the range 0,6 mg/l to 1,7 mg/l.

▼ B

1.6. QUALITY CRITERIA

For a test to be valid, the following performance criteria apply:

- in the controls, including the control containing the solubilising agent, not more than 10 % of the daphnids should have been immobilised;

- the dissolved oxygen concentration at the end of the test should be ≥ 3 mg/l in control and test vessels.

Note: For the first criterion, not more than 10 % of the control daphnids should show immobilisation or other signs of disease or stress, for example, discoloration, unusual behaviour such as trapping at surface of water.

1.7. DESCRIPTION OF THE TEST METHOD

1.7.1. **Apparatus**

Test vessels and other apparatus that will come into contact with the test solutions should be made entirely of glass or other chemically inert material. Test vessels will normally be glass test tubes or beakers; they should be cleaned before each use using standard laboratory procedures. Test vessels should be loosely covered to reduce the loss of water due to evaporation and to avoid the entry of dust into the solutions. Volatile substances should be tested in completely filled closed vessels, large enough to prevent oxygen becoming limiting or too low (see Section 1.6 and first paragraph of Section 1.8.3).

In addition some or all of the following equipment will be used: oxygen-meter (with microelectrode or other suitable equipment for measuring dissolved oxygen in low volumes samples); pH-meter; adequate apparatus for temperature control; equipment for the determination of total organic carbon concentration (TOC); equipment for the determination of chemical oxygen demand (COD); equipment for the determination of hardness, etc.

1.7.2. **Test organism**

Daphnia magna Straus is the preferred test species although other suitable *Daphnia* species can be used in this test (e.g. *Daphnia pulex*). At the start of the test, the animals should be less than 24 hours old and to reduce variability, it is strongly recommended they are not first brood progeny. They should be derived from a healthy stock (i.e. showing no signs of stress such as high mortality, presence of males and ephippia, delay in the production of the first brood, discoloured animals, etc.). All organisms used for a particular test should have originated from cultures established from the same stock of daphnids. The stock animals must be maintained in culture conditions (light, temperature, medium) similar to those to be used in the test. If the daphnids culture medium to be used in the test is different from that used for routine daphnids culture, it is good practice to include a pre-test acclimation period. For that, brood daphnids should be maintained in dilution water at the test temperature for at least 48 hours prior to the start of the test.

▼B**1.7.3. Holding and dilution water**

Natural water (surface or ground water), reconstituted water or dechlorinated tap water are acceptable as holding and dilution water if daphnids will survive in it for the duration of the culturing, acclimation and testing without showing signs of stress. Any water which conforms to the chemical characteristics of an acceptable dilution water as listed in Appendix 1 is suitable as a test water. It should be of constant quality during the period of the test. Reconstituted water can be made up by adding specific amounts of reagents of recognised analytical grade to deionised or distilled water. Examples of reconstituted water are given in (1) (6) and in Appendix 2. Note that media containing known chelating agents, such as M4 and M7 media in Appendix 2, should be avoided for testing substances containing metals. The pH should be in the range of 6 to 9. Hardness between 140 and 250 mg/l (as CaCO₃) is recommended for *Daphnia magna*, while lower hardness may be also appropriate for other *Daphnia* species. The dilution water may be aerated prior to use for the test so that the dissolved oxygen concentration has reached saturation.

If natural water is used, the quality parameters should be measured at least twice a year or whenever it is suspected that these characteristics may have changed significantly (see previous paragraph and Appendix 1). Measurements of heavy metals (e.g. Cu, Pb, Zn, Hg, Cd, Ni) should also be made. If dechlorinated tap water is used, daily chlorine analysis is desirable. If the dilution water is from a surface or ground water source, conductivity and total organic carbon (TOC) or chemical oxygen demand (COD) should be measured.

1.7.4. Test solutions

Test solutions of the chosen concentrations are usually prepared by dilution of a stock solution. Stock solutions should preferably be prepared by dissolving the test substance in the dilution water. As far as possible, the use of solvents, emulsifiers or dispersants should be avoided. However, such compounds may be required in some cases in order to produce a suitably concentrated stock solution. Guidance for suitable solvents, emulsifiers and dispersants is given in (4). In any case, the test substance in the test solutions should not exceed the limit of solubility in the dilution water.

The test should be carried out without the adjustment of pH. If the pH does not remain in the range 6-9, then a second test could be carried out, adjusting the pH of the stock solution to that of the dilution water before addition of the test substance. The pH adjustment should be made in such a way that the stock solution concentration is not changed to any significant extent and that no chemical reaction or precipitation of the test substance is caused. HCl and NaOH are preferred.

▼ B

1.8. PROCEDURE

1.8.1. **Conditions of exposure**1.8.1.1. *Test groups and controls*

Test vessels are filled with appropriate volumes of dilution water and solutions of test substance. Ratio of air/water volume in the vessel should be identical for test and control group. Daphnids are then placed into test vessels. At least 20 animals, preferably divided into four groups of five animals each, should be used at each test concentration and for the controls. At least 2 ml of test solution should be provided for each animal (i.e. a volume of 10 ml for five daphnids per test vessel). The test may be carried out using semi-static renewal or flow-through system when the concentration of the test substance is not stable.

One dilution-water control series and also, if relevant, one control series containing the solubilising agent must be run in addition to the treatment series.

1.8.1.2. *Test concentrations*

A range-finding test may be conducted to determine the range of concentrations for the definitive test unless information on toxicity of the test substance is available. For this purpose, the daphnids are exposed to a series of widely spaced concentrations of the test substance. Five daphnids should be exposed to each test concentration for 48 hours or less, and no replicates are necessary. The exposure period may be shortened (e.g. 24 hours or less) if data suitable for the purpose of the range-finding test can be obtained in less time.

At least five test concentrations should be used. They should be arranged in a geometric series with a separation factor preferably not exceeding 2,2. Justification should be provided if fewer than five concentrations are used. The highest concentration tested should preferably result in 100 % immobilisation, and the lowest concentration tested should preferably give no observable effect.

1.8.1.3. *Incubation conditions*

The temperature should be within the range of 18 °C and 22 °C, and for each single test it should be constant within ± 1 °C. A 16-hour light and eight-hour dark cycle is recommended. Complete darkness is also acceptable, especially for the test substances unstable in light.

The test vessels must not be aerated during the test. The test is carried out without adjustment of pH. The daphnids should not be fed during the test.

1.8.1.4. *Duration*

The test duration is 48 hours.

1.8.2. **Observations**

Each test vessel should be checked for immobilised daphnids at 24 and 48 hours after the beginning of the test (see Section 1.2 for definitions). In addition to immobility, any abnormal behaviour or appearance should be reported.

▼ B**1.8.3. Analytical measurements**

The dissolved oxygen and pH are measured at the beginning and end of the test in the control(s) and in the highest test substance concentration. The dissolved oxygen concentration in controls should be in compliance with the validity criterion (see Section 1.6). The pH should normally not vary by more than 1,5 units in any one test. The temperature is usually measured in control vessels or in ambient air and it should be recorded preferably continuously during the test or, as a minimum, at the beginning and end of the test.

The concentration of the test substance should be measured, as a minimum, at the highest and lowest test concentration, at the beginning and end of the test (4). It is recommended that results be based on measured concentrations. However, if evidence is available to demonstrate that the concentration of the test substance has been satisfactorily maintained within $\pm 20\%$ of the nominal or measured initial concentration throughout the test, then the results can be based on nominal or measured initial values.

1.9. LIMIT TEST

Using the procedures described in this Method, a limit test may be performed at 100 mg/l of test substance or up to its limit of solubility in the test medium (whichever is the lower) in order to demonstrate that the EC_{50} is greater than this concentration. The limit test should be performed using 20 daphnids (preferably divided into four groups of five), with the same number in the control(s). If any immobilisation occurs, a full study should be conducted. Any observed abnormal behaviour should be recorded.

2. DATA

Data should be summarised in tabular form, showing for each treatment group and control, the number of daphnids used, immobilisation at each observation. The percentages immobilised at 24 hours and 48 hours are plotted against test concentrations. Data are analysed by appropriate statistical methods (e.g. probit analysis, etc.) to calculate the slopes of the curves and the EC_{50} with 95 % confidence limits ($p = 0,05$) (7) (8).

Where the standard methods of calculating the EC_{50} , are not applicable to the data obtained, the highest concentration causing no immobility and the lowest concentration producing 100 % immobility should be used as an approximation for the EC_{50} (this being considered the geometric mean of these two concentrations).

3. REPORTING**3.1. TEST REPORT**

The test report must include the following:

Test substance:

— physical nature and relevant physical-chemical properties,

▼ B

- chemical identification data, including purity.

Test species:

- source and species of *Daphnia*, supplier of source (if known) and the culture conditions used (including source, kind and amount of food, feeding frequency).

Test conditions:

- description of test vessels: type of vessels, volume of solution, number of daphnids per test vessel, number of test vessels (replicates) per concentration,
- methods of preparation of stock and test solutions including the use of any solvent or dispersants, concentrations used,
- details of dilution water: source and water quality characteristics (pH, hardness, Ca/Mg ratio, Na/K ratio, alkalinity, conductivity, etc.); composition of reconstituted water if used,
- incubation conditions: temperature, light intensity and periodicity, dissolved oxygen, pH, etc.

Results:

- the number and percentage of daphnids that were immobilised or showed any adverse effects (including abnormal behaviour) in the controls and in each treatment group, at each observation time and a description of the nature of the effects observed,
- results and date of test performed with reference substance, if available,
- the nominal test concentrations and the result of all analyses to determine the concentration of the test substance in the test vessels; the recovery efficiency of the method and the limit of determination should also be reported,
- all physical-chemical measurements of temperature, pH and dissolved oxygen made during the test,
- the EC₅₀ at 48 h for immobilisation with confidence intervals and graphs of the fitted model used for their calculation, the slopes of the dose-response curves and their standard error; statistical procedures used for determination of EC₅₀; (these data items for immobilisation at 24 h should also be reported when they were measured),
- explanation for any deviation from the Testig Method and whether the deviation affected the test results.

4. REFERENCES

- (1) ISO 6341. (1996). Water quality — Determination of the inhibition of the mobility of *Daphnia magna* Straus (Cladocera, Crustacea) — Acute toxicity test. Third edition, 1996.
- (2) EPA OPPTS 850.1010. (1996). Ecological Effects Test Guidelines — Aquatic Invertebrate Acute Toxicity Test, Freshwater Daphnids.

▼B

- (3) Environment Canada. (1996) Biological test method. Acute Lethality Test Using *Daphnia* spp. EPS 1/RM/11. Environment Canada, Ottawa, Ontario, Canada.
- (4) Guidance Document on Aquatic Toxicity Testing of Difficult Substances and Mixtures. OECD Environmental Health and Safety Publication. Series on Testing and Assessment. No 23. Paris 2000.
- (5) Commission of the European Communities. Study D8369. (1979). Inter-laboratory Test Programme concerning the study of the ecotoxicity of a chemical substance with respect to *Daphnia*.
- (6) OECD Guidelines for the Testing of Chemicals. Guideline 211: *Daphnia magna* Reproduction Test, adopted September 1998.
- (7) Stephan C.E. (1977). Methods for calculating an LC₅₀. In Aquatic Toxicology and Hazard Evaluation (edited by F.I. Mayer and J.L. Hamelink). ASTM STP 634 — American Society for Testing and Materials. p. 65-84
- (8) Finney D.J. (1978). Statistical Methods in Biological Assay. 3rd ed. London. Griffin, Weycombe, UK.

▼B*Appendix 1***SOME CHEMICAL CHARACTERISTICS OF AN ACCEPTABLE
DILUTION WATER**

Substance	Concentration
Particulate matter	< 20 mg/l
Total organic carbon	< 2 mg/l
Unionised ammonia	< 1 µg/l
Residual chlorine	< 10 µg/l
Total organophosphorus pesticides	< 50 ng/l
Total organochlorine pesticides plus polychlorinated biphenyls	< 50 ng/l
Total organic chlorine	< 25 ng/l



Appendix 2

EXAMPLES OF SUITABLE RECONSTITUTED TEST WATER

ISO Test water (I)

Stock solutions (single substance)		To prepare the reconstituted water, add the following volumes of stock solutions to 1 litre water (*)
Substance	Amount added to 1 litre water (*)	
Calcium chloride CaCl ₂ , 2H ₂ O	11,76 g	25 ml
Magnesium sulfate MgSO ₄ , 7H ₂ O	4,93 g	25 ml
Sodium bicarbonate NaHCO ₃	2,59 g	25 ml
Potassium chloride KCl	0,23 g	25 ml

(*) Water of suitable purity, e.g. deionised, distilled or reverse osmosis with conductivity preferably not exceeding 10 $\mu\text{S}\cdot\text{cm}^{-1}$.

Elendt M7 and M4 medium

Acclimation to Elendt M4 and M7 medium

Some laboratories have experienced difficulty in directly transferring *Daphnia* to M4 and M7 media. However, some success has been achieved with gradual acclimation, i.e. moving from own medium to 30 % Elendt, then to 60 % Elendt and then to 100 % Elendt. The acclimation periods may need to be as long as one month.

Preparation

Trace element

Separate stock solutions (I) of individual trace elements are first prepared in water of suitable purity, e.g. deionised, distilled or reverse osmosis. From these different stock solutions (I) a second single stock solution (II) is prepared, which contains all trace elements (combined solution), i.e.:

Stock solution(s) I (single substance)	Amount added to water (mg/l)	Concentration (related to medium M4)	To prepare the combined stock solution II, add the following amount of stock solution I to water (ml/l)	
			M4	M7
H ₃ BO ₃	57 190	20 000-fold	1,0	0,25
MnCl ₂ .4H ₂ O	7 210	20 000-fold	1,0	0,25
LiCl	6 120	20 000-fold	1,0	0,25

▼ B

Stock solution(s) I (single substance)	Amount added to water (mg/l)	Concentration (related to medium M4)	To prepare the combined stock solution II, add the following amount of stock solution I to water (ml/l)	
			M4	M7
RbCl	1 420	20 000-fold	1,0	0,25
SrCl ₂ ·6H ₂ O	3 040	20 000-fold	1,0	0,25
NaBr	320	20 000-fold	1,0	0,25
Na ₂ MoO ₄ ·2H ₂ O	1 230	20 000-fold	1,0	0,25
CuCl ₂ ·2H ₂ O	335	20 000-fold	1,0	0,25
ZnCl ₂	260	20 000-fold	1,0	1,0
CoCl ₂ ·6H ₂ O	200	20 000-fold	1,0	1,0
KI	65	20 000-fold	1,0	1,0
Na ₂ SeO ₃	43,8	20 000-fold	1,0	1,0
NH ₄ VO ₃	11,5	20 000-fold	1,0	1,0
Na ₂ EDTA·2H ₂ O	5 000	2 000-fold	—	—
FeSO ₄ ·7H ₂ O	1 991	2 000-fold	—	—

Both Na 2 EDTA and FeSO₄ solutions are prepared singly, poured together and autoclaved immediately.

This gives:

2 l Fe-EDTA solution		1 000-fold	20,0	5,0
----------------------	--	------------	------	-----

M4 and M7 media

M4 and M7 media are prepared using stock solution II, the macro-nutrients and vitamin as follows:

	Amount added to water (mg/l)	Concentration (related to medium M4)	Amount of stock solution II added to prepare medium (ml/l)	
			M4	M7
Stock solution II (combined trace elements)		20-fold	50	50
Macro nutrient stock solutions (single substance)				
CaCl ₂ · 2H ₂ O	293 800	1 000-fold	1,0	1,0
MgSO ₄ · 7H ₂ O	246 600	2 000-fold	0,5	0,5
KCl	58 000	10 000-fold	0,1	0,1
NaHCO ₃	64 800	1 000-fold	1,0	1,0
Na ₂ SiO ₃ · 9H ₂ O	50 000	5 000-fold	0,2	0,2
NaNO ₃	2 740	10 000-fold	0,1	0,1
KH ₂ PO ₄	1 430	10 000-fold	0,1	0,1
K ₂ HPO ₄	1 840	10 000-fold	0,1	0,1

▼ B

	Amount added to water (mg/l)	Concentration (related to medium M4)	Amount of stock solution II added to prepare medium (ml/l)	
			M4	M7
Combined Vitamin stock	—	10 000-fold	0,1	0,1

The combined vitamin stock solution is prepared by adding the 3 vitamin to 1 litre water, as shown below:

Thiamine hydrochloride	750	10 000-fold		
Cyanocobalamine (B ₁₂)	10	10 000-fold		
Biotine	7,5	10 000-fold		

The combined vitamin stock is stored frozen in small aliquots. Vitamins are added to the media shortly before use.

N.B: to avoid precipitation of salts when preparing the complete media, add the aliquots of stock solutions to about 500-800 ml deionised water and then fill up to 1 litre.

N.B: the first publication of the M4 medium can be found in Elendt, B. P. (1990). Selenium deficiency in crustacea; an ultrastructural approach to antennal damage in *Daphnia magna* Straus. *Protoplasma*, 154, 25-33.

▼M6**C.3. FRESHWATER ALGA AND CYANOBACTERIA, GROWTH INHIBITION TEST**

INTRODUCTION

1. This test method is equivalent to OECD test guideline (TG) 201 (2006, annex corrected in 2011). The need to extend the test method to include additional species and update it to meet the requirements for hazard assessment and classification of chemicals has been identified. This revision has been completed on the basis of extensive practical experience, scientific progress in the field of algal toxicity studies, and extensive regulatory use, which has occurred since the original adoption.
2. Definitions used are given in Appendix 1.

PRINCIPLE OF THE TEST

3. The purpose of this test is to determine the effects of a chemical on the growth of freshwater microalgae and/or cyanobacteria. Exponentially growing test organisms are exposed to the test chemical in batch cultures over a period of normally 72 hours. In spite of the relatively brief test duration, effects over several generations can be assessed.
4. The system response is the reduction of growth in a series of algal cultures (test units) exposed to various concentrations of a test chemical. The response is evaluated as a function of the exposure concentration in comparison with the average growth of replicate, unexposed control cultures. For full expression of the system response to toxic effects (optimal sensitivity), the cultures are allowed unrestricted exponential growth under nutrient sufficient conditions and continuous light for a sufficient period of time to measure reduction of the specific growth rate.
5. Growth and growth inhibition are quantified from measurements of the algal biomass as a function of time. Algal biomass is defined as the dry weight per volume, e.g. mg algae/litre test solution. However, dry weight is difficult to measure and therefore surrogate parameters are used. Of these surrogates, cell counts are most often used. Other surrogate parameters include cell volume, fluorescence, optical density, etc. A conversion factor between the measured surrogate parameter and biomass should be known.
6. The test endpoint is inhibition of growth, expressed as the logarithmic increase in biomass (average specific growth rate) during the exposure period. From the average specific growth rates recorded in a series of test solutions, the concentration bringing about a specified x % inhibition of growth rate (e.g. 50 %) is determined and expressed as the E_xC_x (e.g. E_xC_{50}).
7. An additional response variable used in this test method is yield, which may be needed to fulfil specific regulatory requirements in some countries. It is defined as the biomass at the end of the exposure period minus the biomass at the start of the exposure period. From the yield recorded in a series of test solutions, the concentration bringing about a specified x % inhibition of yield (e.g., 50 %) is calculated and expressed as the E_yC_x (e.g. E_yC_{50}).
8. In addition, the lowest observed effect concentration (LOEC) and the no observed effect concentration (NOEC) may be statistically determined.

▼ M6

INFORMATION ON THE TEST CHEMICAL

9. Information on the test chemical which may be useful in establishing the test conditions includes structural formula, purity, stability in light, stability under the conditions of the test, light absorption properties, pK_a , and results of studies of transformation including biodegradability in water.

10. The water solubility, octanol water partition coefficient (P_{ow}) and vapour pressure of the test chemical should be known and a validated method for the quantification of the chemical in the test solutions with reported recovery efficiency and limit of detection should be available.

VALIDITY OF THE TEST

11. For the test to be valid, the following performance criteria should be met:
 - The biomass in the control cultures should have increased exponentially by a factor of at least 16 within the 72-hour test period. This corresponds to a specific growth rate of $0,92 \text{ day}^{-1}$. For the most frequently used species the growth rate is usually substantially higher (see Appendix 2). This criterion may not be met when species that grow slower than those listed in Appendix 2 are used. In this case, the test period should be extended to obtain at least a 16-fold growth in control cultures, while the growth has to be exponential throughout the test period. The test period may be shortened to at least 48 hours to maintain unlimited, exponential growth during the test as long as the minimum multiplication factor of 16 is reached.

 - The mean coefficient of variation for section-by-section specific growth rates (days 0-1, 1-2 and 2-3, for 72-hour tests) in the control cultures (See Appendix 1 under 'coefficient of variation') must not exceed 35 %. See paragraph 49 for the calculation of section-by-section specific growth rate. This criterion applies to the mean value of coefficients of variation calculated for replicate control cultures.

 - The coefficient of variation of average specific growth rates during the whole test period in replicate control cultures must not exceed 7 % in tests with *Pseudokirchneriella subcapitata* and *Desmodesmus subspicatus*. For other less frequently tested species, the value should not exceed 10 %.

REFERENCE CHEMICAL

12. Reference chemical(s), such as 3,5-dichlorophenol used in the international ring test (1), may be tested as a means of checking the test procedure. Potassium dichromate can also be used as a reference chemical for green algae. It is desirable to test a reference chemical at least twice a year.

APPLICABILITY OF THE TEST

13. This test method is most easily applied to water-soluble chemicals which, under the conditions of the test, are likely to remain in the water. For testing of chemicals that are volatile, strongly adsorbing, coloured, having a low solubility in water or chemicals that may affect the availability of nutrients or minerals in the test medium, certain modifications of the described

▼ M6

procedure may be required (e.g., closed system, conditioning of the test vessels). Guidance on some appropriate modifications is given in (2) (3) and (4).

DESCRIPTION OF THE TEST METHOD**Apparatus**

14. Test vessels and other apparatus which will come into contact with the test solutions should be made entirely of glass or other chemically inert material. The items should be thoroughly washed to ensure that no organic or inorganic contaminants may interfere with the algal growth or composition of the test solutions.
15. The test vessels will normally be glass flasks of dimensions that allow a sufficient volume of culture for measurements during the test and a sufficient mass transfer of CO₂ from the atmosphere (see paragraph 30). Note that the liquid volume must be sufficient for analytical determinations (see paragraph 37).
16. In addition some or all of the following equipment may be required:
 - Culturing apparatus: a cabinet or chamber is recommended, in which the chosen incubation temperature can be maintained at ± 2 °C.
 - Light measurement instruments: it is important to note that the method of measurement of light intensity, and in particular the type of receptor (collector), may affect the measured value. Measurements should preferably be made using a spherical (4π) receptor (which responds to direct and reflected light from all angles above and below the plane of measurement), or a 2π receptor (which responds to light from all angles above the measurement plane).
 - Apparatus to determine algal biomass. Cell count, which is the most frequently used surrogate parameter for algal biomass, may be made using an electronic particle counter, a microscope with counting chamber, or a flow cytometer. Other biomass surrogates can be measured using a flow cytometer, fluorimeter, spectrophotometer or colorimeter. A conversion factor relating cell count to dry weight is useful to calculate. In order to provide useful measurements at low biomass concentrations when using a spectrophotometer, it may be necessary to use cuvettes with a light path of at least 4 cm.

Test organisms

17. Several species of non-attached microalgae and cyanobacteria may be used. The strains listed in Appendix 2 have been shown to be suitable using the test procedure specified in this test method.
18. If other species are used, the strain and/or origin should be reported. Confirm that exponential growth of the selected test alga can be maintained throughout the test period under the prevailing conditions.

Growth medium

19. Two alternative growth media, the OECD and the AAP medium, are recommended. The compositions of these media are shown in Appendix 3. Note that the initial pH value and the buffering capacity (regulating pH increase) of the two media are different. Therefore the results of the tests may be different depending on the medium used, particularly when testing ionising chemicals.

▼M6

20. Modification of the growth media may be necessary for certain purposes, e.g. when testing metals and chelating agents or testing at different pH values. Use of a modified medium should be described in detail and justified (3) (4).

Initial biomass concentration

21. The initial biomass in the test cultures must be the same in all test cultures and sufficiently low to allow exponential growth throughout the incubation period without risk of nutrient depletion. The initial biomass should not exceed 0,5 mg/l as dry weight. The following initial cell concentrations are recommended:

<i>Pseudokirchneriella subcapitata</i> :	$5 \times 10^3 - 10^4$ cells/ml
<i>Desmodesmus subspicatus</i>	$2-5 \times 10^3$ cells/ml
<i>Navicula pelliculosa</i>	10^4 cells/ml
<i>Anabaena flos-aquae</i>	10^4 cells/ml
<i>Synechococcus leopoliensis</i>	$5 \times 10^4 - 10^5$ cells/ml

Concentrations of test chemical

22. The concentration range in which effects are likely to occur may be determined on the basis of results from range-finding tests. For the final definitive test at least five concentrations, arranged in a geometric series with a factor not exceeding 3.2, should be selected. For test chemicals showing a flat concentration response curve a higher factor may be justified. The concentration series should preferably cover the range causing 5-75 % inhibition of algal growth rate.

Replicates and controls

23. The test design should include three replicates at each test concentration. If determination of the NOEC is not required, the test design may be altered to increase the number of concentrations and reduce the number of replicates per concentration. The number of control replicates must be at least three, and ideally should be twice the number of replicates used for each test concentration.
24. A separate set of test solutions may be prepared for analytical determinations of test chemical concentrations (see paragraphs 36 and 38).
25. When a solvent is used to solubilise the test chemical, additional controls containing the solvent at the same concentration as used in the test cultures must be included in the test design.

Preparation of inoculum culture

26. In order to adapt the test alga to the test conditions and ensure that the algae are in the exponential growth phase when used to inoculate the test solutions, an inoculum culture in the test medium is prepared 2-4 days before start of the test. The algal biomass should be adjusted in order to allow exponential growth to prevail in the inoculum culture until the test starts. Incubate the inoculum culture under the same conditions as the test cultures. Measure the increase in biomass in the inoculum culture to ensure

▼M6

that growth is within the normal range for the test strain under the culturing conditions. An example of the procedure for algal culturing is described in Appendix 4. To avoid synchronous cell divisions during the test a second propagation step of the inoculum culture may be required.

Preparation of test solutions

27. All test solutions must contain the same concentrations of growth medium and initial biomass of test alga. Test solutions of the chosen concentrations are usually prepared by mixing a stock solution of the test chemical with growth medium and inoculum culture. Stock solutions are normally prepared by dissolving the chemical in test medium.

28. Solvents, e.g. acetone, t-butyl alcohol and dimethyl formamide, may be used as carriers to add chemicals of low water solubility to the test medium (2)(3). The concentration of solvent should not exceed 100 µl/l, and the same concentration of solvent should be added to all cultures (including controls) in the test series.

Incubation

29. Cap the test vessels with air-permeable stoppers. The vessels are shaken and placed in the culturing apparatus. During the test it is necessary to keep the algae in suspension and to facilitate transfer of CO₂. To this end constant shaking or stirring should be used. The cultures should be maintained at a temperature in the range of 21 to 24 °C, controlled at ± 2 °C. For species other than those listed in Appendix 2, e.g. tropical species, higher temperatures may be appropriate, providing that the validity criteria can be fulfilled. It is recommended to place the flasks randomly and to reposition them daily in the incubator.

30. The pH of the control medium should not increase by more than 1,5 units during the test. For metals and chemicals that partly ionise at a pH around the test pH, it may be necessary to limit the pH drift to obtain reproducible and well defined results. A drift of < 0,5 pH units is technically feasible and can be achieved by ensuring an adequate CO₂ mass transfer rate from the surrounding air to the test solution, e.g. by increasing the shaking rate. Another possibility is to reduce the demand for CO₂ by reducing the initial biomass or the test duration.

31. The surface where the cultures are incubated should receive continuous, uniform fluorescent illumination e.g. of 'cool-white' or 'daylight' type. Strains of algae and cyanobacteria vary in their light requirements. The light intensity should be selected to suit the test organism used. For the recommended species of green algae, select the light intensity at the level of the test solutions from the range of 60-120 µE · m⁻² · s⁻¹ when measured in the photosynthetically effective wavelength range of 400-700 nm using an appropriate receptor. Some species, in particular *Anabaena flos-aquae*, grow well at lower light intensities and may be damaged at high intensities. For such species an average light intensity in the range 40-60 µE · m⁻² · s⁻¹ should be selected. (For light-measuring instruments calibrated in lux, an equivalent range of 4 440 - 8 880 lux for cool white light corresponds approximately to the recommended light intensity 60-120 µE · m⁻² · s⁻¹). Maintain the light intensity within ±15 % from the average light intensity over the incubation area.

▼ M6**Test duration**

32. Test duration is normally 72 hours. However, shorter or longer test durations may be used provided that all validity criteria in paragraph 11 can be met.

Measurements and analytical determinations

33. The algal biomass in each flask is determined at least daily during the test period. If measurements are made on small volumes removed from the test solution by pipette, these should not be replaced.
34. Measurement of biomass is done by manual cell counting by microscope or an electronic particle counter (by cell counts and/or biovolume). Alternative techniques, e.g. flow cytometry, *in vitro* or *in vivo* chlorophyll fluorescence (5) (6), or optical density can be used if a satisfactory correlation with biomass can be demonstrated over the range of biomass occurring in the test.
35. Measure the pH of the solutions at the beginning and at the end of the test.
36. Provided an analytical procedure for determination of the test chemical in the concentration range used is available, the test solutions should be analysed to verify the initial concentrations and maintenance of the exposure concentrations during the test.
37. Analysis of the concentration of the test chemical at the start and end of the test of a low and high test concentration and a concentration around the expected EC₅₀ may be sufficient where it is likely that exposure concentrations will vary less than 20 % from nominal values during the test. Analysis of all test concentrations at the beginning and at the end of the test is recommended where concentrations are unlikely to remain within 80-120 % of the nominal concentration. For volatile, unstable or strongly adsorbing test chemicals, additional samplings for analysis at 24 hour intervals during the exposure period are recommended in order to better define loss of the test chemical. For these chemicals, extra replicates may be needed. In all cases, determination of test chemical concentrations need only be performed on one replicate vessel at each test concentration (or the contents of the vessels pooled by replicate).
38. The test media prepared specifically for analysis of exposure concentrations during the test should be treated identically to those used for testing, i.e. they should be inoculated with algae and incubated under identical conditions. If analysis of the dissolved test chemical concentration is required, it may be necessary to separate algae from the medium. Separation should preferably be made by centrifugation at a low g-force, sufficient to settle the algae.
39. If there is evidence that the concentration of the chemical being tested has been satisfactorily maintained within ± 20 % of the nominal or measured initial concentration throughout the test, analysis of the results can be based on nominal or measured initial values. If the deviation from the nominal or measured initial concentration is not within the range of ± 20 %, analysis of the results should be based on geometric mean concentration during exposure or on models describing the decline of the concentration of the test chemical (3) (7).

▼ M6

40. The alga growth inhibition test is a more dynamic test system than most other short-term aquatic toxicity tests. As a consequence, the actual exposure concentrations may be difficult to define, especially for adsorbing chemicals tested at low concentrations. In such cases, disappearance of the test chemical from solution by adsorption to the increasing algal biomass does not mean that it is lost from the test system. When the result of the test is analysed, it should be checked whether a decrease in concentration of the test chemical in the course of the test is accompanied by a decrease in growth inhibition. If this is the case, application of a suitable model describing the decline of the concentration of the test chemical (7) may be considered. If not, it may be appropriate to base the analysis of the results on the initial (nominal or measured) concentrations.

Other observations

41. Microscopic observation should be performed to verify a normal and healthy appearance of the inoculum culture and to observe any abnormal appearance of the algae (as may be caused by the exposure to the test chemical) at the end of the test.

Limit test

42. Under some circumstances, e.g. when a preliminary test indicates that the test chemical has no toxic effects at concentrations up to 100 mg/l or up to its limit of solubility in the test medium (whichever is the lower), a limit test involving a comparison of responses in a control group and one treatment group (100 mg/l or a concentration equal to the limit of solubility), may be undertaken. It is strongly recommended that this be supported by analysis of the exposure concentration. All previously described test conditions and validity criteria apply to a limit test, with the exception that the number of treatment replicates should be at least six. The response variables in the control and treatment group may be analysed using a statistical test to compare means, e.g. a Student's t-test. If variances of the two groups are unequal, a t-test adjusted for unequal variances should be performed

DATA AND REPORTING**Plotting growth curves**

43. The biomass in the test vessels may be expressed in units of the surrogate parameter used for measurement (e.g. cell number, fluorescence).
44. Tabulate the estimated biomass concentration in test cultures and controls together with the concentrations of test material and the times of measurement, recorded with a resolution of at least whole hours, to produce plots of growth curves. Both logarithmic scales and linear scales can be useful at this first stage, but logarithmic scales are mandatory and generally give a better presentation of variations in growth pattern during the test period. Note that exponential growth produces a straight line when plotted on a logarithmic scale, and inclination of the line (slope) indicates the specific growth rate.
45. Using the plots, examine whether control cultures grow exponentially at the expected rate throughout the test. Examine all data points and the appearance of the graphs critically and check raw data and procedures for possible errors. Check in particular any data point that seems to deviate by a systematic error. If it is obvious that procedural mistakes can be identified

▼ M6

and/or considered highly likely, the specific data point is marked as an outlier and not included in subsequent statistical analysis. (A zero algal concentration in one out of two or three replicate vessels may indicate the vessel was not inoculated correctly, or was improperly cleaned). State reasons for rejection of a data point as an outlier clearly in the test report. Accepted reasons are only (rare) procedural mistakes and not just bad precision. Statistical procedures for outlier identification are of limited use for this type of problem and cannot replace expert judgement. Outliers (marked as such) should preferably be retained among the data points shown in any subsequent graphical or tabular data presentation.

Response variables

46. The purpose of the test is to determine the effects of the test chemical on the growth of algae. This test method describes two response variables, as different jurisdictions have different preferences and regulatory needs. In order for the test results to be acceptable in all jurisdictions, the effects should be evaluated using both response variables (a) and (b) described below.

(a) Average specific growth rate: this response variable is calculated on the basis of the logarithmic increase of biomass during the test period, expressed per day

(b) Yield: this response variable is the biomass at the end of the test minus the starting biomass.

47. It should be noted that toxicity values calculated by using these two response variables are not comparable and this difference must be recognised when using the results of the test. EC_x values based upon average specific growth rate (E_rC_x) will generally be higher than results based upon yield (E_yC_x) if the test conditions of this test method are adhered to, due to the mathematical basis of the respective approaches. This should not be interpreted as a difference in sensitivity between the two response variables, simply that the values are different mathematically. The concept of average specific growth rate is based on the general exponential growth pattern of algae in non-limited cultures, where toxicity is estimated on the basis of the effects on the growth rate, without being dependent on the absolute level of the specific growth rate of the control, slope of the concentration-response curve or on test duration. In contrast, results based upon the yield response variable are dependent upon all these other variables. E_yC_x is dependent on the specific growth rate of the algal species used in each test and on the maximum specific growth rate that can vary between species and even different algal strains. This response variable should not be used for comparing the sensitivity to toxicants among algal species or even different strains. While the use of average specific growth rate for estimating toxicity is scientifically preferred, toxicity estimates based on yield are also included in this test method to satisfy current regulatory requirements in some countries.

Average growth rate

48. The average specific growth rate for a specific period is calculated as the logarithmic increase in the biomass from the equation for each single vessel of controls and treatments [1]:

▼ M6

$$\mu_{i-j} = \frac{\ln X_j - \ln X_i}{t_j - t_i} (\text{day}^{-1}) \quad [1],$$

where:

μ_{i-j} is the average specific growth rate from time i to j ;

X_i is the biomass at time i ;

X_j is the biomass at time j

For each treatment group and control group, calculate a mean value for growth rate along with variance estimates.

49. Calculate the average specific growth rate over the entire test duration (normally days 0-3), using the nominally inoculated biomass as the starting value rather than a measured starting value, because in this way greater precision is normally obtained. If the equipment used for biomass measurement allows sufficiently precise determination of the low inoculum biomass (e.g. flow cytometer) then the measured initial biomass concentration can be used. Assess also the section-by-section growth rate, calculated as the specific growth rates for each day during the course of the test (days 0-1, 1-2 and 2-3) and examine whether the control growth rate remains constant (see validity criteria, paragraph 11). A significantly lower specific growth rate on day one than the total average specific growth rate may indicate a lag phase. While a lag phase can be minimised and practically eliminated in control cultures by proper propagation of the pre-culture, a lag phase in exposed cultures may indicate recovery after initial toxic stress or reduced exposure due to loss of test chemical (including sorption onto the algal biomass) after initial exposure. Hence the section-by-section growth rate may be assessed in order to evaluate effects of the test chemical occurring during the exposure period. Substantial differences between the section-by-section growth rate and the average growth rate indicate deviation from constant exponential growth and that close examination of the growth curves is warranted.
50. Calculate the percent inhibition of growth rate for each treatment replicate from equation [2]:

$$\%I_r = \frac{\mu_c - \mu_r}{\mu_c} \times 100 \quad [2],$$

where:

$\%I_r$ = percent inhibition in average specific growth rate;

μ_c = mean value for average specific growth rate (μ) in the control group;

μ_r = average specific growth rate for the treatment replicate.

51. When solvents are used to prepare the test solutions, the solvent controls rather than the controls without solvents should be used in calculation of percent inhibition.

Yield

52. Yield is calculated as the biomass at the end of the test minus the starting biomass for each single vessel of controls and treatments. For each test concentration and control, calculate a mean value for yield along with variance estimates. The percent inhibition in yield ($\%I_y$) may be calculated for each treatment replicate as follows:

▼ M6

$$\%I_y = \frac{(Y_c - Y_T)}{Y_c} \times 100 \quad [3]$$

where:

$\%I_y$ = percent inhibition of yield;

Y_C = mean value for yield in the control group;

Y_T = value for yield for the treatment replicate.

Plotting concentration response curve

53. Plot the percentage of inhibition against the logarithm of the test chemical concentration and examine the plot closely, disregarding any such data point that was singled out as an outlier in the first phase. Fit a smooth line through the data points by eye or by computerised interpolation to get a first impression of the concentration-response relationship, and then proceed with a more detailed method, preferably a computerised statistical method. Depending on the intended usage of data; the quality (precision) and amount of data as well as the availability of data analysis tools, it may be decided (and sometimes well justified) to stop the data analysis at this stage and simply read the key figures EC_{50} and EC_{10} (and/or EC_{20}) from the eye fitted curve (see also section below on stimulatory effects). Valid reasons for not using a statistical method may include:
- Data are not appropriate for computerised methods to produce any more reliable results than can be obtained by expert judgement — in such situations some computer programs may even fail to produce a reliable solution (iterations may not converge etc.)
 - Stimulatory growth responses cannot be handled adequately using available computer programs (see below).

Statistical procedures

54. The aim is to obtain a quantitative concentration-response relationship by regression analysis. It is possible to use a weighted linear regression after having performed a linearising transformation of the response data — for instance into probit or logit or Weibull units (8), but non-linear regression procedures are preferred techniques that better handle unavoidable data irregularities and deviations from smooth distributions. Approaching either zero or total inhibition, such irregularities may be magnified by the transformation, interfering with the analysis (8). It should be noted that standard methods of analysis using probit, logit, or Weibull transforms are intended for use on quantal (e.g. mortality or survival) data, and must be modified to accommodate growth or biomass data. Specific procedures for determination of EC_x values from continuous data can be found in (9) (10) and (11). The use of non-linear regression analysis is further detailed in Appendix 5.
55. For each response variable to be analysed, use the concentration-response relationship to calculate point estimates of EC_x values. When possible, the 95 % confidence limits for each estimate should be determined. Goodness of fit of the response data to the regression model should be assessed either graphically or statistically. Regression analysis should be performed using individual replicate responses, not treatment group means. If, however nonlinear curve fitting is difficult or fails because of too great scatter in the data, the problem may be circumvented by performing the regression on group means as a practical way of reducing the influence of suspected

▼ M6

outliers. Use of this option should be identified in the test report as a deviation from normal procedure because curve fits with individual replicates did not produce a good result.

56. EC₅₀ estimates and confidence limits may also be obtained using linear interpolation with bootstrapping (13), if available regression models/methods are unsuitable for the data.

57. For estimation of the LOEC and hence the NOEC, for effects of the test chemical on growth rate, it is necessary to compare treatment means using analysis of variance (ANOVA) techniques. The mean for each concentration must then be compared with the control mean using an appropriate multiple comparison or trend test method. Dunnett's or Williams' test may be useful (12)(14)(15)(16)(17). It is necessary to assess whether the ANOVA assumption of homogeneity of variance holds. This assessment may be performed graphically or by a formal test (17). Suitable tests are Levene's or Bartlett's. Failure to meet the assumption of homogeneity of variances can sometimes be corrected by logarithmic transformation of the data. If heterogeneity of variance is extreme and cannot be corrected by transformation, analysis by methods such as step-down Jonkheere trend tests should be considered. Additional guidance on determining the NOEC can be found in (11).

58. Recent scientific developments have led to a recommendation of abandoning the concept of NOEC and replacing it with regression based point estimates EC_x. An appropriate value for x has not been established for this algal test. A range of 10 to 20 % appears to be appropriate (depending on the response variable chosen), and preferably both the EC₁₀ and EC₂₀ should be reported.

Growth stimulation

59. Growth stimulation (negative inhibition) at low concentrations is sometimes observed. This can result from either hormesis ('toxic stimulation') or from addition of stimulating growth factors with the test material to the minimal medium used. Note that the addition of inorganic nutrients should not have any direct effect because the test medium should maintain a surplus of nutrients throughout the test. Low dose stimulation can usually be ignored in EC₅₀ calculations unless it is extreme. However, if it is extreme, or an EC_x value for low x is to be calculated, special procedures may be needed. Deletion of stimulatory responses from the data analysis should be avoided if possible, and if available curve fitting software cannot accept minor stimulation, linear interpolation with bootstrapping can be used. If stimulation is extreme, use of a hormesis model may be considered (18).

Non toxic growth inhibition

60. Light absorbing test materials may give rise to a growth rate reduction because shading reduces the amount of available light. Such physical types of effects should be separated from toxic effects by modifying the test conditions and the former should be reported separately. Guidance may be found in (2) and (3).

TEST REPORT

61. The test report must include the following:

▼ M6*Test chemical:*

- physical nature and relevant physical-chemical properties, including water solubility limit;
- chemical identification data (e.g., CAS Number), including purity (impurities).

Test species:

- the strain, supplier or source and the culture conditions used.

Test conditions:

- date of start of the test and its duration;
- description of test design: test vessels, culture volumes, biomass density at the beginning of the test;
- composition of the medium;
- test concentrations and replicates (e.g., number of replicates, number of test concentrations and geometric progression used);
- description of the preparation of test solutions, including use of solvents etc.
- culturing apparatus;
- light intensity and quality (source, homogeneity);
- temperature;
- concentrations tested: the nominal test concentrations and any results of analyses to determine the concentration of the test chemical in the test vessels. The recovery efficiency of the method and the limit of quantification in the test matrix should be reported;
- all deviations from this test method;
- method for determination of biomass and evidence of correlation between the measured parameter and dry weight;

Results:

- pH values at the beginning and at the end of the test at all treatments;
- biomass for each flask at each measuring point and method for measuring biomass;
- growth curves (plot of biomass versus time);
- calculated response variables for each treatment replicate, with mean values and coefficient of variation for replicates;
- graphical presentation of the concentration/effect relationship;

▼ M6

- estimates of toxicity for response variables e.g., EC₅₀, EC₁₀, EC₂₀ and associated confidence intervals. If calculated, LOEC and NOEC and the statistical methods used for their determination;
- if ANOVA has been used, the size of the effect which can be detected (e.g. the least significant difference);
- any stimulation of growth found in any treatment;
- any other observed effects, e.g. morphological changes of the algae;
- discussion of the results, including any influence on the outcome of the test resulting from deviations from this test method.

LITERATURE

- (1) International Organisation for Standardisation (1993). ISO 8692 Water quality — Algal growth inhibition test.
- (2) International Organisation for Standardisation (1998). ISO/DIS 14442. Water quality — Guidelines for algal growth inhibition tests with poorly soluble materials, volatile compounds, metals and waster water.
- (3) OECD (2000). Guidance Document on Aquatic Toxicity Testing of Difficult Substances and mixtures. Environmental Health and Safety Publications. Series on Testing and Assessment, no. 23. Organisation for Economic Co-operation and Development, Paris.
- (4) International Organisation for Standardisation (1998). ISO 5667-16 Water quality — Sampling — Part 16: Guidance on Biotesting of Samples.
- (5) Mayer, P., Cuhel, R. and Nyholm, N. (1997). A simple in vitro fluorescence method for biomass measurements in algal growth inhibition tests. *Water Research* 31: 2525-2531.
- (6) Slovacey, R.E. and Hanna, P.J. (1997). In vivo fluorescence determinations of phytoplankton chlorophyll, *Limnology & Oceanography* 22: 919-925
- (7) Simpson, S.L., Roland, M.G.E., Stauber, J.L. and Batley, G.E. (2003). Effect of declining toxicant concentrations on algal bioassay endpoints. *Environ. Toxicol. Chem.* 22: 2073-2079.
- (8) Christensen, E.R., Nyholm, N. (1984). Ecotoxicological Assays with Algae: Weibull Dose-Response Curves. *Env. Sci. Technol.* 19: 713-718.
- (9) Nyholm, N. Sørensen, P.S., Kusk, K.O. and Christensen, E.R. (1992). Statistical treatment of data from microbial toxicity tests. *Environ. Toxicol. Chem.* 11: 157-167.
- (10) Bruce, R.D., and Versteeg, D.J. (1992). A statistical procedure for modelling continuous toxicity data. *Environ. Toxicol. Chem.* 11: 1485-1494.
- (11) OECD (2006). Current Approaches in the Statistical Analysis of Ecotoxicity Data: A Guidance to Application. Organisation for Economic Co-operation and Development, Paris.

▼M6

- (12) Dunnett, C.W. (1955). A multiple comparisons procedure for comparing several treatments with a control. *J. Amer. Statist. Assoc.* 50: 1096-1121
- (13) Norberg-King T.J. (1988). An interpolation estimate for chronic toxicity: The ICp approach. National Effluent Toxicity Assessment Center Technical Report 05-88. US EPA, Duluth, MN.
- (14) Dunnett, C.W. (1964). New tables for multiple comparisons with a control. *Biometrics* 20: 482-491.
- (15) Williams, D.A. (1971). A test for differences between treatment means when several dose levels are compared with a zero dose control. *Biometrics* 27: 103-117.
- (16) Williams, D.A. (1972). The comparison of several dose levels with a zero dose control. *Biometrics* 28: 519-531.
- (17) Draper, N.R. and Smith, H. (1981). *Applied Regression Analysis*, second edition. Wiley, New York.
- (18) Brain, P. and Cousens, R. (1989). An equation to describe dose-responses where there is stimulation of growth at low doses. *Weed Research*, 29, 93-96.

▼ M6*Appendix 1***Definitions**

The following definitions and abbreviations are used for the purposes of this test method:

Biomass is the dry weight of living matter present in a population expressed in terms of a given volume; e.g., mg algae/litre test solution. Usually 'biomass' is defined as a mass, but in this test this word is used to refer to mass per volume. Also in this test, surrogates for biomass, such as cell counts, fluorescence, etc. are typically measured and the use of the term 'biomass' thus refers to these surrogate measures as well.

Chemical means a substance or mixture

Coefficient of variation is a dimensionless measure of the variability of a parameter, defined as the ratio of the standard deviation to the mean. This can also be expressed as a percent value. Mean coefficient of variation of average specific growth rate in replicate control cultures should be calculated as follows:

1. Calculate % CV of average specific growth rate out of the daily/section by section growth rates for the respective replicate;
2. Calculate the mean value out of all values calculated under point 1 to get the mean coefficient of variation of the daily/section by section specific growth rate in replicate control cultures.

EC_x is the concentration of the test chemical dissolved in test medium that results in an x % (e.g. 50 %) reduction in growth of the test organism within a stated exposure period (to be mentioned explicitly if deviating from full or normal test duration). To unambiguously denote an EC value deriving from growth rate or yield the symbol 'E_rC' is used for growth rate and 'E_yC' is used for yield.

Growth medium is the complete synthetic culture medium in which test algae grow when exposed to the test chemical. The test chemical will normally be dissolved in the test medium.

Growth rate (average specific growth rate) is the logarithmic increase in biomass during the exposure period.

Lowest Observed Effect Concentration (LOEC) is the lowest tested concentration at which the chemical is observed to have a statistically significant reducing effect on growth (at $p < 0,05$) when compared with the control, within a given exposure time. However, all test concentrations above the LOEC must have a harmful effect equal to or greater than those observed at the LOEC. When these two conditions cannot be satisfied, a full explanation must be given for how the LOEC (and hence the NOEC) has been selected.

No Observed Effect Concentration (NOEC) is the test concentration immediately below the LOEC.

Response variable is a variable for the estimation of toxicity derived from any measured parameters describing biomass by different methods of calculation. For this test method growth rates and yield are response variables derived from measuring biomass directly or any of the surrogates mentioned.

▼ **M6**

Specific growth rate is a response variable defined as quotient of the difference of the natural logarithms of a parameter of observation (in this test method, biomass) and the respective time period

Test chemical means any substance or mixture tested using this test method.

Yield is the value of a measurement variable at the end of the exposure period minus the measurement variable's value at the start of the exposure period to express biomass increase during the test.

▼ M6*Appendix 2***Strains Shown to be Suitable for the Test****Green algae**

Pseudokirchneriella subcapitata (formerly known as *Selenastrum capricornutum*), ATCC 22662, CCAP 278/4, 61.81 SAG

Desmodesmus subspicatus (formerly known as *Scenedesmus subspicatus*), 86.81 SAG

Diatoms

Navicula pelliculosa, UTEX 664

Cyanobacteria

Anabaena flos-aquae, UTEX 1444, ATCC 29413, CCAP 1403/13A

Synechococcus leopoliensis, UTEX 625, CCAP 1405/1

Sources of Strains

The strains recommended are available in unialgal cultures from the following collections (in alphabetical order):

ATCC: American Type Culture Collection

10801 University Boulevard
Manassas, Virginia 20110-2209
USA

CCAP, Culture Collection of Algae and Protozoa

Institute of Freshwater Ecology,
Windermere Laboratory
Far Sawrey, Ambleside
Cumbria LA22 0LP
UK

SAG: Collection of Algal Cultures

Inst. Plant Physiology
University of Göttingen
Nikolausberger Weg 18
37073 Göttingen
GERMANY

UTEX Culture Collection of Algae

Section of Molecular, Cellular and Developmental Biology
School of Biological Sciences
the University of Texas at Austin
Austin, Texas 78712
USA.

▼ **M6****Appearance and characteristics of recommended species**

	<i>P. subcapitata</i>	<i>D. subspicatus</i>	<i>N. pelliculosa</i>	<i>A. flos-aquae</i>	<i>S. leopoliensis</i>
Appearance	Curved, twisted single cells	Oval, mostly single cells	Rods	Chains of oval cells	Rods
Size (L × W) µm	8-14 × 2-3	7-15 × 3-12	7,1 × 3,7	4,5 × 3	6 × 1
Cell volume (µm ³ /cell)	40-60 ⁽¹⁾	60-80 ⁽¹⁾	40-50 ⁽¹⁾	30-40 ⁽¹⁾	2,5 ⁽²⁾
Cell dry weight (mg/cell)	2-3 × 10 ⁻⁸	3-4 × 10 ⁻⁸	3-4 × 10 ⁻⁸	1-2 × 10 ⁻⁸	2-3 × 10 ⁻⁹
Growth rate ⁽³⁾ (day ⁻¹)	1,5 -1,7	1,2-1,5	1,4	1,1-1,4	2,0-2,4

⁽¹⁾ Measured with electronic particle counter

⁽²⁾ Calculated from size

⁽³⁾ Most frequently observed growth rate in OECD medium at light intensity approx. 70 µE m⁻² s⁻¹ and 21 °C

Specific Recommendations on Culturing and Handling of Recommended Test Species***Pseudokirchneriella subcapitata* and *Desmodesmus subspicatus***

These green algae are generally easy to maintain in various culture media. Information on suitable media is available from the culture collections. The cells are normally solitary, and cell density measurements can easily be performed using an electronic particle counter or microscope.

Anabaena flos-aquae

Various growth media may be used for keeping a stock culture. It is particularly important to avoid allowing the batch culture to go past log phase growth when renewing, recovery is difficult at this point.

Anabaena flos-aquae develops aggregates of nested chains of cells. The size of these aggregates may vary with culturing conditions. It may be necessary to break up these aggregates when microscope counting or an electronic particle counter is used for determination of biomass.

Sonication of sub-samples may be used to break up chains to reduce count variability. Longer sonication than required for breaking up chains into shorter lengths may destroy the cells. Sonication intensity and duration must be identical for each treatment.

Count enough fields on the hemocytometer (at least 400 cells) to help compensate for variability. This will improve reliability of microscopic density determinations.

An electronic particle counter can be used for determination of total cell volume of *Anabaena* after breaking up the cell chains by careful sonification. The sonification energy has to be adjusted to avoid disruption of the cells.

Use a vortex mixer or similar appropriate method to make sure the algae suspension used to inoculate test vessels is well mixed and homogeneous.

▼ M6

Test vessels should be placed on an orbital or reciprocate shaker table at about 150 revolutions per minute. Alternatively, intermittent agitation may be used to reduce the tendency of *Anabaena* to form clumps. If clumping occurs, care must be taken to achieve representative samples for biomass measurements. Vigorous agitation before sampling may be necessary to disintegrate algal clumps.

Synechococcus leopoliensis

Various growth media may be used for keeping a stock culture. Information on suitable media is available from the culture collections.

Synechococcus leopoliensis grows as solitary rod-shaped cells. The cells are very small, which complicates the use of microscope counting for biomass measurements. Electronic particle counters equipped for counting particles down to a size of approximately 1 µm are useful. In vitro fluorometric measurements are also applicable.

Navicula pelliculosa

Various growth media may be used for keeping a stock culture. Information on suitable media is available from the culture collections. Note that silicate is required in the medium.

Navicula pelliculosa may form aggregates under certain growth conditions. Due to production of lipids the algal cells sometimes tend to accumulate in the surface film. Under those circumstances special measures have to be taken when sub-samples are taken for biomass determination in order to obtain representative samples. Vigorous shaking, e.g. using a vortex mixer may be required.

▼ **M6***Appendix 3***Growth Media**

One of the following two growth media may be used:

— OECD medium: Original medium of OECD TG 201, also according to ISO 8692

— US. EPA medium AAP also according to ASTM.

When preparing these media, reagent or analytical-grade chemicals should be used and deionised water.

Composition of the AAP-medium (US. EPA) and the OECD TG 201 medium.

Component	AAP		OECD	
	mg/l	mM	mg/l	mM
NaHCO ₃	15,0	0,179	50,0	0,595
NaNO ₃	25,5	0,300		
NH ₄ Cl			15,0	0,280
MgCl ₂ ·6(H ₂ O)	12,16	0,0598	12,0	0,0590
CaCl ₂ ·2(H ₂ O)	4,41	0,0300	18,0	0,122
MgSO ₄ ·7(H ₂ O)	14,6	0,0592	15,0	0,0609
K ₂ HPO ₄	1,044	0,00599		
KH ₂ PO ₄			1,60	0,00919
FeCl ₃ ·6(H ₂ O)	0,160	0,000591	0,0640	0,000237
Na ₂ EDTA·2(H ₂ O)	0,300	0,000806	0,100	0,000269*
H ₃ BO ₃	0,186	0,00300	0,185	0,00299
MnCl ₂ ·4(H ₂ O)	0,415	0,00201	0,415	0,00210
ZnCl ₂	0,00327	0,000024	0,00300	0,0000220
CoCl ₂ ·6(H ₂ O)	0,00143	0,000006	0,00150	0,00000630
Na ₂ MoO ₄ ·2(H ₂ O)	0,00726	0,000030	0,00700	0,0000289
CuCl ₂ ·2(H ₂ O)	0,000012	0,00000007	0,00001	0,00000006
pH	7,5		8,1	

The molar ratio of EDTA to iron slightly exceeds unity. This prevents iron precipitation and at the same time, chelation of heavy metal ions is minimised.

In test with the diatom *Navicula pelliculosa* both media must be supplemented with Na₂SiO₃·9H₂O to obtain a concentration of 1,4 mg Si/l.

▼ M6

The pH of the medium is obtained at equilibrium between the carbonate system of the medium and the partial pressure of CO₂ in atmospheric air. An approximate relationship between pH at 25 °C and the molar bicarbonate concentration is:

$$\text{pH}_{\text{eq}} = 11,30 + \log[\text{HCO}_3]$$

With 15 mg NaHCO₃/l, $\text{pH}_{\text{eq}} = 7,5$ (U.S. EPA medium) and with 50 mg NaHCO₃/l, $\text{pH}_{\text{eq}} = 8,1$ (OECD medium).

Element composition of test media

Element	AAP	OECD
	mg/l	mg/l
C	2,144	7,148
N	4,202	3,927
P	0,186	0,285
K	0,469	0,459
Na	11,044	13,704
Ca	1,202	4,905
Mg	2,909	2,913
Fe	0,033	0,017
Mn	0,115	0,115

Preparation of OECD medium

Nutrient	Concentration in stock solution
Stock solution 1: macro nutrients	
NH ₄ Cl	1,5 g/l
MgCl ₂ ·6H ₂ O	1,2 g/l
CaCl ₂ ·2H ₂ O	1,8 g/l
MgSO ₄ ·7H ₂ O	1,5 g/l
KH ₂ PO ₄	0,16 g/l
Stock solution 2: iron	
FeCl ₃ ·6H ₂ O	64 mg/l
Na ₂ EDTA·2H ₂ O	100 mg/l
Stock solution 3: trace elements	
H ₃ BO ₃	185 mg/l
MnCl ₂ ·4H ₂ O	415 mg/l
ZnCl ₂	3 mg/l

▼ M6

Nutrient	Concentration in stock solution
CoCl ₂ ·6H ₂ O	1,5 mg/l
CuCl ₂ ·2H ₂ O	0,01 mg/l
Na ₂ MoO ₄ ·2H ₂ O	7 mg/l
Stock solution 4: bicarbonate	
NaHCO ₃	50 g/l
Na ₂ SiO ₃ ·9H ₂ O	

Sterilise the stock solutions by membrane filtration (mean pore diameter 0,2 µm) or by autoclaving (120 °C, 15 min). Store the solutions in the dark at 4 °C.

Do not autoclave stock solutions 2 and 4, but sterilise them by membrane filtration.

Prepare a growth medium by adding an appropriate volume of the stock solutions 1-4 to water:

Add to 500 ml of sterilised water:

10 ml of stock solution 1

1 ml of stock solution 2

1 ml of stock solution 3

1 ml of stock solution 4

Make up to 1 000 ml with sterilised water.

Allow sufficient time for equilibrating the medium with the atmospheric CO₂, if necessary by bubbling with sterile, filtered air for some hours.

Preparation of U.S. EPA medium

- Add 1 ml of each stock solution in 2.1–2.7 to approximately 900 ml of deionised or distilled water and then dilute to 1 litre.
- Macronutrient stock solutions are made by dissolving the following into 500 ml of deionised or distilled water. Reagents 2.1, 2.2, 2.3, and 2.4 can be combined into one stock solution.

2.1	NaNO ₃	12,750 g.
2.2	MgCl ₂ ·6H ₂ O	6,082 g.
2.3	CaCl ₂ ·2H ₂ O	2,205 g.
2.4	Micronutrient Stock Solution(see 3).	
2.5	MgSO ₄ ·7H ₂ O	7,350 g.
2.6	K ₂ HPO ₄	0,522 g.
2.7	NaHCO ₃	7,500 g.
2.8	Na ₂ SiO ₃ ·9H ₂ O	See Note 1.

▼ M6

Note 1: Use for diatom test species only. May be added directly (202,4 mg) or by way of stock solution to give 20 mg/l Si final concentration in medium.

3. The micronutrient stock solution is made by dissolving the following into 500 ml of deionised or distilled water:
 - 3.1 H_3BO_3 92,760 mg.
 - 3.2 $\text{MnCl}_2 \cdot 4\text{H}_2\text{O}$ 207,690 mg.
 - 3.3 ZnCl_2 1,635 mg.
 - 3.4 $\text{FeCl}_3 \cdot 6\text{H}_2\text{O}$ 79,880 mg.
 - 3.5 $\text{CoCl}_2 \cdot 6\text{H}_2\text{O}$ 0,714 mg.
 - 3.6 $\text{Na}_2\text{MoO}_4 \cdot 2\text{H}_2\text{O}$ 3,630 mg.
 - 3.7 $\text{CuCl}_2 \cdot 2\text{H}_2\text{O}$ 0,006 mg.
 - 3.8 $\text{Na}_2\text{EDTA} \cdot 2\text{H}_2\text{O}$ 150,000 mg. [Disodium (Ethylenedinitrilo) tetraacetate].
 - 3.9 $\text{Na}_2\text{SeO}_4 \cdot 5\text{H}_2\text{O}$ 0,005 mg See Note 2.
- Note 2:* Use only in medium for stock cultures of diatom species.
4. Adjust pH to $7,5 \pm 0,1$ with 0,1 N or 1,0 N NaOH or HCl.
 5. Filter the media into a sterile container through either a 0,22 μm membrane filter if a particle counter is to be used or a 0,45 μm filter if a particle counter is not to be used.
 6. Store medium in the dark at approximately 4 °C until use.

▼ M6*Appendix 4***Example of a procedure for the culturing of algae****General observations**

The purpose of culturing on the basis of the following procedure is to obtain algal cultures for toxicity tests.

Use suitable methods to ensure that the algal cultures are not infected with bacteria. Axenic cultures may be desirable but unialgal cultures must be established and used.

All operations must be carried out under sterile conditions in order to avoid contamination with bacteria and other algae.

Equipment and materials

See under test method: Apparatus.

Procedures for obtaining algal cultures*Preparation of nutrient solutions (media):*

All nutrient salts of the medium are prepared as concentrated stock solutions and stored dark and cold. These solutions are sterilised by filtration or by autoclaving.

The medium is prepared by adding the correct amount of stock solution to sterile distilled water, taking care that no infection occurs. For solid medium 0,8 per cent of agar is added.

Stock culture:

The stock cultures are small algal cultures that are regularly transferred to fresh medium to act as initial test material. If the cultures are not used regularly they are streaked out on sloped agar tubes. These are transferred to fresh medium at least once every two months.

The stock cultures are grown in conical flasks containing the appropriate medium (volume about 100 ml). When the algae are incubated at 20 °C with continuous illumination, a weekly transfer is required.

During transfer an amount of 'old' culture is transferred with sterile pipettes into a flask of fresh medium, so that with the fast-growing species the initial concentration is about 100 times smaller than in the old culture.

The growth rate of a species can be determined from the growth curve. If this is known, it is possible to estimate the density at which the culture should be transferred to new medium. This must be done before the culture reaches the death phase.

Pre-culture:

The pre-culture is intended to give an amount of algae suitable for the inoculation of test cultures. The pre-culture is incubated under the conditions of the test and used when still exponentially growing, normally after an incubation period of 2 to 4 days. When the algal cultures contain deformed or abnormal cells, they must be discarded.

▼ **M6***Appendix 5***Data analysis by nonlinear regression****General considerations**

The response in algal tests and other microbial growth tests — growth of biomass — is by nature a continuous or metric variable — a process rate if growth rate is used and its integral over time if biomass is selected. Both are referenced to the corresponding mean response of replicate non-exposed controls showing maximum response for the conditions imposed — with light and temperature as primary determining factors in the algal test. The system is distributed or homogenous and the biomass can be viewed as a continuum without consideration of individual cells. The variance distribution of the type of response for a such system relate solely to experimental factors (described typically by the log-normal or normal distributions of error). This is by contrast to typical bioassay responses with quantal data for which the tolerance (typically binomially distributed) of individual organisms are often assumed to be the dominant variance component. Control responses are here zero or background level.

In the uncomplicated situation, the normalised or relative response, r , decreases monotonically from 1 (zero inhibition) to 0 (100 per cent inhibition). Note, that all responses have an error associated and that apparent negative inhibitions can be calculated as a result of random error only.

Regression analysis*Models*

A regression analysis aims at quantitatively describing the concentration response curve in the form of a mathematical regression function $Y = f(C)$ or more frequently $F(Z)$ where $Z = \log C$. Used inversely $C = f^{-1}(Y)$ allows the calculation of, EC_x figures, including the EC_{50} , EC_{10} and EC_{20} , and their 95 % confidence limits. Several simple mathematical functional forms have proved to successfully describe concentration — response relationships obtained in algal growth inhibition tests. Functions include for instance the logistic equation, the nonsymmetrical Weibul equation and the log normal distribution function, which are all sigmoid curves asymptotically approaching zero for $C \rightarrow 0$ and one for $C \rightarrow \text{infinity}$.

The use of continuous threshold function models (e.g. the Kooijman model ‘for inhibition of population growth’ Kooijman et al. 1996) is a recently proposed or alternative to asymptotic models. This model assumes no effects at concentrations below a certain threshold EC_0+ that is estimated by extrapolation of the response concentration relationship to intercept the concentration axis using a simple continuous function that is not differentiable in the starting point.

Note that the analysis can be a simple minimisation of sums of residual squares (assuming constant variance) or weighted squares if variance heterogeneity is compensated.

Procedure

The procedure can be outlined as follows: Select an appropriate functional equation, $Y = f(C)$, and fit it to the data by non-linear regression. Use preferably the measurements from each individual flask rather than means of replicates, in order to extract as much information from the data as possible. If the variance is

▼ M6

high, on the other hand, practical experience suggests that means of replicates may provide a more robust mathematical estimation less influenced by systematic errors in the data, than with each individual data point retained.

Plot the fitted curve and the measured data and examine whether the curve fit is appropriate. Analysis of residuals may be a particular helpful tool for this purpose. If the chosen functional relationship to fit the concentration response does not describe well the whole curve or some essential part of it, such as the response at low concentrations, choose another curve fit option — e.g., a non-symmetrical curve like the Weibul function instead of a symmetrical one. Negative inhibitions may be a problem with for instance the log — normal distribution function likewise demanding an alternative regression function. It is not recommended to assign a zero or small positive value to such negative values because this distorts the error distribution. It may be appropriate to make separate curve fits on parts of the curve such as the low inhibition part to estimate EC_{lowx} figures. Calculate from the fitted equation (by ‘inverse estimation’, $C = f^{-1}(Y)$), characteristic point estimates EC_x 's, and report as a minimum the EC_{50} and one or two EC_{lowx} estimates. Experience from practical testing has shown that the precision of the algal test normally allows a reasonably accurate estimation at the 10 % inhibition level if data points are sufficient — unless stimulation occurs at low concentrations as a confounding factor. The precision of an EC_{20} estimate is often considerably better than that of an EC_{10} , because the EC_{20} is usually positioned on the approximately linear part of the central concentration response curve. Sometimes EC_{10} can be difficult to interpret because of growth stimulation. So while the EC_{10} is normally obtainable with a sufficient accuracy it is recommended to report always also the EC_{20} .

Weighting factors

The experimental variance generally is not constant and typically includes a proportional component, and a weighted regression is therefore advantageously carried out routinely. Weighting factors for a such analysis are normally assumed inversely proportional to the variance:

$$W_i = 1/\text{Var}(r_i)$$

Many regression programs allow the option of weighted regression analysis with weighting factors listed in a table. Conveniently weighting factors should be normalised by multiplying them by $n/\sum w_i$ (n is the number of datapoints) so their sum be one.

Normalising responses

Normalising by the mean control response gives some principle problems and gives rise to a rather complicated variance structure. Dividing the responses by the mean control response for obtaining the percentage of inhibition, one introduces an additional error caused by the error on the control mean. Unless this error is negligibly small, weighting factors in the regression and confidence limits must be corrected for the covariance with the control (Draper and Smith, 1981). Note that high precision on the estimated mean control response is important in order to minimise the overall variance for the relative response. This variance is as follows:

(Subscript i refers to concentration level i and subscript 0 to the controls)

$$Y_i = \text{Relative response} = r_i/r_0 = 1 - I = f(C_i)$$

▼ **M6**

with a variance $\text{Var}(Y_i) = \text{Var}(r_i/r_0) \cong (\partial Y_i/\partial r_i) \cdot \text{Var}(r_i) + ((\partial Y_i/\partial r_0)^2) \cdot \text{Var}(r_0)$

and since $(\partial Y_i/\partial r_i) = 1/r_0$ and $(\partial Y_i/\partial r_0) = r_i/r_0^2$

with normally distributed data and m_i and m_0 replicates: $\text{Var}(r_i) = \sigma^2/m_i$

the total variance of the relative response Y_i thus becomes

$$\text{Var}(Y_i) = \sigma^2/(r_0^2 \cdot m_i) + r_i^2 \cdot \sigma^2/r_0^4 \cdot m_0$$

The error on the control mean is inversely proportional to the square root of the number of control replicates averaged, and sometimes it can be justified to include historic data and in this way greatly reduce the error. An alternative procedure is not to normalise the data and fit the absolute responses including the control response data but introducing the control response value as an additional parameter to be fitted by non linear regression. With a usual 2 parameter regression equation, this method necessitates the fitting of 3 parameters, and therefore demands more data points than non-linear regression on data that are normalised using a pre-set control response.

Inverse confidence intervals

The calculation of non-linear regression confidence intervals by inverse estimation is rather complex and not an available standard option in ordinary statistical computer program packages. Approximate confidence limits may be obtained with standard non-linear regression programs with re-parameterisation (Bruce and Versteeg, 1992), which involves rewriting the mathematical equation with the desired point estimates, e.g. the EC_{10} and the EC_{50} as the parameters to be estimated. (Let the function be $I = f(\alpha, \beta, \text{Concentration})$ and utilise the definition relationships $f(\alpha, \beta, EC_{10}) = 0,1$ and $f(\alpha, \beta, EC_{50}) = 0,5$ to substitute $f(\alpha, \beta, \text{concentration})$ with an equivalent function $g(EC_{10}, EC_{50}, \text{concentration})$.)

A more direct calculation (Andersen et al, 1998) is performed by retaining the original equation and using a Taylor expansion around the means of r_i and r_0 .

Recently 'boot strap methods' have become popular. Such methods use the measured data and a random number generator directed frequent re-sampling to estimate an empirical variance distribution.

REFERENCES

- Kooijman, S.A.L.M.; Hanstveit, A.O.; Nyholm, N. (1996): No-effect concentrations in algal growth inhibition tests. *Water Research*, 30, 1625-1632.
- Draper, N.R. and Smith, H. (1981). Applied Regression Analysis, second edition. Wiley, New York.
- Bruce, R.D. and Versteeg, D.J. (1992). A Statistical Procedure for Modelling Continuous Ecotoxicity Data. *Environ. Toxicol. Chem.* 11, 1485-1494.
- Andersen, J.S., Holst, H., Spliid, H., Andersen, H., Baun, A. & Nyholm, N. (1998). Continuous ecotoxicological data evaluated relative to a control response. *Journal of Agricultural, Biological and Environmental Statistics*, 3, 405-420.

▼B**C.4. DETERMINATION OF 'READY' BIODEGRADABILITY****PART I. GENERAL CONSIDERATIONS****I.1. INTRODUCTION**

Six test methods are described that permit the screening of chemicals for ready biodegradability in an aerobic aqueous medium:

- (a) Dissolved Organic Carbon (DOC) Die-Away (Method C.4-A)
- (b) Modified OECD Screening — DOC Die-Away (Method C.4-B)
- (c) Carbon dioxide (CO₂) Evolution (Modified Sturm Test) (Method C.4-C)
- (d) Manometric Respirometry (Method C.4-D)
- (e) Closed Bottle (Method C.4-E)
- (f) MITI (Ministry of International Trade and Industry — Japan) (Method C.4-F)

General and common considerations to all six tests are given in Part I of the method. Items specific for individual methods are given in Parts II to VII. The appendices contain definitions, formulas and guidance material.

An OECD inter-laboratory comparison exercise, done in 1988, has shown that the methods give consistent results. However, depending on the physical characteristics of the substance to be tested, one or other of the methods may be preferred.

I.2. SELECTION OF THE APPROPRIATE METHOD

In order to select the most appropriate method, information on the chemical's solubility, vapour pressure and adsorption characteristics is essential. The chemical structure or formula should be known in order to calculate theoretical values and/or check measured values of parameters, e.g. ThOD, ThCO₂, DOC, TOC, COD (see Appendices 1 and 2).

Test chemicals which are soluble in water to at least 100 mg/l may be assessed by all methods, provided they are non-volatile and non-adsorbing. For those chemicals which are poorly soluble in water, volatile or adsorbing, suitable methods are indicated in Table 1. The manner in which poorly water-soluble chemicals and volatile chemicals can be dealt with is described in Appendix 3. Moderately volatile chemicals may be tested by the DOC Die-Away method if there is sufficient gas space in the test vessels (which should be suitably stoppered). In this case, an abiotic control must be set up to allow for any physical loss.



Table 1:

Applicability of test methods

Test	Analytical Method	Suitability for substances which are:		
		poorly soluble	volatile	adsorbing
DOC Die-Away	Dissolved organic carbon	–	–	+/-
Mod. OECD Die-Away	Dissolved organic carbon	–	–	+/-
CO ₂ Evolution	Respirometry: CO ₂ evolution	+	–	+
Manometric Respirometry	Manometric respirometry: oxygen consumption	+	+/-	+
Closed Bottle	Respirometry: dissolved oxygen	+/-	+	+
MITI	Respirometry: oxygen consumption	+	+/-	+

Information on the purity or the relative proportions of major components of the test material is required to interpret the results obtained, especially when the results are low or marginal.

Information on the toxicity of the test chemical to bacteria (Appendix 4) may be very useful for selecting appropriate test concentrations and may be essential for the correct interpretation of low biodegradation values.

I.3. REFERENCE SUBSTANCES

In order to check the procedure, reference chemicals which meet the criteria for ready biodegradability are tested by setting up an appropriate flask in parallel to the normal test runs.

Suitable chemicals are aniline (freshly distilled), sodium acetate and sodium benzoate. These reference chemicals all degrade in these methods even when no inoculum is deliberately added.

It was suggested that a reference chemical should be sought which was readily biodegradable but required the addition of an inoculum. Potassium hydrogen phthalate has been proposed but more evidence needs to be obtained with this substance before it can be accepted as a reference substance.

In the respirometric tests, nitrogen-containing compounds may affect the oxygen uptake because of nitrification (see Appendices 2 and 5).

I.4. PRINCIPLE OF THE TEST METHODS

A solution, or suspension, of the test substance in a mineral medium is inoculated and incubated under aerobic conditions in the dark or in diffuse light. The amount of DOC in the test solution due to the inoculum should be kept as low as possible compared to the amount of DOC due to the test substance. Allowance is made for the endogenous activity of the inoculum by running parallel blank tests with inoculum but without test substance, although the endogenous activity of cells in the presence of the substance will not exactly match that in the endogenous control. A reference substance is run in parallel to check the operation of the procedures.

▼ B

In general, degradation is followed by the determination of parameters, such as DOC, CO₂ production and oxygen uptake, and measurements are taken at sufficiently frequent intervals to allow the identification of the beginning and end of biodegradation. With automatic respirometers the measurement is continuous. DOC is sometimes measured in addition to another parameter but this is usually done only at the beginning and the end of the test. Specific chemical analysis can also be used to assess primary degradation of the test substance, and to determine the concentration of any intermediate substances formed (obligatory in the MITI test).

Normally, the test lasts for 28 days. Tests however may be ended before 28 days, i.e. as soon as the biodegradation curve has reached a plateau for at least three determinations. Tests may also be prolonged beyond 28 days when the curve shows that biodegradation has started but that the plateau has not been reached day 28.

I.5. QUALITY CRITERIA**I.5.1. Reproducibility**

Because of the nature of biodegradation and of the mixed bacterial populations used as inocula, determinations should be carried out at least in duplicate.

It is common experience that the larger the concentration of micro-organisms initially added to the test medium, the smaller will be the variation between replicates. Ring tests have also shown that there can be large variations between results obtained by different laboratories, but good agreement is normally obtained with easily biodegradable compounds.

I.5.2. Validity of the test

A test is considered valid if the difference of extremes of replicate values of the removal of test chemical at the plateau, at the end of the test or at the end of the 10-day window, as appropriate, is less than 20 % and if the percentage degradation of the reference substance has reached the level for ready biodegradability by 14 days. If either of these conditions is not met, the test should be repeated. Because of the stringency of the methods, low values do not necessarily mean that the test substance is not biodegradable under environmental conditions, but indicates that more work will be necessary to establish biodegradability.

If in a toxicity test, containing both the test substance and a reference chemical, less than 35 % degradation (based on DOC) or less than 25 % (based on ThOD or ThCO₂) occurred in 14 days, the test chemicals can be assumed to be inhibitory (see also Appendix 4). The test series should be repeated, if possible using a lower concentration of test chemical and/or a higher concentration of inoculum, but not greater than 30 mg solids/litre.

I.6. GENERAL PROCEDURES AND PREPARATIONS

General conditions applying to the tests are summarised in Table 2. Apparatus and other experimental conditions pertaining specifically to an individual test are described later under the heading for that test.



Table 2

Test conditions

Test	DOC Die-Away	CO ₂ Evolution	Manometric Respirometry	Modified OECD Screening	Closed Bottle	MITI (l)
Concentration of Test Substance						
as mg/l			100		2-10	100
mg DOC/l	10-40	10-20		10-40		
mg ThoD/l			50-100		5-10	
Concentration of Inoculum (in cells/l, approximately)	≤ 30 mg/l SS or ≤ 100 ml effluent/l (10 ⁷ -10 ⁸)			0,5 ml secondary effluent/l (10 ⁵)	≤ 5 ml of effluent/l (10 ⁴ -10 ⁶)	30 mg/l SS (10 ⁷ -10 ⁸)
Concentration of elements in mineral medium (in mg/l):						
P						116
N						1,3
Na						86
K						122
Mg						2,2
Ca						9,9
Fe						0,05 - 0,1
pH	7,4 ± 0,2					preferably 7,0
Temperature	22 ± 2 °C					25 ± 1 °C

DOC = Dissolved organic Carbon ThoD = Theoretical Oxygen Demand SS = Suspended Solids

1.6.1. Dilution water

Deionised or distilled water, free from inhibitory concentrations of toxic substances (e.g. Cu⁺⁺ ions) is used. It must contain no more than 10 % of the organic carbon content introduced by the test material. The high purity of the test water is necessary to eliminate high blank values. Contamination may result from inherent impurities and also from the ion-exchange resins and lysed material from bacterial and algae. For each series of tests use only one batch of water, checked beforehand by DOC analysis. Such a check is not necessary for the closed bottle test, but the oxygen consumption of the water must be low.

▼ B**I.6.2. Stock solutions of mineral components**

To make up the test solutions, stock solutions of appropriate concentrations of mineral components are made up. The following stock solutions may be used (with different dilution factors) for the methods DOC Die-Away, Modified OECD Screening, CO₂ Evolution, Manometric Respirometry, Closed Bottle test.

The dilution factors and, for the MITI test, the specific preparation of the mineral medium are given under the headings of the specific tests.

Stock solutions:

Prepare the following stock solutions, using analytical grade reagents.

(a) Monopotassium dihydrogen orthophosphate, KH₂PO₄ 8,50 g

Dipotassium monohydrogen orthophosphate, K₂HPO₄ 21,75 g

Disodium monohydrogen orthophosphate dihydrate Na₂HPO₄ · 2 H₂O 33,40 g

Ammonium chloride, NH₄Cl 0,50 g

Dissolve in water and make up to 1 litre The pH of the solution should be 7,4.

(b) Calcium chloride, anhydrous, CaCl₂ 27,50g

or Calcium chloride dihydrate, CaCl₂ · 2 H₂O 36,40 g

Dissolve in water and make up to 1 litre

(c) Magnesium sulphate heptahydrate, MgSO₄ · 7 H₂O 22,50 g

Dissolve in water and make up to 1 litre.

(d) Iron (III) chloride hexahydrate, FeCl₃ · 6H₂O 0,25 g

Dissolve in water and make up to 1 litre.

Note: in order to avoid having to prepare this solution immediately before use add one drop of conc. HCL or 0,4 g ethylenediaminetetra-acetic acid disodium salt (EDTA) per litre.

I.6.3. Stock solutions of chemicals

For example, dissolve 1-10 g, as appropriate, of test or reference chemical in deionised water and make up to 1 litre when the solubility exceeds 1 g/l. Otherwise, prepare stock solutions in the mineral medium or add the chemical direct to the mineral medium. For the handling of less soluble chemicals, see Appendix 3, but in the MITI test (Method C.4-F), neither solvents nor emulsifying agents are to be used.

▼ B**I.6.4. Inocula**

The inoculum may be derived from a variety of sources: activated sludge, sewage effluents (unchlorinated), surface waters and soils or from a mixture of these. For the DOC Die-Away, CO₂ Evolution and Manometric Respirometry tests, if activated sludge is used, it should be taken from a treatment plant or laboratory-scale unit receiving predominantly domestic sewage. Inocula from other sources have been found to give higher scattering of results. For the Modified OECD Screening and the Closed Bottle tests a more dilute inoculum without sludge flocs is needed and the preferred source is a secondary effluent from a domestic waste water treatment plant or laboratory-scale unit. For the MITI test the inoculum is derived from a mixture of sources and is described under the heading of this specific test.

I.6.4.1. *Inoculum from activated sludges*

Collect a sample of activated sludge freshly from the aeration tank of a sewage treatment plant or laboratory-scale unit treating predominantly domestic sewage. Remove coarse particles if necessary by filtration through a fine sieve and keep the sludge aerobic thereafter.

Alternatively, settle or centrifuge (e.g. at 100 g for 10 min) after removal of any coarse particles. Discard the supernatant. The sludge may be washed in the mineral medium. Suspend the concentrated sludge in mineral medium to yield a concentration of 3-5 g suspended solids/l and aerate until required.

Sludge should be taken from a properly working conventional plant. If sludge has to be taken from a high rate treatment plant, or is thought to contain inhibitors, it should be washed. Settle or centrifuge the re-suspended sludge after thorough mixing, discard the supernatant and again re-suspend the washed sludge in a further volume of mineral medium. Repeat this procedure until the sludge is considered to be free from excess substrate or inhibitor.

After complete re-suspension is achieved, or with untreated sludge, withdraw a sample just before use for the determination of the dry weight of the suspended solids.

A further alternative is to homogenise activated sludge (3-5 g suspended solids/l). Treat the sludge in a mechanical blender for two min at medium speed. Settle the blended sludge for 30 min or longer if required and decant liquid for use as inoculum at the rate of 10 mill of mineral medium.

I.6.4.2. *Other sources of inoculum*

It can be derived from the secondary effluent of a treatment plant or laboratory-scale unit receiving predominantly domestic sewage. Collect a fresh sample and keep it aerobic during transport. Allow to settle for 1 h. or filter through a coarse filter paper and keep the decanted effluent or filtrate aerobic until required. Up to 100 ml of this type of inoculum may be used per litre of medium.

▼B

A further source for the inoculum is surface water. In this case, collect a sample of an appropriate surface water, e.g. river, lake, and keep aerobic until required. If necessary, concentrate the inoculum by filtration or centrifugation.

I.6.5. Pre-conditioning of inocula

Inocula may be pre-conditioned to the experimental conditions, but not pre-adapted to the test chemical. Pre-conditioning consists of aerating activated sludge in mineral medium or secondary effluent for five to seven days at the test temperature. Pre-conditioning sometimes improves the precision of the test methods by reducing blank values. It is considered unnecessary to pre-condition MITI inoculum.

I.6.6. Abiotic controls

When required, check for the possible abiotic degradation of the test substance by determining the removal of DOC, oxygen uptake or carbon dioxide evolution in sterile controls containing no inoculum. Sterilise by filtration through a membrane (0,2 - 0,45 micrometre) or by the addition of a suitable toxic substance at an appropriate concentration. If membrane filtration is used, take samples aseptically to maintain sterility. Unless adsorption of the test chemical has been ruled out beforehand, tests which measure biodegradation as the removal of DOC, especially with activated sludge inocula, should include an abiotic control which is inoculated and poisoned.

I.6.7. Number of flasks

The number of flasks in a typical run is described under the headings of each tests.

The following type of flask may be used:

- test suspension: containing test substance and inoculum
- inoculum blank: containing only inoculum
- procedure control: containing reference substance and inoculum
- abiotic sterile control: sterile, containing test substance (see 1.6.6)
- adsorption control: containing test substance, inoculum and sterilising agent
- toxicity control: containing test substance, reference substance and inoculum

It is mandatory that determination in test suspension and inoculum blank is made in parallel. It is advisable to make the determinations in the other flasks in parallel as well.

This may, however, not always be possible. Ensure that sufficient samples or readings are taken to allow the percentage removal in the 10-day window to be assessed.

▼ B**I.7. DATA AND EVALUATION**

In the calculation of D_t , percentage degradation, the mean values of the duplicate measurement of the parameter in both test vessels and inoculum blank are used. The formulas are set out in the sections below on specific tests. The course of degradation is displayed graphically and the 10-day window is indicated. Calculate and report the percentage removal achieved at the end of the 10-day window and the value at the plateau or at the end of the test, whichever is appropriate.

In respirometric tests nitrogen-containing compounds may affect the oxygen uptake because of nitrification (see Appendices 2 and 5).

I.7.1. Degradation measured by means of DOC determination

The percentage degradation D_t at each time a sample was taken should be calculated separately for the flasks containing test substance using mean values of duplicate DOC measurements in order that the validity of the test can be assessed (see 1.5.2). It is calculated using the following equation:

$$D_t = \left(1 - \frac{C_t - C_{bt}}{C_o - C_{bo}} \right) \times 100$$

where:

D_t = % degradation at time t

C_o = mean starting concentration of DOC in the inoculated culture medium containing the test substance (mg DOC/l)

C_t = mean concentration of DOC in the inoculated culture medium containing test substance at time t (mg DOC/l)

C_{bo} = mean starting concentration of DOC in blank inoculated mineral medium (mg DOC/l)

C_{bt} = mean concentration of DOC blank inoculated mineral medium at time t (mg DOC/l).

All concentrations are measured experimentally.

I.7.2. Degradation measured by means of specific analysis

When specific analytical data are available, calculate primary biodegradation from:

$$D_t = \frac{S_b - S_a}{S_b} \times 100$$

where:

D_t = % degradation at time t, normally 28 days,

S_a = residual amount of test substance in inoculated medium at end of test (mg),

S_b = residual amount of test substance in the blank test with water/medium to which only the test substance was added (mg).

▼ B**1.7.3. Abiotic degradation**

When an abiotic sterile control is used, calculate the percentage abiotic degradation using:

$$\% \text{ abiotic degradation} = \frac{C_{s(0)} - C_{s(t)}}{C_{s(0)}} \times 100$$

Where:

$C_{s(0)}$ = DOC Concentration in sterile control at day 0

$C_{s(t)}$ = DOC Concentration in sterile control at day t.

I.8. REPORTING

The test report shall, if possible, contain the following:

- test and reference chemicals, and their purity,
- test conditions,
- inoculum: nature and sampling site(s), concentration and any pre-conditioning treatment,
- proportion and nature of industrial waste present in sewage if known,
- test duration and temperature,
- in the case of poorly soluble test chemicals, treatment given,
- test method applied; scientific reasons and explanation should be given for any change of procedure,
- data sheet,
- any observed inhibition phenomena,
- any observed abiotic degradation,
- specific chemical analytical data, if available,
- analytical data on intermediates, if available,
- the graph of percentage degradation against time for the test and reference substances; the lag phase, degradation phase, 10-day window and slope should be clearly indicated (Appendix 1). If the test has complied with the validity criteria, the mean of the degradation percentages of the flasks containing test substance may be used for the graph,
- percentage removal after 10-day window, and at plateau or at end of the test.

PART II. DOC DIE-AWAY TEST (Method C.4-A)**II.1. PRINCIPLE OF THE METHOD**

A measured volume of inoculated mineral medium containing a known concentration of the test substance (10-40 mg DOC/l) as the nominal sole source of organic carbon is aerated in the dark or diffused light at 22 ± 2 °C.

▼ B

Degradation is followed by DOC analysis at frequent intervals over a 28-day period. The degree of biodegradation is calculated by expressing the concentration of DOC removed (corrected for that in the blank inoculum control) as a percentage of the concentration initially present. The degree of primary biodegradation may also be calculated from supplemental chemical analysis made at the beginning and end of incubation.

II.2. DESCRIPTION OF THE METHOD**II.2.1. Apparatus**

- (a) Conical flasks, e. g. 250 ml to 2 l, depending on the volume needed for DOC analysis;
- (b) shaking machine to accommodate the conical flasks, either with automatic temperature control or used in a constant temperature room; and of sufficient power to maintain aerobic conditions in all flasks;
- (c) filtration apparatus, with suitable membranes;
- (d) DOC analyser;
- (e) apparatus for determining dissolved oxygen;
- (f) centrifuge.

II.2.2. Preparation of mineral medium

For the preparation of the stock solutions, see I.6.2.

Mix 10 ml of solution (a) with 800 ml dilution water, add 1 ml of solutions (b) to (d) and make up to 1 l with dilution water.

II.2.3. Preparation and pre-conditioning of inoculum

The inoculum may be derived from a variety of sources: activated sludge; sewage effluents; surface waters; soils or from a mixture of these.

See I.6.4., I.6.4.1., I.6.4.2. and I.6.5.

II.2.4. Preparation of flasks

As an example, introduce 800 ml portions of mineral medium into 2 l conical flasks and add sufficient volumes of stock solutions of the test and reference substances to separate flasks to give a concentration of chemical equivalent to 10-40 mg DOC/l. Check the pH values and adjust, if necessary, to 7.4. Inoculate the flasks with activated sludge or other source of inocula (see I.6.4.), to give a final concentration not greater than 30 mg suspended solids/l. Also prepare inoculum controls in the mineral medium but without test or reference chemical.

If needed, use one vessel to check the possible inhibitory effect of the test chemical by inoculating a solution containing, in the mineral medium, comparable concentrations of both the test and a reference chemical.

Also, if required, set up a further, sterile flask to check whether the test chemical is degraded abiotically by using an uninoculated solution of the chemical (see I.6.6).

▼ B

Additionally, if the test chemical is suspected of being significantly adsorbed on to glass, sludge, etc., make a preliminary assessment to determine the likely extent of adsorption and thus the suitability of the test for the chemical (see Table 1). Set up a flask containing the test substance, inoculum and sterilising agent.

Make up the volumes in all flasks to 11 with mineral medium and, after mixing, take a sample from each flask to determine the initial concentration of DOC (see Appendix 2.4). Cover the openings of the flasks, e.g. with aluminium foil, in such a way as to allow free exchange of air between the flask and the surrounding atmosphere. Then insert the vessels into the shaking machine for starting the test.

II.2.5. Number of flasks in typical run

Flasks 1 and 2: Test suspension

Flasks 3 and 4: Inoculum blank

Flask 5: Procedure control

preferably and when necessary:

Flask 6: Abiotic sterile control

Flask 7: Adsorption control

Flask 8: Toxicity control

See also I.6.7.

II.2.6. Performance of the test

Throughout the test, determine the concentrations of DOC in each flask in duplicate at known time intervals, sufficiently frequently to be able to determine the start of the 10-day window and the percentage removal at the end of the 10-day window. Take only the minimal volume of test suspension necessary for each determination.

Before sampling make good evaporation losses from the flasks by adding dilution water (I.6.1) in the required amount if necessary. Mix the culture medium thoroughly before withdrawing a sample and ensure that material adhering to the walls of the vessels is dissolved or suspended before sampling. Membrane-filter or centrifuge (see Appendix 2.4) immediately after the sample has been taken. Analyse the filtered or centrifuged samples on the same day, otherwise store at 2-4 °C for a maximum of 48 h, or below - 18 °C for a longer period.

II.3. DATA AND REPORTING**II.3.1. Treatment of results**

Calculate the percentage degradation at time t as given under I.7.1 (DOC determination) and, optionally, under I.7.2 (specific analysis).

Record all results on the data sheets provided.

▼ B**II.3.2. Validity of results**

See I.5.2.

II.3.3. Reporting

See I.8.

II.4. DATA SHEET

An example of a data sheet is given hereafter.

DOC DIE-AWAY TEST**1. LABORATORY****2. DATE AT START OF TEST****3. TEST SUBSTANCE**

Name:

Stock solution concentration: ... mg/l as chemical

Initial concentration in medium, to: ... mg/l as chemical

4. INOCULUM

Source:

Treatment given:

Pre-conditioning, if any:

Concentration of suspended solids in reaction mixture: mg/l

5. CARBON DETERMINATIONS

Carbon analyser:

	Flask nr		DOC after n-days (mg/l)				
			0	n ₁	n ₂	n ₃	n _x
Test chemical plus inoculum	1	a ₁					
		a ₂					
		a, mean C _{a(t)}					
	2	b ₁					
		b ₂					
		b, men C _{b(t)}					

▼ **B**

	Flask nr		DOC after n-days (mg/l)				
			0	n ₁	n ₂	n ₃	n _x
Blank inoculum without test chemical	3	C ₁					
		C ₂					
		C, mean C _{c(t)}					
	4	d ₁					
		d ₂					
		d, mean C _{d(t)}					
$C_{bl(t)} = \frac{C_{c(t)} + C_{d(t)}}{2}$							

6. EVALUATION OF RAW DATA

Flask nr		% degradation after n days				
		0	n ₁	n ₂	n ₃	n _x
1	$D_1 = \left(1 - \frac{C_{a(t)} - C_{bl(t)}}{C_{a(o)} - C_{bl(o)}}\right) \times 100$	0				
2	$D_2 = \left(1 - \frac{C_{b(t)} - C_{bl(t)}}{C_{b(o)} - C_{bl(o)}}\right) \times 100$	0				
Mean (*)	$D = \frac{D_1 - D_2}{2}$	0				

(*) D₁ and D₂ should not be averaged if there is a considerable difference.

Note: similar formats may be used for the reference chemical and toxicity controls.

7. ABIOTIC CONTROL (optional)

	Time (days)	
	0	t
DOC conc. (mg/l) in sterile control	C _{s(o)}	C _{s(t)}

$$\% \text{ abiotic degradation} = \frac{C_{s(o)} - C_{s(t)}}{C_{s(o)}} \times 100$$

8. SPECIFIC CHEMICAL ANALYSIS (optional)

	residual amount of test chemical at end of test (mg/l)	% primary degradation
Sterile control	S _b	

▼ B

	residual amount of test chemical at end of test (mg/l)	% primary degradation
Inoculated test medium	S_a	$\frac{S_b - S_a}{S_b} \times 100$

PART III. MODIFIED OECD SCREENING TEST
(Method C.4-B)

III.1. PRINCIPLE OF THE METHOD

A measured volume of mineral medium containing a known concentration of the test substance (10-40 mg DOC/litre) as the nominal sole source of organic carbon is inoculated with 0,5 ml effluent per litre of medium. The mixture is aerated in the dark or diffused light at 22 ± 2 °C.

Degradation is followed by DOC analysis at frequent intervals over a 28-day period. The degree of biodegradation is calculated by expressing the concentration of DOC removed (corrected for that in the blank inoculum control) as a percentage of the concentration initially present. The degree of primary biodegradation may also be calculated from supplemental chemical analysis made at the beginning and end of incubation.

III.2. DESCRIPTION OF THE METHOD

III.2.1. Apparatus

- (a) Conical flasks, e.g. 250 ml to 2 litres, depending on the volume needed for DOC analysis;
- (b) shaking machine — to accommodate the conical flasks, either with automatic temperature control or used in a constant temperature room, and of sufficient power to maintain aerobic conditions in all flasks;
- (c) filtration apparatus, with suitable membranes;
- (d) DOC analyser;
- (e) apparatus for determining dissolved oxygen;
- (f) centrifuge.

III.2.2. **Preparation of mineral medium**

For the preparation of the stock solutions, see I.6.2.

Mix 10 ml of solution (a) with 80 ml dilution water, add 1 ml of solutions (b) to (d) and make up to 1 litre with dilution water.

This method uses only 0,5 ml effluent/litre as inoculum and therefore the medium may need to be fortified with trace elements and growth factors. This is done by adding 1 ml each of the following solutions per litre of final medium:

▼ B

Trace element solution:

Manganese sulfate tetrahydrate, $\text{MnSO}_4 \cdot 4\text{H}_2\text{O}$	39,9 mg
Boric acid, H_3BO_3	57,2 mg
Zinc sulfate heptahydrate, $\text{ZnSO}_4 \cdot 7\text{H}_2\text{O}$	42,8 mg
Ammonium heptamolybdate $(\text{NH}_4)_6 \text{Mo}_7\text{O}_{24}$	34,7 mg
Fe-chelate (FeCl_3 ethylenediamine-tetra-acetic acid)	100,0 mg

Dissolve in, and make up to 1 000 ml with dilution water

Vitamin solution:

Yeast extract	15,0 mg
---------------	---------

Dissolve the yeast extract in 100 ml water. Sterilise by passage through a 0,2 micron membrane, or make up freshly.

III.2.3. Preparation and pre-conditioning of inoculum

The inoculum is derived from the secondary effluent of a treatment plant or laboratory scale unit receiving predominantly domestic sewage. See I.6.4.2. and I.6.5.

0,5 ml per litre of mineral medium is used.

III.2.4. Preparation of flasks

As an example, introduce 800 ml portions of mineral medium into 2-litre conical flasks and add sufficient volumes of stock solutions of the test and reference substances to separate flasks to give a concentration of chemical equivalent to 10-40 mg DOC/litre. Check the pH value and adjust, if necessary, to 7,4. Inoculate the flasks with sewage effluent at 0,5 ml/litre (see I.6.4.2). Also prepare inoculum controls in the mineral medium but without test or reference chemical.

If needed, use one vessel to check the possible inhibitory effect of the test chemical by inoculating a solution containing, in the mineral medium, comparable concentrations of both the test and a reference chemical.

Also, if required, set up a further, sterile flask to check whether the test chemical is degraded abiotically by using an uninoculated solution of the chemical (see I.6.6).

Additionally, if the test chemical is suspected of being significantly adsorbed on to glass, sludge, etc., make a preliminary assessment to determine the likely extent of adsorption and thus the suitability of the test for the chemical (see Table 1). Set up a flask containing the test substance, inoculum and sterilising agent.

Make up the volumes in all flasks to 1 litre with mineral medium and, after mixing, take a sample from each flask to determine the initial concentration of DOC (see Appendix 2.4). Cover the openings of the flasks, e.g. with aluminium foil, in such a way as to allow free exchange of air between the flask and the surrounding atmosphere. Then insert the vessels into the shaking machine for starting the test.

▼ B**III.2.5. Number of flasks in typical run**

Flasks 1 and 2: test suspension

Flasks 3 and 4: inoculum blank

Flask 5: procedure control

and preferably and when necessary:

Flask 6: abiotic sterile control

Flask 7: adsorption control

Flask 8: toxicity control

See also 1.6.7.

III.2.6. Performance of the test

Throughout the test, determine the concentrations of DOC in each flask in duplicate at known time intervals, sufficiently frequently to be able to determine the start of the 10-day window and the percentage removal at the end of the 10-day window. Take only the minimal volume of test suspension necessary for each determination.

Before sampling make good evaporation losses from the flasks by adding dilution water (I.6.1) in the required amount if necessary. Mix the culture medium thoroughly before withdrawing a sample and ensure that material adhering to the walls of the vessels is dissolved or suspended before sampling. Membrane-filter or centrifuge (see Appendix 2.4) immediately after the sample has been taken. Analyse the filtered or centrifuged samples on the same day, otherwise store at 2-4 °C for a maximum of 48 h, or below 18 °C for a longer period.

III.3. DATA AND REPORTING**III.3.1. Treatment of results**

Calculate the percentage degradation at time *t* as given under I.7.1 (DOC determination) and, optionally, under I.7.2 (specific analysis).

Record all results on the data sheets provided.

III.3.2. Validity of results

See I.5.2.

III.3.3. Reporting

See I.8.

III.4. DATA SHEET

An example of a data sheet is given hereafter

MODIFIED OECD SCREENING TEST**1. LABORATORY****2. DATE AT START OF TEST**

▼B**3. TEST SUBSTANCE**

Name:

Stock solution concentration: ... mg/litre as chemical

Initial concentration in medium, to: ... mg/litre as chemical

4. INOCULUM

Source:

Treatment given:

Pre-conditioning, if any:

Concentration of suspended solids in reaction mixture: mg/l

5. CARBON DETERMINATIONS

Carbon analyser:

	Flask nr		DOC after n-days (mg/l)				
			0	n ₁	n ₂	n ₃	n _x
Test chemical plus inoculum	1	a ₁					
		a ₂					
		a, mean C _{a(t)}					
	2	b ₁					
		b ₂					
		b, men C _{b(t)}					
Blank inoculum without test chemical	3	C ₁					
		C ₂					
		C, mean C _{c(t)}					
	4	d ₁					
		d ₂					
		d, mean C _{d(t)}					
	$C_{bl(t)} = \frac{C_{c(t)} + C_{d(t)}}{2}$						

6. EVALUATION OF RAW DATA

Flask nr		% degradation afer n days				
		0	n ₁	n ₂	n ₃	n _x
1	$D_1 = \left(1 - \frac{C_{a(t)} - C_{bl(t)}}{C_{a(o)} - C_{bl(o)}} \right) \times 100$	0				

▼ B

Flask nr		% degradation afer n days				
		0	n ₁	n ₂	n ₃	n _x
2	$D_2 = \left(1 - \frac{C_{b(t)} - C_{bl(t)}}{C_{b(o)} - C_{bl(o)}} \right) \times 100$	0				
Mean (*)	$D = \frac{D_1 - D_2}{2}$	0				

(*) D₁ and D₂ should not be averaged if there is a considerable difference.

Note: similar formats may be used for the reference chemical and toxicity controls.

7. ABIOTIC CONTROL (optional)

	Time (days)	
	0	t
DOC conc. (mg/l) in sterile control	C _{s(o)}	C _{s(t)}

$$\% \text{ abiotic degradation} = \frac{C_{s(o)} - C_{s(t)}}{C_{s(o)}} \times 100$$

8. SPECIFIC CHEMICAL ANALYSIS (optional)

	residual amount of test chemical at end of test (mg/l)	% primary degradation
Sterile control	S _b	
Inoculated test medium	S _a	$\frac{S_b - S_a}{S_b} \times 100$

PART IV. CO₂ EVOLUTION TEST (Method C.4-C)

IV.1. PRINCIPLE OF THE METHOD

A measured volume of inoculated mineral medium containing a known concentration of the test chemical (10-20 mg DOC or TOC/l) as the nominal sole source of organic carbon is aerated by the passage of carbon, dioxide-free air at a controlled rate in the dark or in diffuse light. Degradation is followed over 28 days by determining the carbon dioxide produced, which is trapped in barium or sodium hydroxide and which is measured by titration of the residual hydroxide or as inorganic carbon. The amount of carbon dioxide produced from the test chemical (corrected for that derived from the blank inoculum) is expressed as a percentage of ThCO₂. The degree of biodegradation may also be calculated from supplemental DOC analysis made at the beginning and end of incubation.

▼ B

IV.2. DESCRIPTION OF THE METHOD

IV.2.1. **Apparatus**

- (a) Flasks, 2-5 litres, each fitted with an aeration tube reaching nearly the bottom of the vessel and an outlet;
- (b) magnetic stirrers, when assessing poorly soluble chemicals;
- (c) gas-absorption bottles;
- (d) device for controlling and measuring airflow;
- (e) apparatus for carbon dioxide scrubbing, for preparation of air which is free from carbon dioxide; alternatively, a mixture of CO₂-free oxygen and CO₂-free nitrogen, from gas cylinders, in the correct proportions (20 % O₂: 80 % N₂) may be used;
- (f) device for determination of carbon dioxide, either titrimetrically or by some form of inorganic carbon analyser;
- (g) membrane filtration device (optional);
- (h) DOC analyser (optional).

IV.2.2. **Preparation of mineral medium**

For the preparation of the stock solutions, see I.6.2.

Mix 10 ml of solution (a) with 800 ml dilution water, add 1 ml of solutions (b) to (d) and make up to 1 l with dilution water.

IV.2.3. **Preparation and pre-conditioning of inoculum**

The inoculum may be derived from a variety of sources: activated sludge; sewage effluents; surface waters; soils or from a mixture of these.

See I.6.4., I.6.4.1., I.6.4.2. and I.6.5.

IV.2.4. **Preparation of flasks**

As an example the following volumes and weights indicate the values for 5-litre flasks containing 3 l of suspension. If smaller volumes are used modify the values accordingly, but ensure that the carbon dioxide formed can be measured accurately.

To each 5-litre flask add 2400 ml mineral medium. Add an appropriate volume of the prepared activated sludge (see I.6.4.1 and I.6.5) to give a concentration of suspended solids of not more than 30 mg/l in the final 3 l of inoculated mixture. Alternatively first dilute the prepared sludge to give a suspension of 500-1000 mg/l in the mineral medium before adding an aliquot to the contents of the 5 litre flask to attain a concentration of 30 mg/l; this ensures greater precision. Other sources of inoculum may be used (see I.6.4.2.).

Aerate these inoculated mixtures with CO₂-free air overnight to purge the system of carbon dioxide.

▼B

Add the test material and reference substance, separately, as known volume of stock solutions, to replicate flasks to yield concentrations, contributed by the added chemicals, of 10 to 20 mg DOC or TOC/l; leave some flasks without addition of chemicals as inoculum controls. Add poorly soluble test substances directly to the flasks on a weight or volume basis or handle as described in Appendix 3.

If required, use one flask to check the possible inhibitory effect of the test chemical by adding both the test and reference chemicals at the same concentrations as present in the other flasks.

Also, if required, use a sterile flask to check whether the test chemical is degraded abiotically by using an uninoculated solution of the chemical (see I.6.6). Sterilise by the addition of a toxic substance at an appropriate concentration.

Make up the volumes of suspensions in all flasks to 3 l by the addition of mineral medium previously aerated with CO₂-free air. Optionally, samples may be withdrawn for analysis of DOC (see Appendix 2.4.) and/or specific analysis. Connect the absorption bottles to the air outlets of the flasks.

If barium hydroxide is used, connect three absorption bottles, each containing 100 ml of 0,0125 M barium hydroxide solution, in series to each 5-litre flask. The solution must be free of precipitated sulphate and carbonate and its strength must be determined immediately before use. If sodium hydroxide is used, connect two traps, the second acting as a control to demonstrate that all the carbon dioxide was absorbed in the first. Absorption bottles fitted with serum bottle closures are suitable. Add 200 ml 0,05 M sodium hydroxide to each bottle, which is sufficient to absorb the total quantity of carbon dioxide evolved when the test chemical is completely degraded. The sodium hydroxide solution, even when freshly prepared, will contain traces of carbonates; this is corrected by deduction of the carbonate in the blank.

IV.2.5. Number of flasks in a typical run

Flasks 1 and 2: Test suspension

Flasks 3 and 4: Inoculum blank

Flask 5: Procedure control

and, preferably and when necessary:

Flask 6: Abiotic sterile control

Flask 7: Toxicity control

See also I.6.7.

IV.2.6. Performance of the test

Start the test by bubbling CO₂-free air through the suspensions at a rate of 30-100 ml/min. Take samples of the carbon dioxide absorbent periodically for analysis of the CO₂-content. During the first ten days it is recommended that analyses should be made every second or third day and then every fifth day until the 28th day so that the 10-day window period can be identified.

▼ B

On the 28th day, withdraw samples (optionally) for DOC and/or specific analysis, measure the pH of the suspensions and add 1 ml of concentrated hydrochloric acid to each flask; aerate the flasks overnight to drive off the carbon dioxide present in the test suspensions. On day 29 make the last analysis of evolved carbon dioxide.

On the days of measurement of CO₂, disconnect the barium hydroxide absorber closest to the flask and titrate the hydroxide solution with HCl 0,05 M using phenolphthalein as the indicator. Move the remaining absorbers one place closer to the flask and place a new absorber containing 100 ml fresh 0,0125 M barium hydroxide at the far end of the series. Make titrations as needed, for example, when substantial precipitation is seen in the first trap and before any is evident in the second, or at least weekly. Alternatively, with NaOH as absorbent, withdraw with a syringe a small sample (depending on the characteristics of the carbon analyser used) of the sodium hydroxide solution in the absorber nearer to the flask. Inject the sample into the IC part of the carbon analyser for analysis of evolved carbon dioxide directly.

Analyse the contents of the second trap only at the end of the test to correct for any carryover of carbon dioxide.

IV.3. DATA AND REPORTING

IV.3.1. Treatment of results

The amount of CO₂ trapped in an absorber when titrated is given by:

$$\text{mgCO}_2 = (100 \times C_B - 0,5 \times V \times C_A) \times 44$$

where:

V = volume of HCl used for titration of the 100 ml in the absorber (ml)

C_B = concentration of the barium hydroxide solution (M)

C_A = concentration of the hydrochloric acid solution (M)

if C_B is 0,0125 M and C_A is 0,05 M, the titration for 100 ml barium hydroxide is 50 ml and the weight of CO₂ is given by:

$$\frac{0,05}{2} \times 44 \times \text{ml HCl titrated} = 1,1 \times \text{ml HCl}$$

Thus, in this case, to convert volume of HCl titrated to mg CO₂ produced the factor is 1,1.

Calculate the weights of CO₂ produced from the inoculum alone and from the inoculum plus test chemical using the respective titration values and the difference is the weight of CO₂ produced from the test chemical alone.

For example, if the inoculum alone gives a titration of 48 ml and inoculum plus test chemical gives 45 ml,

$$\text{CO}_2 \text{ from inoculum} = 1,1 \times (50-48) = 2,2 \text{ mg}$$

▼ B

CO_2 from inoculum plus test chemical = $1,1 \times (50-45) = 5,5$ mg

and thus the weight of CO_2 produced from the test chemical is 3,3 mg.

The percentage biodegradation is calculated from:

$$\% \text{degradation} = \frac{\text{mg CO}_2 \text{ produced} \times 100}{\text{ThCO}_2 \times \text{mg test chemical added}}$$

or,

$$\% \text{degradation} = \frac{\text{mg CO}_2 \text{ produced} \times 100}{\text{mg TO added in test} \times 3,67}$$

3,67 being the conversion factor (44/12) for carbon to carbon dioxide.

Obtain the percentage degradation after any time interval by adding the percentage of ThCO_2 values calculated for each of the days, up to that time, on which it was measured.

For sodium hydroxide absorbers, calculate the amount of carbon dioxide produced, expressed as IC (mg), by multiplying the concentration of IC in the absorbent by the volume of the absorbent.

Calculate the percentage degradation from:

$$\% \text{ of ThCO}_2 = \frac{\text{mg IC flask} - \text{mg IC blank}}{\text{MG TOC added as test chemical}} \times 100$$

Calculate DOC removals (optional) as described under I.7. Record these and all other results on the data sheets provided.

IV.3.2. **Validity of results**

The IC content of the test chemical suspension in the mineral medium at the beginning of the test must be less than 5 % of the TC, and the total CO_2 evolution in the inoculum blank at the end of the test should not normally exceed 40 mg/l medium. If values greater than 70 mg CO_2 /litre are obtained, the data and experimental technique should be examined critically.

See also I.5.2.

IV.3.3. **Reporting**

See I.8.

IV.4. DATA SHEET

An example of a data sheet is given hereafter.

CARBON DIOXIDE EVOLUTION TEST

1. LABORATORY

2. DATE AT START OF TEST

3. TEST SUBSTANCE

Name:

Stock solution concentration: ... mg/litre as chemical

▼B

Initial conc. in medium: ... mg/litre as chemical

Total C added to flask: ... mg C

ThCO₂: mg CO₂**4. INOCULUM**

Source:

Treatment given:

Pre-conditioning if any:

Concentration of suspended solids in reaction mixture: mg/litre

Time (day)	CO ₂ formed Test (mg)		CO ₂ formed blank (mg)		CO ₂ formed cumu- lative (mg) (test minus blank mean)		ThCO ₂ cumulative $\frac{\text{CO}_2}{\text{ThCO}_2} \times 100$		
	1 2	mean	3 4	mean	1	2	1	2	mean
0									
n ₁									
n ₂									
n ₃									
28									

Note: similar formats may be used for the reference chemical and toxicity controls.

6. CARBON ANALYSIS (optional)

Carbon analyser:

Time (day)	Blank mg/l	Test chemical mg/l
0	C _{b(0)}	C ₀
28 (*)	C _{b(t)}	C _t

(*) Or at end of incubation

▼B

$$\% \text{ DOC removed} = \left(1 - \frac{C_t - C_{b(t)}}{C_o - C_{b(o)}} \right) \times 100$$

7. ABIOTIC DEGRADATION (optional)

$$\% \text{ abiotic degradation} = \frac{\text{CO}_2 \text{ formation in sterile in flask after 28 day (mg)}}{\text{ThCO}_2(\text{mg})} \times 100$$

PART V. MANOMETRIC RESPIROMETRY TEST
(Method C.4-D)**V.1. PRINCIPLE OF THE METHOD**

A measured volume of inoculated mineral medium, containing a known concentration of test chemical (100 mg/litre of the test substance, to give at least 50-100 mg ThOD/litre) as the nominal sole source of organic carbon, is stirred in a closed flask at a constant temperature ($\pm 1^\circ \text{C}$ or closer) for up to 28 days. The consumption of oxygen is determined either by measuring the quantity of oxygen (produced electrolytically) required to maintain constant gas volume in the respirometer flask, or from the change in volume or pressure (or a combination of the two) in the apparatus. Evolved carbon dioxide is absorbed in a solution of potassium hydroxide or another suitable absorbent. The amount of oxygen taken up by the test chemical (corrected for uptake by blank inoculum, run in parallel) is expressed as a percentage of ThOD or COD. Optionally, primary biodegradation may also be calculated from supplemental specific analysis made at the beginning and end of incubation, and ultimate biodegradation by DOC analysis.

V.2. DESCRIPTION OF THE METHOD**V.2.1. Apparatus**

- (a) suitable respirometer;
- (b) temperature control, maintaining $\pm 1^\circ \text{C}$ or better;
- (c) membrane-filtration assembly (optional);
- (d) carbon analyser (optional).

V.2.2. Preparation of mineral medium

For the preparation of the stock solutions, see I.6.2.

Mix 10 ml of solution (a) with 800 ml dilution water, add 1 ml of solutions (b) to (d) and make up to 1 litre with dilution water.

V.2.3. Preparation and pre-conditioning of inoculum

The inoculum may be derived from a variety of sources: activated sludge; sewage effluents; surface waters and soils or from a mixture of these.

See I.6.4., I.6.4.1., I.6.4.2. and I.6.5.

V.2.4. Preparation of flasks

Prepare solutions of the test and reference chemicals, in separate batches, in mineral medium equivalent to a concentration, normally, of 100 mg chemical/litre (giving at least 50-100 mg ThOD/litre), using stock solutions.

▼ B

Calculate the ThOD on the basis of formation of ammonium salts unless nitrification is anticipated, when the calculation should be based on nitrate formation (see Appendix 2.2)

Determine the pH values and if necessary adjust to $7,4 \pm 0,2$.

Poorly soluble substances should be added at a later stage (see below).

If the toxicity of the test chemical is to be determined, prepare a further solution in mineral medium containing both test and reference chemicals at the same concentrations as in the individual solutions.

If measurement of the physico-chemical uptake of oxygen is required, prepare a solution of the test chemical at, normally, 100 mg ThOD/litre which has been sterilised by the addition of a suitable toxic substance (see I.6.6).

Introduce the requisite volume of solutions of test and reference chemicals, respectively, into at least duplicate flasks. Add to further flasks mineral medium only (for inoculum controls) and, if required, the mixed test/reference chemical solution and the sterile solution.

If the test chemical is poorly soluble, add it directly at this stage on a weight or volume basis or handle it as described in Appendix 3. Add potassium hydroxide, soda lime pellets or other absorbent to the CO₂-absorber compartments.

V.2.5. Number of flasks in a typical run

Flasks 1 and 2: test suspension

Flasks 3 and 4: inoculum blank

Flask 5: procedure control

preferably, and when necessary:

Flask 6: sterile control

Flask 7: toxicity control

See also I.6.7.

V.2.6. Performance of the test

Allow the vessels to reach the desired temperature and inoculate appropriate vessels with prepared activated sludge or other source of inoculum to give a concentration of suspended solids not greater than 30 mg/litre. Assemble the equipment, start the stirrer and check for air-tightness, and start the measurement of oxygen uptake. Usually no further attention is required other than taking the necessary readings and making daily checks to see that the correct temperature and adequate stirring are maintained.

Calculate the oxygen uptake from the readings taken at regular and frequent intervals, using the methods given by the manufacturer of the equipment. At the end of incubation, normally 28 days, measure the pH of the contents of the flasks, especially if oxygen uptakes are low or greater than ThODNH₄ (for nitrogen-containing compounds).

▼B

If required, withdraw samples from the respirometer flasks, initially and finally, for analysis of DOC or specific chemical (see Appendix 2.4). At the initial withdrawal, ensure that the volume of test suspension remaining in the flask is known. When oxygen is taken up by N-containing test substance, determine the increase in concentration of nitrite and nitrate over 28 days and calculate the correction for the oxygen consumed by nitrification (Appendix 5).

V.3. DATA AND REPORTING

V.3.1. **Treatment of results**

Divide the oxygen uptake (mg) of the test chemical after a given time (corrected for that by the blank inoculum control after the same time) by the weight of the test chemical used. This yields the BOD expressed as mg oxygen/mg test chemical, that is:

$$\text{BOD} = \frac{(\text{mg O}_2 \text{ uptake by test chemical} - \text{mg O}_2 \text{ uptake by blank})}{(\text{mg test chemical in flask})}$$

= mg O₂ per mg test chemical

calculate the percentage biodegradation either from:

$$\% \text{ biodegradation} = \% \text{ ThOD} = \frac{\text{BOD (mg O}_2/\text{mg chemical)}}{\text{ThOD (mg O}_2 \text{ chemical)}} \times 100$$

or from

$$\% \text{ COD} = \frac{\text{BOD (mg O}_2/\text{mg chemical)}}{\text{COD (mg O}_2 \text{ chemical)}} \times 100$$

It should be noted that these two methods do not necessarily give the same value; it is preferable to use the former method.

For test substances containing nitrogen, use the appropriate ThOD (NH₄ or NO₃) according to what is known or expected about the occurrence of nitrification (Appendix 2.2). If nitrification occurs but is not complete, calculate a correction for the oxygen consumed by nitrification from the changes in concentration of nitrite and nitrate (Appendix 5).

When optional determinations of organic carbon and/or specific chemical are made, calculate the percentage degradation, as described under I.7.

Record all results on the data sheets attached.

V.3.2. **Validity of results**

The oxygen uptake of the inoculum blank is normally 20-30 mg O₂/litre and should not be greater than 60 mg/litre in 28 days. Values higher than 60 mg/litre require critical examination of the data and experimental techniques. If the pH value is outside the range 6-8,5 and the oxygen consumption by the test chemical is less than 60 %, the test should be repeated with a lower concentration of test chemical.

See also I.5.2.

▼ B

		Time (Days)										
		0		7		14		21		28		
% degradation $\frac{\text{BOD}}{\text{ThOD}} \times 100$	D ₁ (a ₁)											
	D ₂ (a ₂)											
	Mean (*)											

V = volume of medium in test flask

(*) D₁ and D₂ should not be averaged if there is a considerable difference.

N.B.: Similar formats may be used for the reference chemical and the toxicity controls.

6. CORRECTION FOR NITRIFICATION (see Annex V)

Day	0	28	Difference
(i) Concentration of nitrate (mg N/litre)			(N)
(ii) Oxygen equivalent ($4,57 \times N \times V$) (mg)	—	—	
(iii) Concentration of nitrite (mg N/litre)			(N)
(iv) Oxygen equivalent ($3,43 \times N \times V$) (mg)	—	—	
(ii + iv) Total oxygen equivalent	—	—	

7. CARBON ANALYSIS (optional)

Carbon analyser:

Time (day)	Blank mg/litre	Test chemical mg/litre
0	(C _{blo})	(C _o)
28 (*)	(C _{blt})	(C _t)

(*) Or at end of incubation

$$\% \text{ DOC removed} = \left(1 - \frac{C_t - C_{blt}}{C_o - C_{blo}} \right) \times 100$$

8. SPECIFIC CHEMICAL (optional)

S_b = concentration in physico-chemical (sterile) control at 28 days

S_a = concentration in inoculated flask at 28 days,

$$\% \text{ biodegradation} = \frac{S_b - S_a}{S_b} \times 100$$

9. ABIOTIC DEGRADATION (optional)

a = oxygen consumption in sterile flasks after 28 days, (mg)

$$\text{oxygen consumption per mg test chemical} = \frac{a \times 100}{C_o V}$$

▼ B

(see Sections 1 and 3)

$$\% \text{ abiotic degradation} = \frac{a \times 100}{C_0 V \times \text{ThOD}}$$

PART VI. CLOSED BOTTLE TEST (Method C.4-E)**VI.1 PRINCIPLE OF THE TEST METHOD**

The solution of the test chemical in mineral medium, usually at 2-5 mg/litre, is inoculated with a relatively small number of micro-organisms from a mixed population and kept in completely full, closed bottles in the dark at constant temperature. Degradation is followed by analysis of dissolved oxygen over a 28-day period. The amount of oxygen taken up by the test chemical, corrected for uptake by the blank inoculum run in parallel, is expressed as a percentage of ThOD or COD.

VI.2 DESCRIPTION OF THE METHOD**VI.2.1. Apparatus**

- a) BOD bottles, with glass stoppers, e.g. 250-300 ml;
- b) water bath or incubator, for keeping bottles at constant temperature (± 1 °C or better) with the exclusion of light;
- c) large glass bottles (2-5 litres) for the preparation of media and for filling the BOD bottles;
- d) oxygen electrode and meter, or equipment and reagents for Winkler titration.

VI.2.2. Preparation of mineral medium

For the preparation of the stock solutions, see I.6.2.

Mix 1 (one) ml of solution (a) to (d) and make up to 1 litre with dilution water.

VI.2.3. Preparation of the inoculum

The inoculum is normally derived from the secondary effluent of a treatment plant or laboratory-scale unit receiving predominantly domestic sewage. An alternative source for the inoculum is surface water. Normally use from one drop (0,05 ml) to 5 ml of filtrate per litre of medium; trials may be needed to discover the optimum volume for a given effluent (See I.6.4.2 and I.6.5).

VI.2.4. Preparation of flasks

Strongly aerate mineral medium for at least 20 min. Carry out each test series with mineral medium derived from the same batch. Generally, the medium is ready for use after standing for 20 h, at the test temperature. Determine the concentration of dissolved oxygen for control purposes; the value should be about 9 mg/litre at 20 °C. Conduct all transfer and filling operations of the air-saturated medium bubble-free, for example, by the use of siphons.

▼ B

Prepare parallel groups of BOD bottles for the determination of the test and reference chemicals in simultaneous experimental series. Assemble a sufficient number of BOD bottles, including inoculum blanks, to allow at least duplicate measurements of oxygen consumption to be made at the desired test intervals, for example, after 0, 7, 14, 21 and 28 days. To ensure being able to identify the 10-day window, more bottles may be required.

Add fully aerated mineral medium to large bottles so that they are about one-third full. Then add sufficient of the stock solutions of the test chemical and reference chemical to separate large bottles so that the final concentration of the chemicals is normally not greater than 10 mg/litre. Add no chemicals to the blank control medium contained in a further large bottle.

In order to ensure that the inoculum activity is not limited, the concentration of dissolved oxygen must not fall below 0,5 mg/litre in the BOD bottles. This limits the concentration of test chemical to about 2 mg/litre. However, for poorly degradable compounds and those with a low ThOD, 5-10 mg/litre can be used. In some cases, it would be advisable to run parallel series of test chemical at two different concentrations, for example, 2 and 5 mg/litre. Normally, calculate the ThOD on the basis of formation of ammonium salts but, if nitrification is expected or known to occur, calculate on the basis of the formation of nitrate (ThOD_{NO3}: see Appendix 2.2). However, if nitrification is not complete but does occur, correct for the changes in concentration of nitrite and nitrate, determined by analysis, (see Appendix 5).

If the toxicity of the test chemical is to be investigated (in the case, for example, of a previous low biodegradability value having been found), another series of bottles is necessary.

Prepare another large bottle to contain aerated mineral medium (to about one-third of its volume) plus test chemical and reference chemical at final concentrations normally the same as those in the other large bottles.

Inoculate the solutions in the large bottles with secondary effluent (one drop or about 0,05 ml, to 5 ml/litre) or with another source such as river water (see I.6.4.2.). Finally, make up the solutions to volume with aerated mineral medium using a hose which reaches down to the bottom of the bottle to achieve adequate mixing.

VI.2.5. Number of flasks in a typical run

In a typical run the following bottles are used:

- at least 10 containing test chemical and inoculum (test suspension),

- at least 10 containing only inoculum (inoculum blank),

- at least 10 containing reference chemical and inoculum (procedure control),

▼B

- and, when necessary, six bottles containing test chemical, reference chemical and inoculum (toxicity control). However, to ensure being able to identify the 10-day window, about twice as many bottles would be necessary.

VI.2.6. Performance of the test

Dispense each prepared solution immediately into the respective group of BOD bottles by hose from the lower quarter (not the bottom) of the appropriate large bottle, so that all the BOD bottles are completely filled. Tap gently to remove any air bubbles. Analyse the zero-time bottles immediately for dissolved oxygen by the Winkler or electrode methods. The contents of the bottles can be preserved for later analysis by the Winkler method by adding manganese (II) sulfate and sodium hydroxide (the first Winkler reagent). Store the carefully stoppered bottles, containing the oxygen fixed as brown manganese (III) hydrated oxide, in the dark at 10-20 °C for no longer than 24 hours before proceeding with the remaining steps of the Winkler method. Stopper the remaining replicate bottles ensuring that no air bubbles are enclosed, and incubate at 20 °C in the dark. Each series must be accompanied by a complete parallel series for the determination of the inoculated blank medium. Withdraw at least duplicate bottles of all series for dissolved oxygen analysis at time intervals (at least weekly) over the 28 days incubation.

Weekly samples should allow the assessment of percentage removal in a 14-day window, whereas sampling every 3-4 days should allow the 10-day window to be identified, which would require about twice as many bottles.

For N-containing test substances, corrections for uptake of oxygen by any nitrification occurring should be made. To do this, use the O₂-electrode method for determining the concentration of dissolved oxygen and then withdraw a sample from the BOD bottle for analysis for nitrite and nitrate. From the increase in concentration of nitrite and nitrate, calculate the oxygen used (see Annex V).

VI.3. DATA AND REPORTING

VI.3.1. Treatment of results

First calculate the BOD exerted after each time period by subtracting the oxygen depletion (mg O₂/litre) of the inoculum blank from that exhibited by the test chemical. Divide this corrected depletion by the concentration (mg/litre) of the test chemical, to obtain the specific BOD as mg oxygen per mg test chemical. Calculate the percentage biodegradability by dividing the specific BOD by the specific ThOD (calculated according to Appendix 2.2) or COD (determined by analysis, see Appendix 2.3), thus:

$$\text{BOD} = \frac{(\text{mg O}_2 \text{ uptake by test chemical} - \text{mg O}_2 \text{ uptake by blank})}{(\text{mg test chemical in flask})}$$

▼ B

= mg O₂ per mg test chemical

$$\% \text{ degradation} = \frac{\text{BOD (mg O}_2\text{/mg test chemical)}}{\text{ThOD (mg O}_2\text{/mg test chemical)}} \times 100$$

Or

$$\% \text{ degradation} = \frac{\text{BOD (mg O}_2\text{/mg test chemical)}}{\text{COD (mg O}_2\text{/mg test chemical)}} \times 100$$

It should be noted that these two methods do not necessarily give same value; it is preferable to use the former method.

For test substances containing nitrogen, use the appropriate ThOD (NH₄ or NO₃) according to what is known or expected about the occurrence of nitrification (Appendix 2.2). If nitrification occurs but is not complete, calculate a correction for the oxygen consumed by nitrification from the changes in concentration of nitrite and nitrate (Appendix 5).

VI.3.2. **Validity of results**

Oxygen depletion in the inoculum blank should not exceed 1,5 mg dissolved oxygen/litre after 28 days. Values higher than this require investigation of the experimental techniques. The residual concentration of oxygen in the test bottles should not fall below 0,5 mg/litre at any time. Such low oxygen levels are valid only if the method of determining dissolved oxygen used is capable of measuring such levels accurately.

See also I.5.2.

VI.3.3. **Reporting**

See I.8.

VI.4. **DATA SHEET**

An example of a data sheet is given hereafter.

CLOSED BOTTLE TEST

1. **LABORATORY**

2. **DATE AT START OF TEST**

3. **TEST SUBSTANCE**

Name:

Stock solution concentration: ... mg/litre

Initial concentration in bottle: ... mg/litre

ThOD or COD: ... mg O₂/mg test substance

4. **INOCULUM**

Source:

Treatment given:

▼ B

Pre-conditioning if any:

Concentration in the reaction mixture: ... mg/litre

5. DO DETERMINATION

Method: Winkler/electrode

Flask analyses

Time of incubation (d)			DO (mg/l)			
			0	n ₁	n ₂	
Blank (without chemical)	1	C ₁				
	2	C ₂				
Mean	$m_b = \frac{C_1 + C_2}{2}$					
Test chemical	1	a ₁				
	2	a ₂				
Mean	$m_t = \frac{a_1 + a_2}{2}$					

Note: Similar format may be used for reference and toxicity control.**6. CORRECTION FOR NITRIFICATION** (see Annex V)

Time of incubation (d)		0	n ₁	n ₂	n ₃
(i)	Concentration of nitrate (mg N/litre)				
(ii)	Change in nitrate concentration (mg N/litre)	—			
(iii)	Oxygen equivalent (mg/litre)	—			
(iv)	Concentration of nitrite (mg N/litre)				
(v)	Change in nitrite concentration (mg N/litre)	—			
(vi)	Oxygen equivalent (mg/litre)	—			
(iii + vi)	Total oxygen equivalent (mg/litre)	—			

7. DO DEPLETION: % DEGRADATION

	Depletion after n days (mg/litre)			
	n ₁	n ₂	n ₃	
FLASK 1: (m _{to} - m _{tx}) - (m _{bo} - m _{bx})				
FLASK 2: (m _{to} - m _{tx}) - (m _{bo} - m _{bx})				

▼ B

	Depletion after n days (mg/litre)			
	n ₁	n ₂	n ₃	
FLASK 1: $\%D_1 = \frac{[(m_{t_0} - m_{t_x}) - (m_{b_0} - m_{b_x})] \times 100}{\text{conc. of test} \times \text{ThOD chemical}}$				
FLASK 2: $\%D_2 = \frac{[(m_{t_0} - m_{t_x}) - (m_{b_0} - m_{b_x})] \times 100}{\text{conc. of test} \times \text{ThOD chemical}}$				
$\% D \text{ mean } (*) = \frac{D_1 - D_2}{2}$				

(*) Do not take mean if there is considerable difference between duplicates.

m_{t_0} = value in the flask at time 0

m_{t_x} = value in the flask at time x

m_{b_0} = mean blank value at time 0

m_{b_x} = mean blank value at time x

Apply also correction for nitrification from iii + vi in section 6.

8. BLANK DO DEPLETIONS

Oxygen consumption by blank: ($m_{b_0} - m_{b_{28}}$) mg/litre. This consumption is important for the validity of the test. It should be less than 1,5 mg/litre.

PART VII. M.I.T.I. TEST (Method C.4-F)

VII.1. PRINCIPLE OF THE METHOD

The oxygen uptake by a stirred solution, or suspension, of the test chemical in a mineral medium, inoculated with specially grown, unadapted micro-organisms, is measured automatically over a period of 28 days in a darkened, enclosed respirometer at 25 ± 1 °C. Evolved carbon dioxide is absorbed by soda lime. Biodegradability is expressed as the percentage oxygen uptake (corrected for blank uptake) of the theoretical uptake (ThOD). The percentage of primary biodegradability is also calculated from supplemental specific chemical analysis made at the beginning and end of incubation and, optionally, by DOC analysis.

VII.2. DESCRIPTION OF THE METHOD

VII.2.1. Apparatus

- (a) Automatic electrolytic BOD meter or respirometer normally equipped with six bottles, 300 ml each and equipped with cups to contain CO₂ absorbent;

▼ B

- (b) constant temperature room and/or water-bath at $25\text{ }^{\circ}\text{C} \pm 1\text{ }^{\circ}\text{C}$ or better;
- (c) membrane-filtration assembly (optional);
- (d) carbon analyser (optional).

VII.2.2. Preparation of mineral medium

Prepare the following stock solutions, using analytical grade reagents and water (I.6.1.):

- | | |
|--|---------|
| (a) Monopotassium dihydrogen ortho phosphate,
KH_2PO_4 | 8,50 g |
| Dipotassium monohydrogen ortho phosphate,
K_2HPO_4 | 21,75 g |
| Disodium monohydrogen ortho phosphate
dodecahydrate $\text{Na}_2\text{HPO}_4 \cdot 12\text{ H}_2\text{O}$ | 44,60 g |
| Ammonium chloride, NH_4Cl | 1,70 g |
| Dissolve in water and make up to 1 litre | |
| The pH value of the solution should be 7,2 | |
| (b) Magnesium sulphate heptahydrate, $\text{MgSO}_4 \cdot 7\text{ H}_2\text{O}$ | 22,50 g |
| Dissolve in water and make up to 1 litre | |
| (c) Calcium chloride anhydrous, CaCl_2 | 27,50 g |
| Dissolve in water and make up to 1 litre | |
| (d) Iron (III) chloride hexahydrate, $\text{FeCl}_3 \cdot 6\text{ H}_2\text{O}$ | 0,25 g |
| Dissolve in water and make up to 1 litre | |

Take 3 ml of each solution (a), (b), (c) and (d) and make up to 1 litre.

VII.2.3. Preparation of inoculum

Collect fresh samples from no fewer than ten sites, mainly in areas where a variety of chemicals are used and discharged. From sites such as sewage treatment works, industrial waste-water treatment, rivers, lakes, seas, collect 11 samples of sludge, surface soil, water, etc. and mix thoroughly together. After removing floating matter and allowing to stand, adjust the supernatant to $\text{pH } 7 \pm 1$ with sodium hydroxide or phosphoric acid.

Use an appropriate volume of the filtered supernatant to fill a fill-and-draw activated sludge vessel and aerate the liquid for about 23 1/2 h. 30 minutes after stopping aeration, discard about one third of the whole volume of supernatant and add an equal volume of a solution (pH 7) containing 0,1 % each of glucose, peptone and monopotassium ortho phosphate, to the settled material and recommence aeration. Repeat this procedure once per day. The sludge unit must be operated according to good practice: effluents should be clear, temperature should be kept at $25 \pm 2^{\circ}\text{C}$, pH should be 7 ± 1 , sludge should settle well, sufficient aeration to keep the mixture aerobic at all times, protozoa should be present and the activity of the sludge should be tested against a reference substance at least every three months. Do not use sludge as inoculum until after at least one month's operation, but not after more than four months. Thereafter, sample from at least 10 sites at irregular intervals, once every three months.

▼B

In order to maintain fresh and old sludge at the same activity, mix the filtered supernatant of an activated sludge in use with an equal volume of the filtered supernatant of a freshly collected ten-source mixture and culture the combined liquor as above. Take sludge for use as inoculum 18-24 h after the unit has been fed.

VII.2.4. **Preparation of flasks**

Prepare the following six flasks:

No 1: test chemical in dilution water at 100 mg/l

No 2, 3 and 4: test chemical in mineral medium at 100 mg/l

No 5: reference chemical (e.g. aniline) in mineral medium at 100 mg/l

No 6: mineral medium only

Add poorly soluble test chemicals directly on a weight or volume basis or handle as described in Appendix 3, except that neither solvents nor emulsifying agents should be used. Add the CO₂ absorbent to all flasks in the special cups provided. Adjust the pH in flasks No 2, 3 and 4 to 7,0.

VII.2.5. **Performance of the test**

Inoculate flasks No 2, 3 and 4 (test suspensions), No 5 (activity control) and No 6 (inoculum blank) with a small volume of the inoculum to give a concentration of 30 mg/l suspended solids. No inoculum is added to flask No 1 which serves as an abiotic control. Assemble the equipment, check for air-tightness, start the stirrers, and start the measurement of oxygen uptake under conditions of darkness. Daily check the temperature, stirrer and coulometric oxygen uptake recorder, and note any changes in colour of the contents of the flasks. Read the oxygen uptakes for the six flasks directly by an appropriate method, for example, from the six-point chart recorder, which produces a BOD curve. At the end of incubation, normally 28 days, measure the pH of the contents of the flasks and determine the concentration of the residual test chemical and any intermediate and, in the case of water soluble substance, the concentration of DOC (Appendix 2.4). Take special care in the case of volatile chemicals. If nitrification is anticipated, determine nitrate and nitrite concentration, if possible.

VII.3. DATA AND REPORTING

VII.3.1. **Treatment of results**

Divide the oxygen uptake (mg) by the test chemical after a given time, corrected for that taken up by the blank inoculum control after the same time, by the weight of the test chemical used. This yields the BOD expressed as mg oxygen/mg test chemical, that is:

$$\text{BOD} = \frac{(\text{mg O}_2 \text{ uptake by test chemical} - \text{mg O}_2 \text{ uptake by blank})}{(\text{mg test chemical in flask})}$$

= mg O₂ per mg test chemical

▼ B

The percentage biodegradation is then obtained from:

$$\% \text{ biodegradation} = \% \text{ ThOD} = \frac{\text{BOD (mg O}_2\text{/mg chemical)}}{\text{ThOD (mg O}_2\text{/mg chemical)}} \times 100$$

For mixtures, calculate the ThOD from the elemental analysis, as for simple compound. Use the appropriate ThOD (ThOD_{NH4} or ThOD_{NO3}) according to whether nitrification is absent or complete (Appendix 2.2). If however, nitrification occurs but is incomplete, make a correction for the oxygen consumed by nitrification calculated from the changes in concentrations of nitrite and nitrate (Appendix 5).

Calculate the percentage primary biodegradation from loss of specific (parent) chemical (see 1.7.2).

$$D_t = \frac{S_b - S_a}{S_b} \times 100 \%$$

If there has been a loss of test chemical in the flask No 1 measuring physico-chemical removal, report this and use the concentration of test chemical (S_b) after 28 days in this flask to calculate the percentage biodegradation.

When determinations of DOC are made (optional), calculate the percentage ultimate biodegradation from:

$$D_t = \left(1 - \frac{C_t - C_{bt}}{C_o - C_{bo}} \right) \times 100 \%$$

as described under point I.7.1. If there has been a loss of DOC in the flask No 1, measuring physico-chemical removal, use the DOC concentration in this flask to calculate the percentage biodegradation.

Record all results on the data sheets attached.

VII.3.2. **Validity of results**

The oxygen uptake of the inoculum blank is normally 20-30 mg O₂/l and should not be greater than 60 mg/l in 28 days. Values higher than 60 mg/l require critical examination of the data and experimental techniques. If the pH value is outside the range 6-8,5 and the oxygen consumption by the test chemical is less than 60 %, the test should be repeated with a lower concentration of test chemical.

See also I.5.2.

If the percentage degradation of aniline calculated from the oxygen consumption does not exceed 40 % after seven days and 65 % after 14 days, the test is regarded as invalid.

VII.3.3. **Reporting**

See I.8.

VII.4. **DATA SHEET**

An example of a data sheet is given below.

MITI (I) TEST

1. **LABORATORY**

2. **DATE AT START OF TEST**

▼ B**3. TEST SUBSTANCE**

Name:

Stock solution concentration: mg/l as chemical

Initial concentration in medium, C_0 : ... mg/l as chemicalVolume of reaction mixture, V : ... mlThOD: ... mg O_2 /l**4. INOCULUM**

Sludge sampling sites:

- | | |
|---------|---------|
| (1) ... | (6) ... |
| (2) ... | (7) ... |
| (3) ... | (8) ... |
| (4) ... | (9) ... |
| (5) ... | (10)... |

Concentration of suspended solids in activated sludge after acclimatisation with synthetic sewage = ... mg/l

Volume of activated sludge per litre of final medium = ... ml

Concentration of sludge in final medium = ... mg/l

5. OXYGEN UPTAKE: BIODEGRADABILITY

Type of respirometer used:

		Time (Days)				
		0	7	14	21	28
O ₂ upt. (mg) test chemical	a ₁					
	a ₂					
	a ₃					
O ₂ upt. (mg) blank	b					
Corrected BOD (mg)	(a ₁ - b ₁) (a ₁ - b ₁) (a ₁ - b ₁)					
BOD per mg test chemical	$\frac{(a - b)}{C_0 V}$	Flask 1				
		Flask 2				
		Flask 3				
% degradation $\frac{BOD}{ThOD} \times 100$		1				
		2				
		3				
		Mean (*)				

(*) Do not take a mean if there are considerable differences between replicates.

▼B

N.B.: Similar formats may be used for the reference compound.

6. CARBON ANALYSIS (optional)

Carbon analyser:

Flask	DOC			% DOC removed	Mean
	Measured	Corrected			
Water + test substance	a			—	—
Sludge + test substance	b ₁		b ₁ - c		
Sludge + test substance	b ₂		b ₂ - c		
Sludge + test substance	b ₃		b ₃ - c		
Control blank	c		—	—	—

$$\% \text{ DOC removed} : \frac{a_1 - (b - c)}{a} \times 100$$

7. SPECIFIC CHEMICAL ANALYTICAL DATA

	Residual amount of test chemical at end of test	% degradation
blank test with water	S _b	
inoculated medium	S _{a1}	
	S _{a2}	
	S _{a3}	

$$\% \text{ degradation} = \frac{S_b - S_a}{S_b} \times 100$$

Calculate % degradation for flasks a₁, and a₃ respectively

8. REMARKS

BOD curve against time, if available, should be attached.

▼B*Appendix 1***ABBREVIATIONS AND DEFINITIONS**

- DO: Dissolved oxygen (mg/l) is the concentration of oxygen dissolved in an aqueous sample.
- BOD: Biochemical oxygen demand (g) is the amount of oxygen consumed by micro-organisms when metabolising a test compound; also expressed as g oxygen uptake per g test compound. (See method C.5).
- COD: Chemical oxygen demand (g) is the amount of oxygen consumed during oxidation of a test compound with hot, acidic dichromate; it provides a measure of the amount of oxidisable matter present; also expressed as g oxygen consumed per g test compound. (See method C.6).
- DOC: Dissolved organic carbon is the organic carbon present in solution or that which passes through a 0,45 micrometre filter or remains in the supernatant after centrifuging at 40 000 m.s⁻² (\pm 4 000 g) for 15 min.
- ThOD: Theoretical oxygen demand (mg) is the total amount of oxygen required to oxidise a chemical completely; it is calculated from the molecular formula (see Appendix 2.2) and is also expressed as mg oxygen required per mg test compound.
- ThCO₂: Theoretical carbon dioxide (mg) is the quantity of carbon dioxide calculated to be produced from the known or measured carbon content of the test compound when fully mineralised; also expressed as mg carbon dioxide evolved per mg test compound.
- TOC: Total organic carbon of a sample is the sum of the organic carbon in solution and in suspension.
- IC: Inorganic carbon
- TC: Total carbon, is the sum of the organic and inorganic carbon present in a sample.

Primary biodegradation:

is the alteration in the chemical structure of a substance, brought about by biological action, resulting in the loss of specific property of that substance.

Ultimate biodegradation (aerobic):

is the level of degradation achieved when the test compound is totally utilised by micro-organisms resulting in the production of carbon dioxide, water, mineral salts and new microbial cellular constituents (biomass).

Readily biodegradable:

an arbitrary classification of chemicals which have passed certain specified screening tests for ultimate biodegradability; these tests are so stringent that it is assumed that such compounds will rapidly and completely biodegrade in aquatic environments under aerobic conditions.

▼ B*Inherently biodegradable:*

a classification of chemicals for which there is unequivocal evidence of biodegradation (primary or ultimate) in any recognized test of biodegradability.

Treatability:

is the amenability of compounds to removal during biological wastewater treatment without adversely affecting the normal operation of the treatment processes. Generally, readily biodegradable compounds are treatable but not all inherently biodegradable compounds are. Abiotic processes may also operate.

Lag time

is the time from inoculation, in a die-away test, until the degradation percentage has increased to at least 10 %. The lag time is often highly variable and poorly reproducible.

Degradation time

is the time from the end of the lag time till the time that 90 % of maximum level of degradation has been reached.

10-day window

is the 10 days immediately following the attainment of 10 % degradation.

▼ B*Appendix 2***CALCULATION AND DETERMINATION OF SUITABLE SUMMARY PARAMETERS**

Depending on the method chosen, certain summary parameters will be required. The following section describes the derivation of these values. The use of these parameters is described in the individual methods.

1. Carbon content

The carbon content is calculated from the known elemental composition or determined by elemental analysis of the test substance.

2. Theoretical oxygen demand (ThOD)

The theoretical oxygen demand (ThOD) may be calculated if the elemental composition is known or determined by elemental analysis. It is for the compound:



without nitrification,

$$\text{ThOD}_{\text{NH}_4} = \frac{16 [2c + 1/2 (h - cl - 3n) + 3s + 5/2p + 1/2na - o]}{\text{MW}} \text{ mg/mg}$$

or with nitrification

$$\text{ThOD}_{\text{NO}_3} = \frac{16 [2c + 1/2 (h - cl) + 5/2n + 3s + 5/2p + 1/2na - o]}{\text{MW}} \text{ mg/mg}$$

3. Chemical Oxygen Demand (COD)

The chemical oxygen demand (COD) is determined according to method C.6.

4. Dissolved organic carbon (DOC)

Dissolved organic carbon (DOC) is by definition the organic carbon of any chemical or mixture in water passing through a 0,45 micrometre filter.

Samples from the test vessels are withdrawn and filtered immediately in the filtration apparatus using an appropriate membrane filter. The first 20 ml (amount can be reduced when using small filters) of the filtrate are discarded. Volumes of 10-20 ml or lower, if injected (volume depending on the amount required for carbon analyser) are retained for carbon analysis. The DOC concentration is determined by means of an organic carbon analyser which is capable of accurately measuring a carbon concentration equivalent or lower than 10 % of the initial DOC concentration used in the test.

Filtered samples which cannot be analysed on the same working day can be preserved by storage in a refrigerator at 2-4 °C for 48 h, or below - 18 °C for longer periods.

Remarks:

Membrane filters are often impregnated with surfactants for hydrophilisation. Thus the filter may contain up to several mg of soluble organic carbon which would interfere in the biodegradability determinations. Surfactants and other soluble organic compounds are removed from the filters by boiling them in deionised water for three periods each of one hour. The filters may then be stored in water for one week. If disposable filter cartridges are used each lot must be checked to confirm that it does not release soluble organic carbon.

▼B

Depending on the type of membrane filter the test chemical may be retained by adsorption. It may therefore be advisable to ensure that the test chemical is not retained by the filter.

Centrifugation at $40\,000\text{ m}\cdot\text{sec}^{-2}$ (4 000 g) for 15 min may be used for differentiation of TOC versus DOC instead of filtration. The method is not reliable at initial concentration of $< 10\text{ mg DOC/l}$ since either not all bacteria are removed or carbon as part of the bacterial plasma is redissolved.

BIBLIOGRAPHY

- Standard Methods for the Examination of Water and Wastewater, 12th ed, Am. Pub. Hlth. Ass., Am. Wat. Poll. Control Fed., Oxygen Demand, 1965, P 65.
- Wagner, R., Von Wasser, 1976, vol. 46, 139.
- DIN-Entwurf 38 409 Teil 41 Deutsche Einheitsverfahren zur Wasser-, Abwasser- und Schlammuntersuchung, Summarische Wirkungs- und Stoffkenngrößen (Gruppe H). Bestimmung des Chemischen Sauerstoffbedarfs (CSB) (H 41), Normenausschuß Wasserwesen (NAW) in DIN Deutsches Institut für Normung e. V.
- Gerike, P., The biodegradability testing of poorly water soluble compounds. Chemosphere, 1984, vol 13 (1), 169.

▼B*Appendix 3***EVALUATION OF THE BIODEGRADABILITY OF POORLY SOLUBLE SUBSTANCES**

In biodegradability tests with poorly soluble substances the following aspects should receive special attention.

While homogeneous liquids will seldom present sampling problems, it is recommended that solid materials be homogenised by appropriate means to avoid errors due to non-homogeneity. Special care must be taken when representative samples of a few milligrams are required from mixtures of chemicals or substances with large amounts of impurities.

Various forms of agitation during the tests may be used. Care should be taken to use only sufficient agitation to keep the chemical dispersed, and to avoid overheating, excessive foaming and excessive shear forces.

An emulsifier which gives a stable dispersion of the chemical may be used. It should not be toxic to bacteria and must not be biodegraded or cause foaming under test conditions.

The same criteria apply to solvents as to the emulsifiers.

It is not recommended that solid carriers be used for solid test substances but they may be suitable for only substances.

When auxiliary substances such as emulsifiers, solvents and carriers are used, a blank run containing the auxiliary substance should be performed.

Any of the three respirometric tests CO₂, BOD, MITI can be used to study the biodegradability of poorly soluble compounds.

BIBLIOGRAPHY

- de Morsier, A. et al., Biodegradation tests for poorly soluble compounds. Chemosphere, 1987, vol. 16, 833.
- Gerike, P., The Biodegradability testing of poorly water soluble compounds. Chemosphere, 1984, vol. 13, 169.

▼B*Appendix 4***EVALUATION OF THE BIODEGRADABILITY OF CHEMICALS
SUSPECTED TO BE TOXIC TO THE INOCULUM**

When a chemical is subjected to ready biodegradability testing and appears to be non-biodegradable, the following procedure is recommended if a distinction between inhibition and inertness is desired (Reynolds et al., 1987).

Similar or identical inocula should be used for the toxicity and biodegradation tests.

To assess the toxicity of chemicals studied in ready biodegradability tests, the application of one or a combination of the inhibition of Sludge Respiration rate (activated sludge respiration inhibition test — Directive 87/302/EEC), BOD and/or Growth Inhibition methods would seem appropriate.

If inhibition due to toxicity is to be avoided, it is suggested that the test substance concentrations used in ready biodegradability testing should be less than 1/10 of the EC₅₀ values (or less than EC₂₀ values) obtained in toxicity testing. Compounds with an EC₅₀ value of greater than 300 mg/l are not likely to have toxic effects in ready biodegradability testing.

EC₅₀ values of less than 20 mg/l are likely to pose serious problems for the subsequent testing. Low test concentrations should be employed, necessitating the use of the stringent and sensitive Closed Bottle test or the use of ¹⁴C-labelled material. Alternatively, an acclimatised inoculum may permit higher test substance concentrations to be used. In the latter case, however, the specific criterion of the ready biodegradability test is lost.

BIBLIOGRAPHY

Reynolds, L. et al., Evaluation of the toxicity of substances to be assessed for biodegradability. Chemosphere, 1987, vol. 16, 2259.

▼B*Appendix 5***CORRECTION FOR OXYGEN UPTAKE FOR INTERFERENCE BY NITRIFICATION**

Errors due to not considering nitrification in the assessment by oxygen uptake of the biodegradability of test substances not containing N are marginal (not greater than 5 %), even if oxidation of the ammonium-N in the medium occurs erratically as between test and blank vessels. However, for test substances containing N, serious errors can arise.

If nitrification has occurred but is not complete the observed oxygen uptake by the reaction mixture may be corrected for the amount of oxygen used in oxidising ammonium to nitrite and nitrate, if the changes in concentration during incubation of nitrite and nitrate are determined by consideration of the following equations:

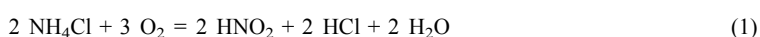

Overall:

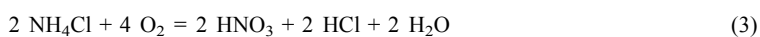

From equation (1), the oxygen uptake by 28 g of nitrogen contained in ammonium chloride (NH₄Cl) in being oxidised to nitrite is 96 g, i.e. a factor of 3,43 (96/28). In the same way, from equation (3) the oxygen uptake by 28 g of nitrogen in being oxidised to nitrate is 128 g, i.e. a factor of 4,57 (128/28).

Since the reactions are sequential, being carried out by distinct and different bacterial species, it is possible for the concentration of nitrite to increase or decrease; in the latter case an equivalent concentration of nitrate would be formed. Thus, the oxygen consumed in the formation of nitrate is 4,57 multiplied by the increase in concentration of nitrate, whereas the oxygen associated with the formation of nitrite is 3,43 multiplied by the increase in the concentration of nitrite or with the decrease in its concentration the oxygen loss is - 3,43 multiplied by the decrease in concentration.

That is:

$$\text{O}_2 \text{ consumed in nitrate formation} = 4,57 \times \text{increase in nitrate concentration} \quad (4)$$

and

$$\text{O}_2 \text{ consumed in nitrite formation} = 3,43 \times \text{increase in nitrite concentration} \quad (5)$$

and

$$\text{O}_2 \text{ lost in nitrite disappearance} = - 3,43 \times \text{decrease in nitrite concentration} \quad (6)$$

So that

$$\text{O}_2 \text{ uptake due to nitrification} = \pm 3,43 \times \text{change in nitrite conc.} + 4,57 \times \text{increase in nitrate conc.} \quad (7)$$

and thus

$$\text{O}_2 \text{ uptake due to C oxidation} = \text{total observed uptake} - \text{O}_2 \text{ uptake due to nitrification} \quad (8)$$

Alternatively, if only total oxidised N is determined, the oxygen uptake due to nitrification may be taken to be, as a first approximation, 4,57 × increase in oxidised N

The corrected value for oxygen consumption due to C oxidation is then compared with ThOD NH₃, as calculated in Appendix 2.

▼B**C.5 DEGRADATION — BIOCHEMICAL OXYGEN DEMAND****1. METHOD****1.1. INTRODUCTION**

The purpose of the method is the measurement of the biochemical oxygen demand (BOD) of solid or liquid organic substances.

Data elaborated with this test pertain to water-soluble compounds; however, volatile compounds and those of low water solubility may also, at least in principle, be tested.

The method is applicable only to those organic test materials which are not inhibitory to bacteria at the concentration used in the test. If the test material is not soluble at the test concentration, special measures, such as the use of ultrasonic dispersion, may have to be employed to achieve good dispersion of test material.

Information on the toxicity of the chemical may be useful to the interpretation of low results and in the selection of appropriate test concentrations.

1.2. DEFINITION AND UNITS

The BOD is defined as the mass of dissolved oxygen required by a specified volume of solution of the substance for the process of biochemical oxidation under prescribed conditions.

The results are expressed as grams of BOD per gram of tested substance.

1.3. REFERENCE SUBSTANCES

The use of a suitable reference substance to check the activity of the inoculum is desirable.

1.4. PRINCIPLE OF THE TEST METHOD

A predetermined amount of the substance, dissolved or dispersed in a well-aerated suitable medium, is inoculated with micro-organisms and incubated at a constant defined ambient temperature in the dark.

The BOD is determined by the difference in dissolved oxygen content at the beginning and at the end of the test. The duration of the test must be at least five days and not more than 28 days.

A blank must be determined in a parallel assay containing no test substance.

1.5. QUALITY CRITERIA

The BOD determination cannot be considered as a valid determination of the biodegradability of a substance. This test may only be regarded as a screening test.

1.6. DESCRIPTION OF THE TEST METHOD

A preliminary solution or dispersion of the substance is prepared to obtain a BOD concentration compatible with the method used. The BOD is then determined following any suitable national or international standardised method.

▼B**2. DATA AND EVALUATION**

The BOD contained in the preliminary solution is calculated according to the selected normalised method, and converted into grams of BOD per gram of tested substance.

3. REPORTING

The method used shall be stated.

The biochemical oxygen demand should be a mean of at least three valid measurements.

All information and remarks relevant for the interpretation of results have to be reported, especially with regard to impurities, physical state, toxic effects and inherent composition of the substance which would affect the results.

The use of an additive to inhibit biological nitrification must be reported.

4. REFERENCES

List of standardised methods, for example:

NF T 90-103: Determination of the biochemical oxygen demand.

NBN 407: Biochemical oxygen demand.

NEN 32355.4: Bepaling van het biochemisch zuurstofverbruik (BZV).

The determination of biochemical oxygen demand, Methods for the examination of water and associated materials, HMSO, London.

ISO 5815: Determination of biochemical oxygen demand after n days.

▼B**C.6. DEGRADATION — CHEMICAL OXYGEN DEMAND****1. METHOD****1.1. INTRODUCTION**

The purpose of the method is the measurement of the chemical oxygen demand (COD) of solid or liquid organic substances in a standard, arbitrary manner, under fixed laboratory conditions.

Information on the formula of the substance will be useful to conduct this test and interpret the result obtained (e.g. halogen salts, ferrous salts of organic compounds, organochlorine compounds).

1.2. DEFINITIONS AND UNITS

The chemical oxygen demand is a measure of the oxidisability of a substance, expressed as the equivalent amount in oxygen of an oxidising reagent consumed by the substance under fixed laboratory conditions.

The result is expressed in grams of COD per gram of tested substance.

1.3. REFERENCE SUBSTANCES

Reference substances do not need to be employed in all cases when investigating a new substance. They should serve primarily to calibrate the method from time to time and to allow comparison of results when another method is applied.

1.4. PRINCIPLE OF THE TEST METHOD

A predetermined amount of the substance, dissolved or dispersed in water, is oxidised by potassium dichromate in a strong sulphuric acid medium with silver sulphate as a catalyst, under reflux for two hours. The residual dichromate is determined by titration with standardised ferrous ammonium sulphate.

In case of chlorine-containing substances, mercuric sulphate⁽¹⁾ is added to reduce chloride interference.

1.5. QUALITY CRITERIA

Because of the arbitrary manner of determination, COD is an 'oxidisability indicator' and as such is used as a practical method to measure organic matter.

Chloride can interfere in this test; inorganic reducing or oxidising agents may also interfere with the COD determination.

Some cyclic compounds and many volatile substances (e.g. lower fatty acids) are not fully oxidised by this test.

1.6. DESCRIPTION OF THE TEST METHOD

A preliminary solution or dispersion of the substance is prepared to obtain a COD between 250 and 600 mg per litre.

⁽¹⁾ After use, solutions containing mercury salts should be treated to avoid dissemination of mercury in the environment.

▼ B*Remarks:*

In the case of poorly soluble and non-dispersible substances, an amount of finely powdered substance or liquid substance corresponding to about 5 mg of COD can be weighed and put in the experimental apparatus with water.

The chemical oxygen demand (COD) is often and especially in case of poorly soluble substances determined advantageously in a variant of the method, i.e., in a closed system with a pressure equaliser (H. Kelkenberg, 1975). In this modification compounds which are only with difficulty determined by the conventional method — e.g. acetic acid — may often be successfully quantified. The method also fails, however, in the case of pyridine. If the potassium dichromate concentration, as prescribed in ref.(1), is raised to 0,25 N (0,0416 M), the direct weighing-in of 5-10 mg of substance is facilitated which is essential for the COD determination of poorly water soluble substances (ref. (2)).

Otherwise, the COD is then determined following any suitable national or international standardised method.

2. **DATA AND EVALUATION**

The COD contained in the experimental flask is calculated following the selected normalised method, and converted to grams of COD per gram of tested substance.

3. **REPORTING**

The reference method used should be stated.

The chemical oxygen demand should be a mean of at least three measurements. All information and remarks relevant to the interpretation of the results have to be reported, especially with regard to impurities, physical state and inherent properties of the substance (if known) which would affect the results.

The use of mercuric sulphate to minimise the chloride interference must be reported.

4. **REFERENCES**

- (1) Kelkenberg, H.,Z. von Wasser und Abwasserforschung, 1975, vol. 8, 146.
- (2) Gerike, P. The biodegradability testing of poorly water soluble compounds. Chemosphere, 1984, vol. 13,169.

List of standardised methods, for example:

NBN T 91-201 Determination of the chemical oxygen demand.

ISBN O 11 7512494 Chemical oxygen demand (dichromate value) of polluted and waste waters.

NF T 90-101 Determination of the chemical oxygen demand.

DS 217 = water analysis Determination of the chemical oxygen demand.

DIN 38409-H-41 Determination of the chemical oxygen demand (COD) within the range above 15 mg per litre.

NEN 3235 5.3 Bepaling van het chemisch zuurstofverbruik.

ISO 6060 Water quality: chemical oxygen demand dichromate methods.

▼ B**C.7. DEGRADATION — ABIOTIC DEGRADATION: HYDROLYSIS
AS A FUNCTION OF PH****1. METHOD**

This testing method is equivalent to the OECD TG 111 (2004).

1.1. INTRODUCTION

Chemicals can enter surface waters by such routes as direct application, spray drift, run-off, drainage, waste disposal, industrial, domestic or agricultural effluent and atmospheric deposition and may be transformed in those waters by chemical (e.g. hydrolysis, oxidation), photochemical and/or microbial processes. This Guideline describes a laboratory test method to assess abiotic hydrolytic transformations of chemicals in aquatic systems at pH values normally found in the environment (pH 4-9) and is based on existing Guidelines (1)(2)(3)(4)(5)(6)(7).

The experiments are performed to determine (i) the rate of hydrolysis of the test substance as a function of pH and (ii) the identity or nature and rates of formation and decline of hydrolysis products to which organisms may be exposed. Such studies may be required for chemicals which are directly applied to water or that are likely to reach the environment by the other routes described above.

1.2. DEFINITIONS AND UNITS

See Appendix 2

1.3. APPLICABILITY OF THE METHOD

The method is generally applicable to chemical substances (unlabelled or labelled) for which an analytical method with sufficient accuracy and sensitivity is available. It is applicable to slightly volatile and non-volatile compounds of sufficient solubility in water. The test should not be applied to chemicals that are highly volatile from water (e.g. fumigants, organic solvents) and thus cannot be kept in solution under the experimental conditions of this test. The test may be difficult to conduct with substances of minimal solubility in water (8).

1.4. PRINCIPLE OF THE TEST METHOD

Sterile aqueous buffer solutions of different pH values (pH 4, 7 and 9) are treated with the test substance and incubated in the dark under controlled laboratory conditions (at constant temperatures). After appropriate time intervals, buffer solutions are analysed for the test substance and for hydrolysis products. With labelled test substance (e.g. ^{14}C), a mass balance can be more easily established.

This testing method is designed as a tiered approach which is shown and explained in Appendix 1. Each tier is triggered by the results of the previous tier.

▼ B

1.5. INFORMATION ON THE TEST SUBSTANCE

Non-labelled or labelled test substance can be used to measure the rate of hydrolysis. Labelled material is generally preferred for studying the pathway of hydrolysis and for establishing mass balance; however, in special cases, labelling may not be absolutely necessary. ^{14}C -labelling is recommended but the use of other isotopes, such as ^{13}C , ^{15}N , ^3H , may also be useful. As far as possible, the label should be positioned in the most stable part(s) of the molecule. For example, if the test substance contains one ring, labelling on this ring is required; if the test substance contains two or more rings, separate studies may be needed to evaluate the fate of each labelled ring and to obtain suitable information on formation of hydrolysis products. The purity of the test substance should be at least 95 %.

Before carrying out a hydrolysis test, the following information on the test substance should be available:

- (a) solubility in water [Testing Method A.6];
- (b) solubility in organic solvents;
- (c) vapour pressure [Testing Method A.4] and/or Henry's Law constant;
- (d) n-octanol/water partition coefficient [Testing Method A.8];
- (e) dissociation constant (pK_a) [OECD Guideline 112] (9);
- (f) direct and indirect phototransformation rate in water where appropriate.

Analytical methods for quantification of the test substance and, if it is relevant, for identification and quantification of hydrolysis products in aqueous solutions should be available (see also Section 1.7.2).

1.6. REFERENCE SUBSTANCES

Where possible, reference substances should be used for the identification and quantification of hydrolysis products by spectroscopic and chromatographic methods or other suitably sensitive methods.

1.7. QUALITY CRITERIA

1.7.1. Recovery

Analysis of, at least, duplicate buffer solutions or of their extracts immediately after the addition of the test substance gives a first indication of the repeatability of the analytical method and of the uniformity of the application procedure for the test substance. Recoveries for later stages of the experiments are given by the respective mass balances (when labelled material is used). Recoveries should range from 90 % to 110 % for labelled and non labelled chemicals (7). In case it is technically difficult to reach this range, a recovery of 70 % for non labelled chemicals is acceptable, but justification should be given.

▼B**1.7.2. Repeatability and sensitivity of analytical method**

Repeatability of the analytical method(s) used to quantify the test substance and hydrolysis products at later times can be checked by duplicate analysis of the same buffer solutions (or of their extracts) after sufficient quantities of hydrolysis products have formed for quantification

The analytical method should be sufficiently sensitive to quantify test substance concentrations down to 10 % or less of the initial concentration. If relevant, analytical methods should also be sufficiently sensitive to quantify any hydrolysis product representing 10 % or more of applied (at any time during the study) down to 25 % or less of its peak concentration.

1.7.3. Confidence intervals for hydrolysis kinetic data

Confidence intervals should be computed and presented for all regression coefficients, rate constants, half-lives, and any other kinetic parameters (e.g. DT50).

1.8. DESCRIPTION OF THE TEST METHOD**1.8.1. Equipment and apparatus**

The study should be performed in glass containers (e.g. test tubes, small flasks) under dark and sterile conditions, if necessary, unless preliminary information (such as the n-octanol-water partition coefficient) indicates that the test substance may adhere to glass. In such cases, alternative materials (such as Teflon) may have to be considered. It may also be possible to alleviate the problem of adhere to glass by using one or more of the following methods:

- determine the mass of test substance and hydrolysis products sorbed to the test vessel,
- use of an ultrasonic bath,
- ensure a solvent wash of all glassware at each sampling interval,
- use of formulated products,
- use an increased amount of co-solvent for addition of test substance to the system; if a co-solvent is used it should be a co-solvent that does not hydrolyse the test substance.

Temperature-controlled water bath shakers or thermostatically controlled incubators for incubation of the various test solutions are normally required.

Standard laboratory equipment is required, including, in particular, the following:

- pH meter,

▼B

- analytical instruments such as GC, HPLC, TLC equipment, including the appropriate detection systems for analysing radio-labelled and non-labelled substances or inverse isotopes dilution method,
- instruments for identification purposes (e.g. MS, GC-MS, HPLC-MS, NMR, etc.),
- liquid scintillation counter,
- separating funnels for liquid-liquid extraction,
- instrumentation for concentrating solutions and extracts (e.g. rotating evaporator),
- temperature control devise (e.g. water bath).

Chemical reagents include, for example:

- organic solvents, analytical grade, such as hexane, dichloromethane, etc.,
- scintillation liquid,
- buffer solutions (for details see Section 1.8.3).

All glassware, reagent-grade water and buffer solutions used in the hydrolysis tests should be sterilised.

1.8.2. **Test substance application**

The test substance should be applied as aqueous solution into the different buffer solutions (see Appendix 3). If it is necessary for adequate dissolution, the use of low amounts of water miscible solvents (such as acetonitrile, acetone, ethanol) is permitted for application and distribution of the test substance but this should not normally exceed 1 % v/v. In case a higher concentration of solvents is considered (e.g. in the case of poorly soluble test substances), this could only be allowed when it can be shown that the solvent has no effect on the hydrolysis of the test substances.

The use of formulated product is not routinely recommended, as it cannot be excluded that the formulation ingredients may influence the hydrolysis process. However, for poorly water-soluble test substances or for substances that adhere to glass (see Section 1.8.1), the use of formulated material may be an appropriate alternative.

One concentration of the test substance should be used; it should not exceed 0,01 M or half of the saturation concentration (see Appendix 1).

▼ B**1.8.3. Buffer solutions**

The hydrolysis test should be performed at pH values of 4, 7 and 9. For this purpose, buffer solutions should be prepared using reagent grade chemicals and water. Some useful buffer systems are presented in Appendix 3. It should be noted that the buffer system used may influence the rate of hydrolysis and where this is observed an alternate buffer system should be employed ⁽¹⁾.

The pH of each buffer solution should be checked with a calibrated pH meter to a precision of at least 0,1 at the required temperature.

1.8.4. Test conditions**1.8.4.1. Test temperature**

The hydrolysis experiments should be carried out at constant temperatures. For extrapolation purposes, it is important to maintain the temperature to at least $\pm 0,5$ °C.

A preliminary test (Tier 1) should be conducted at a temperature of 50 °C if the hydrolytic behaviour of the test substance is unknown. Higher Tier kinetic tests should be carried out with a minimum of three temperatures (including the test at 50 °C) unless the test substance is stable to hydrolysis as determined by the Tier 1 testing. A suggested temperature range is 10-70 °C (preferably with at least one temperature below 25 °C utilised), which will encompass the reporting temperature of 25 °C and most of the temperatures encountered in the field.

1.8.4.2. Light and oxygen

All of the hydrolysis tests should be carried out using any suitable method to avoid photolytic effects. All suitable measures should be taken to avoid oxygen (e.g. by bubbling helium, nitrogen or argon for five minutes before preparation of the solution).

1.8.4.3. Test duration

The preliminary test should be carried out for 5 days whereas the higher Tier tests should be conducted until 90 % hydrolysis of the test substance or for 30 days whichever comes first.

1.8.5. Performance of the test**1.8.5.1. Preliminary test (Tier 1)**

The preliminary test is performed at $50 \pm 0,5$ °C and pH 4,0, 7,0 and 9,0. If less than 10 % of hydrolysis is observed after 5 days ($t_{0,525^{\circ}\text{C}} > 1$ year), the test substance is considered hydrolytically stable and, normally, no additional testing is required. If the substance is known to be unstable at environmentally relevant temperatures ⁽²⁾, the preliminary test is not required. The analytical method must be sufficiently precise and sensitive to detect a reduction of 10 % in the initial concentration.

⁽¹⁾ Mabey and Mill recommend the use of borate or acetate buffers instead of phosphate (11).

⁽²⁾ Such information may come from other sources such as hydrolysis data of structurally similar compounds from the literature or from other preliminary, semi-quantitative hydrolysis tests with the test substance at an earlier development stage.

▼B1.8.5.2. *Hydrolysis of unstable substances (Tier 2)*

The higher Tier (advanced) test should be performed at the pH values at which the test substance was found unstable as defined by the preliminary test above. The buffered solutions of the test substance should be thermostated at the selected temperatures. To test for first-order behaviour, each reaction solution should be analysed in time intervals which provide a minimum of six spaced data points normally between 10 % and 90 % hydrolysis of the test substance. Individual replicate test samples (a minimum of duplicate samples contained in separate reaction vessels) should be removed and the contents analysed at each of at least six sampling times (for a minimum of twelve replicate data points). The use of a single bulk sample from which individual aliquots of the test solution are removed at each sampling interval is considered to be inadequate, as it does not allow for the analysis of data variability and it may lead to problems with contamination of the test solution. Sterility confirmation tests should be conducted at the end of the higher Tier test (i.e. at 90 % hydrolysis or 30 days). However, if no degradation (i.e. transformation) is observed, sterility tests are not considered necessary.

1.8.5.3. *Identification of hydrolysis products (Tier 3)*

Any major hydrolysis products at least those representing > 10 % of the applied dose should be identified by appropriate analytical methods.

1.8.5.4. *Optional tests*

Additional tests at pH values other than 4, 7 and 9 may be required for a hydrolytically unstable test substance. For example, for physiological purposes a test under more acidic conditions (e.g. pH 1,2) may be required employing a single physiologically relevant temperature (37 °C).

2. DATA

The amounts of test substance and of hydrolysis products, if relevant, should be given as % of applied initial concentration and, where appropriate, as mg/L for each sampling interval and for each pH and test temperature. In addition, a mass balance should be given in percentage of the applied initial concentration when labelled test substance has been used.

A graphical presentation of the log-transformed data of the test substance concentrations against time should be reported. Any major hydrolysis products at least those representing $\geq 10\%$ of the applied dose should be identified and their log-transformed concentrations should also be plotted in the same manner as the parent substance to show their rates of formation and decline.

▼ B

2.1. TREATMENT OF RESULTS

More accurate determinations of half-lives or DT_{50} values should be obtained by applying appropriate kinetic model calculations. The half-life and/or DT_{50} values (including confidence limits) should be reported for each pH and temperature together with a description of the model used the order of kinetics and the coefficient of determination (r^2). If appropriate, the calculations should also be applied to the hydrolysis products.

In the case of rate studies carried out at different temperatures, the pseudo first-order hydrolysis rate constants (k_{obs}) should be described as a function of temperature. The calculation should be based on both the separation of k_{obs} into rate constants for acid catalysed, neutral, and base catalysed hydrolysis (k_H , $k_{neutral}$, and k_{OH} respectively) and the Arrhenius equation:

$$k_{obs} = k_H[H^+] + k_{neutral} + k_{OH}[OH^-] = \sum_{i=H,neutral,OH} A_i e^{-B_i/T}$$

where A_i and B_i are regression constants from the intercept and slope, respectively, of the best fit lines generated from linearly regressing $\ln k_i$ against the reciprocal of the absolute temperature in Kelvin (T). Through the use of the Arrhenius relationships for acid, neutral and base catalysed hydrolysis, pseudo first-order rate constants, and thus half-lives can be calculated for other temperatures for which the direct experimental determination of a rate constant is not practicable (10).

2.2. EVALUATION AND INTERPRETATION OF RESULTS

Most hydrolysis reactions follow apparent first order reaction rates and, therefore, half-lives are independent of the concentration (see equation 4 in Appendix 2). This usually permits the application of laboratory results determined at 10^{-2} to 10^{-3} M to environmental conditions ($\leq 10^{-6}$ M) (10). Several examples of good agreement between rates of hydrolysis measured in both pure and natural waters for a variety of chemicals were reported by Mabey and Mill (11), provided both pH and temperature had been measured.

3. REPORTING

3.1. TEST REPORT

The test report must include at least the following information:

Test substance:

— common name, chemical name, CAS number, structural formula (indicating position of label when radiolabelled material is used) and relevant physical-chemical properties (see Section 1.5);

— purity (impurities) of test substance,

— label purity of labelled chemical and molar activity (where appropriate).

▼ B

- Buffer solutions:
- dates and details of preparation,
- buffers and waters used,
- molarity and pH of buffer solutions.

Test conditions:

- dates of the performance of the studies,
- amount of test substance applied,
- method and solvents (type and amount) used for application of the test substance,
- volume of buffered test substance solutions incubated,
- description of the incubation system used,
- pH and temperature during the study,
- sampling times,
- method(s) of extraction,
- methods for quantification and identification of the test substance and its hydrolysis products in the buffer solutions,
- number of replicates.

Results:

- repeatability and sensitivity of the analytical methods used,
- recoveries (% values for a valid study are given in Section 1.7.1),
- replicate data and means in a tabular forms,
- mass balance during and at the end of the studies (when labelled test substance is used),
- results of preliminary test,
- discussion and interpretation of results,
- all original data and figures.

The following information is only required when hydrolysis rate is determined:

- plots of concentrations versus time for the test substances and, where appropriate, for the hydrolysis products at each pH value and temperature;
- tables of results of Arrhenius equation for the temperature 20 °C/ 25 °C, with pH, rate constant [h^{-1} or day^{-1}], half-life or DT_{50} , temperatures [°C] including confidence limits and the coefficients of correlation (r^2) or comparable information;
- proposed pathway of hydrolysis.

▼B

4.

REFERENCES

- (1) OECD, (1981) Hydrolysis as a Function of pH. OECD Guideline for Testing of Chemicals No 111, adopted 12 May 1981.
- (2) US-Environmental Protection Agency, (1982) 40 CFR 796.3500, Hydrolysis as a Function of pH at 25 °C. Pesticide Assessment Guidelines, Subdivision N. Chemistry: Environmental Fate.
- (3) Agriculture Canada, (1987) Environmental Chemistry and Fate Guidelines for registration of pesticides in Canada.
- (4) European Union (EU), (1995) Commission Directive 95/36/EC amending Council Directive 91/414/EEC concerning the placing of plant protection products on the market. Annex V: Fate and Behaviour in the Environment.
- (5) Dutch Commission for Registration of Pesticides, (1991) Application for registration of a pesticide. Section G: Behaviour of the product and its metabolites in soil, water and air.
- (6) BBA, (1980) Merkblatt No 55, Teil I und II: Prüfung des Verhaltens von Pflanzenbehandlungsmitteln im Wasser (October 1980).
- (7) SETAC, (1995) Procedures for Assessing the Environmental Fate and Ecotoxicity of Pesticides. Mark R. Lynch, Ed.
- (8) OECD, (2000) Guidance document on aquatic toxicity testing of difficult substances and mixtures, OECD Environmental Health and Safety Publications Series on Testing and Assessment No 23.
- (9) OECD, (1993) Guidelines for the Testing of Chemicals. Paris. OECD (1994-2000): Addenda 6-11 to Guidelines for the Testing of Chemicals.
- (10) Nelson, H, Laskowski D, Thermes S, and Hendley P., (1997) Recommended changes in pesticide fate study guidelines for improving input to computer models. (Text version of oral presentation at the 14th Annual Meeting of the Society of Environmental Toxicology and Chemistry, Dallas TX, November 1993).
- (11) Mabey, W. and Mill, T., (1978) Critical review of hydrolysis of organic compounds in water under environmental conditions. J. Phys. Chem. Ref. Data 7, p. 383-415.

▼ B

Appendix 1

Tiered hydrolysis test scheme

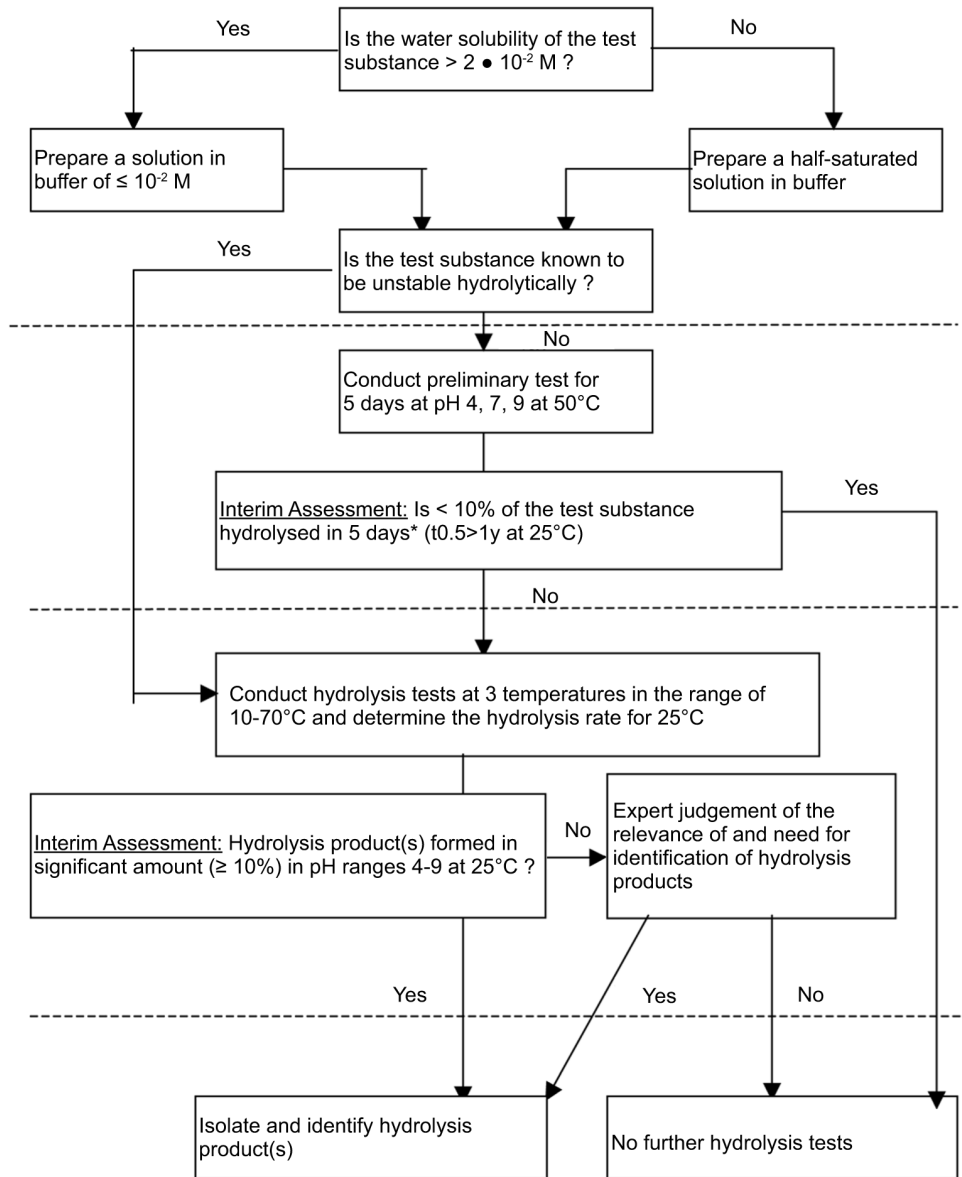

* 10% hydrolysis of a test substance at 50°C corresponds to a half-life of approx. 30 days which corresponds to a value of approx. 1 year at 20°C.

▼ B*Appendix 2***Definitions and units**

Standard International (SI) units should be used in any case.

Test substance: any substance, whether the parent compound or relevant transformation products.

Transformation products: all substances resulting from biotic or abiotic transformation reactions of the test substance.

Hydrolysis products: all substances resulting from hydrolytic transformation reactions of the test substance.

Hydrolysis refers to a reaction of a test substance RX with water, with the net exchange of the group X with OH at the reaction centre:



The rate at which the concentration of RX decreases in this simplified process is given by

$$\text{rate} = k [\text{H}_2\text{O}] [\text{RX}] \quad \text{second order reaction}$$

or

$$\text{rate} = k [\text{RX}] \quad \text{first order reaction}$$

depending on the rate determining step. Because the water is present in great excess compared to the test substance, this type of reaction is usually described as a pseudo-first order reaction in which the observed rate constant is given by the relationship

$$k_{\text{obs}} = k [\text{H}_2\text{O}] \quad [2]$$

and can be determined from the expression (*)

$$k_{\text{obs}} = \frac{1}{t} \ln \frac{C_0}{C_t} \quad [3]$$

where:

t = time

and C_0 , C_t = concentrations of RX at times 0 and t.

The units of this constant have the dimensions of (time)⁻¹ and the half-life of the reaction (time for 50 % of RX to react) is given by

$$t_{0,5} = \frac{\ln 2}{k_{\text{obs}}} \quad [4]$$

Half-life: ($t_{0,5}$) is the time taken for 50 % hydrolysis of a test substance when the reaction can be described by first order kinetics; it is independent of the concentration.

(*) If the plot of the log-transformed data vs. time does not indicate a linear function (equated with a first-order reaction rate), then the use of equation [3] is not appropriate for determining the hydrolysis rate constant of the test compound.

▼ B

DT₅₀ (Disappearance Time 50): is the time within which the concentration of the test substance is reduced by 50 %; it is different from the half-life $t_{0,5}$ when the reaction does not follow first order kinetics.

Estimation of k at different temperature

When the rate constants are known for two temperatures, the rate constants at other temperatures can be calculated using the Arrhenius equation:

$$k = A \times e^{-\frac{E}{R \times T}} \text{ or } \ln k = \frac{-E}{R \times T} + \ln A$$

A plot of $\ln k$ versus $1/T$ gives a straight line with a slope of $-E/R$

where:

k = rate constant, measured at different temperatures

E = activation energy [kJ/mol]

T = absolute temperature [K]

R = gas constant [8,314 J/mol.K]

The activation energy was calculated by regression analysis or the following equation:

$$E = R \times \frac{\ln k_2 - \ln k_1}{\left(\frac{1}{T_1} - \frac{1}{T_2}\right)}$$

where: $T_2 > T_1$.

▼ B*Appendix 3***Buffer Systems****A. CLARK AND LUBS:****Buffer mixtures of CLARK and LUBS (*)**

Composition	pH
0,2 N HCl and 0,2 N KCl at 20 °C	
47,5 ml. HCl + 25 ml. KCl dil. to 100 ml	1,0
32,25 ml. HCl + 25 ml. KCl dil. to 100 ml	1,2
20,75 ml. HCl + 25 ml. KCl dil. to 100 ml	1,4
13,15 ml. HCl + 25 ml. KCl dil. to 100 ml	1,6
8,3 ml. HCl + 25 ml. KCl dil. to 100 ml	1,8
5,3 ml. HCl + 25 ml. KCl dil. to 100 ml	2,0
3,35 ml. HCl + 25 ml. KCl dil. to 100 ml	2,2
0,1 M potassium biphthalate + 0,1 N HCl at 20 °C	
46,70 ml. 0,1 N HCl + 50 ml. biphthalate to 100 ml	2,2
39,60 ml. 0,1 N HCl + 50 ml. biphthalate to 100 ml	2,4
32,95 ml. 0,1 N HCl + 50 ml. biphthalate to 100 ml	2,6
26,42 ml. 0,1 N HCl + 50 ml. biphthalate to 100 ml	2,8
20,32 ml. 0,1 N HCl + 50 ml. biphthalate to 100 ml	3,0
14,70 ml. 0,1 N HCl + 50 ml. biphthalate to 100 ml	3,2
9,90 ml. 0,1 N HCl + 50 ml. biphthalate to 100 ml	3,4
5,97 ml. 0,1 N HCl + 50 ml. biphthalate to 100 ml	3,6
2,63 ml. 0,1 N HCl + 50 ml. biphthalate to 100 ml	3,8
0,1 M potassium biphthalate + 0,1 N NaOH at 20 °C	
0,40 ml. 0,1 N NaOH + 50 ml. biphthalate to 100 ml	4,0
3,70 ml. 0,1 N NaOH + 50 ml. biphthalate to 100 ml	4,2
7,50 ml. 0,1 N NaOH + 50 ml. biphthalate to 100 ml	4,4
12,15 ml. 0,1 N NaOH + 50 ml. biphthalate to 100 ml	4,6
17,70 ml. 0,1 N NaOH + 50 ml. biphthalate to 100 ml	4,8

(*) The pH values reported in these tables have been calculated from the potential measurements using Sørensen's standard equations (1909). The corresponding pH values are 0,04 units higher than the tabulated values.

▼ B

Composition	pH
23,85 ml. 0,1 N NaOH + 50 ml. biphthalate to 100 ml	5,0
29,95 ml. 0,1 N NaOH + 50 ml. biphthalate to 100 ml	5,2
35,45 ml. 0,1 N NaOH + 50 ml. biphthalate to 100 ml	5,4
39,85 ml. 0,1 N NaOH + 50 ml. biphthalate to 100 ml	5,6
43,00 ml. 0,1 N NaOH + 50 ml. biphthalate to 100 ml	5,8
45,45 ml. 0,1 N NaOH + 50 ml. biphthalate to 100 ml	6,0

Buffer mixtures of CLARK and LUBS (Continued)

0,1 M monopotassium phosphate + 0,1 N NaOH at 20 °C	
5,70 ml. 0,1 N NaOH + 50 ml. phosphate to 100 ml	6,0
8,60 ml. 0,1 N NaOH + 50 ml. phosphate to 100 ml	6,2
12,60 ml. 0,1 N NaOH + 50 ml. phosphate to 100 ml	6,4
17,80 ml. 0,1 N NaOH + 50 ml. phosphate to 100 ml	6,6
23,45 ml. 0,1 N NaOH + 50 ml. phosphate to 100 ml	6,8
29,63 ml. 0,1 N NaOH + 50 ml. phosphate to 100 ml	7,0
35,00 ml. 0,1 N NaOH + 50 ml. phosphate to 100 ml	7,2
39,50 ml. 0,1 N NaOH + 50 ml. phosphate to 100 ml	7,4
42,80 ml. 0,1 N NaOH + 50 ml. phosphate to 100 ml	7,6
45,20 ml. 0,1 N NaOH + 50 ml. phosphate to 100 ml	7,8
46,80 ml. 0,1 N NaOH + 50 ml. phosphate to 100 ml	8,0
0,1 M H₃B₃O₃ in 0,1 M KCl + 0,1 N NaOH at 20 °C	
2,61 ml. 0,1 N NaOH + 50 ml. boric acid to 100 ml	7,8
3,97 ml. 0,1 N NaOH + 50 ml. boric acid to 100 ml	8,0
5,90 ml. 0,1 N NaOH + 50 ml. boric acid to 100 ml	8,2
8,50 ml. 0,1 N NaOH + 50 ml. boric acid to 100 ml	8,4
12,00 ml. 0,1 N NaOH + 50 ml. boric acid to 100 ml	8,6
16,30 ml. 0,1 N NaOH + 50 ml. boric acid to 100 ml	8,8
21,30 ml. 0,1 N NaOH + 50 ml. boric acid to 100 ml	9,0
26,70 ml. 0,1 N NaOH + 50 ml. boric acid to 100 ml	9,2

▼B

32,00 ml. 0,1 N NaOH + 50 ml. boric acid to 100 ml	9,4
36,85 ml. 0,1 N NaOH + 50 ml. boric acid to 100 ml	9,6
40,80 ml. 0,1 N NaOH + 50 ml. boric acid to 100 ml	9,8
43,90 ml. 0,1 N NaOH + 50 ml. boric acid to 100 ml	10,0

B. KOLTHOFF AND VLEESCHHOUWER:**Citrate buffers of KOLTHOFF and VLEESCHHOUWER**

Composition	pH
0,1 M monopotassium citrate and 0,1 N HCl at 18 °C (*)	
49,7 ml. 0,1 N HCl + 50 ml. citrate to 100 ml	2,2
43,4 ml. 0,1 N HCl + 50 ml. citrate to 100 ml	2,4
36,8 ml. 0,1 N HCl + 50 ml. citrate to 100 ml	2,6
30,2 ml. 0,1 N HCl + 50 ml. citrate to 100 ml	2,8
23,6 ml. 0,1 N HCl + 50 ml. citrate to 100 ml	3,0
17,2 ml. 0,1 N HCl + 50 ml. citrate to 100 ml	3,2
10,7 ml. 0,1 N HCl + 50 ml. citrate to 100 ml	3,4
4,2 ml. 0,1 N HCl + 50 ml. citrate to 100 ml	3,6
0,1 M monopotassium citrate and 0,1 N NaOH at 18 °C (*)	
2,0 ml. 0,1 N NaOH + 50 ml. citrate to 100 ml	3,8
9,0 ml. 0,1 N NaOH + 50 ml. citrate to 100 ml	4,0
16,3 ml. 0,1 N NaOH + 50 ml. citrate to 100 ml	4,2
23,7 ml. 0,1 N NaOH + 50 ml. citrate to 100 ml	4,4
31,5 ml. 0,1 N NaOH + 50 ml. citrate to 100 ml	4,6
39,2 ml. 0,1 N NaOH + 50 ml. citrate to 100 ml	4,8
46,7 ml. 0,1 N NaOH + 50 ml. citrate to 100 ml	5,0
54,2 ml. 0,1 N NaOH + 50 ml. citrate to 100 ml	5,2
61,0 ml. 0,1 N NaOH + 50 ml. citrate to 100 ml	5,4
68,0 ml. 0,1 N NaOH + 50 ml. citrate to 100 ml	5,6
74,4 ml. 0,1 N NaOH + 50 ml. citrate to 100 ml	5,8
81,2 ml. 0,1 N NaOH + 50 ml. citrate to 100 ml	6,0

(*) Add tiny crystal of thymol or a similar substance to prevent growth of molds.

▼ **B**C. **SÖRENSEN:****Borate mixtures of SÖRENSEN**

Composition		Sörensen 18 °C	Walbum, pH at		
ml. Borax	ml. HCl/NaOH		10 °C	40 °C	70 °C
0,05 M borax + 0,1 N HCl					
5,25	4,75	7,62	7,64	7,55	7,47
5,50	4,50	7,94	7,98	7,86	7,76
5,75	4,25	8,14	8,17	8,06	7,95
6,00	4,00	8,29	8,32	8,19	8,08
6,50	3,50	8,51	8,54	8,40	8,28
7,00	3,00	8,08	8,72	8,56	8,40
7,50	2,50	8,80	8,84	8,67	8,50
8,00	2,00	8,91	8,96	8,77	8,59
8,50	1,50	9,01	9,06	8,86	8,67
9,00	1,00	9,09	9,14	8,94	8,74
9,50	0,50	9,17	9,22	9,01	8,80
10,00	0,00	9,24	9,30	9,08	8,86
0,05 M borax + 0,1 N NaOH					
10,0	0,0	9,24	9,30	9,08	8,86
9,0	1,0	9,36	9,42	9,18	8,94
8,0	2,0	9,50	9,57	9,30	9,02
7,0	3,0	9,68	9,76	9,44	9,12
6,0	4,0	9,97	10,06	9,67	9,28

Phosphate mixtures of SÖRENSEN

Composition	pH
0,0667 M Monopotassium phosphate + 0,0667 M Disodium phosphate at 20 °C	
99,2 ml. KH ₂ PO ₄ + 0,8 ml Na ₂ HPO ₄	5,0
98,4 ml. KH ₂ PO ₄ + 1,6 ml Na ₂ HPO ₄	5,2
97,3 ml. KH ₂ PO ₄ + 2,7 ml Na ₂ HPO ₄	5,4
95,5 ml. KH ₂ PO ₄ + 4,5 ml Na ₂ HPO ₄	5,6
92,8 ml. KH ₂ PO ₄ + 7,2 ml Na ₂ HPO ₄	5,8
88,9 ml. KH ₂ PO ₄ + 11,1 ml Na ₂ HPO ₄	6,0
83,0 ml. KH ₂ PO ₄ + 17,0 ml Na ₂ HPO ₄	6,2
75,4 ml. KH ₂ PO ₄ + 24,6 ml Na ₂ HPO ₄	6,4
65,3 ml. KH ₂ PO ₄ + 34,7 ml Na ₂ HPO ₄	6,6

▼B

53,4 ml. KH_2PO_4 + 46,6 ml Na_2HPO_4	6,8
41,3 ml. KH_2PO_4 + 58,7 ml Na_2HPO_4	7,0
29,6 ml. KH_2PO_4 + 70,4 ml Na_2HPO_4	7,2
19,7 ml. KH_2PO_4 + 80,3 ml Na_2HPO_4	7,4
12,8 ml. KH_2PO_4 + 87,2 ml Na_2HPO_4	7,6
7,4 ml. KH_2PO_4 + 92,6 ml Na_2HPO_4	7,8
3,7 ml. KH_2PO_4 + 96,3 ml Na_2HPO_4	8,0

▼B**C.8. TOXICITY FOR EARTHWORMS**

ARTIFICIAL SOIL TEST

1. METHOD**1.1. INTRODUCTION**

In this laboratory test, the test substance is added to an artificial soil in which worms are placed for 14 days. After this period (and optionally after seven days) the lethal effect of the substance on the earthworms is examined. The test provides a method for relatively short-term screening of the effect of chemicals on earthworms, by dermal and alimentary uptake.

1.2. DEFINITION AND UNIT

LC₅₀: the concentration of a substance estimated as killing 50 % of the test animals during the test period.

1.3. REFERENCE SUBSTANCE

A reference substance is used periodically as a means of demonstration that the sensitivity of the test system has not changed significantly.

Analytical grade chloroacetamide is recommended as the reference substance.

1.4. PRINCIPLE OF THE TEST

Soil is a variable medium, so for this test a carefully defined artificial loam soil is used. Adult earthworms of the species *Eisenia foetida* (see note in Appendix) are kept in a defined artificial soil treated with different concentrations of the test substance. The content of the containers is spread on a tray 14 days (and optionally seven days) after the beginning of the test, and the earthworms surviving at each concentration counted.

1.5. QUALITY CRITERIA

The test is designed to be as reproducible as possible with respect to the test substrate and organism. Mortality in the controls must not exceed 10 % at the end of the test, or the test is invalid.

1.6. DESCRIPTION OF THE TEST METHOD**1.6.1. Materials****1.6.1.1. Test substrate**

A defined artificial soil is used as a basic test substrate.

(a) Basic substrate (percentages are in terms of dry weight)

— 10 % sphagnum peat (as close to pH 5,5 to 6,0 as possible with no visible plant remains and finely ground),

▼B

- 20 % kaolinite clay with preferably more than 50 % kaolinite,
- about 69 % industrial quartz sand (dominant fine sand with more than 50 % of particle size 0,05 to 0,2 mm). If the substance is not sufficiently dispersible in water, 10 g per test container should be kept available for mixing with the test substance later on,
- about 1 % calcium carbonate (CaCO₃), pulverised, chemically pure, added to bring the pH to 6,0 ± 0,5.

(b) Test substrate

The test substrate contains the basic substrate, the test substance and deionised water.

Water content is about 25 to 42 % of the dry weight of the basic substrate. The water content of the substrate is determined by drying a sample to constant weight at 105 °C. The key criterion is that the artificial soil must be wetted to a point where there is no standing water. Care should be taken in mixing to obtain an even distribution of the test substance and the substrate. The way of introducing the test substance to the substrate has to be reported.

(c) Control substrate

The control substrate contains the basic substrate and water. If an additive agent is used, an additional control should contain the same quantity of the additive agent.

1.6.1.2. Test containers

Glass containers of about one litre capacity (adequately covered with plastic lids, dishes or plastic film with ventilation holes) filled with an amount of wet test or control substrate equivalent to 500 g dry weight of substrate.

1.6.2. Test conditions

Containers should be kept in climatic chambers at a temperature of 20 ± 2 °C with continuous light. Light intensity should be 400 to 800 lux.

The test period is 14 days, but mortality can be assessed optionally seven days after starting the test.

1.6.3. Test procedure

Test concentrations

Concentrations of the test substance are expressed as weight of substance per dry weight of basic substrate (mg/kg).

Range finding test

The range of concentrations just causing mortalities of 0 to 100 % may be determined in a range-finding test to provide information on the range of concentrations to be used in the definitive test.

▼B

The substance should be tested at the following concentrations: 1 000; 100; 10; 1; 0,1 mg substance/kilogram test substrate (dry weight).

If a full definitive test is to be carried out, one test batch per concentration and one for the untreated control, each with 10 worms, could be sufficient for the range-finding test.

Definitive test

The results of the range-finding test are used to choose at least five concentrations in a geometric series just spanning the range 0 to 100 % mortality and differing by a constant factor not exceeding 1,8.

Tests using these series of concentration should allow the LC_{50} value and its confidence limits to be estimated as precisely as possible.

In the definitive test at least four test batches per concentration and four untreated controls, each with 10 worms, are used. The results of these replicate batches are given as a mean and standard deviation.

When two consecutive concentrations, at a ratio of 1,8, give only 0 % and 100 % mortality, these two values are sufficient to indicate the range within which the LC_{50} falls.

Mixture of the basic test substrate and the test substance

The test substrate should, whenever possible, be made up without any additional agents other than water. Immediately before the start of the test, an emulsion or dispersion of the test substance in deionised water or other solvent is mixed with the basic test substrate, or sprayed evenly over it with a fine chromatographic or similar spray.

If insoluble in water, the test substance can be dissolved in as small a volume as possible of suitable organic solvent (e.g. hexane, acetone or chloroform).

Only agents which volatilise readily may be used to solubilise, disperse or emulsify the test substance. The test substrate must be ventilated before use. The amount of water evaporated must be replaced. The control should contain the same quantity of any additive agent.

If the test substance is not soluble, dispersible or emulsifiable in organic solvents, 10 g of a mixture of fine ground quartz sand and a quantity of test substance necessary to treat 500 g dry weight of artificial soil are mixed with 490 g of dry weight of test substrate.

For each test batch, an amount of wet test substrate equivalent to 500 g dry weight is placed in each glass container and 10 earthworms, which have been conditioned for 24 hours in a similar wet basic substrate and then washed quickly and surplus water absorbed on filter paper before use, are placed on the test substrate surface.

▼ B

The containers are covered with perforated plastic lids, dishes or film to prevent the substrate drying and they are kept under the test conditions for 14 days.

The assessments should be made 14 days (and optionally seven days) after setting up the test. The substrate is spread on a plate made of glass or stainless steel. The earthworms are examined and the numbers of surviving earthworms determined. Earthworms are considered dead if they do not respond to a gentle mechanical stimulus to the front end.

When the examination is made at seven days, the container is refilled with the substrate and the surviving earthworms are replaced on the same test substrate surface.

1.6.4. *Test organisms*

Test organisms should be adult *Eisenia foetida* (see note in Appendix) (at least two months old with clitellum) wet weight 300 to 600 mg. (For breeding method see Appendix.)

2. **DATA**

2.1. TREATMENT AND EVALUATION OF RESULTS

The concentrations of the substance tested are reported with reference to the corresponding percentages of dead earthworms.

When the data are adequate the LC₅₀ value and the confidence limits ($p = 0,05$) should be determined using standard methods (Litchfield and Wilcoxon, 1949, for equivalent method). The LC₅₀ should be given as mg of test substance per kilogram of the test substrate (dry weight).

In those cases where the slope of the concentration curve is too steep to permit calculation of the LC₅₀, a graphical estimate of this value is sufficient.

When two consecutive concentrations at a ratio of 1,8 give only 0 % and 100 % mortality, the two values are sufficient to indicate the range within which the LC₅₀ falls.

3. **REPORTING**

3.1. TEST REPORT

The test report shall, if possible, contain the following:

- statement that the test has been carried out in accordance with the abovementioned quality criteria,
- test carried out (range finding test and/or definitive test),
- exact description of the test conditions or statement that the test has been carried out in accordance with the method; any deviations have to be reported,
- exact description of how the test substance has been mixed into the basic test substrate,
- information about test organisms (species, age, mean and range in weight, keeping and breeding conditions, supplier),

▼B

- method used for determination of LC₅₀,
- test results including all data used,
- description of observed symptoms or changes in behaviour of test organisms,
- mortality in the controls,
- LC₅₀ or highest tested concentration without mortality and lowest tested concentration with a mortality of 100 %, 14 days (and optionally seven days) after setting up the test,
- plotting of the concentration/response curve,
- results obtained with the reference substance, whether in association with the present test or from previous quality control exercises.

4. REFERENCES

- 1) OECD, Paris, 1981, Test Guideline 207, Decision of the Council C(81)30 final.
- 2) Edwards, C. A. and Lofty, J. R., 1977, Biology of Earthworms, Chapman and Hall, London, p. 331.
- 3) Bouche. M. B., 1972, Lombriciens de France, Ecologie et Systematique, Institut National de la Recherche Agronomique, p. 671.
- 4) Litchfield, J. T. and Wilcoxon, F., A simplified method of evaluation dose effect experiments. I. Pharm. Exp. Therap., vol. 96, 1949, p. 99.
- 5) Commission of the European Communities, Development of a standardised laboratory method for assessing the toxicity of chemical substances to earthworms, Report EUR 8714 EN, 1983.
- 6) Umweltbundesamt/Biologische Bundesanstalt für land- und Forstwirtschaft, Berlin, 1984, Verfahrensvorschlag 'Toxizitätstest am Regenwurm *Eisenia foetida* in künstlichem Boden', in: Rudolph/Boje, Ökotoxikologie, ecomed, Landsberg, 1986.

▼B*Appendix***Breeding and keeping of the worms before testing**

For breeding the animals, 30 to 50 adult worms, are put in a breeding box with fresh substrate and removed after 14 days. These animals may be used for further breeding batches. The earthworms hatched from the cocoons are used for testing when mature (under the prescribed conditions after two to three months).

Keeping and breeding conditions

Climatic chamber: temperature 20 ± 2 °C preferably with continuous light (intensity 400 to 800 lux).

Breeding boxes: suitable shallow containers of 10 to 20 l volume.

Substrate: *Eisenia foetida* may be bred in various animal excrements. It is recommended to use as breeding medium a mixture of 50 % by volume peat and 50 % cow or horse dung. The medium should have a pH value of about 6 to 7 (regulated with calcium carbonate) and a low ionic conductivity (less than 6 mmhos or 0,5 % salt concentration).

The substrate should be moist but not too wet.

Other successful procedures may be used besides the method given above.

Note: Eisenia foetida exists in two races which some taxonomists have separated into species (Bouche, 1972). These are morphologically similar but one, *Eisenia foetida foetida*, has typically transverse striping or banding on the segments and the other, *Eisenia foetida andrei*, lacks this and has a variegated reddish colour. Where possible *Eisenia foetida andrei* should be used. Other species may be used if the necessary methodology is available.



C.9. BIODEGRADATION

ZAHN-WELLENS TEST

1. METHOD

1.1. INTRODUCTION

The purpose of the method is the evaluation of the potential ultimate biodegradability of water-soluble, non-volatile organic substances when exposed to relatively high concentrations of micro-organisms in a static test.

Physico-chemical adsorption on the suspended solids may take place and this must be taken into account when interpreting results (see 3.2).

The substances to be studied are used in concentrations corresponding to DOC-values in the range of 50 to 400 mg/litre or COD-values in the range of 100 to 1 000 mg/litre (DOC = dissolved organic carbon; COD = chemical oxygen demand). These relatively high concentrations have the advantage of analytical reliability. Compounds with toxic properties may delay or inhibit the degradation process.

In this method, the measure of the concentration of dissolved organic carbon or the chemical oxygen demand is used to assess the ultimate biodegradability of the test substance.

A simultaneous use of a specific analytical method may allow the assessment of the primary biodegradation of the substance (disappearance of the parent chemical structure).

The method is applicable only to those organic test substances which, at the concentration used in the test:

- are soluble in water under the test conditions,
- have negligible vapour pressure under the test conditions,
- are not inhibitory to bacteria,
- are adsorbed within the test system only to a limited extent,
- are not lost by foaming from the test solution.

Information on the relative proportions of the major components of the test material will be useful in interpreting the results obtained, particularly in those cases where the results are low or marginal.

Information on the toxicity of the substance to micro-organisms is desirable for the interpretation of low results and in the selection of appropriate test concentrations.

▼ B

1.2. DEFINITIONS AND UNITS

The amount of degradation attained at the end of the test is reported as the 'Biodegradability in the Zahn-Wellens test':

$$D_T(\%) = \left[1 - \frac{(C_T - C_B)}{(C_A - C_{BA})} \right] \times 100$$

where:

DT = biodegradation (%) at time T,

CA = DOC (or COD) values in the test mixture measured three hours after the beginning of the test (mg/l) (DOC = dissolved organic carbon, COD = chemical oxygen demand),

CT = DOC or COD values in the test mixture at time of sampling (mg/l),

CB = DOC or COD value of the blank at time of sampling (mg/l),

CBA = DOC or COD value of the blank, measured three hours after the beginning of the test (mg/l).

The extent of degradation is rounded to the nearest full percent.

Percentage degradation is stated as the percentage DOC (or COD) removal of the tested substance.

The difference between the measured value after three hours and the calculated or preferably measured initial value may provide useful information on the elimination of the substance (see 3.2, Interpretation of results).

1.3. REFERENCE SUBSTANCES

In some cases when investigating new substances reference substances may be useful; however, specific reference substances cannot yet be recommended.

1.4. PRINCIPLE OF THE TEST METHOD

Activated sludge, mineral nutrients and the test material as the sole carbon source in an aqueous solution are placed together in a one to four litre glass vessel equipped with an agitator and an aerator. The mixture is agitated and aerated at 20 to 25 °C under diffuse illumination or in a dark room for up to 28 days. The degradation process is monitored by determination of the DOC (or COD) values in the filtered solution at daily or other appropriate regular time intervals. The ratio of eliminated DOC (or COD) after each interval to the value three hours after the start is expressed as percentage biodegradation and serves as the measure of the extent of degradation at this time. The result is plotted versus time to give the biodegradation curve.

When a specific analytical method is used, changes in the concentration of the parent molecule due to biodegradation can be measured (primary biodegradability).

▼B

1.5. QUALITY CRITERIA

The reproducibility of this test has been proven to be satisfactory in a ring test.

The sensitivity of the method is largely determined by the variability of the blank and, to a lesser extent, by the precision of the determination of dissolved organic carbon and the level of test compound in the liquor.

1.6. DESCRIPTION OF THE TEST PROCEDURE

1.6.1. *Preparations*

1.6.1.1. Reagents

Test water: drinking water with an organic carbon content < 5 mg/litre. The concentration of calcium and magnesium ions together must not exceed 2,7 mmole/litre; otherwise adequate dilution with deionised or distilled water is required.

Sulphuric acid, analytical reagent (A.R.): 50 g/l

Sodium hydroxide solution A.R.: 40 g/l

Mineral nutrient solution: dissolve in one litre deionised water:

ammonium chloride, NH₄Cl, A.R.: 38,5 g

sodium dihydrogenphosphate, NaH₂PO₄·2H₂O, A.R.: 33,4 g

potassium dihydrogenphosphate, KH₂PO₄, A.R.: 8,5 g

di-potassium mono-hydrogenphosphate, K₂HPO₄, A.R.: 21,75 g

The mixture serves both as a nutrient and as buffering system.

1.6.1.2. Apparatus

Glass vessels with a volume of one to four litres (e.g. cylindrical vessels).

Agitator with a glass or metal stirrer on a suitable shaft (the stirrer should rotate about 5 to 10 cm above the bottom of the vessel). A magnetic stirrer with a 7 to 10 cm long rod can be used instead.

Glass tube of 2 to 4 mm inner diameter to introduce air. The opening of the tube should be about 1 cm above the bottom of the vessel.

Centrifuge (about 3 550 g).

pH-meter.

Dissolved-oxygen meter.

Paper filters.

▼B

Membrane filtration apparatus.

Membrane filters, pore size 0,45 µm. Membrane filters are suitable if it is assured that they neither release carbon nor absorb the substance in the filtration step.

Analytical equipment for determining organic carbon content and chemical oxygen demand.

1.6.1.3. Preparation of the inoculum

Activated sludge from a biological treatment plant is washed by (repeatedly) centrifuging or settling with test water (above).

The activated sludge must be in an appropriate condition. Such sludge is available from a properly working waste-water treatment plant. To get as many different species or strains of bacteria as possible, it may be preferred to mix inocula from different sources (e.g. different treatment plants, soil extracts, river waters, etc.). The mixture is to be treated as described above.

For checking the activity of the activated sludge see 'Functional control', below.

1.6.1.4. Preparation of the test solutions

To the test vessel add 500 ml of test water, 2,5 ml/litre mineral nutrient solution and activated sludge in an amount corresponding to 0,2 to 1,0 g/litre dry matter in the final mixture. Add sufficient stock solution of the substance to be tested so that a DOC concentration of 50 to 400 mg/litre results in the final mixture. The corresponding COD-values are 100 to 1 000 mg/litre. Make up with test water to a total volume of one to four litres. The total volume to be chosen is dependent on the number of samples to be taken for DOC or COD determinations and the volumes necessary for the analytical procedure.

Normally a volume of two litres can be regarded as satisfactory. At least one control vessel (blank) is set up to run in parallel with each test series; it contains only activated sludge and mineral nutrient solution made up with test water to the same total volume as in the test vessels.

1.6.2. *Performance of the test*

The test vessels are agitated with magnetic stirrers or screw propellers under diffuse illumination or in a dark room at 20 to 25 °C. Aeration is accomplished by compressed air cleaned by a cotton-wool strainer and a wash bottle if necessary. It must be ensured that the sludge does not settle and the oxygen concentration does not fall below 2 mg/litre.

The pH-value must be checked at regular intervals (e.g. daily) and adjusted to pH 7 to 8, if necessary.

▼ B

Losses from evaporation are made up just before each sampling with deionised or distilled water in the required amounts. A good procedure is to mark the liquid level on the vessel before starting the test. New marks are made after each sampling (without aeration and stirring). The first samples are always taken three hours after the start of the test in order to detect adsorption of test material by the activated sludge.

The elimination of the test material is followed by DOC or COD determinations made daily or at some other regular interval. The samples from the test vessel and the blank are filtered through a carefully washed paper filter. The first 5 ml of test solution filtrate are discarded. Sludges difficult to filter may be removed previously by centrifugation for 10 minutes. DOC and COD determinations are made at least in duplicate. The test is run for up to 28 days.

Note: samples remaining turbid are filtered through membrane filters. The membrane filters must not release or adsorb any organic material.

Functional control of activated sludge

A vessel containing a known substance should be run in parallel with each test series in order to check the functional capacity of the activated sludge. Diethyleneglycol has been found useful for this purpose.

Adaptation

If analyses are carried out at relatively short intervals (e.g. daily), adaptation can be clearly recognised from the degradation curve (see Figure 2). The test should therefore not be started immediately before the weekend.

If the adaptation occurs in the end of the period, the test can be prolonged until the degradation is finished.

Note: if a broader knowledge of the behaviour of the adapted sludge is needed, the same activated sludge is exposed once again to the same test material in accordance with the following procedure:

Switch of the agitator and the aerator and allow the activated sludge to settle. Draw off the supernatant liquid, fill up to two litres with test water, stir for 15 minutes and allow to settle again. After the supernatant liquid is drawn off again, use the remaining sludge to repeat the test with the same material in accordance with 1.6.1.4 and 1.6.2, above. The activated sludge can also be isolated by centrifuging instead of settling.

The adapted sludge may be mixed with fresh sludge to a concentration of 0,2 to 1 g dry weight/litre.

▼ B**Analytical means**

Normally samples are filtered through a carefully washed paper filter (for washing use deionised water).

Samples which remain turbid are filtered through membrane filters (0,45 µm).

The DOC concentration is determined in duplicate in the sample filtrates (the first 5 ml are discarded) by means of the TOC instrument. If the filtrate cannot be analysed on the same day, it must be stored in the refrigerator until the next day. Longer storage cannot be recommended.

The COD concentration: is determined in the sample filtrates with a COD analytical set-up by the procedure described in reference (2) below.

2. DATA AND EVALUATION

DOC and/or COD concentrations are determined at least in duplicate in the samples according to 1.6.2 above. The degradation at time T is calculated according to the formula (with definitions) given under 1.2 above.

The extent of degradation is rounded to the nearest full percent. The amount of degradation attained at the end of the test is reported as the 'Biodegradability in the Zahn-Wellens test'.

Note: if complete degradation is attained before the test time is over and this result is confirmed by a second analysis on the next day, the test can be concluded.

3. REPORTING**3.1. TEST REPORT**

The test report shall, if possible, contain the following:

- the initial concentration of the substance,
- all other information and the experimental results concerning the tested substance, the reference substance if used, and the blank,
- the concentration after three hours,
- biodegradation: curve with description,
- date and location where test organisms were sampled, status of adaptation, concentration used, etc.,
- scientific reasons for any changes of test procedure.

3.2. INTERPRETATION OF RESULTS

Removal of DOC (COD) which takes place gradually over days or weeks indicates that the test substance is being biodegraded.

▼B

However, physico-chemical adsorption can, in some cases, play a role and this is indicated when there is complete or partial removal from the outset, within the first three hours, and the difference between control and test supernatant liquors remains at an unexpectedly low level.

Further tests are necessary if a distinction is to be drawn between biodegradation (or partial biodegradation) and adsorption.

This can be done in a number of ways, but the most convincing is to use the supernatant or sludge as inoculum in a base-set test (preferably a respirometric test).

Test substances giving high, non-adsorptive removal of DOC (COD) in this test should be regarded as potentially biodegradable. Partial, non-adsorptive removal indicates that the chemical is at least subject to some biodegradation. Low, or zero removals of DOC (COD) may be due to inhibition of microorganisms by the test substance and this may also be revealed by lysis and loss of sludge, giving turbid supernatants. The test should be repeated using a lower concentration of test substance.

The use of a compound-specific analytical method or of ^{14}C -labelled test substance may allow greater sensitivity. In the case of ^{14}C test compound, the recovery of the $^{14}\text{CO}_2$ will confirm that biodegradation has occurred.

When results are given in terms of primary biodegradation, an explanation should, if possible, be given on the chemical structure change that leads to the loss of response of the parent test substance.

The validation of the analytical method must be given together with the response found on the blank test medium.

4. REFERENCES

- (1) OECD, Paris, 1981, Test Guideline 302 B, Decision of the Council C(81) 30 final.
- (2) Annex V C.9 Degradation: Chemical Oxygen Demand, Commission Directive 84/449/EEC, (OJ L 251, 19.9.1984, p. 1).

▼ B*Appendix*

EVALUATION EXAMPLE

Organic compound:	4-Ethoxybenzoic acid
Theoretical test concentration:	600 mg/l
Theoretical DOC:	390 mg/l
Inoculum	Sewage treatment plant of...
Concentration:	1 gram dry material/litre
Adaptation status:	not adapted
Analysis:	DOC-determination
Amount of sample:	3 ml
Control substance:	Diethyleneglycol
Toxicity of compound:	No toxic effects below 1 000 mg/l Test used: fermentation tubes test

Test time	Control substance				Test substance		
	Blank DOC (1) mg/l	DOC (1) mg/l	DOC net mg/l	Degradation %	DOC (1) mg/l	DOC net mg/l	Degradation %
0	—	—	300,0	—	—	390,0	—
3 hours	4,0	298,0	294,0	2	371,6	367,6	6
1 day	6,1	288,3	282,2	6	373,3	367,2	6
2 days	5,0	281,2	276,2	8	360,0	355,0	9
5 days	6,3	270,5	264,2	12	193,8	187,5	52
6 days	7,4	253,3	245,9	18	143,9	136,5	65
7 days	11,3	212,5	201,2	33	104,5	93,2	76
8 days	7,8	142,5	134,7	55	58,9	51,1	87
9 days	7,0	35,0	28,0	91	18,1	11,1	97
10 days	18,0	37,0	19,0	94	20,0	2,0	99

(1) Mean values of triplicate determinations.

▼ B

Figure 1

Examples of biodegradation curves

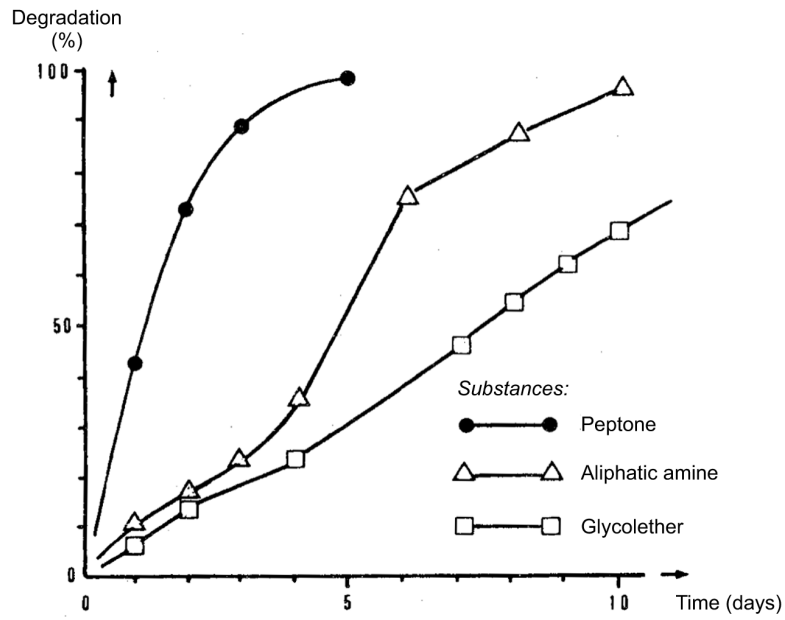
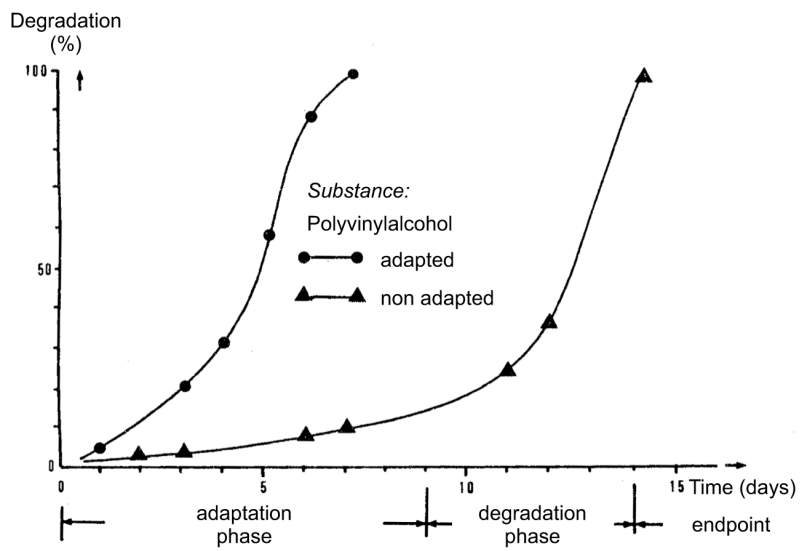

Figure 2

Examples of sludge adaptation



▼M4**C.10. SIMULATION TESTS AEROBIC SEWAGE TREATMENT: C.10-A: ACTIVATED SLUDGE UNITS — C.10-B: BIOFILMS****C.10-A: Activated Sludge Units**

INTRODUCTION

1. This Test Method is equivalent to OECD Test Guideline (TG) 303 (2001). In the 1950s it was realised that the newly introduced surfactants caused excessive foaming in waste water treatment plants and in rivers. They were not fully removed in the aerobic treatment and in some cases limited the removal of other organic matter. This instigated many investigations into how surfactants could be removed from waste waters and whether new chemicals produced by industry were amenable to waste water treatment. In order to do this, model units were used representing the two main types of aerobic biological waste water treatment (activated sludge and percolating, or trickling, filtration). It would have been impractical and very costly to distribute each new chemical and to monitor large-scale treatment plants, even on a local basis.

INITIAL CONSIDERATIONS

Activated sludge units

2. Model activated sludge units have been described ranging in size from 300 ml up to about 2 000 ml. Some closely mimicked full-scale plants, having sludge settlement tanks with settled sludge being pumped back to the aeration tank, while others provided no settlement facilities e.g. Swisher (1). The size of the apparatus is a compromise; on the one hand, it must be large enough for successful mechanical operation and for the provision of sufficient volume of samples without affecting the operation, while on the other hand it should not be so large that it demands excessive space and materials.
3. Two forms of apparatus which have been extensively and satisfactorily used are the Husmann units (2) and Porous Pot units (3)(4), first used in the study of surfactants; these are described in this Test Method. Others have also been used satisfactorily, e.g. Eckenfelder (5). Because of the relatively high cost and effort of applying this simulation test, simpler and cheaper screening tests, now embodied in chapter C.4 A-F of this Annex (6) were investigated in parallel. Experience with many surfactants and other chemicals has shown that those which passed the screening tests (readily biodegradable) also degraded in the simulation test. Some of those failing the screening tests passed the inherent biodegradability tests (chapters C.12 (7) and C.19 (8) of this Annex) but only some of this latter group were degraded in the simulation test, while those chemicals which failed tests for inherent biodegradability did not degrade in the simulation tests (9)(10)(11).
4. For some purposes simulation tests carried out under a single set of operating conditions are sufficient; the results are expressed as a percentage removal of the test chemical or of dissolved organic carbon (DOC). A description of such a test is given in this test method. However, unlike the previous version of this chapter, which described only one type of apparatus treating synthetic sewage in the coupled mode using a relatively

▼ **M4**

crude method of sludge wastage, this text offers a number of variations. Alternatives to the type of apparatus, mode of operation, sewage and sludge wastage removal are described. This text closely follows that of ISO 11733 (12), which was carefully scrutinised during its preparation, though the method has not been subject to a ring test.

5. For other purposes the concentration of the test chemical in the effluent is required to be known more accurately and for this a more extensive method is needed. For example, the sludge wastage rate must be more precisely controlled throughout each day and throughout the period of the test, and units have to be run at a number of wastage rates. For a fully comprehensive method, tests should also be run at two or three different temperatures: such a method is described by Birch (13)(14) and summarised in Appendix 6. However, present knowledge is insufficient to decide which of the kinetic models are applicable to the biodegradation of chemicals in waste water treatment and in the aquatic environment generally. The application of Monod kinetics, given in Appendix 6 as an example, is limited to chemicals present at 1 mg/l and above, but in the opinion of some even this remains to be substantiated. Tests at concentrations more truly reflecting those found in waste waters are indicated, in Appendix 7, but such tests, and those in Appendix 6, are included in Appendices instead of being issued as separate Test Methods.

Filters

6. Much less attention has been given to model percolating filters, perhaps because they are more cumbersome and less compact than activated sludge plant models. Gerike et al developed trickling filter units and operated them in the coupled mode ((15). These filters were relatively large (height 2 m; volume 60 l) and each required as much as 2 l/h of sewage. Baumann et al (16), simulated trickling filters by inserting polyester 'fleece' strips into 1 m tubes (14 mm int. diameter) after the strips had been immersed in concentrated activated sludge for 30 min. The test chemical as sole C source in a mineral salts solution was fed down the vertical tube and biodegradation was assessed from measurements of DOC in the effluent and CO₂ in the issuing gas.
7. Biofilters have been simulated in another way (15); the inner surfaces of rotating tubes, inclined at a small angle to the horizontal, were fed with sewage (about 250 ml/h) with and without the test chemical, and the collected effluents analysed for DOC and/or the specific test chemical.

PRINCIPLE OF THE TEST

8. This method is designed to determine the elimination and the primary and/or ultimate biodegradation of water-soluble organic chemicals by aerobic micro-organisms in a continuously operated test system simulating the activated sludge process. An easily biodegradable organic medium and the organic test chemical are the sources of carbon and energy for the micro-organisms.
9. Two continuously operated test units (activated sludge plants or porous pots) are run in parallel under identical conditions which are chosen to suit the purpose of the test. Normally the mean hydraulic retention time is 6 h and the mean sludge age (sludge retention time) is 6 to 10 days. Sludge is wasted by one of two methods, the test chemical is normally added at a concentration of between 10 mg/l dissolved organic carbon (DOC) and 20 mg/l DOC, to the influent (organic medium) of only one of the units. The second unit is used as a control unit to determine the biodegradation of the organic medium.

▼M4

10. In frequently taken samples of the effluents, the DOC, preferably, or chemical oxygen demand (COD) is determined, together with the concentration of the test chemical (if required) by specific analysis, in the effluent from the unit receiving the test chemical. The difference between the effluent concentrations of DOC or COD in the test and control units is assumed to be due to the test chemical or its organic metabolites. This difference is compared with the influent concentration of DOC or COD due to the added test chemical in order to determine the elimination of the test chemical.
11. Biodegradation may normally be distinguished from bioadsorption by careful examination of the elimination-time curve and may usually be confirmed by applying a test for ready biodegradation using an acclimatised inoculum from the unit receiving the test chemical.

INFORMATION ON THE TEST CHEMICAL

12. The purity, water solubility, volatility and adsorption characteristics of the test chemical should be known to enable correct interpretation of results to be made. Normally volatile and insoluble chemicals cannot be tested unless special precautions are taken (see Appendix 5). The chemical structure, or at least the empirical formula, should also be known in order to calculate theoretical values and/or to check measured values of parameters, e.g. theoretical oxygen demand (ThOD), dissolved organic carbon (DOC) and chemical oxygen demand (COD).
13. Information on the toxicity of the test chemical to micro-organisms (see Appendix 4) may be useful for selecting appropriate test concentrations and may be essential for the correct interpretation of low biodegradation values.

PASS LEVELS

14. In the original application of this simulation (confirmatory) test to the primary biodegradation of surfactants, a removal of more than 80 % of the specific chemical is required before the surfactant may be marketed. If the value of 80 % is not attained, this simulation (confirmatory) test may be applied and the surfactant may be marketed only if more than 90 % of the specific chemical is removed. With chemicals in general there is no question of pass/fail and the value of percentage removal obtained can be used in proximate calculations of the probable environmental concentration to be used in hazard assessments posed by chemicals. Results tend to follow an all or nothing pattern. In a number of studies of pure chemicals the percentage removal of DOC was found to be > 90 % in more than three quarters and > 80 % in over 90 % of chemicals which showed any significant degree of biodegradability.
15. Relatively few chemicals (e.g. surfactants) are present in sewage at the concentrations (about 10 mg C/l) used in this test. Some chemicals may be inhibitory at these concentrations, while the kinetics of removal of others may be different at low concentrations. A more accurate assessment of the degradation could be made by using modified methods, using realistically low concentrations of the test chemical, and the data collected could be used to calculate kinetic constants. However, the necessary experimental techniques have not yet been fully validated and neither have the kinetic models, which describe the biodegradation reactions, been established (see Appendix 7).

▼ M4

REFERENCE CHEMICALS

16. To ensure that the experimental procedure is being carried out correctly, it is useful occasionally to test chemicals whose behaviour is known simultaneously when test chemicals are investigated. Such chemicals include adipic acid, 2-phenyl phenol, 1-naphthol, diphenic acid, 1-naphthoic acid, etc. (9)(10)(11).

REPRODUCIBILITY OF TEST RESULTS

17. There have been far fewer reports of studies of simulation tests than of tests for ready biodegradability. Reproducibility between (simultaneous) replicates is good (within 10-15 %) for test chemicals degraded by 80 % or more but for less well degraded chemicals variability is greater. Also, with some borderline chemicals widely disparate results (e.g. 10 %, 90 %) have been recorded on different occasions within the 9 weeks allowed in the test.
18. Little difference has been found in results obtained with the two types of apparatus, but some chemicals have been more extensively and consistently degraded in the presence of domestic sewage than with OECD synthetic sewage.

DESCRIPTION OF THE TEST METHOD

Apparatus*Test system*

19. The test system for one test chemical consists of a test unit and a control unit; but when only specific analyses are performed (primary biodegradation) only a test unit is required. One control unit can be used for several test units receiving either the same or different test chemicals. In the case of coupling (Appendix 3) each test unit must have its own control unit. The test system may be either an activated sludge plant model, Husmann unit (Appendix 1, Figure 1) or a porous pot (Appendix 1, Figure 2). In both cases storage vessels of sufficient size for the influents and effluents are needed, as well as pumps to dose the influent, either mixed with solution of the test chemical or separately.
20. Each activated sludge plant unit consists of an aeration vessel with a known capacity of about 3 litres of activated sludge and a separator (secondary clarifier) which holds about 1,5 litres; the volumes can, to some extent, be changed by adjusting the height of the separator. Vessels of different sizes are permissible if they are operated with comparable hydraulic loads. If it is not possible to keep the temperature in the test room in the desired range, the use of water-jacketed vessels with temperature controlled water is recommended. An airlift pump or a dosing pump is used to recycle the activated sludge from the separator to the aeration vessel, either continuously or intermittently at regular intervals.
21. The porous pot system consists of an inner, porous cylinder with a conical bottom held in a slightly larger vessel of the same shape, but made of an impervious plastic material. A suitable material for the porous vessel is porous polyethylene of maximum pore size 90 µm and 2 mm thickness. Separation of the sludge from the treated organic medium is effected by differential passage through the porous wall. Effluents collect in the annular space from where it overflows into the collecting vessel. No settlement occurs and hence there is no sludge return. The whole system may be mounted in a thermostatically controlled water-bath. Porous pots become

▼ **M4**

blocked and could overflow in the initial stages. In such a case, replace the porous liner with a clean one by first siphoning the sludge from the pot into a clean bucket and removing the blocked liner. After wiping out the impervious outer cylinder insert a clean liner and return the sludge to the pot. Any sludge adhering to the sides of the blocked liner is also carefully scraped off and transferred. Clean blocked pots first by using a fine jet of water to remove remaining sludge and by soaking in dilute sodium hypochlorite solution, then in water, followed by thoroughly rinsing with water.

22. For aeration of the sludge in the aeration vessels of both systems, suitable techniques are required, for example sintered cubes (diffuser stones) and compressed air. The air shall be cleaned, if necessary, by passing through a suitable filter and washed. Sufficient air must pass through the system to maintain aerobic conditions and to keep sludge flocs in suspension at all times during the test.

Filtration apparatus or centrifuge

23. Device for filtration of samples with membrane filters of suitable porosity (nominal aperture diameter 0,45 µm) which adsorb soluble organic chemicals and release organic carbon to a minimum degree. If filters are used which release organic carbon, wash the filters carefully with hot water to remove leachable organic carbon. Alternatively, a centrifuge capable of producing 40 000 m/s² may be used.

Analytical equipment

24. Apparatus required to determine:
- DOC(dissolved organic carbon) and TOC (total organic carbon), or COD (chemical oxygen demand);
 - specific chemical, if required;
 - suspended solids, pH, oxygen concentration in water;
 - temperature, acidity and alkalinity;
 - ammonium, nitrite and nitrate, if the test is performed under nitrifying conditions.

Water

25. Tap water, containing less than 3 mg/l DOC. Determine the alkalinity if not already known.
26. Deionised water, containing less than 2 mg/l DOC.

Organic medium

27. Synthetic sewage, domestic sewage or a mixture of both is permissible as the organic medium. It has been shown (11)(14) that the use of domestic sewage alone often gives increased percentage DOC removal and even allows the removal and biodegradation of some chemicals which are not biodegraded when OECD synthetic sewage is used. Also, the constant or intermittent addition of domestic sewage often stabilises the activated sludge, including the crucial ability to settle well. Thus, the use of domestic sewage is recommended. Measure the DOC or COD concentration in each new batch of organic medium. The acidity or alkalinity of the organic medium should be known. The organic medium may require the addition of a suitable buffer (sodium hydrogen carbonate or potassium dihydrogen phosphate) if it is of low acidity or alkalinity, to maintain a pH of about 7,5 ± 0,5 in the aeration vessel during the test. The amount of buffer to be added, and when to add it, has to be decided in each individual case. When mixtures are used either continuously or intermittently, the DOC (or COD) of the mixture must be kept at an approximately constant value, e.g. by dilution with water.

▼ M4*Synthetic sewage*

28. Dissolve in each litre of tap water: peptone, 160 mg; meat extract, 110 mg; urea, 30 mg; anhydrous dipotassium hydrogen phosphate (K_2HPO_4), 28 mg; sodium chloride (NaCl), 7 mg; calcium chloride dihydrate ($CaCl_2 \cdot 2H_2O$), 4 mg; magnesium sulphate heptahydrate ($Mg_2SO_4 \cdot 7H_2O$), 2 mg. This OECD synthetic sewage is an example and gives a mean DOC concentration in the influent of about 100 mg/l. Alternatively, use other compositions, with about the same DOC concentration, which are closer to real sewage. If a less concentrated influent is required, dilute the synthetic sewage, for example 1:1, with tap water to obtain a concentration of about 50 mg/l. Such a weaker influent will allow better growth of nitrifying organisms and this modification should be used if the simulation of nitrifying waste water plants is to be investigated. This synthetic sewage may be made up in distilled water in a concentrated form and stored at about 1 °C for up to one week. When needed, dilute with tap water. (This medium is unsatisfactory e.g. nitrogen concentration is very high, relatively low carbon content, but nothing better has been suggested, except to add more phosphate as buffer and extra peptone).

Domestic sewage

29. Use fresh settled sewage collected daily from a treatment works receiving predominantly domestic sewage. It should be collected, prior to primary sedimentation, from the overflow channel of the primary sedimentation tank, or from the feed to the activated sludge plant, and be largely free from coarse particles. The sewage can be used after storage for several days (but generally should not exceed seven days) at about 4 °C, if it is proved that the DOC (or COD) has not significantly decreased (i.e. by less than 20 %) during storage. In order to limit disturbances to the system, the DOC (or COD) of each new batch should be adjusted before use to an appropriate constant value, e.g. by dilution with tap water.

Activated sludge

30. Collect activated sludge for inoculation from the aeration tank of a well operated waste water treatment plant or from a laboratory — scale activated sludge unit, treating predominantly domestic sewage.

Stock solutions of test chemical

31. For chemicals of adequate solubility, prepare stock solutions at appropriate concentrations (e.g. 1 to 5 g/l) in deionised water, or in the mineral portion of the synthetic sewage. (for insoluble and volatile chemicals, see Appendix 5). Determine the DOC and total organic carbon (TOC) of the stock solution and repeat the measurements for each new batch. If the difference between the DOC and TOC is greater than 20 %, check the water-solubility of the test chemical. Compare the DOC or the concentration of the test chemical measured by specific analysis of the stock solution with the nominal value, to ascertain whether recovery is good enough (normally > 90 % can be expected). Ascertain, especially for dispersions, whether or not DOC can be used as an analytical parameter or if only an analytical technique specific for the test chemical can be used. Centrifugation of the samples is required for dispersions. For each new batch, measure the DOC, COD or the test chemical with specific analysis.

▼M4

32. Determine the pH of the stock solution. Extreme values indicate that the addition of the chemical may have an influence on the pH of the activated sludge in the test system. In this case neutralise the stock solution to obtain a pH of $7 \pm 0,5$ with small amounts of inorganic acid or base, but avoid precipitation of the test chemical.

PROCEDURE

33. The procedure is described for the activated sludge plant units; it has to be slightly adapted for the porous pot system.

Preparation of the inoculum

34. Inoculate the test system at the beginning of the test with either activated sludge or an inoculum containing a low concentration of micro-organisms. Keep the inoculum aerated at room temperature until it is used and use it within 24 h. In the first case, take a sample of activated sludge from the aeration tank of an efficiently operated biological waste water treatment plant, or a laboratory treatment plant, which receives predominantly domestic sewage. If nitrifying conditions are to be simulated, take sludge from a nitrifying waste water treatment plant. Determine the concentration of suspended solids and, if necessary, concentrate the sludge by settling so that the volume added to the test system is minimal. Ensure that the starting concentration of dry matter is about 2,5 g/l.
35. In the second case, use 2 ml/l to 10 ml/l of an effluent from a domestic biological waste water treatment plant as an inoculum. To get as many different species of bacteria as possible, it may be helpful to add inocula from various other sources, for example surface water. In this case, the activated sludge will develop and grow in the test system.

Dosage of organic medium

36. Ensure that influent and effluent containers and tubing from influent vessels and to effluent vessels are thoroughly cleaned to remove microbial growths initially and throughout the test. Assemble the test systems in a room where the temperature is controlled (normally in the range 20-25 °C) or use water-jacketed test units. Prepare a sufficient volume of the required organic medium (paragraphs 27-29). Initially fill the aeration vessel and the separator with the organic medium and add the inoculum (paragraphs 34, 35). Start the aeration such that the sludge is kept in suspension and in an aerobic state and begin dosing the influent and recycling the settled sludge. Dose organic medium out of storage vessels into the aeration vessels (paragraphs 20, 21) of the test and control units and collect the respective effluents in similar storage vessels. To get the normal hydraulic retention time of 6 h, the organic medium is pumped at 0,5 l/h. To confirm this rate, measure the daily amount of organic medium dosed by noting the reduction in volumes of the medium in the storage vessels. Other modes of dosing would be necessary for determining the effects of intermittent release and 'shock' loading of chemicals.
37. If the organic medium is prepared for use for a period longer than 1 day, cooling at about 4 °C, or other appropriate methods of conservation are necessary to prevent microbial growth and biodegradation outside the test units (paragraph 29). If synthetic sewage is used, it is possible to prepare, and store at about 4 °C, a concentrated stock solution (e.g. 10-fold the normal concentration, paragraph 28). This stock solution can be well mixed with the appropriate volume of tap water before use; alternatively, it can be pumped directly while the appropriate amount of tap water is pumped separately.

▼ **M4***Dosage of test chemical*

38. Add an appropriate volume of the stock solution of the test chemical (paragraph 31) to the storage vessel of the influent or dose it directly with a separate pump into the aeration vessel. The normal mean test concentration in the influent should be between 10 mg/l and 20 mg/l DOC, with an upper concentration of no more than 50 mg/l. If the water-solubility of the test chemical is low or if toxic effects are likely to occur, reduce the concentration to 5 mg/l DOC or even less, but only if a suitable specific analytical method is available and performed (dispersed test chemicals which are poorly soluble in water may be added using special dosing techniques, see Appendix 5).
39. Start adding the test chemical after a period in which the system has stabilised and is removing DOC of the organic medium efficiently (about 80 %). It is important to check that all units are working equally efficiently before the addition of test chemical; if they are not, it usually helps to mix the individual sludges and to re-disperse equal volumes to individual units. When an inoculum of (about) 2,5 g/l (dry weight) activated sludge is used, the test chemical may be added from the start of the test since directly adding increasing amounts from the beginning has the advantage that the activated sludge may be better able to adapt to the test chemical. In whatever manner the test chemical is added, it is recommended that the relevant flow rate and/or the volumes in the storage vessel(s) are measured at regular intervals.

Handling of activated sludge

40. The concentration of activated sludge solids normally stabilises between limits during the test, independent of the inoculum used, in the range 1 to 3 g/l (dry weight) depending on the quality and concentration of the organic medium, operating conditions, the nature of the micro-organisms present and the influence of the test chemical.
41. Either determine the suspended solids in the aeration vessels at least weekly and discard surplus sludge to maintain the concentration at 1 g/l to 3 g/l (dry weight), or control the mean sludge age at a constant value usually in the range 6 days to 10 days. If, for example, a sludge retention time of 8 days is chosen, remove daily 1/8 of the volume of the activated sludge in the aeration vessel and discard it. Carry this out on a daily basis or, preferably, by means of an automatic intermittently operating pump. Maintaining the concentration of suspended solids constant, or within narrow limits, does not maintain a constant sludge retention time (SRT), which is the operating variable that determines the value of the concentration of test chemical in the effluent.
42. Throughout the test, remove, at least daily, any sludge adhering to the walls of the aeration vessel and the separator so that it is resuspended. Check and clean regularly all tubes and tubing to prevent growth of biofilm. Recycle the settled sludge from the separator to the aeration vessel, preferably by intermittent pumping. No recycling takes place in the porous pot system but ensure that clean inner pots are inserted before the volume in the vessel rises significantly (paragraph 21).
43. Poor settlement and loss of sludge may occur in the Husmann plant units. These may be rectified by employing one or more of the actions, listed below, in parallel in test and control units:
 - fresh sludge or flocculant (for example 2 ml/vessel of 50 g/l FeCl₃) could be added at regular intervals, e.g. weekly, but ascertain that no reaction or precipitation of the test chemical occurs with FeCl₃;

▼ **M4**

- the air-lift pump could be replaced by a peristaltic pump, thus enabling a sludge recirculation flow which about equals the influent flow to be used and allowing development of an anaerobic zone in the settled sludge (the geometry of the air-lift pump limits the minimum flow rate of returned sludge to be about 12-fold that of the influent);
- sludge could be pumped intermittently from the separator to the aeration vessel (e.g. 5 min. every 2,5 h to recycle 1 l/h to 1,5 l/h);
- a non-toxic, anti-foaming agent at minimal concentration could be used to prevent loss by foaming (e.g. silicone oil);
- air could be passed through the sludge in the separator in short, shock bursts (e.g. 10 sec. every hour);
- the organic medium may be dosed at intervals into the aeration vessel (e.g. 3 min. to 10 min. every hour).

Sampling and analysis

44. At regular intervals measure the dissolved oxygen concentration, the temperature and the pH value of the activated sludge in the aeration vessels. Ensure that sufficient oxygen is always available (> 2 mg/l) and that the temperature is kept in the required range (normally 20 °C to 25 °C). Keep the pH at $7,5 \pm 0,5$ by dosing small amounts of inorganic base or acid into the aeration vessel or into the influent, or by increasing the buffering capacity of the organic medium (see paragraph 27). When nitrification occurs acid is produced, the oxidation of 1 mg N producing the equivalent of about 7 mg CO_3^- . The frequency of measuring depends on the parameter to be measured and the stability of the system, and may vary between daily and weekly measurements.
45. Measure the DOC or COD in the influents to the control and test vessels. Measure the test chemical concentration in the test influent by specific analysis or estimate it from the concentration in the stock solution (paragraph 31), the volume used and the amount of sewage dosed into the test unit. It is recommended that the concentration of the test chemical be calculated in order to reduce the variability of the concentration data.
46. Take suitable samples from the collected effluent (e.g. 24 h composites) and filter through a membrane of pore size $0,45$ μm or centrifuge them at about $40,000$ m/s^2 for about 15 min. Centrifuging should be used if filtering is difficult. Determine DOC or COD at least in duplicate to measure ultimate biodegradation and, if required, primary biodegradation by an analysis specific for the test chemical.
47. The use of COD may give rise to analytical problems at low concentrations and is therefore recommended only if a sufficiently high test concentration (about 30 mg/l) is used. Also, for strongly adsorbing chemicals, it is recommended that the amount of adsorbed chemical in the sludge be measured using an analytical technique specific for the test chemical.
48. The frequency of sampling depends on the expected duration of the test. A recommended frequency is three times per week. Once the units are operating efficiently, allow from 1 week to a maximum of 6 weeks after the test chemical has been introduced, for adaptation to reach a steady state. Preferably obtain at least 15 valid values in the plateau phase (paragraph 59), normally lasting 3 weeks, for the evaluation of the test result. The test may be completed if a sufficient degree of elimination is reached (e.g. > 90 %) and these 15 values, which represent analyses carried out each weekday over 3 weeks, are available. Normally, do not exceed a test duration of more than 12 weeks after addition of the test chemical.

▼ M4

49. If the sludge nitrifies and if the effects of the test chemical on nitrification are to be studied, analyse samples from the effluent of the test and control units at least once per week for ammonium and/or nitrite plus nitrate.
50. All analyses should be performed as soon as possible, especially the nitrogen determinations. If analyses have to be postponed, store the samples at about 4 °C in the dark in full, tightly stopped bottles. If samples have to be stored for more than 48 h, preserve them by deep-freezing, acidification (e.g. 10 ml/l of a 400 g/l solution of sulphuric acid) or by addition of a suitable toxic substance (e.g. 20 ml/l of a 10 g/l solution of mercury (II) chloride). Ensure that the preservation technique does not influence results of analysis.

Coupling of test units

51. If coupling is to be used (Appendix 3), daily exchange the same amount of activated sludge (150 ml to 1 500 ml for aeration vessels containing 3 litres of liquor) between the aeration vessels of the test unit and its control unit. If the test chemical adsorbs strongly onto the sludge, change only the supernatant of the separators. In both cases use a correction factor to calculate the test results (paragraph 55).

DATA AND REPORTING**Treatment of results**

52. Calculate the percentage of DOC or COD elimination of the test chemical for each timed assessment, using the equation:

$$D_t = \frac{C_s - (E - E_0)}{C_s} \times 100$$

where

D_t = % elimination of DOC or COD at time t

C_s = DOC or COD in the influent due to the test chemical, preferably estimated from the stock solution (mg/l)

E = measured DOC or COD value in the test effluent at time t (mg/l)

E_0 = measured DOC or COD value in the control effluent at time t (mg/l)

53. The degree of DOC or COD elimination of the organic medium in the control unit is helpful information in assessing the biodegradative activity of the activated sludge during the test. Calculate the percentage elimination from the equation:

$$D_B = \frac{C_M - E_0}{C_M} \times 100$$

where

D_B = % elimination of DOC or COD of the organic medium in the control unit at time t

C_M = DOC or COD of the organic medium in the control influent (mg/l)

▼ M4

Optionally, calculate the percentage elimination DOC or COD due to the organic medium plus test chemical in the test unit from the equation:

$$D_T = \frac{C_T - E}{C_T} \times 100$$

where

D_T = % elimination of total test influent DOC or COD

C_T = DOC or COD of total test influent or calculated from stock solutions (mg/l)

54. Calculate the removal of the test chemical if measured with a specific analytical method at each time assessment from equation:

$$D_{ST} = \frac{S_i - S_e}{S_i} \times 100$$

where

D_{ST} = % primary elimination of test chemical at time t

S_i = measured or estimated test chemical concentration in the test influent (mg/l)

S_e = measured test chemical concentration in test effluent at time t (mg/l)

55. If the coupling mode has been used, compensate the dilution of the test chemical in the aeration vessel by the sludge exchange using a correction factor (see Appendix 3). If a mean hydraulic retention time of 6 h and an exchange of half of the volume of the activated sludge in the aeration vessel have been used, the determined daily elimination values (D_t , paragraph 52) have to be corrected to obtain the true degree of elimination, D_{tc} , of the test chemical from the equation:

$$D_{tc} = \frac{4D_t - 100}{3}$$

Expression of test results

56. Plot the percentage elimination D_t (or D_{tc}) and D_{st} , if available, versus time (see Appendix 2). From the shape of the elimination curve of the test chemical (*per se* or as DOC) some conclusions may be drawn about the removal process.

Adsorption

57. If a high DOC elimination of the test chemical is observed from the beginning of the test, the test chemical is probably eliminated by adsorption onto the activated sludge solids. It is possible to prove this by determining the adsorbed test chemical by specific analysis. It is not usual for the elimination of DOC of adsorbable chemicals to remain high throughout the test; normally, there is a high degree removal initially which gradually falls to an equilibrium value. If, however, the adsorbable test chemical was able to cause acclimation of the microbial population in some way or other, the DOC elimination of the test chemical would subsequently increase and reach a high plateau value.

▼ M4*Lag phase*

58. As in static, screening tests, many test chemicals require a lag phase before full biodegradation occurs. In the lag phase, acclimation or adaptation of the degrading bacteria takes place with almost no removal of the test chemical; then the initial growth of these bacteria occurs. This phase ends and the degradation phase is taken to begin when about 10 % of the initial amount of test chemical is removed (after allowing for adsorption, if it occurs). The lag phase is often highly variable and poorly reproducible.

Plateau phase

59. The plateau phase of an elimination curve in a continuous test is defined as that phase in which the maximum degradation takes place. The plateau phase should be at least 3 weeks and have about 15 measured valid values.

Mean degree of elimination of test chemical

60. Calculate the mean value from the elimination values (D_t) of the test chemical at the plateau phase. Rounded to the nearest whole number (1 %), it is the degree of elimination of the test chemical. It is also recommended to calculate the 95 % confidence interval of the mean value.

Elimination of organic medium

61. Plot the percentage of elimination of the DOC or COD of the organic medium in the control unit (D_B) versus time. Indicate the mean degree of elimination in the same way as for the test chemical (paragraph 60).

Indication of biodegradation

62. If the test chemical does not adsorb significantly on to activated sludge and the elimination curve has a typical shape of a biodegradation curve with lag, degradation and plateau phases (paragraphs 58, 59), the measured elimination can safely be attributed to biodegradation. If a high initial removal has taken place, the simulation test cannot differentiate between biological and abiotic elimination processes. In such cases, and in other cases where there is any doubt about biodegradation (e.g. if stripping takes place), analyse adsorbed test chemicals or perform additional static biodegradation tests based on parameters clearly indicating biological processes. Such tests are the oxygen uptake methods (chapter C.4 D, E and F of this Annex (6)) or a test with measurement of carbon dioxide production (chapter C.4 C of this Annex (6)) or the ISO Headspace method (18), using a pre-exposed inoculum from the simulation test. If both the DOC removal and specific chemical removal have been measured, significant differences (the former being lower than the latter) between the percentages removed indicate the presence in the effluents of intermediate organic products which may be more difficult to degrade than the parent chemical.

Validity of test results

63. Information on the normal biodegradation behaviour of the inoculum is achieved if the degree of elimination of the organic medium (paragraph 53) in the control unit is determined. Consider the test to be valid if the degree of DOC or COD elimination in the control unit(s) is > 80 % after two weeks and no unusual observations have been made.

▼ M4

64. If a readily biodegradable (reference) chemical has been used, the degree of biodegradation (D_t , paragraph 52) should be $> 90 \%$.
65. If the test is performed under nitrifying conditions, the mean concentration in the effluents should be $< 1 \text{ mg/l}$ ammonia-N and $< 2 \text{ mg/l}$ nitrite-N.
66. If these criteria (paragraphs 63-65) are not met, repeat the test using an inoculum from a different source, test a reference chemical, and review all experimental procedures.

Test Report

67. The test report must include the following:

Test chemical:

- identification data;
- physical nature and, where relevant, physical-chemical properties.

Test conditions:

- type of test system; any modifications for testing insoluble and volatile chemicals;
- type of organic medium;
- proportion and nature of industrial waste waters in sewage, if known;
- inoculum, nature and sampling site(s), concentration and any pre-treatment;
- test chemical stock solution: DOC and TOC content; how prepared, if suspension; test concentration used; reasons if outside range of 10-20 mg/l DOC; method of addition; date first added; any changes;
- mean sludge age and mean hydraulic retention time; method of sludge wastage; methods of overcoming bulking, loss of sludge, etc.;
- analytical techniques employed;
- test temperature;
- qualities of the sludge-bulking, sludge volume index (SVI), mixed liquor suspended solids (MLSS);
- any deviations from standard procedures and any circumstances which may have affected results.

Test results:

- all measured data (DOC, COD, specific analyses, pH, temperature, oxygen concentration, suspended solids, N chemicals, if relevant);
- all calculated values of D_t (or D_{tc}), D_B , D_{St} obtained in tabular form and the elimination curves;
- information on lag and plateau phases, test duration, the degree of elimination of the test chemical and that of the organic medium in the control unit, together with statistical information and statements of biodegradability and validity of the test;
- discussion of results.

▼ **M4***LITERATURE:*

- (1) Swisher RD (1987). 'Surfactant Biodegradation', 2nd Edn. Marcel Dekker Inc. New York, 1085 pp.
- (2) German Government (1962). Ordinance of the degradability of detergents in washing and cleaning agents. Bundesgesetzblatt, Pt.1 No 49: 698-706.
- (3) Painter HA and King EF (1978a). WRc porous-pot method for assessing biodegradability. Technical Report No 70, Water Research Centre, Medmenham, UK.
- (4) Painter HA and King EF (1978b). The effect of phosphate and temperature on growth of activated sludge and on biodegradation of surfactants. Wat. Res. 12: 909-915.
- (5) Eckenfelder, W.W (19) US EPA.
- (6) Chapter C.4 of this Annex, Determination of 'Ready' Biodegradability.
- (7) Chapter C.12 of this Annex, Biodegradation — Modified SCAS Test.
- (8) Chapter C.19 of this Annex, Estimation of the Adsorption Coefficient (K_{OC}) on Soil and on Sewage Sludge Using High Performance Liquid Chromatography (HPLC).
- (9) Gerike P and Fischer WK (1979). A correlation study of biodegradability determinations with various chemicals in various tests. Ecotox. Env. Saf. 3:157-173.
- (10) Gerike P and Fischer WK (1981), as (9), II Additional results and conclusions. Ecotox. Env. Saf. 5: 45-55.
- (11) Painter HA and Bealing D (1989). Experience and data from the OECD activated sludge simulation test. pp. 113-138, In: Laboratory tests for simulation of water treatment processes. CEC Water Pollution Report 18. Eds. Jacobsen BN, Muntau H, Angeletti G.
- (12) ISO 11733 (1995; revised 2004). Evaluation of the elimination and biodegradability of organic substances in an aqueous medium — activated sludge simulation test.
- (13) Birch RR (1982). The biodegradability of alcohol ethoxylates. XIII Jornado Com. Espanol. Deterg.: 33-48.
- (14) Birch RR (1984). Biodegradation of nonionic surfactants. J.A.O.C.S. 61 (2): 340-343.
- (15) Gerike P, Fischer WK and Holtmann W (1980). Biodegradability determinations in trickling filter units compared with the OECD confirmatory test. Wat.Res. 14: 753-758.
- (16) Baumann U, Kuhn G and Benz M. (1998). Einfache Versuchsanordnung zur Gewinnung gewässerökologisch relevanter Daten, UWSF — Z. Umweltchem. Ökotox. 10: 214-220.
- (17) Her Majesty's Stationery Office (1982). Assessment of biodegradability. Methods for the examination of waters and associated materials. pp. 91-98 ISBN 0117516619.
- (18) ISO 14593 (1998). Water Quality — Evaluation in an aqueous medium of the ultimate biodegradability of organic compounds. Method by the analysis of inorganic carbon in sealed vessels.

▼ **M4***Appendix 1**Figure 1***Equipment used for assessment of biodegradability**

Husmann unit

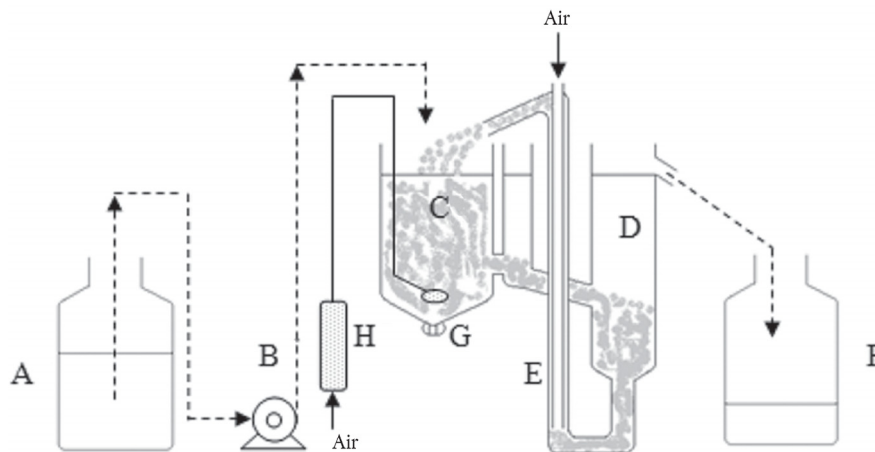

- | | |
|-----------------------------------|----------------------|
| A. Storage vessel | E. Air lift pump |
| B. Dosing pump | F. Collection vessel |
| C. Aeration chamber (3l capacity) | G. Aerator |
| D. Settling vessel | H. Air flow meter |

*Figure 2***Equipment used for assessment of biodegradability**

Porous pot

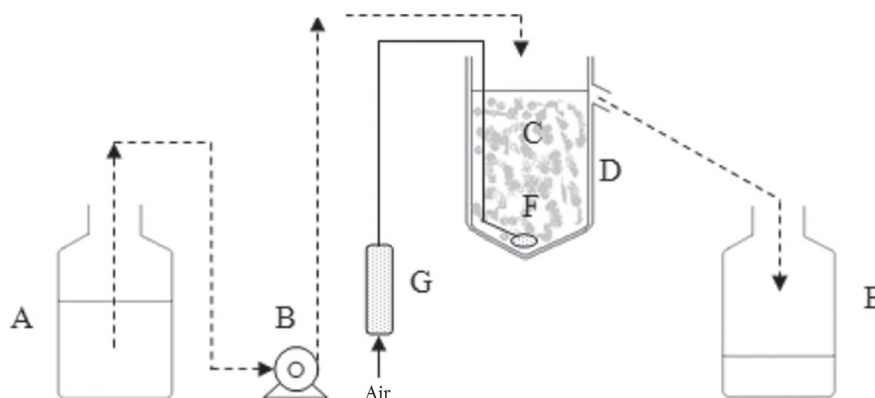

- | | |
|-----------------------------|----------------------|
| A. Storage vessel | E. Collection vessel |
| B. Dosing pump | F. Diffuser |
| C. Porous aeration vessel | G. Air flow meter |
| D. Outer impermeable vessel | |

▼ **M4**

Figure 3

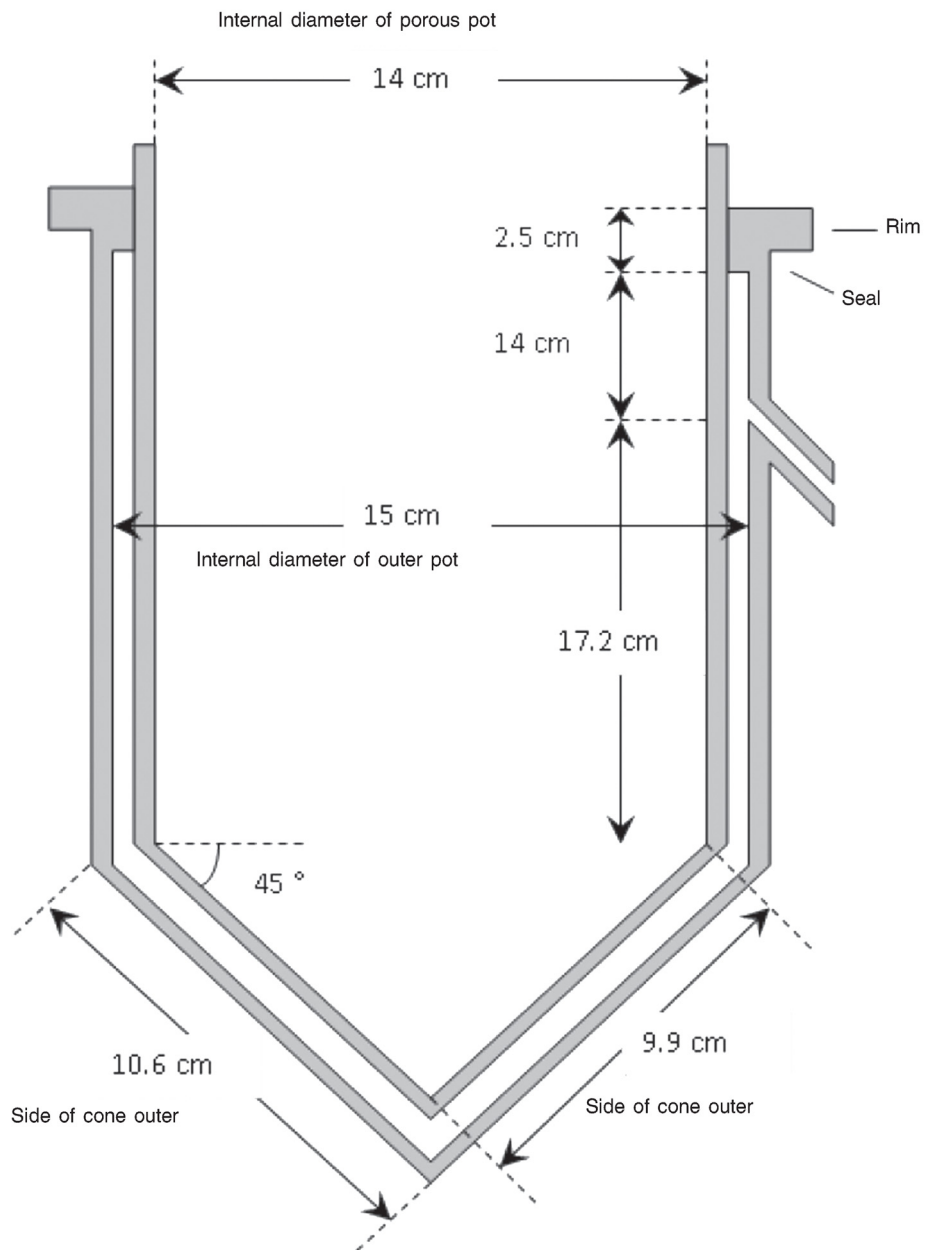
Details of 3 litre porous pot aeration vessel

▼ M4

Appendix 2

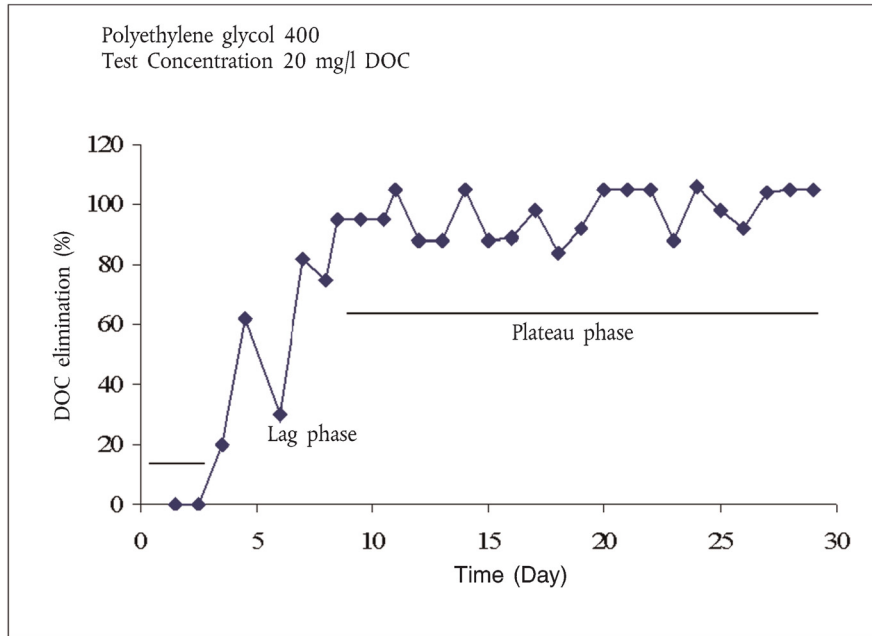
Example of an elimination curve

▼ **M4***Appendix 3*

[INFORMATIVE]

COUPLING OF THE TEST UNITS

In order to try to equalise the microbial populations in sludges in a test unit, receiving sewage plus a test chemical, and in a control unit, receiving only sewage, a daily interchange of sludge was introduced (1). The procedure was called coupling and the method is known as coupled units. Coupling was initially performed using Husmann activated sludge units but it has also been done with Porous Pot units (2)(3). No significant differences in results were found as between non-coupled and coupled units, whether Husmann or Porous Pot so there is no advantage in expending the time and energy needed in coupling the units.

Sludge exchanges can give the appearance of quite a considerable removal, since some of the test chemical is transferred and the concentrations of test chemical in the test and control effluents become more nearly equal. Thus, correcting factors have to be used, which depend on the fraction exchanged and the mean hydraulic retention time. More details of the calculation have been published (1).

Calculate the corrected DOC or COD elimination degree using the general formula:

$$D_{tc} = (D_t - 100 \cdot a \cdot r/12)/(1 - a \cdot r/12) \%$$

where

D_{tc} = corrected % DOC or COD elimination

D_t = determined % DOC or COD elimination

a = interchange fraction of the volume of the activated sludge units

r = mean hydraulic retention time (h)

If, for example, half of the volume of the aeration tank is exchanged ($a = 0,5$) and the mean hydraulic retention time is 6 h, the correction formula is:

$$D_{tc} = \frac{4D_t - 100}{3}$$

LITERATURE:

- (1) Fischer W, Gerike P, Holtmann W (1975). Biodegradability Determinations via Unspecific Analyses (Chemical Oxygen Demand, DOC) in Coupled Units of the OECD Confirmatory Test. I The test. *Wat. Res.* 9: 1131-1135.
- (2) Painter HA, Bealing DJ (1989). Experience and Data from the OECD Activated Sludge Simulation Test. pp. 113-138. In: *Laboratory Tests for Simulation of Water Treatment Processes* CEC Water Pollution Report 18. Eds. Jacobsen BN, Muntau H, Angeletti G.
- (3) Painter HA, King EF (1978). Water Research Centre Porous Pot Method for Assessing Biodegradability. Technical Report TR70, Water Research Centre, Stevenage, UK.

▼ **M4***Appendix 4*

EVALUATION OF INHIBITION OF THE ACTIVATED SLUDGE

Process by test chemicals

1. A chemical (or a waste water) may not be degraded or removed in the simulation test and may even have an inhibitory effect on the sludge micro-organisms. Other chemicals are biodegraded at low concentrations but are inhibitory at higher concentration (hormesis). Inhibitory effects may have been revealed at an earlier stage or may be determined by applying a toxicity test, using an inoculum similar to or identical with that used in the simulation test (1). Such methods are inhibition of oxygen uptake (chapter C.11 of this Annex (2) and ISO 8192(3)) or inhibition of growth of sludge organisms (ISO 15522 (4)).
2. In the simulation test any inhibition will be manifest by the difference in dissolved organic carbon (DOC) or chemical oxygen demand COD between the effluent from the test vessel and that from the control being greater than the DOC added as test chemical. Expressed in another way, the percentage removal of DOC (and biochemical oxygen demand BOD, chemical oxygen demand COD, and/or NH_4^+) of the organic medium on treatment will be decreased by the presence of the test chemical. If this occurs, the test should be repeated reducing the concentration of the test chemical until a level is reached at which no inhibition occurs and perhaps further reducing the concentration until the test chemical is biodegraded. However, if the test chemical (or waste water) has adverse effects on the process at all concentrations tested, the indications are that the chemical is difficult, if not impossible, to treat biologically, but it may be worth repeating the test with activated sludge from a different source and/or subjecting the sludge to a more gradual acclimation.
3. Conversely, if the test chemical is bioeliminated at the first attempt in the simulation test, its concentration should be increased if it is required to be known whether the chemical could be inhibitory.
4. It should be remembered in trying to determine degrees of inhibition that the activated sludge population can change, so that with time the micro-organisms may develop a tolerance towards an inhibitory chemical.
5. Calculation of degree of inhibition:

The overall percentage removals R_o , of BOD, DOC, COD etc., for the test and control units can be calculated from:

$$R_o = 100 (I - E)/I\%$$

where:

I = influent concentration of BOD, DOC, COD etc., for test or control vessels (mg/l)

E = respective effluent concentrations (mg/l).

I and E must be corrected for the DOC due to the test chemical in the test units, otherwise the calculations of percentage inhibition will be incorrect.

▼ M4

The degree of inhibition caused by the presence of the test chemical can be calculated from:

$$\% \text{ inhibition} = 100 (R_c - R_t)/R_c$$

where:

R_c = percentage removal in the control vessels

R_t = percentage removal in the test vessels

LITERATURE:

- (1) Reynolds L et al. (1987). Evaluation of the toxicity of substances to be assessed for biodegradability. *Chemosphere* 16: 2259.
- (2) Chapter C.11 of this Annex, Biodegradation — Activated Sludge Respiration Inhibition Test.
- (3) ISO 8192 (2007) Water quality — Test for inhibition of oxygen consumption by activated sludge for carbonaceous and ammonium oxidation.
- (4) ISO 15522 (1999) Water Quality — Determination of the inhibitory effect of water constituents on activated sludge microorganisms.

▼ M4*Appendix 5***Poorly water-soluble test chemicals — volatile chemicals****Poorly water-soluble chemicals**

Few reports seem to have been published on subjecting poorly water-soluble and insoluble chemicals to tests simulating waste water treatment (1)(2)(3).

There is no single method of dispersal of the test chemical which is applicable to all insoluble chemicals. Two of the four types of method described in ISO 10634 (4) would seem to be suitable for attempting to disperse test chemicals for simulation testing; they are the use of emulsifying agents and/or of ultrasonic energy. The stability over at least 24h periods of the resulting dispersion should be established. Suitably stabilised dispersions, contained in a constantly stirred reservoir (paragraph 38), would then be dosed to the aeration tank separately from the domestic (or synthetic) sewage.

If the dispersions are stable, investigate how the test chemical can be determined in the dispersed form. It is unlikely that DOC will be suitable, so that a specific analytical method for the test chemical would have to be established which could be applied to effluents, effluent solids and activated sludge. The fate of the test chemical in the simulation of the activated sludge process would then be determined in liquid and solid phases. Thus, a 'mass balance' would be established to decide whether the test chemical had been biodegraded. However, this would indicate only primary biodegradation. Demonstration of ultimate biodegradation should be attempted by applying a respirometric test for ready biodegradability (chapter C.4 of this Annex (5) C, F or D) using as inoculum sludge exposed to the test chemical in the simulation test.

Volatile chemicals

The application of waste water treatment simulations to volatile chemicals is both debatable and problematic. As with poorly water-soluble test chemicals, very few reports seem to have been published describing simulation tests using volatile chemicals. A conventional type of complete-mixing apparatus is adapted by sealing the aeration and settling tanks, measuring and controlling the air flow using flow-meters and passing the exit gas through traps to collect volatile organic matter. In some cases, a vacuum pump is used to draw the exit gas through a 'cold' trap or a purge-trap containing Tenax and silica gel for gas-chromatographic analyses. The test chemical present in the trap can be determined analytically.

The test is carried out in two parts. The units are first operated without sludge but with the synthetic waste water plus test chemical being pumped into the aeration tank. Influent, effluent and exit gas samples are collected and analysed for the test chemical for a few days. From the data collected, the percentage (R_{vs}) of the test chemical stripped from the system may be calculated.

Then the normal biological test (with sludge) is performed under operating conditions identical to those in the stripping study. DOC or COD measurements are also made to check that the units are performing efficiently. Occasional analyses are made to determine the test chemical in the influent, effluent and exit gas in the first part of the test; after acclimation more frequent analyses are made. Again, from the data in the steady state, the percentage of removal of the test chemical from the liquid phase by all processes (R_T) (physical and biological) may be calculated, as well as the proportion (R_V) stripped from the system.

▼ M4

Calculation:

- (a) In the non-biological test, the percentage (R_{VP}) of the test material stripped from the system may be calculated from:

$$R_{VP} = \frac{S_{VP}}{S_{IP}} \cdot 100$$

where

R_{VP} = removal of test chemical by volatilisation (%),

S_{VP} = test chemical collected in trap expressed as equivalent concentration in liquid phase (mg/l),

S_{IP} = test chemical concentration in influent (mg/l).

- (b) In the biological test, the percentage (R_V) of the test material stripped from the system may be calculated from:

$$R_V = \frac{S_V}{S_I} \cdot 100$$

where

R_V = removal of test chemical by volatilisation in biological test (%),

S_V = test chemical collected in trap in biological test, expressed as equivalent concentration in liquid influent (mg/l),

S_I = test chemical concentration in influent (mg/l).

- (c) In the biological test, the percentage (R_T) of the test chemical removed by all processes is given by:

$$R_T = 1 - \frac{S_E}{S_I} \cdot 100$$

where

S_E = concentration of test chemical in the (liquid) effluent (mg/l).

- (d) Thus, the percentage (R_{BA}) removed by biodegradation plus adsorption can be calculated from:

$$R_{BA} = (R_T - R_V)$$

Separate tests should be carried out to determine whether the test chemical is adsorbed; if it is, then a further correction may be made.

- (e) A comparison between the proportion of test chemical stripped from the biological (R_V) and non-biological test (R_{VP}) systems indicates the overall effect that biological treatment has had on the emission of the test chemical into the atmosphere.

Example: Benzene

Sludge retention time = 4 days

A synthetic sewage; retention time = 8 h.

$S_{IP} = S_I = 150$ mg/l

$S_{VP} = 150$ mg/l ($S_{EP} = 0$)

$S_V = 22,5$ mg/l

$S_E = 50$ µg/l

▼ M4

Thus,

$$R_{VP} = 100, R_V = 15$$

$$R_T = 100 \text{ and } R_{BA} = 85.$$

Benzene was assumed not to be adsorbed onto sludge.

LITERATURE:

- (1) Horn JA, Moyer JE, Hale JH (1970). Biological degradation of tertiary butyl alcohol. Proc. 25th Ind. Wastes Conference Purdue Univ.: 939-854.
- (2) Pitter P, Chudoba J (1990). Biodegradability of organic substances in the aquatic environment. CRC Press. Boston, USA.
- (3) Stover EL, Kincannon DF (1983). Biological treatability of specific organic compounds found in chemical industry waste waters. J. Wat. Pollut. Control Fed. 55: 97.
- (4) ISO 10634 (1995) Water Quality — Guidance for the preparation and treatment of poorly water-soluble organic compounds for the subsequent evaluation of their biodegradability in an aqueous medium.
- (5) Chapter C.4 of this Annex, Determination of 'Ready' Biodegradability.

▼ **M4***Appendix 6***Effects of sludge retention time (SRT) on treatability of chemicals**

INTRODUCTION

1. The method described in the main text was designed to ascertain whether the chemicals tested (usually those known to be inherently, but not readily, biodegradable) can be biodegraded within the limits imposed in waste water treatment plants. The results are expressed in terms of percentage removal and percentage biodegradation. The conditions of operation of the activated sludge units and choice of influent allow rather wide variations in concentration of the test chemical in the effluent. Tests are carried out at only one nominal concentration of sludge solids or one nominal sludge retention time (SRT) and the sludge wastage regimes described can cause the value of SRT to vary considerably during the test, both from day to day and during a day.
2. In this variant (1)(2) the SRT is controlled within much narrower limits throughout each 24h period (just as happens on the large-scale) which results in a more constant concentration in effluents. Domestic sewage is recommended since it gives more consistent and higher percentage removals. Also, the effects of a number of SRT values are investigated and in a more detailed study the effects of a range of temperatures on effluent concentration may be determined.
3. There is no general agreement yet on which kinetic models operate when chemicals bio-degrade under conditions in waste water treatment. The Monod model of bacterial growth and substrate utilisation was chosen (1)(2) to be applied to the data collected, since the method was intended to be applied only to chemicals produced in high tonnages, resulting in concentrations in sewage of above 1 mg/l. The validity of the simplified model and the assumptions made was established using a series of alcohol ethoxylates having varying degrees of primary biodegradability (2)(3).

Note: This variant method follows closely much of the text of this test method C.10-A and only those details which differ are given hereafter.

PRINCIPLE OF THE TEST

4. Activated sludge porous-pot units, designed to facilitate the (almost) continuous wastage of mixed liquor allowing very precise control of the sludge retention time (SRT, or θ_s), are operated in the non-coupled mode over a range of SRTs and, optionally, over a range of temperatures. The retention time is usually 2 to 10 days and the temperature between 5 and 20 °C. Sewage, preferably domestic, and a solution of the test chemical are dosed separately to the units at rates to give the required sewage retention time (3 to 6 hours) and the required concentration of test chemical in the influent. Control units receiving no test chemical are operated in parallel for comparative purposes.
5. Other types of apparatus can be used but great care should be exercised to ensure that good control of SRT is achieved. For example, when using plants, which incorporate a settler, allowance for loss of solids via the plant effluent may be necessary. Further, special precautions to avoid errors due to variation in the quantity of sludge in the settler should also be taken.

▼M4

6. The units are operated at each selected set of conditions and, after equilibrium has been reached, the average steady state concentrations in the effluents of test chemical and, optionally, DOC are obtained over a period of about three weeks. Besides assessing the percentage removal of test chemical and, optionally, DOC, the relationship between plant-operating conditions and the concentration in the effluent is expressed in graphical form. From this tentative kinetic constants may be calculated and the conditions under which the test chemical can be treated may be predicted.

INFORMATION ON THE TEST CHEMICAL

7. Chapter C.10 A, paragraphs 12 and 13 apply.

PASS LEVELS

8. Chapter C.10 A, paragraphs 14 and 15 apply.

REFERENCE TEST CHEMICAL

9. Chapter C.10 A, paragraph 16 applies.

REPRODUCIBILITY OF TEST RESULTS

10. Chapter C.10 A, paragraphs 17 and 18 apply.

DESCRIPTION OF THE METHOD

Apparatus

11. A suitable unit is the modified porous pot system (Appendix 6.1). It consists of an inner vessel (or liner) constructed from porous polypropylene of 3,2 mm thickness and pore size of approximately 90 µm, the joint being butt-welded. (This makes a more robust unit than that described in paragraph 21 of this chapter, C.10 A). The liner is fitted into an impervious polyethylene outer vessel, which consists of two parts: a circular base in which holes are bored to accommodate two air lines and a sludge-wastage line, and an upper cylinder which screws on to the base and which has an outlet placed so as to give a known volume (3 l) in the porous pot vessel. One of the air lines is fitted with a diffuser stone and the other is open-ended and set at right-angles to the stone in the pot. This system produces the necessary turbulence to ensure that the contents of the pot are completely mixed, as well as providing concentrations of dissolved oxygen greater than 2 mg/l.
12. The appropriate number of units are maintained at controlled temperatures in the range of 5 to 20 °C (± 1 °C), either in water baths or in constant temperature rooms. Pumps are required to dose to the aeration vessels the solution of the test chemical and settled sewage at the required rates (0-1,0 ml/min and 0-25 ml/min, respectively) and a third pump to remove waste sludge from the aeration vessels. The necessary very low flow-rate of waste sludge is achieved by using a pump set at a higher rate and operated intermittently by the use of a timer-switch, e.g. operating for 10 seconds per min, pump delivery rate of 3ml/min yielding a wastage rate of 0,5 ml/min.

Filtration apparatus or centrifuge

13. Chapter C10 A, paragraph 23 applies.

Analytical equipment

14. Chapter C.10 A, paragraph 24 applies.

Water

▼M4

15. Chapter C.10 A, paragraphs 25 and 26 apply.

Organic medium

16. Chapter C.10 A, paragraph 27 applies.

Synthetic sewage

17. Chapter C.10 A, paragraph 28 applies.

Domestic sewage

18. Chapter C.10 A, paragraph 29 applies.

Activated sludge

19. Chapter C.10 A, paragraph 30 applies.

Stock solutions of test chemical

20. Chapter C.10 A, paragraphs 31 and 32 apply.

PROCEDURE

Preparation of the inoculum

21. Chapter C.10 A, paragraph 34 applies only — use activated sludge (about 2,5 g/l).

Number of test units

22. For a simple test, ie. to measure percentage removal, only a single SRT is required, but in order to acquire data necessary to calculate tentative kinetic constants 4 or 5 SRT values are required. Values between 2 and 10 days are usually chosen. Practically, it is convenient to perform a test at 4 or 5 SRTs simultaneously at one temperature; in extended studies the same SRT values, or perhaps a different range of values, are used at other temperatures within the range 5 to 20 °C. For primary biodegradation (the main use), only one unit per set of conditions is normally required. However, for ultimate biodegradability a control unit is required, for each set of conditions, which receives sewage but not test chemical. If the test chemical is thought to be present in the sewage used, it would be necessary to use control units when assessing primary biodegradation, and making the necessary correction in the calculations.

Dosage of organic medium and test chemical

23. Chapter C.10 A, paragraphs 36 to 39 apply, but note that the test chemical solution is dosed separately and that various sludge wastage rates are used. Also monitor and adjust, if necessary, to within $\pm 10\%$, the flow-rates of influents, effluents and sludge wastage frequently, e.g. twice per day. If difficulties are encountered in the analytical methods when domestic sewage is used, carry out the test with synthetic sewage, but it must be assured that different media give comparable kinetic data.

Handling of activated sludge units

24. Chapter C.10 A, paragraphs 40 to 43 apply, but control SRT only by 'constant' wastage of sludge.

Sampling and analysis

25. Chapter C.10 A, paragraphs 44 to 50 apply, except that the concentration of the test chemical is to be determined and DOC determined optionally; COD should not be used.

▼M4**DATA AND REPORTING****Treatment of results**

26. Chapter C.10 A, paragraphs 52 to 54 apply.

Expression of test results

27. Chapter C.10 A, paragraphs 56 to 62 apply.

Calculation of kinetic constants

28. It is more realistic to quote the mean steady — state concentration of the test chemical in the effluent and to describe how this varies with plant-operating conditions than to quote percentage primary biodegradation. This can be done by consideration of equation (6) in Appendix 6.2, which can yield values for K_S , μ_m and θ_{SC} , the critical sludge retention time.

(Alternatively, approximate values of K_S and μ_m may be obtained using a simple computer program to fit the theoretical curve calculated from equation 2 (Appendix 6.2) to the experimental values obtained. Although any given solution will not be unique, a reasonable approximation of K_S and μ_m can be obtained.)

Variability of results

29. It is common experience that variable values of kinetic parameters for individual chemicals are obtained. It is thought that the conditions under which the sludge has been grown, as well as the conditions prevailing in the test used (as in paragraph 5 and in other tests), have a large effect on the resulting values. One aspect of this variability has been discussed by Grady et al (4), who have suggested that the terms 'extant' and 'intrinsic' should be applied to two extreme conditions representing the limits of physiological state a culture may attain during a kinetic experiment. If the state is not allowed to change during the test, the kinetic parameter values reflect the conditions in the environment from which the micro-organisms were taken; these values are called 'extant' or currently existing. At the other extreme, if conditions in the test are such as to permit the full development of the protein-synthesizing system allowing maximum possible growth rate, the kinetic parameters obtained are said to be 'intrinsic', and are dependent only on the nature of the substrate and the types of bacteria in the culture. As a guide, extant values will be obtained by keeping the ratio of concentration of substrate to competent micro-organisms (S_o/X_o) low, e.g. 0,025, and intrinsic values arise when the ratio is high e.g. at least 20. In both cases, S_o should equal or exceed the relevant value of K_S , the half-saturation constant.
30. Variability and other facets of biodegradation kinetics were discussed at a recent SETAC workshop (5). From such studies, reported and projected, a clearer view of kinetics operating in waste water treatment plants should be forthcoming to enable a better interpretation of existing data to be made, as well as to suggest more relevant designs for future Test Methods.

LITERATURE:

- (1) Birch RR (1982). The biodegradability of alcohol ethoxylates. XIII Jornado Com. Espanol Deterg.: 33-48.
- (2) Birch RR (1984). Biodegradation of nonionic surfactants. J.A.O.C.S., 61(2): 340-343.
- (3) Birch RR (1991). Prediction of the fate of detergent chemicals during sewage treatment. J. Chem. Tech. Biotechnol., 50: 411-422.

▼M4

- (4) Grady CPL, Smets BF and Barbeau DS (1996). Variability in kinetic parameter estimates: A review of possible causes and a proposed terminology. *Wat. Res.*, 30 (3): 742-748.
- (5) Biodegradation kinetics: Generation and use of data for regulatory decision making (1997). Workshop at Port Sunlight, UK. Eds. Hales SG, Feitjel T, King H, Fox K, Verstraete W. 4-6th Sept. 1996. SETAC- Europe, Brussels.

▼ **M4**

Appendix 6.1

Porous Pot with SRT Control

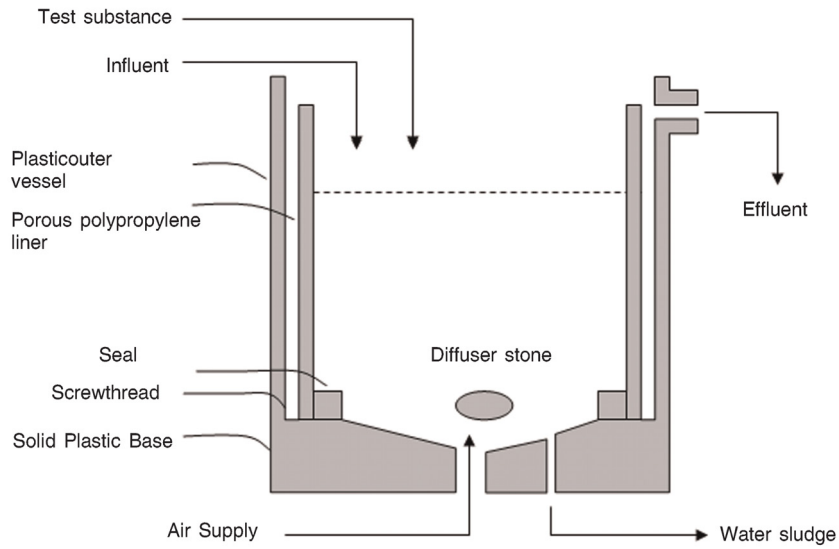

▼ **M4***Appendix 6.2***Calculation of Kinetic Constants**

1. By assuming Monod kinetics apply and considering a mass balance of active solids and substrate across the activated sludge system (1), the following steady state expressions can be obtained:

$$\frac{1}{\theta_s} = \frac{\mu_m \cdot S_1}{K_s + S_1} - K_d \quad [1]$$

or

$$S_1 = \frac{K_s \cdot (1 + K_d \cdot \theta_s)}{\theta_s \cdot (\mu_m - K_d) - 1} \quad [2]$$

where:

S_1 = concentration of substrate in effluent, (mg/l)

K_s = half-saturation constant, the concentration at which $\mu = \mu_m/2$ (mg/l)

μ = specific growth rate (d^{-1})

μ_m = maximum value of μ_m (d^{-1})

K_d = specific decay rate of active solids (d^{-1})

θ_s = sludge mean retention time, SRT (d)

Examination of this equation leads to the following conclusions:

- (i) The effluent concentration is independent of that in the influent (S_0); hence, the percentage biodegradation varies with the influent concentration, S_0 .
- (ii) The only plant-control parameter affecting S_1 is the sludge retention time, θ_s .
- (iii) For a given concentration in the influent, S_0 , there will be a critical sludge retention time, such that:

$$\frac{1}{\theta_{SC}} = \frac{\mu_s \cdot S_0}{K_s + S_0} - K_d \quad [3]$$

where:

θ_{SC} = critical sludge retention time, below which the competent micro-organisms will be washed out of the plant.

- (iv) Since the other parameters in equation (2) are associated with growth kinetics, temperature is likely to affect the effluent substrate level and the critical sludge age, ie. the sludge retention time needed to obtain a certain degree of treatment would increase with decreasing temperature.

2. From a mass balance of solids in the porous pot system, and assuming that the solids concentration in the plant effluent, X_2 is low compared with that in the aeration vessel, X_1 , the sludge retention time

$$\theta_s = \frac{V \cdot X_1}{(Q_0 - Q_1) \cdot X_2 + Q_1 \cdot X_1} \quad [4]$$

▼ M4

and

$$\theta_s = \frac{V \cdot X_1}{Q_1 \cdot X_1} = \frac{V}{Q_1}$$

where:

V = volume of the aeration vessel (l)

X₁ = concentration of solids in aeration vessel (mg/l)

X₂ = concentration of solids in effluent (mg/l)

Q₀ = flow rate of influent (l/d)

Q₁ = flow rate of waste sludge (l/d)

Thus, it is possible to control the sludge retention time at any pre-selected value by the control of the waste sludge flow rate, Q₁.

Conclusions:

3. The main purpose of the test is thus to allow the effluent concentration, and hence the levels of test chemical in the receiving waters, to be predicted.
4. By plotting S₁, vs. θ_s, the critical sludge retention time, θ_{SC}, can sometimes be readily evaluated, eg. curve 3 in Figure 1. When this is not possible, θ_{SC} may be calculated, together with approximate values of μ_m and K_s, by plotting S₁, vs. S₁•θ_s.

Rearrangement of equation (1) gives

$$\frac{S_1 \cdot \theta_s}{1 + \theta_s \cdot K_d} = \frac{K_s}{\mu_m} + \frac{S_1}{\mu_m} \quad [5]$$

If K_d is small, then 1 + θ_s · K_d ~ 1 and [5] becomes:

$$S_1 \cdot \theta_s = \frac{K_s}{\mu_m} + \frac{S_1}{\mu_m} \quad [6]$$

Thus, the plot should be a straight line (see Figure 2) of slope 1/μ_m and intercept K_s/μ_m; also θ_s ~ 1/μ_m.

▼ **M4**

Figure 1
 Three temperatures; five SRTs

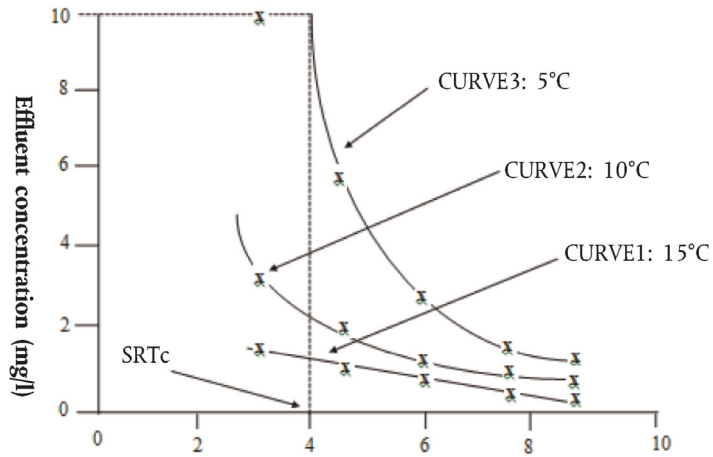
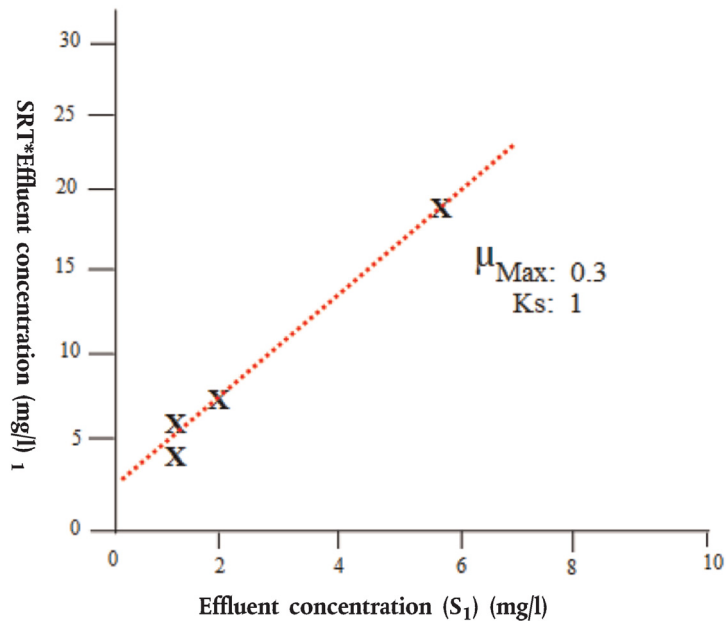

Figure 2
 Regression Line SRT · S1 vs S1 at T = 5 °C



Glossary:

Effluent concentration:

Curve:

▼ M4*Appendix 7*TEST AT LOW ($\mu\text{g/l}$) CONCENTRATION RANGE

1. Many chemicals are normally present in the aquatic environment, even in waste waters, at very low concentrations ($\mu\text{g/l}$). At such concentrations, they probably do not serve as primary substrates resulting in growth, but are more likely to degrade as non-growth, secondary substrates, concurrent with a variety of naturally occurring carbon chemicals. Consequently the degradations of such chemicals will not fit the model described in Appendix 6. There are many models which could be applied and, under the conditions prevailing in waste water treatment systems, more than one may be simultaneously operative. Far more research will be necessary to elucidate this problem.
2. Meanwhile the procedure given in the main text (chapter C.10 A) can be followed, but only for primary biodegradability, using suitably low concentrations ($< 100 \mu\text{g/l}$) and a validated analytical procedure. The percentage biodegradation may be calculated (see para. 54 of the Test Method) provided that abiotic processes (adsorption, volatility, etc.) are taken into account. An example is the study by Nyholm and his associates (1)(2) using a 4 h cycle in a fill and draw system. They reported pseudo first-order constants for 5 chemicals added in a synthetic sewage at 5 to $100 \mu\text{g/l}$. (For ultimate biodegradability ^{14}C -labelled test chemicals may be used. A description of this is beyond the scope of this Test Method since there are as yet no agreed procedures, though a proposed method for ISO 14592 (3) contains guidance on the use of ^{14}C -labelled chemicals.

SCAS test

3. Later, a simpler two-stage test was proposed (4)(5)(6); the semi-continuous activated sludge (SCAS) method is followed by short-term kinetic tests on samples withdrawn from the SCAS units. The SCAS system is operated with known sludge wastage rates (unlike the original C.12 test method) and is fed a modified OECD synthetic sewage or domestic sewage. The synthetic sewage was modified (because of changing pH value and poor sludge settleability) by addition of phosphate as buffer, yeast extract, iron (III) chloride and trace element salts, and its COD was increased to about 750 mg/l by increasing the concentration of peptone and meat extract. The units were operated on a 24 h cycle: aeration for 23 h, wastage of sludge, settlement, withdrawal of supernatant (effluent) followed by addition of synthetic sewage plus test chemical, up to $100 \mu\text{g/l}$, (i.e. at about the same concentration used in the short term test). Once per week 10 % of the total sludge was replaced by fresh sludge in order to maintain a balanced microbial population.
4. The concentrations of test chemical initially and at the end of aeration are measured and the test is continued until a constant removal of test chemical is attained; this takes from one week to several months.

Short-term test

5. A short test (e.g. 8 hours) is applied to determine the (pseudo) first order kinetic rate constant for the decay of the test chemical in activated sludge of known but different origins and histories. In particular, sludge samples are taken from the SCAS reactors — at the end of an aeration period when the concentration of organic substrate is low — during the course of an acclimatisation experiment (paragraphs 3, 4). Sludge may also be taken from a

▼ M4

parallel SCAS unit not exposed to the test chemical, for comparison. Mixtures of sludge and the test chemical added at two or more concentrations in the range 1-50 µg/l are aerated, without the addition of synthetic sewage or other organic substrate. The test chemical remaining in solution is determined at regular intervals e.g. hourly depending on the degradability of the chemical, for a period not longer than 24h. Samples are centrifuged before appropriate analysis.

Calculations

6. Data from the SCAS units are used to calculate the percentage removal of test chemical (paragraph 54). Also, an average rate constant, K_1 , (normalised for concentration of suspended solids) can be calculated from:

$$K_1 = 1/t \cdot \ln \frac{C_e}{C_i} \cdot 1/SS(1/g \text{ h})$$

where:

t = aeration time (23h)

C_e = concentration at end of aeration period (µg/l)

C_i = concentration at beginning of aeration (µg/l)

SS = concentration of activated sludge solids (g/l)

7. In the short term test the log % concentration remaining is plotted against time and the slope of the initial part (10-50 % degradation) of the plot is equivalent to K_1 , the (pseudo) first order constant. The constant is normalised with respect to the concentration of sludge solids by dividing the slope by the concentration of sludge solids. The reported result must also include details of initial concentrations of the test chemical and suspended solids, sludge retention time, sludge loading and source, and details of pre-exposure (if any) to the test chemical.

Variability of results

8. Variability and other facets of biodegradation kinetics were discussed at a recent SETAC workshop (7). From such studies, reported and projected, a clearer view of kinetics operating in waste water treatment plants should be forth-coming to enable a better interpretation of existing data to be made, as well as to suggest more relevant designs for future Test Methods.

LITERATURE:

- (1) Nyholm N, Jacobsen BN, Pedersen BM, Poulsen O, Dambourg A and Schultz B (1992). Removal of micropollutants in laboratory activated sludge reactors. Biodegradability. Wat. Res. 26: 339-353.
- (2) Jacobsen BN, Nyholm N, Pedersen BM, Poulsen O, and Ostfeldt P (1993). Removal of organic micropollutants in laboratory activated sludge reactors under various operating conditions: Sorption. Wat. Res. 27: 1505-1510.
- (3) ISO 14592 (ISO/TC 147/SC5/WG4, N264) (1998). Water Quality — Evaluation of the aerobic biodegradability of organic compounds at low concentrations in water.

▼ M4

- (4) Nyholm N, Ingerslev F, Berg UT, Pedersen JP and Frimer-Larsen H (1996). Estimation of kinetic rate constants for biodegradation of chemicals in activated sludge waste water treatment plants using short-term batch experiments and $\mu\text{g/l}$ range spiked concentrations *Chemosphere* 33 (5): 851-864.
- (5) Berg UT and Nyholm N (1996). Biodegradability simulation Studies in semi-continuous activated sludge reactors with low ($\mu\text{g/l}$ range) and standard (ppm range) chemical concentrations. *Chemosphere* 33 (4): 711-735.
- (6) Danish Environmental Protection Agency. (1996). Activated sludge biodegradability simulation test. Environmental Project, No 337. Nyholm, N. Berg, UT. Ingerslev, F. Min. of Env. and Energy, Copenhagen.
- (7) Biodegradation kinetics: Generation and use of data for regulatory decision making (1997). Workshop at Port Sunlight, UK. Eds. Hales, SG. Feitjel, T. King, H. Fox, K. and Verstraete, W. 4-6th Sept. 1996. SETAC- Europe, Brussels.

▼ M4**C.10-B: Biofilms**

INTRODUCTION

1. Simulation tests are normally applied to chemicals which have failed a screening test for ready biodegradability (Chapter C.4 A to F of this Annex (9)), but have passed a test for inherent biodegradability. Exceptionally simulation tests are also applied to any chemical about which more information is required, especially high-tonnage chemicals, and normally the activated sludge test is applied (C.10 A). In some circumstances, however, specific information is required relating the behaviour of a chemical to methods of waste water treatment involving biofilms, namely, percolating or trickling filters, rotating biological contactors, fluidised beds. To meet this need various devices have been developed.
2. Gerike *et al.* (1) used large, pilot-scale trickling filters which they used in the coupled mode. These filters took up much space and required relatively large volumes of sewage or synthetic sewage. Truesdale *et al.* (2) described smaller filters (6 ft × 6 in. diameter) which were fed surfactant-free natural sewage but still required rather large volumes. As many as 14 weeks were required for the development of a 'mature' biofilm and an additional 4-8 weeks were needed after first introduction of the test surfactant before acclimatisation took place.
3. Baumann *et al.* (3) developed a much smaller filter which used polyester 'fleece' previously steeped in activated sludge as the inert medium supporting the biofilm. The test chemical was used as the sole source of carbon and biodegradability was assessed from measurements of dissolved organic carbon (DOC) in the influent and effluent, and from the amount of CO₂ in the exit gas.
4. A quite different approach was made by Gloyna *et al.* (4) who invented the rotating tubular reactor. On the internal surface of the rotating tube a biofilm was grown on the known surface area by passage of influent introduced at the top end of the tube, inclined at a small angle to the horizontal. The reactor has been used to study the biodegradability of surfactants (5), as well as to investigate the optimal thickness of biofilm and diffusion through the film (6). These latter authors further developed the reactor, including modifying it to be able to determine CO₂ in the exit gas.
5. The rotating tubular reactor has been adopted by the Standing Committee of Analysts (UK) as a standard method for assessing both the biodegradability of chemicals (7) and the treatability and toxicity of waste waters (8). The method described here has the advantages of simplicity, compactness, reproducibility and the need for relatively small volumes of organic medium.

PRINCIPLE OF THE TEST

6. Synthetic or domestic sewage, and the test chemical, in admixture or alone, are applied to the internal surface of a slowly rotating inclined tube. A layer of microorganisms, similar to those present on bio-filter media, is built up on the internal surface. The conditions of operation of the reactor are chosen to give adequate elimination of organic matter and, if required, oxidation of ammonium.

▼ M4

7. Effluent from the tube is collected and either settled and/or filtered before analysis for dissolved organic carbon (DOC) and/or the test chemical by a specific method. Control units receiving no test chemical are operated in parallel under the same conditions for comparative purposes. The difference between the concentrations of DOC in the effluent from the test and control units is assumed to be due to the test chemical and its organic metabolites. This difference is compared with the concentration of the added test chemical (as DOC) to calculate the elimination of the test chemical.
8. Biodegradation may normally be distinguished from bio-adsorption by careful examination of the elimination-time curve. Confirmation may usually be obtained by applying a test for ready biodegradation (oxygen uptake or carbon dioxide production) using an acclimated inoculum taken at the end of the test from the reactors receiving the test chemical.

INFORMATION ON THE TEST CHEMICAL

9. The purity, water solubility, volatile and adsorption characteristics of the test chemical should be known to enable correct interpretation of results to be made.
10. Normally, volatile and poorly soluble chemicals cannot be tested unless special precautions are taken (see Appendix 5 to chapter C.10 A). The chemical structure, or at least the empirical formula, should also be known in order to calculate theoretical values and/or to check measured values of parameters, e.g. theoretical oxygen demand (ThOD), DOC.
11. Information on the toxicity of the test chemical to micro-organisms (see Appendix 4 to chapter C.10 A) may be useful for selecting appropriate test concentrations and may be essential for the correct interpretation of low biodegradation values.

PASS LEVELS

12. Originally, the primary biodegradation of surfactants was required to reach 80 % or more before the chemical could be marketed. If the value of 80 % is not attained, this simulation (confirmatory) test may be applied and the surfactant may be marketed only if more than 90 % of the specific chemical is removed. With chemicals in general there is no question of a pass/fail level and the value of percentage removed can be used in proximate calculations of the probable environmental concentration to be used in hazard assessments posed by chemicals. In a number of studies of pure chemicals the percentage removal of DOC was found to be > 90 % in more than three-quarters, and > 80 % in over 90 %, of chemicals which showed any significant degree of biodegradability.

REFERENCE CHEMICALS

13. To ensure that the experimental procedure is being carried out correctly, it is useful occasionally to test reference chemicals whose behaviour is known. Such chemicals include adipic acid, 2-phenyl phenol, 1-naphthol, diphenic acid and 1-naphthoic acid.

REPRODUCIBILITY OF TEST RESULTS

14. The relative standard deviation within tests was found by a laboratory in the UK to be 3,5 % and between tests to be 5 % (7).

▼ M4

DESCRIPTION OF THE METHOD

Apparatus*Rotating tubular reactors*

15. The apparatus (see figures 1 and 2 in the Appendix 8 consists of a bank of acrylic tubes each 30,5 cm long and 5 cm internal diameter, supported on rubber-rimmed wheels contained within a metal supporting frame. Each tube has an outside lip, approximately 0,5 cm deep, to retain it on the wheels, the internal surface is roughened with coarse wire wool and there is a 0,5 cm deep internal lip at the upper (feed) end to retain the liquid. The tubes are inclined at an angle of approximately one degree to the horizontal to achieve the required contact time when the test medium is applied to a clean tube. The rubber-tyred wheels are rotated using a slow, variable-speed motor. The temperature of the tubes is controlled by installation in a constant temperature room.
16. By enclosing each tube reactor inside a slightly larger, capped tube and ensuring that connections were gas-tight, exit CO₂ gas could be collected in an alkaline solution for subsequent measurement (6).
17. A 24h supply, for each tube, of organic medium with added test chemical if applicable, is contained in a 20 l storage vessel (A)(see Figure 2). If required, the test chemical solution may be dosed separately. Near the bottom of each storage vessel there is an outlet which is connected by suitable tubing, e.g. silicone rubber, via a peristaltic pump (B) to a glass or acrylic delivery tube which enters 2-4 cm into the higher (feed) end of the inclined tube (C). Effluent is allowed to drip from the lower end of the inclined tube to be collected in another storage vessel (D). The effluent is settled or filtered before analysis.

Filtration apparatus-centrifuge

18. Device for filtration of samples with membranes filter of suitable porosity (nominal aperture diameter 0,45 µm) which adsorb organic chemicals or release organic carbon to a minimum degree. If filters are used which release organic carbon, wash them carefully with hot water to remove leachable organic carbon. Alternatively a centrifuge capable of achieving 40 000 m/sec² may be used.
19. Analytical equipment for determining:
 - DOC/total organic carbon (TOC), or chemical oxygen demand (COD);
 - specific chemical (HPLC, GC etc.) if required;
 - pH, temperature, acidity, alkalinity;
 - ammonium, nitrite, nitrate, if the tests are performed under nitrifying conditions.

Water

20. Tap water, containing less than 3 mg/l DOC.
21. Distilled or deionised water, containing less than 2 mg/l DOC.

▼ **M4***Organic medium*

22. Synthetic sewage, domestic sewage or a mixture of both may be used as the organic medium. It has been shown that the use of domestic sewage alone often gives increased percentage removed of DOC (in activated sludge units) and even allows the biodegradation of some chemicals, which are not biodegraded when OECD synthetic sewage is used. Thus, the use of domestic sewage is recommended. Measure the DOC (or COD) concentration in each new batch of organic medium. The acidity or alkalinity of the organic medium should be known. The medium may require the addition of a suitable buffer (sodium hydrogen carbonate or potassium hydrogen phosphate), if it is of low acidity or alkalinity, to maintain a pH of about $7,5 \pm 0,5$ in the reactor during the test. The amount of buffer, and when to add it, has to be decided in each individual case.

Synthetic sewage

23. Dissolve in each 1 litre of tap water: peptone, 160 mg; meat extract, 110 mg; urea, 30 mg; anhydrous dipotassium hydrogen phosphate, (K_2HPO_4), 28 mg; sodium chloride, (NaCl), 7 mg; calcium chloride dihydrate, ($CaCl_2 \cdot 2H_2O$), 4 mg; magnesium sulphate heptahydrate, ($MgSO_4 \cdot 7H_2O$), 2 mg. This OECD synthetic sewage is an example and gives a mean DOC concentration in the influent of about 100 mg/l. Alternatively, use other compositions, with about the same DOC concentrations, which are closer to real sewage. This synthetic sewage may be made up in distilled water in a concentrated form and stored at about 1 °C for up to one week. When needed, dilute with tap water. (This medium is unsatisfactory e.g. nitrogen concentration is very high, relatively low carbon content, but nothing better has been suggested, except to add more phosphate, as buffer, and extra peptone).

Domestic sewage

24. Use fresh settled sewage collected daily from a treatment works receiving predominantly domestic sewage. It should be collected from the overflow channel of the primary sedimentation tank, or from the feed to activated sludge plant, and be largely free from coarse particles. The sewage can be used after storage for several days at about 4 °C, if it is proved that the DOC (or COD) has not significantly decreased (i.e. by less than 20 %) during storage. In order to limit disturbances to the system, the DOC (or COD) of each new batch should be adjusted before use to an appropriate constant value, e.g. by dilution with tap water.

Lubricant

25. Glycerol or olive oil may be used for lubricating the peristaltic pump rollers: both are suitable for use on silicone-rubber tubing.

Stocks solutions of test chemical

26. For chemicals of adequate solubility prepare stock solutions at appropriate concentrations (e.g. 1 to 5 g/l) in deionised water or in the mineral portion of the synthetic sewage. For insoluble chemicals, see Appendix 5 in chapter C.10-A. This method is not suitable for volatile chemicals without modifications to the tubular reactors (paragraph 16). Determine the DOC and TOC of the stock solution and repeat the measurements for each new batch. If the difference between the DOC and TOC is greater than 20 %, check the water-solubility of the test chemical. Compare the DOC or the concentration of the test chemical measured by specific analysis of the stock solution with

▼ M4

the nominal value to ascertain whether recovery is good enough (normally > 90 % can be expected). Ascertain, especially for dispersions, whether or not DOC can be used as an analytical parameter or if only an analytical technique specific for the test chemical can be used. Centrifugation of the samples is required for dispersions. For each new batch, measure the DOC, COD or the test chemical with specific analysis.

27. Determine the pH of the stock solution. Extreme values indicate that the addition of the chemical may have an influence on the pH of the activated sludge in the test system. In this case neutralise the stock solution to obtain a pH of $7 \pm 0,5$ with small amounts of inorganic acid or base, but avoid precipitation of the test chemical.

PROCEDURE*Preparation of organic medium for dosing*

28. Ensure that all influent and effluent containers and tubing from influent vessels and to effluent vessels are thoroughly cleaned to remove microbial growths, initially and throughout the test.
29. Prepare the synthetic sewage (paragraph 23) freshly each day either from the solids or from the concentrated stock solution by appropriate dilution with tap water. Measure the required amount in a cylinder and add to a clean influent vessel. Also, where necessary, add the required amount of the stock solution of the test chemical or reference chemical to the synthetic sewage before dilution. If it is more convenient or necessary to avoid loss of the test chemical, prepare a separate diluted solution of the test chemical in a separate reservoir and deliver this to the inclined tubes via a different dosing pump.
30. Alternatively (and preferably), use settled domestic sewage (paragraph 24) collected freshly each day if possible.

Operation of rotating tubular reactors

31. Two identical tubular reactors are required for the assessment of one test chemical, and they are assembled in a constant temperature room normally at 22 ± 2 °C.
32. Adjust the peristaltic pumps to deliver 250 ± 25 ml/h of the organic medium (without test chemical) into the inclined tubes, which are rotated at 18 ± 2 rpm. Apply the lubricant (paragraph 25) to the pump tubes initially and periodically through the test to ensure proper functioning and to prolong the life of the tubing.
33. Adjust the angle of inclination of the tubes to the horizontal to produce a residence time of $125 \pm 12,5$ sec. for the feed in a clean tube. Estimate the retention time by adding a non-biological marker (e.g. NaCl, inert dye) to the feed: the time taken to reach peak concentration in the effluent is taken to be the mean retention time (when maximum film is present, the retention time can increase up to about 30 min.).
34. These rates, speeds and times have been found to give adequate removals (> 80 %) of DOC (or COD) and to produce nitrified effluents. The rate of flow should be changed if removal is insufficient or if the performance of a particular treatment plant is to be simulated. In the latter case, adjust the rate of dosing the organic medium until the performance of the reactor matches that of the treatment plant.

▼M4*Inoculation*

35. Airborne inoculation may be sufficient to start the growth of micro-organisms when synthetic sewage is used, but otherwise add 1 ml/l of settled sewage to the feed for 3 days.

Measurements

36. At regular intervals check that the dose-rates and rotating speeds are within the required limits. Also, measure the pH of the effluent, especially if nitrification is expected.

Sampling and analysis

37. The method, pattern and frequency of sampling are chosen to suit the purpose of the test. For example, take snap (or grab) samples of influent and effluent, or collect samples over a longer period e.g. 3-6 h. In the first period, without test chemical, take samples twice per week. Filter the samples through membranes or centrifuge at about 40 000 m/sec² for about 15 min (paragraph 18). It may be necessary to settle and/or coarse-filter the samples before membrane filtration. Determine DOC (or COD) at least in duplicate and if required BOD, ammonium and nitrite/nitrate.
38. All analyses should be performed as soon as possible after collection and preparation of the samples. If analyses have to be postponed, store the samples at about 4 °C in the dark in full, tightly stoppered bottles. If samples have to be stored for more than 48h, preserve them by deep-freezing, acidification or by addition of a suitable toxic chemical (e.g. 20 ml/l of a 10 g/l solution of mercury (II) chloride). Ensure that the preservation technique does not influence the results of analysis.

Running-in period

39. In this period, the surface biofilm grows to reach an optimal thickness, usually taking about 2 weeks and should not exceed 6 weeks. The removal (paragraph 44) of DOC (or COD) increases and reaches a plateau value. When the plateau has been reached at a similar value in both tubes, one is selected to be a control in the remainder of the test, during which their performance should remain consistent.

Introduction of test chemical

40. At this stage add the test chemical to the other reactor at the required concentration, usually 10-20 mg C/l. The control continues to receive the organic medium alone.

Acclimation period

41. Continue the twice weekly analyses for DOC (or COD) and, if primary biodegradability is to be assessed, also measure the concentration of the test chemical by specific analysis. Allow from one to six weeks (or longer under special conditions) after the test chemical has first been introduced for acclimation to occur. When the percentage removal (paragraphs 43-45) reaches a maximum value, obtain 12-15 valid values in the plateau phase over about 3 weeks for evaluation of the mean percentage removal. The test is considered completed if a sufficiently high degree of elimination is reached. Normally, do not exceed a test duration of more than 12 weeks after the first addition of the test chemical.

▼ M4*Sloughing of the film*

42. The sudden removal of large quantities of excess film from the tubes, or sloughing, takes place at relatively regular intervals. To ensure that the comparability of results is unaffected, allow tests to cover at least two full cycles of growing and sloughing.

DATA AND REPORTING**Treatment of results**

43. Calculate the percentage DOC (or COD) elimination of the test chemical for each timed assessment using the equation:

$$D_t = 100 [C_s - (E - E_o)]/C_s \%$$

where:

D_t = percentage elimination of DOC (or COD) at time t ;

C_s = concentration of DOC (or COD) in the influent due to the test chemical, preferably estimated from the concentration in, and volume added, of the stock solution (mg/l);

E = measured DOC (or COD) in the test effluent at time t (mg/l);

E_o = measured DOC (or COD) in the control effluent at time t (mg/l).

Repeat the calculation for the reference chemical, if tested.

Performance of the control reactor

44. The degree of DOC (or COD) elimination (D_B) of the organic medium in the control reactors is helpful information in assessing the biodegradative activity of the biofilm during the test. Calculate the percentage elimination from the equation:

$$D_B = 100 (1 - E_o/C_m)\%$$

where:

C_m = DOC (or COD) of the organic medium in the control influent (mg/l).

45. Calculate the removal (D_{ST}) of the test chemical, if measured, by a specific analytical method at each time assessment from the equation:

$$D_{ST} = 100 (1 - S_e/S_i)\%$$

where:

S_i = measured or, preferably, estimated concentration of test chemical in the test influent (mg/l)

S_e = measured test chemical concentration in the test effluent at time t (mg/l)

▼ M4

If the analytical method gives a positive value in unamended sewage equivalent to S_c mg/l, calculate the percentage removal (D_{SC}) from:

$$DSC = 100 (S_i - S_e + S_c)/(S_i + S_c)\%$$

Expression of test results

46. Plot the percentage elimination D_t and D_{ST} (or D_{SC}), if available, versus time (see Appendix 2 in chapter C.10- A). Take the mean (expressed to the nearest whole number) and standard deviation of the 12-15 values for D_T (and for D_{ST} , if available) obtained in the plateau phase as the percentage removal of the test chemical. From the shape of the elimination curve, some conclusions may be drawn about the removal processes.

Adsorption

47. If a high DOC elimination of the test chemical is observed at the beginning of the test, the test chemical is probably eliminated by adsorption on to the biofilm. It may be possible to prove this by determining the adsorbed test chemical on solids sloughed from the film. It is not usual for the elimination of the DOC of adsorbable chemicals to remain high throughout the test; normally, there is an initial high degree of removal which gradually falls to an equilibrium value. If, however, the adsorbed test chemical was able to cause acclimation of the microbial population, the elimination of the test chemical DOC would subsequently increase and reach a high, plateau level.

Lag phase

48. As in static, screening tests many test chemicals require a lag phase before full biodegradation occurs. In the lag phase, acclimation (or adaptation) of the competent bacteria takes place with almost no removal of the test chemical; then the initial growth of these bacteria occurs. This phase ends and the degradation phase is arbitrarily taken to begin when about 10 % of the initial amount of test chemical is removed (after allowing for adsorption, if it occurs). The lag phase is often highly variable and poorly reproducible.

Plateau phase

49. The plateau phase of an elimination curve in a continuous test is defined as that phase in which the maximum degradation takes place. This phase should last at least 3 weeks and have about 12-15 measured valid values.

Mean degree of elimination of the test chemical

50. Calculate the mean value from the elimination values D_t (and D_{st} , if available) of the test chemical at the plateau phase. Rounded to the nearest whole number (1 %), it is the degree of elimination of the test chemical. It is also recommended to calculate the 95 % confidence interval of the mean value. In a similar way calculate the mean degree (D_B) of elimination of the organic medium in the control vessel.

▼ M4**Indication of biodegradation**

51. If the test chemical does not adsorb significantly on to the biofilm and the elimination curve has a typical shape of a biodegradation curve with lag, degradation and plateau phases (paragraphs 48, 49), the measured elimination can safely be attributed to biodegradation. If a high initial removal has taken place, the simulation test cannot differentiate between biological and abiotic elimination processes. In such cases, and in other cases where there is any doubt about biodegradation (e.g. if stripping takes place), analyse adsorbed test chemical on samples of the film or perform additional static (screening) tests for biodegradability based on parameters clearly indicating biological processes. Such tests are the oxygen uptake methods (Chapter C.4 of this Annex D, E and F) (9) or a test which measures CO₂ production (Chapter C.4-C of this Annex or the Headspace method) (10); use as inoculum pre-exposed biofilm from the appropriate reactor.
52. If both the DOC removal and specific chemical removal have been measured, significant differences (the former being lower than the latter) between the percentages removed indicate the presence in the effluents of intermediate organic products, which may be more difficult to degrade; these should be investigated.

Validity of test results

53. Consider the test to be valid if the degree of DOC (or COD) elimination (D_B) in the control units is > 80 % after 2 weeks operation and no unusual observations have been made.
54. If a readily biodegradable (reference) chemical has been tested, the degree of biodegradation should be > 90 % and the difference between duplicate values should not be greater than 5 %. If these two criteria are not met, review the experimental procedures and/or obtain domestic sewage from another source.
55. Similarly, differences between biodegradation values from duplicate units (if used) treating a test chemical should not differ by more than 5 %. If this criterion is not met but the removals are high, continue analysis for a further three weeks. If removal is low, investigate the inhibitory effects of the test chemical if not known and repeat the test at a lower concentration of test chemical, if that is feasible.

Test Report

56. The test report must include the following:

Test chemical:

- identification data;
- physical nature and, where relevant, physico-chemical properties.

Test conditions:

- any modifications to test system, especially if insolubles or volatiles tested;
- type of organic medium;
- proportion and nature of industrial wastes in sewage, if used and if known;
- method of inoculation;

▼ M4

- test chemical stock solution — DOC (dissolved organic carbon) and TOC (total organic carbon) content; how prepared, if suspension; test concentration(s) used, reasons if outside range 10-20 mg/l DOC; method of addition; date first added; any changes in concentration;
- mean hydraulic retention time (with no growth); rotational speed of tube; approximate angle of inclination, if possible;
- details of sloughing; time and intensity;
- test temperature and range;
- analytical techniques employed.

Test results:

- all measured data DOC, COD, specific analyses, pH, temperature, N chemicals, if relevant;
- all calculated date of D_t (or D_{tc}), D_B , D_s obtained in tabular form and elimination curves;
- information on lag and plateau phases, test duration, the degree of elimination of the test chemical, of the reference chemical (if tested) and of the organic medium (in the control unit), together with statistical data and statements of biodegradability and validity of the test;
- discussion of results.

LITERATURE:

- (1) Gerike P, Fischer W, Holtmann W (1980). Biodegradability determinations in trickling filter units compared with the OECD Confirmatory Test. *Wat. Res.* 14: 753-758.
- (2) Truesdale GA, Jones K, Vandyke KG (1959). Removal of synthetic detergents in sewage treatment processes: Trials of a new biologically attackable material. *Wat. Waste Tr. J.* 7: 441-444.
- (3) Baumann U, Kuhn G and Benz M. (1998) Einfache Versuchsanordnung zur Gewinnung gewässerökologisch relevanter Daten, UWSF — Z. Umweltchem. Ökotox. 10: 214-220.
- (4) Gloyna EF, Comstock RF, Renn CE (1952). Rotary tubes as experimental trickling filters. *Sewage ind. Waste* 24: 1355-1357.
- (5) Kumke GW, Renn CE (1966). LAS removal across an institutional trickling filter. *JAOCS* 43: 92-94.
- (6) Tomlinson TG, Snaddon DHM, (1966). Biological oxidation of sewage by films of micro-organisms. *Int.J. Air Wat. Pollut.* 10: 865-881.
- (7) Her Majesty's Stationery Office (1982). Methods for the examination of waters and associated materials. Assessment of biodegradability, 1981, London.
- (8) Her Majesty's Stationery Office (1984). Methods for the examination of waters and associated materials. Methods for assessing the treatability of chemicals and industrial waste waters and their toxicity to sewage treatment processes, 1982, London.
- (9) Chapter C.4 of this Annex, Determination of 'Ready' Biodegradability A-F.
- (10) ISO 14593 (1998). Water Quality-Evaluation in an aqueous medium of the ultimate biodegradability of organic substances. Method by analysis of released inorganic carbon in sealed vessels.

▼ **M4**

Appendix 8

Figure 1

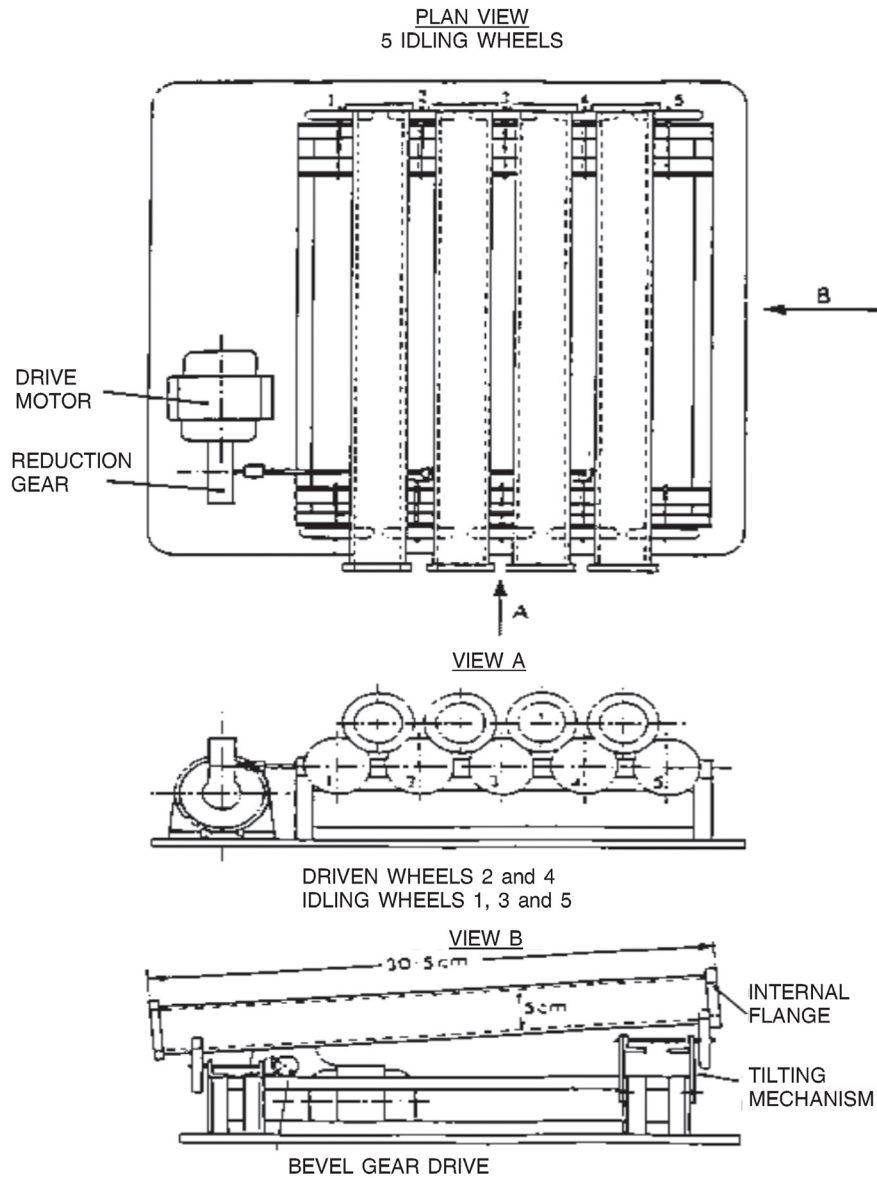
Rotating tubes*Glossary:*

Plan view:

View A/B:

Driven wheels:

Idling wheels:

Drive motor:

Reduction gear:

Internal flange:

Tilting mechanism:

Bevel gear drive:

▼ M4

Figure 2
Flow diagram

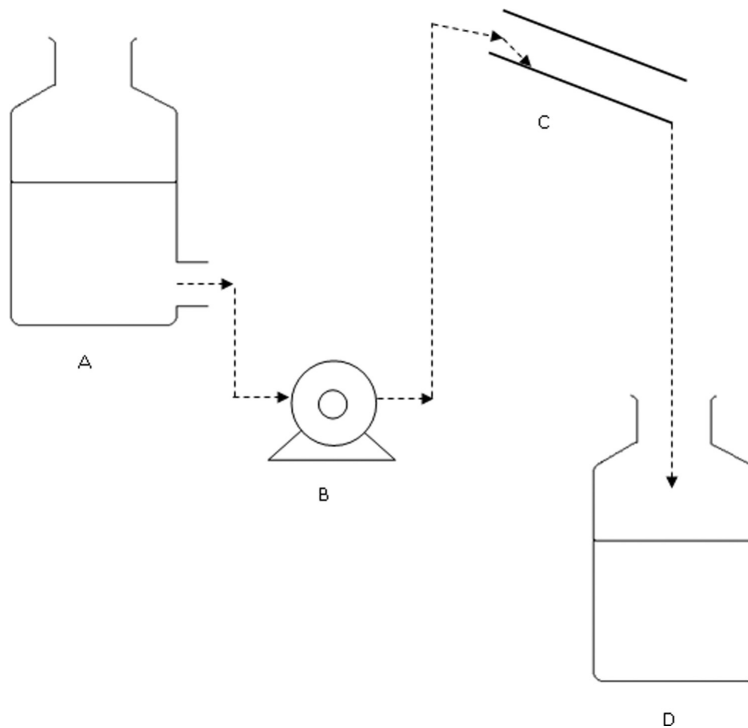

A: Feed Tank

B: Peristaltic Pump

C: Rotating Tube

D: Effluent Collection Vessel

DEFINITIONS:

Test chemical: Any substance or mixture tested using this Test Method.

Chemicals: It should be noted that the term 'chemical' is used broadly in the UNCED agreements and subsequent documents to include substances, products, mixtures, preparations, or any other terms that may be used in existing systems to denote coverage.

▼M6**C.11. ACTIVATED SLUDGE, RESPIRATION INHIBITION TEST
(CARBON AND AMMONIUM OXIDATION)**

INTRODUCTION

1. This test method is equivalent to OECD test guideline (TG) 209 (2010). This test method describes a method to determine the effects of a chemical on micro-organisms from activated sludge (largely bacteria) by measuring their respiration rate (carbon and/or ammonium oxidation) under defined conditions in the presence of different concentrations of the test chemical. The test method is based on the ETAD (Ecological and Toxicological Association of the Dyestuffs Manufacturing industry) test (1) (2), on the previous OECD TG 209 (3) and on the revised ISO Standard 8192 (4). The purpose of the test is to provide a rapid screening method to assess the effects of chemicals on the microorganisms of the activated sludge of the biological (aerobic) stage of waste-water treatment plants. The results of the test may also serve as an indicator of suitable non-inhibitory concentrations of test chemicals to be used in biodegradability tests (for example Chapters C.4 A-F, C.9, C.10, C.12 and C.29 of this Annex, OECD TG302C). In this case, the test can be performed as a screening test, similar to a range-finding or limit test (see paragraph 39), considering the overall respiration only. However, this information should be taken with care for ready biodegradability tests (Chapter C.4 A-F and C.29 of this Annex) for which the inoculum concentration is significantly lower than the one used in this test method. Indeed, an absence of inhibition in this respiration test does not automatically result in non-inhibitory conditions in the ready biodegradability test of Chapters C.4 A-F or C.29 of this Annex.
2. Overall, the respiration inhibition test seems to have been applied successfully since it was first published, but on some occasions spurious results were reported, e.g. (2) (4) (5). Concentration related respiration curves are sometimes bi-phasic, dose-response plots have been distorted and EC₅₀ values have been unexpectedly low (5). Investigations showed that such results are obtained when the activated sludge used in the test nitrifies significantly and the test chemical has a greater effect on the oxidation of ammonium than on general heterotrophic oxidation. Therefore, these spurious results may be overcome by performing additional testing using a specific inhibitor of nitrification. By measuring the oxygen uptake rates in the presence and absence of such an inhibitor, e.g. N-allylthiourea (ATU), the separate total, heterotrophic and nitrification oxygen uptake rates can be calculated (4) (7) (8). Thus, the inhibitory effects of a test chemical on the two processes may be determined and the EC₅₀ values for both organic carbon oxidation (heterotrophic) and ammonium oxidation (nitrification) may be calculated in the usual way. It should be noted that in some rare cases, the inhibitory effect of N-allylthiourea may be partially or completely nullified as a result of complexation with test chemicals or medium supplements, e.g. Cu⁺⁺ ions (6). Cu⁺⁺ ions are essential for *Nitrosomonas*, but are toxic in higher concentration.
3. The need for nitrification in the aerobic treatment of wastewaters, as a necessary step in the process of removing nitrogen compounds from wastewaters by denitrification to gaseous products, has become urgent particularly in European countries; the EU has now set lower limits for the concentration of nitrogen in treated effluents discharged to receiving waters (1).

(1) Council Directive 91/271/EEC of 21 May 1991 concerning urban waste-water treatment (OJ L 135, 30.5.1991, p. 40).

▼M6

4. For most purposes, the method to assess the effect on organic carbon oxidation processes alone is adequate. However, in some cases an examination of the effect on nitrification alone, or on both nitrification and organic carbon oxidation separately, are needed for the interpretation of the results and understanding the effects.

PRINCIPLE OF THE TEST METHOD

5. The respiration rates of samples of activated sludge fed with synthetic sewage are measured in an enclosed cell containing an oxygen electrode after a contact time of 3 hours. Under consideration of the realistic exposure scenario, longer contact times could be appropriate. If the test chemical is rapidly degraded e.g. abiotically via hydrolysis, or is volatile and the concentration cannot be adequately maintained, additionally a shorter exposure period e.g. 30 minutes can be used. The sensitivity of each batch of activated sludge should be checked with a suitable reference chemical on the day of exposure. The test is typically used to determine the EC_x (e.g. EC_{50}) of the test chemical and/or the no-observed effect concentration (NOEC).
6. The inhibition of oxygen uptake by micro-organisms oxidising organic carbon may be separately expressed from that by micro-organisms oxidising ammonium by measurement of the rates of uptake of oxygen in the absence and presence of N-allylthiourea, a specific inhibitor of the oxidation of ammonium to nitrite by the first-stage nitrifying bacteria. In this case the percentage inhibition of the rate of oxygen uptake is calculated by comparison of the rate of oxygen uptake in the presence of a test chemical with the mean oxygen uptake rate of the corresponding controls containing no test chemical, both in the presence and absence of the specific inhibitor, N-allylthiourea.
7. Any oxygen uptake arising from abiotic processes may be detected by determining the rate in mixtures of test chemical, synthetic sewage medium and water, omitting activated sludge.

INFORMATION OF THE TEST CHEMICAL

8. The identification (preferably CAS number), name (IUPAC), purity, water solubility, vapour pressure, volatility and adsorption characteristics of the test chemical should be known to enable correct interpretation of results to be made. Normally, volatile chemicals cannot be tested adequately unless special precautions are taken (see paragraph 21).

APPLICABILITY OF THE TEST METHOD

9. The test method may be applied to water-soluble, poorly soluble and volatile chemicals. However, it may not always be possible to obtain EC_{50} values with chemicals of limited solubility and valid results with volatile chemicals may only be obtained providing that the bulk (say > 80 %) of the test chemical remains in the reaction mixture at the end of the exposure period(s). Additional analytical support data should be submitted to refine the EC_x concentration when there is any uncertainty regarding the stability of the test chemical or its volatility.

▼ M6

REFERENCE CHEMICALS

10. Reference chemicals should be tested periodically in order to assure that the test method and test conditions are reliable, and to check the sensitivity of each batch of activated sludge used as microbial inoculum on the day of exposure. The chemical 3,5-dichlorophenol (3,5-DCP) is recommended as the reference inhibitory chemical, since it is a known inhibitor of respiration and is used in many types of test for inhibition/toxicity (4). Also copper (II) sulphate pentahydrate can be used as a reference chemical for the inhibition of total respiration (9). N-methylaniline can be used as a specific reference inhibitor of nitrification (4).

VALIDITY CRITERIA AND REPRODUCIBILITY

11. The blank controls (without the test chemical or reference chemical) oxygen uptake rate should not be less than 20 mg oxygen per one gramme of activated sludge (dry weight of suspended solids) in an hour. If the rate is lower, the test should be repeated with washed activated sludge or with the sludge from another source. The coefficient of variation of oxygen uptake rate in control replicates should not be more than 30 % at the end of definitive test.
12. In a 2004 international ring test organised by ISO (4) using activated sludge derived from domestic sewage, the EC_{50} of 3,5-DCP was found to lie in the range 2 mg/l to 25 mg/l for total respiration, 5 mg/l to 40 mg/l for heterotrophic respiration and 0,1 mg/l to 10 mg/l for nitrification respiration. If the EC_{50} of 3,5-DCP does not lie in the expected range, the test should be repeated with activated sludge from another source. The EC_{50} of copper (II) sulphate pentahydrate should lie in the range of 53-155 mg/l for the total respiration (9).

DESCRIPTION OF THE TEST METHOD

Test vessels and apparatus

13. Usual laboratory equipment and the following should be used:
 - (a) Test vessels — for example, 1 000 ml beakers to contain 500 ml of reaction mixture (see 5 in Fig.1);
 - (b) Cell and attachments for measuring concentration of dissolved oxygen; a suitable oxygen electrode; an enclosed cell to contain the sample with no headspace and a recorder (e.g. 7, 8, 9 in Fig.1 of Appendix 2); alternatively, a BOD bottle may be used with a suitable sleeve adaptor for sealing the oxygen electrode against the neck of the bottle (see Fig. 2 of Appendix 3). To avoid loss of displaced liquid on insertion of the oxygen electrode, it is advisable first to insert a funnel or glass tube through the sleeve, or to use vessels with flared-out rims. In both cases a magnetic stirrer or alternative stirrer method, e.g. self-stirring probe, should be used;
 - (c) Magnetic stirrers and followers, covered with inert material, for use in measurement chamber and/or in the test vessels;
 - (d) Aeration device: if necessary, compressed air should be passed through an appropriate filter to remove dust and oil and through wash bottles containing water to humidify the air. The contents of vessels should be

▼M6

aerated with Pasteur pipettes, or other aeration devices, which do not adsorb chemicals. An orbital shaker operated at orbiting speeds between 150 and 250 rpm with flasks of, for example, 2 000 ml capacity, can be used to satisfy the oxygen demand for the sludge and overcome difficulties with chemicals that produce excessive foam, are volatile and therefore lost, or are difficult to disperse when aerated by air sparging. The test system is typically a number of beakers aerated continuously and sequentially established (e.g. at ca. 10 - 15 minute intervals), then analysed in a sequential manner. Validated instrumentation that allows the simultaneous aeration and measurement of the oxygen consumption rate in the mixtures may also be used;

(e) pH-meter;

(f) Centrifuge, general bench-top centrifuge for sludge capable of 10 000 m/s².

Reagents

14. Analytical grade reagents should be used throughout.

Water

15. Distilled or deionised water, containing less than 1 mg/l DOC, should be used except where chlorine free tap water is specified.

Synthetic sewage feed

16. The medium should be prepared to contain the following constituents at the stated amounts:

— peptone	16 g
— meat extract (or a comparable vegetable extract)	11 g
— urea	3 g
— sodium chloride (NaCl)	0,7 g
— calcium chloride dihydrate (CaCl ₂ , 2H ₂ O)	0,4 g
— magnesium sulphate heptahydrate (MgSO ₄ , 7H ₂ O)	0,2 g
— anhydrous potassium monohydrogen phosphate (K ₂ HPO ₄)	2. 8g
— distilled or deionised water to 1 litre	

17. The pH of this solution should be $7,5 \pm 0,5$. If the prepared medium is not used immediately, it should be stored in the dark at 0 °C to 4 °C, for no longer than 1 week or under conditions, which do not change its composition. It should be noted that this synthetic sewage is a 100 fold concentrate of that described in the OECD Technical Report 'Proposed method for the determination of the biodegradability of surfactants used in synthetic detergents' June 11, 1976, with moreover dipotassium hydrogen phosphate added.

▼ M6

18. Alternatively, components of the medium can be sterilised individually prior to storage, or the peptone and meat extract can be added shortly before carrying out the test. Prior to use, the medium should be thoroughly mixed and the pH adjusted if necessary to $\text{pH } 7,5 \pm 0,5$.

Test chemical

19. A stock solution should be prepared for readily water soluble test substances up to the maximum water solubility only (precipitations are not acceptable). Poorly water soluble substances, mixtures with components of different water solubility and adsorptive substances should be directly weighed into the test vessels. In these cases, use of stock solutions may be an alternative if dissolved concentrations of the test chemicals are analytically determined in the test vessels (prior to adding activated sludge). If water accommodated fractions (WAFs) are prepared, an analytical determination of the dissolved concentrations of the test chemicals in the test vessels is also essential. Using organic solvents, dispersants/emulsifiers to improve solubility should be avoided. Ultrasonication of stock solutions and pre-stirring suspensions, e.g. overnight, is possible when there is adequate information available concerning the stability of the test chemical under such conditions.
20. The test chemical may adversely affect pH within the test system. The pH of the test chemical-treated mixtures should be determined prior to the test set up, in a preliminary trial, to ascertain whether pH adjustment will be necessary prior to the main test and again on the day of the main test. Solutions/suspensions of test chemical in water should be neutralised prior to inoculum addition, if necessary. However, since neutralisation may change the chemical properties of the chemical, further testing, depending on the purposes of the study, could be performed to assess the effect of the test chemical on the sludge without pH adjustment.
21. The toxic effects of volatile chemicals, especially in tests in which air is bubbled through the system, can result in variable effect levels occurring owing to losses of the substance during the exposure period. Caution should be exercised with such substances by performing substance specific analysis of control mixtures containing the substance and modifying the aeration regime.

Reference chemical

22. If 3,5-dichlorophenol is used as reference chemical, a solution of 1,00 g of 3,5-dichlorophenol in 1 000 ml of water should be prepared (15). Warm water and/or ultrasonication should be used to accelerate the dissolution and make the solution up to volume when it has cooled to room temperature. However, it should be ensured that the reference chemical is not structurally changed. The pH of the solution should be checked and adjusted, if necessary, with NaOH or H_2SO_4 to pH 7 - 8.
23. If copper(II)sulphate pentahydrate is used as a reference chemical, concentrations of 58 mg/l, 100 mg/l and 180 mg/l (a factor of 1,8) are used. The substance is weighed in directly into the test vessels (29 - 50 - 90 mg for 500 ml total volume). It is then dissolved with 234 ml of autoclaved tap water. Copper(II)sulphate pentahydrate is easily soluble. When the test is started, 16 ml of synthetic sewage and 250 ml of activated sludge are added.

▼ M6**Specific inhibitor of nitrification**

24. A 2,32 g/l stock solution of N-allylthiourea (ATU) should be prepared. The addition of 2,5 ml of this stock solution to an incubation mixture of final volume of 500 ml results in a final concentration of 11,6 mg ATU/l (10^{-4} mol/l) which is known to be sufficient (4) to cause 100 % inhibition of nitrification in a nitrifying activated sludge containing 1,5g/l suspended solids.

Abiotic control

25. Under some rare conditions, a test chemical with strong reducing properties may cause measurable abiotic oxygen consumption. In such cases, abiotic controls are necessary to discriminate between abiotic oxygen uptake by the test chemical and microbial respiration. Abiotic controls may be prepared by omitting the inoculum from the test mixtures. Similarly, abiotic controls without inoculum may be included when supporting analytical measurements are performed to determine the achieved concentration during the exposure phase of the test, e.g. when using stock solutions of poorly water soluble chemicals with components with different water solubility. In specific cases it may be necessary to prepare an abiotic control with sterilised inoculum (e.g. by autoclaving or adding sterilising toxicants). Some chemicals may produce or consume oxygen only if the surface area is big enough for reaction, even if they normally need a much higher temperature or pressure to do so. In this respect special attention should be given to peroxy substances. A sterilised inoculum provides a big surface area.

Inoculum

26. For general use, activated sludge should be collected from the exit of the aeration tank, or near the exit from the tank, of a well-operated wastewater treatment plant receiving predominantly domestic sewage. Depending on the purpose of the test, other adequate types or sources of activated sludge, e.g. sludge grown in the laboratory, may also be used at suitable suspended solids concentrations of 2 g/l to 4 g/l. However, sludges from different treatment plants are likely to exhibit different characteristics and sensitivities.
27. The sludge may be used as collected but coarse particles should be removed by settling for a short period, e.g. 5 to 15 minutes, and decanting the upper layer of finer solids or sieving (e.g. 1 mm² mesh). Alternatively, the sludge may be homogenised in a blender for a *ca.* 15 seconds or longer, but caution is needed regarding the shear forces and the temperature change which might occur for long periods of blending.
28. Washing the sludge is often necessary, e.g. if the endogenous respiration rate is low. The sludge should first be centrifuged for a period to produce a clear supernatant and pellet of sewage solids e.g. 10 minutes at *ca.* 10 000 m/s². The supernatant liquid should be discarded and the sludge re-suspended in chlorine-free tap water, with shaking, and the wash-water should then be removed by re-centrifuging and discarding again. The washing and centrifuging process should be repeated, if necessary. The dry mass of a known volume of the re-suspended sludge should be determined and the sludge concentrated by removing liquor or diluted further in chlorine-free tap water to obtain the required sludge solids concentration of 3 g/l. The activated sludge should be continuously aerated (e.g. 2 l/minute) at the test temperature and, where possible used on day of collection. If this is not possible, the sludge should be fed daily

▼ M6

with the synthetic sewage feed (50 ml synthetic sewage feed/l activated sludge) for two additional days. The sludge is then used for the test and the results are accepted as valid, provided that no significant change in its activity, assessed by its endogenous heterotrophic and nitrification respiration rate, has occurred.

29. Difficulties can arise if foaming occurs during the incubation to the extent that the foam and the sludge solids carried on it, are expelled from the aeration vessels. Occasionally, foaming may simply result from the presence of the synthetic sewage, but foaming should be anticipated if the test chemical is, or contains, a surfactant. Loss of sludge solids from the test mixtures will result in artificially lowered respiration rates that could mistakenly be interpreted as a result of inhibition. In addition, aeration of surfactant solution concentrates the surfactant in the foam layer; loss of foam from the test system will lower the exposure concentrations. The foaming can be controlled by simple mechanical methods (e.g. occasional manual stirring using a glass rod) or by adding a surfactant-free silicone emulsion antifoam agent and/or use the shake flask aeration method. If the problem is associated with the presence of the synthetic sewage, the sewage composition should be modified by including an antifoam reagent at a rate of e.g. 50 µl/l. If foaming is caused by the test chemical, the quantity needed for abatement should be determined at the maximum test concentration, and then all individual aeration vessels should be identically treated (including those, e.g. blank controls and reference vessels where foam is absent). If antifoam agents are used, there should be no interaction with inoculum and/or test chemical.

TEST PROCEDURE

30. The inhibition of three different oxygen uptakes may be determined, total, heterotrophic only and that due to nitrification. Normally, the measurement of total oxygen uptake inhibition should be adequate. The effects on heterotrophic oxygen uptake from the oxidation of organic carbon, and due to the oxidation of ammonium are needed when there is a specific requirement for such two separate end-points for a particular chemical or (optionally) to explain atypical dose-response curves from inhibition of total oxygen uptake.

Test conditions

31. The test should be performed at a temperature within the range 20 ± 2 °C.

Test mixtures

32. Test mixtures (F_T as in Table 1) containing water, synthetic sewage feed and the test chemical should be prepared to obtain different nominal concentrations of the test chemical (See Table 1 for example of volumes of constituents). The pH should be adjusted to $7,5 \pm 0,5$, if necessary; mixtures should be diluted with water and the inoculum added to obtain equal final volumes in the vessels and to begin the aeration.

Reference mixtures

33. Mixtures (F_R) should be prepared with the reference chemical, e.g. 3,5-dichlorophenol, in place of the test chemical in the same way as the test mixtures.

▼ M6**Blank controls**

34. Blank controls (F_B) should be prepared at the beginning and end of the exposure period in tests in which the test beakers are set up sequentially at intervals. In tests performed using equipment which allows simultaneous measurements of oxygen consumption to be made, at least two blank controls should be included in each batch of simultaneous analysis. Blank controls contain an equal volume of activated sludge and synthetic medium but not test or reference chemical. They should be diluted with water to the same volume as the test and reference mixtures.

Abiotic control

35. If necessary, for example if a test chemical is known or suspected to have strong reducing properties, a mixture F_A should be prepared to measure the abiotic oxygen consumption. The mixture should have the same amounts of test chemical, synthetic sewage feed and the same volume as the test mixtures, but no activated sludge.

General procedure and measurements

36. Test mixtures, reference mixtures and the blank and abiotic controls are incubated at the test temperature under conditions of forced aeration (0,5 to 1 l/min) to keep the dissolved oxygen concentration above 60 - 70 % saturation and to maintain the sludge flocs in suspension. Stirring the cultures is also necessary to maintain sludge flocs in suspension. The incubation is considered to begin with the initial contact of the activated sludge inoculum with the other constituents of the final mixture. At the end of incubation, after the specified exposure times of usually 3 hours, samples are withdrawn to measure the rate of decrease of the concentration of dissolved oxygen in the cell designed for the purpose (Fig.2 of Appendix 3) or in a completely filled BOD bottle. The manner in which the incubations begin also depends on the capacity of the equipment used to measure oxygen consumption rates. For example, if it comprises a single oxygen probe, the measurements are made individually. In this case, the various mixtures needed for the test in synthetic sewage should be prepared but the inoculum should be withheld, and the requisite portions of sludge should be added to each vessel of the series. Each incubation should be started in turn, at conveniently timed intervals of e.g. 10 to 15 minutes. Alternatively, the measuring system may comprise multiple probes that facilitate multiple simultaneous measurements; in this case, inoculum may be added at the same time to appropriate groups of vessels.
37. The activated sludge concentration in all test, reference and blank (but not abiotic control) mixtures is nominally 1,5 g/l of suspended solids. The oxygen consumption should be measured after 3 hours of exposure. Additional 30-minute exposure measurements should be performed as appropriate and previously described in paragraph 5.

Nitrification potential of sludge

38. In order to decide whether sludge nitrifies and, if so, at what rate, mixtures (F_B) as in the blank control and additional 'control' mixtures (F_N) but which also contain N-allylthiourea at 11,6 mg/l should be prepared. The mixtures should be aerated and incubated at $20\text{ °C} \pm 2\text{ °C}$ for 3 hours. Then the rates

▼ M6

of oxygen uptake should be measured and the rate of oxygen uptake due to nitrification calculated.

Test designs*Range-finding test*

39. A preliminary test is used, when necessary, to estimate the range of concentrations of the test chemical needed in a definitive test for determining the inhibition of oxygen consumption. Alternatively, the absence of inhibition of oxygen consumption by the test chemical in a preliminary test may demonstrate that a definitive test is unnecessary, but triplicates at the highest tested concentration of the preliminary test (typically 1 000 mg/l, but dependent on the data requirement) should be included.

Table 1

Examples of mixtures for the preliminary test

Reagent	Original Concentration				
Test chemical stock solution	10 g/l				
Synthetic medium stock solution	See paragraph 16				
Activated sludge stock suspension	3 g/l of suspended solids				
Components of mixtures	Dosing into test vessels ^(a)				
	F _{T1}	F _{T2}	F _{T3-5}	F _{B1-2}	F _A
Test chemical stock solution (ml) (paragraphs 19 to 21)	0,5	5	50	0	50
Synthetic sewage feed stock solution (ml) (paragraph 16)	16	16	16	16	16
Activated sludge suspension (ml) (paragraphs 26 to 29)	250	250	250	250	0
Water (paragraph 15)	233,5	229	184	234	434
Total volume of mixtures (ml)	500	500	500	500	500
Concentrations in the mixture					
Test suspension (mg/l) Activated sludge	10	100	1 000	0	1 000
(suspended solids) (mg/l)	1 500	1 500	1 500	1 500	0

^(a) The same procedure should be followed with the reference chemical, to give flasks F_{R1-3}

40. The test should be performed using at least three concentrations of the test chemical, for example, 10 mg/l, 100 mg/l and 1 000 mg/l with a blank control and, if necessary, at least three abiotic controls with the highest concentrations of the test chemical (see as example Table 1). Ideally the lowest concentration should have no effect on oxygen consumption. The

▼ M6

rates of oxygen uptake and the rate of nitrification, if relevant, should be calculated; then the percentage inhibition should be calculated. Depending on the purpose of the test, it is also possible to simply determine the toxicity of a limit concentration, e.g. 1 000 mg/l. If no statistically significant toxic effect occurs at this concentration, further testing at higher or lower concentrations is not necessary. It should be noted that poorly water soluble substances, mixtures with components of different water solubility and adsorptive substances should be directly weighed into the test vessels. In this case, the volume reserved for the test substance stock solution should be replaced with dilution water.

*Definitive test***Inhibition of total oxygen uptake**

41. The test should be carried out using a range of concentrations deduced from the preliminary test. In order to obtain both a NOEC and an EC_x (e.g. EC_{50}), six controls and five treatment concentrations in a geometric series with five replicates are in most cases recommended. The abiotic control does not need to be repeated if there was no oxygen uptake in the preliminary test, but if significant uptake occurs abiotic controls should be included for each concentration of test chemical. The sensitivity of the sludge should be checked using the reference chemical 3,5-dichlorophenol. The sludge sensitivity should be checked for each test series, since the sensitivity is known to fluctuate. In all cases, samples are withdrawn from the test vessels after 3 hours, and additionally 30 minutes if necessary, for measurement of the rate of oxygen uptake in the oxygen electrode cell. From the data collected, the specific respiration rates of the control and test mixtures are calculated; the percentage inhibition is then calculated from equation 7, below.

Differentiation between inhibition of heterotrophic respiration and nitrification

42. The use of the specific nitrification inhibitor, ATU, enables the direct assessment of the inhibitory effects of test chemicals on heterotrophic oxidation, and by subtracting the oxygen uptake rate in the presence of ATU from the total uptake rate (no ATU present), the effects on the rate of nitrification may be calculated. Two sets of reaction mixtures should be prepared according to the test designs for EC_x or NOEC described in paragraph 41, but additionally, ATU should be added to each mixture of one set at a final concentration of 11,6 mg/l, which has been shown to inhibit nitrification completely in sludge with suspended solids concentrations of up to 3 000 mg/l (4). The oxygen uptake rates should be measured after the exposure period; these direct values represent heterotrophic respiration only, and the differences between these and the corresponding total respiration rates represent nitrification. The various degrees of inhibition are then calculated.

Measurements

43. After the exposure period(s) a sample from the first aeration vessel should be transferred to the oxygen electrode cell (Fig. 1 of Appendix 2) and the concentration of dissolved oxygen should immediately be measured. If a multiple electrode system is available, then the measurements may be made simultaneously. Stirring (by means of a covered magnet) is essential at the same rate as when the electrode is calibrated to ensure that the probe responds with minimal delay to changing oxygen concentrations, and to allow regular and reproducible oxygen measurements in the measuring vessel. Usually, the self-stirring probe system of some oxygen electrodes is adequate. The cell should be rinsed with water between measurements.

▼ M6

Alternatively, the sample can be used to fill a BOD bottle (Fig. 2 of Appendix 3) fitted with a magnetic stirrer. An oxygen probe with a sleeve adaptor should then be inserted into the neck of the bottle and the magnetic stirrer should be started. In both cases the concentration of dissolved oxygen should continuously be measured and recorded for a period, usually 5 to 10 minutes or until the oxygen concentration falls below 2 mg/l. The electrode should be removed, the mixture returned to the aeration vessel and aerating and stirring should be continued, if measurement after longer exposure periods is necessary.

Verification of the test chemical concentration

44. For some purposes, it may be necessary to measure the concentration of the test chemical in the test vessels. It should be noted that if stock solutions of:

- poorly water soluble substances,
- mixtures with components with different water solubility, or
- substances with good water solubility, but where the concentration of the stock solution is near the maximum water solubility,

are used, the dissolved fraction is unknown, and the true concentration of the test chemical that is transferred into the test vessels is not known. In order to characterise the exposure, an analytical estimation of the test chemical concentrations in the test vessels is necessary. To simplify matters, analytical estimation should be performed before the addition of the inoculum. Due to the fact that only dissolved fractions will be transferred into test vessels, measured concentrations may be very low.

45. To avoid time-consuming and expensive analytics, it is recommended to simply weigh the test chemical directly into the test vessels and to refer to the initial weighed nominal concentration for subsequent calculations. A differentiation between dissolved, undissolved or adsorbed fractions of the test chemical is not necessary because all these fractions appear under real conditions in a waste water treatment plant likewise, and these fractions may vary depending on the composition of the sewage. The aim of the test method is to estimate a non inhibitory concentration realistically and it is not suitable to investigate in detail which fractions make a contribution to the inhibition of the activated sludge organisms. Finally, adsorptive substances should be also weighed directly into the test vessels; and the vessels should be silanised in order to minimise losses through adsorption.

DATA AND REPORTING**Calculation of oxygen uptake rates**

46. The oxygen uptake rates should be calculated from the mean of the measured values, e.g. from the linear part of the graphs of oxygen concentration versus time, limiting the calculations to oxygen concentrations between 2,0 mg/l and 7,0 mg/l, since higher and lower concentrations may themselves influence rates of consumption. Excursion into concentration bands below or above these values is occasionally unavoidable and necessary, for example, when respiration is heavily suppressed and consequently very slow or if a particular activated sludge respire very quickly. This is acceptable provided the extended sections of the uptake graph are straight and their gradients do not change as they pass through the 2,0 mg/l or 7,0 mg/l O₂ boundaries. Any curved sections of the graph

▼ M6

indicate that the measurement system is stabilising or the uptake rate is changing and should not be used for the calculation of respiration rates. The oxygen uptake rate should be expressed in milligrammes per litre per hour (mg/lh) or milligrammes per gramme dry sludge per hour (mg/gh). The oxygen consumption rate, R , in mg/lh, may be calculated or interpolated from the linear part of the recorded oxygen decrease graph according to Equation 1:

$$R = (Q_1 - Q_2)/\Delta_t \times 60 \quad (1)$$

where:

Q_1 is the oxygen concentration at the beginning of the selected section of the linear phase (mg/l);

Q_2 is the oxygen concentration at the end of the selected section of the linear phase (mg/l);

Δ_t is the time interval between these two measurements (min.).

47. The specific respiration rate (R_s) is expressed as the amount of oxygen consumed per g dry weight of sludge per hour (mg/gh) according to Equation 2:

$$R_s = R/SS \quad (2)$$

where SS is the concentration of suspended solids in the test mixture (g/l).

48. The different indices of R which may be combined are:

S specific rate

T total respiration rate

N rate due to nitrification respiration

H rate due to heterotrophic respiration

A rate due to abiotic processes

B rate based on blank assays (mean)

Calculation of oxygen uptake rate due to nitrification

49. The relationship between total respiration (R_T), nitrification respiration (R_N) and heterotrophic respiration (R_H) is given by Equation 3:

$$R_N = R_T - R_H \quad (3)$$

where:

R_N is the rate of oxygen uptake due to nitrification (mg/lh);

R_T is the measured rate of oxygen uptake by the blank control (no ATU; F_B) (mg/lh).

R_H is the measured rate of oxygen uptake of the blank control with added ATU (F_N) (mg/lh).

▼ M6

50. This relationship is valid for blank values (R_{NB} , R_{TB} , R_{HB}), abiotic controls (R_{NA} , R_{TA} , R_{HA}) and assays with test chemicals (R_{NS} , R_{TS} , R_{HS}) (mg/gh). Specific respiration rates are calculated from:

$$R_{NS} = R_N/SS \quad (4)$$

$$R_{TS} = R_T/SS \quad (5)$$

$$R_{HS} = R_H/SS \quad (6)$$

51. If R_N is insignificant (e.g. < 5 % of R_T in blank controls) in a preliminary test, it may be assumed that the heterotrophic oxygen uptake equals the total uptake and that no nitrification is occurring. An alternative source of activated sludge would be needed if the tests were to consider effects on heterotrophic and nitrifying micro-organisms. A definitive test is performed if there is evidence of suppressed oxygen uptake rates with different test chemical concentrations.

Calculation of percentage of inhibition

52. The percentage inhibition, I_T , of total oxygen consumption at each concentration of test chemical, is given by Equation 7:

$$I_T = [1 - (R_T - R_{TA})/R_{TB}] \times 100 \% \quad (7)$$

53. Similarly, the percentage inhibition of heterotrophic oxygen uptake, I_H , at each concentration of test chemical, is given by Equation 8:

$$I_H = [1 - (R_H - R_{HA})/R_{HB}] \times 100 \% \quad (8)$$

54. Finally, the inhibition of oxygen uptake due to nitrification, I_N , at each concentration, is given by Equation 9:

$$I_N = [1 - (R_T - R_H)/(R_{TB} - R_{HB})] \times 100 \% \quad (9)$$

55. The percentage inhibition of oxygen uptake should be plotted against logarithm of the test chemical concentration (inhibition curve, see Fig.3 of Appendix 4). Inhibition curves are plotted for each aeration period of 3 h or additionally after 30 min. The concentration of test chemical which inhibits the oxygen uptake by 50 % (EC_{50}) should be calculated or interpolated from the graph. If suitable data are available, the 95 % confidence limits of the EC_{50} , the slope of the curve, and suitable values to mark the beginning of inhibition (for example, EC_{10} or EC_{20}) and the end of the inhibition range (for example, EC_{80} or EC_{90}) may be calculated or interpolated.

56. It should be noted that in view of the variability often observed in the results, it may in many cases be sufficient to express the results additionally in order of magnitude, for example:

EC_{50} < 1 mg/l

EC_{50} 1 mg/l to 10 mg/l

EC_{50} 10 mg/l to 100 mg/l

EC_{50} > 100 mg/l

Interpretation of results

EC_x

▼ M6

57. EC_x -values including their associated lower and upper 95 % confidence limits for the parameter are calculated using appropriate statistical methods (e.g. probit analysis, logistic or Weibull function, trimmed Spearman-Kärber method or simple interpolation (11)). An EC_x is obtained by inserting a value corresponding to x % of the control mean into the equation found. To compute the EC_{50} or any other EC_x , the per-treatment means (x) should be subjected to regression analysis.

NOEC estimation

58. If a statistical analysis is intended to determine the NOEC, per-vessel statistics (individual vessels are considered as replicates) are necessary. Appropriate statistical methods should be used according to the OECD Document on Current Approaches in the Statistical Analysis of Ecotoxicity Data: a Guidance to Application (11). In general, adverse effects of the test chemical compared to the control are investigated using one-tailed (smaller) hypothesis testing at $p \leq 0,05$.

Test report

59. The test report should include the following information:

Test chemical

- common name, chemical name, CAS number, purity;
- physico-chemical properties of the test chemical (e.g. $\log K_{ow}$, water solubility, vapour pressure, Henry's constant (H) and possible information on the fate of the test chemical e.g. adsorption to activated sludge);

Test system

- source, conditions of operation of the wastewater treatment plant and influent it receives, concentration, pre-treatment and maintenance of the activated sludge;

Test conditions

- test temperature, pH during the test and duration of the exposure phase(s);

Results

- specific oxygen consumption of the controls ($\text{mg O}_2/(\text{g sludge} \times \text{h})$);
- all measured data, inhibition curve(s) and method for calculation of EC_{50} ;
- EC_{50} and, if possible, 95 per cent confidence limits, possibly EC_{20} , EC_{80} ; possibly NOEC and the used statistical methods, if the EC_{50} cannot be determined;
- results for total, and if appropriate, heterotrophic and nitrification inhibition;
- abiotic oxygen uptake in the physico-chemical control (if used);
- name of the reference chemical and results with this chemical;
- all observations and deviations from the standard procedure, which could have influenced the result.

LITERATURE

- (1) Brown, D., Hitz, H.R. and Schäfer, L. (1981). The assessment of the possible inhibitory effect of dyestuffs on aerobic waste-water bacteria, Experience with a screening test. *Chemosphere* 10 (3): 245-261.

▼ M6

- (2) King, E. F. and Painter H. A. (1986). Inhibition of respiration of activated sludge; variability and reproducibility of results. *Toxicity Assessment* 1(1): 27-39.
- (3) OECD (1984), Activated sludge, Respiration inhibition test, Test Guideline No. 209, Guidelines for the testing of chemicals, OECD, Paris.
- (4) ISO (2007). ISO 8192 Water Quality- Test for inhibition of oxygen consumption by activated sludge for carbonaceous and ammonium oxidation, International Organization for Standardization.
- (5) Bealing, D. J. (2003). Document ISO/TC147/WGI/N.183, International Organization for Standardization.
- (6) Painter, H A, Jones K (1963). The use of the wide-bore dropping-mercury electrode for the determination of the rates of oxygen uptake and oxidation of ammonia by micro-organisms. *Journal of Applied Bacteriology* 26 (3): 471-483.
- (7) Painter, H. A. (1986). Testing the toxicity of chemicals by the inhibition of respiration of activated sludge. *Toxicity Assessment* 1:515-524.
- (8) Robra, B. (1976). Wasser/Abwasser 117, 80.
- (9) Fiebig S. and Noack, U. (2004). The use of copper(II)sulphate pentahydrate as reference substance in the activated sludge respiration inhibition test — acc. to the OECD guideline 209. *Fresenius Environmental Bulletin* 13 No. 12b: 1556-1557.
- (10) ISO (1995). ISO 10634 Water Quality — Guidance for the preparation and treatment of poorly water-soluble organic compounds for the subsequent evaluation of their biodegradability in aqueous medium, International Organization for Standardization.
- (11) OECD (2006). Current approaches in the statistical analysis of ecotoxicity data: a guidance to application, Series on testing and assessment No. 54, ENV/JM/MONO(2006)18, OECD, Paris.

▼ M6*Appendix 1***Definitions**

The following definitions are applicable to this test method.

Chemical means a substance or a mixture.

EC_x (Effect concentration for x % effect) is the concentration that causes an x % of an effect on test organisms within a given exposure period when compared with a control. For example, an EC₅₀ is a concentration estimated to cause an effect on a test end point in 50 % of an exposed population over a defined exposure period.

NOEC (no observed effect concentration) is the test chemical concentration at which no effect is observed. In this test, the concentration corresponding to the NOEC, has no statistically significant effect ($p < 0,05$) within a given exposure period when compared with the control.

Test chemical means any substance or mixture tested using this test method.

▼ **M6**

Appendix 2

Fig. 1: Examples for measuring unit

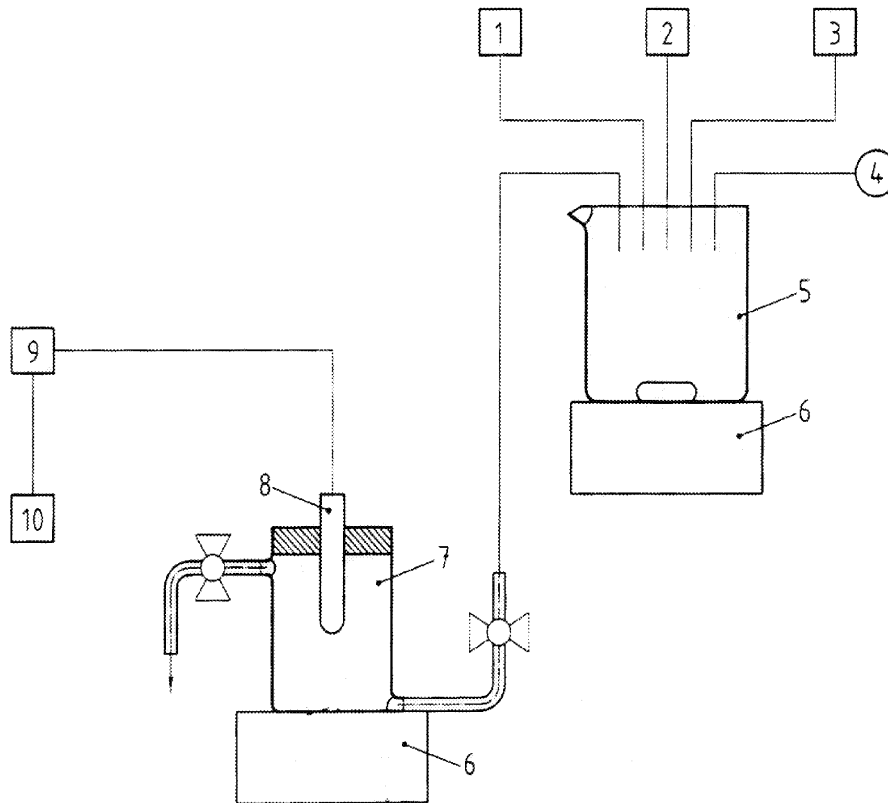

Key:

- | | |
|--------------------|-------------------------------|
| 1 activated sludge | 6 magnetic stirrer |
| 2 synthetic medium | 7 oxygen measuring cell |
| 3 test chemical | 8 oxygen electrode |
| 4 air | 9 oxygen measuring instrument |
| 5 mixing vessel | 10 recorder |

▼ **M6**

Appendix 3

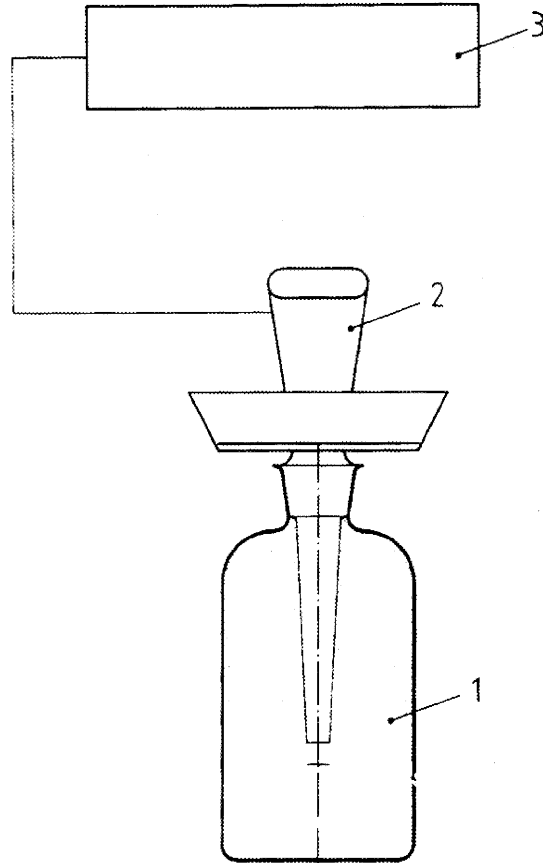
Fig. 2: Example of measuring unit, using a BOD bottle

Key:

1 Test vessel

2 oxygen electrode

3 oxygen measuring instrument

▼ **M6**

Appendix 4

Fig. 3: Example of inhibition curves

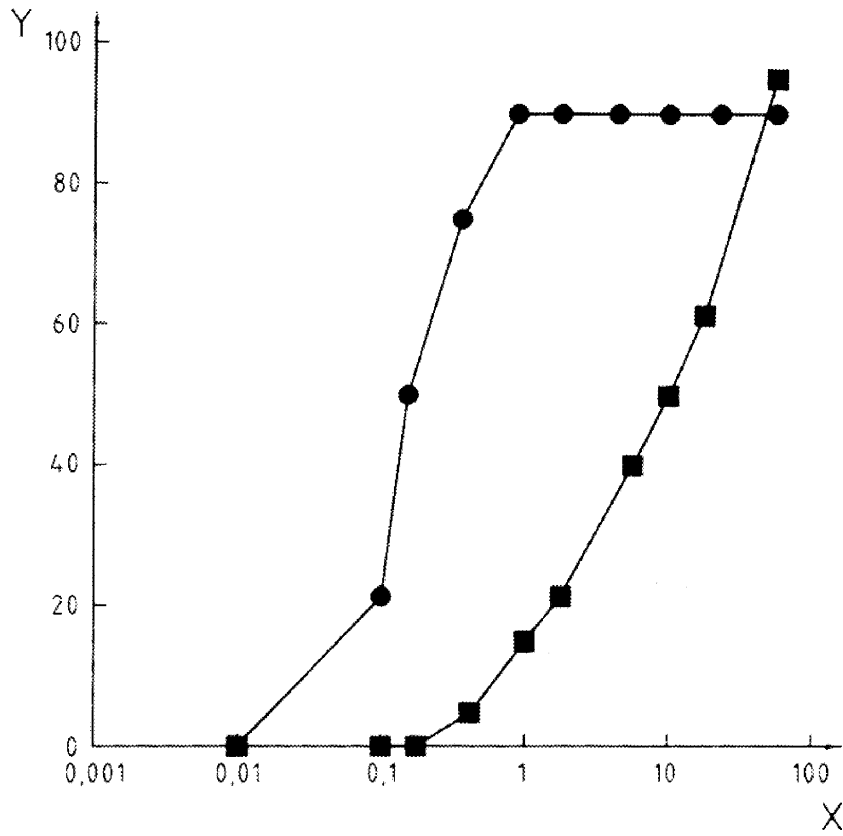

Key:

X concentration of 3,5-dichlorophenol (mg/l)

Y inhibition (%)

■ inhibition heterotrophic respiration using a nitrifying sludge

● inhibition nitrification using a nitrifying sludge.

▼ B**C.12. BIODEGRADATION**

MODIFIED SCAS TEST

1. **METHOD**

1.1. INTRODUCTION

The purpose of the method is the evaluation of the potential ultimate biodegradability of water-soluble, non-volatile organic substances when exposed to relatively high concentrations of micro-organisms over a long time period. The viability of the microorganisms is maintained over this period by daily addition of a settled sewage feed. (For weekend requirements, the sewage may be stored at 4 °C. Alternatively, the synthetic sewage of the OECD confirmatory test may be used.)

Physico-chemical adsorption on the suspended solids may take place and this must be taken into account when interpreting results (see 3.2).

Because of the long detention period of the liquid phase (36 hours), and the intermittent addition of nutrients, the test does not simulate those conditions experienced in a sewage treatment plant. The results obtained with various test substances indicate that the test has a high biodegradation potential.

The conditions provided by the test are highly favourable to the selection and/or adaptation of micro-organisms capable of degrading the test compound. (The procedure may also be used to produce acclimatised inocula for use in other tests.)

In this method, the measure of the concentration of dissolved organic carbon is used to assess the ultimate biodegradability of the test substances. It is preferable to determine DOC after acidification and purging rather than as the difference of $C_{\text{total}} - C_{\text{inorganic}}$.

The simultaneous use of a specific analytical method may allow the assessment of the primary degradation of the substance (disappearance of the parent chemical structure).

The method is applicable only to those organic test substances which, at the concentration used in the test:

- are soluble in water (at least 20 mg dissolved organic carbon/litre),
- have negligible vapour pressure,
- are not inhibitory to bacteria,
- do not significantly adsorb within the test system,
- are not lost by foaming from the test solution.

The organic carbon content of the test material must be established.

▼ B

Information on the relative proportions of the major components of the test material will be useful in interpreting the results obtained, particularly in those cases where the results are low or marginal.

Information on the toxicity to microorganisms of the substance may be useful to the interpretation of low results and in the selection of an appropriate test concentration.

1.2. DEFINITIONS AND UNITS

C_T = concentration of test compound as organic carbon as present in or added to the settled sewage at the start of the aeration period (mg/litre),

C_t = concentration of dissolved organic carbon found in the supernatant liquor of the test at the end of the aeration period (mg/litre),

C_c = concentration of dissolved organic carbon found in the supernatant liquor of the control at the end of the aeration period (mg/litre).

The biodegradation is defined in this method as the disappearance of the organic carbon. The biodegradation can be expressed as:

1. The percentage removal D_{da} of the amount of substance added daily:

$$D_{da} = \frac{C_T - (C_T - C_c)}{C_T} \times 100 \quad [1]$$

where

D_{da} = degradation/daily addition.

2. The percentage removal D_{ssd} of the amount of substance present at the start of each day:

$$D_{ssd} = \frac{2C_T + C_{ti} - C_{ci} - 3C_{t(i+1)} + 3C_{c(i+1)}}{2C_T + C_{ti} - C_{ci}} \times 100 \quad [2 (a)]$$

$$\approx \frac{2C_T - 2(C_t - C_c)}{2C_T + (C_t - C_c)} \times 100 \quad [2 (b)]$$

where

D_{ssd} = degradation/substance start of day;

the indices i and $(i + 1)$ refer to the day of measurement.

Equation 2(a) is recommended if effluent DOC varies from day to day, while equation 2(b) may be used when effluent DOC remains relatively constant from day to day.

▼ B

1.3. REFERENCE SUBSTANCES

In some cases, when investigating a new substance, reference substances may be useful; however, no specific reference substance is recommended here.

Data on several compounds evaluated in ring tests are provided (see Appendix 1) primarily so that calibration of the method may be performed from time to time and to permit comparison of results when another method is employed.

1.4. PRINCIPLE OF THE TEST METHOD

Activated sludge from a sewage treatment plant is placed in a semi-continuous activated sludge (SCAS) unit. The test compound and settled domestic sewage are added, and the mixture is aerated for 23 hours. The aeration is then stopped, the sludge allowed to settle and the supernatant liquor is removed.

The sludge remaining in the aeration chamber is then mixed with a further aliquot of test compound and sewage and the cycle is repeated.

Biodegradation is established by determination of the dissolved organic carbon content of the supernatant liquor. This value is compared with that found for the liquor obtained from a control tube dosed with settled sewage only.

When a specific analytical method is used, changes in the concentration of the parent molecule due to biodegradation can be measured (primary biodegradability).

1.5. QUALITY CRITERIA

The reproducibility of this method based on removal of dissolved organic carbon has not yet been established. (When primary biodegradation is considered, very precise data are obtained for materials that are extensively degraded).

The sensitivity of the method is largely determined by the variability of the blank and to a lesser extent by the precision of the determination of dissolved organic carbon and the level of test compound in the liquor at the start of each cycle.

1.6. DESCRIPTION OF THE TEST PROCEDURE

1.6.1. *Preparations*

A sufficient number of clean aeration units, alternatively, the original 1,5 litre SCAS test unit may be used, and air inlet tubes (Figure 1) for each test substance and controls are assembled. Compressed air supplied to the test units, cleaned by a cotton wool strainer, should be free of organic carbon and pre-saturated with water to reduce evaporation losses.

A sample of mixed liquor, containing 1 to 4 g suspended solids/litre, is obtained from an activated sludge plant treating predominantly domestic sewage. Approximately 150 ml of the mixed liquor are required for each aeration unit.

▼ B

Stock solutions of the test substance are prepared in distilled water; the concentration normally required is 400 mg/litre as organic carbon which gives a test compound concentration of 20 mg/litre carbon at the start of each aeration cycle if no biodegradation is occurring.

Higher concentrations are allowed if the toxicity to microorganisms permits it.

The organic carbon content of the stock solutions is measured.

1.6.2. *Test conditions*

The test should be performed at 20 to 25 °C.

A high concentration of aerobic microorganisms is used (from 1 to 4 g/litre suspended solids), and the effective detention period is 36 hours. The carbonaceous material in the sewage feed is oxidised extensively, normally within eight hours after the start of each aeration cycle. Thereafter, the sludge respire endogenously for the remainder of the aeration period, during which time the only available substrate is the test compound unless this is also readily metabolised. These features, combined with daily re-inoculation of the test when domestic sewage is used as the medium, provide highly favourable conditions for both acclimatisation and high degree of biodegradation.

1.6.3. *Performance of the test*

A sample of mixed liquor from a suitable predominantly domestic activated sludge plant or laboratory unit is obtained and kept aerobic until used in the laboratory. Each aeration unit as well as the control unit are filled with 150 ml of mixed liquor (if the original SCAS test unit is used, multiply the given volumes by 10) and the aeration is started. After 23 hours, aeration is stopped and the sludge is allowed to settle for 45 minutes. The tap of each vessel is opened in turn, and 100 ml portions of the supernatant liquor are withdrawn. A sample of settled domestic sewage is obtained immediately before use, and 100 ml are added to the sludge remaining in each aeration unit. Aeration is started anew. At this stage no test materials are added, and the units are fed daily with domestic sewage only until a clear supernatant liquor is obtained on settling. This usually takes up to two weeks, by which time the dissolved organic carbon in the supernatant liquor at the end of each aeration cycle approaches a constant value.

At the end of this period, the individual settled sludges are mixed, and 50 ml of the resulting composite sludge are added to each unit.

95 ml of settled sewage and 5 ml of water are added to the control units, and 95 ml of the settled sewage plus 5 ml of the appropriate test compound stock solution (400 mg/litre) are added to the test units. Aeration is started again and continued for 23 hours. The sludge is then allowed to settle for 45 minutes and the supernatant drawn off and analysed for dissolved organic carbon content.

The above fill-and-draw procedure is repeated daily throughout the test.

▼B

Before settling, it may be necessary to clean the walls of the units to prevent the accumulation of solids above the level of the liquid. A separate scraper or brush is used for each unit to prevent cross contamination.

Ideally, the dissolved organic carbon in the supernatant liquors is determined daily, although less frequent analyses are permissible. Before analysis the liquors are filtered through washed 0,45 µm membrane filters or centrifuged. Membrane filters are suitable if it is assured that they neither release carbon nor absorb the substance in the filtration step. The temperature of the sample must not exceed 40 °C while it is in the centrifuge.

The length of the test for compounds showing little or no biodegradation is indeterminate, but experience suggests that this should be at least 12 weeks in general, but not longer than 26 weeks.

2. DATA AND EVALUATION

The dissolved organic carbon values in the supernatant liquors of the test units and the control units are plotted against time.

As biodegradation is achieved, the level found in the test will approach that found in the control. Once the difference between the two levels is found to be constant over three consecutive measurements, such number of further measurements as are sufficient to allow statistical treatment of the data are made and the percentage biodegradation of the test compound is calculated (D_{da} or D_{ssd} , see 1.2).

3. REPORTING

3.1. TEST REPORT

The test report shall, if possible, contain the following:

- all information on the kind of sewage, the type of unit used and the experimental results concerning the tested substance, the reference substance if used, and the blank,
- the temperature,
- removal curve with description, mode of calculation (see 1.2),
- date and location where the activated sludge and the sewage were sampled, status of adaptation, concentration, etc.,
- scientific reasons for any changes of test procedure,
- signature and date.

▼ B

3.2. INTERPRETATION OF RESULTS

Since the substance to be tested by this method will not be readily biodegradable, any removal of DOC due solely to biodegradation will normally be gradual over days or weeks, except in such cases where acclimatisation is sudden as indicated by an abrupt disappearance occurring after some weeks.

However, physico-chemical adsorption can sometimes play an important role; this is indicated when there is complete or partial removal of the added DOC at the outset. What happens subsequently depends on factors such as the degrees of adsorption and the concentration of suspended solids in the discarded effluent. Usually the difference between the concentration of DOC in the control and test supernatant liquors gradually increases from the initial low value and this difference then remains at the new value for the remainder of the experiment, unless acclimatisation takes place.

If a distinction is to be drawn between biodegradation (or partial biodegradation) and adsorption, further tests are necessary. This can be done in a number of ways, but the most convincing is to use the supernatant liquor, or sludge, as inoculum in a base-set test (preferably a respirometric test).

Test substances giving high, non-adsorptive removal of DOC in this test should be regarded as potentially biodegradable. Partial, non-adsorptive removal indicates that the chemical is at least subject to some biodegradation.

Low, or zero removals of DOC may be due to inhibition of micro-organisms by the test substance and this may also be revealed by lysis and loss of sludge, giving turbid supernatants. The test should be repeated using a lower concentration of test substance.

The use of a specific analytical method or of ^{14}C -labelled test substance may allow greater sensitivity. In the case of ^{14}C test compound, the recovery of the $^{14}\text{CO}_2$ will confirm that biodegradation has occurred.

When results are also given in terms of primary biodegradation, an explanation should, if possible, be given on the chemical structure change that leads to the loss of response of the parent test substance.

The validation of the analytical method must be given together with the response found on the blank test medium.

4. REFERENCES

- (1) OECD, Paris, 1981, Test Guideline 302 A, Decision of the Council C(81) 30 final.

▼ B*Appendix 1***SCAS test: example of results**

Substance	C_T (mg/l)	$C_t - C_c$ (mg/l)	Percentage biodegradation, D_{da}	Test duration (days)
4-acetyl aminobenzene sulphonate	17,2	2,0	85	40
Tetra propylene benzene sulphonate	17,3	8,4	51,4	40
4-nitrophenol	16,9	0,8	95,3	40
Diethylene glycol	16,5	0,2	98,8	40
Aniline	16,9	1,7	95,9	40
Cyclopentane tetra carboxylate	17,9	3,2	81,1	120

▼B

Appendix 2

Example of test apparatus

Figure 1

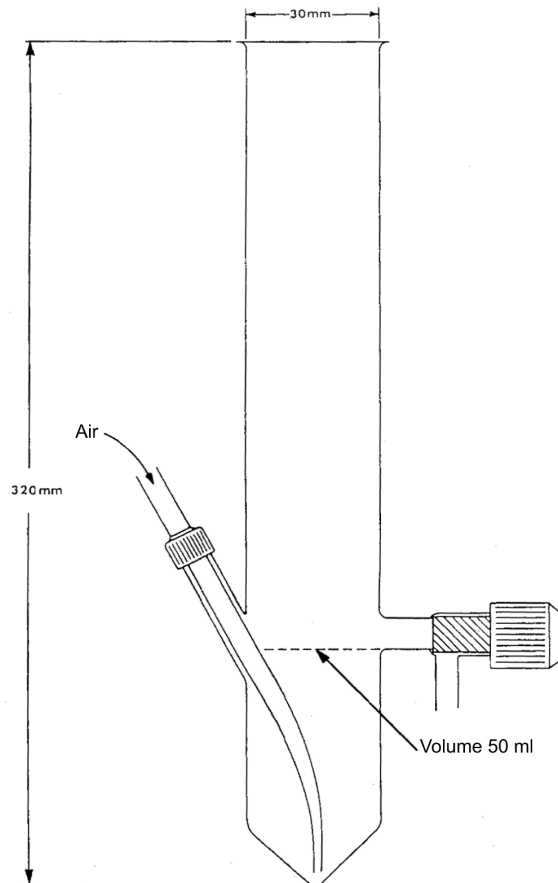

▼ **M7****C.13. BIOACCUMULATION IN FISH: AQUEOUS AND DIETARY EXPOSURE**

INTRODUCTION

This test method (TM) is equivalent to OECD test guideline (TG) 305 (2012). The major goal of this revision of test method is two-fold. Firstly, it is intended to incorporate a dietary bioaccumulation⁽¹⁾ test suitable for determining the bioaccumulation potential of substances with very low water solubility. Secondly, it is intended to create a test method that, when appropriate, utilises fewer fish for animal welfare reasons, and that is more cost-effective.

In the years since adoption of the consolidated test method C.13 (1), numerous substances have been tested, and considerable experience has been gained both by laboratories and by regulatory authorities. This has led to the conviction that the complexity of the test can be reduced if specific criteria are met (*cf.* paragraph 88), and that a tiered approach is possible. Experience has also shown that biological factors such as growth and fish lipid content can have a strong impact on the results and may need to be taken into account. In addition, it has been recognised that testing very poorly water soluble substances may not be technically feasible. In addition, for substances with very low water solubility in the aquatic environment, exposure via water may be of limited importance in comparison to the dietary route. This has led to the development of a test method in which fish are exposed via their diet (*cf.* paragraph 7-14 and 97 onwards). Validation (ring test) of the dietary exposure test was conducted in 2010 (51).

The main changes include:

- The testing of only one test concentration can be considered sufficient, when it is likely that the bioconcentration factor (BCF) is independent of the test concentration.
- A minimised aqueous exposure test design in which a reduced number of sample points is possible, if specific criteria are met.
- Fish lipid content should be measured so that BCF can be expressed on a 5 % lipid content basis.
- Greater emphasis on kinetic BCF estimation (when possible) next to estimating the BCF at steady state.
- For certain groups of substances, a dietary exposure test will be proposed, where this is considered more suitable than an aqueous exposure test.
- Fish weight should be measured so that BCF_k can be corrected for growth dilution.

Before carrying out any of the bioaccumulation tests, the following information about the test substance should be known:

- (a) Sensitivity of the analytical technique for measuring tissue and aqueous or food concentrations of both the test substance and possible metabolites (*cf.* paragraph 65).
- (b) Solubility in water [TM A.6; (2)]; this should be determined in accordance with a method that is appropriate for the (estimated) range of the solubility to obtain a reliable value. For hydrophobic substances, this will generally be the column elution method.

⁽¹⁾ See Appendix 1 for definitions and units

▼ **M7**

- (c) n-Octanol-water partition coefficient, K_{OW} ⁽¹⁾ [TMs A.8 (4), A.24 (5), A.23 (6)]; or other suitable information on partitioning behaviour (e.g. sorption to lipids, K_{OC}); this should be determined in accordance with a method that is appropriate for the (estimated) range of the K_{OW} to obtain a reliable value. For hydrophobic substances, this will generally be the slow-stirring method [TM A.23 (6)];
- (d) Substance stability in water (hydrolysis [TM C.7 (7)]);
- (e) Substance stability in food (specifically when a dietary exposure test approach is chosen);
- (f) Information on phototransformation relevant for the irradiation conditions in the test (8);
- (g) Surface tension (*i.e.* for substances where the log K_{OW} cannot be determined) [TM A.5 (9)];
- (h) Vapour pressure [TM A.4 (10)];
- (i) Any information on biotic or abiotic degradation in water, such as (but not restricted to) ready biodegradability [TMs C.4 parts II to VII (11), C.29 (12)], where appropriate;
- (j) Information on metabolites: structure, log K_{OW} , formation and degradability, where appropriate;
- (k) Acid dissociation constant (pK_a) for substances that might ionise. If necessary, the pH of the test water should be adjusted to ensure that the substance is in the unionised form in the test if compatible with fish species.

Independent of the chosen exposure method or sampling scheme, this test method describes a procedure for characterising the bioaccumulation potential of substances in fish. Although flow-through test regimes are much to be preferred, semi-static regimes are permissible, provided that the validity criteria (*cf.* paragraphs 24 and 113) are satisfied. In the dietary exposure route, the flow-through system is not necessary to maintain aqueous concentrations of the tested substance, but will help maintain adequate dissolved oxygen concentrations and help ensure clean water and remove influences of e.g. excretion products.

Independent of the chosen test method, sufficient details are given in this test method for performing the test while allowing adequate freedom for adapting the experimental design to the conditions in particular laboratories and for varying characteristics of test substances. The aqueous exposure test is most appropriately applied to stable organic substances with log K_{OW} values between 1,5 and 6,0 (13) but may still be applied to strongly hydrophobic substances (having log $K_{OW} > 6,0$), if a stable and fully dissolved concentration of the test substance in water can be demonstrated. If a stable concentration of the test substance in water cannot be demonstrated, an aqueous study would not be appropriate thus the dietary approach for testing the substance in fish would be required (although interpretation and use of the results of the dietary test may depend on the regulatory framework). Pre-estimates of the bioconcentration factor (BCF, sometimes denoted as K_B) for organic substances with log K_{OW} values up to about 9,0 can be obtained using the equation of Bintein *et al.* (14). The pre-estimate of the bioconcentration factor for such strongly hydrophobic substances

⁽¹⁾ Sometimes denoted by P_{OW} ; determined by a shake-flask method in TM A.8 (4), an HPLC method in TM A.24 (5) and a slow-stirring method in TM A.23 (6). The generator-column technique is occasionally used for the determination of log K_{OW} . A limited number of studies are available that makes use of this technique, primarily for chlorinated biphenyls and dibenzodioxins (e.g. Li and Doucette, 1993) (3). For substances that might ionise, log K_{OW} should refer to the unionised form.

▼ M7

may be higher than the steady-state bioconcentration factor (BCF_{SS}) value expected to be obtained from laboratory experiments, especially when a simple linear model is used for the pre-estimate. Parameters which characterise the bioaccumulation potential include the uptake rate constant (k_1), loss rate constants including the depuration rate constant (k_2), the steady-state bioconcentration factor (BCF_{SS}), the kinetic bioconcentration factor (BCF_K) and the dietary biomagnification factor (BMF) ⁽¹⁾.

Radiolabelled test substances can facilitate the analysis of water, food and fish samples, and may be used to determine whether identification and quantification of metabolites will be necessary. If total radioactive residues are measured alone (e.g. by combustion or tissue solubilisation), the BCF or BMF is based on the total of the parent substance, any retained metabolites and also assimilated carbon. BCF or BMF values based on total radioactive residues may not, therefore, be directly comparable to a BCF or BMF derived by specific chemical analysis of the parent substance only. Separation procedures, such as TLC, HPLC or GC ⁽²⁾ may be employed before analysis in radiolabelled studies in order to determine BCF or BMF based on the parent substance. When separation techniques are applied, identification and quantification of parent substance and relevant metabolites should be performed ⁽³⁾ (*cf.* paragraph 65) if BCF or BMF is to be based upon the concentration of the parent substance in fish and not upon total radiolabelled residues. It is also possible to combine a fish metabolism or *in vivo* distribution study with a bioaccumulation study by analysis and identification of the residues in tissues. The possibility of metabolism can be predicted by suitable tools (e.g. OECD QSAR toolbox ⁽¹⁵⁾ and proprietary QSAR programs).

The decision on whether to conduct an aqueous or dietary exposure test, and in what set-up, should be based on the factors in paragraph 3 considered together with the relevant regulatory framework. For example, for substances, which have a high $\log K_{OW}$ but still show appreciable water solubility with respect to the sensitivity of available analytical techniques, an aqueous exposure test should be considered in the first instance. However it is possible that information on water solubility is not definitive for these hydrophobic types of substances, so the possibility of preparing stable, measurable dissolved aqueous concentrations (stable emulsions are not allowed) applicable for an aqueous exposure study should be investigated before a decision is made on which test method to use ⁽¹⁶⁾. It is not possible to give exact prescriptive guidance on the method to be used based on water solubility and octanol-water partition coefficient 'cut off' criteria, as other factors (analytical techniques, degradation, adsorption, etc.) can have a marked influence on method applicability for the reasons given above. However, a $\log K_{OW}$ above 5 and a water solubility below ~ 0,01 - 0,1 mg/l mark the range of substances where testing via aqueous exposure may become increasingly difficult.

Other factors that may influence test choice should be considered, including the substance's potential for adsorption to test vessels and apparatus, its stability in aqueous solution versus its stability in fish food ⁽¹⁷⁾ ⁽¹⁸⁾, etc.

Information on such practical aspects may be available from other completed aqueous studies. Further information on the evaluation of aspects relating to the performance of bioaccumulation studies is available in the literature (e.g. ⁽¹⁹⁾).

For substances where the solubility or the maintenance of the aqueous concentration as well as the analysis of these concentrations do not pose any constraints to the realization of an aqueous exposure method, this method is preferred to determine the bioconcentration potential of the substance. In any case, it should be verified that the aqueous exposure concentration(s) to be applied are within the aqueous solubility in the test media. Different methods for maintaining stable concentrations of the dissolved test substance can be used, such as the use of

⁽¹⁾ See Appendix 1 for definitions and units

⁽²⁾ TLC: thin layer chromatography; HPLC: high pressure liquid chromatography; GC: gas chromatography

⁽³⁾ In some regulatory frameworks analysis of metabolites may be obligatory when certain conditions are met (*cf.* paragraph 65).

▼ M7

stock solutions or passive dosing systems (e.g. column elution method), as long as it can be demonstrated that stable concentrations can be maintained and the test media are not altered from that recommended in paragraph 27.

For strongly hydrophobic substances ($\log K_{OW} > 5$ and a solubility below $\sim 0,01-0,1$ mg/l), testing via aqueous exposure may become increasingly difficult. Reasons for constraints may be that the aqueous concentration cannot be maintained at a level that is considered to be sufficiently constant (e.g. due to sorption to the glass of exposure containers or rapid uptake by the fish) or that the aqueous concentrations to be applied are so low that they are in the same range as or below the analytical limit of quantification⁽¹⁾. For these highly hydrophobic substances the dietary test is recommended, provided that the test is consistent with the relevant regulatory framework and risk assessment needs.

For surfactants it should be considered whether the aqueous bioconcentration test is feasible, given the substance properties, otherwise the dietary study is probably more appropriate. Surfactants are surface acting agents, which lower the interfacial tension between two liquids. Their amphiphilic nature (*i.e.* they contain both a hydrophilic and a hydrophobic part) causes them to accumulate at interfaces such as the water-air interface, the water-food interface, and glass walls, which hampers the determination of their aqueous concentration.

The dietary test can circumvent some of the exposure aspects for complex mixtures with components of differing water solubility limits, in that comparable exposure to all components of the mixture is more likely than in the aqueous method (*cf.* (20)).

It should be noted that the dietary approach yields a dietary biomagnification factor (BMF) rather than a bioconcentration factor (BCF)⁽²⁾. Approaches are available to estimate a kinetic bioconcentration factor (BCF_K) from data generated in the dietary study (as discussed in Appendix 8, but these approaches should be used with caution. In general, these approaches assume first order kinetics, and are only applicable to certain groups of compounds. It is unlikely that such approaches can be applied for surfactants (see paragraph 12).

A minimised aqueous exposure test set-up with fewer sampling points to reduce the number of animals and/or resources (*cf.* paragraph 83 onwards) should only be applied to those substances where there is reason to expect that uptake and depuration will follow approximately first order kinetics (*i.e.* in general non-ionized organic substances, *cf.* paragraph 88).

C.13 - I: AQUEOUS EXPOSURE BIOCONCENTRATION FISH TEST

PRINCIPLE OF THE TEST

The test consists of two phases: the exposure (uptake) and post-exposure (depuration) phases. During the uptake phase, a group of fish of one species is exposed to the test substance at one or more chosen concentrations, depending on the properties of the test substance (*cf.* paragraph 49). They are then transferred to a medium free of the test substance for the depuration phase. A depuration phase is always necessary unless uptake of the substance during the uptake phase has

⁽¹⁾ In general, measured concentrations in water during the uptake phase should be at least an order of magnitude above the limit of quantification so that more than one half-life of body burden can be measured in the depuration phase of the study.

⁽²⁾ See Appendix 1 for definitions and units

▼ M7

been insignificant. The concentration of the test substance in/on the fish (or specified tissue thereof) is followed through both phases of the test. In addition to the exposed group, a control group of fish is held under identical conditions except for the absence of the test substance, to relate possible adverse effects observed in the bioconcentration test to a matching control group and to obtain background concentrations of test substance ⁽¹⁾.

In the aqueous exposure test, the uptake phase is usually run for 28 days. The duration can be lengthened if necessary (*cf.* paragraph 18), or shortened if it is demonstrated that steady-state has been reached earlier (see Appendix 1, definitions and units). A prediction of the length of the uptake phase and the time to steady-state can be made from equations in Appendix 5. The depuration period is then begun when the fish are no longer exposed to the test substance, by transferring the fish to the same medium but without the test substance in a clean vessel. Where possible the bioconcentration factor is calculated preferably both as the ratio of concentration in the fish (C_f) and in the water (C_w) at steady-state (BCF_{SS} ; see Appendix 1, definition) and as a kinetic bioconcentration factor (BCF_K ; see Appendix 1, definitions and units), which is estimated as the ratio of the rate constants of uptake (k_1) and depuration (k_2) assuming first order kinetics ⁽²⁾.

If a steady-state is not achieved within 28 days, either the BCF is calculated using the kinetic approach (*cf.* paragraph 38) or the uptake phase can be extended. Should this lead to an impractically long uptake phase to reach steady-state (*cf.* paragraphs 37 and 38, Appendix 5), the kinetic approach is preferred. Alternatively, for highly hydrophobic substances the conduction of a dietary study should be considered ⁽³⁾, provided that the dietary test is consistent with the relevant regulatory framework.

The uptake rate constant, the depuration (loss) rate constant (or constants, where more complex models are involved), the bioconcentration factor (steady-state and/or kinetic), and where possible, the confidence limits of each of these parameters are calculated from the model that best describes the measured concentrations of test substance in fish and water (*cf.* Appendix 5).

The increase in fish mass during the test will result in a decrease of test substance concentration in growing fish (so-called growth dilution), and thus the kinetic BCF will be underestimated if not corrected for growth (*cf.* paragraphs 72 and 73).

The BCF is based on the total concentration in the fish (*i.e.* per total wet weight of the fish). However, for special purposes, specified tissues or organs (e.g. muscle, liver), may be used if the fish are sufficiently large or the fish may be divided into edible (fillet) and non-edible (viscera) fractions. Since, for many organic substances, there is a clear relationship between the potential for bioconcentration and hydrophobicity, there is also a corresponding relationship between the lipid content of the test fish and the observed bioconcentration of such substances. Thus, to reduce this source of variability in test results for those substances with high lipophilicity (*i.e.* with $\log K_{OW} > 3$), bioconcentration should be expressed as normalised to a fish with a 5 % lipid content (based on whole body wet weight) in addition to that derived directly from the study. This is necessary to provide a basis from which results for different substances

⁽¹⁾ For most test substances, there should ideally be no detections in the control water. Background concentrations should only be relevant to naturally occurring materials (e.g., some metals) and substances that are ubiquitous in the environment.

⁽²⁾ If first order kinetics is obviously not obeyed, more complex models should be employed (see references in Appendix 5 and advice from a biostatistician sought).

⁽³⁾ Uptake may be limited by low exposure concentrations because of low water solubility in the bioconcentration test, whereas far higher exposure concentrations can be achieved with the dietary test.

▼M7

and/or test species can be compared against one another. The figure of 5 % lipid content has been widely used as this represents the average lipid content of fish commonly used in this test method (21).

INFORMATION ON THE TEST SUBSTANCE

In addition to the properties of the test substance given in the Introduction (paragraph 3), other information required is the toxicity to the fish species to be used in the test, preferably the asymptotic LC_{50} (*i.e.* time-independent) and/or toxicity estimated from long-term fish tests (e.g. TMs C.47 (22), C.15 (23), C.14 (24)).

An appropriate analytical method, of known accuracy, precision, and sensitivity, for the quantification of the substance in the test solutions and in biological material should be available, together with details of sample preparation and storage. The analytical quantification limit of the test substance in both water and fish tissues should also be known. When a radiolabelled test substance is used, it should be of the highest purity (e.g. preferably > 98 %) and the percentage of radioactivity associated with impurities should be known.

VALIDITY OF THE TEST

For a test to be valid the following conditions apply:

The water temperature variation is less than ± 2 °C, because large deviations can affect biological parameters relevant for uptake and depuration as well as cause stress to animals;

The concentration of dissolved oxygen does not fall below 60 % saturation;

The concentration of the test substance in the chambers is maintained within ± 20 % of the mean of the measured values during the uptake phase;

The concentration of the test substance is below its limit of solubility in water, taking into account the effect that the test water may have on effective solubility⁽¹⁾;

The mortality or other adverse effects/disease in both control and treated fish is less than 10 % at the end of the test; where the test is extended over several weeks or months, death or other adverse effects in both sets of fish should be less than 5 % per month and not exceed 30 % in all. Significant differences in average growth between the test and the control groups of sampled fish could be an indication of a toxic effect of the test substance.

REFERENCE SUBSTANCES

The use of reference substances of known bioconcentration potential and low metabolism would be useful in checking the experimental procedure, when required (e.g. when a laboratory has no previous experience with the test or experimental conditions have been changed).

⁽¹⁾ For multi-constituent substances, UVCBs and mixtures, the water solubility of each relevant component should be considered to determine the appropriate exposure concentrations.

▼ M7

DESCRIPTION OF THE METHOD

Apparatus

Care should be taken to avoid the use of materials — for all parts of the equipment — that can dissolve, sorb or leach and have an adverse effect on the fish. Standard rectangular or cylindrical tanks, made of chemically inert material and of a suitable capacity in compliance with loading rate (*cf.* paragraph 43), can be used. The use of soft plastic tubing should be minimised. Polytetrafluoroethylene, stainless steel and/or glass tubing should be used. Experience has shown that for test substances with high adsorption coefficient, such as the synthetic pyrethroids, silanised glass may be required. In such situations the equipment should be discarded after use. It is preferable to expose test systems to concentrations of the test substance to be used in the study for as long as is required to demonstrate the maintenance of stable exposure concentrations prior to the introduction of test organisms.

Water

Natural water is generally used in the test and should be obtained from uncontaminated and uniform quality source. Yet, reconstituted water (*i.e.* demineralised water with specific nutrients added in known amounts) may be more suitable to guarantee uniform quality over time. The dilution water, which is the water that is mixed with the test substance before entering the test vessel (*cf.* paragraph 30), should be of a quality that will allow the survival of the chosen fish species for the duration of the acclimation and test periods without them showing any abnormal appearance or behaviour. Ideally, it should be demonstrated that the test species can survive, grow and reproduce in the dilution water (e.g. in laboratory culture or a life-cycle toxicity test). The dilution water should be characterised at least by pH, hardness, total solids, total organic carbon (TOC⁽¹⁾) and, preferably also ammonium, nitrite and alkalinity and, for marine species, salinity. The parameters which are important for optimal fish well-being are not fully known, but Appendix 2 gives recommended maximum concentrations of a number of parameters for fresh and marine test waters.

The dilution water should be of constant quality during the period of a test. The pH value should be within the range 6,0 to 8,5 at test start, but during a given test it should be within a range of $\pm 0,5$ pH units. In order to ensure that the dilution water will not unduly influence the test result (for example, by complexation of the test substance) or adversely affect the performance of the stock of fish, samples should be taken at intervals for analysis, at least at the beginning and end of the test. Determination of heavy metals (e.g. Cu, Pb, Zn, Hg, Cd, and Ni), major anions and cations (e.g. Ca²⁺, Mg²⁺, Na⁺, K⁺, Cl⁻, and SO₄²⁻), pesticides (e.g. total organophosphorous and total organochlorine pesticides), total organic carbon and suspended solids should be conducted, for example, every three months where dilution water is known to be relatively constant in quality. If dilution water quality has been demonstrated to be constant over at least one year, determinations can be less frequent and intervals extended (e.g. every six months).

The natural particle content as well as the total organic carbon of the dilution water should be as low as possible to avoid adsorption of the test substance to organic matter, which may reduce its bioavailability and therewith result in an underestimation of the BCF. The maximum acceptable value is 5 mg/l for particulate matter (dry matter, not passing a 0,45 μm filter) and 2 mg/l for

⁽¹⁾ TOC includes organic carbon from particles and dissolved organic carbon, *i.e.* TOC = POC + DOC.

▼ M7

total organic carbon (*cf.* Appendix 2). If necessary, the dilution water should be filtered before use. The contribution to the organic carbon content in test water from the test fish (excreta) and from the food residues should be kept as low as possible (*cf.* paragraph 46).

Test Solutions

Prepare a stock solution of the test substance at a suitable concentration. The stock solution should preferably be prepared by simply mixing or agitating the test substance in the dilution water. An alternative that may be appropriate in some cases is the use of a solid phase desorption dosing system. The use of solvents and dispersants (solubilising agents) is not generally recommended (*cf.* (25)); however, the use of these materials may be acceptable in order to produce a suitably concentrated stock solution, but every effort should be made to minimise the use of such materials and their critical micelle concentration should not be exceeded (if relevant). Solvents which may be used are acetone, ethanol, methanol, dimethyl formamide and triethylene glycol; dispersants that have been used are Tween 80, methylcellulose 0,01 % and HCO-40. The solvent concentration in the final test medium should be the same in all treatments (i.e. regardless of test substance concentration) and should not exceed the corresponding toxicity thresholds determined for the solvent under the test conditions. The maximum level is a concentration of 100 mg/l (or 0,1 ml/l). It is unlikely that a solvent concentration of 100 mg/l will significantly alter the maximum dissolved concentration of the test substance which can be achieved in the medium (25). The solvent's contribution (together with the test substance) to the overall content of organic carbon in the test water should be known. Throughout the test, the concentration of total organic carbon in the test vessels should not exceed the concentration of organic carbon originating from the test substance, and solvent or solubilising agent⁽¹⁾, if used, by more than 10 mg/l (± 20 %). Organic matter content can have a significant effect on the amount of freely dissolved test substance during flow-through fish tests, especially for highly lipophilic substances. Solid-phase microextraction (*cf.* paragraph 60) can provide important information on the ratio between bound and freely dissolved compounds, of which the latter is assumed to represent the bioavailable fraction. The test substance concentration should be below the solubility limit of the test substance in the test media in spite of the use of a solvent or solubilising agent. Care should be taken when using readily biodegradable solvents as these can cause problems with bacterial growth in flow-through tests. If it is not possible to prepare a stock solution without the use of a solubilising agent, consideration should be given to the appropriateness of an aqueous exposure study as opposed to a dietary exposure study.

For flow-through tests, a system which continuously dispenses and dilutes a stock solution of the test substance (e.g. metering pump, proportional diluter, saturator system) or a solid phase desorption dosing system is required to deliver the test concentrations to the test chambers. Preferably allow at least five volume replacements through each test chamber per day. The flow-through mode is to be preferred, but where this is not possible (e.g. when the test organisms are adversely affected) a semi-static technique may be used provided that the validity criteria are satisfied (*cf.* paragraph 24). The flow rates of stock solutions and dilution water should be checked both 48 hours before and then at least daily during the test. Include in this check the determination of the flow-rate through each test chamber and ensure that it does not vary by more than 20 % either within or between chambers.

⁽¹⁾ Although not generally recommended, if a solvent or solubilising agent is used the organic carbon originating from this agent should be added to the organic carbon from the test substance to evaluate the concentration of organic carbon in the test vessels.

▼ M7**Selection of species**

Important criteria in the selection of species are that they are readily available, can be obtained in convenient sizes and can be satisfactorily maintained in the laboratory. Other criteria for selecting fish species include recreational, commercial, ecological importance as well as comparable sensitivity, past successful use etc. Recommended test species are given in Appendix 3. Other species may be used but the test procedure may have to be adapted to provide suitable test conditions. The rationale for the selection of the species and the experimental method should be reported in this case. In general, the use of smaller fish species will shorten the time to steady-state, but more fish (samples) may be needed to adequately analyse lipid content and test substance concentrations in the fish. In addition it is possible that differences in respiration rate and metabolism between young and older fish may hamper comparisons of results between different tests and test species. It should be noted that fish species tested during a (juvenile) life-stage with rapid growth can complicate data interpretation.

Holding of fish (relevant for aqueous and dietary exposure)

The stock population of fish should be acclimated for at least two weeks in water (*cf.* paragraph 28) at the test temperature and feed throughout on a sufficient diet (*cf.* paragraph 45). Both water and diet should be of the same type as those to be used during the test.

Following a 48-hour settling-in period, mortalities are recorded and the following criteria applied:

- Mortalities exceeding 10 % of the population in seven days: reject the entire batch;
- Mortalities of between 5 and 10 % of the population in seven days: acclimate for seven additional days — if more than 5 % mortality during the second seven days, reject the entire batch;
- Mortalities below 5 % of the population in seven days: accept the batch.

Fish used in tests should be free from observable diseases and abnormalities. Any diseased fish should be discarded. Fish should not receive treatment for disease in the two weeks preceding the test, or during the test.

PERFORMANCE OF THE TEST**Preliminary test**

It may be useful to conduct a preliminary experiment in order to optimise the test conditions of the definitive test, e.g. selection of test substance concentration(s), duration of the uptake and depuration phases, or to determine whether a full test need be conducted. The design of the preliminary test should be such as to obtain the information required. It can be considered if a minimised test may be sufficient to derive a BCF, or if a full study is needed (*cf.* paragraphs 83-95 on the minimised test).

Conditions of Exposure*Duration of uptake phase*

A prediction of the duration of the uptake phase can be obtained from practical experience (e.g. from a previous study or an accumulation study on a structurally related substance) or from certain empirical relationships utilising knowledge of either the aqueous solubility or the octanol/water partition coefficient of the test substance (provided that uptake follows first order kinetics, *cf.* Appendix 5).

▼ M7

The uptake phase should be run for 28 days unless it can be demonstrated that steady-state has been reached earlier (see Appendix 1, definitions and units). A steady-state is reached in the plot of test substance in fish (C_f) against time when the curve becomes parallel to the time axis and three successive analyses of C_f made on samples taken at intervals of at least two days are within $\pm 20\%$ of each other, and there is no significant increase of C_f in time between the first a last successive analysis. When pooled samples are analysed, at least four successive analyses are required. For test substances which are taken up slowly the intervals would more appropriately be seven days. If steady-state has not been reached by 28 days, either the BCF is calculated using only the kinetic approach, which is not reliant on steady-state being reached, or the uptake phase can be extended, taking further measurements, until steady-state is reached or for 60 days, whichever is shorter. Also, the test substance concentration in the fish at the end of the uptake phase needs to be sufficiently high to ensure a reliable estimation of k_2 from the depuration phase. If no significant uptake is shown after 28 days, the test can be stopped.

Duration of the depuration phase

For substances following first order kinetics, a period of half the duration of the uptake phase is usually sufficient for an appropriate (e.g. 95 %) reduction in the body burden of the substance to occur (*cf.* Appendix 5 for explanation of the estimation). If the time required to reach 95 % loss is impractically long, exceeding for example twice the normal duration of the uptake phase (*i.e.* more than 56 days) a shorter period may be used (e.g. until the concentration of test substance is less than 10 % of steady-state concentration). However, longer depuration periods may be necessary for substances having more complex patterns of uptake and depuration than are represented by a one-compartment fish model that yields first order kinetics. If such complex patterns are observed and/or anticipated, it is advised to seek advice from a biostatistician and/or pharmacokineticist to ensure a proper test set-up. As the depuration period is extended, numbers of fish to sample may become limiting and growth differences between fish can influence the results. The period will also be governed by the period over which the concentration of the test substance in the fish remains above the analytical limit of quantification.

Numbers of test fish

Select the numbers of fish per test concentration such that a minimum of four fish are available at each sampling point. Fish should only be pooled if analysis of single fish is not feasible. If higher precision in curve fitting (and derived parameters) is intended or if metabolism studies are required (e.g. to distinguish between metabolites and parent substance when using radiolabelled test substances), more fish per sampling point will be necessary. The lipid content should be determined on the same biological material as is used to determine the concentration of the test substance. Should this not be feasible, additional fish may be needed (*cf.* paragraphs 56 and 57).

If adult (*i.e.* sexually mature) fish are used, they should not be in a spawning state or recently spent (*i.e.* already spawned) either before or during the test. It should also be reported whether male or female, or both are used in the experiment. If both sexes are used, differences in growth and lipid content between sexes should be documented to be non-significant before the start of the exposure, in particular if it is anticipated that pooling of male and female fish will be necessary to ensure detectable substance concentrations and/or lipid content.

▼ M7

In any one test, select fish of similar weight such that the smallest are no smaller than two-thirds of the weight of the largest. All should be of the same year-class and come from the same source. Since weight and age of a fish may have a significant effect on BCF values (12) these details should be recorded accurately. It is recommended that a sub-sample of the stock of fish is weighed shortly before the start of the test in order to estimate the mean weight (*cf.* paragraph 61).

Loading

High water-to-fish ratios should be used in order to minimise the reduction in the concentration of the test compound in water caused by the addition of the fish at the start of the test and also to avoid decreases in dissolved oxygen concentration. It is important that the loading rate is appropriate for the test species used. In any case, a fish-to-water loading rate of 0,1-1,0 g of fish (wet weight) per litre of water per day is normally recommended. Higher fish-to-water loading rates can be used if it is shown that the required concentration of test substance can be maintained within ± 20 % limits, and that the concentration of dissolved oxygen does not fall below 60 % saturation (*cf.* paragraph 24).

In choosing appropriate loading regimes, take into account the normal habitat of the fish species. For example, bottom-living fish may demand a larger bottom area of the aquarium for the same volume of water compared to pelagic fish species.

Feeding

During the acclimation and test periods, feed an appropriate diet of known lipid and total protein content to the fish in an amount sufficient to keep them in a healthy condition and to maintain body weight (some growth is allowed). Feed daily throughout the acclimation and test periods at a set level depending on the species used, experimental conditions and calorific value of the food (for example for rainbow trout between approximately 1 to 2 % of body weight per day). The feeding rate should be selected such that fast growth and large increase of lipid content are avoided. To maintain the same feeding rate, the amount of feed should be re-calculated as appropriate, for example once per week. For this calculation, the weight of the fish in each test chamber can be estimated from the weight of the fish sampled most recently in that chamber. Do not weigh the fish remaining in the chamber.

Uneaten food and faeces should be siphoned daily from the test chambers shortly after feeding (30 minutes to one hour). The chambers should be kept as clean as possible throughout the test to keep the concentration of organic matter as low as possible (*cf.* paragraph 29), since the presence of organic carbon may limit the bioavailability of the test substance (12).

Since many feeds are derived from fishmeal, it should be ensured that the feed will not influence the test results or induce adverse effects, e.g. by containing (traces of) pesticides, heavy metals and/or the test substance itself.

Light and temperature

A 12- to 16-hour photoperiod is recommended and the temperature (± 2 °C) should be appropriate for the test species (*cf.* Appendix 3). The type and characteristics of illumination should be known. Caution should be given to the possible phototransformation of the test substance under the irradiation conditions of the study. Appropriate illumination should be used avoiding exposure of fish to unnatural photoproducts. In some cases it may be appropriate to use a filter to screen out UV irradiation below 290 nm.

▼ M7*Test concentrations*

The test was originally designed for non-polar organic substances. For this type of substance, the exposure of fish to a single concentration is expected to be sufficient, as no concentration effects are expected, although two concentrations may be required for the relevant regulatory framework. If substances outside this domain are tested, or other indications of possible concentration dependence are known, the test should be run with two or more concentrations. If only one concentration is tested, justification for the use of one concentration should be given (*cf.* paragraph 79). Also, the tested concentration should be as low as is practical or technically possible (*i.e.* not close to the solubility limit).

In some cases it can be anticipated that the bioconcentration of a substance is dependent on the water concentration (e.g. for metals, where the uptake in fish may be at least partly regulated). In such a case it is necessary that at least two, but preferably more, concentrations are tested (*cf.* paragraph 49) which are environmentally relevant. Also for substances where the concentrations tested have to be near the solubility limit for practical reasons, testing at least two concentrations is recommended, because this can give insight into the reliability of the exposure concentrations. The choice of the test concentrations should incorporate the environmentally realistic concentration as well as the concentration that is relevant to the purpose of the specific assessment.

The concentration(s) of the test substance should be selected to be below its chronic effect level or 1 % of its acute asymptotic LC₅₀, within an environmentally relevant range and at least an order of magnitude above its limit of quantification in water by the analytical method used. The highest permissible test concentration can also be determined by dividing the acute 96 h LC₅₀ by an appropriate acute/ chronic ratio (e.g. appropriate ratios for some substances are about three, but a few are above 100). If a second concentration is used, it should differ from the one above by a factor of ten. If this is not possible because of the toxicity criterion (that limits the upper test concentration) and the analytical limit (that limits the lower test concentration), a lower factor than ten can be used and use of radiolabelled test substance (of the highest purity, e.g. preferably > 98 %) should be considered. Care should be taken that no concentration used is above the solubility limit of the test substance in the test media.

Controls

One dilution water control or if relevant (*cf.* paragraphs 30 and 31), one control containing the solvent should be run in addition to the test series.

Frequency of Water Quality Measurements

During the test, dissolved oxygen, TOC, pH and temperature should be measured in all test and control vessels. Total hardness and salinity (if relevant) should be measured in the control(s) and one vessel. If two or more concentrations are tested, measure these parameters at the higher (or highest) concentration. As a minimum, dissolved oxygen and salinity (if relevant) should be measured three times — at the beginning, around the middle and end of the uptake period — and once a week in the depuration period. TOC should be measured at the beginning of the test (24 h and 48 h prior to test initiation of uptake phase) before addition of the fish and at least once a week during both uptake and depuration phases. Temperature should be measured and recorded daily, pH at the beginning and end of each period and hardness once each test. Temperature should preferably be monitored continuously in at least one vessel.

▼ M7**Sampling and Analysis of Fish and Water***Fish and water sampling schedule*

Water should be sampled from the test chambers for the determination of test substance concentration before addition of the fish and during both uptake and depuration phases. The water should be sampled before feeding, at the same time as the fish sampling. More frequent sampling may be useful to ensure stable concentrations after introduction of the fish. During the uptake phase, the concentrations of test substance should be determined in order to check compliance with the validity criteria (paragraph 24). If water sample analyses at the beginning of the depuration phase show that the test substance is not detected, this can be used as a justification not to measure test and control water for the test substance for the remainder of the depuration phase.

Fish should be sampled on at least five occasions during the uptake phase and on at least four occasions during the depuration phase for test substance. Since on some occasions it will be difficult to calculate a reasonably precise estimate of the BCF value based on this number of samples (especially when other than simple first order uptake and depuration kinetics are indicated), it may be advisable to take samples at a higher frequency in both periods (*cf.* Appendix 4).

The lipid content should be determined on the same biological material as is used to determine the concentration of the test substance at least at the start and end of the uptake phase and at the end of the depuration phase. Should this not be feasible, at least three independent fish should be sampled to determine lipid content at each of the same three time-points. The number of fish per tank at the start of the experiment should be adjusted accordingly⁽¹⁾. Alternatively, if no significant amounts of the test substance are detected in control fish (*i.e.* fish from the stock population), the control fish from the test can be analysed for lipid content only and test substance analysis in the test group(s) (and the related uptake rate constant, depuration rate constant and BCF values) can be corrected for changes according to control group lipid content during the test⁽²⁾.

Dead or diseased fish should not be analysed for test substance or lipid concentration.

An example of an acceptable sampling schedule is given in Appendix 4. Other schedules can readily be calculated using other assumed values of K_{OW} to calculate the exposure time for 95 % uptake (refer to Appendix 5 for calculations).

Sampling should be continued during the uptake phase until a steady-state has been established (see Appendix 1, definitions and units) or the uptake phase is otherwise terminated (after 28 or 60 days, *cf.* paragraphs 37 and 38). Before beginning the depuration phase, the fish should be transferred to clean vessels.

Sampling and sample preparation

Water samples should be obtained for analysis e.g. by siphoning through inert tubing from a central point in the test chamber. Neither filtration nor centrifuging appears always to separate the non-bioavailable fraction of the test substance from that which is bioavailable. If a separation technique is applied, a justification for, or validation of, the separation technique should always be provided in the test report given the bioavailability difficulties (25). Especially for highly

⁽¹⁾ If the lipid content is not analysed in the same fish as the test substance, fish should at least be of the similar weight, and (if relevant) the same sex.

⁽²⁾ This alternative is only valid if the fish in all test groups are held in similar group sizes, fish are removed according to the same pattern and fed in the same way. This ensures that fish growth in all test groups is similar, if the tested concentration is below the toxic range. If the growth is similar, also the lipid content is expected to be similar. A different growth in the control would indicate a substance effect and invalidate the study.

▼ M7

hydrophobic substances (*i.e.* those substances with a $\log K_{ow} > 5$) (12) (26), where adsorption to the filter matrix or centrifugation containers could occur, samples should not be subjected to those treatments. Instead, measures should be taken to keep the tanks as clean as possible (*cf.* paragraph 46) and the content of total organic carbon should be monitored during both the uptake and depuration phases (*cf.* paragraph 53). To avoid possible issues with reduced bioavailability, sampling by solid phase microextraction techniques may be used for poorly soluble and highly hydrophobic substances.

The sampled fish should be euthanised instantly, using the most appropriate and humane method (for whole fish measurements, no further processes than rinsing with water (*cf.* paragraph 28) and blot drying the fish should be done). Weigh and measure total length⁽¹⁾. In each individual fish, the measured weight and length should be linked to the analysed substance concentration (and lipid content, if applicable), for example using a unique identifier code for each sampled fish.

It is preferable to analyse fish and water immediately after sampling in order to prevent degradation or other losses and to calculate approximate uptake and depuration rate constants as the test proceeds. Immediate analysis also avoids delay in determining when a plateau (steady-state) has been reached.

Failing immediate analysis, the samples should be stored by an appropriate method. Before the beginning of the study, information should be obtained on the proper method of storage for the particular test substance — for example, deep-freezing, holding at 4 °C, extraction, etc. The duration of storage should be selected to ensure that the substance has not degraded while in storage.

Quality of analytical method

Since the whole procedure is governed essentially by the accuracy, precision and sensitivity of the analytical method used for the test substance, check experimentally that the accuracy, precision and reproducibility of the substance analysis, as well as recovery of the test substance from both water and fish are satisfactory for the particular method. This should be part of preliminary tests. Also, check that the test substance is not detectable in the dilution water used. If necessary, correct the values of test substance concentration in water and fish obtained from the test for the recoveries and background values of controls. The fish and water samples should be handled throughout in such a manner as to minimise contamination and loss (e.g. resulting from adsorption by the sampling device).

Analysis of fish samples

If radiolabelled materials are used in the test, it is possible to analyse for total radiolabel (*i.e.* parent and metabolites) or the samples may be cleaned up so that the parent substance can be analysed separately. If the BCF is to be based on the parent substance, the major metabolites should be characterised, as a minimum at the end of the uptake phase (*cf.* paragraph 6). Major metabolites are those representing $\geq 10\%$ of total residues in fish tissues, those representing $\geq 5\%$ at two consecutive sampling points, those showing increasing levels throughout the uptake phase, and those of known toxicological concern. If the BCF for the whole fish in terms of total radiolabelled residues is ≥ 500 , it may be advisable — and for certain categories of substances such as pesticides strongly recommended — identifying and quantifying major metabolites. Quantification of such metabolites may be required by some regulatory authorities. If degradates representing $\geq 10\%$ of total radiolabelled residues in the fish tissue are identified and

⁽¹⁾ In addition to weight, total length should be recorded because comparison of the extent of length increase during the test is a good indicator of whether an adverse effect has occurred.

▼ M7

quantified, then it is also recommended to identify and quantify degradates in the test water. Should this not be feasible, this should be explained in the report.

The concentration of the test substance should usually be determined for each weighed individual fish. If this is not possible, pooling of the samples on each sampling occasion may be done but pooling does restrict the statistical procedures which can be applied to the data, so an adequate number of fish to accommodate the desired pooling, statistical procedure and power should be included in the test. References (27) and (28) may be used as an introduction to relevant pooling procedures.

BCF should be expressed as normalised to a fish with a 5 % lipid content (based on wet weight) in addition to that derived directly from the study (*cf.* paragraph 21), unless it can be argued that the test substance does not accumulate primarily in lipids. The lipid content of the fish should be determined on each sampling occasion if possible, preferably on the same extract as that produced for analysis for the test substance, since the lipids often have to be removed from the extract before it can be analysed chromatographically. However, analysis of test substances often requires specific extraction procedures which might be in contradiction to the test methods for lipid determination. In this case (until suitable non-destructive instrumental methods are available), it is recommended to employ a different strategy to determine the fish lipid content (*cf.* paragraph 56). Suitable methods should be used for determination of lipid content (20). The chloroform/methanol extraction technique (29) may be recommended as standard method (30), but the Smedes-method (31) is recommended as an alternative technique. This latter method is characterised by a comparable efficiency of extraction, high accuracy, the use of less toxic organic solvents and ease of performance. Other methods for which accuracy compares favourably to the recommended methods could be used if properly justified. It is important to give details of the method used.

Fish growth measurement

At the start of the test, five to ten fish from the stock population need to be weighed individually and their total length measured. These can be the same fish used for lipid analysis (*cf.* paragraph 56). The weight and length of fish used for each sampling event from both test and control groups should be measured before chemical or lipid analysis is conducted. The measurements of these sampled fish can be used to estimate the weight and length of fish remaining in the test and control tanks (*cf.* paragraph 45).

DATA AND REPORTING**Treatment of results**

The uptake curve of the test substance should be obtained by plotting its concentration in/on fish (or specified tissues) in the uptake phase against time on arithmetic scales. If the curve has reached a plateau, that is, become approximately asymptotic to the time axis, the steady-state BCF (BCF_{SS}) should be calculated from:

$$\frac{C_f \text{ at steady - state (mean)}}{C_w \text{ at steady - state (mean)}}$$

▼ **M7**

The development of C_f may be influenced by fish growth (*cf.* paragraphs 72 and 73). The mean exposure concentration (C_w) is influenced by variation over time. It can be expected that a time-weighted average concentration is more relevant and precise for bioaccumulation studies, even if variation is within the appropriate validity range (*cf.* paragraph 24). A time weighted average (TWA) water concentration can be calculated according to Appendix 5, section 1.

The kinetic bioconcentration factor (BCF_K) should be determined as the ratio k_1/k_2 , the two first order kinetic rate constants. Rate constants k_1 and k_2 and BCF_K can be derived by simultaneously fitting both the uptake and the depuration phase. Alternatively, k_1 and k_2 can be determined sequentially (see Appendix 5 for a description and comparison of these methods). The depuration rate constant (k_2) may need correction for growth dilution (*cf.* paragraphs 72 and 73). If the uptake and/or depuration curve is obviously not first order, then more complex models should be employed (see references in Appendix 5 and advice from a biostatistician and/or pharmacokineticist sought).

Fish weight/length data

Individual fish wet weights and total lengths for all sampling intervals are tabulated separately for test and control groups during the uptake (including stock population for start of uptake) and depuration phases. In each individual fish the measured weight and length should be linked to the analysed chemical concentration, for example using a unique identifier code for each sampled fish. Weight is the preferred measure of growth for the purposes of correcting kinetic BCF values for growth dilution (see paragraph 73 and Appendix 5 for the method used to correct data for growth dilution).

Growth-Dilution Correction and Lipid Normalisation

Fish growth during the depuration phase can lower measured chemical concentrations in the fish with the effect that the overall depuration rate constant (k_2) is greater than would arise from removal processes (e.g. respiration, metabolism, egestion) alone. Kinetic bioconcentration factors should be corrected for growth dilution. A BCF_{SS} will also be influenced by growth, but no agreed procedure is available to correct a BCF_{SS} for growth. In cases of significant growth, the BCF_K , corrected for growth (BCF_{Kg}), should also be derived as it may be a more relevant measure of the bioconcentration factor. Lipid contents of test fish (which are strongly associated with the bioaccumulation of hydrophobic substances) can vary enough in practice such that normalisation to a set fish lipid content (5 % w/w) is necessary to present both kinetic and steady-state bioconcentration factors in a meaningful way, unless it can be argued that the test substance does not primarily accumulate in lipid (e.g. some perfluorinated substances may bind to proteins). Equations and examples for these calculations can be found in Appendix 5.

To correct a kinetic BCF for growth dilution, the depuration rate constant should be corrected for growth. This growth-corrected depuration rate constant (k_{2g}) is calculated by subtracting the growth rate constant (k_g , as obtained from the measured weight data) from the overall depuration rate constant (k_2). The growth-corrected kinetic bioconcentration factor is then calculated by dividing the uptake rate constant (k_1) by the growth-corrected depuration rate constant (k_{2g}) (*cf.* Appendix 5). In some cases this approach is compromised. For example, for very slowly depurating substances tested in fast growing fish, the derived k_{2g} may be very small and so the error in the two rate constants used to derive it becomes critical, and in some cases k_g estimates can be larger than k_2 . An alternative approach that circumvents the need for growth dilution correction involves using mass of test substance per fish (whole fish basis) depuration data

▼ M7

rather than the usual mass of test substance per unit mass of fish (concentration) data. This can be easily achieved as tests according to this TM should link recorded tissue concentrations to individual fish weights. The simple procedure for doing this is outlined in Appendix 5. Note that k_2 should still be reported even if this alternative approach is used.

Kinetic and steady-state bioconcentration factors should also be reported relative to a default fish lipid content of 5 % (w/w), unless it can be argued that the test substance does not primarily accumulate in lipid. Fish concentration data, or the BCF, are normalised according to the ratio between 5 % and the actual (individual) mean lipid content (in % wet weight) (*cf.* Appendix 5).

If chemical and lipid analyses have been conducted on the same fish, then individual fish lipid normalised data should be used to calculate a lipid-normalised BCF. Alternatively, if the growth in control and exposed fish is similar, the lipid content of control fish alone may be used for lipid-correction (*cf.* paragraph 56). A method for calculating a lipid-normalised BCF is described in Appendix 5.

Interpretation of results

The results should be interpreted with caution where measured concentrations of test solutions occur at levels near the detection limit of the analytical method.

Average growth in both test and control groups should in principle not be significantly different to exclude toxic effects. The growth rate constants or the growth curves of the two groups should be compared by an appropriate procedure ⁽¹⁾.

Clearly defined uptake and depuration curves are an indication of good quality bioconcentration data. For the rate constants, the result of a χ^2 goodness-of-fit-test should show a good fit (*i.e.* small measurement error percentage (32)) for the bioaccumulation model, so that the rate constants can be considered reliable (*cf.* Appendix 5). If more than one test concentration is used, the variation in uptake/depuration constants between the test concentrations should be less than 20 % ⁽²⁾. If not, concentration dependence could be indicated. Observed significant differences in uptake/ depuration rate constants between the applied test concentrations should be recorded and possible explanations given. Generally, the 95 % confidence limit of BCFs from well-designed studies approach ± 20 % of the derived BCF.

If two or more concentrations are tested, the results of both or all concentrations are used to examine whether the results are consistent and to show whether there is concentration dependence. If only one concentration is tested to reduce the use

⁽¹⁾ A *t*-test on growth rate constants can be performed, to test whether growth differs between control and test groups, or an *F*-test in case of analysis of variance. If needed, an *F*-test or likelihood ratio test can be used to assist in the choice of the appropriate growth model (OECD monograph 54, (32)).

⁽²⁾ These percentages assume that the analytical methods are reliable and the half life is < 14 days. If the analytical methods are less reliable or the half life is (greatly) increased these numbers will become larger.

▼M7

of animals and/or resources, justification of the use of one concentration should be given.

The resulting BCF_{SS} is doubtful if the BCF_K is significantly larger than the BCF_{SS} , as this can be an indication that steady-state has not been reached or growth dilution and loss processes have not been taken into account. In cases where the BCF_{SS} is very much higher than the BCF_K , the derivation of the uptake and depuration rate constants should be checked for errors and re-evaluated. A different fitting procedure might improve the estimate of BCF_K (*cf.* Appendix 5).

Test Report

Apart from the test substance information indicated in paragraph 3, the test report includes the following information:

Test substance:

Physical nature and, where relevant, physicochemical properties;

— Chemical identification data, such as IUPAC or CAS name, CAS number, SMILES or InChI code, structural formula, purity, chemical identity of impurities as appropriate and practically feasible, etc. (including the organic carbon content, if appropriate).

— For multi-constituent substances and UVCB (chemical substances of Unknown or Variable composition, Complex reaction products and Biological materials) description, as far as possible, of the chemical identity of the individual constituents and, for each, of its percentage of the total mass of the substance. How the analytical method used in the test reflects a measure of the concentration of the substance should be summarised; all analytical procedures should be described including the accuracy of the method, method detection limit, and limit of quantification.

— If radiolabelled, the precise position of the labelled atom(s) and the percentage of radioactivity associated with impurities.

— Information on the test substance toxicity to fish (ideally the test species). The toxicity should be reported as an acute 96 h LC_{50} and a NOAEC & LOAEC from a chronic study (*i.e.*, an early life stage test or a full life cycle test, if available).

— Storage conditions of the test chemical or test substance and stability of the test chemical or test substance under storage conditions if stored prior to use.

Test species:

Scientific name, strain, source, any pre-treatment, acclimation, age, sex (if relevant), size-range (weight and length), etc.

Test conditions:

— Test procedure used (e.g. flow-through or semi-static); regular study or minimised design (including rationale and justification).

— Type and characteristics of illumination used and photoperiod(s).

— Test design (e.g. number and size of test chambers, water volume replacement rate, loading rate, number of replicates, number of fish per replicate, number of test concentrations, length of uptake and depuration phases, sampling frequency for fish and water samples).

▼ M7

- Method of preparation of stock solutions and frequency of renewal (the solvent, its concentration and its contribution to the organic carbon content of test water should be given, when used) or description of alternative dosing system.
- The nominal test concentrations, the means of the measured values and their standard deviations in the test vessels and the method and frequency by which these were attained.
- Source of the dilution water, description of any pre-treatment, results of any demonstration of the ability of test fish to live in the water, and water characteristics: pH, hardness, temperature, dissolved oxygen concentration, residual chlorine levels (if measured), total organic carbon, suspended solids, salinity of the test medium (if appropriate) and any other measurements made.
- Water quality within test vessels, pH, hardness, TOC, temperature and dissolved oxygen concentration; methods used and frequency of measurements.
- Detailed information on feeding, e.g. type of food(s), source, composition (at least lipid and protein content if possible), selected feeding rate, amount given and frequency;
- Information on the treatment of fish and water samples, including details of preparation, storage, extraction and analytical procedures (and precision) for the test substance and lipid content.
- Methods used for treatment randomisation and assignment of fish to test vessels.
- Date of introduction of test organisms to test solutions and test duration.
- Description of range-finding tests and results, if available.

Results:

- Results from any preliminary study performed.
- Mortality of the control fish and the fish in each exposure chamber and any observed abnormal behaviour.
- Information on any adverse effects observed.
- Complete description of all chemical analysis procedures employed including limits of detection and quantification, variability and recovery.
- The lipid content of the fish, including the method used, and if derived, lipid normalisation factor (L_n , factor to express results relative to fish lipid content of 5 %).
- Tabulated fish weight (and length) data, linked to individual fish chemical concentrations (and lipid content, if applicable), both for control and exposure groups (for example using unique identifiers for each sampled fish) and calculations for derived growth rate constant(s).

▼ M7

- Tabulated test substance concentration data in fish (C_f , linked to individual fish) and water (C_w) (with mean values for test group and control, standard deviation and range, if appropriate) for all sampling times (C_f expressed in mg/kg wet weight of whole body or specified tissues thereof, e.g. lipid, and C_w in mg/l). C_w values for the control series (background should also be reported).
- Curves (including all measured data), showing the following (if applicable, concentrations may be expressed in relation to the whole body and the lipid content normalised to 5 % of the animal or specified tissues thereof):
 - growth, *i.e.* fish weight vs. time or natural logarithm transformed weight vs. time (including the derived growth rate constant, k_g);
 - the uptake and depuration of the test substance in the fish (on one graph);
 - the time to steady-state (if achieved);
 - natural logarithm transformed concentration vs. uptake time (including the derived uptake rate constant k_1);
 - natural logarithm transformed concentration (ln concentration) vs. depuration time (including the derived depuration rate constant k_2); and
 - both uptake and depuration phase curves, showing both the data and the fitted model.
- If a visual inspection of a plot shows obvious outliers, a statistically valid outlier test may be applied to remove spurious data points as well as documented justification for their omission.
- The steady-state bioconcentration factor, (BCF_{SS}), if steady-state is (almost) achieved.
- Kinetic bioconcentration factor (BCF_K) and derived uptake and depuration rate constants k_1 and k_2 , together with the variances in k_2 (slope and intercept) if sequential fitting is used.
- Confidence limits, standard deviation (as available) and methods of computation/data analysis for each parameter for each concentration of test substance used.
- Any information concerning radiolabelled test substance metabolites and their accumulation.
- Growth rate constant(s) (including 95 % confidence interval(s)) and calculated growth-corrected depuration rate constant (k_{2g}), half-life and BCF (BCF_{Kg}) values.
- Anything unusual about the test, any deviation from these procedures, and any other relevant information.
- A summary table of relevant measured and calculated data, as hereafter:

▼ **M7**

Substance Uptake and Depuration Rate Constants and Bioconcentration Factors (BCF)	
k_g (growth rate constant; day^{-1}):	Insert Value (95 % CI) ⁽¹⁾
k_1 (overall uptake rate constant; $\text{l kg}^{-1} \text{ day}^{-1}$):	Insert Value (95 % CI) ⁽¹⁾
k_2 (overall depuration rate constant; day^{-1}):	Insert Value (95 % CI) ⁽¹⁾
k_{2g} (growth-corrected depuration rate constant; day^{-1}):	Insert Value (95 % CI) ⁽¹⁾
C_f (chemical concentration in the fish at steady-state; mg kg^{-1}):	Insert Value \pm SD ⁽²⁾
C_w (chemical concentration in the water; mg l^{-1}):	Insert Value \pm SD ⁽²⁾
L_n (lipid normalisation factor):	Insert Value ⁽³⁾
BCF_{SS} (steady-state BCF; l kg^{-1})	Insert Value \pm SD ⁽²⁾
BCF_{SSL} (lipid normalised steady-state BCF; l kg^{-1}):	Insert Value ⁽³⁾ \pm SD ⁽²⁾
BCF_K (kinetic BCF; l kg^{-1})	Insert Value (95 % CI) ⁽¹⁾
BCF_{Kg} (growth-corrected kinetic BCF; l kg^{-1})	Insert Value (95 % CI) ⁽¹⁾
$t_{1/2g}$ (growth-corrected half-life; day):	Insert Value (95 % CI) ⁽¹⁾
BCF_{KL} (lipid-normalised kinetic BCF; l kg^{-1}):	Insert Value
BCF_{KLG} (lipid-normalised growth corrected kinetic BCF; l kg^{-1}):	Insert Value

⁽¹⁾ CI: confidence interval (where possible to estimate)
⁽²⁾ SD: Standard deviation (where possible to estimate)

Results reported as 'not detected/quantified at the limit of detection/quantification' by pre-test method development and experimental design should be avoided, since such results cannot be used for rate constant calculations.

C.13 - II: MINIMISED AQUEOUS EXPOSURE FISH TEST

INTRODUCTION

The growing experience that has been gained in conducting and interpreting the full test, both by laboratories and regulatory bodies, shows that — with some exceptions — first order kinetics apply for estimating uptake and depuration rate constants. Thus, uptake and depuration rate constants can be estimated with a minimum of sampling points, and the kinetic BCF derived.

The initial purpose of examining alternative designs for BCF studies was to develop a small test to be used in an intermediate testing step to refute or confirm BCF estimates based on K_{OW} and QSARs and so eliminate the need for a full study for many substances, and to minimise cost and animal use via reduction in sampling and in the number of analytical sequences performed. While following the main design of the previous test method to allow integration of test results with existing BCF data, and to ease performance of testing and data interpretation, the aim was to provide BCF estimates of adequate accuracy

▼ M7

and precision for risk assessment decisions. Many of the same considerations apply as in the full test, e.g. validity criteria (*cf.* paragraph 24) and stopping a test if insignificant uptake is seen at the end of the uptake phase (*cf.* paragraphs 16 and 38).

Substances that would be eligible for the minimised test design should belong to the general domain that this test method was developed for, *i.e.* non-polar organic substances (*cf.* paragraph 49). If there is any indication that the substance to be tested might show a different behaviour (e.g. a clear deviation from first-order kinetics), a full test should be conducted for regulatory purposes.

Typically, the minimised test is not run over a shorter period than the standard BCF test, but comprises less fish sampling (see Appendix 6 for the rationale). However, the depuration period may be shortened for rapidly depurating substances to avoid concentrations in the fish falling below the limit of detection/quantification before the end of the test. A minimised exposure fish test with a single concentration can be used to determine the need for a full test, and if the resulting data used to calculate rate constants and BCF are robust (*cf.* paragraph 93), the full test may be waived if the resulting BCF is far from regulatory values of concern.

In some cases, it may be advantageous to perform the minimised test design with more than one test concentration as a preliminary test to determine whether BCF estimates for a substance are concentration dependent. If the BCF estimates from the minimised test show concentration dependence, the performance of the full test will be necessary. If, based on such a minimised test, BCF estimates are not concentration dependent but the results are not considered definitive, then any subsequent full test could be performed at a single concentration, thereby reducing animal use in comparison to a two (or more) concentration full test.

Substances potentially eligible for the minimised test should:

- Be likely to exhibit approximate first order uptake and depuration kinetics, e.g. derived from read-across with similar substances;
- Have a $\log K_{OW} < 6$ unless rapid metabolism is expected ⁽¹⁾;
- Be sufficiently water-soluble with respect to the analytical technique (*cf.* paragraph 24);
- Be clearly quantifiable (*i.e.* concentrations should be at least one order of magnitude above the limit of quantification), both in fish and water, radioactive labelling is recommended (*cf.* paragraph 23); and
- Have a depuration period greater than its predicted half-life (*cf.* Appendix 5 for calculations), or the duration of depuration should be adjusted accordingly (*cf.* paragraph 91). An exception to this rule is allowed if rapid metabolism of the substance is expected.

⁽¹⁾ The minimised test may in fact be used to demonstrate rapid metabolism when it is known that rapid metabolism is likely.

▼ M7**SAMPLING SCHEDULE FOR STUDIES FOLLOWING THE MINIMISED DESIGN****Fish sampling**

Fish sampling is reduced to four sampling points:

- At the middle and end of the uptake phase (the latter being the beginning of depuration as well), e.g. after 14 and 28 days (33).
- At the middle of the depuration phase and at termination of the study (where substance concentration is < 10 % of the maximum concentration, or at least clearly past one half-life of the substance), e.g. after 7 and 14 days of depuration (33). If rapid depuration is expected or observed, it may be necessary to shorten the depuration period to avoid concentrations in the fish falling below the limit of quantification.
- Lipid measurement as in full study.
- Growth correction as in full study.
- The BCF is calculated as a kinetic BCF.

Water sampling

For the minimised design, water is sampled as in full study (*cf.* paragraph 54) or at least five times equally divided over the uptake phase, and weekly in the depuration phase.

Design modifications

Taking into account the test substance properties, valid QSAR predictions and the specific purpose of the study, some modifications in the design of the study can be considered:

- If greater precision is needed, more fish (6 or 8 instead of 4) could be used for the sample at the end of the uptake phase.
- Inclusion of an 'extra' group of fish to be used if depuration at 14 days (or the predicted end of the depuration phase) has not been sufficient for adequate depuration (*i.e.* > 50 %). If the predicted duration of the depuration phase is shorter or longer than 14 days, the sampling schedule should be adapted (*i.e.* one group of fish at the predicted end of the depuration phase, and one group after half that time).
- Use of two test concentrations to explore possible concentration dependence. If the results of the minimised test, conducted with two test concentrations, show that the BCF is not concentration dependent (*i.e.* differ less than 20 %), one test concentration may be considered sufficient in a full test, if it is conducted.
- It seems likely that models of bioaccumulation processes such as those proposed by Arnot *et al.* (35) can be used to assist in planning the length of uptake and depuration phases (see also Appendix 5).

Calculations

The rationale for this approach is that the bioconcentration factor in a full test can either be determined as a steady-state bioconcentration factor (BCF_{SS}) by calculating the ratio of the concentration of the test substance in the fish's tissue to the concentration of the test substance in the water, or by calculating the kinetic bioconcentration factor (BCF_K) as the ratio of the uptake rate constant k_1 to the depuration rate constant k_2 . The BCF_K is valid even if a steady-state concentration of a substance is not achieved during uptake, provided that uptake and

▼ M7

deuration act approximately according to first order kinetic processes. As an absolute minimum two data points are required to estimate uptake and deuration rate constants, one at the end of the uptake phase (*i.e.* at the beginning of the deuration phase) and one at the end (or after a significant part) of the deuration phase. The intermediate sampling point is recommended as a check on the uptake and deuration kinetics ⁽¹⁾. For calculations, see Appendixes 5 and 6.

Interpretation of the results

To assess the validity and informative value of the test, verify that the deuration period exceeds one half-life. Also, the BCF_{Km} (kinetic BCF derived from a minimised test) should be compared to the minimised BCF_{SS} value (which is the BCF_{SS} calculated at the end of the uptake phase, assuming that steady-state has been reached. This can only be assumed, as the number of sampling points is not sufficient for proving this). If the $BCF_{Km} < \text{minimised } BCF_{SS}$, the minimised BCF_{SS} should be the preferred value. If BCF_{Km} is less than 70 % of the minimised BCF_{SS} , the results are not valid, and a full test should be conducted.

If the minimised test gives a BCF_{Km} in the region of any value of regulatory concern, a full test should be conducted. If the result is far from any regulatory value of concern (well above or below), a full test may not be necessary, or a single concentration full test may be conducted if required by the relevant regulatory framework.

If a full test is found to be necessary after a minimised test at one concentration, this can be conducted at a second concentration. If the results are consistent, a further full test at a different concentration can be waived, as the bioconcentration of the substance is not expected to be concentration dependent. If the minimised test has been conducted at two concentrations, and the results show no concentration dependence, the full test may be conducted with only one concentration (*cf.* paragraph 87).

Test report

The test report for the minimised test should include all the information demanded for the full test (*cf.* paragraph 81), except that which is not possible to elaborate (*i.e.* a curve showing the time to steady-state and the steady-state bioconcentration factor; for the latter the minimised BCF_{ss} should be given instead). Additionally, it should also include the reasoning for using the minimised test and the resulting BCF_{Km} .

C.13 - III: DIETARY EXPOSURE BIOACCUMULATION FISH TEST**INTRODUCTION**

The method described in this section should be used for substances where the aqueous exposure methodology is not practicable (for example because stable, measurable water concentrations cannot be maintained, or adequate body burdens cannot be achieved within 60 days of exposure; see previous sections on the aqueous exposure method). It should be realised though that the endpoint from this test will be a dietary biomagnification factor (BMF) rather than a bioconcentration factor (BCF) ⁽²⁾.

In May 2001 a new method for the bioaccumulation testing of poorly water soluble organic substances was presented at the SETAC Europe conference

⁽¹⁾ When only two data points are measured, estimates of the confidence limits for BCF_{Km} can be made using bootstrap methods. When intermediate data points are also available confidence limits for BCF_{Km} can be calculated as in the full test.

⁽²⁾ See Appendix 1 for definitions and units

▼ M7

held in Madrid (36). This work built on various reported bioaccumulation studies in the literature using a dosing method involving spiked feed (*e.g.* (37)). Early in 2004 a draft protocol (38), designed to measure the bioaccumulation potential of poorly water soluble organic substances for which the standard water exposure bioconcentration method was not practicable, together with a supporting background document (39), was submitted to an EU PBT working group. Further justification given for the method was that potential environmental exposure to such poorly soluble substances (*i.e.* $\log K_{OW} > 5$) may be largely via the diet (*cf.* (40) (41) (42) (43) (44)). For this reason, dietary exposure tests are referred to in some published chemicals regulations⁽¹⁾. It should be realised however, that in the method described here exposure via the aqueous phase is carefully avoided and thus a BMF value from this test method cannot directly be compared to a BMF value from a field study (in which both water and dietary exposure may be combined).

This section of the present test method is based on this protocol (38) and is a new method that did not appear in the previous version of TM C.13. This alternative test allows the dietary exposure pathway to be directly investigated under controlled laboratory conditions.

Potential investigators should refer to paragraphs 1 to 14 of this test method for information on when the dietary exposure test may be preferred over the aqueous exposure test. Information on the various substance considerations is laid out, and should be considered before a test is conducted.

The use of radiolabelled test substances can be considered with similar considerations as for the aqueous exposure method (*cf.* paragraphs 6 and 65).

The dietary method can be used to test more than one substance in a single test, so long as certain criteria are fulfilled; these are explored further in paragraph 112. For simplicity the methodology here describes a test using only one test substance.

The dietary test is similar to the aqueous exposure method in many respects with the obvious exception of the exposure route. Hence many aspects of the method described here overlap with the aqueous exposure method described in the previous section. Cross-reference to relevant paragraphs in the previous section has been made as far as possible, but in the interests of readability and understanding a certain amount of duplication is unavoidable.

PRINCIPLE OF THE TEST

Flow-through or semi-static conditions can be employed (*cf.* paragraph 4); flow-through conditions are recommended to limit potential exposure of test substance via water as a result of any desorption from spiked food or faeces. The test consists of two phases: uptake (test substance-spiked feed) and depuration (clean, untreated feed) (*cf.* paragraph 16). In the uptake phase, a 'test' group of fish are

⁽¹⁾ For the purpose of Regulation (EC) No 1907/2006 concerning the Registration, Evaluation, Authorisation and Restriction of Chemicals (REACH) (OJ L 396, 30.12.2006, p. 1), this issue is addressed in the 'Guidance on Information Requirements and Chemical Safety Assessment', chapter R.7c, R.7.10.3.1; R.7.10.4.1; and figure R7.10-2.

▼ M7

fed a set diet of a commercial fish food of known composition, spiked with the test substance, on a daily basis. Fish ideally should consume all of the offered food (*cf.* paragraph 141). Fish are then fed the pure, untreated commercial fish food during the depuration phase. As for the aqueous exposure method, more than one test group with different spiked test substance concentrations can be used if necessary, but for the majority of highly hydrophobic organic test substances one test group is sufficient (*cf.* paragraphs 49 and 107). If semi-static conditions are used fish should be transferred to a new medium and/or a new test chamber at the end of the uptake phase (in case the medium and/or apparatus used in the uptake phase has been contaminated with the test substance through leaching). The concentrations of the test substance in the fish are measured in both phases of the test. In addition to the group of fish fed the spiked diet (the test group), a control group of fish is held under identical conditions and fed identically except that the commercial fish food diet is not spiked with test substance. This control group allows background levels of test substance to be quantified in unexposed fish and serves as a comparison for any treatment-related adverse effects noted in the test group(s) ⁽¹⁾. It also allows comparison of growth rate constants between groups as a check that similar quantities of offered diet have been consumed (potential differences in palatability between diets should also be considered in explaining different growth rate constants; *cf.* paragraph 138). It is important that during both the uptake and depuration phases, diets of nutritional equivalency are fed to the test and control groups.

An uptake phase that lasts 7-14 days is generally sufficient, based on experience from the method developers (38) (39). This range should minimise the cost of undertaking the test whilst still ensuring sufficient exposure for most substances. However, in some cases the uptake phase may be extended (*cf.* paragraph 127). During the uptake phase the substance concentration in the fish may not reach steady-state so data treatment and results from this method are usually based on a kinetic analysis of tissue residues. (Note: Equations for estimating time to steady-state can be applied here as for the aqueous exposure test — see Appendix 5). The depuration phase begins when the fish are first fed unspiked diet and typically lasts for up to 28 days or until the test substance can no longer be quantified in whole fish, whichever is the sooner. The depuration phase can be shortened or lengthened beyond 28 days, depending on the change with time in measured chemical concentrations and fish size.

This method allows the determination of the substance-specific half-life ($t_{1/2}$), from the depuration rate constant, k_2), the assimilation efficiency (absorption across the gut; a), the kinetic dietary biomagnification factor (BMF_K), the growth-corrected kinetic dietary biomagnification factor (BMF_{Kg}), and the lipid-corrected⁽²⁾ kinetic dietary biomagnification factor (BMF_{KL}) (and/or the growth- and lipid-corrected kinetic dietary biomagnification factor, BMF_{KgL}) for the test substance in fish. As for the aqueous exposure method, increase in fish mass during the test will result in dilution of test substance in growing fish and thus the (kinetic) BMF will be underestimated if not corrected for growth (*cf.* paragraphs 162 and 163). In addition, if it is estimated that steady-state was reached in the uptake phase an indicative steady-state BMF can be calculated. Approaches are available that make it feasible to estimate a kinetic bioconcentration factor (BCF_K) from data generated in the dietary study (e.g. (44) (45) (46) (47) (48)). Pros and cons of such approaches are discussed in Appendix 8.

⁽¹⁾ For most test substances, there should ideally be no detections in the control water. Background concentrations should only be relevant to naturally occurring materials (e.g., some metals) and substances that are ubiquitous in the environment.

⁽²⁾ As the BMF is defined as the ratio of the concentration of a substance in an organism to that in the organism's food at steady-state, lipid is taken into account by correcting for the contents of lipid in the organism and in the food, hence it is described more accurately as a 'correction'. This approach differs from 'normalisation' to a set organism lipid content as is done in the aqueous exposure bioconcentration test.

▼ M7

The test was designed primarily for poorly soluble non-polar organic substances that follow approximately first order uptake and depuration kinetics in fish. In case a substance is tested that does not follow approximately first order uptake and depuration kinetics, then more complex models should be employed (see references in Appendix 5) and advice from a biostatistician and/or pharmacokineticist sought.

The BMF is normally determined using test substance analysis of whole fish (wet weight basis). If relevant for the objectives of the study, specific tissues (e.g. muscle, liver) can be sampled if the fish is divided into edible and non-edible parts (*cf.* paragraph 21). Furthermore, removal and separate analysis of the gastrointestinal tract may be employed to determine the contribution to whole fish concentrations for sample points at the end of the uptake phase and near the beginning of the depuration phase, or as part of a mass balance approach.

Lipid content of sampled whole fish should be measured so that concentrations can be lipid-corrected, taking account of lipid content of both the diet and the fish (*cf.* paragraphs 56 and 57, and Appendix 7).

Fish weight of sampled individuals should be measured and recorded, and be linked to the analysed chemical concentration for that individual (e.g. reported using a unique identifier code for each fish sampled), for the purpose of calculating growth that may occur during the test. Fish total length should also be measured where possible⁽¹⁾. Weight data are also necessary for estimating BCF using depuration data from the dietary test.

INFORMATION ON THE TEST SUBSTANCE

Information on the test substance as described in paragraphs 3 and 22 should be available. An analytical method for test substance concentrations in water is not usually necessary; methods with suitable sensitivity for measuring concentrations in fish food and fish tissue are required.

The method can be used to test more than one substance in a single test. However, test substances should be compatible with one another such that they do not interact or change their chemical identity upon spiking into fish food. The aim is that measured results for each substance tested together should not differ greatly from the results that would be given if individual tests had been run on each test substance. Preliminary analytical work should establish that each substance can be recovered from a multiply-spiked food and fish tissue sample with i) high recoveries (e.g. > 85 % of nominal) and ii) the necessary sensitivity for testing. The total dose of substances tested together should be below the combined concentration that might cause toxic effects (*cf.* paragraph 51). Furthermore, possible adverse effects in fish and the potential for interactive effects (e.g. metabolic effects) associated with testing multiple substances simultaneously should be taken into consideration in the experimental design. Simultaneous testing of ionisable substances should be avoided. In terms of exposure, the method is also suitable for complex mixtures (*cf.* paragraph 13, although the same limitations in analysis as for any other method will apply).

VALIDITY OF THE TEST

For a test to be valid the following conditions apply (*cf.* paragraph 24):

— Water temperature variation is less than ± 2 °C in treatment or control groups

⁽¹⁾ Total length should also be recorded during the test as it is a good indicator of whether an adverse effect has occurred.

▼M7

- Concentration of dissolved oxygen does not fall below 60 % of the air saturation value

- The concentration of the test substance in fish food before and at the end of the uptake phase is within a range of ± 20 % (based on at least three samples at both time points)

- A high degree of homogeneity of substance in food should be demonstrated in preliminary analytical work on the spiked diet; at least three sample concentrations for the substance taken at test start should not vary more than ± 15 % from the mean

- Concentrations of test substance are not detected, or are present only at typical trace levels, in un-spiked food or control fish tissues relative to treated samples

- Mortality or other adverse effects/disease in both control and test group fish should be ≤ 10 % at the end of the test; if the test is extended for any reason, adverse effects in both groups are ≤ 5 % per month, and ≤ 30 % cumulatively. Significant differences in average growth between the test and the control groups of sampled fish could be an indication of a toxic effect of the test substance.

REFERENCE SUBSTANCES

If a laboratory has not performed the assay before or substantial changes (e.g. change of fish strain or supplier, different fish species, significant change of fish size, fish food or spiking method, etc.) have been made, it is advisable that a technical proficiency study is conducted, using a reference substance. The reference substance is primarily used to establish whether the food spiking technique is adequate to ensure maximum homogeneity and bioavailability of test substances. One example that has been used in the case of non-polar hydrophobic substances is hexachlorobenzene (HCB), but other substances with existing reliable data on uptake and biomagnification should be considered due to the hazardous property of HCB ⁽¹⁾. If used, basic information on the reference substance should be presented in the test report, including name, purity, CAS number, structure, toxicity data (if available) as for test substances (*cf.* paragraphs 3 and 22).

DESCRIPTION OF THE METHOD

Apparatus

Materials and apparatus should be used as described in the aqueous exposure method (*cf.* paragraph 26). A flow-through or static renewal test system that provides a sufficient volume of dilution water to the test tanks should be used. The flow rates should be recorded.

Water

Test water should be used as described in the aqueous exposure method (*cf.* paragraphs 27-29). The test medium should be characterised as described and its quality should remain constant during the test. The natural particle content and total organic carbon should be as low as possible (≤ 5 mg/l particulate matter; ≤ 2 mg/l total organic carbon) before test start. TOC need only be measured before the test as part of the test water characterisation (*cf.* paragraph 53).

⁽¹⁾ HCB is listed in Annexes A and C to the Stockholm Convention, and in Annexes I and III of Regulation (EC) No 850/2004 on persistent organic pollutants (OJ L 158, 30.4.2004, p. 7)

▼ M7**Diet**

A commercially available fish food (floating and/or slow sinking pelletised diet) that is characterised in terms of at least protein and fat content is recommended. The food should have a uniform pellet size to increase the efficiency of the feed exposure, *i.e.* the fish will eat more of the food instead of eating the larger pieces and missing the smaller ones. The pellets should be appropriately sized for the size of the fish at the start of the test (e.g. pellet diameters roughly 0,6-0,85 mm for fish between 3 and 7 cm total length, and 0,85-1,2 mm for fish between 6 and 12 cm total length may be used). Pellet size may be adjusted depending on fish growth at the start of the depuration phase. An example of a suitable food composition, as commercially supplied, is given in Appendix 7. Test diets with total lipid content between 15 and 20 % (w/w) have commonly been used in the development of this method. Fish food with such a high lipid concentration may not be available in some regions. In such cases studies could be run with a lower lipid concentration in the food, and if necessary the feeding rate adjusted appropriately to maintain fish health (based on preliminary testing). The total lipid content of the test group and control group diets needs to be measured and recorded before the start of the test and at the end of the uptake phase. Details provided by the commercial feed supplier of analysis for nutrients, moisture, fibre and ash, and if possible minerals and pesticide residues (e.g. 'standard' priority pollutants), should be presented in the study report.

When spiking the food with test substance, all possible efforts should be made to ensure homogeneity throughout the test food. The concentration of test substance in the food for the test group should be selected taking into account the sensitivity of the analytical technique, the test substance's toxicity (NOEC if known) and relevant physicochemical data. If used, the reference substance should preferably be incorporated at a concentration around 10 % of that of the test substance (or in any case as low as is practicable), subject to analysis sensitivity (e.g. for hexachlorobenzene a concentration in the food of 1-100 µg/g has been found to be acceptable; *cf.* (47) for more information on assimilation efficiencies of HCB).

The test substance can be spiked to the fish food in several ways depending on its physical characteristics and solubility (see Appendix 7 for more details on spiking methods):

- If the substance is soluble and stable in triglycerides, the substance should be dissolved in a small amount of fish oil or edible vegetable oil before mixing with fish food. In this instance, care should be taken to avoid producing a ration that is too high in lipid, taking into account the natural lipid content of the spiked feed, by adding the minimum known quantity of oil required to achieve distribution and homogeneity of the test substance in the food, or;

- The food should be spiked using a suitable organic solvent, so long as homogeneity and bioavailability are not compromised (it is possible that (micro)crystals of the test substance may form in the food as a consequence of solvent evaporation and there is no easy way to prove this has not occurred; *cf.* (49)), or;

- Non-viscous liquids should be added directly to fish food but they should be well mixed to promote homogeneity and facilitate good assimilation. The technique for mixing should ensure homogeneity of the spiked feed.

▼ M7

In few cases, e.g. less hydrophobic test substances more likely to desorb from the food, it may be necessary to coat prepared food pellets with a small quantity of corn/fish oil (see paragraph 142). In such cases, control food should be treated similarly and the final prepared feed used for lipid measurement.

If used, the results of the reference substance should be comparable with literature study data carried out under similar conditions with a comparable feeding rate (*cf.* paragraph 45) and reference substance-specific parameters should meet the relevant criteria in paragraph 113 (3rd, 4th and 5th points).

If an oil or carrier solvent is used as a vehicle for the test substance, an equivalent amount of the same vehicle (excluding test substance) should be mixed with the control diet in order to maintain equivalency with the spiked diet. It is important that during both the uptake and depuration phases, diets of nutritional equivalency are fed to the test and control groups.

The spiked diet should be stored under conditions that maintain stability of the test substance within the feed mix (e.g. refrigeration) and these conditions reported.

Selection of fish species

Fish species as specified for the aqueous exposure may be used (*cf.* paragraph 32 and Appendix 3). Rainbow trout (*Oncorhynchus mykiss*), carp (*Cyprinus carpio*) and fathead minnow (*Pimephales promelas*) have been commonly used in dietary bioaccumulation studies with organic substances before the publication of this TM. The test species should have a feeding behaviour that results in rapid consumption of the administered food ration to ensure that any factor influencing the concentration of the test substance in food (e.g. leaching into the water and the possibility of aqueous exposure) is kept to a minimum. Fish within the recommended size/weight range (*cf.* Appendix 3) should be used. Fish should not be so small as to hamper ease of analyses on an individual basis. Species tested during a life-stage with rapid growth can complicate data interpretation, and high growth rates can influence the calculation of assimilation efficiency⁽¹⁾.

Holding of fish

Acclimatisation, mortality and disease acceptance criteria are the same as for the aqueous exposure method prior to test conductance (*cf.* paragraphs 33-35).

PERFORMANCE OF THE TEST**Pre-study work and range-finding test**

Pre-study analytical work is necessary to demonstrate recovery of the substance from spiked food/spiked fish tissue. A range-finding test to select a suitable concentration in the food is not always necessary. For the purposes of showing that no adverse effects are observed and evaluating the palatability of spiked diet, sensitivity of analytical method for fish tissue and food, and selection

⁽¹⁾ For rapid growth during the uptake phase the true feeding rate will decrease below that set at the beginning of exposure.

▼ **M7**

of suitable feeding rate and sampling intervals during depuration phase etc., preliminary feeding experiments may be undertaken but are not obligatory. A preliminary study may be valuable to estimate numbers of fish needed for sampling during the depuration phase. This can result in significant reduction in the number of fish used, especially for test substances that are particularly susceptible to metabolism.

Conditions of exposure

Uptake Phase duration

An uptake phase of 7-14 days is usually sufficient, during which one group of fish are fed the control diet and another group of fish the test diet daily at a fixed ration dependent on the species tested and the experimental conditions, e.g. between 1-2 % of body weight (wet weight) in the case of rainbow trout. The feeding rate should be selected such that fast growth and large increase of lipid content are avoided. If needed the uptake phase may be extended based on practical experience from previous studies or knowledge of the test substance's (or analogue's) uptake/depuration in fish. The start of the test is defined as the time of first feeding with spiked food. An experimental day runs from the time of feeding to shortly before the time of next feeding (e.g. one hour). Thus the first experimental day of uptake runs from the time of first feeding with spiked food and ends shortly before the second feeding with spiked food. In practice the uptake phase ends shortly before (e.g. one hour) the first feeding with unspiked test substance as the fish will continue to digest spiked food and absorb the test substance in the intervening 24 hours. It is important to ensure that a sufficiently high (non-toxic) body burden of the test substance is achieved with respect to the analytical method, so that at least an order of magnitude decline can be measured during the depuration phase. In special cases an extended uptake phase (up to 28 days) may be used with additional sampling to gain an insight into uptake kinetics. During uptake the concentration in the fish may not reach steady-state. Equations for estimating time to steady-state, as an indication of the likely duration needed to achieve appreciable fish concentrations, can be applied here as for the aqueous exposure test (*cf.* Appendix 5).

In some cases it may be known that uptake of substance in the fish over 7-14 days will be insufficient for the food concentration used to reach a high enough fish concentration to analyse at least an order of magnitude decline during depuration, either due to poor analytical sensitivity or to low assimilation efficiency. In such cases it may be advantageous to extend the initial feeding phase to longer than 14 days, or, especially for highly metabolisable substances, a higher dietary concentration should be considered. However, care should be taken to keep the body burden during uptake below the (estimated) chronic no effect concentration (NOEC) in fish tissue (*cf.* paragraph 138).

Duration of the depuration phase

Depuration typically lasts for up to 28 days, beginning once the test group fish are fed pure, untreated diet after the uptake phase. Depuration begins with the first feeding of 'unspiked' food rather than straight after the last 'spiked' food feeding as the fish will continue to digest the food and absorb the test substance in the intervening 24 hours, as noted in paragraph 126. Hence the first sample in the depuration phase is taken shortly before the second feeding with unspiked diet. This depuration period is designed to capture substances with a potential half-life of up to 14 days, which is consistent with that of bioaccumulative substances⁽¹⁾, so 28 days comprises two half-lives of such substances. In

⁽¹⁾ In an aqueous exposure study, a 14-day half-life would correspond to a BCF of ca. 10 000 L/kg using fish of 1 g with a corresponding uptake rate of about 500 L/kg/d (according to the equation of Sijm *et al* (46)).

▼ M7

cases of very highly bioaccumulating substances it may be advantageous to extend the depuration phase (if indicated by preliminary testing).

If a substance is depurated very slowly such that an exact half-life may not be determined in the depuration phase, the information may still be sufficient for assessment purposes to indicate a high level of bioaccumulation. Conversely, if a substance is depurated so fast that a reliable time zero concentration (concentration at the end of uptake/start of depuration, $C_{0,d}$) and k_2 cannot be derived, a conservative estimate of k_2 can be made (*cf.* Appendix 7).

If analyses of fish at earlier intervals (e.g. 7 or 14 days) show that the substance has depurated below quantification levels before the full 28-day period, then subsequent sampling may be discontinued and the test terminated.

In few cases no measurable uptake of the test substance may have occurred at the end of the uptake period (or with the second depuration sample). If it can be demonstrated that: i) the validity criteria in paragraph 113 are fulfilled; and ii) lack of uptake is not due to some other shortcoming of the test (e.g. uptake duration not long enough, deficiency in food spiking technique leading to poor bioavailability, lack of sensitivity of the analytical method, fish not consuming food, etc.); it may be possible to terminate the study without the need to re-run it with a longer uptake duration. If preliminary work has indicated that this may be the case, analysis of faeces, if possible, for undigested test substance may be advisable as part of a 'mass balance' approach.

Numbers of test fish

Similar to the aqueous exposure test, fish of similar weight and length should be selected, with the smallest fish being no less than two-thirds of the weight of the largest (*cf.* paragraphs 40-42).

The total number of fish for the study should be selected based on the sampling schedule (a minimum of one sample at the end of the uptake phase and four to six samples during the depuration phase, but depending on the phases' durations), taking into account the sensitivity of the analytical technique, the concentration likely to be achieved at the end of the uptake phase (based on prior knowledge) and the depuration duration (if prior knowledge allows estimation). Five to ten fish should be sampled at each event, with growth parameters (weight and total length) being measured before chemical or lipid analysis.

Owing to the inherent variability in the size, growth rate, and physiology among fish and the likely variation in the quantity of administered diet that each fish consumes, at least five fish should be sampled at each interval from the test group and five from the control group in order to adequately establish the average concentration and its variability. The variability among the fish used is likely to contribute more to the overall uncontrolled variability in the test than the variability inherent in the analytical methodologies employed, and thus justifies the use of up to ten fish per sample point in some cases. However, if background test substance concentrations in control fish are not measurable at the start of depuration, chemical analysis of two-three control fish at the final sampling interval only may be sufficient so long as the remaining control fish at all sample points are still sampled for weight and total length (so that the same number are sampled from test and control groups for growth). Fish should be stored, weighed individually (even if it proves necessary for the sample results to be combined subsequently) and total length measured.

▼ M7

For a standard test with, for example, a 28-day depuration duration including five depuration samples, this means a total of 59-120 fish from test and 50-110 from control groups, assuming that the substance's analytical technique allows lipid content analysis to be carried out on the same fish. If lipid analysis cannot be conducted on the same fish as chemical analysis, and using control fish only for lipid analysis is also not feasible (*cf.* paragraph 56), an additional 15 fish would be required (three from the stock population at test start, three each from control and test groups at the start of depuration and three each from control and test groups at the end of the experiment). An example sampling schedule with fish numbers can be found in Appendix 4.

Loading

Similarly high water-to-fish ratios should be used as for the aqueous exposure method (*cf.* paragraphs 43 and 44). Although fish-to-water loading rates do not have an effect on exposure concentrations in this test, a loading rate of 0,1-1,0 g of fish (wet weight) per litre of water per day is recommended to maintain adequate dissolved oxygen concentrations and minimise test organism stress.

Test diet and Feeding

During the acclimatisation period, fish should be fed an appropriate diet as described above (paragraph 117). If the test is being conducted under flow-through conditions, the flow should be suspended while the fish are fed.

During the test, the diet for the test group should adhere to that described above (paragraphs 116-121). In addition to consideration of substance-specific factors, analytical sensitivity, expected concentration in the diet under environmental conditions and chronic toxicity levels/body burden, selection of the target spiking concentration should take into account palatability of the food (so that fish do not avoid eating). Nominal spiking concentration of the test substance should be documented in the report. Based on experience, spiking concentrations in the range of 1-1 000 µg/g provide a practical working range for test substances that do not exhibit a specific toxic mechanism. For substances acting via a non-specific mechanism, tissue residue levels should not exceed 5 µmol/g lipid since residues above this level are likely to pose chronic effects (19) (48) (50) ⁽¹⁾. For other substances care should be taken that no adverse effects occur from the accumulated exposure (*cf.* paragraph 127). This is especially true if more than one substance is being tested simultaneously (*cf. paragraph* 112).

The appropriate amount of the test substance can be spiked to the fish food in one of three ways, as described in paragraph 119 and Appendix 7. The methods and procedures for spiking the feed should be documented in the report. Untreated food is fed to the control fish, containing an equivalent quantity of unspiked oil vehicle if this has been used in the spiked feed for the uptake phase, or having been treated with 'pure' solvent if a solvent vehicle was used for test group diet preparation. The treated and untreated diets should be measured analytically at least in triplicate for test substance concentration before the start and at the end of the uptake phase. After exposure to the treated feed (uptake phase), fish (both groups) are fed untreated food (depuration phase).

Fish are fed at a fixed ration (dependent on species; e.g. approximately 1-2 % of wet body weight per day in the case of rainbow trout). The feeding rate should

⁽¹⁾ Since the actual internal concentrations can only be determined after the test has been performed, an estimate of the expected internal concentration is needed (e.g. based on the expected BMF and the concentration in the food; *cf.* Equation A5.8 in Appendix 5).

▼ M7

be selected such that fast growth and large increase of lipid content are avoided. The exact feeding rate set during the experiment should be recorded. Initial feeding should be based on the scheduled weight measurements of the stock population just prior to the start of the test. The amount of feed should be adjusted based on the wet weights of sampled fish at each sampling event to account for growth during the experiment. Weights and lengths of fish in the test and control tanks can be estimated from the weights and total lengths of fish used at each sampling event; do not weigh or measure the fish remaining in the test and control tanks. It is important to maintain the same set feeding rate throughout the experiment.

Feeding should be observed to ensure that the fish are visibly consuming all of the food presented in order to guarantee that the appropriate ingestion rates are used in the calculations. Preliminary feeding experiments or previous experience should be considered when selecting a feeding rate that will ensure that all food from once-daily feeding is consumed. In the event that food is consistently being left uneaten, it may be advisable to spread the dose over an extra feeding period in each experimental day (e.g. replace once-daily feeding with feeding half the amount twice daily). If this is necessary, the second feeding should occur at a set time and be timed so that the maximum period of time possible passes before fish sampling (e.g. time for second feeding is set within the first half of an experimental day).

Although fish generally rapidly consume the food, it is important to ensure that the substance remains adsorbed to the food. Efforts should be made to avoid the test substance becoming dispersed in water from the food, thereby exposing the fish to aqueous concentrations of the test substance in addition to the dietary route. This can be achieved by removing any uneaten food (and faeces) from the test and control tanks within one hour of feeding, but preferably within 30 minutes. In addition, a system where the water is continuously cleaned over an active carbon filter to absorb any 'dissolved' contaminant may be used. Flow-through systems may help to flush away food particles and dissolved substances rapidly⁽¹⁾. In some cases, a slightly modified spiked food preparation technique can help to alleviate this problem (see paragraph 119).

Light and Temperature

As for the aqueous exposure method (*cf.* paragraph 48), a 12 to 16 hour photoperiod is recommended and temperature (± 2 °C) appropriate for the test species used (*cf.* Appendix 3). Type and characteristics of illumination should be known and documented.

Controls

One control group should be used, with fish fed the same ration as the test group but without the test substance present in the feed. If an oil or solvent vehicle has been used to spike the feed in the test group, the control group food should be treated in exactly the same way but with the absence of test substance so that the diets of the test group and control group are equivalent (*cf.* paragraphs 121 and 139).

⁽¹⁾ The presence of the test substance in the test medium as a result of excretion by the fish or leaching from food may not be totally avoidable. Therefore one option is to measure the substance concentration in water at the end of the uptake period, especially if a semi-static set up is used, to help to establish whether any aqueous exposure has occurred.

▼ M7**Frequency of Water Quality Measurements**

The conditions described in the aqueous exposure method apply here also, except that TOC need only be measured before the test as part of the test water characterisation (*cf.* paragraph 53).

Sampling and Analysis of Fish and Diet*Analysis of Diet Samples*

Samples of the test and control diets should be analysed at least in triplicate for the test substance and for lipid content at least before the beginning and at the end of the uptake phase. The methods of analysis and procedures for ensuring homogeneity of the diet should be included in the report.

Samples should be analysed for the test substance by the established and validated method. Pre-study work should be conducted to establish the limit of quantification, percent recovery, interferences and analytical variability in the intended sample matrix. If a radiolabelled material is being tested, similar considerations as those for the aqueous exposure method should be considered with feed analysis replacing water analysis (*cf.* paragraph 65).

Analysis of Fish

At each fish sampling event, 5-10 individuals will be sampled from exposure and control treatments (in some instances numbers of control fish can be reduced; *cf.* paragraph 134).

Sampling events should occur at the same time on each experimental day (relative to feeding time), and should be timed so that the likelihood of food remaining in the gut during the uptake phase and the early part of the depuration phase is minimised to prevent spurious contributions to total test substance concentrations (*i.e.* sampled fish should be removed at the end of an experimental day, keeping in mind that an experimental day starts at the time of feeding and ends at the time of the next feeding, approximately 24 hours later. Depuration begins with the first feeding of unspiked food; *cf.* paragraph 128). The first depuration phase sample (taken shortly before the second feeding with unspiked food) is important as extrapolation back one day from this measurement is used to estimate the time zero concentration ($C_{0,d}$, the concentration in the fish at the end of uptake/start of depuration). Optionally, the gastrointestinal tract of the fish can be removed and analysed separately at the end of uptake and at days 1 and 3 of depuration.

At each sampling event fish should be removed from both test vessels and treated in the same way as described in the aqueous method (*cf.* paragraphs 61-63).

Concentrations of test substance in whole fish (wet weight) are measured at least at the end of the uptake phase and during the depuration phase in both control and test groups. During the depuration phase, four to six sampling points are recommended (e.g. 1, 3, 7, 14 and 28 days). Optionally, an additional sampling point may be included after 1-3 days' uptake to estimate assimilation efficiency from the linear phase of uptake for the fish while still near the beginning of the exposure period. Two main deviations from the schedule exist: i) if an extended uptake phase is employed for the purposes of investigating uptake kinetics, there will be additional sampling points during the uptake phase and so additional fish will need to be included (*cf.* paragraph 126); ii) if the study has been terminated at the end of the uptake phase owing to no measurable uptake (*cf.* paragraph 131). Individual fish that are sampled should be weighed (and

▼ **M7**

their total length measured) to allow growth rate constants to be determined. Concentrations of the substance in specific fish tissue (edible and non-edible portions) can also be measured at the end of uptake and selected depuration times. If a radiolabelled material is being tested, similar considerations as those for the aqueous exposure method should be considered with feed analysis replacing water analysis (*cf.* paragraph 65).

For the periodic use of a reference substance (*cf.* paragraph 25), it is preferable that concentrations are measured in the test group at the end of uptake and at all depuration times specified for the test substance (whole fish); concentrations need only be analysed in the control group at end of uptake (whole fish). In certain circumstances (for example if analysis techniques for test substance and reference substance are incompatible, such that additional fish would be needed to follow the sampling schedule) another approach may be used as follows to minimise the number of additional fish required. Concentrations of the reference substance are measured during depuration only on days 1, 3 and two further sampling points, selected such that reliable estimations of time zero concentration ($C_{0,d}$) and k_2 can be made for the reference substance.

If possible the lipid content of the individual fish should be determined on each sampling occasion, or at least at the start and end of the uptake phase and at the end of the depuration phase. (*cf.* paragraphs 56 and 67). Depending on the analytical method (refer to paragraph 67 and to Appendix 4), it may be possible to use the same fish for both lipid content and test substance concentration determination. This is preferred on the grounds of minimising fish numbers. However, should this not be possible, the same approach as described in the aqueous exposure method can be used (see paragraph 56 for these alternative lipid measurement options). The method used to quantify the lipid content should be documented in the report.

Quality of the analytical method

Experimental checks should be conducted to ensure the specificity, accuracy, precision and reproducibility of the substance-specific analytical technique, as well as recoveries of the test substance from both food and fish.

Fish growth measurement

At the start of the test a sample of fish from the stock population need to be weighed (and their total length measured). These fish should be sampled shortly before the first spiked feeding (e.g. one hour), and assigned to experimental day 0. The number of fish for this sample should be at least the same as that for the samples during the test. Some of these can be the same fish used for lipid analysis before the start of the uptake phase (*cf.* paragraph 153). At each sampling interval fish are first weighed and their length measured. In each individual fish the measured weight (and length) should be linked to the analysed chemical concentration (and lipid content, if applicable), for example using a unique identifier code for each sampled fish. The measurements of these sampled fish can be used to estimate the weight (and length) of fish remaining in the test and control tanks.

Experimental Evaluation

Observations of mortality should be performed and recorded daily. Additional observations for adverse effects should be performed, for example for abnormal behaviour or pigmentation, and recorded. Fish are considered dead if there is no respiratory movement and no reaction to a slight mechanical stimulus can be detected. Any dead or clearly moribund fish should be removed.

▼ **M7****DATA AND REPORTING****Treatment of results**

Test results are used to derive the depuration rate constant (k_2) as a function of the total wet weight of the fish. Growth rate constant, k_g , based on mean increase in fish weight is calculated and used to produce the growth-corrected depuration rate constant, k_{2g} , if appropriate. In addition, the assimilation efficiency (a; absorption from the gut), the kinetic biomagnification factor (BMF_K) (if necessary growth corrected, BMF_{Kg}), its lipid-corrected value (BMF_{KL} or BMF_{KgL} , if corrected for growth dilution) and feeding rate should be reported. Also, if an estimate of the time to steady-state in the uptake phase can be made (e.g. 95 % of steady-state or $t_{95} = 3,0/k_2$), an estimate of the steady-state BMF (BMF_{SS}) can be included (*cf.* paragraphs 105 and 106, and Appendix 5) if the t_{95} value indicates that steady-state conditions may have been reached. The same lipid correction should be applied to this BMF_{SS} as to the kinetically-derived BMF (BMF_K) to give a lipid-corrected value, BMF_{SSL} (note that no agreed procedure is available to correct a steady-state BMF for growth dilution). Formulae and example calculations are presented in Appendix 7. Approaches are available that make it feasible to estimate a kinetic bioconcentration factor (BCF_K) from data generated in the dietary study. This is discussed in Appendix 8.

Fish weight/length data

Individual fish wet weights and lengths for all time periods are tabulated separately for test and control groups for all sampling days during the uptake phase (stock population for start of uptake; control group and test group for end of uptake and, if conducted, the early phase (e.g. day 1-3 of uptake) and depuration phase (e.g. days 1, 2, 4, 7, 14, 28, for control and test group). Weight is the preferred measure of growth for growth dilution correction purposes. See below (paragraphs 162 and 163) and Appendix 5 for the method(s) used to correct data for growth dilution.

Test substance concentration in fish data

Individual fish test substance residue measurements (or pooled fish samples if individual fish measurements are not possible), expressed in terms of wet weight concentration (w/w), are tabulated for test and control fish for individual sample times. If lipid analysis has been conducted on each sampled fish then individual lipid-corrected concentrations, in terms of lipid concentration (w/w lipid), can be derived and tabulated.

- Test substance residue measurements in individual fish (or pooled fish samples if individual fish measurements are not possible, *cf.* paragraph 66) for the depuration period are converted to their natural logarithms and plotted versus time (day). If a visual inspection of the plot shows obvious outliers, a statistically valid outlier test may be applied to remove spurious data points as well as documented justification for their omission.
- A linear least squares correlation is calculated for the $\ln(\text{concentration})$ vs. depuration (day) data. The slope and intercept of the line are reported as the overall depuration rate constant (k_2) and natural logarithm of the derived time zero concentration ($C_{0,d}$) (*cf.* Appendix 5 and Appendix 7 for further details). Should this not be possible because concentrations fall below the limit of quantification for the second depuration sample, a conservative estimate of k_2 can be made (*cf.* Appendix 7).
- The variances in the slope and intercept of the line are calculated using standard statistical procedures and the 90 % (or 95 %) confidence intervals around these results evaluated and presented.

▼ **M7**

- The mean measured fish concentration for the final day of uptake (measured time zero concentration, $C_{0,m}$) is also calculated and compared with the derived value $C_{0,d}$. In case the derived value is lower than the measured value, the difference may suggest the presence of undigested spiked food in the gut. If the derived value is very much higher than the measured value, this may be an indication that the value derived from the depuration data linear regression is erroneous and should be re-evaluated (see Appendix 7).

Depuration rate and biomagnification factor

To calculate the biomagnification factor from the data, first the assimilation efficiency (absorption of test substance across the gut, α) should be obtained. To do this, equation A7.1 in Appendix 7 should be used, requiring the derived concentration in fish at time zero of the depuration phase ($C_{0,d}$), (overall) depuration rate constant (k_2), concentration in the food (C_{food}), food ingestion rate constant (I) and duration of the uptake period (t) to be known. The slope and intercept of the linear relationship between $\ln(\text{concentration})$ and depuration time are reported as the overall depuration rate constant ($k_2 = \text{slope}$) and time zero concentration ($C_{0,d} = e^{\text{intercept}}$), as above. The derived values should be checked for biological plausibility (e.g. assimilation efficiency as a fraction is not greater than 1). (I) is calculated by dividing the mass of food by the mass of fish fed each day (if fed at 2 % of body weight, (I) will be 0,02). However, the feeding rate used in the calculation may need to be adjusted for fish growth (this can be done using the known growth rate constant to estimate the fish weight at each time-point during the uptake phase; *cf.* Appendix 7). In cases where k_2 and $C_{0,d}$ cannot be derived because, for example, concentrations fell below the limit of detection for the second depuration sample, a conservative estimate of k_2 and an 'upper bound' BMF_k can be made (*cf.* Appendix 7).

Once the assimilation efficiency (α) is obtained, the biomagnification factor can be calculated by multiplying α by the ingestion rate constant (I) and dividing by the (overall) depuration rate constant (k_2). The growth-corrected biomagnification factor is calculated in the same way but using the growth-corrected depuration rate constant (k_{2g} ; *cf.* paragraphs 162 and 163). An alternative estimate of the assimilation efficiency can be derived if tissue analysis was performed on fish sampled in the early, linear phase of the uptake phase; *cf.* paragraph 151 and Appendix 7. This value represents an independent estimate of assimilation efficiency for an essentially unexposed organism (*i.e.* the fish are near the beginning of the uptake phase). The assimilation efficiency estimated from depuration data is usually used to derive the BMF.

Lipid Correction and Growth-Dilution Correction

Fish growth during the depuration phase can lower measured chemical concentrations in the fish with the effect that the overall depuration rate constant, k_2 , is greater than would arise from removal processes (e.g. metabolism, egestion) alone (*cf.* paragraph 72). Lipid contents of test fish (which are strongly associated with the bioaccumulation of hydrophobic substances) and lipid contents of food can vary enough in practice such that their correction is necessary to present biomagnification factors in a meaningful way. The biomagnification factor should be corrected for growth dilution (as is the kinetic BCF in the aqueous exposure method) and corrected for the lipid content of the food relative to that of the fish (the lipid-correction factor). Equations and examples for these calculations can be found in Appendix 5 and Appendix 7, respectively.

To correct for growth dilution, the growth-corrected depuration rate constant (k_{2g}) should be calculated (see Appendix 5 for equations). This growth-corrected depuration rate constant (k_{2g}) is then used to calculate the growth-corrected biomagnification factor, as in paragraph 73. In some cases this approach is not

▼ **M7**

possible. An alternative approach that circumvents the need for growth dilution correction involves using mass of test substance per fish (whole fish basis) depuration data rather than the usual mass of test substance per unit mass of fish (concentration) data. This can be easily achieved as tests according to this method should link recorded tissue concentrations to individual fish weights. The simple procedure for doing this is outlined in Appendix 5. Note that k_2 should still be estimated and reported even if this alternative approach is used.

To correct for the lipid content of the food and fish when lipid analysis has not been conducted on all sampled fish, the mean lipid fractions (w/w) in the fish and in the food are derived ⁽¹⁾. The lipid correction factor (L_c) is then calculated by dividing the fish mean lipid fraction by the mean food lipid fraction. The biomagnification factor, growth corrected or not as applicable, is divided by the lipid correction factor to calculate the lipid-corrected biomagnification factor.

If chemical and lipid analyses were conducted on the same fish at each sampling point, then the lipid-corrected tissue data for individual fish may be used to calculate a lipid-corrected BMF directly (*cf.* (37)). The plot of lipid-corrected concentration data gives $C_{0,d}$ on a lipid basis and k_2 . Mathematical analysis can then proceed using the same equations in Appendix 7, but assimilation efficiency (a) is calculated using the lipid-normalised food ingestion rate constant (I_{lipid}) and the dietary concentration on a lipid basis ($C_{food-lipid}$). Lipid corrected parameters are similarly then used to calculate BMF (note that growth rate constant correction should also be applied to the lipid fraction rather than the fish wet weight to calculate the lipid-corrected, growth corrected BMF_{KGL}).

Interpretation of results

Average growth in both test and control groups should in principle not be significantly different to exclude toxic effects. The growth rate constants or the growth curves of the two groups should be compared by an appropriate procedure ⁽²⁾.

Test report

After termination of the study, a final report is prepared containing the information on *Test Substance*, *Test Species* and *Test Conditions* as listed in paragraph 81 (as for the aqueous exposure method). In addition, the following information is required:

Test Substance:

— Any information on stability of the test substance in prepared food;

⁽¹⁾ This approach is specific to the dietary study, distinct from the procedure followed in the aqueous exposure, hence the word 'correction' has been used rather than 'normalisation' to prevent confusion — see also footnote in paragraph 106.

⁽²⁾ A *t*-test on growth rate constants can be performed, to test whether growth differs between control and test groups, or an *F*-test in case of analysis of variance. If needed, an *F*-test or likelihood ratio test can be used to assist in the choice of the appropriate growth model (OECD monograph 54, (32)).

▼ M7*Test Conditions:*

- Substance nominal concentration in food, spiking technique, amount of (lipid) vehicle used in food spiking process (if used), test substance concentration measurements in spiked diet for each analysis (at least in triplicate before study start and at end of uptake) and mean values;
- If used, type and quality of carrier oil or solvent (grade, supplier, etc.) used for food spiking;
- Food type employed (proximate analysis ⁽¹⁾, grade or quality, supplier, etc.), feeding rate during uptake phase, amount of food administered and frequency (including any adjustments based on sampled fish weight);
- Time at which fish were collected and euthanised for chemical analysis for each sample point (e.g. one hour before the following day's feeding);

Results:

- Results from any preliminary study work;
- Information on any adverse effects observed;
- Complete description of all chemical analysis procedures employed including limits of detection and quantification, variability and recovery;
- Measured lipid concentrations in food (spiked and control diet), individual, mean values and standard deviations;
- Tabulated fish weight (and length) data linked to individual fish, both for control and exposure groups (for example using unique identifiers for each fish) and calculations, derived growth rate constant(s) and 95 % confidence interval(s);
- Tabulated test substance concentration data in fish, mean measured concentration at end of uptake ($C_{0,m}$), and derived (overall) depuration rate constant (k_2) and concentration in fish at start of depuration phase ($C_{0,d}$) together with the variances in these values (slope and intercept);
- Tabulated fish lipid contents data (listed against specific substance concentrations if applicable), mean values for test group and control at test start, end of uptake and end of depuration;
- Curves (including all measured data), showing the following (if applicable, concentrations may be expressed in relation to the whole body of the animal or specified tissues thereof):
 - growth (*i.e.* fish weight (and length) vs. time) or natural logarithm transformed weight vs. time;

⁽¹⁾ A foodstuff analysis technique for protein, lipid, crude fibre and ash content; this information is usually available from the feed supplier.

▼ **M7**

- the depuration of the test substance in the fish; and
- natural logarithm transformed concentration (ln concentration) vs. depuration time (including the derived depuration rate constant k_2 , and natural logarithm derived concentration in fish at start of depuration phase, $C_{0,d}$).
- If a visual inspection of a plot shows obvious outliers, a statistically valid outlier test may be applied to remove spurious data points as well as documented justification for their omission.
- Calculated growth-corrected depuration rate constant and growth-corrected half-life.
- Calculated assimilation efficiency (α).
- ‘Raw’ dietary BMF, lipid and growth-dilution corrected kinetic BMF (‘raw’ and lipid-corrected based on whole fish wet weight), tissue-specific BMF if applicable.
- Any information concerning radiolabelled test substance metabolites and their accumulation.
- Anything unusual about the test, any deviation from these procedures, and any other relevant information.
- A summary table of relevant measured and calculated data, as hereafter:

Substance Depuration Rate constants and Biomagnification Factors (BMF _K)	
k_g (growth rate constant; day ⁻¹):	Insert Value (95 % CI) (1)
k_2 (overall depuration rate constant, day ⁻¹):	Insert Value (95 % CI)
k_{2g} (growth-corrected depuration rate constant; day ⁻¹):	Insert Value (95 % CI) (1)
$C_{0,m}$ (measured time zero concentration, the concentration in fish at end of uptake) (µg/g):	Insert Value ± SD (2)
$C_{0,d}$ (derived time zero concentration of depuration phase; µg/g):	Insert Value ± SD (2)
I (set feed ingestion rate; g food/g fish/day):	Insert Value
I_g (effective feeding rate, adjusted for growth; g food/g fish/day) (2):	Insert Value ± SD (2)
C_{food} (chemical concentration in the food; µg/g):	Insert Value ± SD (2)
α (substance assimilation efficiency):	Insert Value ± SD (2)
BMF _K (kinetic dietary BMF):	Insert Value (95 % CI) (1)
BMF _{Kg} (growth-corrected kinetic dietary BMF):	Insert Value (95 % CI) (1)

▼ M7

Substance Depuration Rate constants and Biomagnification Factors (BMF _K)	
$t_{1/2g}$ (growth-corrected half-life in days):	Insert Value ± SD ⁽²⁾
L_c (lipid correction factor):	Insert Value
BMF _{KgL} (lipid-corrected growth-corrected kinetic BMF):	Insert Value
BMF _{SS-L} (indicative lipid-corrected steady-state BMF) ⁽²⁾ :	Insert Value ± SD ⁽²⁾

(¹) CI: confidence interval (where possible to estimate).
(²) SD: Standard deviation (where possible to estimate).

LITERATURE:

- (1) Chapter C.13 of this Annex, *Bioconcentration: Flow-through Fish Test*.
- (2) Chapter A.6 of this Annex, *Water Solubility*
- (3) Li A, Doucette W.J. (1993), The effect of cosolutes on the aqueous solubilities and octanol/water partition coefficients of selected polychlorinated biphenyl congeners. *Environ Toxicol Chem* 12: 2031-2035
- (4) Chapter A.8 of this Annex, *Partition Coefficient (n-octanol/water): Shake Flask Method*.
- (5) Chapter A.24 of this Annex, *Partition Coefficient (n-octanol/water), HPLC Method*.
- (6) Chapter A.23 of this Annex, *Partition Coefficient (1-Octanol/Water): Slow-Stirring Method*.
- (7) Chapter C.7 of this Annex, *Hydrolysis as a Function of pH*.
- (8) OECD (1997), OECD Environmental Health and Safety Publications Series on Testing and Assessment Number 7: Guidance Document on Direct Phototransformation of Chemicals in Water OCDE/GD(97)21. Organisation for Economic Co-operation and Development (OECD), Paris, France.
- (9) Chapter A.5 of this Annex, *Surface Tension of Aqueous Solutions*.
- (10) Chapter A.4 of this Annex, *Vapour Pressure*.
- (11) Chapter C.4 of this Annex, *Ready Biodegradability*.
- (12) Chapter C.29 of this Annex, *Ready Biodegradability — CO₂ in sealed vessels*
- (13) Connell D.W. (1988), Bioaccumulation behaviour of persistent chemicals with aquatic organisms. *Rev. Environ. Contam. Toxicol.* 102: 117-156.
- (14) Bintein S., Devillers J. and Karcher W. (1993), Nonlinear dependence of fish bioconcentration on *n*-octanol/water partition coefficient. *SAR QSAR Environ. Res.* 1: 29-39.
- (15) OECD (2011), QSAR Toolbox 2.1. February 2011. Available from: http://www.oecd.org/document/54/0,3746,en_2649_34379_42923638_1_1_1_1,00.html.

▼M7

- (16) Brown R.S., Akhtar P., Åkerman J., Hampel L., Kozin I.S., Villerius L.A. and Klamer H.J.C. (2001), Partition controlled delivery of hydrophobic substances in toxicity tests using poly(dimethylsiloxane) (PDMS) films. *Environ. Sci. Technol.* 35: 4097-4102.
- (17) Fernandez J.D., Denny J.S. and Tietge J.E. (1998), A simple apparatus for administering 2,3,7,8-tetrachlorodibenzo-*p*-dioxin to commercially available pelletized fish food. *Environ. Toxicol. Chem.* 17: 2058-2062.
- (18) Nichols J.W., Fitzsimmons P.N., Whiteman F.W. and Dawson T.D. (2004), A physiologically based toxicokinetic model for dietary uptake of hydrophobic organic compounds by fish: I. Feeding studies with 2,2', 5,5'-tetrachlorobiphenyl. *Toxicol. Sci.* 77: 206-218.
- (19) Parkerton T.F., Arnot J.A., Weisbrod A.V., Russom C., Hoke R.A., Woodburn K., Traas T., Bonnell M., Burkhard L.P. and Lampi M.A. (2008), Guidance for evaluating *in vivo* fish bioaccumulation data. *Integr. Environ. Assess. Manag.* 4: 139-155.
- (20) Verbruggen E.M.J., Beek M., Pijnenburg J. and Traas T.P. (2008). Ecotoxicological environmental risk limits for total petroleum hydrocarbons on the basis of internal lipid concentrations. *Environ. Toxicol. Chem.* 27: 2436-2448.
- (21) Schlechtriem C., Fliedner A. and Schäfers C. (2012), Determination of lipid content in fish samples from bioaccumulation studies: Contributions to the revision of OECD Test Guideline 305. *Environmental Sciences Europe* 2012, 24:13. published: 3 April 2012.
- (22) Chapter C.47 of this Annex, *Fish, Early-Life Stage Toxicity Test*.
- (23) Chapter C.15 of this Annex, *Fish, Short-term Toxicity Test on Embryo and Sac-Fry Stages*
- (24) Chapter C.14 of this Annex, *Fish, Juvenile Growth Test*.
- (25) OECD (2000), OECD Environmental Health and Safety Publications Series on Testing and Assessment No. 23: Guidance Document on Aquatic Toxicity Testing of Difficult Substances and Mixtures [ENV/JM/MONO\(2000\)6](#). Organisation for Economic Co-operation and Development (OECD), Paris, France.
- (26) US-EPA (1994), Great Lake water quality initiative technical support document for the procedure to determine bioaccumulation factors 822-R-94-002. US EPA, Office of Water, Office of Science and Technology, Washington, DC, USA.
- (27) US-FDA (1999), Pesticide analytical manual (PAM). Vol.1. US Food and Drug Administration, Rockville, MD, USA.
- (28) US-EPA (1974), Section 5, A (1) Analysis of Human or Animal Adipose Tissue, in *Analysis of Pesticide Residues in Human and Environmental Samples*, Thompson, J.F., Editor. US-EPA, Research Triangle Park, NC, USA
- (29) Bligh E.G. and Dyer W.J. (1959), A rapid method of total lipid extraction and purification. *Can. J. Biochem. Physiol.* 37: 911-917.
- (30) Gardner W.S., Frez W.A., Cichocki E.A. and Parrish C.C. (1985), Micromethod for lipids in aquatic invertebrates. *Limnol. Oceanogr.* 30: 1099-1105.
- (31) Smedes F. (1999), Determination of total lipid using non-chlorinated solvents. *Analyst.* 124: 1711-1718.
- (32) OECD (2006), OECD Environmental Health and Safety Publications Series on Testing and Assessment No. 54: Current approaches in the statistical analysis of ecotoxicity data: a guidance to application. [ENV/JM/MONO\(2006\)18](#). Organisation for Economic Co-operation and Development (OECD), Paris, France.

▼ M7

- (33) Springer T.A., Guiney P.D., Krueger H.O. and Jaber M.J. (2008), Assessment of an approach to estimating aquatic bioconcentration factors using reduced sampling. *Environ. Toxicol. Chem.* 27: 2271-2280.
- (34) Springer T.A. (2009), *Statistical Research Related to Update of OECD Guideline 305*. Wildlife International, Ltd, Easton, MD, USA.
- (35) Arnot J.A., Meylan W., Tunkel J., Howard P.H., Mackay D., Bonnell M. and Boethling R.S. (2009), A quantitative structure-activity relationship for predicting metabolic biotransformation rates for organic chemicals in fish. *Environ. Toxicol. Chem.* 28: 1168-1177.
- (36) Parkerton T., Letinski D., Febbo E., Davi R., Dzambia C., Connelly M., Christensen K. and Peterson D. (2001), A practical testing approach for assessing bioaccumulation potential of poorly water soluble organic chemicals (presentation). in SETAC Europe 12th Annual Meeting: Madrid, Spain.
- (37) Fisk A.T., Cymbalisky C.D., Bergman Å. and Muir D.C.G. (1996), Dietary accumulation of C₁₂- and C₁₆-chlorinated alkanes by juvenile rainbow trout (*Oncorhynchus mykiss*). *Environ. Toxicol. Chem.* 15: 1775-1782.
- (38) Anonymous (2004), Fish, dietary bioaccumulation study — Basic protocol, document submitted to the TC-NES WG on PBT.
- (39) Anonymous (2004), Background document to the fish dietary study protocol, document submitted to the TC-NES WG on PBT.
- (40) Bruggeman W.A., Opperhuizen A., Wijbenga A. and Hutzinger O. (1984), Bioaccumulation of super-lipophilic chemicals in fish, *Toxicol. Environ. Chem.* 7: 173-189.
- (41) Muir D.C.G., Marshall W.K. and Webster G.R.B. (1985), Bioconcentration of PCDDs by fish: effects of molecular structure and water chemistry. *Chemosphere.* 14: 829-833.
- (42) Thomann R.V. (1989), Bioaccumulation model of organic chemical distribution in aquatic food chains. *Environ. Sci. Technol.* 23: 699-707.
- (43) Nichols J.W., Fitzsimmons P.N. and Whiteman F.W. (2004), A physiologically based toxicokinetic model for dietary uptake of hydrophobic organic compounds by fish: II. Stimulation of chronic exposure scenarios. *Toxicol. Sci.* 77: 219-229.
- (44) Gobas F.A.P.C., de Wolf W., Burkhard L.P., Verbruggen E. and Plotzke K. (2009), Revisiting bioaccumulation criteria for POPs and PBT assessments. *Integr. Environ. Assess. Manag.* 5: 624-637.
- (45) Sijm D.T.H.M. and van der Linde A. (1995), Size-dependent bioconcentration kinetics of hydrophobic organic chemicals in fish based on diffusive mass transfer and allometric relationships. *Environ. Sci. Technol.* 29: 2769-2777.
- (46) Sijm D.T.H.M., Verberne M.E., de Jonge W.J., Pärt P. and Opperhuizen A. (1995), Allometry in the uptake of hydrophobic chemicals determined *in vivo* and in isolated perfused gills. *Toxicol. Appl. Pharmacol.* 131: 130-135.
- (47) Fisk A.T., Norstrom R.J., Cymbalisky C.D. and Muir D.G.G. (1998), Dietary accumulation and depuration of hydrophobic organochlorines: Bioaccumulation parameters and their relationship with the octanol/water partition coefficient. *Environ. Toxicol. Chem.* 17: 951-961.
- (48) McGrath J.A., Parkerton T.F. and Di Toro D.M. (2004), Application of the narcosis target lipid model to algal toxicity and deriving predicted-no-effect concentrations. *Environ. Toxicol. Chem.* 23: 2503-2517.
- (49) Poppendieck D.G. (2002), Polycyclic Aromatic Hydrocarbon Desorption Mechanisms from Manufactured Gas Plant Site Samples. Dissertation. Department of Civil, Architectural and Environmental Engineering, University of Texas, Austin, TX, USA.

▼M7

- (50) McCarty L.S. and Mackay D. (1993), Enhancing ecotoxicological modelling and assessment: body residues and modes of toxic action. *Environ. Sci. Technol.* 27: 1718-1728.

- (51) OECD (2012), OECD Environmental Health and Safety Publications Series on Testing and Assessment No. 175: Part I — Validation Report of a ring test for the OECD TG 305 dietary exposure bioaccumulation fish test. Part II — Additional Report including comparative analysis of trout and carp results ENV/JM/MONO(2012)20. Organisation for Economic Co-operation and Development (OECD), Paris, France.

▼ M7*Appendix 1*

DEFINITIONS AND UNITS:

The assimilation efficiency (α) is a measure of the relative amount of substance absorbed from the gut into the organism (α is unitless, but it is often expressed as a percentage rather than a fraction).

Bioaccumulation is generally referred to as a process in which the substance concentration in an organism achieves a level that exceeds that in the respiratory medium (e.g. water for a fish or air for a mammal), the diet, or both (1).

Bioconcentration is the increase in concentration of the test substance in or on an organism (or specified tissues thereof) relative to the concentration of test substance in the surrounding medium.

The bioconcentration factor (BCF or K_B) at any time during the uptake phase of this accumulation test is the concentration of test substance in/on the fish or specified tissues thereof (C_f as mg/kg) divided by the concentration of the substance in the surrounding medium (C_w as mg/l). BCF is expressed in $l \cdot kg^{-1}$. Please note that corrections for growth and/or a standard lipid content are not accounted for.

Biomagnification is the increase in concentration of the test substance in or on an organism (or specified tissues thereof) relative to the concentration of test substance in the food.

The biomagnification factor (BMF) is the concentration of a substance in a predator relative to the concentration in the predator's prey (or food) at steady-state. In the method described in this test method, exposure via the aqueous phase is carefully avoided and thus a BMF value from this test method cannot directly be compared to a BMF value from a field study (in which both water and dietary exposure may be combined).

The dietary biomagnification factor (dietary BMF) is the term used in this test method to describe the result of dietary exposure test, in which exposure via the aqueous phase is carefully avoided and thus the dietary BMF from this test method cannot directly be compared to a BMF value from a field study (in which both water and dietary exposure may be combined).

The depuration or post-exposure (loss) phase is the time, following the transfer of the test fish from a medium containing test substance to a medium free of that substance, during which the depuration (or the net loss) of the substance from the test fish (or specified tissue thereof) is studied.

The depuration (loss) rate constant (k_2) is the numerical value defining the rate of reduction in the concentration of the test substance in the test fish (or specified tissues thereof) following the transfer of the test fish from a medium containing the test substance to a medium free of that substance (k_2 is expressed in day^{-1}).

Dissolved organic carbon (DOC) is a measure of the concentration of carbon originating from dissolved organic sources in the test media.

The exposure or uptake phase is the time during which the fish are exposed to the test substance.

The food ingestion rate (I) is the average amount of food eaten by each fish each day, relative to the estimated average fish whole body weight (expressed in terms of g food/g fish/day).

▼ M7

The kinetic bioconcentration factor (BCF_K) is the ratio of the uptake rate constant, k_1 , to the depuration rate constant, k_2 (i.e. k_1/k_2 — see corresponding definitions in this Appendix). In principle the value should be comparable to the BCF_{SS} (see definition above), but deviations may occur if steady-state was uncertain or if corrections for growth have been applied to the kinetic BCF.

The lipid normalised kinetic bioconcentration factor (BCF_{KL}) is normalised to a fish with a 5 % lipid content.

The lipid normalised, growth corrected kinetic bioconcentration factor (BCF_{KGL}) is normalised to a fish with a 5 % lipid content and corrected for growth during the study period as described in Appendix 5.

The lipid normalised steady-state bioconcentration factor (BCF_{SSL}) is normalised to a fish with 5 % lipid content.

A multi-constituent substance is defined for the purpose of REACH as a substance which has more than one main constituent present in a concentration between 10 % and 80 % (w/w).

The octanol-water partition coefficient (K_{OW}) is the ratio of a substance's solubility in *n*-octanol and water at equilibrium (Methods A.8 (2), A.24 (3), A.23 (4)); also expressed as P_{OW} . The logarithm of K_{OW} is used as an indication of a substance's potential for bioconcentration by aquatic organisms.

Particulate organic carbon (POC) is a measure of the concentration of carbon originating from suspended organic sources in the test media.

Solid-phase microextraction (SPME) is a solvent-free analytical technique developed for dilute systems. In this method, a polymer coated fibre is exposed to the gas or liquid phase containing the analyte of interest. Generally, a minimum analysis time is imposed so that equilibrium conditions are established between the solid and fluid phases, with respect to the measured species. Subsequently the concentration of the analyte of interest can be determined directly from the fibre or after extracting it from the fibre into a solvent, depending on the determination technique.

A steady-state is reached in the plot of test substance in fish (C_f) against time when the curve becomes parallel to the time axis and three successive analyses of C_f made on samples taken at intervals of at least two days are within ± 20 % of each other, and there is no significant increase of C_f in time between the first and last successive analysis. When pooled samples are analysed at least four successive analyses are required. For test substances which are taken up slowly the intervals would more appropriately be seven days.

The steady-state bioconcentration factor (BCF_{SS}) does not change significantly over a prolonged period of time, the concentration of the test substance in the surrounding medium being constant during this period of time (cf. Definition of steady-state).

Total organic carbon (TOC) is a measure of the concentration of carbon originating from all organic sources in the test media, including particulate and dissolved sources.

The uptake rate constant (k_1) is the numerical value defining the rate of increase in the concentration of test substance in/on test fish (or specified tissues thereof) when the fish are exposed to that substance (k_1 is expressed in $l\ kg^{-1}\ day^{-1}$).

Substances of Unknown or Variable composition, Complex reaction products and Biological materials are known as UVCB

▼ M7

Chemical is a substance or a mixture.

Test chemical is any substance or mixture tested using this test method.

LITERATURE:

- (1) Gobas F.A.P.C., de Wolf W., Burkhard L.P., Verbruggen E. and Plotzke K. (2009), Revisiting bioaccumulation criteria for POPs and PBT assessments. *Integr. Environ. Assess. Manag.* 5: 624-637.
- (2) Chapter A.8 of this Annex, *Partition Coefficient (n-octanol/water): Shake Flask Method*
- (3) Chapter A.24 of this Annex, *Partition Coefficient (n-octanol/water), HPLC Method*.
- (4) Chapter A.23 of this Annex, *Partition Coefficient (1-Octanol/Water): Slow-Stirring Method*.

▼ **M7***Appendix 2***SOME CHEMICAL CHARACTERISTICS OF AN ACCEPTABLE
DILUTION WATER**

Component	Limit concentration
Particulate matter	5 mg/l
Total organic carbon	2 mg/l
Un-ionised ammonia	1 µg/l
Residual chlorine	10 µg/l
Total organophosphorous pesticides	50 ng/l
Total organochlorine pesticides plus polychlorinated biphenyls	50 ng/l
Total organic chlorine	25 ng/l
Aluminium	1 µg/l
Arsenic	1 µg/l
Chromium	1 µg/l
Cobalt	1 µg/l
Copper	1 µg/l
Iron	1 µg/l
Lead	1 µg/l
Nickel	1 µg/l
Zinc	1 µg/l
Cadmium	100 ng/l
Mercury	100 ng/l
Silver	100 ng/l

▼ **M7**

Appendix 3

FISH SPECIES RECOMMENDED FOR TESTING

Recommended species	Recommended range of test temperature (°C)	Recommended total length of test animal (cm) ⁽²⁾
<i>Danio rerio</i> ⁽¹⁾ (Teleostei, Cyprinidae) (Hamilton-Buchanan) Zebra-fish	20 – 25	3,0 ± 0,5
<i>Pimephales promelas</i> (Teleostei, Cyprinidae) (Rafinesque) Fathead minnow	20 – 25	5,0 ± 2,0
<i>Cyprinus carpio</i> (Teleostei, Cyprinidae) (Linnaeus) Common carp	20 – 25	8,0 ± 4,0 ⁽³⁾
<i>Oryzias latipes</i> (Teleostei, Poeciliidae) (Temminck and Schlegel) Ricefish	20 – 25	4,0 ± 1,0
<i>Poecilia reticulata</i> (Teleostei, Poeciliidae) (Peters) Guppy	20 – 25	3,0 ± 1,0
<i>Lepomis macrochirus</i> (Teleostei Centrarchidae) (Rafinesque) Bluegill	20 – 25	5,0 ± 2,0
<i>Oncorhynchus mykiss</i> (Teleostei Salmonidae) (Walbaum) Rainbow trout	13 – 17	8,0 ± 4,0
<i>Gasterosteus aculeatus</i> (Teleostei, (Gasterosteidae) (Linnaeus) Three-spined stickleback	18 — 20	3,0 ± 1,0

⁽¹⁾ Meyer *et al.* (1)

⁽²⁾ It should be noted that in the test itself weight is preferred as the measure for size and growth rate constant derivations. It is however recognised that length is a more practical measure if fish have to be selected by sight at the beginning of an experiment (*i.e.* from the stock population).

⁽³⁾ This length range is indicated in the Testing Methods for New Chemical Substances etc. based on the Japan's Chemical Substances Control Law (CSCL).

Various estuarine and marine species have less widely been used, for example:

Spot	(<i>Leiostomus xanthurus</i>)
Sheepshead minnow	(<i>Cyprinodon variegatus</i>)
Silverside	(<i>Menidia beryllina</i>)
Shiner perch	(<i>Cymatogaster aggregata</i>)
English sole	(<i>Parophrys vetulus</i>)
Staghorn sculpin	(<i>Leptocottus armatus</i>)
Three-spined stickleback	(<i>Gasterosteus aculeatus</i>)
Sea bass	(<i>Dicentracus labrax</i>)
Bleak	(<i>Alburnus alburnus</i>)

▼M7

The freshwater fish listed in the table above are easy to rear and/or are widely available throughout the year, whereas the availability of marine and estuarine species is partially confined to the respective countries. They are capable of being bred and cultivated either in fish farms or in the laboratory, under disease- and parasite-controlled conditions, so that the test animal will be healthy and of known parentage. These fish are available in many parts of the world.

LITERATURE:

- (1) Meyer A., Biermann C.H. and Orti G. (1993), The phylogenetic position of the zebrafish (*Danio rerio*), a model system in developmental biology: An invitation to the comparative method Proc. R. Soc. Lond. B. 252: 231-236.

▼M7

Appendix 4

SAMPLING SCHEDULES FOR AQUEOUS AND DIETARY EXPOSURE TESTS

1. Theoretical example of a sampling schedule for a full aqueous exposure bioconcentration test of a substance with $\log K_{OW} = 4$.

Fish Sampling	Sample time schedule		No. of water samples ⁽¹⁾	No. of fish per sample ⁽¹⁾
	Minimal required frequency (days) ⁽²⁾	Additional sampling (days) ⁽²⁾		
Uptake phase				
1	- 1		2 ⁽³⁾	4 ⁽⁴⁾
	0		(2)	(3 ⁽⁶⁾)
2	0,3		2	4
		0,4	(2)	(4)
3	0,6		2	4
		0,9	(2)	(4)
4	1,2		2	4
		1,7	(2)	(4)
5	2,4		2	4
		3,3	(2)	(4)
6	4,7		2	4 – 8 ⁽⁵⁾
				(3 ⁽⁶⁾)
Depuration phase				Transfer fish to water free of test substance
7	5,0		2	4
		5,3		(4)
8	5,9		2	4
		7,0		(4)
9	9,3		2	4
		11,2		(4)
10	14,0		2	4 – 8 ⁽⁵⁾
		17,5		(4+3 ⁽⁶⁾)
TOTAL				40 – 72 (48 – 80) ⁽⁵⁾

⁽¹⁾ Values in brackets are numbers of samples (water, fish) to be taken if additional sampling is carried out.

⁽²⁾ Pre-test estimate of k_2 for $\log K_{OW}$ of 4,0 is $0,652 \text{ days}^{-1}$. The total duration of the experiment is set to $3 \times t_{SS} = 3 \times 4,6$ days, i.e. 14 days. For the estimation of t_{SS} refer to Appendix 5.

⁽³⁾ Sample water after a minimum of 3 'chamber-volumes' has been delivered.

⁽⁴⁾ These fish are sampled from the stock population.

⁽⁵⁾ If greater precision or metabolism studies are necessary that require more fish, these should be sampled particularly at the end of the uptake and depuration phases (cf. paragraph 40).

⁽⁶⁾ At least 3 additional fish may be required for lipid content analysis if it is not possible to use the same fish sampled for substance concentrations at the start of the test, the end of the uptake phase and the end of the depuration phase. Note it should be possible in many cases to use the 3 control fish alone (cf. paragraph 56).

▼ **M7****2. Theoretical example of sampling schedule for dietary bioaccumulation test of substance following 10 day uptake and 42 day depuration phases.**

Sampling event	Sample time schedule		No. food samples	No. fish per sample	
	Day of phase	Additional fish samples?		Test Group	Control Group
Uptake phase					
1	0	Possible ⁽¹⁾ ⁽²⁾	3 — test group 3 — control group ⁽¹⁾	0	5 – 10 (8 – 13) ⁽²⁾
1A ⁽³⁾	1-3			5 – 10	5 – 10
2	10	Yes ⁽⁴⁾	3 — test group 3 — control group ⁽¹⁾	10 – 15 ⁽⁴⁾ (13 – 18) ⁽⁵⁾	5 – 10 (8 – 13) ⁽⁵⁾
Depuration phase					
3	1	Yes ⁽⁴⁾		10 – 15 ⁽⁴⁾	5 – 10
4	2			5 – 10	5 – 10
5	4			5 – 10	5 – 10
6	7	Yes ⁽⁴⁾		10 – 15 ⁽⁴⁾	5 – 10
7	14			5 – 10	5 – 10
8	28			5 – 10	5 – 10
9	42	Yes ⁽⁴⁾		10 – 15 ⁽⁴⁾ (13 – 18) ⁽⁵⁾	5 – 10 (8 – 13) ⁽⁵⁾
TOTAL				59 – 120 (63 – 126) ⁽⁴⁾ ⁽⁵⁾	50 – 110 (56 – 116) ⁽⁴⁾ ⁽⁵⁾

⁽¹⁾ 3 samples of feed from both control and test groups analysed for test substance concentrations and for lipid content.

⁽²⁾ Fish are sampled from the stock population as near to the start of the study as possible; at least 3 fish from the stock population at test start should be sampled for lipid content.

⁽³⁾ (Optional) sampling early in the uptake phase provides data to calculate dietary assimilation of test substance that can be compared with the assimilation efficiency calculated from the depuration phase data.

⁽⁴⁾ 5 extra fish may be sampled for tissue-specific analysis.

⁽⁵⁾ At least 3 additional fish may be required for lipid content analysis if it is not possible to use the same fish sampled for substance concentrations at the start of the test, the end of the uptake phase and the end of the depuration phase. Note it should be possible in many cases to use the 3 control fish alone (*cf.* paragraphs 56 and 153).

Note on phase and sampling timings: The uptake phase begins with the first feeding of spiked diet. An experimental day runs from one feeding until shortly before the next, 24 hours later. The first sampling event (1 in the table) should be taken shortly before the first feeding (e.g. one hour). Sampling during a study should ideally be carried out shortly before the following day's feeding (*i.e.* about 23 hours after the sample day's feeding). The uptake phase ends shortly before the first feeding with unspiked diet, when the depuration phase begins (test group fish are likely to be still digesting spiked feed in the intervening 24 hours after the last spiked diet feeding). This means that the end of uptake sample should be taken shortly before the first feeding with unspiked diet and the first depuration phase sample should be taken about 23 hours after the first feeding with unspiked feed.

▼ **M7***Appendix 5***GENERAL CALCULATIONS**

1. Introduction
2. Prediction of the duration of the uptake phase
3. Prediction of the duration of the depuration phase
4. Sequential method: determination of depuration (loss) rate constant k_2
5. Sequential method: determination of uptake rate constant k_1 (aqueous exposure method only)
6. Simultaneous method for calculation of uptake and depuration (loss) rate constants (aqueous exposure method only)
7. Growth dilution correction for kinetic BCF and BMF
8. Lipid normalisation to 5 % lipid content (aqueous exposure method only)

1. INTRODUCTION

The general fish aquatic bioaccumulation model can be described in terms of uptake and loss processes, ignoring uptake with food. The differential equation (dC_f/dt) describing the rate of change in fish concentration ($\text{mg}\cdot\text{kg}^{-1}\cdot\text{day}^{-1}$) is given by (1):

$$\frac{dC_f}{dt} = k_1 \times C_w - (k_2 + k_g + k_m + k_e) \times C_f \quad \text{[Equation A5.1]}$$

Where

k_1 = First order rate constant for uptake into fish ($\text{l}\cdot\text{kg}^{-1}\cdot\text{day}^{-1}$).

k_2 = First order rate constant for depuration from fish (day^{-1}).

k_g = First order rate constant for fish growth ('growth dilution') (day^{-1})

k_m = First order rate constant for metabolic transformation (day^{-1})

k_e = First order rate constant for faecal egestion (day^{-1})

C_w = Concentration in water ($\text{mg}\cdot\text{l}^{-1}$).

C_f = Concentration in fish ($\text{mg}\cdot\text{kg}^{-1}$ wet weight).

For bioaccumulating substances, it can be expected that a time-weighted average (TWA) is the most relevant exposure concentration in water (C_w) within the allowed range of fluctuation (*cf.* paragraph 24). It is recommended to calculate a TWA water concentration, according to the procedure in Appendix 6 of TM C.20 (2). It should be noted that the ln-transformation of the water concentration is suitable when exponential decay between renewal periods is expected, e.g. in a semi-static test design. In a flow through system, ln-transformation of exposure concentrations may not be needed. If TWA water concentrations are derived, they should be reported and used in subsequent calculations.

In a standard fish BCF test uptake and depuration can be described in terms of two first order kinetic processes.

▼ M7

$$\text{Rate of uptake} = k_1 \times C_w \quad [\text{Equation A5.2}]$$

$$\text{Overall loss rate} = (k_2 + k_g + k_m + k_e) \times C_f \quad [\text{Equation A5.3}]$$

At steady-state, assuming growth and metabolism are negligible (*i.e.* the values for k_g and k_m cannot be distinguished from zero), the rate of uptake equals the rate of depuration, and so combining Equation A5.2 and Equation A5.3 gives the following relationship:

$$BCF = \frac{C_{f-ss}}{C_{w-ss}} = \frac{k_1}{k_2} \quad [\text{Equation A5.4}]$$

Where

C_{f-ss} = Concentration in fish at steady-state (mg kg^{-1} wet weight).

C_{w-ss} = Concentration in water at steady-state (mg l^{-1}).

The ratio of k_1/k_2 is known as the kinetic BCF (BCF_K) and should be equal to the steady-state BCF (BCF_{SS}) obtained from the ratio of the steady-state concentration in fish to that in water, but deviations may occur if steady-state was uncertain or if corrections for growth have been applied to the kinetic BCF. However, as k_1 and k_2 are constants, steady-state does not need to be reached to derive a BCF_K .

Based on these first order equations, this Appendix 5 includes the general calculations necessary for both aqueous and dietary exposure bioaccumulation methods. However, sections 5, 6 and 8 are only relevant for the aqueous exposure method but are included here as they are 'general' techniques. The sequential (sections 4 and 5) and simultaneous (section 6) methods allow the calculation of uptake and depuration constants which are used to derive kinetic BCFs. The sequential method for determining k_2 (section 4) is important for the dietary method as it is needed to calculate both assimilation efficiency and BMF. Appendix 7 details the calculations that are specific to the dietary method.

2. PREDICTION OF THE DURATION OF THE UPTAKE PHASE

Before performing the test, an estimate of k_2 and hence some percentage of the time needed to reach steady-state may be obtained from empirical relationships between k_2 and the *n*-octanol/water partition coefficient (K_{OW}) or k_1 and BCF. It should be realised, however, that the equations in this section only apply when uptake and depuration follow first-order kinetics. If this is clearly not the case it is advised to seek advice from a biostatistician and/or pharmacokineticist, if predictions of the uptake phase are desirable.

An estimate of k_2 (day^{-1}) may be obtained by several methods. For example, the following empirical relationships could be used in the first instance ⁽¹⁾:

$$\log k_2 = 1,47 - 0,414 \log K_{OW} \quad (r^2=0,95) \quad [(3); \text{Equation A5.5}]$$

or

$$k_2 = \frac{k_1}{BCF} \quad [\text{Equation A5.6}]$$

Where $k_1 = 520 \times W^{-0,32}$ (for substances with a $\log K_{OW} > 3$) $(r^2=0,85)$ [(4); Equation A5.7]

⁽¹⁾ As with every empirical relationship, it should be verified that the test substance falls within the applicability domain of the relationship

▼ **M7**

And $BCF = 10^{(0,910 \cdot \log K_{ow} - 1,975 \cdot \log(6,8 \cdot 10^{-7} K_{ow} + 1) - 0,786)}$ ($r^2=0,90$)[(5); Equation A5.8]

W = mean treated fish weight (grams wet weight) at the end of uptake/start of depuration ⁽¹⁾

For other related relationships *see* (6). It may be advantageous to employ more complicated models in the estimation of k_2 if, for example, it is likely that significant metabolism may occur (7) (8). However as the complexity of the model increases, greater care should be taken with the interpretation of the predictions. For example the presence of nitro groups might indicate fast metabolism, but this is not always the case. Therefore the user should weigh up the predictive method results against chemical structure and any other relevant information (for example preliminary studies) in the scheduling of a study.

The time to reach a certain percentage of steady-state may be obtained, by applying the k_2 -estimate, from the general kinetic equation describing uptake and depuration (first-order kinetics), assuming growth and metabolism is negligible. If substantial growth occurs during the study, the estimations described below will not be reliable. In such cases, it is better to use the growth corrected k_{2g} as described later (see Section 7 of this Appendix):

$$\frac{dC_f}{dt} = k_1 C_w - k_2 C_f \quad \text{[Equation A5.9]}$$

or, if C_w is constant:

$$C_f = \frac{k_1}{k_2} \cdot C_w (1 - e^{-k_2 t}) \quad \text{[Equation A5.10]}$$

When steady-state is approached ($t \rightarrow \infty$), Equation A5.10 may be reduced (*cf.* (9) (10)) to:

$$C_f = \frac{k_1}{k_2} \cdot C_w \quad \text{[Equation A5.11]}$$

or

$$\frac{C_f}{C_w} = \frac{k_1}{k_2} = BCF \quad \text{[Equation A5.12]}$$

Then $BCF \times C_w$ is an approximation to the concentration in the fish at steady-state ($C_{f,ss}$). [Note: the same approach can be used when estimating a steady-state BMF with the dietary test. In this case, BCF is replaced with BMF and C_w with C_{food} , concentration in the food, in the equations above]

Equation A5.10 may be transcribed to:

$$C_f = C_{f-ss} (1 - e^{-k_2 t}) \quad \text{[Equation A5.13]}$$

or

$$\frac{C_f}{C_{f-ss}} = 1 - e^{-k_2 t} \quad \text{[Equation A5.14]}$$

Applying Equation A5.14, the time to reach a certain percentage of steady-state may be predicted when k_2 is pre-estimated using Equation A5.5 or Equation A5.6.

As a guideline, the statistically optimal duration of the uptake phase for the production of statistically acceptable data (BCF_K) is that period which is required for the curve of the logarithm of the concentration of the test

⁽¹⁾ The weight of fish at the end of the uptake phase can be estimated from previous study data or knowledge of the test species' likely increase in size from a typical test starting weight over a typical uptake duration (e.g. 28 days).

▼ M7

substance in fish plotted against linear time to reach at least 50 % of steady-state (*i.e.* $0,69/k_2$), but not more than 95 % of steady-state (*i.e.* $3,0/k_2$) (11). In case accumulation reaches beyond 95 % of steady-state, calculation of a BCF_{SS} becomes feasible.

The time to reach 80 percent of steady-state is (using Equation A5.14):

$$0,80 = 1 - e^{-k_2 t} \quad \text{[Equation A5.15]}$$

or

$$t_{80} = \frac{-\ln(0,20)}{k_2} = \frac{1,6}{k_2} \quad \text{[Equation A5.16]}$$

Similarly the time to reach 95 percent of steady-state is:

$$t_{95} = \frac{-\ln(0,05)}{k_2} = \frac{3,0}{k_2} \quad \text{[Equation A5.17]}$$

For example, the duration of the uptake phase (*i.e.* time to reach a certain percentage of steady-state, e.g. t_{80} or t_{95}) for a test substance with $\log K_{OW} = 4$ would be (using Equation A5.5, Equation A5.16 and Equation A5.17):

$$\log k_2 = 1,47 - 0,414 \cdot 4$$

$$k_2 = 0,652 \text{ day}^{-1}$$

$$t_{80} = \frac{1,6}{0,652} = 2,45 \text{ days (59 hours)}$$

$$\text{or } t_{95} = \frac{3,0}{0,652} = 4,60 \text{ days (110 hours)}$$

Alternatively, the expression:

$$t_{eSS} = 6,54 \cdot 10^{-3} \cdot K_{OW} + 55,31 \text{ (hours)} \quad \text{[Equation A5.18]}$$

may be used to calculate the time for effective steady-state (t_{eSS}) to be reached (12). For a test substance with $\log K_{OW} = 4$ this results in:

$$t_{eSS} = 6,54 \cdot 10^{-3} \cdot 10^4 + 55,31 = 121 \text{ hours}$$

3. PREDICTION OF THE DURATION OF THE DEPURATION PHASE

A prediction of the time needed to reduce the body burden to a certain percentage of the initial concentration may also be obtained from the general equation describing uptake and depuration (assuming first order kinetics, *cf.* Equation A5.9 (1) (13).

For the depuration phase, C_w (or C_{food} for the dietary test) is assumed to be zero. The equation may then be reduced to:

$$\frac{dC_f}{dt} = k_2 C_f \quad \text{[Equation A5.19]}$$

or

$$C_f = C_{f,0} \cdot e^{-k_2 t} \quad \text{[Equation A5.20]}$$

where $C_{f,0}$ is the concentration at the start of the depuration period.

50 percent depuration will then be reached at the time (t_{50}):

▼ M7

$$\frac{C_f}{C_{f,0}} = \frac{1}{2} = e^{-k_2 t_{50}}$$

or

$$t_{50} = \frac{-\ln(0,50)}{k_2} = \frac{0,693}{k_2}$$

Similarly 95 percent depuration will be reached at:

$$t_{95} = \frac{-\ln(0,05)}{k_2} = \frac{3,0}{k_2}$$

If 80 % uptake is used for the first period ($1,6/k_2$) and 95 % loss in the depuration phase ($3,0/k_2$), then depuration phase is approximately twice the duration of the uptake phase.

Note that the estimations are based on the assumption that uptake and depuration patterns will follow first order kinetics. If first-order kinetics is obviously not obeyed, these estimations are not valid.

4. SEQUENTIAL METHOD: DETERMINATION OF DEPURATION (LOSS) RATE CONSTANT K_2

Most bioconcentration data have been assumed to be 'reasonably' well described by a simple two-compartment/two-parameter model, as indicated by the rectilinear curve which approximates to the points for concentrations in fish (on an ln scale), during the depuration phase.

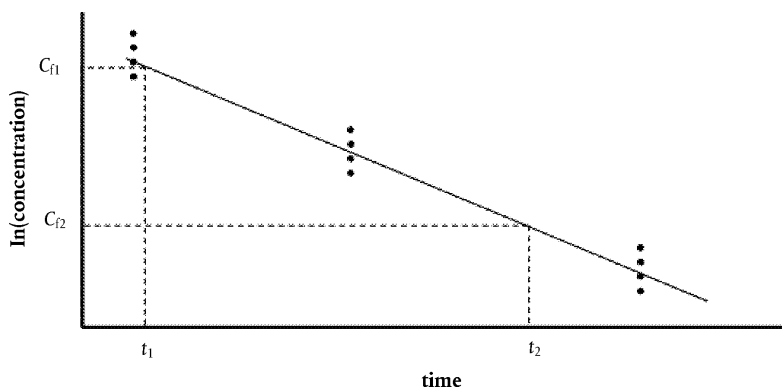

Note that deviations from a straight line may indicate a more complex depuration pattern than first order kinetics. The graphical method may be applied for resolving types of depuration deviating from first order kinetics.

To calculate k_2 for multiple time (sampling) points, perform a linear regression of $\ln(\text{concentration})$ versus time. The slope of the regression line is an estimate of the depuration rate constant k_2 ⁽¹⁾. From the intercept the average concentration in the fish at the start of the depuration phase ($C_{0,d}$; which equals the average concentration in the fish at the end of the uptake phase) can easily be calculated (including error margins) ⁽¹⁾:

⁽¹⁾ In most programs that allow a linear regression, also standard errors and confidence interval (CI) of the estimates are given, e.g. in Microsoft Excel using the Data Analysis tool pack.

▼ **M7**

$$C_{0,d} = e^{\text{intercept}} \quad [\text{Equation A5.21}]$$

To calculate k_2 when only two time (sampling) points are available (as in the minimised design), substitute the two average concentrations into the following equation

$$k_2 = \frac{\ln(C_{f1}) - \ln(C_{f2})}{t_2 - t_1} \quad [\text{Equation A5.22}]$$

Where $\ln(C_{f1})$ and $\ln(C_{f2})$ are the natural logarithms of the concentrations at times t_1 and t_2 , respectively, and t_2 and t_1 are the times when the two samples were collected relative to the start of depuration ⁽¹⁾.

5. SEQUENTIAL METHOD: DETERMINATION OF UPTAKE RATE CONSTANT k_1 (AQUEOUS EXPOSURE METHOD ONLY)

To find a value for k_1 given a set of sequential time concentration data for the uptake phase, use a computer program to fit the following model:

$$C_f(t) = C_w(t) \cdot \frac{k_1}{k_2} \cdot (1 - e^{-k_2 t}) \quad [\text{Equation A5.23}]$$

Where k_2 is given by the previous calculation, $C_f(t)$ and $C_w(t)$ are the concentrations in fish and water, respectively, at time t .

To calculate k_1 when only two time (sampling) points are available (as in the minimised design), use the following formula:

$$k_1 = \frac{C_f \cdot k_2}{C_w(1 - e^{-k_2 t})} \quad [\text{Equation A5.24}]$$

Where k_2 is given by the previous calculation, C_f is the concentration in fish at the start of the depuration phase, and C_w is the average concentration in the water during the uptake phase ⁽²⁾.

Visual inspection of the k_1 and k_2 slopes when plotted against the measured sample point data can be used to assess goodness of fit. If it turns out that the sequential method has given a poor estimate for k_1 then the simultaneous approach to calculate k_1 and k_2 should be applied (see next section 6). Again, the resulting slopes should be compared against the plotted measured data for visual inspection of goodness of fit. If the goodness of fit is still poor this may be an indication that first order kinetics do not apply and other more complex models should be employed.

6. SIMULTANEOUS METHOD FOR CALCULATION OF UPTAKE AND DEPURATION (LOSS) RATE CONSTANTS (AQUEOUS EXPOSURE METHOD ONLY)

Computer programs can be used to find values for k_1 and k_2 given a set of sequential time concentration data and the model:

$$C_f = C_w \cdot \frac{k_1}{k_2} \cdot (1 - e^{-k_2 t}) \quad 0 < t < t_c \quad [\text{Equation A5.25}]$$

$$C_f = C_w \cdot \frac{k_1}{k_2} \cdot (e^{-k_2(t-t_c)} - e^{-k_2 t}) \quad t > t_c \quad [\text{Equation A5.26}]$$

where

t_c = time at the end of the uptake phase.

This approach directly provides standard errors for the estimates of k_1 and k_2 . When k_1/k_2 is substituted by BCF (cf. Equation A5.4) in Equation A5.25 and

⁽¹⁾ In contrast with the linear regression method, using this formula will not yield a standard error for k_2 .

⁽²⁾ In contrast with a linear fitting procedure, this method will usually not yield a standard error or confidence interval for the estimated k_1 .

▼ M7

Equation A5.26, the standard error and 95 % CI of the BCF can be estimated as well. This is especially useful when comparing different estimates due to data transformation. The dependent variable (fish concentration) can be fitted with or without \ln transformation, and the resulting BCF uncertainty can be evaluated.

As a strong correlation exists between the two parameters k_1 and k_2 if estimated simultaneously, it may be advisable first to calculate k_2 from the depuration data only (see above); k_2 in most cases can be estimated from the depuration curve with relatively high precision. k_1 can be subsequently calculated from the uptake data using non-linear regression⁽¹⁾. It is advised to use the same data transformation when fitting sequentially.

Visual inspection of the resulting slopes when plotted against the measured sample point data can be used to assess goodness of fit. If it turns out that this method has given a poor estimate for k_1 then the simultaneous approach to calculate k_1 and k_2 can be applied. Again, the fitted model should be compared against the plotted measured data for visual inspection of goodness of fit and the resulting parameter estimates for k_1 , k_2 and resulting BCF and their standard errors and/or confidence intervals should be compared between different types of fit.

If the goodness of fit is poor this may be an indication that first order kinetics does not apply and other more complex models should be employed. One of the most common complications is fish growth during the test.

7. GROWTH DILUTION CORRECTION FOR KINETIC BCF AND BMF

This section describes a standard method for correction due to fish growth during the test (so called 'growth dilution') which is only valid when first order kinetics applies. In case there are indications that first order kinetics do not apply, it is advised to seek advice from a biostatistician for a proper correction of growth dilution or to use the mass based approach described below.

In some cases this method for correcting growth dilution is subject to a lack of precision or sometimes does not work (for example for very slowly depurating substances tested in fast growing fish the derived depuration rate constant corrected for growth dilution, k_{2g} , may be very small and so the error in the two rate constants used to derive it become critical, and in some cases k_g estimates may be larger than k_2). In such cases an alternative approach (*i.e.* mass approach), which also works when first order growth kinetics have not been obeyed, can be used which avoids the need for the correction. This approach is outlined at the end of this section.

Growth rate constant subtraction method for growth correction

For the standard method all individual weight and length data are converted to natural logarithms and $\ln(\text{weight})$ or $\ln(1/\text{weight})$ is plotted vs. time (day), separately for treatment and control groups. The same process is carried out for the data from the uptake and depuration phases separately. Generally for growth dilution correction it is more appropriate to use the weight data from the whole study to derive the growth rate constant (k_g), but statistically significant differences between the growth rate constants derived for the

⁽¹⁾ It should be realised that the uncertainty in the k_2 estimate is not used properly in the bioaccumulation model when this is essentially regarded as constant when fitting k_1 in the sequential fit method. The resulting BCF uncertainty will therefore be different between the simultaneous and sequential fitting methods.

▼ M7

uptake phase and depuration phase may indicate that the depuration phase rate constant should be used. Overall growth rates from aqueous studies for test and control groups can be used to check for any treatment related effects.

A linear least squares correlation is calculated for the $\ln(\text{fish weight})$ vs. day (and for $\ln(1/\text{weight})$ vs. day) for each group (test(s) and control groups, individual data, not daily mean values) for the whole study, uptake and depuration phases using standard statistical procedures. The variances in the slopes of the lines are calculated and used to evaluate the statistical significance ($p = 0,05$) of the difference in the slopes (growth rate constants) using the student t -test (or ANOVA if more than one concentration is tested). Weight data are generally preferred for growth correction purposes. Length data, treated in the same way, may be useful to compare control and test groups for treatment related effects. If there is no statistically significant difference in the weight data analysis, the test and control data may be pooled and an overall fish growth rate constant for the study (k_g) calculated as the overall slope of the linear correlation. If statistically significant differences are observed, growth rate constants for each fish group, and/or study phase, are reported separately. The rate constant from each treated group should then be used for growth dilution correction purposes of that group. If statistical differences between the uptake and depuration phase rate constants were noted, depuration phase derived rate constants should be used.

The calculated growth rate constant (k_g expressed as day^{-1}) can be subtracted from the overall depuration rate constant (k_2) to give the depuration rate constant, k_{2g} .

$$k_{2g} = k_2 - k_g \quad [\text{Equation A5.27}]$$

The uptake rate constant is divided by the growth-corrected depuration rate constant to give the growth-corrected kinetic BCF, denoted BCF_{k_g} (or BMF_{k_g}).

$$\text{BCF}_{k_g} = \frac{k_1}{k_{2g}} \quad [\text{Equation A5.28}]$$

The growth rate constant derived for a dietary study is used in Equation A7.5 to calculate the growth corrected BMF_{k_g} (cf. Appendix 7).

Mass based method for growth correction

An alternative to the above ‘growth rate constant subtraction method’ that avoids the need to correct for growth can be used as follows. The principle is to use depuration data on a mass basis per whole fish rather than on a concentration basis.

Convert depuration phase tissue concentrations (mass of test substance/unit mass of fish) into mass of test substance/fish; match concentrations and individual fish weights in tabular form (e.g. using a computer spreadsheet) and multiply each concentration by the total fish weight for that measurement to give a set of mass test substance/fish for all depuration phase samples.

Plot the resulting natural logarithm of substance mass data against time for the experiment (depuration phase) as would be done normally.

▼ M7

For the aqueous exposure method, derive the uptake rate constant routinely (see sections 4 and 6) note that the 'normal' k_2 value should be used in the curve fitting equations for k_1) and derive the depuration rate constant from the above data. Because the resulting value for the depuration rate constant is independent of growth as it has been derived on a mass basis per whole fish, it should be denoted as k_{2g} and not k_2 .

8. LIPID NORMALISATION TO 5 % LIPID CONTENT (AQUEOUS EXPOSURE METHOD ONLY)

BCF results (kinetic and steady-state) from aqueous exposure tests should also be reported relative to a default fish lipid content of 5 % wet weight, unless it can be argued that the test substance does not primarily accumulate in lipid (e.g. some perfluorinated substances may bind to proteins). Fish concentration data, or the BCF, need to be converted to a 5 % lipid content wet weight basis. If the same fish were used for measuring substance concentrations and lipid contents at all sampling points, this requires each individual measured concentration in the fish to be corrected for that fish's lipid content.

$$C_{f,L} = \frac{0,05}{L} \cdot C_f \quad \text{[Equation A5.29]}$$

where

$C_{f,L}$ = lipid-normalised concentration in fish (mg kg^{-1} wet weight)

L = lipid fraction (based on wet weight)

C_f = concentration of test substance in fish (mg kg^{-1} wet weight)

If lipid analysis was not conducted on all sampled fish, a mean lipid value is used to normalise the BCF. For the steady-state BCF, the mean value recorded at the end of the uptake phase in the treatment group should be used. For the normalisation of a kinetic BCF there may be some cases where a different approach is warranted, for example if the lipid content changed markedly during the uptake or depuration phase. However a feeding rate that minimises dramatic changes in lipid content should be used anyway routinely.

$$BCF_{KL} = \frac{0.05}{L_n} \cdot BCF_K \quad \text{[Equation A5.30]}$$

where

BCF_{KL} = lipid-normalised kinetic BCF (L kg^{-1})

L_n = mean lipid fraction (based on wet weight)

BCF_K = kinetic BCF (L kg^{-1})

LITERATURE:

- (1) Arnot J.A. and Gobas F.A.P.C. (2004), A food web bioaccumulation model for organic chemicals in aquatic ecosystems, *Environ. Toxicol. Chem.* 23: 2343–2355.
- (2) Chapter C.20 of this Annex, *Daphnia magna Reproduction Test*.
- (3) Spacie A. and Hamelink J.L. (1982), Alternative models for describing the bioconcentration of organics in fish. *Environ. Toxicol. Chem.* 1: 309-320.

▼ **M7**

- (4) Sijm D.T.H.M., Verberne M.E., de Jonge W.J., Pärt P. and Opperhuizen A. (1995), Allometry in the uptake of hydrophobic chemicals determined *in vivo* and in isolated perfused gills. *Toxicol. Appl. Pharmacol.* 131: 130-135.
- (5) Bintein S., Devillers J. and Karcher W. (1993), Nonlinear dependence of fish bioconcentration on *n*-octanol/water partition coefficient. *SAR QSAR Environ. Res.* 1: 29-39.
- (6) Kristensen P. (1991), Bioconcentration in fish: comparison of BCF's derived from OECD and ASTM testing methods; influence of particulate matter to the bioavailability of chemicals. Danish Water Quality Institute, Hørsholm, Denmark.
- (7) Arnot J.A., Meylan W., Tunkel J., Howard P.H., Mackay D., Bonnell M. and Boethling R.S. (2009), A quantitative structure-activity relationship for predicting metabolic biotransformation rates for organic chemicals in fish. *Environ. Toxicol. Chem.* 28: 1168-1177.
- (8) OECD (2011), QSAR Toolbox 2.1. February 2011. Available from: http://www.oecd.org/document/54/0,3746,en_2649_34379_42923638_1_1_1_1,00.html.
- (9) Branson D.R., Blau G.E., Alexander H.C. and Neely W.B. (1975). Bioconcentration of 2,2',4,4' tetrachlorobiphenyl in rainbow trout as measured by an accelerated test. *T. Am. Fish. Soc.* 104: 785-792.
- (10) Ernst W. (1985), Accumulation in aquatic organisms, in *Appraisal of tests to predict the environmental behaviour of chemicals*, Sheeman, P., *et al.*, Editors. John Wiley & Sons Ltd, New York, NY, USA: 243-255.
- (11) Reilly P.M., Bajramovic R., Blau G.E., Branson D.R. and Sauerhoff M.W. (1977), Guidelines for the optimal design of experiments to estimate parameters in first order kinetic models. *Can. J. Chem. Eng.* 55: 614-622.
- (12) Hawker D.W. and Connell D.W. (1988), Influence of partition coefficient of lipophilic compounds on bioconcentration kinetics with fish. *Wat. Res.* 22: 701-707.
- (13) Konemann H. and van Leeuwen K. (1980), Toxicokinetics in fish: Accumulation and elimination of six chlorobenzenes by guppies. *Chemosphere.* 9: 3-19.

▼ M7

Appendix 6

EQUATION SECTION FOR AQUEOUS EXPOSURE TEST: MINIMISED TEST DESIGN

The rationale for this approach is that the bioconcentration factor in a full test can either be determined as a steady-state bioconcentration factor (BCF_{SS}) by calculating the ratio of the concentration of the test substance in the fish's tissue to the concentration of the test substance in the water, or by calculating the kinetic bioconcentration factor (BCF_K) as the ratio of the uptake rate constant k_1 to the depuration rate constant k_2 . The BCF_K is valid even if a steady-state concentration of a substance is not achieved during uptake, provided that uptake and depuration act approximately according to first order kinetic processes.

If a measurement of the concentration of the substance in tissues (C_{f1}) is made at the time that exposure ends (t_1) and the concentration in tissue (C_{f2}) is measured again after a period of time has elapsed (t_2), the depuration rate constant (k_2) can be estimated using Equation A5.22 from Appendix 5.

The uptake rate constant, k_1 , can then be determined algebraically using Equation A5.23 from Appendix 5 (where C_f equals C_{f1} and t equals t_1) (1). The kinetic bioconcentration factor for the minimised design (designated as BCF_{Km} to distinguish it from kinetic bioconcentration factors determined using other methods) is thus:

$$BCF_{Km} = \frac{k_1}{k_2} \quad \text{[Equation A6.1]}$$

Concentrations or results should be corrected for growth dilution and normalised to a fish lipid content of 5 %, as is described in Appendix 5.

The minimised BCF_{SS} is the BCF calculated at the end of the uptake phase, assuming that steady-state has been reached. This can only be assumed, as the number of sampling points is not sufficient for proving this.

$$\text{minimised } BCF_{SS} = \frac{C_f - \text{minSS}}{C_w - \text{minSS}} \quad \text{[Equation A6.2]}$$

Where

$C_{f-\text{minSS}}$ = Concentration in fish at assumed steady-state at end of uptake (mg kg^{-1} wet weight).

$C_{w-\text{minSS}}$ = Concentration in water at assumed steady-state at end of uptake (mg l^{-1}).

LITERATURE:

- (1) Springer T.A., Guiney P.D., Krueger H.O. and Jaber M.J. (2008), Assessment of an approach to estimating aquatic bioconcentration factors using reduced sampling. *Environ. Toxicol. Chem.* 27: 2271-2280.

▼ M7

Appendix 7

EQUATION SECTION FOR DIETARY EXPOSURE TEST

1. Example of constituent quantities of a suitable commercial fish food
2. Food spiking technique examples
3. Calculation of assimilation efficiency and biomagnification factor
4. Lipid correction
5. Evaluation of differences between measured time zero concentration (C_{0,m}) and derived time zero concentration (C_{0,d})
6. Guidance for very fast depurating test substances

1. EXAMPLE OF CONSTITUENT QUANTITIES OF A SUITABLE COMMERCIAL FISH FOOD

Major constituent	Fish meal
Crude Protein	≤ 55,0 %
Crude fat	≤ 15,0 % ⁽¹⁾
Crude Fibre	≥ 2,0 %
Moisture	≥ 12 %
Ash	≥ 8 %

⁽¹⁾ In some regions it may only be possible to obtain fish food with a lipid concentration that falls far short of this upper limit. In such cases studies should be run with the lower lipid concentration in the food as supplied, and the feeding rate adjusted appropriately to maintain fish health. Diet lipids should not be artificially increased by the addition of excess oil.

2. FOOD SPIKING TECHNIQUE EXAMPLES

General Points

Control diets should be prepared in exactly the same way as the spiked diet, but with an absence of test substance.

To check the concentration of the treated diet, triplicate samples of the dosed food should be extracted with a suitable extraction method and the test substance concentration or radioactivity in the extracts measured. High analytical recoveries (> 85 %) with low variation between samples (three sample concentrations for the substance taken at test start should not vary more than ± 15 % from the mean) should be demonstrated.

During the dietary test, three diet samples for analysis should be collected on day 0 and at the end of the uptake phase for the determination of the test substance content in the diet.

Fish food preparation with a liquid test material (neat)

A target, nominal test concentration in the treated fish food is set, for example 500 µg test substance/g food. The appropriate quantity (by molar mass or specific radioactivity) of neat test substance is added to a known mass of fish food in a glass jar or rotary evaporator bulb. The mass of fish food should be sufficient for the duration of the uptake phase (taking into account the need

▼ **M7**

for increasing quantities at each feed owing to fish growth). The fish feed/test substance should be mixed overnight by slow tumbling (e.g. using a roto-rack mixer or by rotation if a rotary evaporator bulb is used). The spiked diet should be stored under conditions that maintain stability of the test substance within the feed mix (e.g. refrigeration) until use.

Fish food preparation with a corn or fish oil vehicle

Solid test substances should be ground in a mortar to a fine powder. Liquid test substances can be added directly to the corn or fish oil. The test substance is dissolved in a known quantity of corn or fish oil (e.g. 5-15 ml). The dosed oil is quantitatively transferred into a rotary evaporation bulb of suitable size. The flask used to prepare the dosed oil should be flushed with two small aliquots of oil and these added to the bulb to make sure all dissolved test substance is transferred. To ensure complete dissolution/dispersion in the oil (or if more than one test substance is being used in the study), a micro-stirrer is added, the flask stoppered and the mixture stirred rapidly overnight. An appropriate quantity of fish diet (usually in pellet form) for the test is added to the bulb, and the bulb's contents are mixed homogeneously by continuously turning the glass bulb for at least 30 minutes, but preferably overnight. Thereafter, the spiked food is stored appropriately (e.g. refrigerated) to ensure test substance stability in the food until use.

Fish food preparation with an organic solvent

An appropriate quantity of test substance (by molar mass or specific radioactivity) sufficient to achieve the target dose is dissolved in a suitable organic solvent (e.g. cyclohexane or acetone; 10-40 ml, but a greater volume if necessary depending on the quantity of food to spike). Either an aliquot, or all (added portion wise), of this solution is mixed with the appropriate mass of fish food sufficient for the test to achieve the required nominal dose level. The food/test substance can be mixed in a stainless steel mixing bowl and the freshly-dosed fish food left in the bowl in a laboratory hood for two days (stirred occasionally) to allow the excess solvent to evaporate, or mixed in a rotary evaporator bulb with continuous rotation. The excess solvent can be 'blown' off under a stream of air or nitrogen if necessary. Care should be taken to ensure that the test substance does not crystallise as the solvent is removed. The spiked diet should be stored under conditions (e.g. refrigeration) that maintain stability of the test substance within the feed mix until use.

3. CALCULATION OF ASSIMILATION EFFICIENCY AND BIOMAGNIFICATION FACTOR

To calculate the assimilation efficiency, the overall depuration rate constant should first be estimated according to section 4 of Appendix 5 (using the 'sequential method', *i.e.* standard linear regression) using mean sample concentrations from the depuration phase. The feeding rate constant, I , and uptake duration, t , are known parameters of the study. C_{food} , the mean measured concentration of the test substance in the food is a measured variable in the study. $C_{0,d}$, the test substance concentration in the fish at the end of the uptake phase, is usually derived from the intercept of a plot of $\ln(\text{concentration})$ vs. depuration day.

The substance assimilation efficiency (α , absorption of test substance across the gut) is calculated as:

$$\alpha = \frac{C_{0,d} \cdot k_2}{I \cdot C_{\text{food}}} \cdot \frac{1}{1 - e^{-k_2 t}} \quad [\text{Equation A7.1}]$$

where:

$C_{0,d}$ = derived concentration in fish at time zero of the depuration phase (mg kg^{-1});

▼ M7

k_2 = overall (not growth-corrected) depuration rate constant (day^{-1}),
calculated according to equations in Appendix 5, Section 3;

I = food ingestion rate constant ($\text{g food g}^{-1} \text{ fish day}^{-1}$);

C_{food} = concentration in food ($\text{mg kg}^{-1} \text{ food}$);

t = duration of the feeding period (day)

However, the feeding rate, I , used in the calculation may need to be adjusted for fish growth to give an accurate assimilation efficiency, a . In a test where fish grow significantly during the uptake phase (in which no correction of feed quantities is made to maintain the set feeding rate), the effective feeding rate as the uptake phase progresses will be lower than that set, resulting in a higher 'real' assimilation efficiency. (Note this is not important for the overall calculation of BMF as the I terms effectively cancel out between Equation A7.1 and Equation A7.4). The mean feeding rate corrected for growth dilution, I_g , can be derived in several ways, but a straightforward and rigorous one is to use the known growth rate constant (k_g) to estimate the test fish weights at time points during the uptake phase, *i.e.*:

$$W_f(t) = W_{f,0} \times e^{k_g \cdot t} \quad \text{[Equation A7.2]}$$

where

$W_f(t)$ = mean fish weight at uptake day t

$W_{f,0}$ = mean fish weight at the start of the experiment

In this way (at least) the mean fish weight on the last day of exposure ($W_{f,\text{end-of-uptake}}$) can be estimated. As the feeding rate was set based on $W_{f,0}$, the effective feeding rate for each day of uptake can be calculated using these two weight values. The growth-corrected feeding rate, I_g ($\text{g food g}^{-1} \text{ fish day}^{-1}$), to use instead of I in cases of rapid growth during the uptake phase, can then be calculated as

$$I_g = \frac{I \times W_{f,0}}{W_{f,\text{end-of-uptake}}} \quad \text{[Equation A7.3]}$$

Once the assimilation efficiency has been obtained, the BMF can be calculated by multiplying it with the feeding rate constant I (or I_g , if used to calculate α) and dividing the product by the overall depuration rate constant k_2 :

$$BMF = \frac{I \times \alpha}{k_2} \quad \text{[Equation A7.4]}$$

The growth-corrected biomagnification factor should also be calculated in the same way, using the growth corrected depuration rate constant (as derived according to section 7 in Appendix 5). Again, if I_g has been used to calculate α , it should also be used here instead of I :

$$BMF = \frac{I \times \alpha}{k_{2g}} \quad \text{[Equation A7.5]}$$

where:

α = assimilation efficiency (absorption of test substance across the gut);

k_2 = overall (not growth-corrected) depuration rate constant (day^{-1}),
calculated according to equations in Appendix 5, Section 3;

▼ **M7**

k_{2g} = growth-corrected depuration rate constant (day^{-1});

I = food ingestion rate constant ($\text{g food g}^{-1} \text{ fish day}^{-1}$);

The growth-corrected half-life ($t_{1/2}$) is calculated as follows.

$$t_{1/2} = \frac{0,693}{k_{2g}} \quad \text{[Equation A7.6]}$$

The substance assimilation efficiency from the diet can also be estimated if tissue residues are determined during the linear phase of the uptake phase (between days 1 and 3). In this case the substance assimilation efficiency (α) can be determined as follows

$$\alpha = \frac{C_{\text{fish}}(t)}{I \times C_{\text{food}} \times t} \quad \text{[Equation A7.7]}$$

Where

$C_{\text{fish}}(t)$ = the concentration of test substance in the fish at time t (mg kg^{-1} wet weight).

4. LIPID CORRECTION

If lipid content was measured on the same fish as chemical analysis for all sampling intervals, then individual concentrations should be corrected on a lipid basis and the $\ln(\text{concentration, lipid corrected})$ plotted against depuration (day) to give $C_{0,d}$ and k_2 . Assimilation efficiency (Equation A7.1) can then be calculated on a lipid basis, using C_{food} on a lipid basis (*i.e.* C_{food} is multiplied by the mean lipid fraction of the food). Subsequent calculation using Equation A7.4 and Equation A7.5 will give the lipid-corrected (and growth-dilution corrected) BMF directly.

Otherwise, the mean lipid fraction (w/w) in the fish and in the food are derived for both treatment and control groups (for food and control group fish this is usually from data measured at exposure start and end; for treatment group fish this is usually from data measured at end of exposure only). In some studies, fish lipid content may increase markedly; in such cases it is more appropriate to use a mean test fish lipid concentration calculated from the measured values at the end of exposure and end of depuration. In general, data from the treatment group only should be used to derive both of the lipid fractions.

The lipid-correction factor (L_c) is calculated as:

$$L_c = \frac{L_{\text{fish}}}{L_{\text{food}}} \quad \text{[Equation A7.8]}$$

where L_{fish} and L_{food} are the mean lipid fractions in fish and food, respectively.

The lipid-correction factor is used to calculate the lipid-corrected biomagnification factor (BMF_L):

$$\text{BMF}_L = \frac{\text{BMF}}{L_c} \quad \text{[Equation A7.9]}$$

5. EVALUATION OF DIFFERENCES BETWEEN MEASURED TIME ZERO CONCENTRATION ($C_{0,M}$) AND DERIVED TIME ZERO CONCENTRATION ($C_{0,D}$)

The measured time zero concentration ($C_{0,m}$) and derived time zero concentration ($C_{0,d}$) should be compared. If they are very similar, then this supports the first order model used to derive the depuration parameters.

▼ M7

In some studies there may be a marked difference between the derived time zero value, $C_{0,d}$, and the mean measured time zero concentration, $C_{0,m}$ (see last bullet point of paragraph 159 of this test method). If $C_{0,d}$ is very much lower than $C_{0,m}$ ($C_{0,d} \ll C_{0,m}$), the difference may suggest the presence of undigested spiked food in the gut. This may be tested experimentally by conducting separate analysis on the excised gut if additional (whole fish) samples were taken and stored at the end of the uptake phase. Otherwise, if a statistically valid outlier test applied to the depuration phase linear regression indicates that the first sample point of depuration is erroneously elevated, carrying out the linear regression to derive k_2 but omitting the first depuration concentration point may be appropriate. In such cases, if the uncertainty in the linear regression is greatly decreased, and it is clear that approximately first order depuration kinetics were obeyed, it may be appropriate to use the resulting $C_{0,d}$ and k_2 values in the assimilation efficiency calculation. This should be fully justified in the report. It is also possible that non-first order kinetics were operating in the depuration phase. If this is likely (*i.e.* the natural logarithm transformed data appear to follow a curve compared with the straight-line linear regression plot), then the calculations of k_2 and $C_{0,d}$ are unlikely to be valid and the advice of a biostatistician should be sought.

If $C_{0,d}$ is very much higher than the measured value ($C_{0,d} \gg C_{0,m}$) this may indicate: that the substance was depurated very fast (*i.e.* sampling points approached the limit of quantification of the analytical method very early in the depuration phase, *cf.* Section 6 below); that there was a deviation from first order depuration kinetics; that the linear regression to derive k_2 and $C_{0,d}$ is flawed; or that a problem with the measured concentrations in the study occurred at some sampling time points. In such cases the linear regression plot should be scrutinised for evidence of samples at or near the limit of quantification, for outliers and for obvious curvature (suggestive of non-first order kinetics), and highlighted in the report. Any subsequent re-evaluation of the linear regression to improve estimated values should be described and justified. If marked deviation from first order kinetics is observed, then the calculations of k_2 and $C_{0,d}$ are unlikely to be valid and the advice of a biostatistician should be sought.

6. GUIDANCE FOR VERY FAST DEPURATING TEST SUBSTANCES

As discussed in paragraph 129 of the test method, some substances may depurate so fast that a reliable time zero concentration, $C_{0,d}$, and k_2 cannot be derived because in samples very early in the depuration phase (*i.e.* from the second depuration sample onwards) the substance is effectively no longer measured (concentrations reported at the limit of quantification). This situation was observed in the ring test carried out in support of this test method with benzo[a]pyrene, and has been documented in the validation report for the method. In such cases linear regression cannot be carried out reliably, and is likely to give an unrealistically high estimate of $C_{0,d}$, resulting in an apparent assimilation efficiency much greater than 1. It is possible to calculate a conservative estimate of k_2 and an 'upper bound' BMF in these instances.

Using those data points of the depuration phase where a concentration was measured, up to and including the first 'non-detect' concentration (concentration set at limit of quantification), a linear regression (using natural logarithm transformed concentration data against time) will give an estimate of k_2 . For these sorts of cases this is likely only to involve two data points (e.g. sample days 1 and 2 of depuration) and then k_2 can be estimated using Equation A5.22 in Appendix 5. This k_2 estimate can be used to estimate an assimilation efficiency according to equation A7.1, substituting the $C_{0,d}$ value in the equation with the measured time zero concentration ($C_{0,m}$) in cases where $C_{0,d}$ is clearly estimated to be much higher than could have been achievable in the test. If $C_{0,m}$ was not measurable, then the limit

▼ M7

of detection in fish tissue should be used. If, in some cases, this gives a value of $\alpha > 1$, then the assimilation efficiency is assumed to 1 as a 'worst case'.

The maximum BMF_K can then be estimated using Equation A7.4, and should be quoted as a 'much less than' (\ll) value. For example, for a study carried out with a feeding rate of 3 % and a depuration half-life less than 3 days, and a 'worst case' α of 1, the BMF_K is likely to be below about 0,13. Given the purpose of this estimation and the fact that values will be conservative in nature, it is not necessary to correct them for growth dilution or fish and food lipid content.

▼ M7*Appendix 8***APPROACHES TO ESTIMATE TENTATIVE BCFS FROM DATA COLLECTED IN THE DIETARY EXPOSURE STUDY**

The dietary method is included in this test method for the bioaccumulation testing of substances that cannot in practice be tested using the aqueous exposure method. The aqueous exposure method gives a bioconcentration factor, whereas the dietary method leads directly to information on feeding biomagnification potential. In many chemical safety regimes information on aquatic bioconcentration is required (for example in risk assessment and the Globally Harmonized System of Classification). Hence there is a need to use the data generated in a dietary study to estimate a bioconcentration factor that is comparable to tests conducted according to the aqueous exposure method⁽¹⁾. This section explores approaches that may be followed to do this, while recognising the shortcomings that are inherent in the estimations.

The dietary study measures depuration to give a depuration rate constant, k_2 . If an uptake rate constant can be estimated with the available data for the situation where the fish had been exposed to the test substance via the water, then a kinetic BCF could be estimated.

The estimation of an uptake rate constant for water exposure of a test substance is reliant on many assumptions, all of which will contribute to the estimate's uncertainty. Furthermore, this approach to estimating a BCF assumes that the overall rate of depuration (including contributory factors like distribution in the body and individual depuration processes) is independent of the exposure technique used to produce a test substance body burden.

The main assumptions inherent in the estimation approach can be summarised as follows.

Depuration following dietary uptake is the same as depuration following aqueous exposure for a given substance

Uptake from water would follow first order kinetics

Depending on the method used to estimate uptake:

- uptake can be correlated with fish weight alone
- uptake can be correlated with the substance's octanol-water partition coefficient alone
- uptake can be correlated with a combination of fish weight and the substance's octanol-water partition coefficient
- factors that can affect uptake in an aqueous exposure study in practice such as substance bioavailability, adsorption to apparatus, molecular size etc. have little effect
- and, crucially:

The database ('training set') used to develop the uptake estimation method is representative of the substance under consideration

Several publications in the open literature have derived equations relating uptake from water in fish via the gills to a substance's octanol-water partition coefficient,

⁽¹⁾ In the wild the route leading to greatest exposure in aqueous environments is likely to be through ingestion for very hydrophobic substances and so an estimated BCF is not strictly representative of such a substance's bioaccumulation potential.

▼ M7

fish weight (1) (2) (3) (4), volume and/or lipid content, membrane permeation/diffusion (5) (6), fish ventilation volume (7) and by a fugacity/mass balance approach (8) (9) (10). A detailed appraisal of such methods in this context is given in Crookes & Brooke (11). A publication by Barber (12) focussed on modelling bioaccumulation through dietary uptake is also useful in this context as it includes contributions from gill uptake rate models. A section of the background document to the 2004 dietary protocol (13) was also devoted to this aspect.

Most of these models seem to have been derived using limited databases. For models where details of the database used to build the model are available, it appears that the types of substances used are often of a similar structure or class (in terms of functionality, e.g. organochlorines). This adds to the uncertainty in using a model to predict an uptake rate constant for a different type of substance, in addition to test-specific considerations like species, temperature, etc.

A review of available techniques (11) highlighted that no one method is 'more correct' than the others. Therefore, a clear justification should be given for the model used. Where several methods are available for which the use can be justified, it may be prudent to present several estimates of k_1 (and so BCF) or a range of k_1 values (and BCF) according to several uptake estimation methods. However, given the differences in model types and datasets used to develop them, taking a mean value from estimates derived in different ways would not be appropriate.

Some researchers have postulated that BCF estimates of this sort require a bioavailability correction to account for a substance's adsorption to dissolved organic carbon (DOC) under aqueous exposure conditions, to bring the estimate in line with results from aqueous exposure studies (e.g. (13) (14)). However, this correction may not be appropriate given the low levels of DOC required in an aqueous exposure study for a 'worst case' estimate (*i.e.* ratio of bioavailable substance to substance as measured in solution). For highly hydrophobic substances uptake at the gill may become limited by the rate of passive diffusion near the gill surface; in this case it is possible that the correction may be accounting for this effect rather than what it was designed for.

It is advised to focus on methods that require inputs for which data will be readily available for substances tested according to the dietary study described here (*i.e.* $\log K_{OW}$, fish weight). Other methods that require more complex inputs may be applied, but may need additional measurements in the test or detailed knowledge on the test substance or fish species that may not be widely available. In addition, choice of model may be influenced by the level of validation and applicability domain (see (11) for a review and comparison of different methods).

It should be borne in mind that the resulting k_1 estimate, and estimated BCF, are uncertain and may need to be treated in a weight-of-evidence approach along with the derived BMF and substance parameters (e.g. molecular size) for an overall picture of a substance's bioaccumulation potential. Interpretation and use of these parameters may depend on the regulatory framework.

LITERATURE:

- (1) Sijm D.T.H.M., Pärt P. and Opperhuizen A. (1993), The influence of temperature on the uptake rate constants of hydrophobic compounds determined by the isolated perfused gills of rainbow trout (*Oncorhynchus mykiss*). *Aquat. Toxicol.* 25: 1-14.
- (2) Sijm D.T.H.M., Verberne M.E., Part P. and Opperhuizen A. (1994), Experimentally determined blood and water flow limitations for uptake of hydrophobic compounds using perfused gills of rainbow trout (*Oncorhynchus mykiss*): Allometric applications. *Aquat. Toxicol.* 30: 325-341.
- (3) Sijm D.T.H.M., Verberne M.E., de Jonge W.J., Pärt P. and Opperhuizen A. (1995), Allometry in the uptake of hydrophobic chemicals determined *in vivo* and in isolated perfused gills. *Toxicol. Appl. Pharmacol.* 131: 130-135.

▼ M7

- (4) Barber M.C. (2003), A review and comparison of models for predicting dynamic chemical bioconcentration in fish. *Environ. Toxicol. Chem.* 22: 1963-1992.
- (5) Opperhuizen A. (1986), Bioconcentration of hydrophobic chemicals in fish, in *Aquatic Toxicology and Environmental Fate*, STP 921, Poston, T.M. and Purdy, R., Editors. American Society for Testing and Materials, Philadelphia, PA, USA: 304-315.
- (6) Arnot J.A. and Gobas F.A.P.C. (2004), A food web bioaccumulation model for organic chemicals in aquatic ecosystems. *Environ. Toxicol. Chem.* 23: 2343-2355.
- (7) Thomann R.V. (1989), Bioaccumulation model of organic chemical distribution in aquatic food chains. *Environ. Sci. Technol.* 23: 699-707.
- (8) Hendriks A.J., van der Linde A., Cornelissen G. and Sijm D.T.H.M. (2001). The power of size. 1. Rate constants and equilibrium ratios for accumulation of organic substances related to octanol-water partition ratio and species weight. *Environ. Toxicol. Chem.* 20: 1399-1420.
- (9) Campfens J. and Mackay D. (1997), Fugacity-based model of PCB bioaccumulation in complex aquatic food webs. *Environ. Sci. Technol.* 31: 577-583.
- (10) Arnot J.A. and Gobas F.A.P.C. (2003), A generic QSAR for assessing the bioaccumulation potential of organic chemicals in aquatic food webs. *QSAR Comb. Sci.* 22: 337-345.
- (11) Crookes M. and Brooke D. (2010), Estimation of fish bioconcentration factor (BCF) from depuration data. Draft Report. Environmental Agency, Bristol, UK.
- (12) Barber M.C. (2008), Dietary uptake models used for modelling the bioaccumulation of organic contaminants in fish. *Environ. Toxicol. Chem.* 27: 755-777
- (13) Anonymous (2004), Background document to the fish dietary study protocol, document submitted to the TC-NES WG on PBT.
- (14) Gobas F. and Morrison H. (2000), Bioconcentration and biomagnification in the aquatic environment, in *Handbook of property estimation methods for chemicals*, Boethling, R.S. and Mackay, D., Editors. Lewis Publishers, Boca Raton, FL, USA: 189-231.

▼ B**C.14. FISH JUVENILE GROWTH TEST****1. METHOD**

This growth toxicity test method is a replicate of the OECD TG 215 (2000).

1.1. INTRODUCTION

This test is designed to assess the effects of prolonged exposure to chemicals on the growth of juvenile fish. It is based on a method, developed and ring-tested (1)(2) within the European Union, for assessing the effects of chemicals on the growth of juvenile rainbow trout (*Oncorhynchus mykiss*) under flow-through conditions. Other well documented species may be used. For example, experience has been gained from growth tests with zebrafish (*Danio rerio*)⁽¹⁾ (3)(4) and ricefish (medaka, *Oryzias latipes*) (5)(6)(7).

See also General introduction Part C.

1.2. DEFINITIONS

Lowest observed effect concentration (LOEC): is the lowest tested concentration of a test substance at which the substance is observed to have a significant effect (at $p < 0,05$) when compared with the control. However, all test concentrations above the LOEC must have a harmful effect equal to or greater than those observed at the LOEC.

No observed effect concentration (NOEC): is the test concentration immediately below the LOEC.

EC_x: in this test method is the concentration of the test substance which causes a x % variation in growth rate of the fish when compared with controls.

Loading rate: is the wet weight of fish per volume of water.

Stocking density: is the number of fish per volume of water.

Individual fish specific growth rate: expresses the growth rate of one individual based on its initial weight.

Tank-average specific growth rate: expresses the mean growth rate of a tank population at one concentration.

Pseudo specific growth rate: expresses the individual growth rate compared to the mean initial weight of the tank population.

⁽¹⁾ Meyer, A., Bierman, C.H. and Orti, G. (1993). The phylogenetic position of the zebrafish (*Danio rerio*), a model system in developmental biology: an invitation to the comparative method. Proc. R. Soc. Lond. B. 252, 231-236.

▼ B

1.3. PRINCIPLE OF THE TEST METHOD

Juvenile fish in exponential growth phase are placed, after being weighted, in test chambers and are exposed to a range of sublethal concentrations of the test substance dissolved in water preferably under flow-through, or, if not possible, under appropriate semi-static (static-renewal) conditions. The test duration is 28 days. Fish are fed daily. The food ration is based on initial fish weights and may be recalculated after 14 days. At the end of the test, the fish are weighed again. Effects on growth rates are analysed using a regression model in order to estimate the concentration that would cause a x % variation in growth rate, i.e. EC_x (e.g. EC₁₀, EC₂₀, or EC₃₀). Alternatively, the data may be compared with control values in order to determine the lowest observed effect concentration (LOEC) and hence the no observed effect concentration (NOEC).

1.4. INFORMATION ON THE TEST SUBSTANCE

Results of an acute toxicity test (see Test Method C. 1.) preferably performed with the species chosen for this test, should be available. This implies that the water solubility and the vapour pressure of the test substance are known and a reliable analytical method is available for the quantification of the substance in the test solutions with known and reported accuracy and limit of detection is available.

Useful information includes the structural formula, purity of the substance, stability in water and light, pK_a, P_{ow} and results of a test for ready biodegradability (see Test Method C.4).

1.5. VALIDITY OF THE TEST

For the test to be valid the following conditions apply:

- the mortality in the control(s) must not exceed 10 % at the end of the test;
- the mean weight of fish in the control(s) must have increased enough to permit the detection of the minimum variation of growth rate considered as significant. A ring-test (2) has shown that for rainbow trout the mean weight of fish in the controls must have increased by at least the half (i.e. 50 %) of their mean initial weight over 28 days; e.g. initial weight: 1 g/fish (= 100 %), final weight after 28 days: ≥ 1,5 g/fish (≥ 150 %);
- the dissolved oxygen concentration must have been at least 60 % of the air saturation value (ASV) throughout the test;
- the water temperature must not differ by more than ± 1 °C between test chambers at any one time during the test and should be maintained within a range of 2 °C within the temperature ranges specified for the test species (Appendix 1).

1.6. DESCRIPTION OF THE TEST METHOD

1.6.1. Apparatus

Normal laboratory equipment and especially the following:

- oxygen and pH meters;

▼ B

- equipment for determination of water hardness and alkalinity;

- adequate apparatus for temperature control and preferably continuous monitoring;

- tanks made of chemically inert material and of suitable capacity in relation to the recommended loading and stocking density (see Section 1.8.5 and Appendix 1);

- suitably accurate balance (i.e. accurate to $\pm 0,5$ %).

1.6.2. Water

Any water in which the test species shows suitable long-term survival and growth may be used as a test water. It should be of constant quality during the period of the test. The pH of the water should be within the range 6,5 to 8,5, but during a given test it should be within a range of $\pm 0,5$ pH units. Hardness above 140 mg/l (as CaCO_3) is recommended. In order to ensure that the dilution water will not unduly influence the test result (for example by complexation of test substance), samples should be taken at intervals for analysis. Measurements of heavy metals (e.g. Cu, Pb, Zn, Hg, Cd and Ni), major anions and cations (e.g. Ca, Mg, Na, K, Cl and SO_4), pesticides (e.g. total organophosphorus and total organochlorine pesticides), total organic carbon and suspended solids should be made, for example, every three months where a dilution water is known to be relatively constant in quality. If water quality has been demonstrated to be constant over at least one year, determinations can be less frequent and intervals extended (e.g. every 6 months). Some chemical characteristics of an acceptable dilution water are listed in Appendix 2.

1.6.3. Test solutions

Test solutions of the chosen concentrations are prepared by dilution of a stock solution.

The stock solution should preferably be prepared by simply mixing or agitating the test substance in the dilution water by using mechanical means (e.g. stirring or ultrasonication). Saturation columns (solubility columns) can be used for achieving a suitable concentrated stock solution.

The use of solvents or dispersants (solubilising agents) may be required in some cases in order to produce a suitably concentrated stock solution. Examples of suitable solvents are acetone, ethanol, methanol, dimethylsulfoxide, dimethylformamide and triethyleneglycol. Examples of suitable dispersants are Cremophor RH40, Tween 80, Methylcellulose 0,01 % and HCO-40. Care should be taken when using readily biodegradable agents (e.g. acetone) and/or highly volatile compounds as these can cause problems with bacterial built-up in flow-through tests. When a solubilising agent is used it must have no significant effects on the fish growth nor visible adverse effects on the juvenile as revealed by a solvent-only control.

▼ B

For flow-through tests, a system which continually dispenses and dilutes a stock solution of the test substance (e.g. metering pump, proportional diluter, saturator system) is required to deliver a series of concentrations to the test chambers. The flow rates of stock solutions and dilution water should be checked at intervals, preferably daily, during the test and should not vary by more than 10 % throughout the test. A ring-test (2) has shown that, for rainbow trout, a frequency of water removal during the test of six litres/g of fish/day is acceptable (see Section 1.8.2.2).

For semi-static (renewal) tests, the frequency of medium renewal will depend on the stability of the test substance, but a daily water renewal is recommended. If, from preliminary stability tests (see Section 1.4), the test substance concentration is not stable (i.e. outside the range 80-120 % of nominal or falling below 80 % of the measured initial concentration) over the renewal period, consideration should be given to the use of a flow-through test.

1.6.4. Selection of species

Rainbow trout (*Oncorhynchus mykiss*) is the recommended species for this test since most experience has been gained from ring-test with this species (1)(2). However, other well documented species can be used but the test procedure may have to be adapted to provide suitable test conditions. For example, experience is also available with zebrafish (*Danio rerio*) (3)(4) and ricefish (medaka, *Oryzias latipes*) (5)(6)(7). The rationale for the selection of the species and the experimental method should be reported in this case.

1.6.5. Holding of fish

The test fish shall be selected from a population of a single stock, preferably from the same spawning, which has been held for at least two weeks prior to the test under conditions of water quality and illumination similar to those used in the test. They should be fed a minimum ration of 2 % body weight per day and preferably 4 % body weight per day throughout the holding period and during the test.

Following a 48 h setting-in period, mortalities are recorded and the following criteria applied:

- mortalities of greater than 10 % of population in seven days: reject the entire batch;
- mortalities of between 5 % and 10 % of population: acclimation for seven additional days; if more than 5 % mortality during second seven days, reject the entire batch;
- mortalities of less than 5 % of population in seven days: accept the batch.

Fish should not receive treatment for disease in the two weeks preceding the test, or during the test.

▼ B

1.7. TEST DESIGN

The 'test design' relates to the selection of the number and spacing of the test concentrations, the number of tanks at each concentration level and the number of fish per tank. Ideally, the test design should be chosen with regard to:

- the objective of the study;
- the method of statistical analysis that will be used;
- the availability and cost of experimental resources.

The statement of the objective should, if possible, specify the statistical power at which a given size of difference (e.g. in growth rate) is required to be detected or, alternatively, the precision with which the EC_x (e.g. with $x = 10, 20$, or 30 , and preferably not less than 10) is required to be estimated. Without this, a firm prescription of the size of the study cannot be given.

It is important to recognise that a design which is optimal (makes best use of resources) for use with one method of statistical analysis is not necessarily optimal for another. The recommended design for the estimation of a LOEC/NOEC would not therefore be the same as that recommended for analysis by regression.

In most of cases, regression analysis is preferable to the analysis of variance, for reasons discussed by Stephan and Rogers (8). However, when no suitable regression model is found ($r^2 < 0,9$) NOEC/LOEC should be used.

1.7.1. **Design for analysis by regression**

The important considerations in the design of a test to be analysed by regression are:

- The effect concentration (e.g. $EC_{10,20,30}$) and the concentration range over which the effect of the test substance is of interest, should necessarily be spanned by the concentrations included in the test. The precision with which estimates of effect concentrations can be made, will be best when the effect concentration is in the middle of the range of concentrations tested. A preliminary range-finding test may be helpful in selecting appropriate test concentrations.
- To enable satisfactory statistical modelling, the test should include at least one control tank and five additional tanks at different concentrations. Where appropriate, when a solubilising agent is used, one control containing the solubilising agent at the highest tested concentration should be run in addition to the test series (see Sections 1.8.3 and 1.8.4).
- An appropriate geometric series or logarithmic series (9) (see Appendix 3) may be used. Logarithmic spacing of test concentration is to be preferred.

▼B

- If more than six tanks are available, the additional tanks should either be used to provide replication or distributed across the range of concentrations in order to enable closer spacing of the levels. Either of these measures are equally desirable.

1.7.2. Design for estimation of a NOEC/LOEC using Analysis of Variance (ANOVA)

There should preferably be replicate tanks at each concentration, and statistical analysis should be at the tank level (10). Without replicate tanks, no allowance can be made for variability between tanks beyond that due to individual fish. However, experience has shown (11) that between-tank variability was very small compared with within-tank (i.e. between-fish) variability in the case examined. Therefore a relatively acceptable alternative is to perform statistical analysis at the level of individual fish.

Conventionally, at least five test concentrations in a geometric series with a factor preferably not exceeding 3,2 are used.

Generally, when tests are performed with replicate tanks, the number of replicate control tanks and therefore the number of fish should be the double of the number in each of the test concentrations, which should be of equal size (12)(13)(14). On the opposite, in absence of replicate tanks, the number of fish in the control group should be the same as the number in each test concentration.

If the ANOVA is to be based on tanks rather than individual fish (which would entail either individual marking of the fish or the use of 'pseudo' specific growth rates (see Section 2.1.2)), there is a need for enough replication of tanks to enable the standard deviation of 'tanks-within-concentrations' to be determined. This means that the degrees of freedom for error in the analysis of variance should be at least 5 (10). If only the controls are replicated, there is a danger that the error variability will be biased because it may increase with the mean value of the growth rate in question. Since growth rate is likely to decrease with increasing concentration, this will tend to lead to an overestimate of the variability.

1.8. PROCEDURE**1.8.1. Selection and weighing of test fish**

It is important to minimise variation in weight of the fish at the beginning of the test. Suitable size ranges for the different species recommended for use in this test are given in Appendix 1. For the whole batch of fish used in the test, the range in individual weights at the start of the test should ideally be kept to within $\pm 10\%$ of the arithmetic mean weight and, in any case, should not exceed 25%. It is recommended to weigh a subsample of fish before the test in order to estimate the mean weigh.

▼B

Food should be withheld from the stock population for 24 h prior to the start of the test. Fish should then be chosen at random. Using a general anaesthetic (e.g. an aqueous solution of 100 mg/l tricaine methane sulphonate (MS 222) neutralised by the addition of two parts of sodium bicarbonate per part of MS 222), fish should be weighted individually as wet weights (blotted dry) to the precision given in Appendix 1. Those fish with weights within the intended range should be retained and then should be randomly distributed between the test vessels. The total wet weight of fish in each test vessel should be recorded. The use of anaesthetics likewise handling of fish (including blotting and weighing) may cause stress and injuries to the juvenile fish, in particular for those species of small size. Therefore handling of juvenile fish must be done with the utmost care to avoid stressing and injuring test animals.

The fish are weighed again on day 28 of the test (see Section 1.8.6). However, if it is deemed necessary to recalculate the food ration, fish can be weighed again on day 14 of the test (see Section 1.8.2.3). Other method as photographic method could be used to determine changes in fish size from which food rations could be adjusted.

1.8.2. Conditions of exposure**1.8.2.1. Duration**

The test duration is ≥ 28 days.

1.8.2.2. Loading rates and stocking densities

It is important that the loading rate and stocking density is appropriate for the test species used (see Appendix 1). If the stocking density is too high, then overcrowding stress will occur leading to reduced growth rates and possibly to disease. If it is too low, territorial behaviour may be induced which could also affect growth. In any case, the loading rate should be low enough in order that a dissolved oxygen concentration of at least 60 % ASV can be maintained without aeration. A ring-test (2) has shown that, for rainbow trout, a loading rate of 16 trouts of 3-5 g in a 40-litre volume is acceptable. Recommended frequency of water removal during the test is 6 litres/g of fish/day.

1.8.2.3. Feeding

The fish should be fed with an appropriate food (Appendix 1) at a sufficient rate to induce acceptable growth rate. Care should be taken to avoid microbial growth and water turbidity. For rainbow trout, a rate of 4 % of their body weight per day is likely to satisfy these conditions (2)(15)(16)(17). The daily ration may be divided into two equal portions and given to the fish in two feeds per day, separated by at least 5 h. The ration is based on the initial total fish weight for each test vessel. If the fish are weighted again on day 14, the ration is then recalculated. Food should be withheld from the fish 24 h prior to weighing.

▼ B

Uneaten food and fecal material should be removed from the test vessels each day by carefully cleaning the bottom of each tank using a suction.

1.8.2.4. Light and temperature

The photoperiod and water temperature should be appropriate for the test species (Appendix 1).

1.8.3. Test concentrations

Normally five concentrations of the test substance are required, regardless of the test design (see Section 1.7.2). Prior knowledge of the toxicity of the test substance (e.g. from an acute test and/or from range-finding studies) should help in selecting appropriate test concentrations. Justification should be given if fewer than five concentrations are used. The highest tested concentration should not exceed the substance solubility limit in water.

Where a solubilising agent is used to assist in stock solution preparation, its final concentration should not be greater than 0,1 ml/l and should preferably be the same in all test vessels (see Section 1.6.3). However, every effort should be made to avoid use of such materials.

1.8.4. Controls

The number of dilution-water controls depends on the test design (see Sections 1.7-1.7.2). If a solubilising agent is used, then the same number of solubilising-agent controls as dilution-water controls should also be included.

1.8.5. Frequency of analytical determinations and measurements

During the test, the concentrations of test substance are determined at regular intervals (see below).

In flow-through tests, the flow rates of diluent and toxicant stock solution should be checked at intervals, preferably daily, and should not vary by more than 10 % throughout the test. Where the test substance concentrations are expected to be within ± 20 % of the nominal values (i.e. within the range 80-120 %; see Sections 1.6.2 and 1.6.3), it is recommended that, as a minimum, the highest and lowest test concentrations be analysed at the start of the test and at weekly intervals thereafter. For the test where the concentration of the test substance is not expected to remain within ± 20 % of nominal (on the basis of stability data of the test substance), it is necessary to analyse all test concentrations, but following the same regime.

In semi-static (renewal) tests where the concentration of the test substance is expected to remain within ± 20 % of the nominal values, it is recommended that, as a minimum, the highest and lowest test concentrations be analysed when freshly prepared and immediately prior to renewal at the start of the study and weekly thereafter. For tests where the concentration of the test substance is not expected to remain within ± 20 % of nominal, all test concentrations must be analysed following the same regime as for more stable substances.

▼ B

It is recommended that results be based on measured concentrations. However, if evidence is available to demonstrate that the concentration of the test substance in solution has been satisfactorily maintained within $\pm 20\%$ of the nominal or measured initial concentration throughout the test, then the results can be based on nominal or measured values.

Samples may need to be filtered (e.g. using a 0,45 μm pore size) or centrifuged. Centrifugation is the recommended procedure. However, if the test material does not adsorb to filters, filtration may also be acceptable.

During the test, dissolved oxygen, pH and temperature should be measured in all test vessels. Total hardness, alkalinity and salinity (if relevant) should be measured in the controls and one vessel at the highest concentration. As a minimum, dissolved oxygen and salinity (if relevant) should be measured three times (at the beginning, middle and end of the test). In semi-static tests, it is recommended that dissolved oxygen be measured more frequently, preferably before and after each water renewal or at least once a week. pH should be measured at the beginning and end of each water renewal in static renewal test and at least weekly in flow-through tests. Hardness and alkalinity should be measured once each test. Temperature should preferably be monitored continuously in at least one test vessel.

1.8.6. Observations

Weight: at the end of the test all surviving fish must be weighed as wet weights (blotted dry) either in groups by test vessel or individually. Weighing of animals by test vessel is preferred to individual weights which require that fish be individually marked. In the case of the measurement of individual weights for determination of individual fish specific growth rate, the marking technique selected should avoid stressing the animals (alternatives to freeze marking may be appropriate, e.g. the use of coloured fine fishing line).

The fish should be examined daily during the test period and any external abnormalities (such as hemorrhage, discoloration) and abnormal behaviour noted. Any mortalities should be recorded and the dead fish removed as soon as possible. Dead fish are not replaced, the loading rate and stocking density being sufficient to avoid effects on growth through changes in number of fish per tank. However, the feeding rate will need to be adjusted.

2. DATA AND REPORTING**2.1. TREATMENT OF RESULTS**

It is recommended that a statistician be involved in both the design and analysis of the test since this test method allows for considerable variation in experimental design as for example, in the number of test chambers, number of test concentrations, number of fish, etc. In view of the options available in test design, specific guidance on statistical procedure is not given here.

▼ B

Growth rates should not be calculated for test vessels where the mortality exceeds 10 %. However, mortality rate should be indicated for all test concentrations.

Whichever method is used to analyse the data, the central concept is the specific growth rate r between time t_1 and time t_2 . This can be defined in several ways depending on whether fish are individually marked or not or whether a tank average is required.

$$r_1 = \frac{\log_e w_2 - \log_e w_1}{t_2 - t_1} \times 100$$

$$r_2 = \frac{\log_e w_2 - \log_e w_1}{t_2 - t_1} \times 100$$

$$r_3 = \frac{\log_e w_2 - \log_e w_1}{t_2 - t_1} \times 100$$

where:

r_1 = individual fish specific growth rate

r_2 = tank-average specific growth rate

r_3 = 'pseudo' specific growth rate

w_1, w_2 = weights of a particular fish at times t_1 and t_2 , respectively

$\log_e w_1$ = logarithm of the weight of an individual fish at the start of the study period

$\log_e w_2$ = logarithm of the weight of an individual fish at the end of the study period

$\log_e w_1$ = average of the logarithms of the values w_1 for the fish in the tank at the start of the study period

$\log_e w_2$ = average of the logarithms of the values w_2 for the fish in the tank at the end of the study period

t_1, t_2 = time (days) at start and end of study period

r_1, r_2, r_3 can be calculated for the 0-28 days period and, where appropriate (i.e. when measurement at day 14 has been done) for the 0-14 and 14-28 days periods.

2.1.1. **Analysis of results by regression (concentration-response modelling)**

This method of analysis fits a suitable mathematical relationship between the specific growth rate and concentration, and hence enables the estimation of the 'EC_x' i.e. any required EC value. Using this method the calculation of r for individual fish (r_1) is not necessary and instead, the analysis can be based on the tank-average value of r (r_2). This last method is preferred. It is also more appropriate in case of the use of smallest species.

The tank-average specific growth rates (r_2) should be plotted graphically against concentration, in order to inspect the concentration response relationship.

▼ B

For expressing the relationship between r_2 and concentration, an appropriate model should be chosen and its choice must be supported by appropriate reasoning.

If the numbers of fish surviving in each tank are unequal, then the process of model fitting, whether simple or non-linear, should be weighted to allow for unequal sizes of groups.

The method of fitting the model must enable an estimate of, for example, the EC_{20} and of its dispersion (either standard error or confidence interval) to be derived. The graph of the fitted model should be shown in relation to the data so that the adequacy of the fit of the model can be seen (8)(18)(19)(20).

2.1.2. Analysis of results for the estimation of the LOEC

If the test has included replication of tanks at all concentration levels, the estimation of the LOEC could be based on an analysis of variance (ANOVA) of the tank-average specific growth rate (see Section 2.1), followed by a suitable method (e.g. Dunnett's or Williams' test (12)(13)(14)(21)) of comparing the average r for each concentration with the average r for the controls to identify the lowest concentration for which this difference is significant at a 0,05 probability level. If the required assumptions for parametric methods are not met — non-normal distribution (e.g. Shapiro-Wilk's test) or heterogeneous variance (Bartlett's test), consideration should be given to transforming the data to homogenise variances prior to performing the ANOVA, or to carrying out a weighted ANOVA.

If the test has not included replication of tanks at each concentration, an ANOVA based on tanks will be insensitive or impossible. In this situation, an acceptable compromise is to base the ANOVA on the 'pseudo' specific growth rate r_3 for individual fish.

The average r_3 for each test concentration may then be compared with the average r_3 for the controls. The LOEC can then be identified as before. It must be recognised that this method provides no allowance for, nor protection against, variability between tanks, beyond that which is accounted for by the variability between individual fish. However, experience has shown (8) that between-tank variability was very small compared with within-tank (i.e. between fish) variability. If individual fish are not included in the analysis, the method of outlier identification and justification for its use must be provided.

2.2. INTERPRETATION OF RESULTS

The results should be interpreted with caution where measured toxicant concentrations in test solutions occur at levels near the detection limit of the analytical method or, in semi static tests, when the concentration of the test substance decreases between freshly prepared solution and before renewal.

2.3. TEST REPORT

The test report must include the following information:

▼ B

- 2.3.1. **Test substance:**
- physical nature and relevant physical-chemical properties;
 - chemical identification data including purity and analytical method for quantification of the test substance where appropriate.
- 2.3.2. **Test species:**
- scientific name, possibly
 - strain, size, supplier, any pre-treatment, etc.
- 2.3.3. **Test conditions:**
- test procedure used (e.g. semi-static/renewal, flow-through, loading, stocking density, etc.),
 - test design (e.g. number of test vessels, test concentrations and replicates, number of fish per vessel),
 - method of preparation of stock solutions and frequency of renewal (the solubilising agent and its concentration must be given, when used),
 - the nominal test concentrations, the means of the measured values and their standard deviations in the test vessels and the method by which these were attained and evidence that the measurements refer to the concentrations of the test substance in true solution,
 - dilution water characteristics: pH, hardness, alkalinity, temperature, dissolved oxygen concentration, residual chlorine levels (if measured), total organic carbon, suspended solids, salinity of the test medium (if measured) and any other measurements made,
 - water quality within test vessels: pH, hardness, temperature and dissolved oxygen concentration,
 - detailed information on feeding, (e.g. type of food(s), source, amount given and frequency).
- 2.3.4. **Results:**
- evidence that controls met the validity criterion for survival, and data on mortalities occurring in any of the test concentrations,
 - statistical analytical techniques used, statistics based on replicates or fish, treatment of data and justification of techniques used,
 - tabulated data on individual and mean fish weights on days 0, 14 (if measured) and 28 values of tank-average or pseudo specific growth rates (as appropriate) for the periods 0-28 days or possibly 0-14 and 14-28,
 - results of the statistical analysis (i.e. regression analysis or ANOVA) preferably in tabular and graphical form and the LOEC ($p = 0,05$) and the NOEC or EC_x with, when possible, standard errors, as appropriate,

▼B

— incidence of any unusual reactions by the fish and any visible effects produced by the test substance.

3. REFERENCES

- (1) Solbe J.F. de LG (1987) Environmental Effects of Chemicals (CFM 9350 SLD). Report on a UK Ring Test of a Method for Studying the Effects of Chemicals on the Growth rate of Fish. WRc Report No PRD 1388-M/2.
- (2) Ashley S., Mallett M.J. and Grandy N.J., (1990) EEC Ring Test of a Method for Determining the Effects of Chemicals on the Growth Rate of Fish. Final Report to the Commission of the European Communities. WRc Report No EEC 2600-M.
- (3) Crossland N.O. (1985) A method to evaluate effects of toxic chemicals on fish growth. *Chemosphere*, 14, p. 1855-1870.
- (4) Nagel R., Bresh H., Caspers N., Hansen P.D., Market M., Munk R., Scholz N. and Höfte B.B., (1991) Effect of 3,4-dichloroaniline on the early life stages of the Zebrafish (*Brachydanio rerio*): results of a comparative laboratory study. *Ecotox. Environ. Safety*, 21, p. 157-164.
- (5) Yamamoto, Tokio., (1975) Series of stock cultures in biological field. Medaka (killifish) biology and strains. Keigaku Publish. Tokio, Japan.
- (6) Holcombe, G.W., Benoit D.A., Hammermeister, D.E., Leonard, E.N. and Johnson, R.D., (1995) Acute and long-term effects of nine chemicals on the Japanese medaka (*Oryzias latipes*). *Arch. Environ. Conta. Toxicol.* 28, p. 287-297.
- (7) Benoit, D.A., Holcombe, G.W. and Spehar, R.L., (1991) Guidelines for conducting early life toxicity tests with Japanese medaka (*Oryzias latipes*). Ecological Research Series EPA-600/3-91-063. U.S. Environmental Protection Agency, Duluth, Minesota.
- (8) Stephan C.E. and Rogers J.W., (1985) Advantages of using regression analysis to calculate results of chronic toxicity tests. *Aquatic Toxicology and Hazard Assessment: Eighth Symposium*, ASTM STP 891, R C Bahner and D J Hansen, Eds., American Society for Testing and Materials, Philadelphia, p. 328-338.
- (9) Environment Canada, (1992) Biological test method: toxicity tests using early life stages of salmonid fish (rainbow trout, coho salmon, or Atlantic salmon). Conservation and Protection, Ontario, Report EPS 1/RM/28, p. 81.
- (10) Cox D.R., (1958) Planning of experiments. Wiley Edt.
- (11) Pack S., (1991) Statistical issues concerning the design of tests for determining the effects of chemicals on the growth rate of fish. Room Document 4, OECD Ad Hoc Meeting of Experts on Aquatic Toxicology, WRc Medmenham, UK, 10-12 December 1991.
- (12) Dunnett C.W., (1955) A Multiple Comparisons Procedure for Comparing Several Treatments with a Control, *J. Amer. Statist. Assoc.*, 50, p. 1096-1121.
- (13) Dunnett C.W., (1964) New tables for multiple comparisons with a control. *Biometrics*, 20, p. 482-491.

▼B

- (14) Williams D.A., (1971) A test for differences between treatment means when several dose levels are compared with a zero dose control. *Biometrics* 27, p. 103-117.
- (15) Johnston, W.L., Atkinson, J.L., Glanville N.T., (1994) A technique using sequential feedings of different coloured food to determine food intake by individual rainbow trout, *Oncorhynchus mykiss*: effect of feeding level. *Aquaculture* 120, p. 123-133.
- (16) Quinton, J. C. and Blake, R.W., (1990) The effect of feed cycling and ration level on the compensatory growth response in rainbow trout, *Oncorhynchus mykiss*. *Journal of Fish Biology*, 37, p. 33-41.
- (17) Post, G., (1987) Nutrition and Nutritional Diseases of Fish. Chapter IX in *Testbook of Fish Health*. T.F.H. Publications, Inc. Neptune City, New Jersey, USA. p. 288.
- (18) Bruce, R.D. and Versteeg D.J., (1992) A statistical procedure for modelling continuous toxicity data. *Environ. Toxicol. Chem.* 11, p. 1485-1494.
- (19) DeGraeve, G.M., Cooney, J.M., Pollock, T.L., Reichenbach, J.H., Dean, Marcus, M.D. and McIntyre, D.O., (1989) Precision of EPA seven-day fathead minnow larval survival and growth test; intra and interlaboratory study. report EA-6189 (American Petroleum Institute Publication, No 4468). Electric Power Research Institute, Palo alto, CA.
- (20) Norbert-King T.J., (1988) An interpolation estimate for chronic toxicity: the ICp approach. US Environmental Protection Agency. Environmental Research Lab., Duluth, Minesota. Tech. Rep. No 05-88 of National Effluent Toxicity Assesment Center. Sept. 1988. p. 12.
- (21) Williams D.A., (1972) The comparison of several dose levels with a zero dose control. *Biometrics* 28, p. 510-531.

FISH SPECIES RECOMMENDED FOR TESTING AND SUITABLE TEST CONDITIONS

Species	Recommended test temperature range (°C)	Photoperiod (hours)	Recommended range for initial fish weight (g)	Required measurement precision	Loading rate (g/l)	Stocking density (per litre)	Food	Test duration (days)
Recommended species:								
<i>Oncorhynchus mykiss</i> rainbow trout	12,5-16,0	12-16	1-5	to nearest 100 mg	1,2-2,0	4	Dry proprietary salmonid fry food	≥ 28
Other well documented species:								
<i>Danio rerio</i> zebrafish	21-25	12-16	0,050-0,100	to nearest 1 mg	0,2-1,0	5-10	Live food (<i>Brachionus Artemia</i>)	≥ 28
<i>Oryzias latipes</i> ricefish (Medaka)	21-25	12-16	0,050-0,100	to nearest 1 mg	0,2-1,0	5-20	Live food (<i>Brachionus Artemia</i>)	≥ 28

▼B*Appendix 2***SOME CHEMICAL CHARACTERISTICS OF AN ACCEPTABLE
DILUTION WATER**

Substance	Concentrations
Particulate matter	< 20 mg/l
Total organic carbon	< 2 mg/l
Unionised ammonia	< 1 µg/l
Residual chlorine	< 10 µg/l
Total organophosphorus pesticides	< 50 ng/l
Total organochlorine pesticides plus polychlorinated biphenyls	< 50 ng/l
Total organic chlorine	< 25 ng/l



Appendix 3

Logarithmic series of concentrations suitable for toxicity test (9)

Column (Number of concentrations between 100 and 10, or between 10 and 1)(*)						
1	2	3	4	5	6	7
100	100	100	100	100	100	100
32	46	56	63	68	72	75
10	22	32	40	46	52	56
3,2	10	18	25	32	37	42
1,0	4,6	10	16	22	27	32
	2,2	5,6	10	15	19	24
	1,0	3,2	6,3	10	14	18
		1,8	4,0	6,8	10	13
		1,0	2,5	4,6	7,2	10
			1,6	3,2	5,2	7,5
			1,0	2,2	3,7	5,6
				1,5	2,7	4,2
				1,0	1,9	3,2
					1,4	2,4
					1,0	1,8
						1,3
						1,0

(*) A series of five (or more) successive concentrations may be chosen from a column. Mid-points between concentrations in column (x) are found in column (2x + 1). The values listed can represent concentrations expressed as percentage per volume or weight (mg/l or µg/l). Values can be multiplied or divided by any power of 10 as appropriate. Column 1 might be used if there was considerable uncertainty on the toxicity level.

▼B**C.15. FISH, SHORT-TERM TOXICITY TEST ON EMBRYO AND SAC-FRY STAGES****1. METHOD**

This short-term toxicity test method is a replicate of the OECD TG 212 (1998).

1.1. INTRODUCTION

This short-term toxicity test on Fish Embryo and Sac-Fry stages is a short-term test in which the life stages from the newly fertilised egg to the end of the sac-fry stage are exposed. No feeding is provided in the embryo and sac-fry test, and the test should thus be terminated while the sac-fry are still nourished from the yolk-sac.

The test is intended to define lethal, and to a limited extent, sub-lethal effects of chemicals on the specific stages and species tested. This test would provide useful information in that it could (a) form a bridge between lethal and sub-lethal tests, (b) be used as a screening test for either a Full Early Life Stage test or for chronic toxicity tests and (c) be used for testing species where husbandry techniques are not sufficiently advanced to cover the period of change from endogenous to exogenous feeding.

It should be borne in mind that only tests incorporating all stages of the life-cycle of fish are generally liable to give an accurate estimate of the chronic toxicity of chemicals to fish, and that any reduced exposure with respect to life stages may reduce the sensitivity and thus underestimate the chronic toxicity. It is therefore expected that the embryo and sac-fry test would be less sensitive than a Full Early Life Stage test, particularly with respect to chemicals with high lipophilicity ($\log P_{ow} > 4$) and chemicals with a specific mode of toxic action. However smaller differences in sensitivity between the two tests would be expected for chemicals with a non-specific, narcotic mode of action (1).

Prior to the publication of this test, most experience with this embryo and sac-fry test has been with the freshwater fish *Danio rerio* Hamilton-Buchanan (Teleostei, Cyprinidae — common name zebrafish). More detailed guidance on test performance for this species is therefore given in Appendix 1. This does not preclude the use of other species for which experience is also available (Table 1).

1.2. DEFINITIONS

Lowest Observed Effect Concentration (LOEC): is the lowest tested concentration of a test substance at which the substance is observed to have a significant effect (at $p < 0,05$) when compared with the control. However, all test concentrations above the LOEC must have a harmful effect equal to or greater than those observed at the LOEC.

No Observed Effect Concentration (NOEC): is the test concentration immediately below the LOEC.

▼ B

1.3. PRINCIPLE OF THE TEST

The embryo and sac-fry stages of fish are exposed to a range of concentrations of the test substance dissolved in water. Within the protocol a choice is possible between a semi-static and a flow-through procedure. The choice depends on the nature of the test substance. The test is begun by placing fertilised eggs in the test chambers and is terminated just before the yolk-sac of any larvae in any of the test chambers has been completely absorbed or before mortalities by starvation start in controls. Lethal and sub-lethal effects are assessed and compared with control values to determine the lowest observed effect concentration and hence the no observed effect concentration. Alternatively, they may be analysed using a regression model in order to estimate the concentration that would cause a given percentage effect (i.e. LC/EC_x, where x is a defined % effect).

1.4. INFORMATION ON THE TEST SUBSTANCE

Results of an acute toxicity test (see Method C. 1) preferably performed with the species chosen for this test, should be available. The results may be useful in selecting an appropriate range of test concentrations in the early life stages test. Water solubility (including solubility in the test water) and the vapour pressure of the test substance should be known. A reliable analytical method for the quantification of the substance in the test solutions with known and reported accuracy and limit of detection should be available.

Information on the test substance which is useful in establishing the test conditions includes the structural formula, purity of the substance, stability in light, stability under the conditions of the test, pK_a, P_{ow} and results of a test for ready biodegradability (see Method C. 4).

1.5. VALIDITY OF THE TEST

For a test to be valid, the following conditions apply:

- overall survival of fertilised eggs in the controls and where relevant, in the solvent-only vessels must be greater than or equal to the limits defined in Appendices 2 and 3

- the dissolved oxygen concentration must be between 60 and 100 % of the air saturation value (ASV) throughout the test

- the water temperature must not differ by more than $\pm 1,5$ °C between test chambers or between successive days at any time during the test and should be within the temperature ranges specified for the test species (Appendices 2 and 3).

▼B

1.6. DESCRIPTION OF THE TEST METHOD

1.6.1. **Test chambers**

Any glass or other chemically inert vessels can be used. The dimensions of the vessels should be large enough to allow compliance with the loading rate (see Section 1.7.1.2). It is recommended that test chambers be randomly positioned in the test area. A randomised block design with each treatment being present in each block is preferable to a completely randomised design when there are systematic effects in the laboratory that can be controlled using blocking. Blocking, if used, should be taken account of in the subsequent data analysis. The test chambers should be shielded from unwanted disturbance.

1.6.2. **Selection of fish species**

Recommended fish species are given in Table 1A. This does not preclude the use of other species (examples are given in Table 1B), but the test procedure may have to be adapted to provide suitable test conditions. The rationale for the selection of the species and the experimental method should be reported in this case.

1.6.3. **Holding of the brood fish**

Details on holding the brood stock under satisfactory conditions may be found in OECD TG 210 ⁽¹⁾ and in references (2)(3)(4)(5)(6).

1.6.4. **Handling of embryos and larvae**

Embryos and larvae may be exposed, within the main vessel, in smaller vessels fitted with mesh sides or ends to permit a flow of test solution through the vessel. Non-turbulent flow through these small vessels may be induced by suspending them from an arm arranged to move the vessel up and down but always keeping the organisms submerged; a siphon-flush system can also be used. Fertilised eggs of salmonid fishes can be supported on racks or meshes with apertures sufficiently large to allow larvae to drop through after hatching. The use of pasteur pipettes is appropriate to remove the embryos and larvae in the semi-static tests with complete daily renewal (see paragraph 1.6.6)

Where egg containers, grids or meshes have been used to hold eggs within the main test vessel, these restraints should be removed after the larvae hatch ⁽¹⁾, except that meshes should be retained to prevent the escape of the fish. If there is a need to transfer the larvae, they should not be exposed to the air and nets should not be used to release fish from egg containers (such a caution may not be necessary for some less fragile species, e.g. the carp). The timing of this transfer varies with the species and transfer may not always be necessary. For the semi-static technique, beakers or shallow containers may be used, and, if necessary, equipped with a mesh screen slightly elevated above the bottom of the beaker. If the volume of these containers is sufficient to comply with loading requirements, (see 1.7.1.2) no transfer of embryo or larvae may be necessary.

⁽¹⁾ OECD, Paris, 1992, Test Guideline 210, 'Fish, Early-life Stage Toxicity Test'.

▼ B**1.6.5. Water**

Any water which conforms to the chemical characteristics of an acceptable dilution water as listed in Appendix 4 and in which the test species shows control survival at least as good as that described in Appendices 2 and 3 is suitable as a test water. It should be of constant quality during the period of the test. The pH should remain within a range of $\pm 0,5$ pH units. In order to ensure that the dilution water will not unduly influence the test result (for example by complexation of test substance), or adversely affect the performance of the brood stock, samples should be taken at intervals for analysis. Measurements of heavy metals (e.g. Cu, Pb, Zn, Hg, Cd and Ni), major anions and cations (e.g. Ca, Mg, Na, K, Cl and SO_4), pesticides (e.g. total organophosphorus and total organochlorine pesticides), total organic carbon and suspended solids should be made, for example, every three months, where a dilution water is known to be relatively constant in quality. If water quality has been demonstrated to be constant over at least one year, determinations can be less frequent and intervals extended (e.g. every six months).

1.6.6. Test solutions

Test solutions of the chosen concentrations are prepared by dilution of a stock solution.

The stock solution should preferably be prepared by simply mixing or agitating the test substance in the dilution water by using mechanical means (e.g. stirring and ultrasonication). Saturation columns (solubility columns) can be used for achieving a suitable concentrated stock solution. As far as possible, the use of solvents or dispersants (solubilising agents) should be avoided; however, such compounds may be required in some cases in order to produce a suitably concentrated stock solution. Examples of suitable solvents are acetone, ethanol, methanol, dimethylformamide and triethyleneglycol. Examples of suitable dispersants are Cremophor RH40, Tween 80, methylcellulose 0,01 % and HCO-40. Care should be taken when using readily biodegradable agents (e.g. acetone) and/or highly volatile as these can cause problems with bacterial built-up in flow-through tests. When a solubilising agent is used it must have no significant effect on survival nor visible adverse effect on the early-life stages as revealed by a solvent-only control. However, every effort should be made to avoid the use of such materials.

For the semi-static technique, two different renewal procedures may be followed; either (i) new test solutions are prepared in clean vessels and surviving eggs and larvae gently transferred into the new vessels in a small volume of old solution, avoiding exposure to air, or (ii) the test organisms are retained in the vessels whilst a proportion (at least three-quarters) of the test water is changed. The frequency of medium renewal will depend on the stability of the test substance, but a daily water renewal is recommended. If, from preliminary stability tests (see Section 1.4), the test substance concentration is not stable (i.e. outside the range 80-120 % of nominal or falling below 80 % of the measured initial concentration) over the renewal period, consideration should be given to the use of a flow-through test. In any case, care should be taken to avoid stressing the larvae during the water renewal operation.

▼ B

For flow-through tests, a system which continually dispenses and dilutes a stock solution of the test substance (e.g. metering pump, proportional diluter, saturator system) is required to deliver a series of concentrations to the test chambers. The flow rates of stock solutions and dilution water should be checked at intervals, preferably daily, and should not vary by more than 10 % throughout the test. A flow rate equivalent to at least five test chamber volumes per 24 hours has been found suitable (2).

1.7. PROCEDURE

Useful information on the performance of fish embryo and sac-fry toxicity tests is available in the literature, some examples of which are included in the literature section of this text (7)(8)(9).

1.7.1. Conditions of exposure**1.7.1.1. Duration**

The test should start preferably within 30 minutes after the eggs have been fertilised. The embryos are immersed in the test solution before, or as soon as possible after, commencement of the blastodisc cleavage stage and in any case before the onset of the gastrula stage. For eggs obtained from commercial supplier, it may not be possible to start the test immediately after fertilisation. As the sensitivity of the test may be seriously influenced by delaying the start of the test, the test should be initiated within eight hours after fertilisation. As larvae are not fed during the exposure period, the test should be terminated just before the yolk sac of any larvae in any of the test chambers has been completely absorbed or before mortalities by starvation start in controls. The duration will depend upon the species used. Some recommended durations are given in Appendices 2 and 3.

1.7.1.2. Loading

The number of fertilised eggs at the start of the test should be sufficient to meet statistical requirements. They should be randomly distributed among treatments, and at least 30 fertilised eggs, divided equally (or as equally as possible since it can be difficult to obtain equal batches when using some species) between at least three replicate test chambers, should be used per concentration. The loading rate (biomass per volume of test solution) should be low enough in order that a dissolved oxygen concentration of at least 60 % ASV can be maintained without aeration. For flow-through tests, a loading rate not exceeding 0,5 g/l per 24 hours and not exceeding 5 g/l of solution at any time has been recommended (2).

1.7.1.3. Light and temperature

The photoperiod and test water temperature should be appropriate for the test species (Appendix 2 and 3). For the purpose of temperature monitoring, it may be appropriate to use an additional test vessel.

▼B**1.7.2. Test concentrations**

Normally, five concentrations of the test substance spaced by a constant factor not exceeding 3,2 are required. The curve relating LC₅₀ to period of exposure in the acute study should be considered when selecting the range of test concentrations. The use of fewer than five concentrations, for example in limit tests, and a narrower concentration interval may be appropriate in some circumstances. Justification should be provided if fewer than five concentrations are used. Concentrations of the substance higher than the 96 hour LC₅₀ or 100 mg/l, whichever is the lower, need not be tested. Substances should not be tested above their solubility limit in the test water.

When a solubilising agent is used to aid preparation of test solutions (see Section 1.6.6), its final concentration in the test vessels should not be greater than 0,1 ml/l and should be the same in all test vessels.

1.7.3. Controls

One dilution-water control (replicated as appropriate) and also, if relevant, one control containing the solubilising-agent (replicated as appropriate) should be run in addition to the test series.

1.7.4. Frequency of analytical determinations and measurements

During the test, the concentrations of the test substance are determined at regular intervals.

In semi-static tests where the concentration of the test substance is expected to remain within $\pm 20\%$ of the nominal (i.e. within the range 80-120 %; see Section 1.4 and 1.6.6), it is recommended that, as a minimum, the highest and lowest test concentrations be analysed when freshly prepared and immediately prior to renewal on at least three occasions spaced evenly over the test (i.e. analyses should be made on a sample from the same solution — when freshly prepared and at renewal).

For tests where the concentration of the test substance is not expected to remain within $\pm 20\%$ of nominal (on the basis of stability data of the substance), it is necessary to analyse all test concentrations, when freshly prepared and at renewal, but following the same regime (i.e. on at least three occasions spaced evenly over the test). Determination of test substance concentrations prior to renewal need only be performed on one replicate vessel at each test concentration. Determinations should be made no more than seven days apart. It is recommended that results be based on measured concentrations. However, if evidence is available to demonstrate that the concentration of the test substance in solution has been satisfactorily maintained within $\pm 20\%$ of the nominal or measured initial concentration throughout the test, then results can be based on nominal or measured initial values.

For flow-through tests, a similar sampling regime to that described for semi-static tests is appropriate (but measurement of 'old' solutions is not applicable in this case). However, if the test duration is more than seven days, it may be advisable to increase the number of sampling occasions during the first week (e.g. three sets of measurements) to ensure that the test concentrations are remaining stable.

▼B

Samples may need to be centrifuged or filtered (e.g. using a 0,45 µm pore size). However, since neither centrifuging nor filtration appears always to separate the non-bioavailable fraction of the test substance from that which is bioavailable, samples may not be subjected to those treatments.

During the test, dissolved oxygen, pH and temperature should be measured in all test vessels. Total hardness and salinity (if relevant) should be measured in the controls and one vessel at the highest concentration. As a minimum, dissolved oxygen and salinity (if relevant) should be measured three times (at the beginning, middle and end of the test). In semi-static tests, it is recommended that dissolved oxygen be measured more frequently, preferably before and after each water renewal or at least once at week. pH should be measured at the beginning and end of each water renewal in semi-static test and at least weekly in flow-through tests. Hardness should be measured once each test. Temperature should be measured daily and it should preferably be monitored continuously in at least one test vessel.

1.7.5. **Observations**

1.7.5.1. *Stage of embryonic development*

The embryonic stage (i.e. gastrula stage) at the beginning of exposure to the test substance should be verified as precisely as possible. This can be done using a representative sample of eggs suitably preserved and cleared. The literature may also be consulted for the description and illustration of embryonic stages (2)(5)(10)(11).

1.7.5.2. *Hatching and survival*

Observations on hatching and survival should be made at least once daily and numbers recorded. It may be desirable to make more frequent observations at the beginning of the test (e.g. each 30 minutes during the first three hours), since in some cases, survival times can be more relevant than only the number of deaths (e.g. when there are acute toxic effects). Dead embryos and larvae should be removed as soon as observed since they can decompose rapidly. Extreme care should be taken when removing dead individuals not to knock or physically damage adjacent eggs/larvae, these being extremely delicate and sensitive. Criteria for death vary according to life stage:

- **for eggs:** particularly in the early stages, a marked loss of translucency and change in colouration, caused by coagulation and/or precipitation of protein, leading to a white opaque appearance,
- **for embryos:** absence of body movement and/or absence of heart beat and/or opaque discoloration in species whose embryos are normally translucent,
- **for larvae:** immobility and/or absence of respiratory movement and/or absence of heart-beat and/or white opaque colouration of central nervous system and/or lack of reaction mechanical stimulus.

▼ B1.7.5.3. *Abnormal appearance*

The number of larvae showing abnormality of body form and/or pigmentation, and the stage of yolk-sac absorption, should be recorded at adequate intervals depending on the duration of the test and the nature of the abnormality described. It should be noted that abnormal embryos and larvae occur naturally and can be of the order of several per cent in the control(s) in some species. Abnormal animals should only be removed from the test vessels on death.

1.7.5.4. *Abnormal behaviour*

Abnormalities, e.g. hyperventilation, uncoordinated swimming, and atypical quiescence should be recorded at adequate intervals depending on the duration of the test. These effects, although difficult to quantify, can, when observed, aid in the interpretation of mortality data, i.e. provide information on the mode of toxic action of the substance.

1.7.5.5. *Length*

At the end of the test, measurement of individual lengths is recommended; standard, fork or total length may be used. If however, caudal fin rot or fin erosion occurs, standard lengths should be used. Generally, in a well-run test, the coefficient of variation for length among replicates in the controls should be $\leq 20\%$.

1.7.5.6. *Weight*

At the end of the test, individual weights can be measured; dry weights (24 hours at 60 °C) are preferable to wet weights (blotted dry). Generally, in a well-run test, the coefficient of variation for weight among replicates in the controls should be $\leq 20\%$.

These observations will result in some or all of the following data being available for statistical analysis:

- cumulative mortality,
- numbers of healthy larvae at end of test,
- time to start of hatching and end of hatching (i.e. 90 % hatching in each replicate),
- numbers of larvae hatching each day,
- length (and weight) of surviving animals at end of the test,
- numbers of larvae that are deformed or of abnormal appearance,
- numbers of larvae exhibiting abnormal behaviour.

▼ B**2. DATA AND REPORTING****2.1. TREATMENT OF RESULTS**

It is recommended that a statistician be involved in both the design and analysis of the test since the method allows for considerable variation in experimental design as, for example, in the number of test chambers, number of test concentrations, starting number of fertilised eggs and in the parameters measured. In view of the options available in test design, specific guidance on statistical procedures is not given here.

If LOEC/NOECs are to be estimated, it will be necessary for variations to be analysed within each set of replicates using analysis of variance (ANOVA) or contingency table procedures. In order to make a multiple comparison between the results at the individual concentrations and those for the controls, Dunnett's method may be found useful (12)(13). Other useful examples are also available (14)(15). The size of the effect detectable using ANOVA or other procedures (i.e. the power of the test) should be calculated and reported. It should be noted that not all the observations listed in Section 1.7.5.6 are suitable for statistical analysis using ANOVA. For example, cumulative mortality and numbers of healthy larvae at the end of the test could be analysed using probit methods.

If LC/EC_xs are to be estimated, (a) suitable curve(s), such as the logistic curve, should be fitted to the data of interest using a statistical method such as least squares or non-linear least squares. The curve(s) should be parameterised so that the LC/EC_x of interest and its standard error can be estimated directly. This will greatly ease the calculation of the confidence limits around the LC/EC_x. Unless there are good reasons to prefer different confidence levels, two-sided 95 % confidence should be quoted. The fitting procedure should preferably provide a means for assessing the significance of the lack of fit. Graphical methods for fitting curves can be used. Regression analysis is suitable for all observations listed in Section 1.7.5.6.

2.2. INTERPRETATION OF RESULTS

The results should be interpreted with caution where measured toxicant concentrations in test solutions occur at levels near the detection limit of the analytical method. The interpretation of results for concentrations above the water solubility of the substance should also be made with care.

2.3. THE TEST REPORT

The test report must include the following information:

2.3.1. Test substance:

- physical nature and relevant physical-chemical properties;

- chemical identification data, including purity and analytical method for quantification of the test substance where appropriate.

▼ B**2.3.2. Test species:**

- scientific name, strain, numbers of parental fish (i.e. how many females were used for providing the required numbers of eggs in the test), source and method of collection of the fertilised eggs and subsequent handling.

2.3.3. Test conditions:

- test procedure used (e.g. semi-static or flow-through, time period from fertilisation to start the test, loading, etc),
- photoperiod(s),
- test design (e.g. number of test chambers and replicates, number of embryos per replicate),
- method of preparation of stock solutions and frequency of renewal (the solubilising agent and its concentration must be given, when used),
- the nominal test concentrations, the measured values, their means and their standard deviations in the test vessels and the method by which these were attained and, if the test substance is soluble in water at concentrations below those tested, evidence should be provided that the measurements refer to the concentrations of the test substance in solution,
- dilution water characteristics: pH, hardness, temperature, dissolved oxygen concentration, residual chlorine levels (if measured), total organic carbon, suspended solids, salinity of the test medium (if measured) and any other measurements made,
- water quality within test vessels: pH, hardness, temperature and dissolved oxygen concentration.

2.3.4. Results:

- results from any preliminary studies on the stability of the test substance,
- evidence that controls met the overall survival acceptability standard of the test species (Appendices 2 and 3),
- data on mortality/survival at embryo and larval stages and overall mortality/survival,
- days to hatch and numbers hatched,
- data for length (and weight),
- incidence and description of morphological abnormalities, if any,
- incidence and description of behavioural effects, if any,
- statistical analysis and treatment of data,
- for tests analysed using ANOVA, the lowest observed effect concentration (LOEC) at $p=0,05$ and the no observed effect concentration (NOEC) for each response assessed, including a description of the statistical procedures used and an indication of what size of effect could be detected,

▼B

- for tests analysed using regression techniques, the LC/ECx and confidence intervals and a graph of the fitted model used for its calculation,
- explanation for any deviation from this testing method.

3. **REFERENCES**

- (1) Kristensen P., (1990) Evaluation of the Sensitivity of Short Term Fish Early Life Stage Tests in Relation to other FELS Test Methods. Final report to the Commission of the European Communities, p. 60. June 1990.
- (2) ASTM (1988) Standard Guide for Conducting Early Life-Stage Toxicity Tests with Fishes. American Society for Testing and Materials. E 1241-88. p. 26
- (3) Brauhn J.L. and Schoettger R.A., (1975) Acquisition and Culture of Research Fish: Rainbow trout, Fathead minnows, Channel Catfish and Bluegills. p. 54, Ecological Research Series, EPA-660/3-75-011, Duluth, Minnesota.
- (4) Brungs W.A. and Jones B.R., (1977) Temperature Criteria for Freshwater Fish: Protocol and Procedures p. 128, Ecological Research Series EPA-600/3-77-061, Duluth, Minnesota.
- (5) Laale H.W., (1977) The Biology and Use of the Zebrafish (*Brachydanio rerio*) in Fisheries Research. A Literature Review. J. Biol. 10, p. 121-173.
- (6) Legault R. (1958) A Technique for Controlling the Time of Daily Spawning and Collecting Eggs of the Zebrafish, *Brachydanio rerio* (Hamilton-Buchanan) Copeia, 4, p. 328-330.
- (7) Dave G., Damgaard B., Grande M., Martelin J.E., Rosander B. and Viktor T., (1987) Ring Test of an Embryo-larval Toxicity Test with Zebrafish (*Brachydanio rerio*) Using Chromium and Zinc as Toxicants. Environmental Toxicology and Chemistry, 6, p. 61-71.
- (8) Birge J.W., Black J.A. and Westerman A.G., (1985) Short-term Fish and Amphibian Embryo-larval Tests for Determining the Effects of Toxicant Stress on Early Life Stages and Estimating Chronic Values for Single Compounds and Complex Effluents. Environmental Toxicology and Chemistry 4, p. 807-821.
- (9) Van Leeuwen C.J., Espeldoorn A. and Mol F. (1986) Aquatic Toxicological Aspects of Dithiocarbamates and Related Compounds. III. Embryolarval Studies with Rainbow Trout (*Salmo gairdneri*). J. Aquatic Toxicology, 9, p. 129-145.
- (10) Kirchen R.V. and W. R. West (1969) Teleostean Development. Carolina Tips 32(4): 1-4. Carolina Biological Supply Company.
- (11) Kirchen R.V. and W. R. West (1976) The Japanese Medaka. Its care and Development. Carolina Biological Supply Company, North Carolina. p. 36.
- (12) Dunnett C.W., (1955) A Multiple Comparisons Procedure for Comparing Several Treatments with Control. J. Amer. Statist. Assoc., 50, p. 1096-1121.
- (13) Dunnett C.W. (1964) New Tables for Multiple Comparisons with a Control. Biometrics, 20, p. 482-491.
- (14) Mc Clave J.T., Sullivan J.H. and Pearson J.G., (1980) Statistical Analysis of Fish Chronic Toxicity Test Data. Proceedings of 4th Aquatic Toxicology Symposium, ASTM, Philadelphia.

▼B

- (15) Van Leeuwen C.J., Adema D.M.M. and Hermes J., (1990) Quantitative Structure-Activity Relationships for Fish Early Life Stage Toxicity. *Aquatic Toxicology*, 16, p. 321-334.
- (16) Environment Canada., (1992) Toxicity Tests Using Early Life Stages of Salmonid Fish (Rainbow Trout, Coho Salmon or Atlantic Salmon). Biological Test Method Series. Report EPS 1/RM/28, December 1992, p. 81.
- (17) Dave G. and Xiu R., (1991) Toxicity of Mercury, Nickel, Lead and Cobalt to Embryos and Larvae of Zebrafish, *Brachydanio rerio*. *Arch. of Environmental Contamination and Toxicology*, 21, p. 126-134.
- (18) Meyer A., Bierman C.H. and Orti G., (1993) The phylogenetic position of the Zebrafish (*Danio rerio*), a model system in developmental biology — an invitation to the comparative methods. *Proc. Royal Society of London, Series B*, 252: 231-236.
- (19) Ghillebaert F., Chaillou C., Deschamps F. and Roubaud P., (1995) Toxic Effects, at Three pH Levels, of Two Reference Molecules on Common Carp Embryo. *Ecotoxicology and Environmental Safety* 32, p. 19-28.
- (20) US EPA, (1991) Guidelines for Culturing the Japanese Medaka, *Oryzias latipes*. EPA report EPA/600/3-91/064, Dec. 1991, EPA, Duluth.
- (21) US EPA, (1991) Guidelines for Conducting Early Life Stage Toxicity Tests with Japanese Medaka, (*Oryzias latipes*). EPA report EPA/600/3-91/063, Dec. 1991, EPA, Duluth.
- (22) De Graeve G.M., Cooney J.D., McIntyre D.O., Poccocic T.L., Reichenbach N.G., Dean J.H. and Marcus M.D., (1991) Validity in the performance of the seven-day Fathead minnow (*Pimephales promelas*) larval survival and growth test: an intra- and interlaboratory study. *Environ. Tox. Chem.* 10, p. 1189-1203.
- (23) Calow P., (1993) *Handbook of Ecotoxicology*, Blackwells, Oxford. Vol. 1, chapter 10: Methods for spawning, culturing and conducting toxicity tests with Early Life stages of Estuarine and Marine fish.
- (24) Balon E.K., (1985) *Early life history of fishes: New developmental, ecological and evolutionary perspectives*, Junk Publ., Dordrecht, p. 280.
- (25) Blaxter J.H.S., (1988) Pattern and variety in development, In: W.S. Hoar and D.J. Randall Eds., *Fish Physiology*, vol. XIA, Academic press, p. 1-58.

Table 1A

Fish species recommended for testing

FRESHWATER
<i>Oncorhynchus mykiss</i> Rainbow trout (9)(16)
<i>Danio rerio</i> Zebrafish (7)(17)(18)
<i>Cyprinus caprio</i> Common carp (8)(19)
<i>Oryzias latipes</i> Japanese ricefish/Medaka (20)(21)
<i>Pimephales promelas</i> Fathead minnow (8)(22)

▼B

Table 1B

Examples of other well-documented species which have also been used

FRESHWATER	SALTWATER
<i>Carassius auratus</i> Goldfish (8)	<i>Menidia peninsulae</i> Tidewater silverside (23)(24)(25)
<i>Lepomis macrochirus</i> Bluegill (8)	<i>Clupea harengus</i> Herring (24)(25)
	<i>Gadus morhua</i> Cod (24)(25)
	<i>Cyprinodon variegatus</i> Sheepshead minnow (23)(24)(25)

*Appendix 1***GUIDANCE ON PERFORMANCE OF A TOXICITY TEST ON EMBRYOS AND SAC-FRY OF ZEBRAFISH (*BRACHYDANIO RERIO*)****INTRODUCTION**

The zebrafish originates from the Coromandel coast of India where it inhabits fast-flowing streams. It is a common aquarium fish of the carp family, and information about procedures for its care and culture can be found in standard reference books on tropical fish. Its biology and use in fishery research have been reviewed by Laale (1).

The fish rarely exceeds 45 mm in length. The body is cylindrical with 7-9 dark-blue horizontal silvery stripes. These stripes run into the caudal and anal fins. The back is olive-green. Males are slimmer than females. Females are more silvery and the abdomen is distended, particularly prior to spawning.

Adult fishes are able to tolerate large fluctuations in temperature, pH and hardness. However, in order to get healthy fish which produce eggs of good quality, optimal conditions should be provided.

During spawning the male pursues and butts the female, and as the eggs are expelled they are fertilised. The eggs, which are transparent and non-adhesive, fall to the bottom where they may be eaten by the parents. Spawning is influenced by light. If the morning light is adequate, the fish usually spawns in the early hours following daybreak.

A female can produce batches of several hundreds of eggs at weekly intervals.

CONDITIONS OF PARENTAL FISH, REPRODUCTION AND EARLY-LIFE STAGES

Select a suitable number of healthy fish and keep these in suitable water (e.g. Annex 4) for at least two weeks prior to the intended spawning. The group of fish should be allowed to breed at least once before producing the batch of eggs used in the test. The density of fish during this period should not exceed 1 gram of fish per litre. Regular changes of water or the use of purification systems will enable the density to be higher. The temperature in the holding tanks should be maintained at 25 ± 2 °C. The fish should be provided with a varied diet, which may consist of, for example, appropriate commercial dry food, live newly hatched *Artemia*, chironomids, *Daphnia*, white worms (*Enchytraeids*).

Two procedures are outlined below, which in practice have led to a sufficient batch of healthy, fertilised eggs for a test to be run:

- i) Eight females and 16 males are placed in a tank containing 50 litres of dilution water, shielded from direct light and left as undisturbed as possible for at least 48 hours. A spawning tray is placed at the bottom of the aquarium in the afternoon the day before start of the test. The spawning tray consists of a frame (plexi-glass or other suitable material), 5-7 cm high with a 2-5 mm coarse net attached at the top and a 10-30 µm fine net at the bottom. A number of 'spawning-trees', consisting of untwisted nylon rope, are attached to the coarse net of the frame. After the fish have been left in dark for 12 hours, a faint light is turned on which will initiate the spawning. Two to four hours after spawning, the spawning tray is removed and the eggs collected. The spawning tray will prevent the fish from eating the eggs and at the same time permit an easy collection of the eggs. The group of fish should have spawned at least once before the spawning from which eggs are used for testing.

▼ B

- ii) Five to 10 male and female fish are housed individually at least two weeks prior to the intended spawning. After 5-10 days, the abdomens of the females will be distended and their genital papillae visible. Male fish lack papillae. Spawning is performed in spawning tanks equipped with a false mesh bottom (as above). The tank is filled with dilution water, so that the depth of water above the mesh is 5-10 cm. One female and two males are placed in the tank the day before the intended spawning. The water temperature is gradually increased one degree higher than the acclimatisation temperature. The light is turned off and the tank is left as undisturbed as possible. In the morning a faint light is turned on which will initiate spawning. After two to four hours, the fish are removed and the eggs collected. If larger batches of eggs are needed than can be obtained from one female, a sufficient number of spawning tanks may be set-up in parallel. By recording the reproduction success of the individual females prior to the test (size of batch and quality), those females with highest reproduction success may be selected for breeding.

The eggs should be transferred to the test vessels by means of glass tubes (inner diameter not less than 4 mm) provided with a flexible suction bulb. The amount of water accompanying the eggs on their transfer should be as small as possible. The eggs are heavier than water and sink out of the tube. Care should be taken to prevent eggs (and larvae) coming into contact with the air. Microscopic examination of sample(s) of the batch(es) should be carried out to ensure that there are no irregularities in the first developmental stages. Disinfection of the eggs is not allowed.

The mortality rate of the eggs is highest within the first 24 hours after fertilisation. A mortality of 5-40 % is often seen during this period. Eggs degenerate as a result of unsuccessful fertilisation or development failures. The quality of the batch of eggs seems to depend on the female fish, as some females consistently produce good quality eggs, others never will. Also the development rate and the rate of hatching vary from one batch to another. The successfully fertilised eggs and the yolk sac larvae survive well, normally above 90 %. At 25 °C the eggs will hatch three-five days after fertilisation and the yolk sac will be absorbed approximately 13 days after fertilization.

The embryonic development has been well defined by Hisaoka and Battle (2). Due to the transparency of the eggs and post-hatch larvae, the development of the fish may be followed and the presence of malformations may be observed. Approximately four hours after spawning, the non-fertilized eggs may be distinguished from the fertilized (3). For this examination, eggs and larvae are placed in test vessels of small volume and studied under a microscope.

The test conditions, which apply to the early life stages, are listed in Appendix 2. Optimal values for pH values and hardness of the dilution water are 7,8 and 250 mg CaCO₃/l respectively.

CALCULATIONS AND STATISTICS

A two-stage approach is proposed. First, the data on mortality, abnormal development and hatching-time are analysed statistically. Then, for those concentrations at which no adverse effects on any of these parameters have been detected, the body length is statistically evaluated. This approach is advisable since the toxicant may selectively kill smaller fish, delay hatching-time and induce gross malformations, thus leading to biased length measurements. Furthermore, there will be roughly the same number of fish to be measured per treatment, ensuring the validity of the test statistics.

▼BLC₅₀ AND EC₅₀ DETERMINATIONS

The percentage of surviving eggs and larvae is calculated and corrected for mortality in the controls in accordance with Abbott's formula (4):

$$P = 100 - \left(\frac{C - P'}{C} \times 100 \right)$$

where:

P = corrected % survival

P' = % survival observed in the test concentration

C = % survival in the control

If possible, the LC₅₀ is determined by a suitable method at the end of the test.

If the inclusion of morphological abnormalities in the EC₅₀ statistic is desired, guidance can be found in Stephan (5).

ESTIMATION OF LOEC AND NOEC

An objective of the egg and sac-fry test is to compare the non-zero concentrations with the control, i.e. to determine the LOEC. Therefore multiple comparison procedures should be utilised (6)(7)(8)(9)(10).

REFERENCES

- (1) Laale H.W., (1977) The Biology and Use of the Zebrafish (*Brachydanio rerio*) in Fisheries Research. A Literature Review. J. Fish Biol. 10, p. 121-173.
- (2) Hisaoka K.K. and Battle H.I., (1958). The Normal Development Stages of the Zebrafish *Brachydanio rerio* (Hamilton-Buchanan) J. Morph., 102, p. 311.
- (3) Nagel R., (1986). Untersuchungen zur Eiproduktion beim Zebraabrbliing (*Brachydanio rerio* Hamilton-Buchanan). Journal of Applied Ichthyology, 2, p. 173-181.
- (4) Finney D.J., (1971). Probit Analysis, 3rd ed., Cambridge University Press, Great Britain, p. 1-333.
- (5) Stephan C.E., (1982). Increasing the Usefulness of Acute Toxicity Tests. Aquatic Toxicology and Hazard Assessment: Fifth Conference, ASTM STP 766, J.G. Pearson, R.B. Foster and W.E. Bishop, Eds., American Society for Testing and Materials, p. 69-81.
- (6) Dunnett C.W. (1955). A Multiple Comparisons Procedure for Comparing Several Treatments with a Control. J. Amer. Statist. Assoc., 50, p. 1096-1121.
- (7) Dunnett C.W., (1964) New Tables for Multiple Comparisons with a Control. Biometrics, 20, p. 482-491.
- (8) Williams D.A., (1971). A Test for Differences Between Treatment Means when Several Dose Levels are Compared with a Zero Dose Control. Biometrics, 27, p. 103-117.
- (9) Williams D.A., (1972). The Comparison of Several Dose Levels with a Zero Dose Control. Biometrics 28, p. 519-531.
- (10) Sokal R.R. and Rohlf F.J., (1981). Biometry, the Principles and Practice of Statistics in Biological Research, W.H. Freeman and Co., San Francisco.

TEST CONDITIONS, DURATION AND SURVIVAL CRITERIA FOR RECOMMENDED SPECIES

Species	Temp (°C)	Salinity (0/00)	Photo-period (hrs)	Duration of stages (days)		Typical duration of test	Survival of control, (minimum %)	
				Embryo	Sac-fry		Hatching success	Post-hatch
FRESHWATER								
<i>Brachydanio rerio</i> Zebrafish	25 ± 1	—	12-16	3-5	8-10	As soon as possible after fertilisation (early gastrula stage) to 5 days post-hatch (8-10 days)	80	90
<i>Oncorhynchus mykiss</i> Rainbow trout	10 ± 1 ⁽¹⁾ 12 ± 1 ⁽²⁾	—	0 ^(a)	30-35	25-30	As soon as possible after fertilisation (early gastrula stage) to 20 days post-hatch (50-55 days)	66	70
<i>Cyprinus carpio</i> Common carp	21-25	—	12-16	5	> 4	As soon as possible after fertilisation (early gastrula stage) to 4 days post-hatch (8-9 days)	80	75
<i>Oryzias latipes</i> Japanese ricefish/Medaka	24 ± 1 ⁽¹⁾ 23 ± 1 ⁽²⁾	—	12-16	8-11	4-8	As soon as possible after fertilisation (early gastrula stage) to 5 days post-hatch (13-16 days)	80	80
<i>Pimephales promelas</i> Fathead minnow	25 ± 2	—	16	4-5	5	As soon as possible after fertilisation (early gastrula stage) to 4 days post-hatch (8-9 days)	60	70

⁽¹⁾ For embryos.

⁽²⁾ For larvae.

^(a) Darkness for embryo and larvae until one week after hatching except when they are being inspected. Then subdued lighting throughout the test.

Test conditions, duration and survival criteria for other well documented species

Species	Temp (°C)	Salinity (0/00)	Photo-period (hrs)	Duration of stages (days)		Typical duration of embryo and sac-fry test	Survival of control (minimum %)	
				Embryo	Sac-fry test		Hatching success	Post-hatch
FRESHWATER								
<i>Carassius auratus</i> Goldfish	24 ± 1	—	—	3-4	> 4	As soon as possible after fertilisation (early gastrula stage) to 4 days post-hatch (7 days)	—	80
<i>Leopomis macrochirus</i> Blugill sunfish	21 ± 1	—	16	3	> 4	As soon as possible after fertilisation (early gastrula stage) to 4 days post-hatch (7 days)	—	75
SALTWATER								
<i>Menidia peninsulae</i> Tidewater silverside	22-25	15-22	12	1,5	10	As soon as possible after fertilisation (early gastrula stage) to 5 days post-hatch (6-7 days)	80	60
<i>Clupea harengus</i> Herring	10 ± 1	8-15	12	20-25	3-5	As soon as possible after fertilisation (early gastrula stage) to 3 days post-hatch (23-27 days)	60	80
<i>Gadus morhua</i> Cod	5 ± 1	5-30	12	14-16	3-5	As soon as possible after fertilisation (early gastrula stage) to 3 days post-hatch (18 days)	60	80
<i>Cyprinodon variegatus</i> Sheepshead minnow	25 ± 1	15-30	12	—	—	As soon as possible after fertilisation (early gastrula stage) to 4/7 days post-hatch (28 days)	> 75	80

▼B*Appendix 4***SOME CHEMICAL CHARACTERISTICS OF AN ACCEPTABLE
DILUTION WATER**

Substance	Concentrations
Particulate matter	< 20 mg/l
Total organic carbon	< 2 mg/l
Unionised ammonia	< 1 µg/l
Residual chlorine	< 10 µg/l
Total organophosphorus pesticides	< 50 ng/l
Total organochlorine pesticides plus polychlorinated biphenyls	< 50 ng/l
Total organic chlorine	< 25 ng/l

▼B**C.16. HONEYBEES — ACUTE ORAL TOXICITY TEST****1. METHOD**

This acute toxicity test method is a replicate of the OECD TG 213 (1998).

1.1. INTRODUCTION

This toxicity test is a laboratory method, designed to assess the oral acute toxicity of plant protection products and other chemicals, to adult worker honeybees.

In the assessment and evaluation of toxic characteristics of substances, determination of acute oral toxicity in honeybees may be required, e.g. when exposure of bees to a given chemical is likely. The acute oral toxicity test is carried out to determine the inherent toxicity of pesticides and other chemicals to bees. The results of this test should be used to define the need for further evaluation. In particular, this method can be used in step-wise programmes for evaluating the hazards of pesticides to bees, based on sequential progression from laboratory toxicity tests to semi-field and field experiments (1). Pesticides can be tested as active substances (a.s.) or as formulated products.

A toxic standard should be used to verify the sensitivity of the bees and the precision of the test procedure.

1.2. DEFINITIONS

Acute oral toxicity: is the adverse effects occurring within a maximum period of 96h of an oral administration of a single dose of test substance.

Dose: is the amount of test substance consumed. Dose is expressed as mass (μg) of test substance per test animal ($\mu\text{g}/\text{bee}$). The real dose for each bee can not be calculated as the bees are fed collectively, but an average dose can be estimated (totally consumed test substance/ number of test bees in one cage).

LD₅₀ (Median Lethal Dose) oral: is a statistically derived single dose of a substance that can cause death in 50 % of animals when administered by the oral route. The LD₅₀ value is expressed in μg of test substance per bee. For pesticides, the test substance may be either an active substance (a.s.) or a formulated product containing one or more than one active substance.

Mortality: an animal is recorded as dead when it is completely immobile.

1.3. PRINCIPLE OF THE TEST METHOD

Adult worker honeybees (*Apis mellifera*) are exposed to a range of doses of the test substance dispersed in sucrose solution. The bees are then fed the same diet, free of the test substance. Mortality is recorded daily during at least 48 h and compared with control values. If the mortality rate is increasing between 24 h and 48 h whilst control mortality remains at an accepted level, i.e. $\leq 10\%$, it is appropriate to extend the duration of the test to a maximum of 96 h. The results are analysed in order to calculate the LD₅₀ at 24 h and 48 h and, in case the study is prolonged, at 72 h and 96 h.

▼ B

1.4. VALIDITY OF THE TEST

For a test to be valid, the following conditions apply:

— the average mortality for the total number of controls must not exceed 10 % at the end of the test,

— the LD₅₀ of the toxic standard meets the specified range.

1.5. DESCRIPTION OF THE TEST METHOD

1.5.1. **Collection of bees**

Young adult worker bees of the same race should be used, i.e. bees of the same age, feeding status, etc. Bees should be obtained from adequately fed, healthy, as far as possible disease-free and queen-right colonies with known history and physiological status. They could be collected in the morning of use or in the evening before test and kept under test conditions to the next day. Bees collected from frames without brood are suitable. Collection in early spring or late autumn should be avoided as the bees have a changed physiology during this time. If tests must be conducted in early spring or late autumn, bees can be emerged in an incubator and reared for one week with 'bee bread' (pollen collected from the comb) and sucrose solution. Bees treated with chemical substances, such as antibiotics, anti-varroa products, etc., should not be used for toxicity test for four weeks from the time of the end of the last treatment.

1.5.2. **Housing and feeding conditions**

Easy to clean and well-ventilated cages are used. Any appropriate material can be used, e.g. stainless steel, wire mesh, plastic or disposable wooden cages, etc. Groups of 10 bees per cage are preferred. The size of test cages should be appropriate to the number of bees, i.e. providing adequate space.

The bees should be held in the dark in an experimental room at a temperature of 25 ± 2 °C. The relative humidity, normally around 50-70 %, should be recorded throughout the test. Handling procedures, including treatment and observations may be conducted under (day) light. Sucrose solution in water with a final concentration of 500 g/l (50 % w/v) is used as food. After given test doses, food should be provided *ad libitum*. The feeding system should allow recording food intake for each cage (see Section 1.6.3.1). A glass tube (approximately 50 mm long and 10 mm wide with the open end narrowed to about 2 mm diameter) can be used.

1.5.3. **Preparation of bees**

The collected bees are randomly allocated to test cages, which are randomly placed in the experimental room.

▼B

The bees may be starved for up to 2 h before the initiation of the test. It is recommended that the bees are deprived of food prior to treatment so that all bees are equal in terms of their gut contents at the start of the test. Moribund bees should be rejected and replaced by healthy bees before starting the test.

1.5.4. Preparation of doses

Where the test substance is a water miscible compound this may be dispersed directly in 50 % sucrose solution. For technical products and substances of low water solubility, vehicles such as organic solvent, emulsifiers or dispersants of low toxicity to bees may be used (e.g. acetone, dimethylformamide, dimethylsulfoxide). The concentration of the vehicle depends on the solubility of the test substance and it should be the same for all concentrations tested. However, a concentration of the vehicle of 1 % is generally appropriate and should not be exceeded.

Appropriate control solutions should be prepared, i.e. where a solvent or a dispersant is used to solubilise the test substance, two separate control groups should be used: a solution in water, and a sucrose solution with the solvent/carrier at the concentration used in dosing solutions.

1.6. PROCEDURE**1.6.1. Test and control groups**

The number of doses and replicates tested should meet the statistical requirements for determination of LD_{50} with 95 % confidence limits. Normally, five doses in a geometric series, with a factor not exceeding 2,2, and covering the range for LD_{50} , are required for the test. However, the dilution factor and the number of concentrations for dosage have to be determined in relation to the slope of the toxicity curve (dose versus mortality) and with consideration taken to the statistical method which is chosen for analysis of the results. A range-finding test enables the choice of the appropriate concentrations for dosage.

A minimum of three replicate test groups, each of 10 bees, should be dosed with each test concentration. A minimum of three control batches, each of 10 bees, should be run in addition to the test series. Control batches should also be included for the solvents/carriers used (see Section 1.5.4).

1.6.2. Toxic standard

A toxic standard should be included in the test series. At least three doses should be selected to cover the expected LD_{50} value. A minimum of three replicate cages, each containing 10 bees, should be used with each test dose. The preferred toxic standard is dimethoate, for which the reported oral LD_{50} -24 h is in the range 0,10-0,35 μg a.s./bee (2). However, other toxic standards would be acceptable where sufficient data can be provided to verify the expected dose response (e.g. parathion).

▼B**1.6.3. Exposure****1.6.3.1. Administration of doses**

Each test group of bees must be provided with 100-200 µl of 50 % sucrose solution in water, containing the test substance at the appropriate concentration. A larger volume is required for products of low solubility, low toxicity or low concentration in the formulation, as higher proportions in the sucrose solution have to be used. The amount of treated diet consumed per group should be monitored. Once consumed (usually within 3-4 h), the feeder should be removed from the cage and replaced with one containing sucrose solution alone. The sucrose solutions are then provided *ad libitum*. For some compounds, at higher concentrations rejection of test dose may result in little or no food being consumed. After a maximum of 6 h, unconsumed treated diet should be replaced with the sucrose solution alone. The amount of treated diet consumed should be assessed (e.g. measurement of volume/weight of treated diet remaining).

1.6.3.2. Duration

The duration of the test is preferably 48 h after the test solution has been replaced with sucrose solution alone. If mortality continues to rise by more than 10 % after the first 24 h, the test duration should be extended to a maximum of 96 h provided that control mortality does not exceed 10 %.

1.6.4. Observations

Mortality is recorded at 4 h after starting the test and thereafter at 24 h and 48 h (i.e. after giving dose). If a prolonged observation period is required, further assessments should be made at 24 h intervals, up to a maximum of 96 h, provided that the control mortality does not exceed 10 %.

The amount of diet consumed per group should be estimated. Comparison of the rates of consumption of treated and untreated diet within the given 6 h can provide information about palatability of the treated diet.

All abnormal behavioural effects observed during the testing period should be recorded.

1.6.5. Limit test

In some cases (e.g. when a test substance is expected to be of low toxicity) a limit test may be performed, using 100 µg a.s./bee in order to demonstrate that the LD₅₀ is greater than this value. The same procedure should be used, including three replicate test groups for the test dose, the relevant controls, the assessment of the amount of treated diet consumed, and the use of the toxic standard. If mortalities occur, a full study should be conducted. If sublethal effects are observed (see Section 1.6.4), these should be recorded.

▼B**2. DATA AND REPORTING****2.1. DATA**

Data should be summarised in tabular form, showing for each treatment group, as well as control and toxic standard groups, the number of bees used, mortality at each observation time and number of bees with adverse behaviour. Analyse the mortality data by appropriate statistical methods (e.g. probit analysis, moving-average, binomial probability) (3)(4). Plot dose-response curves at each recommended observation time and calculate the slopes of the curves and the median lethal doses (LD_{50}) with 95 % confidence limits. Corrections for control mortality could be made using Abbott's correction (4)(5). Where treated diet is not completely consumed, the dose of test substance consumed per group should be determined. LD_{50} should be expressed in μg of test substance per bee.

2.2. TEST REPORT

The test report must include the following information:

2.2.1. Test substance:

- physical nature and relevant physical-chemical properties (e.g. stability in water, vapour pressure),
- chemical identification data, including structural formula, purity (i.e. for pesticides, the identity and concentration of active substance(s)).

2.2.2. Test species:

- scientific name, race, approximate age (in weeks), collection method, date of collection,
- information on colonies used for collection of test bees including health, any adult disease, any pre-treatment, etc.

2.2.3. Test conditions:

- temperature and relative humidity of experimental room,
- housing conditions including type, size and material of cages,
- methods of preparation of stock and test solutions (the solvent and its concentration must be given, when used),
- test design, e.g. number and test concentrations used, number of controls; for each test concentration and control, number of replicate cages and number of bees per cage,
- date of test.

▼ B2.2.4. **Results:**

- results of preliminary range-finding study if performed,
- raw data: mortality at each dose tested at each observation time,
- graph of the dose-response curves at the end of the test,
- LD₅₀ values with 95 % confidence limits, at each of the recommended observation times, for test substance and toxic standard;
- statistical procedures used for determining the LD₅₀,
- mortality in controls,
- other biological effects observed or measured e.g. abnormal behaviour of the bees (including rejection of the test dose), rate of consumption of diet in treated and untreated groups,
- any deviation from the test procedures described here and any other relevant information.

3. **REFERENCES**

- (1) EPPO/Council of Europe (1993) Decision-Making Scheme for the Environmental Risk Assessment of Plant Protection Products — Honeybees. EPPO bulletin, vol. 23, N.1, 151-165. March 1993.
- (2) Gough, H. J., McIndoe, E.C., Lewis, G.B., (1994) The use of dimethoate as a reference compound in laboratory acute toxicity tests on honeybees (*Apis mellifera* L.) 1981-1992. Journal of Apicultural Research, 22, p. 119-125.
- (3) Litchfield, J.T. and Wilcoxon, F., (1949) A simplified method of evaluating dose-effect experiments. Jour. Pharmacol. and Exper. Ther., 96, p. 99-113.
- (4) Finney, D.J., (1971) Probit Analysis. 3rd ed., Cambridge, London and New-York.
- (5) Abbott, W.S., (1925) A method for computing the effectiveness of an insecticide. Jour. Econ. Entomol., 18, p. 265-267.



C.17. HONEYBEES — ACUTE CONTACT TOXICITY TEST

1. METHOD

This acute toxicity test method is a replicate of the OECD TG 214 (1998).

1.1. INTRODUCTION

This toxicity test is a laboratory method, designed to assess the acute contact toxicity of plant protection products and other chemicals to adult worker honeybees.

In the assessment and evaluation of toxic characteristics of substances, determination of acute contact toxicity in honeybees may be required, e.g. when exposure of bees to a given chemical is likely. The acute contact toxicity test is carried out to determine the inherent toxicity of pesticides and other chemicals to bees. The results of this test should be used to define the need for further evaluation. In particular, this method can be used in step-wise programmes for evaluating the hazards of pesticides to bees, based on sequential progression from laboratory toxicity tests to semi-field and field experiments (1). Pesticides can be tested as active substances (a.s.) or as formulated products.

A toxic standard should be used to verify the sensitivity of the bees and the precision of the test procedure.

1.2. DEFINITIONS

Acute contact toxicity: is the adverse effects occurring within a maximum period of 96 h of a topical application of a single dose of a substance.

Dose: is the amount of test substance applied. Dose is expressed as mass (μg) of test substance per test animal ($\mu\text{g}/\text{bee}$).

LD₅₀ (Median Lethal Dose) contact: is a statistically derived single dose of a substance that can cause death in 50 % of animals when administered by the contact. The LD₅₀ value is given in μg of test substance per bee. For pesticides, the test substance may be either an active substance (a.s.) or a formulated product containing one or more than one active substance.

Mortality: an animal is recorded as dead when it is completely immobile.

1.3. PRINCIPLE OF THE TEST METHOD

Adult worker honeybees (*Apis mellifera*) are exposed to a range of doses of the test substance dissolved in appropriate carrier, by direct application to the thorax (droplets). The test duration is 48 h. If the mortality rate is increasing between 24 h and 48 h whilst control mortality remains at an accepted level, i.e. < 10 %, it is appropriate to extend the duration of the test to a maximum of 96 h. Mortality is recorded daily and compared with control values. The results are analysed in order to calculate the LD₅₀ at 24 h and 48 h, and in case the study is prolonged at 72 h and 96 h.

▼B

1.4. VALIDITY OF THE TEST

For a test to be valid, the following conditions apply:

- the average mortality for the total numbers of controls must not exceed 10 % at the end of the test,

- the LD₅₀ of the toxic standard meets the specified range.

1.5. DESCRIPTION OF THE TEST METHOD

1.5.1. **Collection of bees**

Young adult worker bees should be used, i.e. bees of the same age, feeding status, race etc. Bees should be obtained from adequately fed, healthy, as far as possible disease-free and queen-right colonies with known history and physiological status. They could be collected in the morning of use or in the evening before test and kept under test conditions to the next day. Bees collected from frames without brood are suitable. Collection in early spring or late autumn should be avoided, as the bees have a changed physiology during the time. If tests have to be conducted in early spring or late autumn, bees can be emerged in an incubator and reared for one week with 'bee bread' (pollen collected from the comb) and sucrose solution. Bees treated with chemical substances, such as antibiotics, anti-varroa products, etc., should not be used for toxicity test for four weeks from the time of the end of the last treatment.

1.5.2. **Housing and feeding conditions**

Easy to clean and well-ventilated cages are used. Any appropriate material can be used, e.g. stainless steel, wire mesh, plastic, disposable wooden cages, etc. The size of test cages should be appropriate to the number of bees, i.e. providing adequate space. Groups of 10 bees per cage are preferred.

The bees should be held in the dark in an experimental room at a temperature of 25 ± 2 °C. The relative humidity, normally around 50-70 %, should be recorded throughout the test. Handling procedures, including treatment and observations may be conducted under (day) light. Sucrose solution in water with a final concentration of 500 g/l (50 % w/v) should be used as food and provided *ad libitum* during the test time, using a bee feeder. This can be a glass tube (approximately 50 mm long and 10 mm wide with the open end narrowed to about 2 mm diameter).

1.5.3. **Preparation of bees**

The collected bees may be anaesthetised with carbon dioxide or nitrogen for application of the test substance. The amount of anaesthetic used and time of exposure should be minimised. Moribund bees should be rejected and replaced by healthy bees before starting the test.

1.5.4. **Preparation of doses**

The test substance is to be applied as solution in a carrier, i.e. an organic solvent or a water solution with a wetting agent. As organic solvent, acetone is preferred but other organic solvents of low toxicity to bees may be used (e.g. dimethylformamide, dimethylsulfoxide). For water dispersed formulated products and highly polar organic substances not soluble in organic carrier solvents, solutions may be easier to apply if prepared in a weak solution of a commercial wetting agent (e.g. Agral, Cittowett, Lubrol, Triton, Tween).

▼ B

Appropriate control solutions should be prepared, i.e. where a solvent or a dispersant is used to solubilise the test substance, two separate control groups should be used, one treated with water, and one treated with the solvent/dispersant.

1.6. PROCEDURE**1.6.1. Test and control groups**

The number of doses and replicates tested should meet the statistical requirements for determination LD_{50} with 95 % confidence limits. Normally five doses in a geometric series, with a factor not exceeding 2,2, and covering the range for LD_{50} , are required for the test. However, the number of doses has to be determined in relation to the slope of the toxicity curve (dose versus mortality) and with consideration taken to the statistical method which is chosen for analysis of the results. A range-finding test enables the choice of the appropriate doses.

A minimum of three replicate test groups, each of 10 bees, should be dosed with each test concentration.

A minimum of three control batches, each of 10 bees, should be run in addition to the test series. If an organic solvent or a wetting agent is used three additional control batches of each 10 bees for the solvent or the wetting agent have to be included.

1.6.2. Toxic standard

A toxic standard must be included in the test series. At least three doses should be selected to cover the expected LD_{50} value. A minimum of three replicate cages, each containing 10 bees, should be used with each test dose. The preferred toxic standard is dime-thoate, for which the reported contact $LD_{50-24\text{ h}}$ is in the range 0,10-0,30 $\mu\text{g a.s./bee}$ (2). However, other toxic standards would be acceptable where sufficient data can be provided to verify the expected dose response (e.g. parathion).

1.6.3. Exposure**1.6.3.1. Administration of doses**

Anaesthetised bees are individually treated by topical application. The bees are randomly assigned to the different test doses and controls. A volume of 1 μl of solution containing the test substance at the suitable concentration should be applied with a microapplicator to the dorsal side of the thorax of each bee. Other volumes may be used, if justified. After application, the bees are allocated to test cages and supplied with sucrose solutions.

1.6.3.2. Duration

The duration of the test is preferably 48 hours. If mortality increases by more than 10 % between 24 h and 48 h, the test duration should be extended up to a maximum of 96 h provided that control mortality does not exceed 10 %.

▼ B**1.6.4. Observations**

Mortality is recorded at 4 h after dosing and thereafter at 24 h and 48 h. If a prolonged observation period is required, further assessments should be made, at 24 h intervals, to a maximum of 96 h, provided that the control mortality does not exceed 10 %.

All abnormal behavioural effects observed during the testing period should be recorded.

1.6.5. Limit test

In some cases (e.g. when a test substance is expected to be of low toxicity) limit test may be performed, using 100 µg a.s./bee in order to demonstrate that the LD₅₀ is greater than this value. The same procedure should be used, including three replicate test groups for the test dose, the relevant controls, and the use of the toxic standard. If mortalities occur, a full study should be conducted. If sublethal effects are observed (see Section 1.6.4) these should be recorded.

2. DATA AND REPORTING**2.1. DATA**

Data should be summarised in tabular form, showing for each treatment group, as well as, control and toxic standard groups, the number of bees used, mortality at each observation time and number of bees with adverse behaviour. Analyse the mortality data by appropriate statistical methods (e.g. probit analysis, moving-average, binomial probability) (3)(4). Plot dose-response curves at each recommended observation time (i.e. 24 h, 48 h and, if relevant, 72 h, 96 h) and calculate the slopes of the curves and the median lethal doses (LD₅₀) with 95 % confidence limits. Corrections for control mortality could be made using Abbott's correction (4)(5). LD₅₀ should be expressed in µg of test substance per bee.

2.2. TEST REPORT

The test report must include the following information:

2.2.1. Test substance:

- physical nature and physical-chemical properties (e.g. stability in water, vapour pressure),
- chemical identification data, including structural formula, purity (i.e. for pesticides, the identity and concentration of active substance(s)).

2.2.2. Test species:

- scientific name, race, approximate age (in weeks), collection method, date of collection,
- information on colonies used for collection of test bees including health, any adult disease, any pre-treatment, etc.

▼ B**2.2.3. Test conditions:**

- temperature and relative humidity of experimental room,
- housing conditions including type, size and material of cages,
- methods of administration of test substance, e.g. carrier solvent used, volume of test solution applied anaesthetics used,
- test design, e.g. number and test doses used, number of controls; for each test dose and control, number of replicate cages and number of bees per cage,
- date of test.

2.2.4. Results:

- results of preliminary range-finding study if performed,
- raw data: mortality at each concentration tested at each observation time,
- graph of the dose-response curves at the end of the test,
- LD₅₀ values, with 95 % confidence limits, at each of the recommended observation times, for test substance and toxic standard,
- statistical procedures used for determining the LD₅₀,
- mortality in controls,
- other biological effects observed or measured and any abnormal responses of the bees,
- any deviation from the test method procedures described here and any other relevant information.

3. REFERENCES

- (1) EPPO/Council of Europe (1993) Decision-Making Scheme for the Environmental Risk Assessment of Plant Protection Products — Honeybees. EPPO bulletin, vol. 23, N.1, p. 151-165. March, 1993.
- (2) Gough, H. J., McIndoe, E.C., Lewis, G.B., (1994) The use of dimethoate as a reference compound in laboratory acute toxicity tests on honeybees (*Apis mellifera* L.), 1981-1992. Journal of Apicultural Research 22, p. 119-125.
- (3) Litchfield, J.T. and Wilcoxon, F., (1949) A simplified method of evaluating dose-effect experiments. Jour. Pharmacol. and Exper. Ther., 96, p. 99-113.
- (4) Finney, D.J., (1971) Probit Analysis. 3rd ed., Cambridge, London and New-York.
- (5) Abbott, W.S., (1925) A method for computing the effectiveness of an insecticide. Jour. Econ. Entomol. 18, p. 265-267.

▼ B**C.18. ADSORPTION/DESORPTION USING A BATCH EQUILIBRIUM METHOD****1. METHOD**

This method is a replicate of the OECD TG 106, for the Determination of Soil Adsorption/Desorption, using a Batch Equilibrium Method (2000).

1.1. INTRODUCTION

The method takes into account a ring test and a workshop for soil selection for the development of an adsorption test (1)(2)(3)(4) and also existing guidelines at national level (5)(6)(7)(8)(9)(10)(11).

Adsorption/desorption studies are useful for generating essential information on the mobility of chemicals and their distribution in the soil, water and air compartments of the biosphere (12)(13)(14)(15)(16)(17)(18)(19)(20)(21). The information can be used in the prediction or estimation, for example, of the availability of a chemical for degradation (22)(23), transformation and uptake by organisms (24); leaching through the soil profile (16)(18)(19)(21)(25)(26)(27)(28); volatility from soil (21)(29)(30); run-off from land surfaces into natural waters (18)(31)(32). Adsorption data can be used for comparative and modelling purposes (19)(33)(34)(35).

The distribution of a chemical between soil and aqueous phases is a complex process depending on a number of different factors: the chemical nature of the substance (12)(36)(37)(38)(39)(40), the characteristics of the soil (4)(12)(13)(14)(41)(42)(43)(44)(45)(46)(47)(48)(49), and climatic factors such as rainfall, temperature, sunlight and wind. Thus, the numerous phenomena and mechanisms involved in the process of adsorption of a chemical by soil cannot be completely defined by a simplified laboratory model such as the present method. However, even if this attempt cannot cover all the environmentally possible cases, it provides valuable information on the environmental relevance of the adsorption of a chemical.

See also General Introduction.

1.2. SCOPE

The method is aimed at estimating the adsorption/desorption behaviour of a substance on soils. The goal is to obtain a sorption value which can be used to predict partitioning under a variety of environmental conditions; to this end, equilibrium adsorption coefficients for a chemical on various soils are determined as a function of soil characteristics (e.g. organic carbon content, clay content and soil texture and pH). Different soil types have to be used in order to cover as widely as possible the interactions of a given substance with naturally occurring soils.

In this method, adsorption represents the process of the binding of a chemical to surfaces of soils; it does not distinguish between different adsorption processes (physical and chemical adsorption) and such processes as surface catalysed degradation, bulk adsorption or chemical reaction. Adsorption that will occur on colloids particles (diameter < 0,2 µm) generated by the soils is not taken into account.

▼ B

The soil parameters that are believed most important for adsorption are: organic carbon content (3)(4)(12)(13)(14)(41)(43)(44)(45)(46)(47)(48); clay content and soil texture (3)(4)(41)(42)(43)(44)(45)(46)(47)(48) and pH for ionisable compounds (3)(4)(42). Other soil parameters which may have an impact on the adsorption/desorption of a particular substance are the effective cation exchange capacity (ECEC), the content of amorphous iron and aluminium oxides, particularly for volcanic and tropical soils (4), as well as the specific surface (49).

The test is designed to evaluate the adsorption of a chemical on different soil types with a varying range of organic carbon content, clay content and soil texture, and pH. It comprises three tiers:

Tier 1: preliminary study in order to determine:

- the soil/solution ratio,
- the equilibrium time for adsorption and the amount of test substance adsorbed at equilibrium,
- the adsorption of the test substance on the surfaces of the test vessels and the stability of the test substance during the test period.

Tier 2: screening test: the adsorption is studied in five different soil types by means of adsorption kinetics at a single concentration and determination of distribution coefficient K_d and K_{oc} .

Tier 3: determination of Freundlich adsorption isotherms to determine the influence of concentration on the extent of adsorption on soils.

Study of desorption by means of desorption kinetics/
Freundlich desorption isotherms (Appendix 1).

1.3. DEFINITIONS AND UNITS

Symbol	Definition	Units
A_{t_i}	adsorption percentage at the time t_i	%
A_{eq}	adsorption percentage at adsorption equilibrium	%
$m_s^{ads}(t_i)$	mass of the test substance adsorbed on the soil at the time t_i	μg
$m_s^{ads}(\Delta t_i)$	mass of the test substance adsorbed on the soil during the time interval Δt_i	μg
$m_s^{ads}(eq)$	mass of the test substance adsorbed on the soil at adsorption equilibrium	μg
m_0	mass of the test substance in the test tube, at the beginning of the adsorption test	μg
$m_m^{ads}(t_i)$	mass of the test substance measured in an aliquot (v_a^A) at the time point t_i	μg
$m_{aq}^{ads}(eq)$	mass of the substance in the solution at adsorption equilibrium	μg
m_{soil}	quantity of the soil phase, expressed in dry mass of soil	g

▼ B

Symbol	Definition	Units
C_{st}	mass concentration of the stock solution of the substance	$\mu\text{g cm}^{-3}$
C_0	initial mass concentration of the test solution in contact with the soil	$\mu\text{g cm}^{-3}$
$C_{aq}^{ads}(t_i)$	mass concentration of the substance in the aqueous phase at the time t_i that the analysis is performed	$\mu\text{g cm}^{-3}$
$C_s^{ads}(eq)$	content of the substance adsorbed on soil at adsorption equilibrium an equilibrium	$\mu\text{g g}^{-1}$
$C_{aq}^{ads}(eq)$	mass concentration of the substance in the aqueous phase at adsorption equilibrium	$\mu\text{g cm}^{-3}$
V_0	initial volume of the aqueous phase in contact with the soil during the adsorption test	cm^3
v_a^A	volume of the aliquot in which the test substance is measured	cm^3
K_d	distribution coefficient for adsorption	$\text{cm}^3 \text{g}^{-1}$
K_{oc}	organic carbon normalised adsorption coefficient	$\text{cm}^3 \text{g}^{-1}$
K_{om}	organic matter normalised distribution coefficient	$\text{cm}^3 \text{g}^{-1}$
K_F^{ads}	Freundlich adsorption coefficient	$\mu\text{g}^{1-1/n} (\text{cm}^3)^{1/n} \text{g}^{-1}$
$1/n$	Freundlich exponent	
D_{t_i}	desorption percentage at a point time t_i	%
$D_{\Delta t_i}$	desorption percentage corresponding to a time interval Δt_i	%
K_{des}	apparent desorption coefficient	$\text{cm}^3 \text{g}^{-1}$
K_F^{des}	Freundlich desorption coefficient	$\mu\text{g}^{1-1/n} (\text{cm}^3)^{1/n} \text{g}^{-1}$
$m_{aq}^{des}(t_i)$	mass of the test substance desorbed from soil at the time t_i	μg
$m_m^{des}(\Delta t_i)$	mass of the test substance desorbed from soil during the time Δt_i	μg
$m_m^{des}(eq)$	mass of the substance determined analytically in the aqueous phase at desorption equilibrium	μg
$m_{aq}^{des}(eq)$	total mass of the test substance desorbed at desorption equilibrium	μg
$m_s^{des}(\Delta t_i)$	mass of the substance remaining adsorbed on the soil after the time interval Δt_i	μg
m_{aq}^A	mass of the substance left over from the adsorption equilibrium due to incomplete volume replacement	μg
$C_s^{des}(eq)$	content of the test substance remaining adsorbed on the soil at desorption equilibrium	$\mu\text{g g}^{-1}$

▼ B

Symbol	Definition	Units
$C_{aq}^{des}(eq)$	mass concentration of the test substance in the aqueous phase at desorption equilibrium	$\mu\text{g cm}^{-3}$
V_T	total volume of the aqueous phase in contact with the soil during the desorption kinetics experiment performed with the serial method	cm^3
V_R	volume of the supernatant removed from the tube after the attainment of adsorption equilibrium and replaced by the same volume of a 0,01 M CaCl_2 solution	cm^3
V_a^D	volume of the aliquot sampled for analytical purpose from the time (i), during the desorption kinetics experiment performed with the serial method	cm^3
V_r^r	volume of the solution taken from the tube (i) for the measurement of the test substance, in desorption kinetics experiment (parallel method)	cm^3
V_r^F	volume of the solution taken from the tube for the measurement of the test substance, at desorption equilibrium	cm^3
MB	mass balance	%
m_E	total mass of the test substance extracted from soil and walls of the test vessel in two steps	μg
V_{rec}	volume of the supernatant recovered after the adsorption equilibrium	cm^3
P_{ow}	octanol/water partition coefficient	
pKa	dissociation constant	
S_w	water solubility	g l^{-1}

1.4. PRINCIPLE OF THE TEST METHOD

Known volumes of solutions of the test substance, non-labelled or radiolabelled, at known concentrations in 0,01 M CaCl_2 are added to soil samples of known dry weight which have been pre-equilibrated in 0,01 M CaCl_2 . The mixture is agitated for an appropriate time. The soil suspensions are then separated by centrifugation and, if so wished, filtration and the aqueous phase is analysed. The amount of test substance adsorbed on the soil sample is calculated as the difference between the amount of test substance initially present in solution and the amount remaining at the end of the experiment (indirect method).

As an option, the amount of the test substance adsorbed can also be directly determined by analysis of soil (direct method). This procedure which involves stepwise soil extraction with appropriate solvent, is recommended in cases where the difference in the solution concentration of the substance cannot be accurately determined. Examples of such cases are: adsorption of the test substance on surface of the test vessels, instability of the test substance in the time scale of the experiment, weak adsorption giving only small concentration change in the solution; and strong adsorption yielding low concentration which cannot be accurately determined. If radiolabelled substance is used, the soil extraction may be avoided by analysis of the soil phase by combustion and liquid scintillation counting. However, liquid scintillation counting is an unspecific technique which cannot differentiate between parental and transformation products; therefore it should be used only if the test chemical is stable for the duration of the study.

▼ B

1.5. INFORMATION ON THE TEST SUBSTANCE

Chemical reagents should be of analytical grade. The use of non-labelled test substances with known composition and preferably at least 95 % purity or of radiolabelled test substances with known composition and radio-purity, is recommended. In the case of short half-life tracers, decay corrections should be applied.

Before carrying out a test for adsorption-desorption, the following information about the test substance should be available:

- (a) water solubility (A.6);
- (b) vapour pressure (A.4) and/or Henry's Law Constant;
- (c) abiotic degradation: hydrolysis as a function of pH (C.7);
- (d) partition coefficient (A.8);
- (e) ready biodegradability (C.4) or aerobic and anaerobic transformation in soil;
- (f) pKa of ionisable substances;
- (g) direct photolysis in water (i.e. UV-vis absorption spectrum in water, quantum yield) and photodegradation on soil.

1.6. APPLICABILITY OF THE TEST

The test is applicable to chemical substances for which an analytical method with sufficient accuracy is available. An important parameter that can influence the reliability of the results, especially when the indirect method is followed, is the stability of the test substance in the time scale of the test. Thus, it is a prerequisite to check the stability in a preliminary study; if a transformation in the time scale of the test is observed, it is recommended that the main study be performed by analysing both soil and aqueous phases.

Difficulties may arise in conducting this test for test substances with low water solubility ($S_w < 10^{-4} \text{ g l}^{-1}$), as well as for highly charged substances, due to the fact that the concentration in the aqueous phase cannot be measured analytically with sufficient accuracy. In these cases, additional steps have to be taken. Guidance on how to deal with these problems is given in the relevant sections of this method.

When testing volatile substances, care should be taken to avoid losses during the study.

1.7. DESCRIPTION OF THE METHOD

1.7.1. **Apparatus and chemical reagents**

Standard laboratory equipment, especially the following:

- (a) tubes or vessels to conduct the experiments. It is important that these tubes or vessels,
 - fit directly in the centrifuge apparatus in order to minimise handling and transfer errors,
 - be made of an inert material, which minimises adsorption of the test substance on its surface,

▼ B

- (b) agitation device: overhead shaker or equivalent equipment; the agitation device should keep the soil in suspension during shaking,
- (c) centrifuge: preferably high-speed, e.g. centrifugation forces > 3 000 g, temperature controlled, capable of removing particles with a diameter greater than 0,2 µm from aqueous solution. The containers should be capped during agitation and centrifugation to avoid volatility and water losses; to minimise adsorption on them, deactivated caps such as teflon lined screw caps should be used,
- (d) optional: filtration device; filters of 0,2 µm porosity, sterile, single use. Special care should be taken in the choice of the filter material, to avoid any losses of the test substance on it; for poorly soluble test substances, organic filter material is not recommended,
- (e) analytical instrumentation, suitable for measuring the concentration of the test chemical,
- (f) laboratory oven, capable of maintaining a temperature of 103 °C to 110 °C,

1.7.2. Characterisation and selection of soils

The soils should be characterised by three parameters considered to be largely responsible for the adsorptive capacity: organic carbon, clay content and soil texture, and pH. As already mentioned (see Scope) other physico-chemical properties of the soil may have an impact on the adsorption/desorption of a particular substance and should be considered in such cases.

The methods used for soil characterisation are very important and can have a significant influence on the results. Therefore, it is recommended that soil pH should be measured in a solution of 0,01 M CaCl₂ (that is the solution used in adsorption/desorption testing) according to the corresponding ISO method (ISO-10390-1). It is also recommended that the other relevant soil properties be determined according to standard methods (for example ISO 'Handbook of Soil Analysis'); this permits the analysis of sorption data to be based on globally standardised soil parameters. Some guidance for existing standard methods of soil analysis and characterisation is given in references (50-52). For calibration of soil test methods, the use of reference soils is recommended.

Guidance for selection of soils for adsorption/desorption experiments is given in Table 1. The seven selected soils cover soil types encountered in temperate geographical zones. For ionisable test substances, the selected soils should cover a wide range of pH, in order to be able to evaluate the adsorption of the substance in its ionised and unionised forms. Guidance on how many different soils to use at the various stages of the test is given under 'Performance of the test' 1.9.

If other soil types are preferred, they should be characterised by the same parameters and should have similar variation in properties to those described in Table 1, even if they do not match the criteria exactly.



Table 1:

Guidance for selection of soil samples for adsorption-desorption

Soil Type	pH range (in 0,01 M CaCl ₂)	Organic carbon content (%)	Clay content (%)	Soil texture ⁽¹⁾
1	4,5 - 5,5	1,0 - 2,0	65-80	clay
2	> 7,5	3,5 - 5,0	20-40	clay loam
3	5,5 - 7,0	1,5 - 3,0	15-25	silt loam
4	4,0 - 5,5	3,0 - 4,0	15-30	loam
5	< 4,0 - 6,0 ⁽²⁾	< 0,5 - 1,5 ⁽²⁾ ⁽³⁾	< 10-15 ⁽²⁾	loamy sand
6	> 7,0	< 0,5 - 1,0 ⁽²⁾ ⁽³⁾	40-65	clay loam/clay
7	< 4,5	> 10	< 10	sand/loamy sand

⁽¹⁾ According to FAO and the US system (85).

⁽²⁾ The respective variables should preferably show values within the range given. If, however, difficulties in finding appropriate soil material occur, values below the indicated minimum are accepted.

⁽³⁾ Soils with less than 0,3 % organic carbon may disturb correlation between organic content and adsorption. Thus, it is recommended the use of soils with a minimum organic carbon content of 0,3 %.

1.7.3. Collection and storage of soil samples

1.7.3.1. Collection

No specific sampling techniques or tools are recommended; the sampling technique depends on the purpose of the study (53)(54)(55)(56)(57)(58).

The following should be considered:

- a) detailed information on the history of the field site is necessary; this includes location, vegetation cover, treatments with pesticides and/or fertilisers, biological additions or accidental contamination. Recommendations of the ISO standard on soil sampling (ISO 10381-6) should be followed with respect to the description of the sampling site;
- b) the sampling site has to be defined by UTM (Universal Transversal Mercator-Projection/European Horizontal Datum) or geographical co-ordinates; this could allow recollection of a particular soil in the future or could help in defining soil under various classification systems used in different countries. Also, only A horizon up to a maximum depth of 20 cm should be collected. Especially for the soil type No 7 if a O_h horizon is present as part of the soil, it should be included in the sampling.

The soil samples should be transported using containers and under temperature conditions which guarantee that the initial soil properties are not significantly altered.

▼B1.7.3.2. *Storage*

The use of soils freshly taken from the field is preferred. Only if this is not possible soil can be stored at ambient temperature and should be kept air-dried. No limit on the storage time is recommended, but soils stored for more than three years should be re-analysed prior to the use with respect to their organic carbon content, pH and CEC.

1.7.3.3. *Handling and preparation of soil samples for the test*

The soils are air-dried at ambient temperature (preferably between 20-25 °C). Disaggregation should be performed with minimal force, so that the original texture of the soil will be changed as little as possible. The soils are sieved to a particle size ≤ 2 mm; recommendations of the ISO standard on soil sampling (ISO 10381-6) should be followed with respect to the sieving process. Careful homogenisation is recommended, as this enhances the reproducibility of the results. The moisture content of each soil is determined on three aliquots with heating at 105 °C until there is no significant change in weight (approximately 12 h). For all calculations the mass of soil refers to oven dry mass, i.e. the weight of soil corrected for moisture content.

1.7.4. **Preparation of the test substance for application to soil**

The test substance is dissolved in a solution of 0,01 M CaCl₂ in distilled or de-ionised water; the CaCl₂ solution is used as the aqueous solvent phase to improve centrifugation and minimise cation exchange. The concentration of the stock solution should preferably be three orders of magnitude higher than the detection limit of the analytical method used. This threshold safeguards accurate measurements with respect to the methodology followed in this method; additionally, the stock solution concentration should be below water solubility of the test substance.

The stock solution should preferably be prepared just before application to soil samples and should be kept closed in the dark at 4 °C. The storage time depends on the stability of the test substance and its concentration in the solution.

Only for poorly soluble substances ($S_w < 10^{-4}$ g l⁻¹), an appropriate solubilising agent may be needed when it is difficult to dissolve the test substance. This solubilising agent: (a) should be miscible with water such as methanol or acetonitrile; (b) its concentration should not exceed 1 % of the total volume of the stock solution and should constitute less than that in the solution of the test substance which will come in contact with the soil (preferably less than 0,1 %); and (c) should not be a surfactant or undergo solvolytic reactions with the test chemical. The use of a solubilising agent should be stipulated and justified in the reporting of the data.

Another alternative for poorly soluble substances is to add the test substance to the test system by spiking: the test substance is dissolved in an organic solvent, an aliquot of which is added to the system of soil and 0,01 M solution of CaCl₂ in distilled or de-ionised water. The content of organic solvent in the aqueous phase should be kept as low as possible, normally not exceeding 0,1 %. Spiking from an organic solution may suffer from volume unreproducibility. Thus, an additional error may be introduced as the test substance and co-solvent concentration would not be the same in all tests.

▼ B

1.8. PREREQUISITES FOR PERFORMING THE ADSORPTION/DESORPTION TEST

1.8.1. **The analytical method**

The key parameters that can influence the accuracy of sorption measurements include the accuracy of the analytical method in analysis of both the solution and adsorbed phases, the stability and purity of the test substance, the attainment of sorption equilibrium, the magnitude of the solution concentration change, the soil/solution ratio and changes in the soil structure during the equilibration process (35)(59-62). Some examples bearing upon the accuracy issues are given in Appendix 2.

The reliability of the analytical method used must be checked at the concentration range which is likely to occur during the test. The experimenter should feel free to develop an appropriate method with appropriate accuracy, precision, reproducibility, detection limits and recovery. Guidance on how to perform such a test is given by the experiment below.

An appropriate volume of 0,01 M CaCl₂, e.g. 100 cm³, is agitated during 4 h with a weight of soil, e.g. 20 g, of high adsorbability, i.e. with high organic carbon and clay content; these weights and volumes may vary depending on analytical needs, but a soil/solution ratio of 1:5 is a convenient starting point. The mixture is centrifuged and the aqueous phase may be filtrated. A certain volume of the test substance stock solution is added to the latter to reach a nominal concentration within the concentration range which is likely to occur during the test. This volume should not exceed 10 % of the final volume of the aqueous phase, in order to change as little as possible the nature of the pre-equilibration solution. The solution is analysed.

One blank run consisting of the system soil + CaCl₂ solution (without test substance) must be included, in order to check for artefacts in the analytical method and for matrix effects caused by the soil.

The analytical methods which can be used for sorption measurements include gas-liquid chromatography (GLC), high-performance liquid chromatography (HPLC), spectrometry (e.g. GC/mass spectrometry, HPLC/mass spectrometry) and liquid scintillation counting (for radio-labelled substances). Independent of the analytical method used, it is considered suitable if the recoveries are between 90 % and 110 % of the nominal value. In order to allow for detection and evaluation after partitioning has taken place, the detection limits of the analytical method should be at least two orders of magnitude below the nominal concentration.

The characteristics and detection limits of the analytical method available for carrying out adsorption studies play an important role in defining the test conditions and the whole experimental performance of the test. This method follows a general experimental path and provides recommendations and guidance for alternative solutions where the analytical method and laboratory facilities may impose limitations.

▼ **B**1.8.2. **The selection of optimal soil/solution ratios**

Selection of appropriate soil to solution ratios for sorption studies depends on the distribution coefficient K_d and the relative degree of adsorption desired. The change of the substance concentration in the solution determines the statistical accuracy of the measurement based on the form of adsorption equation and the limit of the analytical methodology, in detecting the concentration of the chemical in solution. Therefore, in general practice it is useful to settle on a few fixed ratios, for which the percentage adsorbed is above 20 %, and preferably >50 % (62), while care should be taken to keep the test substance concentration in the aqueous phase high enough to be measured accurately. This is particularly important in the case of high adsorption percentages.

A convenient approach to selecting the appropriate soil/water ratios, is based on an estimate of the K_d value either by preliminary studies or by established estimation techniques (Appendix 3). Selection of an appropriate ratio can then be made based on a plot of soil/solution ratio versus K_d for fixed percentages of adsorption (Fig.1). In this plot it is assumed that the adsorption equation is linear⁽¹⁾. The applicable relationship is obtained by rearranging equation (4) of the K_d in the form of equation (1):

$$\frac{V_0}{m_{\text{soil}}} = \left(\frac{m_0}{m_s^{\text{ads}}(\text{eq})} - 1 \right) K_d \quad (1)$$

or in its logarithmic form assuming that $R = m_{\text{soil}}/V_0$ and $A_{\text{eq}} \%/100 = \frac{m_s^{\text{ads}}(\text{eq})}{m_0}$:

$$\log R = -\log K_d + \log \left[\frac{A_{\text{eq}} \%/100}{1 - A_{\text{eq}} \%/100} \right] \quad (2)$$

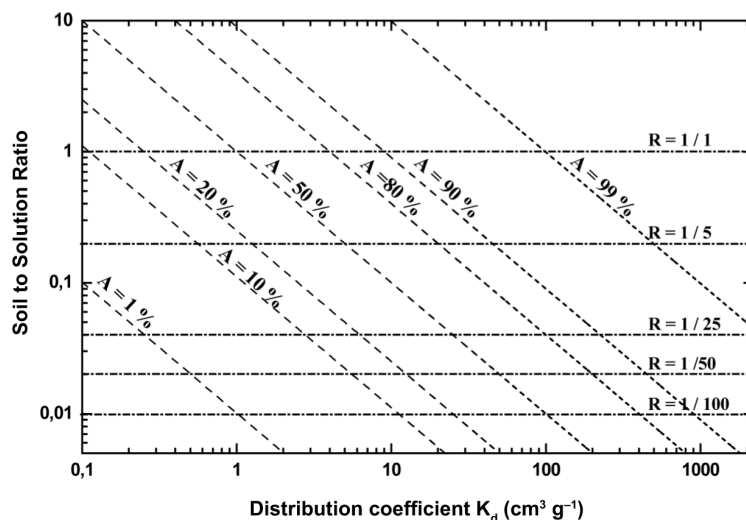

Fig. 1 Relationship between soil to solution ratios and K_d at various percentages of adsorbed test substance

⁽¹⁾ $C_s^{\text{ads}}(\text{eq}) = K_d \cdot C_{\text{aq}}^{\text{ads}}(\text{eq})$.

▼ B

Fig. 1 shows soil/solution ratios required as a function of K_d for different levels of adsorption. For example, with a soil/solution ratio of 1:5 and a K_d of 20, approximately 80 % adsorption would occur. To obtain 50 % adsorption for the same K_d , a 1:25 ratio must be used. This approach to selecting the appropriate soil/solution ratios gives the investigator the flexibility to meet experimental needs.

Areas which are more difficult to deal with are those where the chemical is highly or very slightly adsorbed. Where low adsorption occurs, a 1:1 soil/solution ratio is recommended, although for some very organic soil types smaller ratios may be necessary to obtain a slurry. Care must be taken with the analytical methodology to measure small changes in solution concentration; otherwise the adsorption measurement will be inaccurate. On the other hand, at very high distribution coefficients K_d , one can go up to a 1:100 soil/solution ratio in order to leave a significant amount of chemical in solution. However, care must be taken to ensure good mixing, and adequate time must be allowed for the system to equilibrate. An alternative approach to deal with these extreme cases when adequate analytical methodology is missing, is to predict the K_d value applying estimation techniques based, for example, on P_{ow} values (Appendix 3). This could be useful especially for low adsorbed/polar chemicals with $P_{ow} < 20$ and for lipophilic/highly sorptive chemicals with $P_{ow} > 10^4$.

1.9. PERFORMANCE OF THE TEST**1.9.1. Test conditions**

All experiments are done at ambient temperature and, if possible, at a constant temperature between 20 °C and 25 °C.

Centrifugation conditions should allow the removal of particles larger than 0,2 µm from the solution. This value triggers the smallest sized particle that is considered as a solid particle, and is the limit between solid and colloid particles. Guidance on how to determine the centrifugation conditions is given in Appendix 4.

If the centrifugation facilities cannot guarantee the removal of particles larger than 0,2 µm, a combination of centrifugation and filtration with 0,2 µm filters could be used. These filters should be made of a suitable inert material to avoid any losses of the test substance on them. In any case, it should be proven that no losses of the test substance occur during filtration.

1.9.2. Tier 1 — Preliminary study

The purpose of conducting a preliminary study has already been given in the Scope section. Guidance for setting up such a test is given with the experiment suggested below.

1.9.2.1. Selection of optimal soil/solution ratios

Two soil types and three soil/solution ratios (six experiments) are used. One soil type has high organic carbon and low clay content, and the other low organic carbon and high clay content. The following soil to solution ratios are suggested:

— 50 g soil and 50 cm³ aqueous solution of the test substance (ratio 1/1),

▼B

- 10 g soil and 50 cm³ aqueous solution of the test substance (ratio 1/5),

- 2 g soil and 50 cm³ aqueous solution of the test substance (ratio 1/25).

The minimum amount of soil on which the experiment can be carried out depends on the laboratory facilities and the performance of analytical methods used. However, it is recommended to use at least 1 g, and preferably 2 g, in order to obtain reliable results from the test.

One control sample with only the test substance in 0,01 M CaCl₂ solution (no soil) is subjected to precisely the same steps as the test systems, in order to check the stability of the test substance in CaCl₂ solution and its possible adsorption on the surfaces of the test vessels.

A blank run per soil with the same amount of soil and total volume of 50 cm³ 0,01 M CaCl₂ solution (without test substance) is subjected to the same test procedure. This serves as a background control during the analysis to detect interfering substances or contaminated soils.

All the experiments, included controls and blanks, should be performed at least in duplicate. The total number of the samples which should be prepared for the study can be calculated with respect to the methodology which will be followed.

Methods for the preliminary study and the main study are generally the same, exceptions are mentioned where relevant.

The air-dried soil samples are equilibrated by shaking with a minimum volume of 45 cm³ of 0,01 M CaCl₂ overnight (12 h) before the day of the experiment. Afterwards, a certain volume of the stock solution of the test substance is added in order to adjust the final volume to 50 cm³. This volume of the stock solution added: (a) should not exceed 10 % of the final 50 cm³ volume of the aqueous phase in order to change as little as possible the nature of the pre-equilibration solution; and (b) should preferably result in an initial concentration of the test substance being in contact with the soil (C₀) at least two orders of magnitude higher than the detection limit of the analytical method; this threshold safeguards the ability to perform accurate measurements even when strong adsorption occurs (> 90 %) and to determine later the adsorption isotherms. It is also recommended, if possible, that the initial substance concentration (C₀) not exceed half of its solubility limit.

An example of how to calculate the concentration of the stock solution (C_{st}) is given below. A detection limit of 0,01 µg cm⁻³ and 90 % adsorption are assumed; thus, the initial concentration of the test substance in contact with the soil should preferably be 1 µg cm⁻³ (two orders of magnitude higher than the detection limit). Supposing that the maximum recommended volume of the stock solution is added, i.e. 5 to 45 cm³ 0,01 M CaCl₂ equilibration solution (= 10 % of the stock solution to 50 cm³ total volume of aqueous phase), the concentration of the stock solution should be 10 µg cm⁻³; this is three orders of magnitude higher than the detection limit of the analytical method.

The pH of the aqueous phase should be measured before and after contact with the soil since it plays an important role in the whole adsorption process, especially for ionisable substances.

▼ B

The mixture is shaken until adsorption equilibrium is reached. The equilibrium time in soils is highly variable, depending on the chemical and the soil; a period of 24 h is generally sufficient (77). In the preliminary study, samples may be collected sequentially over a 48 h period of mixing (for example at 4, 8, 24, 48 h). However, times of analysis should be considered with flexibility with respect to the work schedule of the laboratory.

There are two options for the analysis of the test substance in the aqueous solution: (a) the parallel method and (b) the serial method. It should be stressed that, although the parallel method is experimentally more tedious, the mathematical treatment of the results is simpler (Appendix 5). However, the choice of the methodology to be followed, is left to the experimenter who will need to consider the available laboratory facilities and resources.

(a) parallel method: samples with the same soil/solution ratio are prepared, as many as the time intervals at which it is desired to study the adsorption kinetics. After centrifugation and if so wished filtration, the aqueous phase of the first tube is recovered as completely as possible and is measured after, for example, 4 h, that of the second tube after 8 h, that of the third after 24, etc.

(b) serial method: only a duplicate sample is prepared for each soil/solution ratio. At defined time intervals the mixture is centrifuged to separate the phases. A small aliquot of the aqueous phase is immediately analysed for the test substance; then the experiment continues with the original mixture. If filtration is applied after centrifugation, the laboratory should have facilities to handle filtration of small aqueous aliquots. It is recommended that the total volume of the aliquots taken not exceed 1 % of the total volume of the solution, in order not to change significantly the soil/solution ratio and to decrease the mass of solute available for adsorption during the test.

The percentage adsorption A_{t_i} is calculated at each time point (t_i) on the basis of the nominal initial concentration and the measured concentration at the sampling time (t_i), corrected for the value of the blank. Plots of the A_{t_i} versus time (Fig. 1 Appendix 5) are generated in order to estimate the achievement of equilibrium plateau⁽¹⁾. The K_d value at equilibrium is also calculated. Based on this K_d value, appropriate soil/solution ratios are selected from Fig.1, so that the percentage adsorption reaches above 20 % and preferably >50 % (61). All the applicable equations and principles of plotting are given in section on Data and Reporting and in Appendix 5.

1.9.2.2. *Determination of adsorption equilibration time and of the amount of test substance adsorbed at equilibrium*

As already mentioned, plots of A_{t_i} or C_{aq}^{ads} versus time permit estimation of the achievement of the adsorption equilibrium and the amount of test substance adsorbed at equilibrium. Figs. 1 and 2 in the Appendix 5 show examples of such plots. Equilibration time is the system needs to reach a plateau.

⁽¹⁾ Plots of the concentration of the test substance in the aqueous phase (C_{aq}^{ads}) versus time could also be used to estimate the achievement of the equilibrium plateau (see Fig. 2 in Appendix 5).

▼ B

If, with a particular soil, no plateau but a steady increase is found, this may be due to complicating factors such as biodegradation or slow diffusion. Biodegradation can be shown by repeating the experiment with a sterilised sample of the soil. If no plateau is achieved even in this case, the experimenter should search for other phenomena that could be involved in his specific studies; this could be done with appropriate modifications of the experiment conditions (temperature, shaking times, soil/solution ratios). It is left to the experimenter to decide whether to continue the test procedure in spite of a possible failure to achieve an equilibrium.

1.9.2.3. *Adsorption on the surface of the test vessel and stability of the test substance*

Some information on the adsorption of the test substance on the surface of test vessels, as well as its stability, can be derived by analysing the control samples. If a depletion more than the standard error of the analytical method is observed, abiotic degradation and/or adsorption on the surface of the test vessel could be involved. Distinction between these two phenomena could be achieved by thoroughly washing the walls of the vessel with a known volume of an appropriate solvent and subjecting the wash solution to analysis for the test substance. If no adsorption on the surface of the test vessels is observed, the depletion demonstrates abiotic instability of the test substance. If adsorption is found, changing the material of the test vessels is necessary. However, data on the adsorption on the surface of the test vessels gained from this experiment cannot be directly extrapolated to soil/solution experiment. The presence of soil will affect this adsorption.

Additional information on the stability of the test substance can be derived by determination of the parental mass balance over time. This means that the aqueous phase, extracts of soil and test vessel walls are analysed for the test substance. The difference between the mass of the test chemical added and the sum of the test chemical masses in the aqueous phase, extracts of the soil and test vessel walls is equal to the mass degraded and/or volatilised and/or not extracted. In order to perform a mass balance determination, the adsorption equilibrium should have been reached within the period of the experiment.

The mass balance is performed on both soils and for one soil/solution ratio per soil that gives a depletion above 20 % and preferably > 50 % at equilibrium. When the ratio-finding experiment is completed with the analysis of the last sample of the aqueous phase after 48 h, the phases are separated by centrifugation and, if so wished, filtration. The aqueous phase is recovered as much as possible, and a suitable extraction solvent (extraction coefficient of at least 95 %) is added to the soil to extract the test substance. At least two successive extractions are recommended. The amount of test substance in the soil and test vessel extracts is determined and the mass balance is calculated (equation 10, Data and Reporting). If it is less than 90 %, the test substance is considered to be unstable in the time scale of the test. However, studies could still be continued, taking into account the instability of the test substance; in this case it is recommended to analyse both phases in the main study.

▼ B1.9.3. *Tier 2 — Adsorption kinetics at one concentration of the test substance*

Five soils are used, selected from Table 1. There is an advantage to including some or all of the soils used in the preliminary study, if appropriate, among these five soils. In this case, Tier 2 has not to be repeated for the soils used in preliminary study.

The equilibration time, the soil/solution ratio, the weight of the soil sample, the volume of the aqueous phase in contact with the soil and concentration of the test substance in the solution are chosen based on the preliminary study results. Analysis should preferably be done approximately after 2, 4, 6, 8 (possibly also 10) and 24 h contact time; the agitation time may be extended to a maximum of 48 h in case a chemical requires longer equilibration time with respect to ratio-finding results. However, times of analysis could be considered with flexibility.

Each experiment (one soil and one solution) is done at least in duplicate to allow estimation of the variance of the results. In every experiment one blank is run. It consists of the soil and 0,01 M CaCl₂ solution, without test substance, and of weight and volume, respectively, identical to those of the experiment. A control sample with only the test substance in 0,01 M CaCl₂ solution (without soil) is subjected to the same test procedure, serving to safeguard against the unexpected.

The percentage adsorption is calculated at each time point A_{t_i} and/or time interval $A_{\Delta t_i}$ (according to the need) and is plotted versus time. The distribution coefficient K_d at equilibrium, as well as the organic carbon normalised adsorption coefficient K_{oc} (for non-polar organic chemicals), are also calculated.

Results of the adsorption kinetics test

The linear K_d value is generally accurate to describe sorptive behaviour in soil (35)(78) and represents an expression of inherent mobility of chemicals in soil. For example, in general chemicals with $K_d \leq 1 \text{ cm}^3 \text{ g}^{-1}$ are considered to be qualitatively mobile. Similarly, a mobility classification scheme based on K_{oc} values has been developed by MacCall *et al.* (16). Additionally, leaching classification schemes exist based on a relationship between K_{oc} and DT-50 ⁽¹⁾ (32)(79).

Also, according to error analysis studies (61), K_d values below $0,3 \text{ cm}^3 \text{ g}^{-1}$ cannot be estimated accurately from a decrease in concentration in the aqueous phase, even when the most favourable (from point of view of accuracy) soil/solution ratio is applied, i.e. 1:1. In this case analysis of both phases, soil and solution, is recommended.

⁽¹⁾ DT-50: degradation time for 50 % of the test substance.

▼ B

With respect to the above remarks, it is recommended that the study of the adsorptive behaviour of a chemical in soil and its potential mobility be continued by determining Freundlich adsorption isotherms for these systems, for which an accurate determination of K_d is possible with the experimental protocol followed in this test method. Accurate determination is possible if the value which results by multiplying the K_d with the soil/solution ratio is $> 0,3$, when measurements are based on concentration decrease in the aqueous phase (indirect method), or $> 0,1$, when both phases are analysed (direct method) (61).

1.9.4. *Tier 3 — Adsorption isotherms and desorption kinetics/desorption isotherms*

1.9.4.1. Adsorption isotherms

Five test substance concentrations are used, covering preferably two orders of magnitude; in the choice of these concentrations the water solubility and the resulting aqueous equilibrium concentrations should be taken into account. The same soil/solution ratio per soil should be kept along the study. The adsorption test is performed as described above, with the only difference that the aqueous phase is analysed only once at the time necessary to reach equilibrium as determined before in Tier 2. The equilibrium concentrations in the solution are determined and the amount adsorbed is calculated from the depletion of the test substance in the solution or with the direct method. The adsorbed mass per unit mass of soil is plotted as a function of the equilibrium concentration of the test substance (see Data and Reporting).

Results from the adsorption isotherms experiment

Among the mathematical adsorption models proposed so far, the Freundlich isotherm is the one most frequently used to describe adsorption processes. More detailed information on the interpretation and importance of adsorption models is provided in the references (41)(45)(80)(81)(82).

Note: it should be mentioned that a comparison of K_F (Freundlich adsorption coefficient) values for different substances is only possible if these K_F values are expressed in the same units (83).

1.9.4.2. Desorption kinetics

The purpose of this experiment is to investigate whether a chemical is reversibly or irreversibly adsorbed on a soil. This information is important, since the desorption process also plays an important role in the behaviour of a chemical in field soil. Moreover, desorption data are useful inputs in the computer modelling of leaching and dissolved run-off simulation. If a desorption study is desired, it is recommended that the study described below be carried out on each system for which an accurate determination of K_d in the preceding adsorption kinetics experiment was possible.

Likewise with the adsorption kinetics study, there are two options to proceed with the desorption kinetics experiment: (a) the parallel method and (b) serial method. The choice of methodology to be followed, is left to the experimenter who will need to consider the available laboratory facilities and resources.

▼ B

- (a) parallel method: for each soil which is chosen to proceed with the desorption study, samples with the same soil/solution ratio are prepared, as many as the time intervals at which it is desired to study the desorption kinetics. Preferably, the same time intervals as in the adsorption kinetics experiment should be used; however, the total time may be extended as appropriate in order the system to reach desorption equilibrium. In every experiment (one soil, one solution) one blank is run. It consists of the soil and 0,01 M CaCl₂ solution, without test substance, and of weight and volume, respectively, identical to those of the experiment. As a control sample the test substance in 0,01 M CaCl₂ solution (without soil) is subjected to the same test procedure. All the mixtures of the soil with the solution is agitating until to reach adsorption equilibrium (as determined before in Tier 2). Then, the phases are separated by centrifugation and the aqueous phases are removed as much as possible. The volume of solution removed is replaced by an equal volume of 0,01 M CaCl₂ without test substance and the new mixtures are agitated again. The aqueous phase of the first tube is recovered as completely as possible and is measured after, for example, 2 h, that of the second tube after 4 h, that of the third after 6 h, etc. until the desorption equilibrium is reached.
- (b) serial method: after the adsorption kinetics experiment, the mixture is centrifuged and the aqueous phase is removed as much as possible. The volume of solution removed is replaced by an equal volume of 0,01 M CaCl₂ without test substance. The new mixture is agitated until the desorption equilibrium is reached. During this time period, at defined time intervals, the mixture is centrifuged to separate the phases. A small aliquot of the aqueous phase is immediately analysed for the test substance; then, the experiment continues with the original mixture. The volume of each individual aliquot should be less than 1 % of the total volume. The same quantity of fresh 0,01 M CaCl₂ solution is added to the mixture to maintain the soil to solution ratio, and the agitation continues until the next time interval.

The percentage desorption is calculated at each time point (D_{t_i}) and/or time interval ($D_{\Delta t_i}$) (according to the needs of the study) and is plotted versus time. The desorption coefficient of K_{des} at equilibrium is also calculated. All applicable equations are given in Data and Reporting and Appendix 5.

Results from desorption kinetics experiment

Common plots of the percentage desorption D_{t_i} and adsorption A_{t_i} versus time, allow estimation of the reversibility of the adsorption process. If the desorption equilibrium is attained even within twice the time of the adsorption equilibrium, and the total desorption is more than 75 % of the amount adsorbed, the adsorption is considered to be reversible.

1.9.4.3. Desorption isotherms

Freundlich desorption isotherms are determined on the soils used in the adsorption isotherms experiment. The desorption test is performed as described in the section 'Desorption kinetics', with the only difference that the aqueous phase is analysed only once, at desorption equilibrium. The amount of the test substance desorbed is calculated. The content of test substance remaining adsorbed on soil at desorption equilibrium is plotted as a function of the equilibrium concentration of the test substance in solution (see Data and Reporting and Appendix 5).

▼ B**2. DATA AND REPORTING**

The analytical data are presented in tabular form (see Appendix 6). Individual measurements and averages calculated are given. Graphical representations of adsorption isotherms are provided. The calculations are made as described below.

For the purpose of the test, it is considered that the weight of 1 cm³ of aqueous solution is 1g. The soil/solution ratio may be expressed in units of w/w or w/vol with the same figure.

2.1. ADSORPTION

The adsorption A_{t_i} is defined as the percentage of substance adsorbed on the soil related to the quantity present at the beginning of the test, under the test conditions. If the test substance is stable and does not adsorb significantly to the container wall, A_{t_i} is calculated at each time point t_i , according to the equation:

$$A_{t_i} = \frac{m_s^{\text{ads}}(t_i) \cdot 100}{m_0} (\%) \quad (3)$$

where:

A_{t_i} = adsorption percentage at the time point t_i (%);

$m_s^{\text{ads}}(t_i)$ = mass of the test substance adsorbed on the soil at the time t_i (µg);

m_0 = mass of the test substance in the test tube, at the beginning of the test (µg).

Detailed information on how to calculate the percentage of adsorption A_{t_i} for the parallel and serial methods is given in Appendix 5.

The distribution coefficient K_d is the ratio between the content of the substance in the soil phase and the mass concentration of the substance in the aqueous solution, under the test conditions, when adsorption equilibrium is reached.

$$K_d = \frac{C_s^{\text{ads}}(\text{eq})}{C_{\text{aq}}^{\text{ads}}(\text{eq})} = \frac{m_s^{\text{ads}}(\text{eq})}{m_{\text{aq}}^{\text{ads}}(\text{eq})} \cdot \frac{V_0}{m_{\text{soil}}} (\text{cm}^3 \text{ g}^{-1}) \quad (4)$$

where:

$C_s^{\text{ads}}(\text{eq})$ = content of the substance adsorbed on the soil at adsorption equilibrium (µg g⁻¹);

$C_{\text{aq}}^{\text{ads}}(\text{eq})$ = mass concentration of the substance in the aqueous phase at adsorption equilibrium (µg cm⁻³). This concentration is analytically determined taking into account the values given by the blanks;

$m_s^{\text{ads}}(\text{eq})$ = mass of the substance adsorbed on the soil at adsorption equilibrium (µg);

$m_{\text{aq}}^{\text{ads}}(\text{eq})$ = mass of the substance in the solution at adsorption equilibrium (µg);

m_{soil} = quantity of the soil phase, expressed in dry mass of soil (g);

V_0 = initial volume of the aqueous phase in contact with the soil (cm³).

The relation between A_{eq} and K_d is given by:

$$K_d = \frac{A_{\text{eq}}}{100 - A_{\text{eq}}} \cdot \frac{V_0}{m_{\text{soil}}} (\text{cm}^3 \text{ g}^{-1}) \quad (5)$$

▼ B

where:

A_{eq} = percentage of adsorption at adsorption equilibrium, %.

The organic carbon normalised adsorption coefficient K_{oc} relates the distribution coefficient K_{d} to the content of organic carbon of the soil sample:

$$K_{\text{oc}} = K_{\text{d}} \cdot \frac{100}{\% \text{OC}} \quad (\text{cm}^3 \text{ g}^{-1}) \quad (6)$$

where:

$\% \text{OC}$ = percentage of organic carbon in the soil sample (g g^{-1}).

K_{oc} coefficient represents a single value which characterises the partitioning mainly of non-polar organic chemicals between organic carbon in the soil or sediment and water. The adsorption of these chemicals is correlated with the organic content of the sorbing solid (7); thus, K_{oc} values depend on the specific characteristics of the humic fractions which differ considerably in sorption capacity, due to differences in origin, genesis, etc.

2.1.1. Adsorption isotherms

The Freundlich adsorption isotherms equation relates the amount of the test substance adsorbed to the concentration of the test substance in solution at equilibrium (equation 8).

The data are treated as under 'Adsorption' and, for each test tube, the content of the test substance adsorbed on the soil after the adsorption test ($C_{\text{s}}^{\text{ads}}(\text{eq})$, elsewhere denoted as x/m) is calculated. It is assumed that equilibrium has been attained and that $C_{\text{s}}^{\text{ads}}(\text{eq})$ represents the equilibrium value:

$$C_{\text{s}}^{\text{ads}}(\text{eq}) = \frac{m_{\text{s}}^{\text{ads}}(\text{eq})}{m_{\text{soil}}} = \frac{[C_0 - C_{\text{aq}}^{\text{ads}}(\text{eq})] \cdot V_0}{m_{\text{soil}}} \quad (\mu\text{g g}^{-1}) \quad (7)$$

The Freundlich adsorption equation is shown in (8):

$$C_{\text{s}}^{\text{ads}}(\text{eq}) = K_{\text{F}}^{\text{ads}} \cdot C_{\text{aq}}^{\text{ads}}(\text{eq})^{1/n} \quad (\mu\text{g g}^{-1}) \quad (8)$$

or in the linear form:

$$\log C_{\text{s}}^{\text{ads}}(\text{eq}) = \log K_{\text{F}}^{\text{ads}} + 1/n \cdot \log C_{\text{aq}}^{\text{ads}}(\text{eq}) \quad (9)$$

where:

$K_{\text{F}}^{\text{ads}}$ = Freundlich adsorption coefficient; its dimension is $\text{cm}^3 \text{ g}^{-1}$ only if $1/n = 1$; in all other cases, the slope $1/n$ is introduced in the dimension of $K_{\text{F}}^{\text{ads}}$ ($\mu\text{g}^{1-1/n} (\text{cm}^3)^{1/n} \text{ g}^{-1}$);

n = regression constant; $1/n$ generally ranges between 0,7-1,0 indicating that sorption data is frequently slightly non-linear.

Equations (8) and (9) are plotted and the values of $K_{\text{F}}^{\text{ads}}$ and $1/n$ are calculated by regression analysis using the equation 9. The correlation coefficient r^2 of the log equation is also calculated. An example of such plots is given in Fig. 2.

▼ B

Fig. 2 Freundlich Adsorption Plot, normal and linearised

2.1.2. Mass balance

The mass balance (MB) is defined as the percentage of substance which can be analytically recovered after an adsorption test versus the nominal amount of substance at the beginning of the test.

The treatment of data will differ if the solvent is completely miscible with water. In the case of water-miscible solvent, the treatment of data described under 'Desorption' may be applied to determine the amount of substance recovered by solvent extraction. If the solvent is less miscible with water, the determination of the amount recovered has to be made.

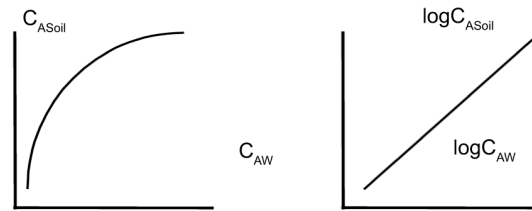
The mass balance MB for the adsorption is calculated as follows; it is assumed that the term (m_E) corresponds to the sum of the test chemical masses extracted from the soil and surface of the test vessel with an organic solvent:

$$MB = \frac{(V_{\text{rec}} \cdot C_{\text{aq}}^{\text{ads}}(\text{eq}) + m_E) \cdot 100}{V_0 \cdot C_0} (\%) \quad (10)$$

where:

MB = mass balance (%);

m_E = total mass of test substance extracted from the soil and walls of the test vessel in two steps (μg);

C_0 = initial mass concentration of the test solution in contact with the soil ($\mu\text{g cm}^{-3}$);

V_{rec} = volume of the supernatant recovered after the adsorption equilibrium (cm^3).

2.2. DESORPTION

The desorption (D) is defined as the percentage of the test substance which is desorbed, related to the quantity of substance previously adsorbed, under the test conditions:

$$D_{t_i} = \frac{m_{\text{aq}}^{\text{des}}(t_i)}{m_s^{\text{ads}}(\text{eq})} \cdot 100(\%) \quad (11)$$

where:

D_{t_i} = desorption percentage at a time point t_i (%);

▼ B

$m_{\text{aq}}^{\text{des}}(t_i)$ = mass of the test substance desorbed from soil at a time point t_i (μg);

$m_{\text{s}}^{\text{ads}}(\text{eq})$ = mass of the test substance adsorbed on soil at adsorption equilibrium (μg).

Detailed information on how to calculate the percentage of desorption D_i for the parallel and serial methods is given in Appendix 5.

The apparent desorption coefficient (K_{des}) is, under the test conditions, the ratio between the content of the substance remaining in the soil phase and the mass concentration of the desorbed substance in the aqueous solution, when desorption equilibrium is reached:

$$K_{\text{des}} = \frac{m_{\text{s}}^{\text{ads}}(\text{eq}) - m_{\text{aq}}^{\text{des}}(\text{eq}) V_{\text{T}}}{m_{\text{aq}}^{\text{des}}(\text{eq}) m_{\text{soil}}} \quad (\text{cm}^3 \text{ g}^{-1}) \quad (12)$$

where:

K_{des} = desorption coefficient ($\text{cm}^3 \text{ g}^{-1}$);

$m_{\text{aq}}^{\text{des}}(\text{eq})$ = total mass of the test substance desorbed from soil at desorption equilibrium (μg);

V_{T} = total volume of the aqueous phase in contact with the soil during the desorption kinetics test (cm^3).

Guidance for calculating the $m_{\text{aq}}^{\text{des}}(\text{eq})$ is given in Appendix 5 under the heading 'Desorption'.

Remark

If the adsorption test which was preceded, was performed with the parallel method the volume V_{T} in the equation (12) is considered to be equal to V_0 .

2.2.1. Desorption isotherms

The Freundlich desorption isotherms equation relates the content of the test substance remaining adsorbed on the soil to the concentration of the test substance in solution at desorption equilibrium (equation 16).

For each test tube, the content of the substance remaining adsorbed on soil at desorption equilibrium is calculated as follows:

$$C_{\text{s}}^{\text{des}}(\text{eq}) = \frac{m_{\text{s}}^{\text{ads}}(\text{eq}) - m_{\text{aq}}^{\text{des}}(\text{eq})}{m_{\text{soil}}} \quad (\mu\text{g g}^{-1}) \quad (13)$$

$m_{\text{aq}}^{\text{des}}(\text{eq})$ is defined as:

$$m_{\text{aq}}^{\text{des}}(\text{eq}) = m_{\text{m}}^{\text{des}}(\text{eq}) \cdot \frac{V_0}{V_{\text{T}}} - m_{\text{aq}}^{\text{A}}(\mu\text{g}) \quad (14)$$

where:

$C_{\text{s}}^{\text{des}}(\text{eq})$ = content of the test substance remaining adsorbed on the soil at desorption equilibrium ($\mu\text{g g}^{-1}$);

$m_{\text{m}}^{\text{des}}(\text{eq})$ = mass of substance determined analytically in the aqueous phase at desorption equilibrium (μg);

▼ B

m_{aq}^{A} = mass of the test substance left over from the adsorption equilibrium due to incomplete volume replacement (μg);

$m_{\text{aq}}^{\text{des}}(\text{eq})$ = mass of the substance in the solution at adsorption equilibrium (μg);

$$m_{\text{aq}}^{\text{A}} = m_{\text{aq}}^{\text{ads}}(\text{eq}) \cdot \left(\frac{V_0 - V_{\text{R}}}{V_0} \right) \quad (15)$$

V_{r}^{F} = volume of the solution taken from the tube for the measurement of the test substance, at desorption equilibrium (cm^3);

V_{R} = volume of the supernatant removed from the tube after the attainment of adsorption equilibrium and replaced by the same volume of a 0,01 M CaCl_2 solution (cm^3);

The Freundlich desorption equation is shown in (16):

$$C_{\text{s}}^{\text{des}}(\text{eq}) = K_{\text{F}}^{\text{des}} \cdot C_{\text{aq}}^{\text{des}}(\text{eq})^{1/n} \quad (\mu\text{g g}^{-1}) \quad (16)$$

or in the linear form:

$$\log C_{\text{s}}^{\text{des}}(\text{eq}) = \log K_{\text{F}}^{\text{des}} + 1/n \cdot \log C_{\text{aq}}^{\text{des}}(\text{eq}) \quad (17)$$

where:

$K_{\text{F}}^{\text{des}}$ = Freundlich desorption coefficient;

n = regression constant;

$C_{\text{aq}}^{\text{des}}(\text{eq})$ = mass concentration of the substance in the aqueous phase at desorption equilibrium ($\mu\text{g cm}^{-3}$).

The equations (16) and (17) can be plotted and the value of $K_{\text{F}}^{\text{des}}$ and $1/n$ are calculated by regression analysis using the equation 17.

Remark:

if the Freundlich adsorption or desorption exponent $1/n$ is equal to 1, the Freundlich adsorption or desorption binding constant ($K_{\text{F}}^{\text{ads}}$ and $K_{\text{F}}^{\text{des}}$) will be equal to the adsorption or desorption equilibrium constants (K_{d} and K_{des}) respectively, and plots of C_{s} vs C_{aq} will be linear. If the exponents are not equal to 1, plots of C_{s} vs C_{aq} will be non-linear and the adsorption and desorption constants will vary along the isotherms.

2.2.2. Test report

The test report should include the following information:

- complete identification of the soil samples used including,
- geographical reference of the site (latitude, longitude),
- date of sampling,

▼ B

- use pattern (e.g. agricultural soil, forest, etc.),
- depth of sampling,
- sand/silt/clay content;
- pH values (in 0,01 M CaCl₂),
- organic carbon content,
- organic matter content,
- nitrogen content,
- C/N ratio,
- cation Exchange Capacity (mmol/kg),
- all information relating to the collection and storage of soil samples,
- where appropriate, all relevant information for the interpretation of the adsorption — desorption of the test substance,
- reference of the methods used for the determination of each parameter,
- information on the test substance as appropriate,
- temperature of the experiments,
- centrifugation conditions,
- analytical procedure used to analyse the test substance,
- justification for any use of solubilising agent for the preparation of the stock solution of the test substance,
- explanations of corrections made in the calculations, if relevant,
- data according to the form sheet (Appendix 6) and graphical presentations,
- all information and observations helpful for the interpretation of the test results.

3. REFERENCES

- (1) Kukowski H. and Brümmer G., (1987) Investigations on the Adsorption and Desorption of Selected Chemicals in Soils. UBA Report 106 02 045, Part II.
- (2) Fränze O., Kuhnt G. and Vetter L., (1987) Selection of Representative Soils in the EC-Territory. UBA Report 106 02 045, Part I.
- (3) Kuhnt G. and Muntau H. (Eds.) EURO-Soils: Identification, Collection, Treatment, Characterisation. Special Publication No 1.94.60, Joint Research Centre. European Commission, ISPRA, December 1994.
- (4) OECD Test Guidelines Programme, Final Report of the OECD Workshop on Selection of Soils/Sediments, Belgirate, Italy, 18-20 January 1995 (June 1995).
- (5) US-Environment Protection Agency: Pesticide Assessment Guidelines, Subdivision N, Chemistry: Environmental Fate, Series 163-1, Leaching and Adsorption/Desorption Studies, Addendum 6 on Data Reporting, 540/09-88-096, Date: 1/1988.

▼B

- (6) US-Environment Protection Agency: Prevention, Pesticides and Toxic Substances, OPPTS Harmonized Test Guidelines, Series 835-Fate, Transport and Transformation Test Guidelines, OPPTS No: 835.1220 Sediment and Soil Adsorption/Desorption Isotherm. EPA No: 712-C-96-048, April 1996.
- (7) ASTM Standards, E 1195-85, Standard Test Method for Determining a Sorption Constant (K_{oc}) for an Organic Chemical in Soil and Sediments.
- (8) Agriculture Canada: Environmental Chemistry and Fate. Guidelines for registration of pesticides in Canada, 15 July 1987.
- (9) Netherlands Commission Registration Pesticides (1995): Application for registration of a pesticide. Section G. Behaviour of the product and its metabolites in soil, water and air.
- (10) Danish National Agency of Environmental Protection (October 1988): Criteria for registration of pesticides as especially dangerous to health or especially harmful to the environment.
- (11) BBA (1990) Guidelines for the Official Testing of Plant Protection Products, Biological Research Centre for Agriculture and Forestry, Braunschweig, Germany.
- (12) Calvet R., (1989) 'Evaluation of adsorption coefficients and the prediction of the mobilities of pesticides in soils', in Methodological Aspects of the Study of Pesticide Behaviour in Soil (ed. P. Jamet), INRA, Paris, (Review).
- (13) Calvet R., (1980) 'Adsorption-Desorption Phenomena' in Interactions between herbicides and the soil. (R.J. Hance ed.), Academic Press, London, p. 83-122.
- (14) Hasset J.J., and Banwart W.L., (1989), 'The sorption of nonpolar organics by soils and sediments' in Reactions and Movement of Organic Chemicals in Soils. Soil Science Society of America (S.S.S.A), Special Publication No 22, p. 31-44.
- (15) van Genuchten M. Th., Davidson J.M., and Wierenga P.J., (1974) 'An evaluation of kinetic and equilibrium equations for the prediction of pesticide movement through porous media'. Soil Sci. Soc. Am. Proc., Vol. 38(1), p. 29-35.
- (16) McCall P.J., Laskowski D.A., Swann R.L., and Dishburger H.J., (1981) 'Measurement of sorption coefficients of organic chemicals and their use, in environmental fate analysis', in Test Protocols for Environmental Fate and Movement of Toxicants. Proceedings of AOAC Symposium, AOAC, Washington DC.
- (17) Lambert S.M., Porter P.E., and Schieferrstein R.H., (1965) 'Movement and sorption of chemicals applied to the soil'. Weeds, 13, p. 185-190.
- (18) Rhodes R.C., Belasco I.J., and Pease H.L., (1970) 'Determination of mobility and adsorption of agrochemicals in soils'. J.Agric.Food Chem., 18, p. 524-528.
- (19) Russell M.H., (1995), 'Recommended approaches to assess pesticide mobility in soil' in Environmental Behavior of Agrochemicals (ed. T.R. Roberts and P.C. Kearney). John Wiley & Sons Ltd.
- (20) Esser H.O., Hemingway R.J., Klein W., Sharp D.B., Vonk J.W. and Holland P.T., (1988) 'Recommended approach to the evaluation of the environmental behavior of pesticides', IUPAC Reports on Pesticides (24). Pure Appl. Chem., 60, p. 901-932.

▼B

- (21) Guth J.A., Burkhard N., and D.O. Eberle, (1976) 'Experimental models for studying the persistence of pesticides in soils'. Proc. BCPC Symposium: Persistence of Insecticides and Herbicides, p. 137-157, BCPC, Surrey, UK.
- (22) Furminge C.G.L., and Osgerby J.M., (1967) 'Persistence of herbicides in soil'. J. Sci. Food Agric., 18, p. 269-273.
- (23) Burkhard N., and Guth J.A., (1981) 'Chemical hydrolysis of 2-Chloro-4,6-bis(alkylamino)-1,3,5-triazine herbicides and their breakdown in soil under the influence of adsorption'. Pestic. Sci. 12, p. 45-52.
- (24) Guth J.A., Gerber H.R., and Schlaepfer T., (1977) 'Effect of adsorption, movement and persistence on the biological availability of soil-applied pesticides'. Proc. Br. Crop Prot. Conf., 3, p. 961-971.
- (25) Osgerby J.M., (1973) 'Process affecting herbicide action in soil'. Pestic. Sci., 4, p. 247-258.
- (26) Guth J.A., (1972) 'Adsorptions- und Einwascheverhalten von Pflanzenschutzmitteln in Böden'. Schr. Reihe Ver. Wass.-Boden-Lufthyg. Berlin-Dahlem, Heft 37, p. 143-154.
- (27) Hamaker J.W., (1975) 'The interpretation of soil leaching experiments', in Environmental Dynamics of Pesticides (eds R. Haque and V.H. Freed), p. 135-172, Plenum Press, NY.
- (28) Helling C.S., (1971) 'Pesticide mobility in soils'. Soil Sci. Soc. Amer. Proc., 35, p. 732-210.
- (29) Hamaker J.W., (1972) 'Diffusion and volatilization' in Organic chemicals in the soil environment (C.A.I. Goring and J.W. Hamaker eds), Vol. I, p. 49-143.
- (30) Burkhard N. and Guth J.A., (1981) 'Rate of volatilisation of pesticides from soil surfaces; Comparison of calculated results with those determined in a laboratory model system'. Pestic. Sci. 12, p. 37-44.
- (31) Cohen S.Z., Creeger S.M., Carsel R.F., and Enfield C.G., (1984) 'Potential pesticide contamination of groundwater from agricultural uses', in Treatment and Disposal of Pesticide Wastes, p. 297-325, Acs Symp. Ser. 259, American Chemical Society, Washington, DC.
- (32) Gustafson D.I., (1989) 'Groundwater ubiquity score: a simple method for assessing pesticide leachability'. J. Environ. Toxic. Chem., 8(4), p. 339-357.
- (33) Leistra M., and Dekkers W.A., (1976) 'Computed effects of adsorption kinetics on pesticide movement in soils'. J. of Soil Sci., 28, p. 340-350.
- (34) Bromilov R.H., and Leistra M., (1980) 'Measured and simulated behavior of aldicarb and its oxydation products in fallow soils'. Pest. Sci., 11, p. 389-395.
- (35) Green R.E., and Karickhoff S.W., (1990) 'Sorption estimates for modeling', in Pesticides in the Soil Environment: Process, Impacts and Modeling (ed. H.H. Cheng). Soil Sci. Soc. Am., Book Series No 2, p. 80-101,
- (36) Lambert S.M., (1967) 'Functional relationship between sorption in soil and chemical structure'. J. Agri. Food Chem., 15, p. 572-576.

▼ B

- (37) Hance R.J., (1969) 'An empirical relationship between chemical structure and the sorption of some herbicides by soils'. *J. Agri. Food Chem.*, 17, p. 667-668.
- (38) Briggs G.G. (1969) 'Molecular structure of herbicides and their sorption by soils'. *Nature*, 223, p. 1288.
- (39) Briggs G.G. (1981) 'Theoretical and experimental relationships between soil adsorption, octanol-water partition coefficients, water solubilities, bioconcentration factors, and the parachor'. *J. Agric. Food Chem.*, 29, p. 1050-1059.
- (40) Sabljic A., (1984) 'Predictions of the nature and strength of soil sorption of organic polutance by molecular topology'. *J. Agric. Food Chem.*, 32, p. 243-246.
- (41) Bailey G.W., and White J.L., (1970) 'Factors influencing the adsorption, desorption, and movement of pesticides in soil'. *Residue Rev.*, 32, p. 29-92.
- (42) Bailey G.W., J.L. White and Y. Rothberg., (1968) 'Adsorption of organic herbicides by montomorillonite: Role of pH and chemical character of adsorbate'. *Soil Sci. Soc. Amer. Proc.* 32, p. 222-234.
- (43) Karickhoff S.W., (1981) 'Semi-empirical estimation of sorption of hydrophobic pollutants on natural sediments and soils'. *Chemosphere* 10, p. 833-846.
- (44) Paya-Perez A., Riaz M. and Larsen B., (1989) 'Soil Sorption of 6 Chlorobenzenes and 20 PCB Congeners'. *Environ. Toxicol. Safety* 21, p. 1-17.
- (45) Hamaker J.W., and Thompson J.M., (1972) 'Adsorption in organic chemicals' in *Organic Chemicals in the Soil Environment* (Goring C.A.I. and Hamaker J.W., eds), Vol I and II, Marcel Dekker, Inc., New York, NY, 1972, p. 49-143.
- (46) Deli J., and Warren G.F., 1971 'Adsorption, desorption and leaching of diphenamid in soils'. *Weed Sci.* 19, p. 67-69.
- (47) Chu-Huang Wu, Buehring N., Davinson J.M. and Santelmann, (1975) 'Napropamide Adsorption, desorption and Movement in soils'. *Weed Science*, Vol. 23, p. 454-457.
- (48) Haues M.H.B., Stacey M., and Thompson J.M., (1968) 'Adsorption of s-triazine herbicides by soil organic preparations' in *Isotopes and Radiation in Soil Organic Studies*, p. 75, International Atomic Energy Agency, Vienna.
- (49) Pionke H.B., and Deangelis R.J., (1980) 'Methods for distributing pesticide loss in field run-off between the solution and adsorbed phase', CREAMS, in *A Field Scale Model for Chemicals, Run-off and Erosion from Agricultural Management Systems*, Chapter 19, Vol. III: Supporting Documentation, USDA Conservation Research report.
- (50) ISO Standard Compendium Environment: Soil Quality — General aspects; chemical and physical methods of analysis; biological methods of analysis. First Edition (1994).
- (51) Scheffer F., and Schachtschabel, *Lehrbuch der Bodenkunde*, F. Enke Verlag, Stuttgart (1982) 11th edition.
- (52) Black, Evans D.D., White J.L., Ensminger L.E., and Clark F.E., eds. 'Methods of Soil Analysis', Vol 1 and 2, American Society of Agronomy, Madison, WI, 1982.

▼ B

- (53) ISO/DIS 10381-1 Soil Quality — Sampling — Part 1: Guidance on the design of sampling programmes.
- (54) ISO/DIS 10381-2 Soil Quality — Sampling — Part 2: Guidance on sampling techniques.
- (55) ISO/DIS 10381-3 Soil Quality — Sampling — Part 3: Guidance on safety of sampling.
- (56) ISO/DIS 10381-4 Soil Quality — Sampling — Part 4: Guidance on the investigation of natural and cultivated soils.
- (57) ISO/DIS 10381-5 Soil Quality — Sampling — Part 5: Guidance on the investigation of soil contamination of urban and industrial sites.
- (58) ISO 10381-6, 1993: Soil Quality — Sampling — Part 6: Guidance on the collection, handling and storage of soil for the assessment of aerobic microbial processes in the laboratory.
- (59) Green R.E., and Yamane V.K., (1970) 'Precision in pesticide adsorption measurements'. *Soil Sci. Am. Proc.*, 34, 353-354.
- (60) Grover R., and Hance R.J. (1970) 'Effect of ratio of soil to water on adsorption of linuron and atrazine'. *Soil Sci.*, p. 109-138.
- (61) Boesten, J.J.T.I., 'Influence of soil/liquid ratio on the experimental error of sorption coefficients in pesticide/soil system'. *Pest. Sci.* 1990, 30, p. 31-41.
- (62) Boesten, J.J.T.I. 'Influence of soil/liquid ratio on the experimental error of sorption coefficients in relation to OECD guideline 106' Proceedings of 5th international workshop on environmental behaviour of pesticides and regulatory aspects, Brussels, 26-29 April 1994.
- (63) Bastide J., Cantier J.M., et Coste C., (1980) 'Comportement de substances herbicides dans le sol en fonction de leur structure chimique'. *Weed Res.* 21, p. 227-231.
- (64) Brown D.S., and Flagg E.W., (1981) 'Empirical prediction of organic pollutants sorption in natural sediments'. *J. Environ.Qual.*, 10(3), p. 382-386.
- (65) Chiou C.T., Porter P.E., and Schmedding D.W., (1983) 'Partition equilibria of non-ionic organic compounds between soil organic matter and water'. *Environ. Sci. Technol.*, 17(4), p. 227-231.
- (66) Gerstl Z., and Mingelgrin U., (1984) 'Sorption of organic substances by soils and sediments'. *J. Environm. Sci. Health*, B19 (3), p. 297-312.
- (67) Vowles P.D., and Mantoura R.F.C., (1987), 'Sediment-water partition coefficient and HPLC retention factors of aromatic hydrocarbons'. *Chemosphere*, 16(1), p. 109-116.
- (68) Lyman W.J., Reehl W.F. and Rosenblatt D.H. (1990) *Handbook of Chemical Property Estimation Methods. Environmental Behaviour of Organic Compounds.* American Chemical Society, Washington DC.
- (69) Keniga E.E., and Goring, C.A.I. (1980) 'Relationship between water solubility, soil sorption, octanol-water partitioning and concentration of chemicals in the biota' in *Aquatic Toxicology* (eds J.G. Eaton, et al.), p. 78-115, ASTM STP 707, Philadelphia.

▼B

- (70) Chiou C.T., Peters L.J., and Freed V.H., (1979) 'A physical concept of soil-water equilibria for non-ionic organic compounds'. *Science*, Vol. 206, p. 831-832.
- (71) Hassett J.J., Banwart W.I., Wood S.G., and Means J.C., (1981) 'Sorption of *p*-Naphthol: implications concerning the limits of hydrophobic sorption'. *Soil Sci. Soc. Am. J.* 45, p. 38-42.
- (72) Karickhoff S.W., (1981), 'Semi-empirical estimation of sorption of hydrophobic pollutants on natural sediments and soils'. *Chemosphere*, Vol. 10(8), p. 833-846.
- (73) Moreale A., van Bladel R., (1981) 'Adsorption de 13 herbicides et insecticides par le sol. Relation solubilité — réactivité'. *Revue de l'Agric.*, 34 (4), p. 319-322.
- (74) Müller M., Kördel W. (1996) 'Comparison of screening methods for the determination/estimation of adsorption coefficients on soil'. *Chemosphere*, 32(12), p. 2493-2504.
- (75) Kördel W., Kotthoff G., Müller M. (1995) 'HPLC — screening method for the determination of the adsorption coefficient on soil — results of a ring test'. *Chemosphere* 30 (7), p. 1373-1384.
- (76) Kördel W., Stutte J., Kotthoff G. (1993), 'HPLC — screening method for the determination of the adsorption coefficient on soil — comparison of different stationary phases. *Chemosphere* 27 (12), p. 2341-2352.
- (77) Hance, R.J., (1967), 'The speed of Attainment of Sorption Equilibria in Some Systems Involving Herbicides'. *Weed Research*, Vol. 7, p. 29-36.
- (78) Koskinen W.C., and Harper S.S., (1990), 'The retention processes: mechanisms' in *Pesticides in the Soil Environment: Processes, Impacts and Modelling* (ed. H.H. Cheng). *Soil Sci. Soc. Am. Book Series*, No 2, Madison, Wisconsin.
- (79) Cohen S.Z., Creeger S.M., Carsel R.F., and Enfield C.G. (1984), 'Potential pesticide contamination of groundwater from agricultural uses', in *Treatment and Disposal of Pesticide Wastes*, p. 297-325, ACS Symp. Ser. 259, American Chemical Society, Washington, DC.
- (80) Giles C.H., (1970) 'Interpretation and use of sorption isotherms' in *Sorption and Transport Processes in Soils*. S.C.I. Monograph No. 37, p. 14-32.
- (81) Giles, C.H.; McEwan J.H.; Nakhwa, S.N. and Smith, D., (1960) 'Studies in adsorption: XI. A system of classification of solution adsorption isotherms and its use in the diagnosis of adsorption mechanisms and in measurements of pesticides surface areas of soils'. *J. Chem. Soc.*, p. 3973-93.
- (82) Calvet R., Tercé M., and Arvien J.C., (1980) 'Adsorption des pesticides par les sols et leurs constituants: 3. Caractéristiques générales de l'adsorption'. *Ann. Agron.* 31, p. 239-251.
- (83) Bedbur E., (1996) 'Anomalies in the Freundlich equation', *Proc. COST 66 Workshop, Pesticides in soil and the environment*, 13-15 May 1996, Stratford-upon-Avon, U.K.
- (84) Guth, J.A., (1985) 'Adsorption/desorption', in *Joint International Symposium, Physicochemical Properties and their Role in Environmental Hazard Assessment*, July 1-3, Canterbury, UK.
- (85) Soil Texture Classification (US and FAO systems): *Weed Science*, 33, Suppl. 1 (1985) and *Soil Sci. Soc. Amer. Proc.* 26, p. 305 (1962).

▼B

Appendix 1

Testing scheme

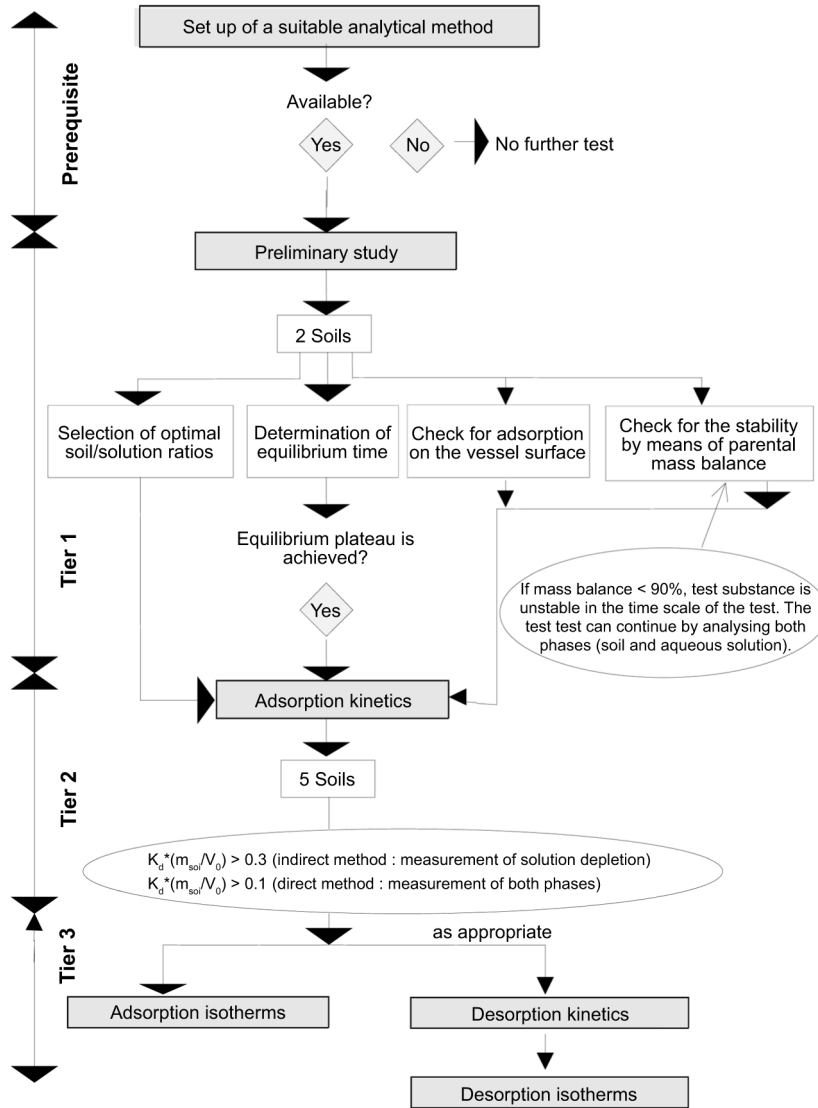

▼ B

Appendix 2

**INFLUENCE OF ACCURACY OF ANALYTICAL METHOD AND
CONCENTRATION CHANGE ON ACCURACY OF ADSORPTION
RESULTS**

From the following table (84) it becomes obvious that when the difference between the initial mass ($m_0 = 110 \mu\text{g}$) and equilibrium mass ($m_{\text{aq}}^{\text{ads}}(\text{eq}) = 100 \mu\text{g}$) of the test substance in the solution is very small, an error of 5 % in the measurement of equilibrium concentration results in an error of 50 % in the calculation of the mass of the substance adsorbed in soil ($m_{\text{s}}^{\text{ads}}(\text{eq})$) and of 52,4 % in the calculation of the K_{d} .

Amount of soil $m_{\text{soil}} = 10 \text{ g}$
Volume of solution $V_0 = 100 \text{ cm}^3$

	$m_{\text{aq}}^{\text{ads}}(\text{eq})$ (μg)	$C_{\text{aq}}^{\text{ads}}(\text{eq})$ ($\mu\text{g cm}^{-3}$)	R	$m_{\text{s}}^{\text{ads}}(\text{eq})^*$ (μg)	$C_{\text{s}}^{\text{ads}}(\text{eq})^*$ ($\mu\text{g g}^{-1}$)	R_{\ddagger}	K_{d}^*	R_{\ddagger}
FOR A = 9 %								
$m_0 = 110 \mu\text{g}$ or $C_0 = 1,100 \mu\text{g/cm}^3$	100	1,000	true value	10	1,00	true value	1	
	101	1,010	1 %	9	0,90	10 %	0,891	10,9 %
	105	1,050	5 %	5	0,50	50 %	0,476	52,4 %
	109	1,090	9 %	1	0,10	90 %	0,092	90,8 %
FOR A = 55 %								
$m_0 = 110 \mu\text{g}$ or $C_0 = 1,100 \mu\text{g/cm}^3$	50,0	0,500	true value	60,0	6,00	true value	12,00	
	50,5	0,505	1 %	59,5	5,95	0,8 %	11,78	1,8 %
	52,5	0,525	5 %	57,5	5,75	4,0 %	10,95	8,8 %
	55,0	0,550	10 %	55,0	5,50	8,3 %	10,00	16,7 %
FOR A = 99 %								
$m_0 = 110 \mu\text{g}$ or $C_0 = 1,100 \mu\text{g/cm}^3$	1,100	0,011	true value	108,9	10,89	true value	990	
	1,111	0,01111	1 %	108,889	10,8889	0,01 %	980	1,0 %
	1,155	0,01155	5 %	108,845	10,8845	0,05 %	942	4,8 %
	1,21	0,0121	10 %	108,790	10,8790	0,10 %	899	9,2 %

$$*m_{\text{s}}^{\text{ads}}(\text{eq}) = m_0 - m_{\text{aq}}^{\text{ads}}(\text{eq}), C_{\text{s}}^{\text{ads}}(\text{eq}) = \frac{[C_0 - C_{\text{aq}}^{\text{ads}}(\text{eq})] V_0}{m_{\text{soil}}}. K_{\text{d}} = \frac{m_{\text{s}}^{\text{ads}}(\text{eq}) V_0}{m_{\text{aq}}^{\text{ads}}(\text{eq}) m_{\text{soil}}}$$

$m_{\text{s}}^{\text{ads}}(\text{eq})$ = mass of the test substance in the soil phase at equilibrium, μg ;

$m_{\text{aq}}^{\text{ads}}(\text{eq})$ = mass of the test substance in the aqueous phase at equilibrium, μg ;

$C_{\text{s}}^{\text{ads}}(\text{eq})$ = content of the test substance in the soil phase at equilibrium, $\mu\text{g g}^{-1}$;

$C_{\text{aq}}^{\text{ads}}(\text{eq})$ = mass concentration of the test substance in the aqueous phase at equilibrium, $\mu\text{g cm}^{-3}$;

R = analytical error in the determination of the $m_{\text{aq}}^{\text{ads}}(\text{eq})$;

R_{\ddagger} = calculated error due to the analytical error R.

▼B

Appendix 3

ESTIMATION TECHNIQUES FOR K_d

1. Estimation techniques permit prediction of K_d based on correlations with, for example, P_{ow} values (12)(39)(63-68), water solubility data (12)(19)(21)(39)(68-73), or polarity data derived by application of HPLC on reversed phase (74-76). As shown in Tables 1 and 2, is the K_{oc} or K_{om} that are calculated from these equations and then, indirectly, the K_d from the equations:

$$K_{oc} = K_d \cdot \frac{100}{\%OC} \text{ (cm}^3 \text{ g}^{-1}\text{)} \quad K_{om} = \frac{K_d}{1,724} \cdot \frac{100}{\%OC} \text{ (cm}^3 \text{ g}^{-1}\text{)}$$

2. The concept of these correlations is based on two assumptions: (1) it is the organic matter of the soil that mainly influences the adsorption of a substance; and (2) the interactions involved are mainly non-polar. As a result, these correlations: (1) are not, or are only to some extent, applicable to polar substances, and (2) are not applicable in cases where the organic matter content of the soil is very small (12). In addition, although satisfactory correlations have been found between P_{ow} and adsorption (19), the same cannot be said for the relationship between water solubility and extent of adsorption (19)(21); so far the studies are very contradictory.
3. Some examples of correlations between the adsorption coefficient and the octanol-water partition coefficient, as well as water solubility are given in Tables 1 and 2, respectively.

Table 1

Examples of correlations between the adsorption distribution coefficient and the octanol-water partition coefficient; for further examples (12) (68).

Substances	Correlations	Authors
Substituted ureas	$\log K_{om} = 0,69 + 0,52 \log P_{ow}$	Briggs (1981) (39)
Aromatic chlorinated	$\log K_{oc} = - 0,779 + 0,904 \log P_{ow}$	Chiou <i>et al.</i> (1983) (65)
Various pesticides	$\log K_{om} = 4,4 + 0,72 \log P_{ow}$	Gerstl and Mingelgrin (1984) (66)
Aromatic hydrocarbons	$\log K_{oc} = - 2,53 + 1,15 \log P_{ow}$	Vowles and Mantoura (1987) (67)

Table 2

Examples of correlations between the adsorption distribution coefficient and water solubility; for further examples see (68) (69).

Compounds	Correlations	Authors
Various pesticides	$\log K_{om} = 3,8 - 0,561 \log S_w$	Gerstl and Mingelgrin (1984) (66)
Aliphatic, aromatic chlorinated substances	$\log K_{om} = (4,040 \pm 0,038) - (0,557 \pm 0,012) \log S_w$	Chiou <i>et al.</i> (1979) (70)
α -naphthol	$\log K_{oc} = 4,273 - 0,686 \log S_w$	Hasset <i>et al.</i> (1981) (71)
Cyclic, aliphatic aromatic substances	$\log K_{oc} = - 1,405 - 0,921 \log S_w - 0,00953 \text{ (mp-25)}$	Karickhoff (1981) (72)
Various compounds	$\log K_{om} = 2,75 - 0,45 \log S_w$	Moreale van Blade (1982) (73)

▼ B*Appendix 4***CALCULATIONS FOR DEFINING THE CENTRIFUGATION CONDITIONS**

1. The centrifugation time is given by the following formula, assuming spherical particles:

$$t = \frac{9}{2} \left[\frac{\eta}{\omega^2 r_p^2 (\rho_s - \rho_{aq})} \right] \ln (R_b/R_t) \quad (1)$$

For simplification purposes, all parameters are described in non-SI units (g, cm).

where:

ω = rotational speed (=2 π rpm/60), rad s⁻¹

rpm = revolutions per minute

η = viscosity of solution, g s⁻¹ cm⁻¹

r_p = particle radius, cm

ρ_s = soil density, g cm⁻³

ρ_{aq} = solution density, g cm⁻³

R_t = distance from the centre of centrifuge rotor to top of solution in centrifuge tube, cm

R_b = distance from the centre of centrifuge rotor to bottom in centrifuge tube, cm

R_b-R_t = length of the soil/solution mixture in the centrifuge tube, cm.

In general practice, double the calculated times is used to ensure complete separation.

2. The equation (1) can be simplified further if we consider the viscosity (η) and the density (ρ_{aq}) of the solution as equal to the viscosity and density of water at 25 °C; thus, $\eta = 8,95 \times 10^{-3}$ g s⁻¹ cm⁻¹ and $\rho_{aq} = 1,0$ g. cm⁻³.

Then, the centrifugation time is given by the equation (2):

$$t = \frac{3.7}{(\text{rpm})^2 \cdot r_p^2 (\rho_s - 1)} \ln \frac{R_b}{R_t} \quad (2)$$

3. From the equation (2) it becomes apparent that two parameters are important in defining the centrifugation condition, i.e. time (t) and speed (rpm), in order to achieve separation of particles with a specific size (in our case 0,1 μm radius): (1) the density of the soil and (2) the length of the mixture in the centrifuge tube (R_b-R_t), i.e. the distance which a soil particle covers from the top of the solution to the bottom of the tube; obviously, for a fixed volume the length of the mixture in the tube will depend on the square of the radius of the tube.
4. Fig. 1 presents variations in the centrifugation time (t) versus centrifugation speed (rpm) for different soil densities (ρ_s) (Fig. 1a) and different lengths of the mixture in the centrifuge tubes (Fig. 2a). From Fig. 1a the influence of the soil density appears obvious; for example, for a classical centrifugation of 3 000 rpm the centrifugation time is approximately 240 min for 1,2 g cm³ soil density, while it is only 50 min for 2,0 g cm³. Similarly, from Fig 1b, for a classical centrifugation of 3 000 rpm the centrifugation time is approximately 50 min for a length of the mixture of 10 cm and only seven min for a length of 1 cm. However, it is important to find an optimal relation between centrifugation which requires the less length possible and easy handling for the experimenter in separating the phases after centrifugation.

▼ B

5. Moreover, when defining the experimental conditions for the separation of soil/solution phases, it is important to consider the possible existence of a third 'pseudo-phase', the colloids. These particles, with a size less than $0,2 \mu\text{m}$, can have an important impact on the whole adsorption mechanism of a substance in a soil suspension. When centrifugation is performed as described above, colloids remain in the aqueous phase and are subjected to analysis together with the aqueous phase. Thus, the information about their impact is lost.

If the conducting laboratory has ultracentrifugation or ultrafiltration facilities, the adsorption/desorption of a substance in soil could be studied more in depth, including information on the adsorption of the substance on the colloids. In this case, an ultracentrifugation at 60 000 rpm/min or an ultrafiltration with filter porosity of 100 000 Daltons should be applied in order to separate the three phases soil, colloids, solution. The test protocol should also be modified accordingly, in order all three phases to be subjected to substance analysis.

Fig. 1a.

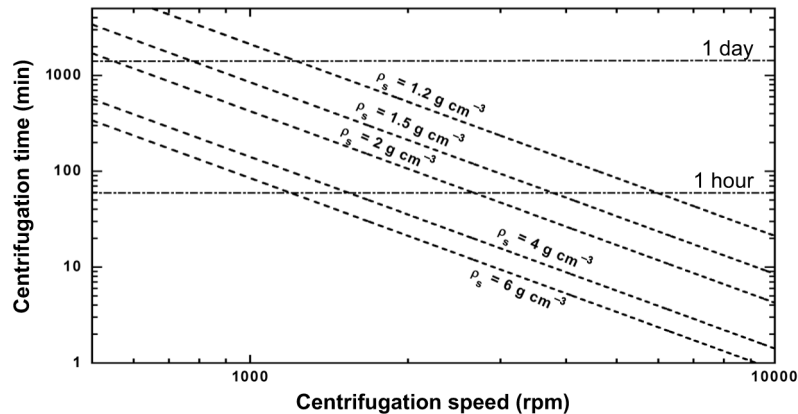

Variations of centrifugation time (t) versus centrifugation speed (rpm) for different soil densities (ρ_s). $R_t = 10 \text{ cm}$, $R_b - R_t = 10 \text{ cm}$, $\eta = 8,95 \times 10^{-3} \text{ g s}^{-1} \text{ cm}^{-1}$ and $\rho_{\text{aq}} = 1,0 \text{ g. cm}^{-3}$ at $25 \text{ }^\circ\text{C}$.

Fig. 1b.

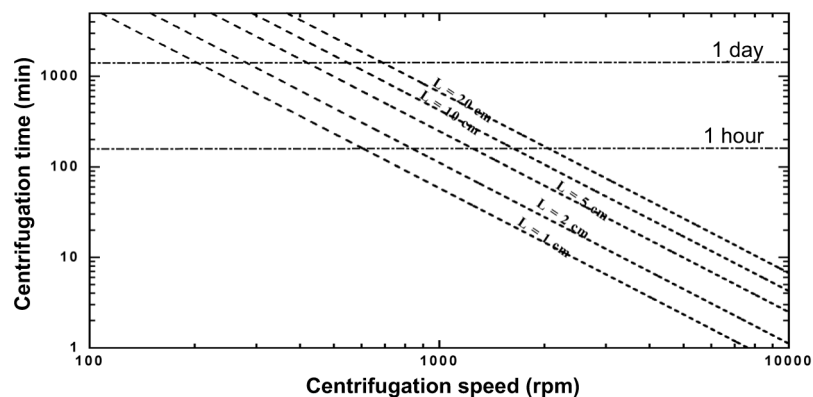

Variations of centrifugation time (t) versus centrifugation speed (rpm) for different lengths of the mixture in the centrifuge tube ($R_b - R_t$) = L ; $R_t = 10 \text{ cm}$, $\eta = 8,95 \times 10^{-3} \text{ g s}^{-1} \text{ cm}^{-1}$, $\rho_{\text{aq}} = 1,0 \text{ g. cm}^{-3}$ at $25 \text{ }^\circ\text{C}$ and $\rho_s = 2,0 \text{ g cm}^{-3}$.

▼ B*Appendix 5***CALCULATION OF ADSORPTION A (%) AND DESORPTION D (%)**

The time scheme of the procedure is:

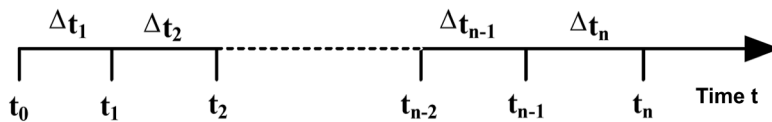

For all the calculations it is assumed that the test substance is stable and does not adsorb significantly to the container walls.

ADSORPTION A (A%)a) *Parallel method*

The percentage adsorption is calculated for each test tube (i) at each time point (t_i), according to the equation:

$$A_{t_i} = \frac{m_s^{\text{ads}}(t_i) \cdot 100}{m_0} (\%) \quad (1)$$

The terms of this equation may be calculated as follows:

$$m_0 = C_0 \cdot V_0 (\mu\text{g}) \quad (2)$$

$$m_s^{\text{ads}}(t_i) = m_0 - C_{\text{aq}}^{\text{ads}}(t_i) \cdot V_0 (\mu\text{g}) \quad (3)$$

where:

A_{t_i} = adsorption percentage (%) at the time point t_i

$m_s^{\text{ads}}(t_i)$ = mass of the test substance on soil at the time t_i that the analysis is performed (μg)

m_0 = mass of test substance in the test tube, at the beginning of the test (μg)

C_0 = initial mass concentration of the test solution in contact with the soil ($\mu\text{g cm}^{-3}$)

▼ B

$C_{aq}^{ads}(t_i)$ = mass concentration of the substance in the aqueous phase at the time t_i that the analysis is performed ($\mu\text{g cm}^{-3}$); this concentration is analytically determined taking into account the values given by the blanks

V_0 = initial volume of the test solution in contact with the soil (cm^3).

The values of the adsorption percentage A_{t_i} or $C_{aq}^{ads}(t_i)$ are plotted versus time and the time after which the sorption equilibrium is attained is determined. Examples of such plots are given in Fig. 1 and Fig. 2 respectively.

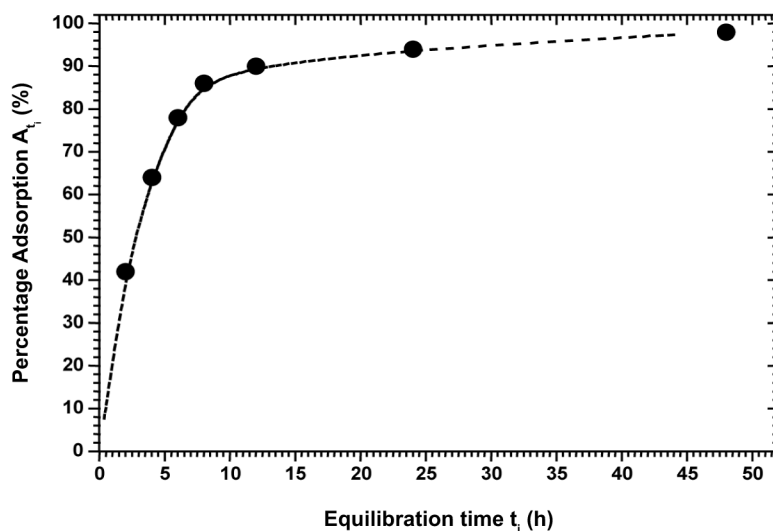

Fig. 1.
Adsorption equilibrium plot

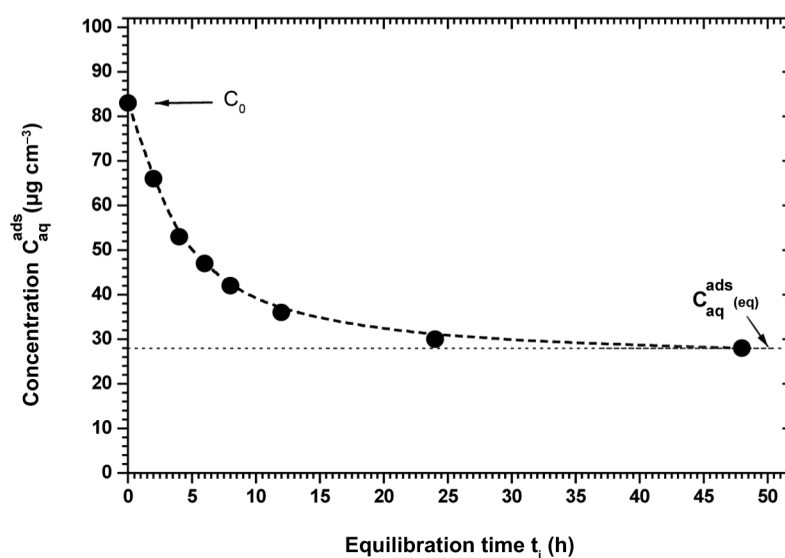

Fig. 2.
Mass concentration of the test substance in the aqueous phase (C_{aq}) versus time

▼ Bb) *Serial method*

The following equations take into account that the adsorption procedure is carried out by measurements of the test substance in small aliquots of the aqueous phase at specific time intervals.

During each time interval the amount of the substance adsorbed on the soil is calculated as follows:

— for the first time interval $\Delta t_1 = t_1 - t_0$

$$m_s^{\text{ads}}(\Delta t_1) = m_0 - m_m^{\text{ads}}(t_1) \cdot \left(\frac{V_0}{V_a^A}\right) \quad (4)$$

— for the second time interval $\Delta t_2 = t_2 - t_1$

$$m_s^{\text{ads}}(\Delta t_2) = m_m^{\text{ads}}(t_1) \cdot \left(\frac{V_0}{V_a^A}\right) - m_m^{\text{ads}}(t_2) \cdot \left(\frac{V_0 - V_a^A}{V_a^A}\right) \quad (5)$$

— for the third time interval $\Delta t_3 = t_3 - t_2$

$$m_s^{\text{ads}}(\Delta t_3) = m_m^{\text{ads}}(t_2) \cdot \left(\frac{V_0 - V_a^A}{V_a^A}\right) - m_m^{\text{ads}}(t_3) \cdot \left(\frac{V_0 - 2 \cdot V_a^A}{V_a^A}\right) \quad (6)$$

— for the nth time interval $\Delta t_n = t_n - t_{n-1}$

$$m_s^{\text{ads}}(\Delta t_n) = m_m^{\text{ads}}(t_{n-1}) \cdot \left(\frac{V_0 - (n-2) \cdot V_a^A}{V_a^A}\right) - m_m^{\text{ads}}(t_n) \cdot \left(\frac{V_0 - (n-1) \cdot V_a^A}{V_a^A}\right) \quad (7)$$

The percentage of adsorption at each time interval, $A_{\Delta t_i}$, is calculated using the following equation:

$$A_{\Delta t_i} = \frac{m_s^{\text{ads}}(\Delta t_i)}{m_0} \cdot 100 \text{ (\%)} \quad (8)$$

while the percentage of adsorption (A_{t_i}) at a time point t_i is given by the equation:

$$A_{t_i} = \frac{\sum_{j=\Delta t_1}^{\Delta t_i} m_s^{\text{ads}}(j)}{m_0} \cdot 100 \text{ (\%)} \quad (9)$$

The values of the adsorption A_{t_i} or $A_{\Delta t_i}$ (with respect to the needs of the study) are plotted versus time and the time after which the sorption equilibrium is attained is determined.

At the equilibration time t_{eq} :

— the mass of the test substance adsorbed on the soil is:

$$m_s^{\text{ads}}(\text{eq}) = \sum_{\Delta t_i=1}^n m_s^{\text{ads}}(\Delta t_i) \quad (10)$$

▼ B

— the mass of the test substance in the solution is:

$$m_{\text{aq}}^{\text{ads}}(\text{eq}) = m_0 - \sum_{\Delta t_i=1}^n m_s^{\text{ads}}(\Delta t_i) \quad (11)$$

— and the percentage of adsorption at equilibrium is:

$$A_{\text{eq}} = \frac{m_s^{\text{ads}}(\text{eq})}{m_0} \cdot 100 \text{ (\%)} \quad (12)$$

The parameters used above are defined as:

$m_s^{\text{ads}}(\Delta t_1), m_s^{\text{ads}}(\Delta t_2), \dots, m_s^{\text{ads}}(\Delta t_n)$ = mass of the substance adsorbed on the soil during the time intervals $\Delta t_1, \Delta t_2, \dots, \Delta t_n$ respectively (μg);

$m_m^{\text{ads}}(t_1), m_m^{\text{ads}}(t_2), \dots, m_m^{\text{ads}}(t_n)$ = mass of the substance measured in an aliquot v_a^A at the time points t_1, t_2, t_n respectively (μg);

$m_s^{\text{ads}}(\text{eq})$ = mass of the substance adsorbed on the soil at adsorption equilibrium (μg);

$m_{\text{aq}}^{\text{ads}}(\text{eq})$ = mass of the substance in the solution at adsorption equilibrium (μg);

v_a^A = volume of the aliquot in which the test substance is measured (cm^3);

$A_{\Delta t_i}$ = percentage of adsorption corresponding at a time interval Δt_i (%);

A_{eq} = percentage of adsorption at adsorption equilibrium (%).

DESORPTION D (A %)

The time t_0 that the desorption kinetics experiment begins, is considered as the moment that the maximal recovered volume of the test substance solution (after that the adsorption equilibrium is attained) is replaced by an equal volume of 0,01 M CaCl_2 solution.

(a) Parallel method

At a time point t_i , the mass of the test substance is measured in the aqueous phase taken from the tube i (V_i^i), and the mass desorbed is calculated according to the equation:

$$m_{\text{aq}}^{\text{des}}(t_i) = m_m^{\text{des}}(t_i) \cdot \left(\frac{V_0}{V_i^i} \right) - m_{\text{aq}}^A \quad (13)$$

At desorption equilibrium $t_i = t_{\text{eq}}$ and therefore $m_{\text{aq}}^{\text{des}}(t_i) = m_{\text{aq}}^{\text{des}}(\text{eq})$

The mass of the test substance desorbed during a time interval (Δt_i) is given by the equation:

$$m_{\text{aq}}^{\text{des}}(\Delta t_i) = m_{\text{aq}}^{\text{des}}(t_i) - \sum_{j=1}^{i-1} m_{\text{aq}}^{\text{des}}(j) \quad (14)$$

The percentage of desorption is calculated:

at a time point t_i from the equation:

▼ B

$$D_{t_i} = \frac{m_{aq}^{des}(t_i)}{m_s^{ads}(eq)} \cdot 100 (\%) \quad (15)$$

and during a time interval (Δt_i) from the equation:

$$D_{\Delta t_i} = \frac{m_{aq}^{des}(\Delta t_i)}{m_s^{ads}(eq)} \cdot 100 (\%) \quad (16)$$

where:

D_{t_i} = desorption percentage at a time point t_i (%)

$D_{\Delta t_i}$ = desorption percentage corresponding to a time interval Δt_i (%)

$m_{aq}^{des}(t_i)$ = mass of the test substance desorbed at a time point t_i , (μg)

$m_{aq}^{des}(\Delta t_i)$ = mass of the test substance desorbed during a time interval Δt_i (μg)

$m_m^{des}(t_i)$ = mass of the test substance analytically measured at a time t_i in a solution volume V_r^i , which is taken for the analysis (μg)

m_{aq}^A = mass of the test substance left over from the adsorption equilibrium due to incomplete volume replacement (μg)

$$m_{aq}^A = m_{aq}^{ads}(eq) \cdot \left(\frac{V_0 - V_R}{V_0} \right) \quad (17)$$

$m_{aq}^{ads}(eq)$ = mass of the test substance in the solution at adsorption equilibrium (μg)

V_R = volume of the supernatant removed from the tube after the attainment of adsorption equilibrium and replaced by the same volume of a 0,01 M CaCl_2 solution (cm^3)

V_r^i = volume of the solution taken from the tube (i) for the measurement of the test substance, in desorption kinetics experiment (cm^3).

The values of desorption D_{t_i} or $D_{\Delta t_i}$ (according to the needs of the study) are plotted versus time and the time after which the desorption equilibrium is attained is determined.

(b) *Serial method*

The following equations take into account that the adsorption procedure, which was preceded, was carried out by measurement of test substance in small aliquots (v_a^A) of the aqueous phase (serial method in 'Performance of the test' 1.9). It is assumed that: (a) the volume of the supernatant removed from the tube after the adsorption kinetics experiment was replaced by the same volume of 0,01 M CaCl_2 solution (V_R) and (b) and the total volume of the aqueous phase in contact with the soil (V_T) during the desorption kinetics experiment remains constant and is given by the equation:

$$V_T = V_0 - \sum_{i=1}^n v_a^A(i) \quad (18)$$

▼ B

At a time point t_i :

- The mass of the test substance is measured in a small aliquot (v_a^D) and the mass desorbed is calculated, according to the equation:

$$m_{aq}^{des}(t_i) = m_m^{des}(t_i) \cdot \left(\frac{V_T}{v_a^D} \right) - m_{aq}^A \cdot \left(\frac{(V_T - (i-1) \cdot v_a^D)}{V_T} \right) \quad (19)$$

- At desorption equilibrium $t_i = t_{eq}$ and therefore $m_{aq}^{des}(t_i) = m_{aq}^{des}(eq)$.
- The percentage of desorption D_i is calculated, from the following equation:

$$D_i = \frac{m_{aq}^{des}(t_i)}{m_s^{ads}(eq)} \cdot 100 (\%) \quad (20)$$

At a time interval (Δt_i):

During each time interval the amount of the substance desorbed is calculated as follows:

- for the first time interval $\Delta t_1 = t_1 - t_0$

$$m_{aq}^{des}(\Delta t_1) = m_m^{des}(t_1) \cdot \left(\frac{V_T}{v_a^D} \right) - m_{aq}^A \quad \text{and} \quad m_s^{des}(t_1) = m_s^{aq}(eq) - m_{aq}^{des}(\Delta t_1) \quad (21)$$

- for the second time interval $\Delta t_2 = t_2 - t_1$

$$m_{aq}^{des}(\Delta t_2) = m_m^{des}(t_2) \cdot \left(\frac{V_T}{v_a^D} \right) - m_{aq}^{des}(\Delta t_1) \cdot \left(\frac{(V_T - v_a^D)}{V_T} \right) - m_{aq}^A \cdot \left(\frac{(V_T - v_a^D)}{V_T} \right) \quad (22)$$

and

$$m_s^{des}(t_2) = m_s^{ads}(eq) - [m_{aq}^{des}(\Delta t_1) + m_{aq}^{des}(\Delta t_2)]$$

- for the n^{th} interval $\Delta t_n = t_n - t_{n-1}$

$$m_{aq}^{des}(\Delta t_n) = \left[m_m^{des}(t_n) \cdot \left(\frac{V_T}{v_a^D} \right) - m_{aq}^A \cdot \left(\frac{(V_T - (n-1) \cdot v_a^D)}{V_T} \right) - \sum_{i=1, n \neq 1}^{n-1} \left(\frac{(V_T - (n-i) \cdot v_a^D)}{V_T} \cdot m_{aq}^{des}(\Delta t_i) \right) \right] \quad (23)$$

and

$$m_s^{des}(t_n) = m_s^{ads}(eq) - \sum_{i=1, n \neq 1}^n m_{aq}^{des}(\Delta t_i)$$

Finally, the percentage of desorption at each time interval, $D_{\Delta t_i}$, is calculated using the following equation:

$$D_{\Delta t_i} = \frac{m_{aq}^{des}(\Delta t_i)}{m_s^{ads}(eq)} \cdot 100 (\%) \quad (24)$$

while the percentage of desorption D_i at a time point t_i is given by the equation:

$$D_i = \frac{\sum_{j=\Delta t_1}^{\Delta t_i} m_{aq}^{des}(j)}{m_s^{ads}(eq)} \cdot 100 = \frac{m_{aq}^{des}(t_i)}{m_s^{ads}(eq)} \cdot 100 (\%) \quad (25)$$

▼ B

where the above used parameters are defined as:

$m_s^{\text{des}}(\Delta t_1), m_s^{\text{des}}(\Delta t_2), \dots, m_s^{\text{des}}(\Delta t_n)$ = mass of the substance remaining adsorbed on the soil after the time intervals $\Delta t_1, \Delta t_2, \dots, \Delta t_n$ respectively (μg)

$m_{\text{aq}}^{\text{des}}(\Delta t_1), m_{\text{aq}}^{\text{des}}(\Delta t_2), \dots, m_{\text{aq}}^{\text{des}}(\Delta t_n)$ = mass of the test substance desorbed during the time intervals $\Delta t_1, \Delta t_2, \dots, \Delta t_n$ respectively (μg)

$m_m^{\text{des}}(t_1), m_m^{\text{des}}(t_2), \dots, m_m^{\text{des}}(t_n)$ = mass of the substance measured in an aliquot (v_a^{D}) at time points t_1, t_2, \dots, t_n , respectively (μg)

V_T = total volume of the aqueous phase in contact with the soil during the desorption kinetics experiment performed with the serial method (cm^3)

m_{aq}^{A} = mass of the test substance left over from the adsorption equilibrium due to incomplete volume replacement (μg)

$$m_{\text{aq}}^{\text{A}} = \left(\frac{\left(V_0 - \sum_{i=1}^n v_a^{\text{A}}(i) \right) - V_R}{V_0 - \sum_{i=1}^n v_a^{\text{A}}(i)} \right) \cdot m_{\text{aq}}^{\text{ads}}(\text{eq}) \quad (26)$$

V_R = volume of the supernatant removed from the tube after the attainment of adsorption equilibrium and replaced by the same volume of a 0,01 M CaCl_2 solution (cm^3)

v_a^{D} = volume of the aliquot sampled for analytical purpose from the tube (i), during the desorption kinetics experiment performed with the serial-method (cm^3)

$$v_a^{\text{D}} \leq 0,02 \cdot V_T \quad (27)$$

▼ B

	Symbol	Units	Equili- bration time	Equili- bration time	Equili- bration time	Equili- bration time
After agitation and centrifugation						
INDIRECT METHOD						
Parallel method						
Concentration test subst. aq. phase Blank correction included	$C_{aq}^{ads}(t_i)$	$\mu\text{g cm}^{-3}$				
Serial method						
Measured mass test subst. in the aliquot V_a^A	$m_m^{ads}(t_i)$	μg				
DIRECT METHOD						
Mass test substance adsorbed on soil	$m_s^{ads}(t_i)$	μg				
Calculation of adsorption						
Adsorption	A_{t_i}	%				
	$A_{\Delta t_i}$	%				
Means						
Adsorption coefficient	K_d	$\text{cm}^3 \text{g}^{-1}$				
Means						
Adsorption coefficient	K_{oc}	$\text{cm}^3 \text{g}^{-1}$				
Means						

Substance tested:

Soil tested:

Dry mass content of the soil (105 °C, 12 h): %

Temperature: °C

Adsorption test: blanks and control

	Symbol	Units	Blank		Control	
Tube No						
Weighed soils		g			0	0
Water amount in weighed soil (calculated)		cm^3			—	—
Volume of 0,01 M CaCl_2 solution added		cm^3				
Volume of the stock solution of the test substance added		cm^3	0	0		
Total volume of aq. phase (calculated)		cm^3			—	—

▼ B

	Symbol	Units	Blank		Blank		Control	
Initial concentration of the test substance in aqueous phase		$\mu\text{g cm}^{-3}$						

After agitation and centrifugation

Concentration in aqueous phase		$\mu\text{g cm}^{-3}$						
--------------------------------	--	-----------------------	--	--	--	--	--	--

Remark: add columns if necessary

Substance tested:

Soil tested:

Dry mass content of the soil (105 °C 12 h): %

Temperature: °C

Mass balance

	Symbol	Units				
Tube No						
Weighed soil	—	g				
Soil: dry mass	m_{soil}	g				
Water volume in weighed soil (calculated)	V_{WS}	ml				
Volume 0,01 M CaCl_2 sol. to equilibrate the soil		ml				
Volume of stock solution		cm^3				
Total volume of aq. phase in contact with soil	V_0	cm^3				
Initial concentration test solution	C_0	$\mu\text{g cm}^{-3}$				
Equilibration time	—	h				

After agitation and centrifugation

Concentr. test subst. aq. phase at adsorption equilibrium blank correction included	$C_{\text{aq}}^{\text{ads}}(\text{eq})$	$\mu\text{g cm}^{-3}$				
Equalibration time	t_{eq}	h				

1st dilution with solvent

Removed volume aq. phase	V_{rec}	cm^3				
Added volume of solvent	ΔV	cm^3				

1st extraction with solvent

Signal analysed in solvent	S_{E1}	var.				
Conc. test subst. in solvent	C_{E1}	$\mu\text{g cm}^{-3}$				

▼ B

	Symbol	Units				
Mass of substance extracted from soil and vessel walls	m_{E1}	μg				
2nd dilution with solvent						
Removed volume of solvent	ΔV_s	cm^3				
Added volume of solvent	$\Delta V'$	cm^3				
2nd extraction with solvent						
Signal analysed in solvent phase	S_{E2}	var.				
Conc. test subst. in solvent	C_{E2}	$\mu\text{g cm}^{-3}$				
Mass of substance extracted from soil and vessel walls	m_{E2}	μg				
Total mass test subst. extracted in two steps	m_E	μg				
Mass balance	MB	%				

Substance tested:

Soil tested:

Dry mass content of the soil (105 °C, 12 h): %

Temperature: °C

Adsorption isotherms

	Symbol	Units							
Tube No									
Weighed soil	—	g							
Soil: dry mass	E	g							
Water volume in weighed soil (calculated)	V_{WS}	cm^3							
Volume 0,01 M CaCl_2 sol. to equilibrate the soil		cm^3							
Volume of stock solution added		cm^3							
Total volume of aq. phase in contact with soil (calculated)	V_0	cm^3							
Concentration solution	C_0	$\mu\text{g cm}^{-3}$							
Equilibration time	—	h							

▼ B

	Symbol	Units								
After agitation and centrifugation										
Concentration subst. aq. phase, blank correction included	$C_{aq}^{ads} (eq)$	$\mu g\ cm^{-3}$								
Temperature		$^{\circ}C$								
Adsorb. mass per unit soil	$C_s^{ads} (eq)$	$\mu g\ g^{-1}$								

Regression analysis:

value of K_F^{ads} :value of $1/n$:regression coefficient r^2 :

Substance tested:

Soil tested:

Dry mass content of the soil (105 °C, 12 h): %

Temperature: °C

Analytical methodology followed: Indirect Parallel Serial **Desorption test**

	Symbol	Units	Time interval	Time interval	Time interval	Time interval
Tube No coming from adsorption step						
Mass of substance adsorbed on soil at adsorption equilibrium	$m_s^{ads} (eq)$	μg				
Removed volume aq. phase, replaced by 0,01 M CaCl ₂	V_R	cm^3				
Total volume of aq. phase in contact with soil	PM	V_0	cm^3			
	SM	V_T	cm^3			
Mass test subst. left over the adsorption equilibrium due to incomplete volume replacement	m_{aq}^A	μg				

Desorption kinetics

Measured mass of substance desorbed from soil at time t_i	$m_m^{des} (t_i)$	μg				
Volume of the solution taken from the tube (i) for the measurement of the test substance	PM	V_r^i	cm^3			
	SM	V_a^D	cm^3			
Mass of substance desorbed from soil at time t_i (calculated)	$m_{aq}^{des} (t_i)$	μg				
Mass of substance desorbed from soil during time interval Δt_i (calculated)	$m_{aq}^{des} (\Delta t_i)$	μg				

▼ B

	Symbol	Units	Time interval	Time interval	Time interval	Time interval
Desorption percentage						
Desorption at time t_i	D_{t_i}	%				
Desorption at time interval Δt_i	$D_{\Delta t_i}$	%				
Apparent desorption coefficient	K_{des}					

PM: parallel method

SM: serial method

▼ B**C.19. ESTIMATION OF THE ADSORPTION COEFFICIENT (K_{OC}) ON SOIL AND ON SEWAGE SLUDGE USING HIGH PERFORMANCE LIQUID CHROMATOGRAPHY (HPLC)****1. METHOD**

This method is a replicate of OECD TG121 (2001).

1.1. INTRODUCTION

The sorption behaviour of substances in soils or sewage sludges can be described through parameters experimentally determined by means of the test method C.18. An important parameter is the adsorption coefficient which is defined as the ratio between the concentration of the substance in the soil/sludge and the concentration of the substance in the aqueous phase at adsorption equilibrium. The adsorption coefficient normalised to the organic carbon content of the soil K_{oc} is a useful indicator of the binding capacity of a chemical on organic matter of soil and sewage sludge and allows comparisons to be made between different chemicals. This parameter can be estimated through correlations with the water solubility and the n-octanol/water partition coefficient (1)(2)(3)(4)(5)(6)(7).

The experimental method described in this test uses HPLC for the estimation of the adsorption coefficient K_{oc} in soil and in sewage sludge (8). The estimates are of higher reliability than those from QSAR calculations (9). As an estimation method it cannot fully replace batch equilibrium experiments used in the test method C18. However, the estimated K_{oc} may be useful for choosing appropriate test parameters for adsorption/desorption studies according to the test method C.18 by calculating K_d (distribution coefficient) or K_f (Freundlich adsorption coefficient) according to the equation 3 (see Section 1.2).

1.2. DEFINITIONS

K_d : distribution coefficient is defined as the ratio of equilibrium concentrations C of a dissolved test substance in a two phase system consisting of a sorbent (soil or sewage sludge) and an aqueous phase; it is a dimensionless value when concentrations in both phases are expressed on a weight/weight base. In case the concentration in the aqueous phase is given on a weight/volume base then the units are $\text{ml} \cdot \text{g}^{-1}$. K_d can vary with sorbent properties and can be concentration dependent.

$$K_d = \frac{C_{soil}}{C_{aq}} \text{ or } \frac{C_{sludge}}{C_{aq}} \quad (1)$$

where:

C_{soil} = concentration of test substance in soil at equilibrium ($\mu\text{g} \cdot \text{g}^{-1}$)

C_{sludge} = concentration of test substance in sludge at equilibrium ($\mu\text{g} \cdot \text{g}^{-1}$)

C_{aq} = concentration of test substance in aqueous phase at equilibrium ($\mu\text{g} \cdot \text{g}^{-1}$, $\mu\text{g} \cdot \text{ml}^{-1}$).

▼ B

K_f: Freundlich adsorption coefficient is defined as the concentration of the test substance in soil or sewage sludge (x/m) when the equilibrium concentration C_{aq} in the aqueous phase is equal to one; units are $\mu\text{g}\cdot\text{g}^{-1}$ sorbent. The value can vary with sorbent properties.

$$\log \frac{x}{m} = \log K_f + \frac{1}{n} \cdot \log C_{aq} \quad (2)$$

where:

x/m = amount of test substance x (μg) adsorbed on amount of sorbent m (g) at equilibrium

$1/n$ = slope of Freundlich adsorption isotherm

C_{aq} = concentration of test substance in aqueous phase at equilibrium ($\mu\text{g}\cdot\text{ml}^{-1}$)

At $C_{aq} = 1$; $\log K_f = \log \frac{x}{m}$

K_{oc}: distribution coefficient (K_d) or Freundlich adsorption coefficient (K_f) normalised to the organic carbon content (f_{oc}) of a sorbent; particularly for non-ionised chemicals, it is an approximate indicator for the extent of adsorption between a substance and the sorbent and allows comparisons to be made between different chemicals. Depending on the dimensions of K_d and K_f , K_{oc} can be dimensionless or have the units $\text{ml}\cdot\text{g}^{-1}$ or $\mu\text{g}\cdot\text{g}^{-1}$ organic matter.

$$K_{oc} = \frac{K_d}{f_{oc}} \left(\text{dimensionless or } \text{ml}\cdot\text{g}^{-1} \right) \text{ or } \frac{K_f}{f_{oc}} \left(\mu\text{g}\cdot\text{g}^{-1} \right) \quad (3)$$

The relationship between K_{oc} and K_d is not always linear and thus K_{oc} values can vary from soil to soil but their variability is greatly reduced compared to K_d or K_f values.

The adsorption coefficient (K_{oc}) is deduced from the capacity factor (k') using a calibration plot of $\log k'$ versus $\log K_{oc}$ of the selected reference compounds.

$$k' = \frac{t_R - t_0}{t_0} \quad (4)$$

where:

t_R = HPLC retention time of test and reference substance (minutes);

t_0 = HPLC dead time (minutes) (see Section 1.8.2).

P_{ow}: The octanol-water partition coefficient is defined as the ratio of the concentrations of dissolved substance in n-octanol and water; it is a dimensionless value.

$$P_{ow} = \frac{C_{octanol}}{C_{aq}} (= K_{ow}) \quad (5)$$

1.3. REFERENCE SUBSTANCES

The structural formula, the purity and the dissociation constant (if appropriate) should be known before using the method. Information on solubility in water and organic solvents, on octanol-water partition coefficient and on hydrolysis characteristics is useful.

▼ B

To correlate the measured HPLC-retention data of a test substance with its adsorption coefficient K_{oc} , a calibration graph of $\log K_{oc}$ versus $\log k'$ has to be established. A minimum of six reference points, at least one above and one below the expected value of the test substance should be used. The accuracy of the method will be significantly improved if reference substances that are structurally related to the test substance are used. If such data are not available, it is up to the user to select the appropriate calibration substances. A more general set of structurally heterogeneous substances should be chosen in this case. Substances and K_{oc} -values which may be used are listed in the Appendix in Table 1 for sewage sludge and in Table 3 for soil. The selection of other calibration substances should be justified.

1.4. PRINCIPLE OF THE TEST METHOD

HPLC is performed on analytical columns packed with a commercially available cyanopropyl solid phase containing lipophilic and polar moieties. A moderately polar stationary phase based on a silica matrix is used:

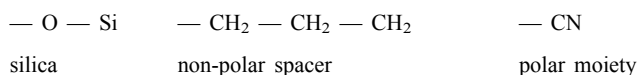

The principle of the test method is similar to testing method A.8 (Partition coefficient, HPLC method). While passing through the column along with the mobile phase the test substance interacts with the stationary phase. As a result of partitioning between mobile and stationary phases the test substance is retarded. The dual composition of the stationary phase having polar and non-polar sites allows for interaction of polar and non-polar groups of a molecule in a similar way as is the case for organic matter in soil or sewage sludge matrices. This enables the relationship between the retention time on the column and the adsorption coefficient on organic matter to be established.

pH has a significant influence on sorption behaviour in particular for polar substances. For agricultural soils or tanks of sewage treatment plants pH normally varies between pH 5,5 and 7,5. For ionisable substances, two tests should be performed with both ionised and non-ionised forms in appropriate buffer solutions but only in cases where at least 10 % of the test compound will be dissociated within pH 5,5 to 7,5.

Since only the relationship between the retention on the HPLC column and the adsorption coefficient is employed for the evaluation, no quantitative analytical method is required and only the determination of the retention time is necessary. If a suitable set of reference substances is available and standard experimental conditions can be used, the method provides a fast and efficient way to estimate the adsorption coefficient K_{oc} .

1.5. APPLICABILITY OF THE TEST

The HPLC method is applicable to chemical substances (unlabelled or labelled) for which an appropriate detection system (e.g. spectrophotometer, radioactivity detector) is available and which are sufficiently stable during the duration of the experiment. It may be particularly useful for chemicals which are difficult to study in other experimental systems (i.e. volatile substances; substances which are not soluble in water at a concentration which can be measured analytically; substances with a high affinity to the surface of incubation systems). The method can be used for mixtures which give unresolved elution bands. In such a case, upper and lower limits of the $\log K_{oc}$ values of the compounds of the test mixture should be stated.

▼ B

Impurities may sometimes cause problems for interpretation of HPLC results, but they are of minor importance as long as the test substance can analytically be clearly identified and separated from the impurities.

The method is validated for the substances listed in Table 1 in the Appendix and was also applied to a variety of other chemicals belonging to the following chemical classes:

- aromatic amines (e.g. trifluralin, 4-chloroaniline, 3,5-dinitroaniline, 4-methylaniline, N-methylaniline, 1-naphthylamine),
- aromatic carboxylic acid esters (e.g. benzoic acid methylester, 3,5-dinitrobenzoic acid ethylester),
- aromatic hydrocarbons (e.g. toluene, xylene, ethylbenzene, nitrobenzene),
- aryloxyphenoxypropionic acid esters (e.g. diclofop-methyl, fenoxaprop-ethyl, fenoxaprop-P-ethyl),
- benzimidazole and imidazole fungicides (e.g. carbendazim, fuberidazole, triazoxide),
- carboxylic acid amides (e.g. 2-chlorobenzamide, N,N-dimethylbenzamide, 3,5-dinitrobenzamide, N-methylbenzamide, 2-nitrobenzamide, 3-nitrobenzamide),
- chlorinated hydrocarbons (e.g. endosulfan, DDT, hexachlorobenzene, quintozone, 1,2,3-trichlorobenzene),
- organophosphorus insecticides (e.g. azinphos-methyl, disulfoton, fenamiphos, isofenphos, pyrazophos, sulprofos, triazophos),
- phenols (e.g. phenol, 2-nitrophenol, 4-nitrophenol, pentachlorophenol, 2,4,6-trichlorophenol, 1-naphthol),
- phenylurea derivatives (e.g. isoproturon, monolinuron, pencycuron),
- pigment dyestuffs (e.g. Acid Yellow 219, Basic Blue 41, Direct Red 81),
- polyaromatic hydrocarbons (e.g. acenaphthene, naphthalene),
- 1,3,5-triazine herbicides (e.g. prometryn, propazine, simazine, terbutryn),
- triazole derivatives (e.g. tebuconazole, triadimefon, tradimenol, triapenthenol).

The method is not applicable for substances which react either with the eluent or the stationary phase. It is also not applicable for substances that interact in a specific way with inorganic components (e.g. formation of cluster complexes with clay minerals). The method may not work for surface active substances, inorganic compounds and moderate or strong organic acids and bases. Log K_{oc} values ranging from 1,5 to 5,0 can be determined. Ionisable substances must be measured using a buffered mobile phase, but care has to be taken to avoid precipitation of buffer components or test substance.

▼ B

1.6. QUALITY CRITERIA

1.6.1. Accuracy

Normally, the adsorption coefficient of a test substance can be estimated to within $\pm 0,5$ log unit of the value determined by the batch equilibrium method (see Table 1 in the Appendix). Higher accuracy may be achieved if the reference substances used are structurally related to the test substance.

1.6.2. Repeatability

Determinations should be run at least in duplicate. The values of $\log K_{oc}$ derived from individual measurements should be within a range of 0,25 log unit.

1.6.3. Reproducibility

Experience gained so far in the application of the method is supportive of its validity. An investigation of the HPLC method, using 48 substances (mostly pesticides) for which reliable data on K_{oc} on soils were available gave a correlation coefficient of $R = 0,95$ (10) (11).

An inter-laboratory comparison test with 11 participating laboratories was performed to improve and validate the method (12). Results are given in Table 2 of the Appendix.

1.7. DESCRIPTION OF THE TEST METHOD

1.7.1. Preliminary Estimation of the Adsorption Coefficient

The octanol-water partition coefficient P_{ow} ($= K_{ow}$) and, to some extent, the water solubility can be used as indicators for the extent of adsorption, particularly for non-ionised substances, and thus may be used for preliminary range finding. A variety of useful correlations have been published for several groups of chemicals (1)(2)(3)(4)(5)(6)(7).

1.7.2. Apparatus

A liquid chromatograph, fitted with a pulse-free pump and a suitable detection device is required. The use of an injection valve with an injection loop is recommended. Commercial cyanopropyl chemically bound resins on a silica base shall be used (e.g. Hypersil and Zorbax CN). A guard column of the same material may be positioned between the injection system and the analytical column. Columns from different suppliers may vary considerably in their separation efficiency. As a guidance, the following capacity factors k' should be reached: $\log k' > 0,0$ for $\log K_{oc} = 3,0$ and $\log k' > -0,4$ for $\log K_{oc} = 2,0$ when using methanol/water 55/45 % as mobile phase.

1.7.3. Mobile phases

Several mobile phases have been tested and the following two are recommended:

— methanol/water (55/45 % v/v)

— methanol/0,01M citrate-buffer pH 6,0 (55/45 % v/v)

▼ B

HPLC grade methanol and distilled water or citrate-buffer are used to prepare the eluting solvent. The mixture is degassed before use. Isocratic elution should be employed. If methanol/water mixtures are not appropriate, other organic solvent/water mixtures may be tried, e.g. ethanol/water or acetonitrile/water mixtures. For ionisable compounds the use of buffer solution is recommended to stabilise pH. Care must be taken to avoid salt precipitation and column deterioration, which may occur with some organic phase/buffer mixtures.

No additives such as ion pair reagents may be used because they can affect the sorption properties of the stationary phase. Such changes of the stationary phase may be irreversible. For this reason, it is mandatory that experiments using additives are carried out on separate columns.

1.7.4. Solutes

Test and reference substances should be dissolved in the mobile phase.

1.8. PERFORMANCE OF THE TEST**1.8.1. Test condition**

The temperature during the measurements should be recorded. The use of a temperature controlled column compartment is highly recommended to guarantee constant conditions during calibration and estimation runs and measurement of the test substance.

1.8.2. Determination of dead time t_0

For the determination of the dead time t_0 , two different methods may be used (see also Section 1.2).

1.8.2.1. *Determination of the dead time t_0 by means of a homologous series*

This procedure has proven to yield reliable and standardised t_0 values. For details see Testing Method A.8: Partition coefficient (n-octanol/water), HPLC method.

1.8.2.2. *Determination of the dead time t_0 by inert substances which are not retained by the column*

This technique is based on the injection of solutions of formamide, urea or sodium nitrate. Measurements should be performed at least in duplicate.

1.8.3. Determination of the retention times t_R

Reference substances should be selected as described in Section 1.3. They may be injected as a mixed standard to determine their retention times, provided it has been confirmed that the retention time of each reference standard is unaffected by the presence of the other reference standards. The calibration should be performed at regular intervals at least twice daily in order to account for unexpected changes in column performance. For best practice the calibration injections should be carried out before and after injections of the test substance to confirm retention times have not drifted. The test substances are injected separately in quantities as small as possible (to avoid column overload) and their retention times are determined.

▼B

In order to increase the confidence in the measurement, at least duplicate determinations should be made. The values of $\log K_{oc}$ derived from individual measurements should fall within a range of 0,25 log unit.

1.8.4. Evaluation

The capacity factors k' are calculated from the dead time t_0 and retention times t_R of the selected reference substances according to equation 4 (see Section 1.2). The $\log k'$ data of the reference substances are then plotted against their $\log K_{oc}$ values from batch equilibrium experiments given in Tables 1 and 3 of the Appendix. Using this plot, the $\log k'$ value of a test substance is then used to determine its $\log K_{oc}$ value. If the actual results show that the $\log K_{oc}$ of the test substance is outside the calibration range the test should be repeated using different, more appropriate reference substances.

2. DATA AND REPORTING

The report must include the following information:

- identity of test and reference substances and their purity, and pK_a values if relevant,
- description of equipment and operating conditions, e.g. type and dimension of analytical (and guard) column, means of detection, mobile phase (ratio of components and pH), temperature range during measurements,
- dead time and the method used for its determination,
- quantities of test and reference substances introduced in the column,
- retention times of reference compounds used for calibration,
- details of fitted regression line ($\log k'$ vs $\log K_{oc}$) and a graph of the regression line,
- average retention data and estimated $\log K_{oc}$ value for the test compound,
- chromatograms.

3. REFERENCES

- (1) W.J. Lyman, W.F. Reehl, D.H. Rosenblatt (ed), (1990) Handbook of chemical property estimation methods, chapt. 4, McGraw-Hill, New York.
- (2) J. Hodson, N.A. Williams, (1988) The estimation of the adsorption coefficient (K_{oc}) for soils by HPLC. Chemosphere, 17, p. 167.
- (3) G.G. Briggs, (1981) Theoretical and experimental relationships between soil adsorption, octanol-water partition coefficients, water solubilities, bioconcentration factors, and the parachor. J. Agric. Food Chem., 29, p. 1050-1059.
- (4) C.T. Chiou, P.E. Porter, D.W. Schmedding, (1983) Partition equilibria of nonionic organic compounds between soil organic matter and water. Environ. Sci. Technol., 17, p. 227-231.
- (5) Z. Gerstl, U. Mingelgrin (1984) Sorption of organic substances by soils and sediment. J. Environm. Sci. Health, B19, p. 297-312.

▼B

- (6) C.T. Chiou, L.J. Peters, V. H. Freed, (1979) A physical concept of soil water equilibria for nonionic organic compounds, *Science*, 106, p. 831-832.
- (7) S.W. Karickhoff, (1981) Semi-empirical estimation of sorption of hydrophobic pollutants on natural sediments and soils. *Chemosphere*, 10, p. 833-846.
- (8) W. Kördel, D. Hennecke, M. Herrmann, (1997) Application of the HPLC-screening method for the determination of the adsorption coefficient on sewage sludges. *Chemosphere*, 35(1/2), p. 121-128.
- (9) M. Mueller, W. Kördel (1996) Comparison of screening methods for the estimation of adsorption coefficients on soil. *Chemosphere*, 32(12), p. 2493-2504.
- (10) W. Kördel, J. Stutte, G. Kotthoff (1993) HPLC-screening method for the determination of the adsorption coefficient in soil-comparison of different stationary phases, *Chemosphere*, 27(12), p. 2341-2352.
- (11) B. von Oepen, W. Kördel, W. Klein (1991) Sorption of nonpolar and polar compounds to soils: Processes, measurements and experience with the applicability of the modified OECD Guideline 106, *Chemosphere*, 22, p. 285-304.
- (12) W. Kördel, G. Kotthoff, J. Müller (1995) HPLC-screening method for the determination of the adsorption coefficient on soil-results of a ring test. *Chemosphere*, 30(7), p. 1373-1384.



Appendix

Table 1

Comparison of K_{oc} values for soils and sewage sludges, and calculated values by the HPLC screening method ⁽¹⁾, ⁽²⁾

substance	CAS-No	log K_{oc} sewage sludges	log K_{oc} HPLC	Δ	log K_{oc} soils	log K_{oc} HPLC	Δ
Atrazine	1912-24-9	1,66	2,14	0,48	1,81	2,20	0,39
Linuron	330-55-2	2,43	2,96	0,53	2,59	2,89	0,30
Fenthion	55-38-9	3,75	3,58	0,17	3,31	3,40	0,09
Monuron	150-68-5	1,46	2,21	0,75	1,99	2,26	0,27
Phenanthrene	85-01-8	4,35	3,72	0,63	4,09	3,52	0,57
Benzoic acid phenylester	93-99-2	3,26	3,03	0,23	2,87	2,94	0,07
Benzamide	55-21-0	1,60	1,00	0,60	1,26	1,25	0,01
4-Nitrobenzamide	619-80-7	1,52	1,49	0,03	1,93	1,66	0,27
Acetanilide	103-84-4	1,52	1,53	0,01	1,26	1,69	0,08
Aniline	62-53-3	1,74	1,47	0,27	2,07	1,64	0,43
2,5-Dichloroaniline	95-82-9	2,45	2,59	0,14	2,55	2,58	0,03

⁽¹⁾ W. Kördel, D. Hennecke, M. Herrmann, (1997) Application of the HPLC-screening method for the determination of the adsorption coefficient on sewage sludges. Chemosphere, 35(1/2), p. 121-128.

⁽²⁾ W. Kördel, D. Hennecke, C. Franke, (1997) Determination of the adsorption-coefficients of organic substances on sewage sludges. Chemosphere, 35 (1/2), p. 107-119.

Table 2

Results of a laboratory inter-comparison test (11 participating laboratories) performed to improve and validate the HPLC-method ⁽¹⁾

substance	CAS-No	log K_{oc}	K_{oc}	log K_{oc}
		[OECD 106]	[HPLC-method]	
Atrazine	1912-24-9	1,81	78 ± 16	1,89
Monuron	150-68-5	1,99	100 ± 8	2,00
Triapenthenol	77608-88-3	2,37	292 ± 58	2,47
Linuron	330-55-2	2,59	465 ± 62	2,67
Fenthion	55-38-9	3,31	2062 ± 648	3,31

⁽¹⁾ W. Kördel, G. Kotthoff, J. Müller (1995). HPLC-screening method for the determination of the adsorption coefficient on soil-results of a ring test. Chemosphere, 30(7), 1373-1384.



Table 3

Recommended reference substances for the HPLC screening method based on soil adsorption data.

Reference substance	CAS-No	log K _{oc} mean values from batch equilibrium	number of K _{oc} data	log S.D.	source
Acetanilide	103-84-4	1,25	4	0,48	(a)
Phenol	108-95-2	1,32	4	0,70	(a)
2-Nitrobenzamide	610-15-1	1,45	3	0,90	(b)
N,N-dimethylbenzamide	611-74-5	1,52	2	0,45	(a)
4-Methylbenzamide	619-55-6	1,78	3	1,76	(a)
Methylbenzoate	93-58-3	1,80	4	1,08	(a)
Atrazine	1912-24-9	1,81	3	1,08	(c)
Isoproturon	34123-59-6	1,86	5	1,53	(c)
3-Nitrobenzamide	645-09-0	1,95	3	1,31	(b)
Aniline	62-53-3	2,07	4	1,73	(a)
3,5-Dinitrobenzamide	121-81-3	2,31	3	1,27	(b)
Carbendazim	10605-21-7	2,35	3	1,37	(c)
Triadimenol	55219-65-3	2,40	3	1,85	(c)
Triazoxide	72459-58-6	2,44	3	1,66	(c)
Triazophos	24017-47-8	2,55	3	1,78	(c)
Linuron	330-55-2	2,59	3	1,97	(c)
Naphthalene	91-20-3	2,75	4	2,20	(a)
Endosulfan-diol	2157-19-9	3,02	5	2,29	(c)
Methiocarb	2032-65-7	3,10	4	2,39	(c)
Acid Yellow 219	63405-85-6	3,16	4	2,83	(a)
1,2,3-Trichlorobenzene	87-61-6	3,16	4	1,40	(a)
γ-HCH	58-89-9	3,23	5	2,94	(a)
Fenthion	55-38-9	3,31	3	2,49	(c)
Direct Red 81	2610-11-9	3,43	4	2,68	(a)
Pyrazophos	13457-18-6	3,65	3	2,70	(c)
α-Endosulfan	959-98-8	4,09	5	3,74	(c)
Diclofop-methyl	51338-27-3	4,20	3	3,77	(c)
Phenanthrene	85-01-8	4,09	4	3,83	(a)
Basic Blue 41 (mix)	26850-47-5 12270-13-2	4,89	4	4,46	(a)
DDT	50-29-3	5,63	1	—	(b)

(a) W. Kördel, J. Müller (1994). Bestimmung des Adsorptionskoeffizienten organischer Chemikalien mit der HPLC. UBA R & D Report No. 106 01 044 (1994).

(b) B.V. Oepen, W. Kördel, W. Klein., (1991) Chemosphere, 22, p. 285-304.

(c) Data provided by industry.

▼M7**C.20. DAPHNIA MAGNA REPRODUCTION TEST****INTRODUCTION**

This test method is equivalent to OECD test guideline (TG) 211 (2012). OECD test guidelines are periodically reviewed in the light of scientific progress. The reproduction test guideline 211 originates from test guideline 202, Part II, *Daphnia* sp. reproduction test (1984). It had generally been acknowledged that data from tests performed according to that TG 202 could be variable. This led to considerable effort being devoted to the identification of the reasons for this variability with the aim of producing a better test method. Test guideline 211 is based on the outcome of these research activities, ring-tests and validation studies performed in 1992 (1), 1994 (2) and 2008 (3).

The main differences between the initial version (TG 202, 1984), and second version (TG 211, 1998) of the reproduction test guideline are:

- the recommended species to be used is *Daphnia magna*;
- the test duration is 21 days;
- for semi-static tests, the number of animals to be used at each test concentration has been reduced from at least 40, preferably divided into four groups of 10 animals, to at least 10 animals held individually (although different designs can be used for flow-through tests);
- more specific recommendations have been made with regard to test medium and feeding conditions.
- the main differences between the second version of the reproduction test guideline (TG 211, 1998) and this version are:
 - appendix 7 has been added to describe procedures for the identification of neonate sex if required. In line with previous versions of this test method sex ratio is an optional endpoint;
 - the response variable number of living offspring produced per surviving parental animal has been supplemented with an additional response variable for *Daphnia* reproduction, i.e. the total number of living offspring produced at the end of the test per parent daphnia at the start of the test excluding from the analysis parental accidental and/or inadvertent mortality. The purpose of the added response variable is to align this response variable with other reproduction test methods on invertebrates. Furthermore, in relation to this response variable, it is possible, in this test method, to remove a source of error, namely the effect of inadvertent and/or accidental parental mortality, should that occur during the exposure period.
 - additional statistical guidance for test design and for treatment of results has been included both for EC_x (e.g. EC₁₀ or EC₅₀) and for NOEC/LOEC approach.
 - a limit test is introduced.

Definitions used are given in Appendix 1.

PRINCIPLE OF THE TEST

The primary objective of the test is to assess the effect of chemicals on the reproductive output of *Daphnia magna*. To this end, young female *Daphnia* (the parent animals), aged less than 24 hours at the start of the test, are exposed to the test chemical added to water at a range of concentrations. The

▼ M7

test duration is 21 days. At the end of the test, the total number of living offspring produced is assessed. Reproductive output of the parent animals can be expressed in other ways (e.g. number of living offspring produced per animal per day from the first day offspring were observed) but these should be reported in addition to the total number of living offspring produced at the end of the test. Because of the particular design of the semi-static test compared to other invertebrate reproduction test methods, it is also possible to count the number of living offspring produced by each individual parent animal. This enables that, contrary to other invertebrate reproduction test methods, if the parent animal dies accidentally and/or inadvertently during the test period, its offspring production can be excluded from data assessment. Hence, if parental mortality occurs in exposed replicates, it should be considered whether or not the mortality follows a concentration-response pattern, e.g. if there is a significant regression of the response versus concentration of the test chemical with a positive slope (a statistical test like the Cochran-Armitage trend test may be used for this). If the mortality does not follow a concentration-response pattern, then those replicates with parental mortality should be excluded from the analysis of the test result. If the mortality follows a concentration-response pattern, the parental mortality should be assigned as an effect of the test chemical and the replicates should not be excluded from the analysis. If the parent animal dies during the test i.e. accidentally from mishandling or accident, or inadvertently due to unexplained incident not related to the effect of the test chemical or turns out to be male, then the replicate is excluded from the analysis (see more in paragraph 51). The toxic effect of the test chemical on reproductive output is expressed as EC_x by fitting the data to an appropriate model by non-linear regression to estimate the concentration that would cause x % reduction in reproductive output, respectively, or alternatively as the NOEC/LOEC value (4). *The test concentrations should preferably bracket the lowest of the used effect concentrations (e.g. EC₁₀) which means that this value is calculated by interpolation and not extrapolation.*

The survival of the parent animals and time to production of first brood should also be reported. Other chemical-related effects on parameters such as growth (e.g. length), and possibly intrinsic rate of population increase, can also be examined (see paragraph 44).

INFORMATION ON THE TEST CHEMICAL

Results of an acute toxicity test (see chapter C.2 of this Annex: *Daphnia* sp. acute immobilisation test) performed with *Daphnia magna* may be useful in selecting an appropriate range of test concentrations in the reproduction tests. The water solubility and the vapour pressure of the test chemical should be known and a reliable analytical method for the quantification of the chemical in the test solutions with reported recovery efficiency and limit of determination should be available.

Information on the test chemical which may be useful in establishing the test conditions includes the structural formula, purity of the chemical, stability in light, stability under the conditions of the test, pK_a, P_{ow} and results of a test for ready biodegradability (see chapters C.4 (determination of 'ready' biodegradability), and C.29 (ready biodegradability — CO₂ in sealed vessels) of this Annex).

VALIDITY OF THE TEST

For a test to be valid, the following performance criteria should be met in the control(s):

- the mortality of the parent animals (female *Daphnia*) does not exceed 20 % at the end of the test;
- the mean number of living offspring produced per parent animal surviving at the end of the test is ≥ 60 .

Note: The same validity criterion (20 %) can be used for accidental and inadvertent parental mortality for the controls as well as for each of the test concentrations.

▼ M7**DESCRIPTION OF THE METHOD****Apparatus**

Test vessels and other apparatus, which will come into contact with the test solutions, should be made entirely of glass or other chemically inert material. The test vessels will normally be glass beakers.

In addition, some or all of the following equipment will be required:

- oxygen meter (with microelectrode or other suitable equipment for measuring dissolved oxygen in low volume samples);
- adequate apparatus for temperature control;
- pH-meter;
- equipment for the determination of the hardness of water;
- equipment for the determination of the total organic carbon concentration (TOC) of water or equipment for the determination of the chemical oxygen demand (COD);
- adequate apparatus for the control of the lighting regime and measurement of light intensity.

Test Organism

The species to be used in the test is *Daphnia magna* Straus⁽¹⁾.

Preferably, the clone should have been identified by genotyping. Research (1) has shown that the reproductive performance of Clone A (which originated from IRCHA in France) (5) consistently meets the validity criterion of a mean of ≥ 60 living offspring per parent animal surviving when cultured under the conditions described in this test method. However, other clones are acceptable provided that the *Daphnia* culture is shown to meet the validity criteria for the test.

At the start of the test, the animals should be less than 24 hours old and should not be first brood progeny. They should be derived from a healthy stock (i.e. showing no signs of stress such as high mortality, presence of males and ephippia, delay in the production of the first brood, discoloured animals, etc.). The stock animals should be maintained in culture conditions (light, temperature, medium, feeding and animals per unit volume) similar to those to be used in the test. If the *Daphnia* culture medium to be used in the test is different from that used for routine *Daphnia* culture, it is good practice to include a pre-test acclimation period of normally about 3 weeks (i.e. one generation) to avoid stressing the parent animals.

Test medium

It is recommended that a fully defined medium be used in this test. This can avoid the use of additives (e.g. seaweed, soil extract), which are difficult to characterise, and therefore improves the opportunities for standardisation between laboratories. Elendt M4 (6) and M7 media (see Appendix 2) have been found to be suitable for this purpose. However, other media (e.g. (7) (8)) are acceptable provided the performance of the *Daphnia* culture is shown to meet the validity criteria for the test.

⁽¹⁾ Other daphnids may be used provided they meet the validity criteria as appropriate (the validity criterion relating to the reproductive output in the controls should be relevant for all species). If other *daphnid* are used they should be clearly identified and their use justified.

▼ M7

If media are used which include undefined additives, these additives should be specified clearly and information should be provided in the test report on composition, particularly with regard to carbon content as this may contribute to the diet provided. It is recommended that the total organic carbon (TOC) and/or chemical oxygen demand (COD) of the stock preparation of the organic additive be determined and an estimate of the resulting contribution to the TOC/COD in the test medium made. It is further recommended that TOC levels in the medium (i.e. before addition of the algae) be below 2 mg/l (9).

When testing chemicals containing metals, it is important to recognise that the properties of the test medium (e.g. hardness, chelating capacity) may have a bearing on the toxicity of the test chemical. For this reason, a fully defined medium is desirable. However, at present, the only fully defined media which are known to be suitable for long-term culture of *Daphnia magna* are Elendt M4 and M7. Both media contain the chelating agent EDTA. Work has shown (2) that the 'apparent toxicity' of cadmium is generally lower when the reproduction test is performed in M4 and M7 media than in media containing no EDTA. M4 and M7 are not, therefore, recommended for testing chemicals containing metals, and other media containing known chelating agents should also be avoided. For metal-containing chemicals it may be advisable to use an alternative medium such as, for example, ASTM reconstituted hard fresh water (9), which contains no EDTA. This combination of ASTM reconstituted hard fresh water and seaweed extract (10) is suitable for long-term culturing of *Daphnia magna* (2).

The dissolved oxygen concentration should be above 3 mg/l at the beginning and during the test. The pH should be within the range 6 - 9, and normally it should not vary by more than 1,5 units in any one test. Hardness above 140 mg/l (as CaCO₃) is recommended. Tests at this level and above have demonstrated reproductive performance in compliance with the validity criteria (11) (12).

Test solutions

Test solutions of the chosen concentrations are usually prepared by dilution of a stock solution. Stock solutions should preferably be prepared, without using any solvents or dispersants if possible, by mixing or agitating the test chemical in test medium using mechanical means such as agitating, stirring or ultrasonication, or other appropriate methods. It is preferable to expose test systems to concentrations of the test chemical to be used in the study for as long as is required to demonstrate the maintenance of stable exposure concentrations prior to the introduction of test organisms. If the test chemical is difficult to dissolve in water, procedures described in the OECD Guidance for handling difficult substances should be followed (13). The use of solvents or dispersants should be avoided, but may be necessary in some cases in order to produce a suitably concentrated stock solution for dosing.

A dilution water control with adequate replicates and, if unavoidable, a solvent control with adequate replicates should be run in addition to the test concentrations. Only solvents or dispersants that have been investigated to have no significant or only minimal effects on the response variable should be used in the test. Examples of suitable solvents (e.g. acetone, ethanol, methanol, dimethylformamide and triethylene glycol) and dispersants (e.g. Cremophor RH40, methylcellulose 0,01 % and HCO-40) are given in (13). Where a solvent or dispersant is used, its final concentration should not be greater than 0,1 ml/l (13) and it should be the same concentration in all test vessels, except the

▼ M7

dilution water control. However, every effort should be made to keep the solvent concentration to a minimum.

PROCEDURE**Conditions of Exposure***Duration*

The test duration is 21 days.

Loading

Parent animals are maintained individually, one per test vessel, usually with 50 - 100 ml (for *Daphnia magna*, smaller volumes may be possible especially for smaller daphnids e.g. *Ceriodaphnia dubia*) of medium in each vessel, unless a flow-through test design is necessary for testing.

Larger volumes may sometimes be necessary to meet requirements of the analytical procedure used for determination of the test chemical concentration, although pooling of replicates for chemical analysis is also allowable. If volumes greater than 100 ml are used, the ration given to the *Daphnia* may need to be increased to ensure adequate food availability and compliance with the validity criteria.

Test animals

For semi-static tests, at least 10 animals individually held at each test concentration and at least 10 animals individually held in the control series.

For flow-through tests, 40 animals divided into four groups of 10 animals at each test concentration has been shown to be suitable (1). A smaller number of test organisms may be used and a minimum of 20 animals per concentration divided into two or more replicates with an equal number of animals (e.g. four replicates each with five daphnids) is recommended. Note that for tests where animals are held in groups, it will not be possible to exclude any offspring from the statistical analysis if inadvertent/ accidental parental mortality occurs when the reproduction has begun, and hence in these cases the reproductive output should be expressed as total number of living offspring produced per parent present at the beginning of the test.

Treatments should be allocated to the test vessels and all subsequent handling of the test vessels should be done in a random fashion. Failure to do this may result in bias that could be construed as being a concentration effect. In particular, if experimental units are handled in treatment or concentration order, then some time-related effect, such as operator fatigue or other error, could lead to greater effects at the higher concentrations. Furthermore, if the test results are likely to be affected by an initial or environmental condition of the test, such as position in the laboratory, then consideration should be given to blocking the test.

Feeding

For semi-static tests, feeding should preferably be done daily, but at least three times per week (i.e. corresponding to media changes). The possible dilution of the exposure concentrations by food addition should be taken into account and avoided as much as possible with well concentrated algae suspensions. Deviations from this (e.g. for flow-through tests) should be reported.

During the test, the diet of the parent animals should preferably be living algal cells of one or more of the following: *Chlorella* sp., *Pseudokirchneriella subcapitata* (formerly *Selenastrum capricornutum*) and *Desmodesmus subspicatus* (formerly *Scenedesmus subspicatus*). The supplied diet should be based on the amount of organic carbon (C) provided to each parent animal. Research (14) has shown that, for *Daphnia magna*, ration levels of between 0,1 and 0,2 mg C/*Daphnia*/day are sufficient for achieving the required

▼M7

number of living offspring to meet the test validity criteria. The ration can be supplied either at a constant rate throughout the period of the test, or, if desired, a lower rate can be used at the beginning and then increased during the test to take account of growth of the parent animals. In this case, the ration should still remain within the recommended range of 0,1 - 0,2 mg C/*Daphnia*/day at all times.

If surrogate measures, such as algal cell number or light absorbance, are to be used to feed the required ration level (i.e. for convenience since measurement of carbon content is time consuming), each laboratory should produce its own nomograph relating the surrogate measure to carbon content of the algal culture (see Appendix 3 for advice on nomograph production). Nomographs should be checked at least annually and more frequently if algal culture conditions have changed. Light absorbance has been found to be a better surrogate for carbon content than cell number (15).

A concentrated algal suspension should be fed to the *Daphnia* to minimise the volume of algal culture medium transferred to the test vessels. Concentration of the algae can be achieved by centrifugation followed by re-suspension in *Daphnia* culture medium.

Light

16 hours light at an intensity not exceeding $15\text{-}20 \mu\text{E} \cdot \text{m}^{-2} \cdot \text{s}^{-1}$ measured at the water surface of the vessel. For light-measuring instruments calibrated in lux, an equivalent range of 1 000-1 500 lux for cool white light corresponds close to the recommended light intensity $15\text{-}20 \mu\text{E} \cdot \text{m}^{-2} \cdot \text{s}^{-1}$.

Temperature

The temperature of the test media should be within the range 18-22 °C. However, for any one test, the temperature should not, if possible, vary by more than 2 °C within these limits (e.g. 18-20, 19-21 or 20-22 °C) as daily range. It may be appropriate to use an additional test vessel for the purposes of temperature monitoring.

Aeration

The test vessels should not be aerated during the test.

Test design*Range finding test*

When necessary, a range-finding test is conducted with, for example five test chemical concentrations and two replicates for each treatment and control. Additional information, from tests with similar chemicals or from literature, on acute toxicity to *Daphnia* and/or other aquatic organisms may also be useful in deciding on the range of concentrations to be used in the range-finding test.

The duration of the range-finding test is 21 days or of a sufficient duration to reliably predict effect levels. At the end of the test, reproduction of the *Daphnia* is assessed. The number of parents and the occurrence of offspring should be recorded.

Definitive test

Normally there should be at least five test concentrations, bracketing effective concentration (e.g. EC_x), and arranged in a geometric series with a separation factor preferably not exceeding 3,2. An appropriate number of replicates for each test concentration should be used (see paragraphs 24-25). Justification should be provided if fewer than five concentrations are used. Chemicals should not be

▼ M7

tested above their solubility limit in test medium. Before conducting the experiment it is advisable to consider the statistical power of the tests design and using appropriate statistical methods (4). In setting the range of concentrations, the following should be borne in mind:

- (i) When EC_x for effects on reproduction is estimated, it is advisable that sufficient concentrations are used to define the EC_x with an appropriate level of confidence. Test concentrations used should preferably bracket the estimated EC_x such that EC_x is found by interpolation rather than extrapolation. It is an advantage for the following statistical analysis to have more test concentrations (e.g. 10) and fewer replicates of each concentration (e.g. 5 thus holding the total number of vessels constant) and with 10 controls.
- (ii) When estimating the LOEC and/or NOEC, the lowest test concentration should be low enough so that the reproductive output at that concentration is not significantly lower than that in the control. If this is not the case, the test should be repeated with a reduced lowest concentration.
- (iii) When estimating the LOEC and/or NOEC, the highest test concentration should be high enough so that the reproductive output at that concentration is significantly lower than that in the control. If this is not the case, the test should be repeated with an increased highest concentration unless the maximum required test concentration for chronic effects testing (i.e., 10 mg/l) was used as the highest test concentration in the initial test.

If no effects are observed at the highest concentration in the range-finding test (e.g. at 10 mg/l), or when the test chemical is highly likely to be of low/ no toxicity based on lack of toxicity to other organisms and/or low/no uptake, the reproduction test may be performed as a limit test, using a test concentration of e.g. 10 mg/l and the control. Ten replicates should be used for both the treatment and the control groups. When a limit test might need to be done in a flow-through system less replicates would be adequate. A limit test will provide the opportunity to demonstrate that there is no statistically significant effect at the limit concentration, but if effects are recorded a full test will normally be required.

Controls

One test-medium control series and also, if relevant, one control series containing the solvent or dispersant should be run in addition to the test series. When used, the solvent or dispersant concentration should be the same as that used in the vessels containing the test chemical. The appropriate number of replicates should be used (see paragraphs 23-24).

Generally in a well-run test, the coefficient of variation around the mean number of living offspring produced per parent animal in the control(s) should be $\leq 25\%$, and this should be reported for test designs using individually held animals.

Test medium renewal

The frequency of medium renewal will depend on the stability of the test chemical, but should be at least three times per week. If, from preliminary stability tests (see paragraph 7), the test chemical concentration is not stable (i.e. outside the range 80 - 120 % of nominal or falling below 80 % of the measured initial concentration) over the maximum renewal period (i.e. 3 days), consideration should be given to more frequent medium renewal, or to the use of a flow-through test.

▼ M7

When the medium is renewed in semi-static tests, a second series of test vessels are prepared and the parent animals transferred to them by, for example, a glass pipette of suitable diameter. The volume of medium transferred with the *Daphnia* should be minimised.

Observations

The results of the observations made during the test should be recorded on data sheets (see examples in Appendixes 4 and 5). If other measurements are required (see paragraph 44), additional observations may be required.

Offspring

The offspring produced by each parent animal should preferably be removed and counted daily from the appearance of the first brood to prevent them consuming food intended for the parent. For the purpose of this test method it is only the number of living offspring that needs to be counted, but the presence of aborted eggs or dead offspring should be recorded.

Mortality

Mortality among the parent animals should be recorded preferably daily, or at least as frequently as offspring are counted.

Other parameters

Although this test method is designed principally to assess effects on reproductive output, it is possible that other effects may also be sufficiently quantified to allow statistical analysis. Reproductive output per surviving parent animal, i.e. number of living offspring produced during the test per surviving parent, may be recorded. This may be compared with the main response variable (reproductive output per parent animal in the start of the test which did not inadvertently or accidentally die during the test). If parental mortality occurs in exposed replicates it should be considered whether or not the mortality follows a concentration-response pattern, e.g. if there is a significant regression of the response versus concentration of the test chemical with a positive slope (a statistical test like the Cochran-Armitage trend test may be used for this). If the mortality does not follow a concentration-response pattern, then those replicates with parental mortality should be excluded from the analysis of the test result. If the mortality follows a concentration-response pattern, the parental mortality should be assigned as an effect of the test chemical and the replicates should not be excluded from the analysis of the test result. Growth measurements are highly desirable since they provide information on possible sublethal effects which may be useful in addition to reproduction measures alone; the measurement of the length of the parent animals (i.e. body length excluding the anal spine) at the end of the test is recommended. Other parameters that can be measured or calculated include time to production of first brood (and subsequent broods), number and size of broods per animal, number of aborted broods, presence of male neonates (OECD, 2008) or ephippia and possibly the intrinsic rate of population increase (see Appendix 1 for definition and Appendix 7 for the identification of the sex of neonates).

Frequency of analytical determinations and measurements

Oxygen concentration, temperature, hardness and pH values should be measured at least once a week, in fresh and old media, in the control(s) and in the highest test chemical concentration.

During the test, the concentrations of test chemical are determined at regular intervals.

In semi-static tests where the concentration of the test chemical is expected to remain within ± 20 per cent of the nominal (i.e. within the range 80 - 120 per cent- see paragraphs 6, 7 and 39), it is recommended that, as a minimum, the

▼ M7

highest and lowest test concentrations be analysed when freshly prepared and at the time of renewal on one occasion during the first week of the test (i.e. analyses should be made on a sample from the same solution — when freshly prepared and at renewal). These determinations should be repeated at least at weekly intervals thereafter.

For tests where the concentration of the test chemical is not expected to remain within ± 20 per cent of the nominal, it is necessary to analyse all test concentrations, when freshly prepared and at renewal. However, for those tests where the measured initial concentration of the test chemical is not within ± 20 per cent of nominal but where sufficient evidence can be provided to show that the initial concentrations are repeatable and stable (i.e. within the range 80 - 120 per cent of initial concentrations), chemical determinations could be reduced in weeks 2 and 3 of the test to the highest and lowest test concentrations. In all cases, determination of test chemical concentrations prior to renewal need only be performed on one replicate vessel at each test concentration.

If a flow-through test is used, a similar sampling regime to that described for semi-static tests is appropriate (but measurement of 'old' solutions is not applicable in this case). However, it may be advisable to increase the number of sampling occasions during the first week (e.g. three sets of measurements) to ensure that the test concentrations are remaining stable. In these types of test, the flow-rate of diluent and test chemical should be checked daily.

If there is evidence that the concentration of the chemical being tested has been satisfactorily maintained within ± 20 per cent of the nominal or measured initial concentration throughout the test, then results can be based on nominal or measured initial values. If the deviation from the nominal or measured initial concentration is greater than ± 20 per cent, results should be expressed in terms of the time-weighted mean (see guidance for calculation in Appendix 6).

DATA AND REPORTING**Treatment of results**

The purpose of this test is to determine the effect of the test chemical on the reproductive output. The total number of living offspring per parent animal should be calculated for each test vessel (i.e. replicate). In addition, the reproduction can be calculated based on the production of living offspring by the surviving parent organism. However, the ecologically most relevant response variable is the total number of living offspring produced per parent animal which does not die accidentally⁽¹⁾ or inadvertently⁽²⁾ during the test. If the parent animal dies accidentally or inadvertently during the test, or turns out to be male, then the replicate is excluded from the analysis. The analysis will then be based on a reduced number of replicates. If parental mortality occurs in exposed replicates it should be considered whether or not the mortality follows a concentration-response pattern, e.g. if there is a significant regression of the response versus concentration of the test chemical with a positive slope (a statistical test like the Cochran-Armitage trend test may be used for this). If the mortality does not follow a concentration-response pattern, then those replicates with parental mortality should be excluded from the analysis of the test result. If the mortality follows a concentration-response pattern, the parental mortality should be assigned as an effect of the test chemical and the replicates should not be excluded from the analysis of the test result.

In summary, when LOEC and NOEC or EC_x are being used to express the effects, it is recommended to calculate the effect on reproduction by the use of both response variables mentioned above i.e.

⁽¹⁾ Accidental mortality: non chemical related mortality caused by an accidental incidence (i.e. known cause)

⁽²⁾ Inadvertent mortality: non chemical related mortality with no known cause

▼ M7

— as the total number of living offspring produced per parent animal which does not die accidentally or inadvertently during the test and;

— as the number of living offspring produced per surviving parental animal;

and then to use as the final result the lowest NOEC and LOEC or EC_x value calculated by using either of these two response variables.

Before employing the statistical analysis, e.g. ANOVA procedures, comparison of treatments to the control by Student t-test, Dunnett's test, Williams' test, or stepdown Jonckheere-Terpstra test, it is recommended to consider transformation of data if needed for meeting the requirements of the particular statistical test. As non-parametric alternatives one can consider Dunn's or Mann-Whitney's tests. 95 % confidence intervals are calculated for individual treatment means.

The number of surviving parents in the untreated controls is a validity criterion, and should be documented and reported. Also all other detrimental effects, e.g. abnormal behavior and toxicological significant findings, should be reported in the final report as well.

EC_x

EC_x-values, including their associated lower and upper confidence limits, are calculated using appropriate statistical methods (e.g. logistic or Weibull function, trimmed Spearman-Kärber method, or simple interpolation). To compute the EC₁₀, EC₅₀ or any other EC_x, the complete data set should be subjected to regression analysis.

NOEC/LOEC

If a statistical analysis is intended to determine the NOEC/LOEC appropriate statistical methods should be used according to OECD Document 54 on the Current Approaches in the Statistical Analysis of Ecotoxicity Data: a Guidance to Application (4). In general, adverse effects of the test chemical compared to the control are investigated using one-tailed hypothesis testing at $p \leq 0,05$.

Normal distribution and variance homogeneity can be tested using an appropriate statistical test, e.g. the Shapiro-Wilk test and Levene test, respectively ($p \leq 0,05$). One-way ANOVA and subsequent multi-comparison tests can be performed. Multiple comparisons (e.g. Dunnett's test) or step-down trend tests (e.g. Williams' test, or stepdown Jonckheere-Terpstra test) can be used to calculate whether there are significant differences ($p \leq 0,05$) between the controls and the various test chemical concentrations (selection of the recommended test according to OECD Guidance Document 54 (4)). Otherwise, non-parametric methods (e.g. Bonferroni-U-test according to Holm or Jonckheere-Terpstra trend test) could be used to determine the NOEC and the LOEC.

Limit test

If a limit test (comparison of control and one treatment only) has been performed and the prerequisites of parametric test procedures (normality, homogeneity) are fulfilled, metric responses can be evaluated by the Student test (t-test). An unequal-variance t-test (such as Welch test) or a non-parametric test such as the Mann-Whitney-U-test may be used, if these requirements are not fulfilled.

To determine significant differences between the controls (control and solvent or dispersant control), the replicates of each control can be tested as described for the limit test. If these tests do not detect significant differences, all control and solvent control replicates may be pooled. Otherwise all treatments should be compared with the solvent control.

▼ M7**Test report**

The test report includes the following:

Test chemical:

- physical nature and relevant physicochemical properties;
- chemical identification data, including purity.

Test species:

- the clone (whether it has been genetically typed), supplier or source (if known) and the culture conditions used. If a different species to *Daphnia magna* is used, this should be reported and justified.

Test conditions:

- test procedure used (e.g. semi-static or flow-through, volume, loading in number of *Daphnia* per litre);
- photoperiod and light intensity;
- test design (e.g. number of replicates, number of parents per replicate);
- details of culture medium used;
- if used, additions of organic material including the composition, source, method of preparation, TOC/COD of stock preparations, estimation of resulting TOC/COD in test medium;
- detailed information on feeding, including amount (in mg C/*daphnia*/day) and schedule (e.g. type of food(s), including, for algae the specific name (species) and, if known, the strain, the culture conditions);
- method of preparation of stock solutions and frequency of renewal (the solvent or dispersant and its concentration should be given, when used).

Results:

- results from any preliminary studies on the stability of the test chemical;
- the nominal test concentrations and the results of all analyses to determine the concentration of the test chemical in the test vessels (see example data sheets in Appendix 5); the recovery efficiency of the method and the limit of determination should also be reported;
- water quality within the test vessels (i.e. pH, temperature and dissolved oxygen concentration, and TOC and/or COD and hardness where applicable) (see example data sheet in Appendix 4);
- the full record of the production of living offspring during the test by each parent animal (see example data sheet in Appendix 4);
- the number of deaths among the parent animals and the day on which they occurred (see example data sheet in Appendix 4);
- the coefficient of variation for control reproductive output (based on total number of living offspring per parent animal alive at the end of the test);
- plot of total number of living offspring produced per parent animal in each replicate excluding any parent animal which may have accidentally or inadvertently died during the test vs. concentration of the test chemical;

▼ M7

- as appropriate plot of total number of living offspring produced per surviving parent animal in each replicate vs. concentration of the test chemical
- where appropriate the Lowest Observed Effect Concentration (LOEC) for reproduction, including a description of the statistical procedures used and an indication of what size of effect could be expected to be detected (a power analysis can be performed before the start of the experiment to provide this) and the No Observed Effect Concentration (NOEC) for reproduction; information on which response variable that has been used for calculating the LOEC and NOEC value (either as total living offspring per maternal organism which did not die accidentally or inadvertently during the test or as total number of living offspring per surviving maternal organism), where appropriate, the LOEC or NOEC for mortality of the parent animals should also be reported;
- where appropriate, the EC_x for reproduction and confidence intervals (e.g. 90 % or 95 %) and a graph of the fitted model used for its calculation, the slope of the concentration-response curve and its standard error;
- other observed biological effects or measurements: report any other biological effects which were observed or measured (e.g. growth of parent animals) including any appropriate justification;
- an explanation for any deviation from the test method.

LITERATURE:

- (1) OECD Test Guidelines Programme. Report of the Workshop on the *Daphnia magna* Pilot Ring Test, Sheffield University, U.K., 20-21 March 1993.
- (2) OECD (1997). Report of the Final Ring Test of the *Daphnia magna* Reproduction Test. Environmental Health and Safety Publications, Series on Testing and Assessment No.6. OECD, Paris.
- (3) OECD (2008). Validation report for an enhancement of OECD TG 211 *Daphnia magna* reproduction test. Environmental Health and Safety Publications, Series on Testing and Assessment, No.88. OECD, Paris.
- (4) OECD (2006). Current approaches in the statistical analysis of ecotoxicity data: a guidance to application. Environmental Health and Safety Publications, Series on Testing and Assessment Number 54. OECD, Paris.
- (5) Baird, D.J., *et al.* (1991). A comparative study of genotype sensitivity to acute toxic stress using clones of *Daphnia magna* Straus. *Ecotox. and Environ. Safety*, 21, 257-265.
- (6) Elendt, B.-P. (1990). Selenium deficiency in Crustacea; An ultrastructural approach to antennal damage in *Daphnia magna* Straus. *Protoplasma*, 154, 25-33.
- (7) EPA (2002). Methods for Measuring the Acute Toxicity of Effluents and Receiving Waters to Freshwater and Marine Organisms. Fifth Edition. EPA/821/R-02/012. U.S. Environmental Protection Agency, Office of Water, Washington, DC. www.epa.gov/waterscience/methods
- (8) Vigano, L. (1991). Suitability of commercially available spring waters as standard medium for culturing *Daphnia magna*. *Bull. Environ. Contam. Toxicol.*, 47, 775-782.
- (9) ASTM. (2008) Standard Guide for Conducting Acute Toxicity Tests with Fishes, Macroinvertebrates, and Amphibians. In: Annual Book of ASTM Standards; Water and Environmental Technology, vol. 11.04; ASTM E729 — 96 (2007) American Society for Testing and Materials, Philadelphia, PA
- (10) Baird, D.J., *et al.* (1989). The long term maintenance of *Daphnia magna* Straus for use in ecotoxicological tests; problems and prospects. In: Proceedings of the 1st European Conference on Ecotoxicology. Copenhagen 1988. (H. Løkke, H. Tyle and F. Bro-Rasmussen. Eds.) pp 144-148.

▼M7

- (11) Parkhurst, B.R., J.L. Forte. And G.P. and Wright (1981) Reproducibility of a life-cycle toxicity test with *Daphnia magna*. Bull. Environ. Contam. and Toxicol., 26: 1-8.
- (12) Cowgill, U.M. and Milazzo, D.P. (1990). The sensitivity of two cladocerans to water quality variables: salinity and hardness. Arch. Hydrobiol., 120 (2): 185-196.
- (13) OECD (2000), *Guidance Document on Aquatic Toxicity Testing of Difficult Substances and Mixtures*, Environmental Health and Safety Publications, Series on Testing and Assessment No. 23. OECD, Paris.
- (14) Sims, I.R., S. Watson. and D. Holmes (1993) Toward a standard *Daphnia* juvenile production test. Environ. Toxicol. and Chem., 12, 2053-2058.
- (15) Sims, I. (1993). Measuring the growth of phytoplankton: the relationship between total organic carbon with three commonly used parameters of algal growth. Arch. Hydrobiol., 128, 459-466.

▼ M7*Appendix 1*

DEFINITIONS:

For the purposes of this test method the following definitions are used:

Accidental mortality: non chemical related mortality caused by an accidental incidence (i.e. known cause).

Chemical: a substance or mixture.

ECx: the concentration of the test chemical dissolved in water that results in a x per cent reduction in reproduction of *Daphnia* within a stated exposure period.

Inadvertent mortality: non chemical related mortality with no known cause.

Intrinsic rate of population increase: a measure of population growth which integrates reproductive output and age-specific mortality (1) (2) (3). In steady state populations it will be zero. For growing populations it will be positive and for shrinking populations it will be negative. Clearly the latter is not sustainable and ultimately will lead to extinction.

Limit of detection: the lowest concentration that can be detected but not quantified.

Limit of determination: the lowest concentration that can be measured quantitatively.

Lowest Observed Effect Concentration (LOEC): the lowest tested concentration at which the chemical is observed to have a statistically significant effect on reproduction and parent mortality (at $p < 0,05$) when compared with the control, within a stated exposure period. However, all test concentrations above the LOEC should have a harmful effect equal to or greater than those observed at the LOEC. When these two conditions cannot be satisfied, a full explanation should be given for how the LOEC (and hence the NOEC) has been selected.

Mortality: an animal is recorded as dead when it is immobile, i.e. when it is not able to swim, or if there is no observed movement of appendages or post-abdomen, within 15 seconds after gentle agitation of the test container. (If another definition is used, this should be reported together with its reference).

No Observed Effect Concentration (NOEC): the test concentration immediately below the LOEC, which when compared with the control, has no statistically significant effect ($p < 0,05$), within a stated exposure period.

Offspring: the young *Daphnia* produced by the parent animals in the course of the test.

Parent Animals: those female *Daphnia* present at the start of the test and of which the reproductive output is the object of study.

Reproductive output: the number of living offspring produced by parental animals within the test period

Test chemical: any substance or mixture tested using this test method.

LITERATURE

- (1) Wilson, E.O. and Bossert, W.H. (1971). A Primer of Population Biology. Sinauer Associates Inc. Publishers.

▼ M7

- (2) Poole, R.W. (1974). *An Introduction to quantitative Ecology*. Mc Graw Hill Series in Population Biology, New York, p 532.
- (3) Meyer, J. S., Ingersoll, C. G., McDonald, L.L. and Boyce, M.S. (1986). Estimating uncertainty in population growth rates: Jackknife vs bootstrap techniques. *Ecology*, 67, 1156-1166.

▼ **M7***Appendix 2***PREPARATION OF FULLY DEFINED ELENDT M7 AND M4 MEDIA****Acclimation to Elendt M7 and M4 media**

Some laboratories have experienced difficulty in directly transferring *Daphnia* to M4 (1) and M7 media. However, some success has been achieved with gradual acclimation, i.e. moving from own medium to 30 % Elendt, then to 60 % Elendt and then to 100 % Elendt. The acclimation periods may need to be as long as one month.

Preparation*Trace elements*

Separate stock solutions (I) of individual trace elements are first prepared in water of suitable purity, e.g. deionised, distilled or reverse osmosis. From these different stock solutions (I) a second single stock solution (II) is prepared, which contains all trace elements (combined solution), i.e.:

Stock solution(s) I (single substance)	Amount added to water	Concentration (related to medium M4)	To prepare the combined stock-solution II add the following amount of stock solution I to water	
			ml/l	
	mg/l		M 4	M 7
H ₃ BO ₃	57 190	20 000-fold	1,0	0,25
MnCl ₂ · 4 H ₂ O	7 210	20 000-fold	1,0	0,25
LiCl	6 120	20 000-fold	1,0	0,25
RbCl	1 420	20 000-fold	1,0	0,25
SrCl ₂ · 6 H ₂ O	3 040	20 000-fold	1,0	0,25
NaBr	320	20 000-fold	1,0	0,25
Mo Na ₂ O ₄ · 2 H ₂ O	1 260	20 000-fold	1,0	0,25
CuCl ₂ · 2 H ₂ O	335	20 000-fold	1,0	0,25
ZnCl ₂	260	20 000-fold	1,0	1,0
CoCl ₂ · 6 H ₂ O	200	20 000-fold	1,0	1,0
KI	65	20 000-fold	1,0	1,0
Na ₂ SeO ₃	43,8	20 000-fold	1,0	1,0
NH ₄ VO ₃	11,5	20 000-fold	1,0	1,0
Na ₂ EDTA · 2 H ₂ O	5 000	2 000-fold	—	—
FeSO ₄ · 7 H ₂ O	1 991	2 000-fold	—	—

Both Na₂EDTA and FeSO₄ solutions are prepared singly, poured together and autoclaved immediately. This gives:

Fe-EDTA solution		1 000-fold	20,0	5,0
------------------	--	------------	------	-----

▼ **M7***M4 and M7 media*

M4 and M7 media are prepared using stock solution II, the macro-nutrients and vitamins as follows:

	Amount added to water	Concentration (related to medium M4)	Amount of stock solution added to prepare medium	
	mg/l		ml/l	
			M 4	M 7
Stock solution II (combined trace elements)		20-fold	50	50
Macro nutrient stock solutions (single substance)				
CaCl ₂ · 2 H ₂ O	293 800	1 000-fold	1,0	1,0
MgSO ₄ · 7 H ₂ O	246 600	2 000-fold	0,5	0,5
KCl	58 000	10 000-fold	0,1	0,1
NaHCO ₃	64 800	1 000-fold	1,0	1,0
Na ₂ SiO ₃ · 9 H ₂ O	50 000	5 000-fold	0,2	0,2
NaNO ₃	2 740	10 000-fold	0,1	0,1
KH ₂ PO ₄	1 430	10 000-fold	0,1	0,1
K ₂ HPO ₄	1 840	10 000-fold	0,1	0,1
Combined Vitamin stock	—	10 000-fold	0,1	0,1

The combined vitamin stock solution is prepared by adding the 3 vitamins to 1 litre water, as shown below:

	mg/l			
Thiamine hydrochloride	750	10 000-fold		
Cyanocobalamine (B ₁₂)	10	10 000-fold		
Biotine	7,5	10 000-fold		

The combined vitamin stock is stored frozen in small aliquots. Vitamins are added to the media shortly before use.

N.B.: To avoid precipitation of salts when preparing the complete media, add the aliquots of stock solutions to about 500 - 800 ml deionized water and then fill it up to 1 litre.

N.N.B. The first publication of the M4 medium can be found in Elendt, B.P. (1990). Selenium deficiency in crustacea; an ultrastructural approach to antennal damage in *Daphnia magna* Straus. *Protoplasma*, 154, 25-33.

▼ M7

Appendix 3

TOTAL ORGANIC CARBON (TOC) ANALYSIS AND PRODUCTION OF A NOMOGRAPH FOR TOC CONTENT OF ALGAL FEED

It is recognised that the carbon content of the algal feed will not normally be measured directly but from correlations (i.e. nomographs) with surrogate measures such as algal cell number or light absorbance).

TOC should be measured by high temperature oxidation rather than by UV or persulphate methods. (For advice see: The Instrumental Determination of Total Organic Carbon, Total Oxygen Demand and Related Determinands 1979, HMSO 1980; 49 High Holborn, London WC1V 6HB).

For nomograph production, algae should be separated from the growth medium by centrifugation followed by resuspension in distilled water. Measure the surrogate parameter and TOC concentration in each sample in triplicate. Distilled water blanks should be analysed and the TOC concentration deducted from that of the algal sample TOC concentration.

Nomographs should be linear over the required range of carbon concentrations. Examples are shown below.

N.B. These should not be used for conversions; it is essential that laboratories prepare their own nomographs.

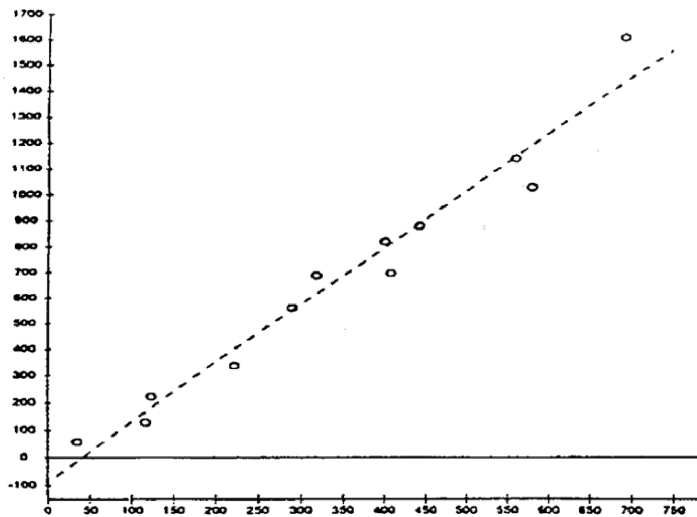

Chlorella vulgaris var. *viridis* (CCAP 211/12).

Regression of mg/l dry weight on mg C/l. Data from concentrated suspensions of semi continuous batch cultured cells, re-suspended in distilled water.

x-axis: mg C/l of concentrated algal feed

y-axis: mg/l dry weight of concentrated algal feed

Correction coefficient – 0,980

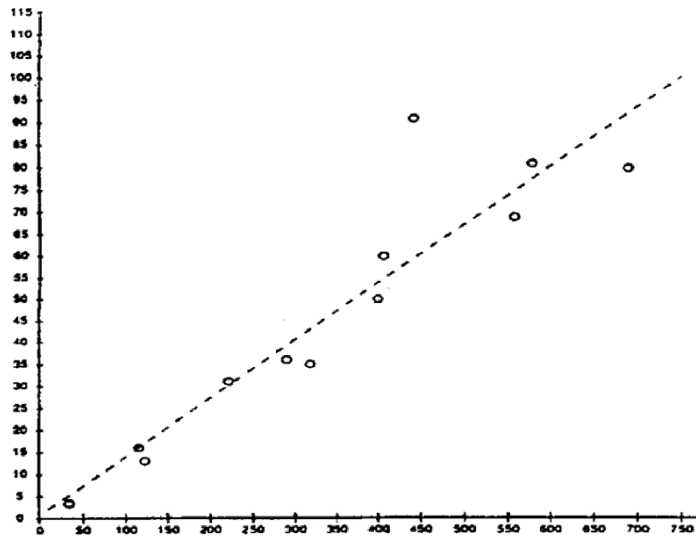
▼ M7

Chlorella vulgaris var. *viridis* (CCAP 211/12).

Regression of cell number on mg C/l. Data from concentrated suspensions of semi continuous batch cultured cells, re-suspended in distilled water.

x-axis: mg C/l of concentrated algal feed

y-axis: No. cells/l of concentrated algal feed

Correction coefficient – 0,926

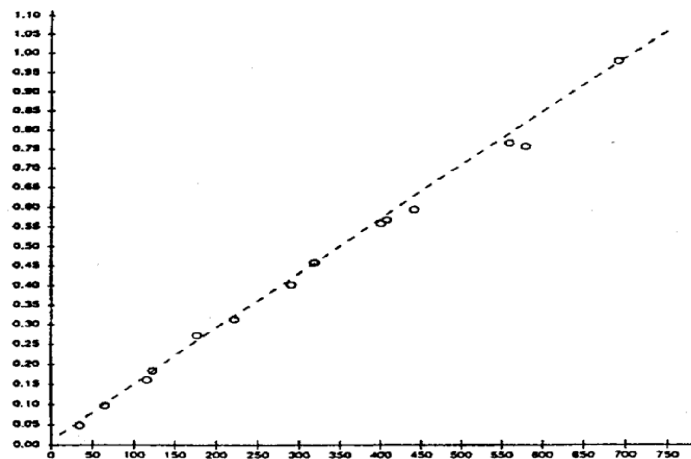

Chlorella vulgaris var. *viridis* (CCAP 211/12).

Regression of absorbance on mg C/l (1 cm path length). Data from concentrated suspensions of semi continuous batch cultured cells, re-suspended in distilled water.

x-axis: mg C/l of concentrated algal feed

y-axis: Absorbance at 440 nm of a 1/10 dilution of concentrated algal feed

Correction coefficient – 0,998

EXAMPLE DATA SHEET FOR RECORDING MEDIUM RENEWAL, PHYSICAL/CHEMICAL MONITORING DATA, FEEDING, DAPHNIA REPRODUCTION AND PARENT MORTALITY

Experiment No:	Date started:					Clone:			Medium:					Type of food:				Test Chemical:				Nominal conc:		
Day	0	1	2	3	4	5	6	7	8	9	10	11	12	13	14	15	16	17	18	19	20	21		
Medium renewal (tick)																								
pH (*)																								new
																								old
O ₂ (mg/l) (*)																								new
																								old
Temp (°C) (*)																								new
																								old
Food provided (tick)																								
No. live offspring (**)																								Total
Vessel 1																								
2																								
3																								
4																								
5																								

▼ M7

Appendix 6

CALCULATION OF A TIME-WEIGHTED MEAN

Time-weighted mean

Given that the concentration of the test chemical can decline over the period between medium renewals, it is necessary to consider what concentration should be chosen as representative of the range of concentrations experienced by the parent *Daphnia*. The selection should be based on biological considerations as well as statistical ones. For example, if reproduction is thought to be affected mostly by the peak concentration experienced, then the maximum concentration should be used. However, if the accumulated or longer term effect of the toxic chemical is considered to be more important, then an average concentration is more relevant. In this case, an appropriate average to use is the time-weighted mean concentration, since this takes account of the variation in instantaneous concentration over time.

Figure 1

Example of time-weighted mean

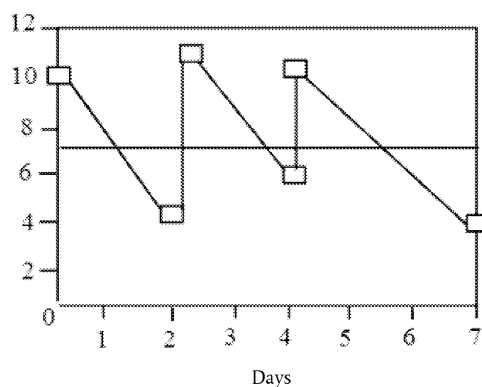

Figure 1 shows an example of a (simplified) test lasting seven days with medium renewal at Days 0, 2 and 4.

- The thin zig-zag line represents the concentration at any point in time. The fall in concentration is assumed to follow an exponential decay process.
- The 6 plotted points represent the observed concentrations measured at the start and end of each renewal period.
- The thick solid line indicates the position of the time-weighted mean.

The time-weighted mean is calculated so that the area under the time-weighted mean is equal to the area under the concentration curve. The calculation for the above example is illustrated in Table 1.

Table 1

Calculation of Time-weighted mean

Renewal No.	Days	Conc 0	Conc 1	Ln(Conc 0)	Ln(Conc 1)	Area
1	2	10,000	4,493	2,303	1,503	13,767
2	2	11,000	6,037	2,398	1,798	16,544
3	3	10,000	4,066	2,303	1,403	19,781

▼ **M7**

Renewal No.	Days	Conc 0	Conc 1	Ln(Conc 0)	Ln(Conc 1)	Area
Total Days:	7					Total Area: 50,092
						TW Mean: 7,156

Days is the number of days in the renewal period

Conc 0 is the measured concentration at the start of each renewal period

Conc 1 is the measured concentration at the end of each renewal period

$\ln(\text{Conc } 0)$ is the natural logarithm of Conc 0

$\ln(\text{Conc } 1)$ is the natural logarithm of Conc 1

Area is the area under the exponential curve for each renewal period. It is calculated by:

$$\text{Area} = \frac{\text{Conc } 0 - \text{Conc } 1}{\ln(\text{Conc } 0) - \ln(\text{Conc } 1)} \times \text{Day}$$

The time-weighted mean (*TW Mean*) is the *Total Area* divided by the *Total Days*.

Of course, for the *Daphnia* reproduction test the table should be extended to cover 21 days.

It is clear that when observations are taken only at the start and end of each renewal period, it is not possible to confirm that the decay process is, in fact, exponential. A different curve would result in a different calculation for *Area*. However, an exponential decay process is not implausible and is probably the best curve to use in the absence of other information.

However, a word of caution is required if the chemical analysis fails to find any chemical at the end of the renewal period. Unless it is possible to estimate how quickly the chemical disappeared from the solution, it is impossible to obtain a realistic area under the curve, and hence it is impossible to obtain a reasonable time-weighted mean.

▼ M7

Appendix 7

GUIDANCE FOR THE IDENTIFICATION OF NEONATE SEX

Production of male neonates can occur under changing environmental conditions, such as shortening photoperiod, temperature, decreasing food concentration, and increasing population density (Hobaek and Larson, 1990; Kleiven *et al.*, 1992). Male production is also a known response to certain insect growth regulators (Oda *et al.*, 2005). Under conditions where chemical stressors are inducing a decrease in reproductive offspring from the parthenogenic females, an increased number of males would be expected (OECD, 2008). On the basis of available information, it is not possible to predict which of the sex ratio or of the reproduction endpoint will be more sensitive; however, there are indications (reference 'validation report', part 1) this increase in the number of males might be less sensitive than the decrease in offspring. Since the primary purpose of the test method is to assess the number of offspring produced, the appearance of males is an optional observation. If this optional endpoint is evaluated in a study, then an additional test validity criterion of no more than 5 % males in the controls should be employed.

The most practical and easy way to differentiate sex of *Daphnia* is to use their phenotypic characteristics, as males and females are genetically identical and their sex is environmentally determined. Males and females are different in the length and morphology of the first antennae, which are longer in males than females (Fig. 1). This difference is recognizable right after birth, although other secondary sex characteristics develop as they grow up (e.g. see Fig. 2 in Olmstead and LeBlanc, 2000).

To observe the morphological sex, neonates produced by each test animal should be transferred by pipet and placed into a petri dish with test medium. The medium is kept to a minimum to restrain movement of the animals. Observation of the first antennae can be conducted under a stereomicroscope ($\times 10$ -60).

Figure 1

24-hour-old male (left) and female (right) of *D. magna*. Males can be distinguished from females by the length and morphology of the first antennae as shown in the circles (Tatarazako *et al.*, 2004)

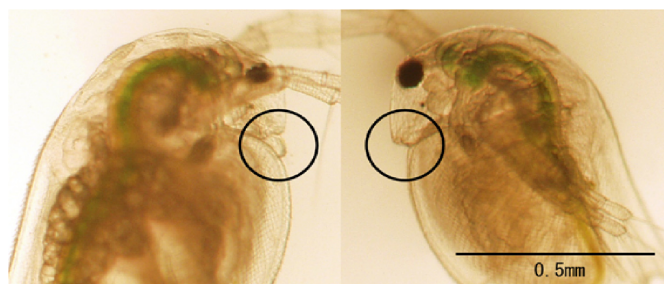

REFERENCES:

Hobaek A and Larson P. 1990. Sex determination in *Daphnia magna*. Ecology 71: 2255-2268.

Kleiven O.T., Larsson P., Hobaek A. 1992. Sexual reproduction in *Daphnia magna* requires three stimuli. Oikos 65, 197-206.

Oda S., Tatarazako N, Watanabe H., Morita M., and Iguchi T. 2005. Production of male neonates in *Daphnia magna* (Cladocera, Crustacea) exposed to juvenile hormones and their analogs. Chemosphere 61:1168-1174.

▼ M7

OECD, 2008. Validation report for an enhancement of OECD TG 211 *Daphnia magna* reproduction test. OECD Series on Testing and Assessment, Number 88. Organisation for Economic Co-operation and Development, Paris.

Olmstead, A.W., LeBlanc, G.A., 2000. Effects of endocrine-active chemicals on the development characteristics of *Daphnia magna*. Environmental Toxicology and Chemistry 19:2107-2113.

Tatarazako, N., Oda, S., Abe, R., Morita M. and Iguchi T., 2004. Development of a screening method for endocrine disruptors in crustaceans using *Daphnia magna* (Cladocera, Crustacea). Environmental Science 17, 439-449.

▼ B**C.21. SOIL MICROORGANISMS: NITROGEN TRANSFORMATION TEST****1. METHOD**

This test method is a replicate of OECD TG 216 (2000).

1.1. INTRODUCTION

This testing method describes a laboratory method designed to investigate the long-term effects of chemicals, after a single exposure, on nitrogen transformation activity of soil microorganisms. The test is principally based on the recommendations of the European and Mediterranean Plant Protection Organization (1). However, other guideline, including those of the German Biologische Bundesanstalt (2), the US Environmental Protection Agency (3) SETAC (4) and the International Organization for Standardization (5), were also taken into account. An OECD workshop on soil/sediment selection held at Belgirate, Italy, in 1995 (6) agreed on the number and type of soils for use in this test. Recommendations for collection, handling and storage of soil sample are based on an ISO Guidance Document (7) and recommendations from the Belgirate workshop. In the assessment and evaluation of toxic characteristics of test substances, determination of effects on soil microbial activity may be required, e.g. when data on the potential side effects of crop protection products on soil microflora are required or when exposure of soil microorganisms to chemicals other than crop protection products is expected. The nitrogen transformation test is carried out to determine the effects of such chemicals on soil microflora. If agrochemicals (e.g. crop protection products, fertilisers, forestry chemicals) are tested, both nitrogen transformation and carbon transformation tests are conducted. If non-agrochemicals are tested, the nitrogen transformation test is sufficient. However, if EC₅₀ values of the nitrogen transformation test for such chemicals fall within the range found for commercially available nitrification inhibitors (e.g. nitrapyrin), a carbon transformation test can be conducted to gain further information.

Soils consist of living and non-living components which exist in complex and heterogeneous mixtures. Microorganisms play an important role in break-down and transformation of organic matter in fertile soils with many species contributing to different aspects of soil fertility. Any long-term interference with these biochemical processes could potentially interfere with nutrient cycling and this could alter soil fertility. Transformation of carbon and nitrogen occurs in all fertile soils. Although the microbial communities responsible for these processes differ from soil to soil, the pathways of transformation are essentially the same.

This testing method described is designed to detect long-term adverse effects of a substance on the process of nitrogen transformation in aerobic surface soils. The test method also allows estimation of the effects of substances on carbon transformation by the soil microflora. Nitrate formation takes place subsequent to the degradation of carbon-nitrogen bonds. Therefore, if equal rates of nitrate production are found in treated and control soils, it is highly probable that the major carbon degradation pathways are intact and functional. The substrate chosen for the test (powdered lucerne meal) has a favourable carbon to nitrogen ratio (usually between 12/1 and 16/1). Because of this, carbon starvation is reduced during the test and if microbial communities are damaged by a chemical, they might recover within 100 days.

▼ B

The tests from which this testing method was developed were primarily designed for substances for which the amount reaching the soil can be anticipated. This is the case, for example, for crop protection products for which the application rate in the field is known. For agrochemicals, testing of two doses relevant to the anticipated or predicted application rate is sufficient. Agrochemicals can be tested as active ingredients (a.i.) or as formulated products. However, the test is not limited to agrochemicals. By changing both the amounts of test substance applied to the soil, and the way in which the data are evaluated, the test can also be used for chemicals for which the amount expected to reach the soil is not known. Thus, with chemicals other than agrochemicals, the effects of a series of concentrations on nitrogen transformation are determined. The data from these tests are used to prepare a dose-response curve and calculate EC_x values, where x is defined % effect.

1.2. DEFINITIONS

Nitrogen transformation: is the ultimate degradation by microorganisms of nitrogen-containing organic matter, via the process of ammonification and nitrification, to the respective inorganic end-product nitrate.

EC_x (effective concentration): is the concentration of the test substance in soil that results in a x percent inhibition of nitrogen transformation to nitrate.

EC_{50} (median effective concentration): is the concentration of the test substance in soil that results in a 50 percent (50 %) inhibition of nitrogen transformation to nitrate.

1.3. REFERENCE SUBSTANCES

None.

1.4. PRINCIPLE OF THE TEST METHOD

Sieved soil is amended with powdered plant meal and either treated with the test substance or left untreated (control). If agrochemicals are tested, a minimum of two test concentrations are recommended and these should be chosen in relation to the highest concentration anticipated in the field. After 0, 7, 14 days and 28 days of incubation, samples of treated and control soils are extracted with an appropriate solvent, and the quantities of nitrate in the extracts are determined. The rate of nitrate formation in treated samples is compared with the rate in the controls, and the percent deviation of the treated from the control is calculated. All tests run for at least 28 days. If, on the 28th day, differences between treated and untreated soils are equal to or greater than 25 %, measurements are continued to a maximum of 100 days. If non-agrochemicals are tested, a series of concentrations of the test substance are added to samples of the soil, and the quantities of nitrate formed in treated and control samples are measured after 28 days of incubation. Results from tests with multiple concentrations are analysed using a regression model, and the EC_x values are calculated (i.e. EC_{50} , EC_{25} and/or EC_{10}). See definitions.

1.5. VALIDITY OF THE TEST

Evaluations of test results with agrochemicals are based on relatively small differences (i.e. average value ± 25 %) between nitrate concentrations in control and treated soil samples, so large variations in the controls can lead to false results. Therefore, the variation between replicate control samples should be less than ± 15 %.

▼ B

1.6. DESCRIPTION OF THE TEST METHOD

1.6.1. **Apparatus**

Test containers made of chemically inert material are used. They should be of a suitable capacity in compliance with the procedure used for incubation of soils, i.e. incubation in bulk or as a series of individual soil samples (see Section 1.7.1.2). Care should be taken both to minimise water loss and to allow gas exchange during the test (e.g. the test containers may be covered with perforated polyethylene foil). When volatile substances are tested, sealable and gas-tight containers should be used. These should be of a size such that approximately one quarter of their volume is filled with the soil sample.

Standard laboratory equipment including the following is used:

- agitation device: mechanical shaker or equivalent equipment;
- centrifuge (3 000 g) or filtration device (using nitrate-free filter paper);
- instrument of adequate sensitivity and reproducibility for nitrate analysis.

1.6.2. **Selection and number of soils**

One single soil is used. The recommended soil characteristics are as follows:

- sand content: not less than 50 % and not greater than 75 %,
- pH: 5,5-7,5,
- organic carbon content: 0,5-1,5 %,
- the microbial biomass should be measured (8)(9) and its carbon content should be at least 1 % of the total soil organic carbon.

In most cases, a soil with these characteristics represents a worst case situation, since adsorption of the test chemical is minimum and its availability to the microflora is maximum. Consequently, tests with other soils are generally unnecessary. However, in certain circumstances, e.g. where the anticipated major use of the test substance is in particular soils such as acidic forest soils, or for electrostatically charged chemicals, it may be necessary to use an additional soil.

▼ B**1.6.3. Collection and storage of soil samples****1.6.3.1. Collection**

Detailed information on the history of the field site from where the test soil is collected should be available. Details include exact location, vegetation cover, dates of treatments with crop protection products, treatments with organic and inorganic fertilisers, additions of biological materials or accidental contaminations. The site chosen for soil collection should be one which allows long-term use. Permanent pastures, fields with annual cereal crops (except maize) or densely sown green manures are suitable. The selected sampling site should not have been treated with crop protection products for a minimum of one year before sampling. Also, no organic fertiliser should have been applied for at least six months. The use of mineral fertiliser is only acceptable when in accordance with the requirements of the crop and soil samples should not be taken until at least three months after fertiliser application. The use of soil treated with fertilisers with known biocidal effects (e.g. calcium cyanamide) should be avoided.

Sampling should be avoided during or immediately following long periods (greater than 30 days) of drought or water logging. For ploughed soils, samples should be taken from a depth of 0 down to 20 cm. For grassland (pasture) or other soils where ploughing does not occur over longer periods (at least one growing season), the maximum depth of sampling may be slightly more than 20 cm (e.g. to 25 cm).

Soil samples should be transported using containers and under temperature conditions which guarantee that the initial soil properties are not significantly altered.

1.6.3.2. Storage

The use of soils freshly collected from the field is preferred. If storage in the laboratory cannot be avoided, soils may be stored in the dark at 4 ± 2 °C for a maximum of three months. During the storage of soils, aerobic conditions must be ensured. If soils are collected from areas where they are frozen for at least three months per year, storage for six months at minus 18 °C to minus 22 °C can be considered. The microbial biomass of stored soils is measured prior to each experiment and the carbon in the biomass should be at least 1 % of the total soil organic carbon content (see Section 1.6.2).

1.6.4. Handling and preparation of soil for the test**1.6.4.1. Pre-incubation**

If the soil was stored (see Section 1.6.3.2), pre-incubation is recommended for a period between two and 28 days. The temperature and moisture content of the soil during pre-incubation should be similar to that used in the test (see Sections 1.6.4.2 and 1.7.1.3).

▼ B1.6.4.2. *Physical-chemical characteristics*

The soil is manually cleared of large objects (e.g. stones, parts of plants, etc.) and then moist sieved without excess drying to a particle size less than or equal to 2 mm. The moisture content of the soil sample should be adjusted with distilled or deionised water to a value between 40 % and 60 % of the maximum water holding capacity.

1.6.4.3. *Amendment with organic substrate*

The soil should be amended with a suitable organic substrate, e.g. powdered lucerne-grass-green meal (main component: *Medicago sativa*) with a C/N ratio between 12/1 and 16/1. The recommended lucerne-soil ratio is 5 g of lucerne per kilogram of soil (dry weight).

1.6.5. **Preparation of the test substance for the application to soil**

The test substance is normally applied using a carrier. The carrier can be water (for water soluble substances) or an inert solid such as fine quartz sand (particle size: 0,1-0,5mm). Liquid carriers other than water (e.g. organic solvents such as acetone, chloroform) should be avoided since they can damage the microflora. If sand is used as a carrier, it can be coated with the test substance dissolved or suspended in an appropriate solvent. In such cases, the solvent should be removed by evaporation before mixing with the soil. For an optimum distribution of the test substance in soil, a ratio of 10 g of sand per kilogram of soil (dry weight) is recommended. Control samples are treated with an equivalent amount of water and/or quartz sand only.

When testing volatile chemicals, losses during treatment should be avoided as far as possible and an attempt should be made to ensure homogeneous distribution in the soil (e.g. the test substance should be injected into the soil at several places).

1.6.6. **Test concentrations**

If agrochemicals are tested, at least two concentrations should be used. The lower concentration should reflect at least the maximum amount expected to reach the soil under practical conditions whereas the higher concentration should be a multiple of the lower concentration. The concentrations of test substance added to soil are calculated assuming uniform incorporation to a depth of 5 cm and a soil bulk density of 1,5. For agrochemicals that are applied directly to soil, or for chemicals for which the quantity reaching the soil can be predicted, the test concentrations recommended are the maximum Predicted Environmental Concentration (PEC) and five times that concentration. Substances that are expected to be applied to soils several times in one season should be tested at concentrations derived from multiplying the PEC by the maximum anticipated number of applications. The upper concentration tested, however, should not exceed 10 times the maximum single application rate. If non-agrochemicals are tested, a geometric series of at least five concentrations is used. The concentrations tested should cover the range needed to determine the EC_x values.

▼B

1.7. PERFORMANCE OF THE TEST

1.7.1. **Conditions of exposure**1.7.1.1. *Treatment and control*

If agrochemicals are tested, the soil is divided into three portions of equal weight. Two portions are mixed with the carrier containing the product, and the other is mixed with the carrier without the product (control). A minimum of three replicates for both treated and untreated soils is recommended. If non-agrochemicals are tested, the soil is divided into six portions of equal weight. Five of the samples are mixed with the carrier containing the test substance, and the sixth sample is mixed with the carrier without the chemical. Three replicates for both treatments and control are recommended. Care should be taken to ensure homogeneous distribution of the test substance in the treated soil samples. During mixing, compacting or balling of the soil should be avoided.

1.7.1.2. *Incubation of soil samples*

Incubation of soil samples can be performed in two ways: as bulk samples of each treated and untreated soil or as a series of individual and equally sized subsamples of each treated and untreated soil. However, when volatile substances are tested, the test should only be performed with a series of individual subsamples. When soils are incubated in bulk, large quantities of each treated and untreated soils are prepared and subsamples to be analysed are taken as needed during the test. The amount initially prepared for each treatment and control depends on the size of the subsamples, the number of replicates used for analysis and the anticipated maximum number of sampling times. Soils incubated in bulk should be thoroughly mixed before subsampling. When soils are incubated as a series of individual soil samples, each treated and untreated bulk soil is divided into the required number of subsamples, and these are utilised as needed. In the experiments where more than two sampling times can be anticipated, enough subsamples should be prepared to account for all replicates and all sampling times. At least three replicate samples of the test soil should be incubated under aerobic conditions (see Section 1.7.1.1). During all tests, appropriate containers with sufficient headspace should be used to avoid development of anaerobic conditions. When volatile substances are tested, the test should only be performed with a series of individual subsamples.

1.7.1.3. *Test conditions and duration*

The test is carried out in the dark at room temperature of 20 ± 2 °C. The moisture content of soil samples should be maintained during the test between 40 % and 60 % of the maximum water holding capacity of the soil (see Section 1.6.4.2) with a range of ± 5 %. Distilled, deionised water can be added as needed.

The minimum duration of tests is 28 days. If agrochemicals are tested, the rates of nitrate formation in treated and control samples are compared. If these differ by more than 25 % on day 28, the test is continued until a difference equal to or less than 25 % is obtained, or for a maximum of 100 days, whichever is shorter. For non-agrochemicals, the test is terminated after 28 days. On day 28, the quantities of nitrate in treated and control soil samples are determined and the EC_x values are calculated.

▼B**1.7.2. Sampling and analysis of soils****1.7.2.1. Soil sampling schedule**

If agrochemicals are tested, soil samples are analysed for nitrate on days 0, 7, 14 and 28. If a prolonged test is required, further measurements should be made at 14 days intervals after day 28.

If non-agrochemicals are tested, at least five test concentrations are used and soil samples are analysed for nitrate at the beginning (day 0) and at the end of the exposure period (28 days). An intermediate measurement, e.g. at day 7, may be added if deemed necessary. The data obtained on day 28 are used to determine EC_x value for the chemical. If desired, data from day 0 control samples can be used to report the initial quantity of nitrate in the soil.

1.7.2.2. Analysis of soil samples

The amount of nitrate formed in each treated and control replicate is determined at each sampling time. Nitrate is extracted from soil by shaking samples with a suitable extraction solvent, e.g. a 0,1 M potassium chloride solution. A ratio of 5 ml of KCl solution per gram dry weight equivalent of soil is recommended. To optimise extraction, containers holding soil and extraction solution should not be more than half full. The mixtures are shaken at 150 rpm for 60 minutes. The mixtures are centrifuged or filtered and the liquid phases are analysed for nitrate. Particle-free liquid extracts can be stored prior to analysis at minus 20 ± 5 °C for up to six months.

2. DATA**2.1. TREATMENT OF RESULTS**

If tests are conducted with agrochemicals, the quantity of nitrate formed in each replicate soil sample should be recorded, and the mean values of all replicates should be provided in tabular form. Nitrogen transformation rates should be evaluated by appropriate and generally acceptable statistical methods (e.g. F-test, 5 % significance level). The quantities of nitrate formed are expressed in mg nitrate/kg dry weight soil/day. The nitrate formation rate in each treatment is compared with that in the control, and the percent deviation from the control is calculated.

If tests are conducted with non-agrochemicals, the quantity of nitrate formed in each replicate is determined, and a dose-response curve is prepared for estimation of the EC_x values. The quantities of nitrate (i.e. mg nitrate/kg dry weight soil) found in the treated samples after 28 days are compared to that found in the control. From these data, the % inhibition values for each test concentration are calculated. These percentages are plotted against concentration, and statistical procedures are then used to calculate the EC_x values. Confidence limits ($p = 0,95$) for the calculated EC_x are also determined using standard procedures (10)(11)(12).

Test substances that contain high quantities of nitrogen may contribute to the quantities of nitrate formed during the test. If these substances are tested at a high concentration (e.g. chemicals which are expected to be used in repeated applications) appropriate controls must be included in the test (i.e. soil plus test substance but without plant meal). Data from these controls must be accounted for in the EC_x calculations.

▼ B**2.2. INTERPRETATION OF RESULTS**

When results from tests with agrochemicals are evaluated, and the difference in the rates of nitrate formation between the lower treatment (i.e. the maximum predicted concentration) and control is equal to or less than 25 % at any sampling time after day 28, the product can be evaluated as having no long-term influence on nitrogen transformation in soils. When results from tests with chemicals other than agrochemicals are evaluated, the EC₅₀, EC₂₅ and/or EC₁₀ values are used.

3. REPORTING

The test report must include the following information:

Complete identification of the soil used including:

- geographical reference of the site (latitude, longitude),
- information on the history of the site (i.e. vegetation cover, treatments with crop protection products, treatments with fertilisers, accidental contamination, etc.),
- use pattern (e.g. agricultural soil, forest, etc.),
- depth of sampling (cm),
- sand/silt/clay content (% dry weight),
- pH (in water),
- organic carbon content (% dry weight),
- nitrogen content (% dry weight),
- initial nitrate concentration (mg nitrate/kg dry weight),
- cation exchange capacity (mmol/kg),
- microbial biomass in terms of percentage of the total organic carbon,
- reference of the methods used for the determination of each parameter,
- all information relating to the collection and storage of soil samples,
- details of pre-incubation of soil if any.

Test substance:

- physical nature and, where relevant, physical-chemical properties,
- chemical identification data, where relevant, including structural formula, purity (i.e. for crop protection products the percentage of active ingredient), nitrogen content.

Substrate:

- source of substrate,
- composition (i.e. lucerne meal, lucerne-grass-green meal),
- carbon, nitrogen content (% dry weight),
- sieve size (mm).

▼ B

Test conditions:

- details of the amendment of soil with organic substrate,
- number of concentrations of test chemical used and, where appropriate, justification of the selected concentrations,
- details of the application of test substance to soil,
- incubation temperature,
- soil moisture content at the beginning and during the test,
- method of soil incubation used (i.e. as bulk or as a series of individual subsamples),
- number of replicates,
- sampling times,
- method used for extraction of nitrate from soil,

Results:

- analytical procedure and equipment used to analyse nitrate,
- tabulated data including individual and mean values for nitrate measurements,
- variation between the replicates in treated and control samples,
- explanations of corrections made in the calculations, if relevant,
- the percent variation in nitrate formation rates at each sampling time or, if appropriate, the EC₅₀ value with 95 % confidence limit, other EC_x (i.e. EC₂₅ or EC₁₀) with confidence intervals, and a graph of the dose-response curve,
- statistical treatment of results,
- all information and observations helpful for the interpretation of the results.

4. REFERENCES

- (1) EPP0, (1994) Decision-Making Scheme for the Environmental Risk Assessment of Plant Protection Chemicals. Chapter 7: Soil Microflora. EPP0 Bulletin 24: 1-16, 1994.
- (2) BBA, (1990) Effects on the Activity of the Soil Microflora. BBA Guidelines for the Official Testing of Plant Protection Products, VI, 1-1 (2nd eds., 1990).
- (3) EPA (1987) Soil Microbial Community Toxicity Test. EPA 40 CFR Part 797.3700. Toxic Substances Control Act Test Guidelines; Proposed rule. September 28, 1987.
- (4) SETAC-Europe, (1995) Procedures for assessing the environmental fate and ecotoxicity of pesticides, Ed. M.R. Lynch, Pub. SETAC-Europe, Brussels.
- (5) ISO/DIS 14238 (1995) Soil Quality — Determination of Nitrogen Mineralisation and Nitrification in Soils and the Influence of Chemicals on these Processes. Technical Committee ISO/TC 190/SC 4: *Soil Quality — Biological Methods*.

▼B

- (6) OECD, (1995) Final Report of the OECD Workshop on Selection of Soils/Sediments, Belgirate, Italy, 18-20 January 1995.
- (7) ISO 10381-6 (1993) Soil quality — Sampling. Guidance on the collection, handling and storage of soil for the assessment of aerobic microbial processes in the laboratory.
- (8) ISO 14240-1, (1997) Soil quality — Determination of soil microbial biomass — Part 1: Substrate-induced respiration method.
- (9) ISO 14240-2, (1997) Soil quality — Determination of soil microbial biomass — Part 2: Fumigation-extraction method.
- (10) Litchfield, J.T. and Wilcoxon F., (1949) A simplified method of evaluating dose-effect experiments. *Jour. Pharmacol. and Exper. Ther.*, 96, p. 99-113.
- (11) Finney, D.J., (1971) *Probit Analysis*. 3rd ed., Cambridge, London and New-York.
- (12) Finney, D.J., (1978) *Statistical Methods in biological Assay*. Griffin, Weycombe, UK.

▼ B**C.22. SOIL MICROORGANISMS: CARBON TRANSFORMATION TEST****1. METHOD**

This method is a replicate of OECD TG 217 (2000).

1.1. INTRODUCTION

This testing method describes a laboratory method designed to investigate long term potential effects of a single exposure of crop protection products and possibly other chemicals on carbon transformation activity of soil microorganisms. The test is principally based on the recommendations of the European and Mediterranean Plant Protection Organization (1). However, other guideline, including those of the German Biologische Bundesanstalt (2), the US Environmental Protection Agency (3) and SETAC (4), were also taken into account. An OECD Workshop on Soil/Sediment Selection held at Belgirate, Italy, in 1995 (5) agreed on the number and type of soils for use in this test. Recommendations for collection, handling and storage of soil sample are based on an ISO Guidance Document (6) and recommendations from the Belgirate Workshop.

In the assessment and evaluation of toxic characteristics of test substances, determination of effects on soil microbial activity may be required, e.g. when data on the potential side effects of crop protection products on soil microflora are required or when exposure of soil microorganisms to chemicals other than crop protection products is expected. The carbon transformation test is carried out to determine the effects of such chemicals on soil microflora. If agrochemicals (e.g. crop protection products, fertilisers, forestry chemicals) are tested, both carbon transformation and nitrogen transformation tests are conducted. If non-agrochemicals are tested, the nitrogen transformation test is sufficient. However, if EC_{50} values of the nitrogen transformation test for such chemicals fall within the range found for commercially available nitrification inhibitors (e.g. nitrapyrin), a carbon transformation test can be conducted to gain further information.

Soils consist of living and non-living components which exist in complex and heterogeneous mixtures. Microorganisms play an important role in breakdown and transformation of organic matter in fertile soils with many species contributing to different aspects of soil fertility. Any long-term interference with these biochemical processes could potentially interfere with nutrient cycling and this could alter the soil fertility. Transformation of carbon and nitrogen occurs in all fertile soils. Although the microbial communities responsible for these processes differ from soil to soil, the pathways of transformation are essentially the same.

▼ B

This testing method is designed to detect long-term adverse effects of a substance on the process of carbon transformation in aerobic surface soils. The test is sensitive to changes in size and activity of microbial communities responsible for carbon transformation since it subjects these communities to both chemical stress and carbon starvation. A sandy soil low in organic matter is used. This soil is treated with the test substance and incubated under conditions that allow rapid microbial metabolism. Under these conditions, sources of readily available carbon in the soil are rapidly depleted. This causes carbon starvation which both kills microbial cells and induces dormancy and/or sporulation. If the test runs for more than 28 days, the sum of these reactions can be measured in (untreated soil) controls as a progressive loss of metabolically active microbial biomass (7). If the biomass in carbon-stressed soil, under the conditions of the test, is affected by the presence of a chemical, it may not return to the same level as the control. Hence, disturbances caused by the test substance at any time during the test will often last until the end of the test.

The tests from which this testing method was developed were primarily designed for substances for which the amount reaching the soil can be anticipated. This is the case, for example, for crop protection products for which the application rate in the field is known. For agrochemicals, testing of two doses relevant to the anticipated or predicted application rate is sufficient. Agrochemicals can be tested as active ingredients (a.i.) or as formulated products. However, the test is not limited to chemicals with predictable environmental concentrations. By changing both the amounts of test substance applied to the soil, and the way in which the data are evaluated, the test can also be used for chemicals for which the amount expected to reach the soil is not known. Thus, with non-agrochemicals, the effects of a series of concentrations on carbon transformation are determined. The data from these tests are used to prepare a dose-response curve and calculate EC_x values, where x is defined % effect.

1.2. DEFINITIONS

Carbon transformation: is the degradation by microorganisms of organic matter to form inorganic end-product carbon dioxide.

EC_x (Effective Concentration): is the concentration of the test substance in soil that results in a x % inhibition of carbon transformation in carbon dioxide.

EC_{50} (Median Effective Concentration): is the concentration of test substance in soil that results in a 50 % inhibition of carbon transformation in carbon dioxide.

1.3. REFERENCE SUBSTANCES

None.

▼B

1.4. PRINCIPLE OF THE TEST METHOD

Sieved soil is either treated with the test substance or left untreated (control). If agrochemicals are tested, a minimum of two test concentrations are recommended and these should be chosen in relation to the highest concentration anticipated in the field. After 0, 7, 14 and 28 days incubation, samples of treated and control soils are mixed with glucose, and glucose-induced respiration rates are measured for 12 consecutive hours. Respiration rates are expressed as carbon dioxide released (mg carbon dioxide/kg dry soil/h) or oxygen consumed (mg oxygen/kg soil/h). The mean respiration rate in the treated soil samples is compared with that in control and the percent deviation of the treated from the control is calculated. All tests run for at least 28 days. If, on the 28th day, differences between treated and untreated soils are equal to or greater than 25 % measurements are continued in 14 day intervals for a maximum of 100 days. If chemicals other than agrochemicals are tested, a series of concentrations of the test substance are added to samples of the soil, and glucose induced respiration rates (i.e. the mean of the quantities of carbon dioxide formed or oxygen consumed) are measured after 28 days. Results from tests with a series of concentrations are analysed using a regression model, and the EC_x values are calculated (i.e. EC₅₀, EC₂₅ and/or EC₁₀). See definitions.

1.5. VALIDITY OF THE TEST

Evaluations of test results with agrochemicals are based on relatively small differences (i.e. average value ± 25 %) between the carbon dioxide released or the oxygen consumed in (or by) control and treated soil samples, so large variations in the controls can lead to false results. Therefore, the variation between replicate control samples should be less than ± 15 %.

1.6. DESCRIPTION OF THE TEST METHOD

1.6.1. **Apparatus**

Test containers made of chemically inert material are used. They should be of a suitable capacity in compliance with the procedure used for incubation of soils, i.e. incubation in bulk or as a series of individual soil samples (see Section 1.7.1.2). Care should be taken both to minimise water loss and to allow gas exchange during the test (e.g. the test containers may be covered with perforated polyethylene foil). When volatile substances are tested, sealable and gas-tight containers should be used. These should be of a size such that approximately one quarter of their volume is filled with the soil sample.

For determination of glucose-induced respiration, incubation systems and instruments for measurement of carbon dioxide production or oxygen consumption are required. Examples of such systems and instruments are found in the literature (8) (9) (10) (11).

1.6.2. **Selection and number of soils**

One single soil is used. The recommended soil characteristics are as follows:

— sand content: not less than 50 % and not greater than 75 %,

▼B

- pH: 5,5-7,5,
- organic carbon content: 0,5-1,5 %,
- the microbial biomass should be measured (12)(13) and its carbon content should be at least 1 % of the total soil organic carbon.

In most cases, a soil with these characteristics represents a worst case situation, since adsorption of the test chemical is minimised and its availability to the microflora is maximum. Consequently, tests with other soils are generally unnecessary. However, in certain circumstances, e.g. where the anticipated major use of the test substance is in particular soils such as acidic forest soils, or for electrostatically charged chemicals, it may be necessary to substitute an additional soil.

1.6.3. **Collection and storage of soil samples**

1.6.3.1. *Collection*

Detailed information on the history of the field site from where the test soil is collected should be available. Details include exact location, vegetation cover, dates of treatments with crop protection products, treatments with organic and inorganic fertilisers, additions of biological materials or accidental contaminations. The site chosen for soil collection should be one which allows long-term use. Permanent pastures, fields with annual cereal crops (except maize) or densely sown green manures are suitable. The selected sampling site should not have been treated with crop protection products for a minimum of one year before sampling. Also, no organic fertiliser should have been applied for at least six months. The use of mineral fertiliser is only acceptable when in accordance with the requirements of the crop and soil samples should not be taken until at least three months after fertiliser application. The use of soil treated with fertilisers with known biocidal effects (e.g. calcium cyanamide) should be avoided.

Sampling should be avoided during or immediately following long periods (greater than 30 days) of drought or water logging. For ploughed soils, samples should be taken from a depth of 0 down to 20 cm. For grassland (pasture) or other soils where ploughing does not occur over longer periods (at least one growing season), the maximum depth of sampling may be slightly more than 20 cm (e.g. to 25 cm). Soil samples should be transported using containers and under temperature conditions which guarantee that the initial soil properties are not significantly altered.

1.6.3.2. *Storage*

The use of soils freshly collected from the field is preferred. If storage in the laboratory cannot be avoided, soils may be stored in the dark at 4 ± 2 °C for a maximum of three months. During the storage of soils, aerobic conditions must be ensured. If soils are collected from areas where they are frozen for at least three months per year, storage for six months at minus 18 °C can be considered. The microbial biomass of stored soils is measured prior to each experiment and the carbon in the biomass should be at least 1 % of the total soil organic carbon content (see Section 1.6.2).

▼B**1.6.4. Handling and preparation of soil for the test****1.6.4.1. Pre-incubation**

If the soil was stored (see Sections 1.6.4.2 and 1.7.1.3), pre-incubation is recommended for a period between two and 28 days. The temperature and moisture content of the soil during pre-incubation should be similar to that used in the test (see Sections 1.6.4.2 and 1.7.1.3).

1.6.4.2. Physical-chemical characteristics

The soil is manually cleared of large objects (e.g. stones, parts of plants, etc.) and then moist sieved without excess drying to a particle size less than or equal to 2 mm. The moisture content of the soil sample should be adjusted with distilled or deionised water to a value between 40 % and 60 % of the maximum water holding capacity.

1.6.5. Preparation of the test substance for the application to soil

The test substance is normally applied using a carrier. The carrier can be water (for water soluble substances) or an inert solid such as fine quartz sand (particle size: 0,1-0,5 mm). Liquid carriers other than water (e.g. organic solvents such as acetone, chloroform) should be avoided since they can damage the microflora. If sand is used as a carrier, it can be coated with the test substance dissolved or suspended in an appropriate solvent. In such cases, the solvent should be removed by evaporation before mixing with the soil. For an optimum distribution of the test substance in soil, a ratio of 10 g of sand per kilogram of soil (dry weight) is recommended. Control samples are treated with the equivalent amount of water and/or quartz sand only.

When testing volatile chemicals, losses during treatment should be avoided and an attempt should be made to ensure homogeneous distribution in the soil (e.g. the test substance should be injected into the soil at several places).

1.6.6. Test concentrations

If crop protection products or other chemicals with predictable environmental concentrations are tested, at least two concentrations should be used. The lower concentration should reflect at least the maximum amount expected to reach the soil under practical conditions whereas the higher concentration should be a multiple of the lower concentration. The concentrations of test substance added to soil are calculated assuming uniform incorporation to a depth of 5 cm and a soil bulk density of 1,5. For agrochemicals that are applied directly to soil, or for chemicals for which the quantity reaching the soil can be predicted, the test concentrations recommended are the Predictable Environmental Concentration (PEC) and five times that concentration. Substances that are expected to be applied to soils several times in one season should be tested at concentrations derived from multiplying the PEC by the maximum anticipated number of applications. The upper concentration tested, however, should not exceed 10 times the maximum single application rate.

If non-agrochemicals are tested, a geometric series of at least five concentrations is used. The concentrations tested should cover the range needed to determine the EC_x values.

▼B

1.7. PERFORMANCE OF THE TEST

1.7.1. **Conditions of exposure**1.7.1.1. *Treatment and control*

If agrochemicals are tested, the soil is divided into three portions of equal weight. Two portions are mixed with the carrier containing the product, and the other is mixed with the carrier without the product (control). A minimum of three replicates for both treated and untreated soils is recommended. If non-agrochemicals are tested, the soil is divided into six portions of equal weight. Five of the samples are mixed with the carrier containing the test substance, and the sixth sample is mixed with the carrier without the chemical. Three replicates for both treatments and control are recommended. Care should be taken to ensure homogeneous distribution of the test substance in the treated soil samples. During mixing, compacting or balling of the soil should be avoided.

1.7.1.2. *Incubation of soil samples*

Incubation of soil samples can be performed in two ways: as bulk samples of each treated and untreated soil or as a series of individual and equally sized subsamples of each treated and untreated soil. However, when volatile substances are tested, the test should only be performed with a series of individual subsamples. When soils are incubated in bulk, large quantities of each treated and untreated soils are prepared and subsamples to be analysed are taken as needed during the test. The amount initially prepared for each treatment and control depends on the size of the subsamples, the number of replicates used for analysis and the anticipated maximum number of sampling times. Soils incubated in bulk should be thoroughly mixed before subsampling. When soils are incubated as a series of individual soil samples, each treated and untreated bulk soil is divided into the required number of subsamples, and these are utilised as needed. In the experiments where more than two sampling times can be anticipated, enough subsamples should be prepared to account for all replicates and all sampling times. At least three replicate samples of the test soil should be incubated under aerobic conditions (see Section 1.7.1.1). During all tests, appropriate containers with sufficient headspace should be used to avoid development of anaerobic conditions. When volatile substances are tested, the test should only be performed with a series of individual subsamples.

1.7.1.3. *Test conditions and duration*

The test is carried out in the dark at room temperature of 20 ± 2 °C. The moisture content of soil samples should be maintained during the test between 40 % and 60 % of the maximum water holding capacity of the soil (see Section 1.6.4.2) with a range of ± 5 %. Distilled, deionised water can be added as needed.

The minimum duration of tests is 28 days. If agrochemicals are tested, the quantities of carbon dioxide released or oxygen consumed in treated and control samples are compared. If these differ by more than 25 % on day 28, the test is continued until a difference equal to or less than 25 % is obtained, or for a maximum of 100 days, whichever is shorter. If non-agrochemicals are tested, the test is terminated after 28 days. On day 28, the quantities of carbon dioxide released or oxygen consumed in treated and control soil samples are determined and the EC_x values are calculated.

▼B**1.7.2. Sampling and analysis of soils****1.7.2.1. Soil sampling schedule**

If agrochemicals are tested, soil samples are analysed for glucose-induced respiration rates on days 0, 7, 14 and 28. If a prolonged test is required, further measurements should be made at 14 days intervals after day 28.

If non-agrochemicals are tested, at least five test concentrations are used and soil samples are analysed for glucose-induced respiration at the beginning (day 0) and at the end of the exposure period (28 days). An intermediate measurement, e.g. at day 7, may be added if deemed necessary. The data obtained on day 28 are used to determine EC_x value for the chemical. If desired, data from day 0 control samples can be used to estimate the initial quantities of metabolically active microbial biomass in the soil (12).

1.7.2.2. Measurement of glucose-induced respiration rates

The glucose-induced respiration rate in each treated and control replicate is determined at each sampling time. The soil samples are mixed with a sufficient amount of glucose to elicit an immediate maximum respiratory response. The amount of glucose needed to elicit a maximum respiratory response from a given soil can be determined in a preliminary test using a series of concentrations of glucose (14). However, for sandy soils with 0,5-1,5 % organic carbon, 2 000 mg to 4 000 mg glucose per kg dry weight soil is usually sufficient. The glucose can be ground to a powder with clean quartz sand (10 g sand/kg dry weight soil) and homogeneously mixed with the soil.

The glucose amended soil samples are incubated in a suitable apparatus for measurement of respiration rates either continuously, every hour, or every two hours (see Section 1.6.1) at 20 ± 2 °C. The carbon dioxide released or the oxygen consumed is measured for 12 consecutive hours and measurements should start as soon as possible, i.e. within one to two hours after glucose supplement. The total quantities of carbon dioxide released or oxygen consumed during the 12 hours are measured and mean respiration rates are determined.

2. DATA**2.1. TREATMENT OF RESULTS**

If agrochemicals are tested, the carbon dioxide released from, or oxygen consumed by each replicate soil sample should be recorded, and the mean values of all replicates should be provided in tabular form. Results should be evaluated by appropriate and generally acceptable statistical methods (e.g. F-test, 5 % significance level). Glucose-induced respiration rates are expressed in mg carbon dioxide/kg dry weight soil/h or mg oxygen/dry weight soil/h. The mean carbon dioxide formation rate or mean oxygen consumption rate in each treatment is compared with that in control, and the percent deviation from the control is calculated.

▼B

If tests are conducted with non-agrochemicals, the quantities of carbon dioxide released or oxygen consumed by each replicate is determined, and a dose-response curve is prepared for estimation of the EC_x values. The glucose-induced respiration rates (i.e. mg carbon dioxide/kg dry weight soil/h or mg oxygen/dry weight soil/h) found in the treated samples after 28 days are compared to that found in control. From these data, the % inhibition values for each test concentration are calculated. These percentages are plotted against concentration, and statistical procedures are used to calculate the EC_x values. Confidence limits ($p = 0,95$) for the calculated EC_x are also determined using standard procedures (15)(16)(17).

2.2. INTERPRETATION OF RESULTS

When results from tests with agrochemicals are evaluated, and the difference in respiration rates between the lower treatment (i.e. the maximum predicted concentration) and control is equal to or less than 25 % at any sampling time after day 28, the product can be evaluated as having no long-term influence on carbon transformation in soils. When results from tests with chemicals other than agrochemicals are evaluated, the EC_{50} , EC_{25} and/or EC_{10} values are used.

3. REPORTING

TEST REPORT

The test report must include the following information:

Complete identification of the soil used including:

- geographical reference of the site (latitude, longitude),
- information on the history of the site (i.e. vegetation cover, treatments with crop protection products, treatments with fertilisers, accidental contamination, etc.),
- use pattern (e.g. agricultural soil, forest, etc.),
- depth of sampling (cm),
- sand/silt/clay content (% dry weight),
- pH (in water),
- organic carbon content (% dry weight),
- nitrogen content (% dry weight);
- cation exchange capacity (mmol/kg),
- initial microbial biomass in terms of percentage of the total organic carbon,
- reference of the methods used for the determination of each parameter,
- all information relating to the collection and storage of soil samples,
- details of pre-incubation of soil if any.

▼ B

Test substance:

- physical nature and, where relevant, physical-chemical properties,
- chemical identification data, where relevant, including structural formula, purity (i.e. for crop protection products the percentage of active ingredient), nitrogen content.

Test conditions:

- details of the amendment of soil with organic substrate,
- number of concentrations of test chemical used and, where appropriate, justification of the selected concentrations,
- details of the application of test substance to soil,
- incubation temperature,
- soil moisture content at the beginning and during the test,
- method of soil incubation used (i.e. as bulk or as a series of individual subsamples),
- number of replicates,
- sampling times.

Results:

- method and equipment used for measurement of respiration rates,
- tabulated data including individual and mean values for quantities of carbon dioxide or oxygen,
- variation between the replicates in treated and control samples,
- explanations of corrections made in the calculations, if relevant,
- the percent variation of glucose-induced respiration rates at each sampling time or, if appropriate, the EC₅₀ with 95 % confidence limit, other EC_x (i.e. EC₂₅ or EC₁₀) with confidence intervals, and a graph of the dose-response curve,
- statistical treatment of results, where appropriate,
- all information and observations helpful for the interpretation of the results.

4. REFERENCES

- (1) Eppo, (1994) Decision-Making Scheme for the Environmental Risk Assessment of Plant Protection Chemicals. Chapter 7: Soil Microflora. Eppo Bulletin 24: 1-16, 1994.
- (2) BBA, (1990) Effects on the Activity of the Soil Microflora. BBA Guidelines for the Official Testing of Plant Protection Products, VI, 1-1 (2nd eds., 1990).
- (3) EPA, (1987) Soil Microbial Community Toxicity Test. EPA 40 CFR Part 797.3700. Toxic Substances Control Act Test Guidelines; Proposed rule. September 28, 1987.

▼ B

- (4) SETAC-Europe, (1995) Procedures for assessing the environmental fate and ecotoxicity of pesticides, Ed. M.R. Lynch, Pub. SETAC-Europe, Brussels.
- (5) OECD, (1995) Final Report of the OECD Workshop on Selection of Soils/Sediments, Belgirate, Italy, 18-20 January 1995.
- (6) ISO 10381-6, (1993) Soil quality — Sampling. Guidance on the collection, handling and storage of soil for the assessment of aerobic microbial processes in the laboratory.
- (7) Anderson, J.P.E., (1987) Handling and Storage of Soils for Pesticide Experiments, in 'Pesticide Effects on Soil Microflora'. Eds. L. Somerville and M.P. Greaves, Chap. 3: 45-60.
- (8) Anderson, J.P.E., (1982) Soil Respiration, in 'Methods of Soil Analysis — Part 2: Chemical and Microbiological Properties'. Agronomy Monograph No 9. Eds. A.L. Page, R.H. Miller and D.R. Keeney. 41: 831- 871.
- (9) ISO 11266-1, (1993) Soil Quality — Guidance on Laboratory Tests for Biodegradation in Soil: Part 1. Aerobic Conditions.
- (10) ISO 14239, (1997E) Soil Quality — Laboratory incubation systems for measuring the mineralisation of organic chemicals in soil under aerobic conditions.
- (11) Heinemeyer O., Insam, H., Kaiser, E.A, and Walenzik, G., (1989) Soil microbial biomass and respiration measurements; an automated technique based on infrared gas analyses. *Plant and Soil*, 116: 77-81.
- (12) ISO 14240-1, (1997) Soil quality — Determination of soil microbial biomass — Part 1: Substrate-induced respiration method.
- (13) ISO 14240-2, (1997) Soil quality — Determination of soil microbial biomass — Part 2: Fumigation-extraction method.
- (14) Malkomes, H.-P., (1986) Einfluß von Glukosemenge auf die Reaktion der Kurzzeit-Atmung im Boden Gegenüber Pflanzenschutzmitteln, Dargestellt am Beispiel eines Herbizide. (Influence of the Amount of Glucose Added to the Soil on the Effect of Pesticides in Short-Term Respiration, using a Herbicide as an Example). *Nachrichtenbl. Deut. Pflanzenschutzd., Braunschweig*, 38: 113-120.
- (15) Litchfield, J.T. and Wilcoxon, F., (1949) A simplified method of evaluating dose-effect experiments. *Jour. Pharmacol. and Exper. Ther.*, 96, 99-113.
- (16) Finney, D.J., (1971) *Probit Analysis*. 3rd ed., Cambridge, London and New-York.
- (17) Finney D.J., (1978) *Statistical Methods in biological Assay*. Griffin, Weycombe, UK.

▼B**C.23. AEROBIC AND ANAEROBIC TRANSFORMATION IN SOIL****1. METHOD**

This test method is a replicate of the OECD TG 307 (2002)

1.1. INTRODUCTION

This test method is based on existing guidelines (1)(2)(3)(4)(5)(6)(7)(8)(9). The method described in this test Method is designed for evaluating aerobic and anaerobic transformation of chemicals in soil. The experiments are performed to determine (i) the rate of transformation of the test substance, and (ii) the nature and rates of formation and decline of transformation products to which plants and soil organisms may be exposed. Such studies are required for chemicals which are directly applied to soil or which are likely to reach the soil environment. The results of such laboratory studies can also be used to develop sampling and analysis protocols for related field studies.

Aerobic and anaerobic studies with one soil type are generally sufficient for the evaluation of transformation pathways (8)(10)(11). Rates of transformation should be determined in at least three additional soils (8)(10).

An OECD Workshop on soil and sediment selection, held at Belgirate, Italy in 1995 (10) agreed, in particular, on the number and types of soils for use in this test. The types of soils tested should be representative of the environmental conditions where use or release will occur. For example, chemicals that may be released in subtropical to tropical climates should be tested with Ferrasols or Nitosols (FAO system). The Workshop also made recommendations relating to collection, handling and storage of soil samples, based on the ISO Guidance (15). The use of paddy (rice) soils is also considered in this method.

1.2. DEFINITIONS

Test substance: any substance, whether the parent compound or relevant transformation products.

Transformation products: all substances resulting from biotic or abiotic transformation reactions of the test substance including CO₂ and products that are in bound residues.

Bound residues: 'Bound residues' represent compounds in soil, plant or animal, which persist in the matrix in the form of the parent substance or its metabolite(s)/transformation products after extraction. The extraction method must not substantially change the compounds themselves or the structure of the matrix. The nature of the bond can be clarified in part by matrix-altering extraction methods and sophisticated analytical techniques. To date, for example, covalent ionic and sorptive bonds, as well as entrapments, have been identified in this way. In general, the formation of bound residues reduces the bioaccessibility and the bioavailability significantly (12) [modified from IUPAC 1984 (13)].

Aerobic transformation: reactions occurring in the presence of molecular oxygen (14).

▼ B

Anaerobic transformation: reactions occurring under exclusion of molecular oxygen (14).

Soil: is a mixture of mineral and organic chemical constituents, the latter containing compounds of high carbon and nitrogen content and of high molecular weights, animated by small (mostly micro-) organisms. Soil may be handled in two states:

- (a) undisturbed, as it has developed with time, in characteristic layers of a variety of soil types;
- (b) disturbed, as it is usually found in arable fields or as occurs when samples are taken by digging and used in this test method (14).

Mineralisation: is the complete degradation of an organic compound to CO₂ and H₂O under aerobic conditions, and CH₄, CO₂ and H₂O under anaerobic conditions. In the context of this test method, when ¹⁴C-labelled compound is used, mineralisation means extensive degradation during which a labelled carbon atom is oxidised with release of the appropriate amount of ¹⁴CO₂ (14).

Half-life: $t_{0,5}$ is the time taken for 50 % transformation of a test substance when the transformation can be described by first-order kinetics; it is independent of the concentration.

DT₅₀ (Disappearance Time 50): is the time within which the concentration of the test substance is reduced by 50 %; it is different from the half-life $t_{0,5}$ when transformation does not follow first order kinetics.

DT₇₅ (Disappearance Time 75): is the time within which the concentration of the test substance is reduced by 75 %.

DT₉₀ (Disappearance Time 90): is the time within which the concentration of the test substance is reduced by 90 %.

1.3. REFERENCE SUBSTANCES

Reference substances should be used for the characterisation and/or identification of transformation products by spectroscopic and chromatographic methods.

1.4. APPLICABILITY OF THE TEST

The method is applicable to all chemical substances (non-labelled or radiolabelled) for which an analytical method with sufficient accuracy and sensitivity is available. It is applicable to slightly volatile, non-volatile, water-soluble or water-insoluble compounds. The test should not be applied to chemicals which are highly volatile from soil (e.g. fumigants, organic solvents) and thus cannot be kept in soil under the experimental conditions of this test.

▼ B

1.5. INFORMATION ON THE SUBSTANCE

Non-labelled or labelled test substance can be used to measure the rate of transformation. Labelled material is required for studying the pathway of transformation and for establishing a mass balance. ¹⁴C-labelling is recommended but the use of other isotopes, such as ¹³C, ¹⁵N, ³H, ³²P, may also be useful. As far as possible, the label should be positioned in the most stable part(s) of the molecule (¹). The purity of the test substance should be at least 95 %.

Before carrying out a test on aerobic and anaerobic transformation in soil, the following information on the test substance should be available:

- (a) solubility in water (Method A.6)
- (b) solubility in organic solvents;
- (c) vapour pressure (Method A.4) and Henry's law constant;
- (d) n-octanol/water partition coefficient (Method A.8);
- (e) chemical stability in dark (hydrolysis) (Method C.7);
- (f) pK_a if a molecule is liable to protonation or deprotonation [OECD Guideline 112] (16).

Other useful information may include data on toxicity of the test substance to soil micro-organisms [testing methods C.21 and C.22] (16).

Analytical methods (including extraction and clean-up methods) for quantification and identification of the test substance and its transformation products should be available.

1.6. PRINCIPLE OF THE TEST METHOD

Soil samples are treated with the test substance and incubated in the dark in biometer-type flasks or in flow-through systems under controlled laboratory conditions (at constant temperature and soil moisture). After appropriate time intervals, soil samples are extracted and analysed for the parent substance and for transformation products. Volatile products are also collected for analysis using appropriate absorption devices. Using ¹⁴C-labelled material, the various mineralisation rates of the test substance can be measured by trapping evolved ¹⁴CO₂ and a mass balance, including the formation of soil bound residues, can be established.

1.7. QUALITY CRITERIA

1.7.1. Recovery

Extraction and analysis of, at least, duplicate soil samples immediately after the addition of the test substance gives a first indication of the repeatability of the analytical method and of the uniformity of the application procedure for the test substance. Recoveries for later stages of the experiments are given by the respective mass balances. Recoveries should range from 90 % to 110 % for labelled chemicals (8) and from 70 % to 110 % for non-labelled chemicals (3).

(¹) For example, if the test substance contains one ring, labelling on this ring is required; if the test substance contains two or more rings, separate studies may be needed to evaluate the fate of each labelled ring and to obtain suitable information on formation of transformation products.

▼ B**1.7.2. Repeatability and sensitivity of analytical method**

Repeatability of the analytical method (excluding the initial extraction efficiency) to quantify test substance and transformation products can be checked by duplicate analysis of the same extract of the soil, incubated long enough for formation of transformation products.

The limit of detection (LOD) of the analytical method for the test substance and for the transformation products should be at least 0,01 mg·kg⁻¹ soil (as test substance) or 1 % of applied dose whichever is lower. The limit of quantification (LOQ) should also be specified.

1.7.3. Accuracy of transformation data

Regression analysis of the concentrations of the test substance as a function of time gives the appropriate information on the reliability of the transformation curve and allows the calculation of the confidence limits for half-lives (in the case of pseudo first order kinetics) or DT₅₀ values and, if appropriate, DT₇₅ and DT₉₀ values.

1.8. DESCRIPTION OF THE METHOD**1.8.1. Equipment and chemical reagents**

Incubation systems consist of static closed systems or suitable flow-through systems (7)(17). Examples of suitable flow-through soil incubation apparatus and biometer-type flask are shown in Figures 1 and 2, respectively. Both types of incubation systems have advantages and limitations (7)(17).

Standard laboratory equipment is required and especially the following:

- analytical instruments such as GLC, HPLC, TLC-equipment, including the appropriate detection systems for analysing radio-labelled or non-labelled substances or inverse isotopes dilution method,
- instruments for identification purposes (e.g. MS, GC-MS, HPLC-MS, NMR, etc.),
- liquid scintillation counter,
- oxidiser for combustion of radioactive material,
- centrifuge,
- extraction apparatus (for example, centrifuge tubes for cold extraction and Soxhlet apparatus for continuous extraction under reflux),
- instrumentation for concentrating solutions and extracts (e.g. rotating evaporator),
- water bath,
- mechanical mixing device (e.g. kneading machine, rotating mixer).

▼B

Chemical reagents used include, for example:

- NaOH, analytical grade, $2 \text{ mol} \cdot \text{dm}^{-3}$, or other appropriate base (e.g. KOH, ethanolamine),
- H_2SO_4 , analytical grade, $0,05 \text{ mol} \cdot \text{dm}^{-3}$,
- ethylene glycol, analytical grade,
- solid absorption materials such as soda lime and polyurethane plugs,
- organic solvents, analytical grade, such as acetone, methanol, etc.,
- scintillation liquid.

1.8.2. Test substance application

For addition to and distribution in soil, the test substance can be dissolved in water (deionised or distilled) or, when necessary, in minimum amounts of acetone or other organic solvents (6) in which the test substance is sufficiently soluble and stable. However, the amount of solvent selected should not have a significant influence on soil microbial activity (see Sections 1.5 and 1.9.2-1.9.3). The use of solvents which inhibit microbial activity, such as chloroform, dichloromethane and other halogenated solvents, should be avoided.

The test substance can also be added as a solid, e.g. mixed in quartz sand (6) or in a small sub-sample of the test soil which has been air-dried and sterilised. If the test substance is added using a solvent the solvent should be allowed to evaporate before the spiked sub-sample is added to the original non-sterile soil sample.

For general chemicals, whose major route of entry into soil is through sewage sludge/farming application, the test substance should be first added to sludge which is then introduced into the soil sample. (see Sections 1.9.2 and 1.9.3)

The use of formulated products is not routinely recommended. However, e.g. for poorly soluble test substances, the use of formulated material may be an appropriate alternative.

1.8.3. Soils**1.8.3.1. Soil selection**

To determine the transformation pathway, a representative soil can be used; a sandy loam or silty loam or loam or loamy sand (according to FAO and USDA classification (18)), with a pH of 5,5-8,0, an organic carbon content of 0,5-2,5 % and a microbial biomass of at least 1 % of total organic carbon is recommended (10).

For transformation rate studies at least three additional soils should be used representing a range of relevant soils. The soils should vary in their organic carbon content, pH, clay content and microbial biomass (10).

▼ B

All soils should be characterised, at least, for texture (% sand, % silt, % clay) [according to FAO and USDA classification (18)], pH, cation exchange capacity, organic carbon, bulk density, water retention characteristic ⁽¹⁾ and microbial biomass (for aerobic studies only). Additional information on soil properties may be useful in interpreting the results. For determination of the soil characteristics the methods recommended in references (19)(20)(21)(22)(23) can be used. Microbial biomass should be determined by using the substrate-induced respiration (SIR) method (25)(26) or alternative methods (20).

1.8.3.2. *Collection, handling, and storage of soils*

Detailed information on the history of the field site from where the test soil is collected should be available. Details include exact location, vegetation cover, treatments with chemicals, treatments with organic and inorganic fertilisers, additions of biological materials or other contamination. If soils have been treated with the test substance or its structural analogues within the previous four years, these should not be used for transformation studies (10)(15).

The soil should be freshly collected from the field (from the A horizon or top 20 cm layer) with a soil water content which facilitates sieving. For soils other than those from paddy fields, sampling should be avoided during or immediately following long periods (> 30 days) of drought, freezing or flooding (14). Samples should be transported in a manner which minimises changes in soil water content and should be kept in the dark with free access of air, as much as possible. A loosely-tied polyethylene bag is generally adequate for this purpose.

The soil should be processed as soon as possible after sampling. Vegetation, larger soil fauna and stones should be removed prior to passing the soil through a 2 mm sieve which removes small stones, fauna and plant debris. Extensive drying and crushing of the soil before sieving should be avoided (15).

When sampling in the field is difficult in winter (soil frozen or covered by layers of snow), it may be taken from a batch of soil stored in the greenhouse under plant cover (e.g. grass or grass-clover mixtures). Studies with soils freshly collected from the field are strongly preferred, but if the collected and processed soil has to be stored prior to the start of the study storage conditions must be adequate and for a limited time only (4 ± 2 °C for a maximum of three months) to maintain microbial activity ⁽²⁾. Detailed instructions on collection, handling and storage of soils to be used for biotransformation experiments can be found in (8)(10)(15)(26)(27).

⁽¹⁾ Water retention characteristic of a soil can be measured as field capacity, as water holding capacity or as water suction tension (pF). For explanations see Appendix 1. It should be reported in the test report whether water retention characteristics and bulk density of soils were determined in undisturbed field samples or in disturbed (processed) samples.

⁽²⁾ Recent research results indicate that soils from temperate zones can also be stored at -20 °C for more than three months (28)(29) without significant losses of microbial activity.

▼ B

Before the processed soil is used for this test, it should be pre-incubated to allow germination and removal of seeds, and to re-establish equilibrium of microbial metabolism following the change from sampling or storage conditions to incubation conditions. A pre-incubation period between two and 28 days approximating the temperature and moisture conditions of the actual test is generally adequate (15). Storage and pre-incubation time together should not exceed three months.

1.9. PERFORMANCE OF THE TEST

1.9.1. **Test conditions**1.9.1.1. *Test temperature*

During the whole test period, the soils should be incubated in the dark at a constant temperature representative of the climatic conditions where use or release will occur. A temperature of 20 ± 2 °C is recommended for all test substances which may reach the soil in temperate climates. The temperature should be monitored.

For chemicals applied or released in colder climates (e.g. in northern countries, during autumn/winter periods), additional soil samples should be incubated but at a lower temperature (e.g. 10 ± 2 °C).

1.9.1.2. *Moisture content*

For transformation tests under aerobic conditions, the soil moisture content (1) should be adjusted to and maintained at a pF between 2,0 and 2,5 (3). The soil moisture content is expressed as mass of water per mass of dry soil and should be regularly controlled (e.g. in 2 week intervals) by weighing of the incubation flasks and water losses compensated by adding water (preferably sterile-filtered tap water). Care should be given to prevent or minimise losses of test substance and/or transformation products by volatilisation and/or photodegradation (if any) during moisture addition.

For transformation tests under anaerobic and paddy conditions, the soil is water-saturated by flooding.

1.9.1.3. *Aerobic incubation conditions*

In the flow-through systems, aerobic conditions will be maintained by intermittent flushing or by continuously ventilating with humidified air. In the biometer flasks, exchange of air is maintained by diffusion.

1.9.1.4. *Sterile aerobic conditions*

To obtain information on the relevance of abiotic transformation of a test substance, soil samples may be sterilised (for sterilisation methods see references 16 and 29), treated with sterile test substance (e.g. addition of solution through a sterile filter) and aerated with humidified sterile air as described in Section 1.9.1.3. For paddy soils, soil and water should be sterilised and the incubation should be carried out as described in Section 1.9.1.6.

(1) The soil should neither be too wet nor too dry to maintain adequate aeration and nutrition of soil microflora. Moisture contents recommended for optimal microbial growth range from 40-60 % water holding capacity (WHC) and from 0,1-0,33 bar (6). The latter range is equivalent to a pF-range of 2,0-2,5. Typical moisture contents of various soil types are given in Appendix 2.

▼ B1.9.1.5. *Anaerobic incubation conditions*

To establish and maintain anaerobic conditions, the soil treated with the test substance and incubated under aerobic conditions for 30 days or one half-life or DT_{50} (whichever is shorter) is then water-logged (1-3 cm water layer) and the incubation system flushed with an inert gas (e.g. nitrogen or argon)⁽¹⁾. The test system must allow for measurements such as pH, oxygen concentration and redox potential and include trapping devices for volatile products. The biometer-type system must be closed to avoid entrance of air by diffusion.

1.9.1.6. *Paddy incubation conditions*

To study transformation in paddy rice soils, the soil is flooded with a water layer of about 1-5 cm and the test substance applied to the water phase (9). A soil depth of at least 5 cm is recommended. The system is ventilated with air as under aerobic conditions. pH, oxygen concentration and redox potential of the aqueous layer should be monitored and reported. A pre-incubation period of at least two weeks is necessary before commencing transformation studies (see Section 1.8.3.2).

1.9.1.7. *Test duration*

The rate and pathway studies should normally not exceed 120 days⁽²⁾ (3)(6)(8), because thereafter a decrease of the soil microbial activity with time would be expected in an artificial laboratory system isolated from natural replenishment. Where necessary to characterise the decline of the test substance and the formation and decline of major transformation products, studies can be continued for longer periods (e.g. 6 or 12 months) (8). Longer incubation periods should be justified in the test report and accompanied by biomass measurements during and at the end of these periods.

1.9.2. **Performance of the test**

About 50 to 200 g of soil (dry weight basis) are placed into each incubation flask (see Figures 1 and 2 in Appendix 3) and the soil treated with the test substance by one of the methods described in Section 1.8.2. When organic solvents are used for the application of the test substance, they should be removed from soil by evaporation. Then the soil is thoroughly mixed with a spatula and/or by shaking of the flask. If the study is conducted under paddy field conditions, soil and water should be thoroughly mixed after application of the test substance. Small aliquots (e.g. 1 g) of the treated soils should be analysed for the test substance to check for uniform distribution. For alternative method, see below.

⁽¹⁾ Aerobic conditions are dominant in surface soils and even in sub-surface soils as shown in an EU sponsored research project [K. Takagi et al. (1992). Microbial diversity and activity in subsoils: Methods, field site, seasonal variation in subsoil temperatures and oxygen contents. Proc. Internat. Symp. Environm. Aspects Pesticides Microbiol., 270-277, 17-21 August 1992, Sigtuna, Sweden]. Anaerobic conditions may only occur occasionally during flooding of soils after heavy rainfalls or when paddy conditions are established in rice fields.

⁽²⁾ Aerobic studies might be terminated much before 120 days provided that ultimate transformation pathway and ultimate mineralisation are clearly reached at that time. Termination of the test is possible after 120 days, or when at least 90 % of the test substance is transformed, but only if at least 5 % CO_2 is formed.

▼ B

The treatment rate should correspond to the highest application rate of a crop protection product recommended in the use instructions and uniform incorporation to an appropriate depth in the field (e.g. top 10 cm layer⁽¹⁾ of soil). For example, for chemicals foliarly or soil applied without incorporation, the appropriate depth for computing how much chemical should be added to each flask is 2,5 cm. For soil incorporated chemicals, the appropriate depth is the incorporation depth specified in the use instructions. For general chemicals, the application rate should be estimated based on the most relevant route of entry; for example, when the major route of entry in soil is through sewage sludge, the chemical should be dosed into the sludge at a concentration that reflects the expected sludge concentration and the amount of sludge added to the soil should reflect normal sludge loading to agricultural soils. If this concentration is not high enough to identify major transformation products, incubation of separate soil samples containing higher rates may be helpful, but excessive rates influencing soil microbial functions should be avoided (see Sections 1.5 and 1.8.2).

Alternatively, a larger batch (i.e. 1 to 2 kg) of soil can be treated with the test substance, carefully mixed in an appropriate mixing machine and then transferred in small portions of 50 to 200 g into the incubation flasks (for example with the use of sample splitters). Small aliquots (e.g. 1 g) of the treated soil batch should be analysed for the test substance to check for uniform distribution. Such a procedure is preferred since it allows for more uniform distribution of the test substance into the soil.

Also untreated soil samples are incubated under the same conditions (aerobic) as the samples treated with the test substance. These samples are used for biomass measurements during and at the end of the studies.

When the test substance is applied to the soil dissolved in organic solvent(s), soil samples treated with the same amount of solvent(s) are incubated under the same conditions (aerobic) as the samples treated with the test substance. These samples are used for biomass measurements initially, during and at the end of the studies to check for effects of the solvent(s) on microbial biomass.

The flasks containing the treated soil are either attached to the flow-through system described in Figure 1 or closed with the absorption column shown in Figure 2 (see Appendix 3).

⁽¹⁾ Calculation of the initial concentration on an area basis using the following equation:

$$C_{\text{soil}} [\text{mg}/\text{kg}_{\text{soil}}] = \frac{A [\text{kg}/\text{ha}] \cdot 10^6 [\text{mg}/\text{kg}]}{l [\text{m}] \cdot 10^4 [\text{m}^2/\text{ha}] \cdot d [\text{kg}_{\text{soil}}/\text{m}^3]}$$

C_{soil} = Initial concentration in soil [$\text{mg} \cdot \text{kg}^{-1}$]

A = Application rate [$\text{kg} \cdot \text{ha}^{-1}$]; l = thickness of field soil layer [m]; d = dry bulk density of soil [$\text{kg} \cdot \text{m}^{-3}$].

As a rule of thumb, an application rate of $1 \text{ kg} \cdot \text{ha}^{-1}$ results in a soil concentration of approximately $1 \text{ mg} \cdot \text{kg}^{-1}$ in a 10 cm layer (assuming a bulk density of $1 \text{ g} \cdot \text{cm}^{-3}$).

▼B**1.9.3. Sampling and measurement**

Duplicate incubation flasks are removed at appropriate time intervals and the soil samples extracted with appropriate solvents of different polarity and analysed for the test substance and/or transformation products. A well-designed study includes sufficient flasks so that two flasks are sacrificed at each sampling event. Also, absorption solutions or solid absorption materials are removed at various time intervals (7-day intervals during the first month and after one month in 17-day intervals) during and at the end of incubation of each soil sample and analysed for volatile products. Besides a soil sample taken directly after application (0-day sample) at least five additional sampling points should be included. Time intervals should be chosen in such a way that pattern of decline of the test substance and patterns of formation and decline of transformation products can be established (e.g. 0, 1, 3, 7 days; 2, 3 weeks; 1, 2, 3 months, etc.).

When using ^{14}C -labelled test substance, non-extractable radioactivity will be quantified by combustion and a mass balance will be calculated for each sampling interval.

In the case of anaerobic and paddy incubation, the soil and water phases are analysed together for test substance and transformation products or separated by filtration or centrifugation before extraction and analysis.

1.9.4. Optional tests

Aerobic, non-sterile studies at additional temperatures and soil moistures may be useful for the estimation of the influence of temperature and soil moisture on the rates of transformation of a test substance and/or its transformation products in soil.

A further characterisation of non-extractable radioactivity can be attempted using, for example, supercritical fluid extraction.

2. DATA**2.1. TREATMENT OF RESULTS**

The amounts of test substance, transformation products, volatile substances (in % only), and non-extractable should be given as % of applied initial concentration and, where appropriate, as $\text{mg} \cdot \text{kg}^{-1}$ soil (based on soil dry weight) for each sampling interval. A mass balance should be given in percentage of the applied initial concentration for each sampling interval. A graphical presentation of the test substance concentrations against time will allow an estimation of its transformation half-life or DT_{50} . Major transformation products should be identified and their concentrations should also be plotted against time to show their rates of formation and decline. A major transformation product is any product representing $\geq 10\%$ of applied dose at any time during the study.

The volatile products trapped give some indication of the volatility potential of a test substance and its transformation products from soil.

▼ B

More accurate determinations of half-lives or DT₅₀ values and, if appropriate, DT₇₅ and DT₉₀ values should be obtained by applying appropriate kinetic model calculations. The half-life and DT₅₀ values should be reported together with the description of the model used, the order of kinetics and the determination coefficient (r^2). First order kinetics is favoured unless $r^2 < 0,7$. If appropriate, the calculations should also be applied to the major transformation products. Examples of appropriate models are described in references 31 to 35.

In the case of rate studies carried out at various temperatures, the transformation rates should be described as a function of temperature within the experimental temperature range using the Arrhenius relationship of the form:

$$k = A \cdot e^{-B/T} \text{ or } \ln k = \ln A - \frac{B}{T},$$

where $\ln A$ and B are regression constants from the intercept and slope, respectively, of a best fit line generated from linearly regressing $\ln k$ against $1/T$, k is the rate constant at temperature T and T is the temperature in Kelvin. Care should be given to the limited temperature range in which the Arrhenius relationship will be valid in case transformation is governed by microbial action.

2.2. EVALUATION AND INTERPRETATION OF RESULTS

Although the studies are carried out in an artificial laboratory system, the results will allow estimation of the rate of transformation of the test substance and also of rate of formation and decline of transformation products under field conditions (36)(37).

A study of the transformation pathway of a test substance provides information on the way in which the applied substance is structurally changed in the soil by chemical and microbial reactions.

3. REPORTING

TEST REPORT

The test report must include:

Test substance:

- common name, chemical name, CAS number, structural formula (indicating position of label(s) when radiolabelled material is used) and relevant physical-chemical properties (see Section 1.5),
- purity (impurities) of test substance,
- radiochemical purity of labelled chemical and specific activity (where appropriate),

Reference substances:

- chemical name and structure of reference substances used for the characterisation and/or identification of transformation product,

Test soils:

- details of collection site,
- date and procedure of soil sampling,

▼ B

- properties of soils, such as pH, organic carbon content, texture (% sand, % silt, % clay), cation exchange capacity, bulk density, water retention characteristic, and microbial biomass,
- length of soil storage and storage conditions (if stored),

Test conditions:

- dates of the performance of the studies,
- amount of test substance applied,
- solvents used and method of application for the test substance,
- weight of soil treated initially and sampled at each interval for analysis,
- description of the incubation system used,
- air flow rates (for flow-through systems only),
- temperature of experimental set-up,
- soil moisture content during incubation,
- microbial biomass initially, during and at the end of the aerobic studies,
- pH, oxygen concentration and redox potential initially, during and at the end of the anaerobic and paddy studies,
- method(s) of extraction,
- methods for quantification and identification of the test substance and major transformation products in soil and absorption materials,
- number of replicates and number of controls.

Results:

- result of microbial activity determination,
- repeatability and sensitivity of the analytical methods used,
- rates of recovery (% values for a valid study are given in Section 1.7.1),
- tables of results expressed as % of applied initial dose and, where appropriate, as $\text{mg} \cdot \text{kg}^{-1}$ soil (on a dry weight basis),
- mass balance during and at the end of the studies,
- characterisation of non-extractable (bound) radioactivity or residues in soil,
- quantification of released CO_2 and other volatile compounds,
- plots of soil concentrations versus time for the test substance and, where appropriate, for major transformation products,
- half-life or DT_{50} , DT_{75} and DT_{90} for the test substance and, where appropriate, for major transformation products including confidence limits,

▼B

- estimation of abiotic degradation rate under sterile conditions,
- an assessment of transformation kinetics for the test substance and, where appropriate, for major transformation products,
- proposed pathways of transformation, where appropriate,
- discussion and interpretation of results,
- raw data (i.e. sample chromatograms, sample calculations of transformation rates and means used to identify transformation products).

4. **REFERENCES**

- (1) US — Environmental Protection Agency, (1982) Pesticide Assessment Guidelines, Subdivision N. Chemistry: Environmental Fate.
- (2) Agriculture Canada, (1987) Environmental Chemistry and Fate. Guidelines for registration of pesticides in Canada.
- (3) European Union (EU), (1995) Commission Directive 95/36/EC of 14 July 1995 amending Council Directive 91/414/EEC concerning the placing of plant protection products on the market. Annex II, Part A and Annex III, Part A: Fate and Behaviour in the Environment.
- (4) Dutch Commission for Registration of Pesticides, (1995) Application for registration of a pesticide. Section G: Behaviour of the product and its metabolites in soil, water and air.
- (5) BBA, (1986) Richtlinie für die amtliche Prüfung von Pflanzenschutzmitteln, Teil IV, 4-1. Verbleib von Pflanzenschutzmitteln im Boden — Abbau, Umwandlung und Metabolismus.
- (6) ISO/DIS 11266-1, (1994) Soil Quality -Guidance on laboratory tests for biodegradation of organic chemicals in soil — Part 1: Aerobic conditions.
- (7) ISO 14239, (1997) Soil Quality — Laboratory incubation systems for measuring the mineralisation of organic chemicals in soil under aerobic conditions.
- (8) SETAC, (1995) Procedures for Assessing the Environmental Fate and Ecotoxicity of Pesticides. Mark R. Lynch, Ed.
- (9) MAFF — Japan 2000 — Draft Guidelines for transformation studies of pesticides in soil — Aerobic metabolism study in soil under paddy field conditions (flooded).
- (10) OECD, (1995) Final Report of the OECD Workshop on Selection of Soils/Sediments. Belgirate, Italy, 18-20 January 1995.
- (11) Guth, J.A., (1980) The study of transformations. In Interactions between Herbicides and the Soil (R.J. Hance, Ed.), Academic Press, p. 123-157.
- (12) DFG: Pesticide Bound Residues in Soil. Wiley — VCH (1998).
- (13) T.R. Roberts: Non-extractable pesticide residue in soils and plants. Pure Appl. Chem. 56, 945-956 (IUPAC 1984).
- (14) OECD Test Guideline 304 A: Inherent Biodegradability in Soil (adopted 12 May 1981).

▼ B

- (15) ISO 10381-6 (1993) Soil Quality — Sampling — Part 6: Guidance on the collection, handling and storage of soil for the assessment of aerobic microbial processes in the laboratory.
- (16) Appendix V to Directive 67/548/EEC.
- (17) Guth, J.A., (1981) Experimental approaches to studying the fate of pesticides in soil. In *Progress in Pesticide Biochemistry*. D.H. Hutson, T.R. Roberts, Eds. J. Wiley & Sons. Vol 1, 85-114.
- (18) Soil Texture Classification (US and FAO systems): *Weed Science*, 33, Suppl. 1 (1985) and *Soil Sci. Soc. Amer. Proc.* 26:305 (1962).
- (19) *Methods of Soil Analysis* (1986) Part 1, Physical and Mineralogical Methods. A. Klute, Ed.) Agronomy Series No 9, 2nd Edition.
- (20) *Methods of Soil Analysis* (1982) Part 2, Chemical and Microbiological Properties. A.L. Page, R.H. Miller and D.R. Keeney, Eds. Agronomy Series No 9, 2nd Edition.
- (21) ISO Standard Compendium Environment (1994) Soil Quality — General aspects; chemical and physical methods of analysis; biological methods of analysis. First Edition.
- (22) Mückenhausen, E., (1975) *Die Bodenkunde und ihre geologischen, geomorphologischen, mineralogischen und petrologischen Grundlagen*. DLG-Verlag, Frankfurt, Main.
- (23) Scheffer, F., Schachtschabel, P., (1975) *Lehrbuch der Bodenkunde*. F. Enke Verlag, Stuttgart.
- (24) Anderson, J.P.E., Domsch, K.H., (1978) A physiological method for the quantitative measurement of microbial biomass in soils. *Soil Biol. Biochem.* 10, p. 215-221.
- (25) ISO 14240-1 and 2 (1997) Soil Quality — Determination of soil microbial biomass — Part 1: Substrate-induced respiration method. Part 2: fumigation-extraction method.
- (26) Anderson, J.P.E., (1987) Handling and storage of soils for pesticide experiments. In *Pesticide Effects on Soil Microflora*. L. Somerville, M.P. Greaves, Eds. Taylor & Francis, 45-60.
- (27) Kato, Yasuhiro. (1998) Mechanism of pesticide transformation in the environment: Aerobic and bio-transformation of pesticides in aqueous environment. *Proceedings of the 16th Symposium on Environmental Science of Pesticide*, p. 105-120.
- (28) Keuken O., Anderson J.P.E., (1996) Influence of storage on biochemical processes in soil. In *Pesticides, Soil Microbiology and Soil Quality*, 59-63 (SETAC-Europe).
- (29) Stenberg B., Johansson M., Pell M., Sjö Dahl-Svensson K., Stenström J., Torstensson L. (1996) Effect of freeze and cold storage of soil on microbial activities and biomass. In *Pesticides, Soil Microbiology and Soil Quality*, 68-69 (SETAC-Europe).
- (30) Gennari, M., Negre, M., Ambrosoli, R., (1987) Effects of ethylene oxide on soil microbial content and some chemical characteristics. *Plant and Soil* 102, p. 197-200.
- (31) Anderson, J.P.E. (1975) Einfluss von Temperatur und Feuchte auf Verdampfung, Abbau und Festlegung von Diallat im Boden. *Z. PflKrankh Pflschutz, Sonderheft VII*, p. 141-146.

▼ B

- (32) Hamaker, J.W., (1976) The application of mathematical modelling to the soil persistence and accumulation of pesticides. Proc. BCPC Symposium: Persistence of Insecticides and Herbicides, p. 181-199.
- (33) Goring, C.A.I., Laskowski, D.A., Hamaker, J.W., Meikle, R.W., (1975) Principles of pesticide degradation in soil. In 'Environmental Dynamics of Pesticides'. R. Haque and V.H. Freed, Eds., p. 135-172.
- (34) Timme, G., Frehse, H., Laska, V., (1986) Statistical interpretation and graphic representation of the degradational behaviour of pesticide residues. II. Pflanzenschutz — Nachrichten Bayer 39, p. 188-204.
- (35) Timme, G., Frehse, H., (1980) Statistical interpretation and graphic representation of the degradational behaviour of pesticide residues. I. Pflanzenschutz — Nachrichten Bayer 33, p. 47-60.
- (36) Gustafson D.I., Holden L.R., (1990) Non-linear pesticide dissipation in soil; a new model based on spatial variability. Environm. Sci. Technol. 24, p. 1032-1041.
- (37) Hurle K., Walker A., (1980) Persistence and its prediction. In Interactions between Herbicides and the Soil (R.J. Hance, Ed.), Academic Press, p. 83-122.

▼ **B**

Appendix 1

WATER TENSION, FIELD CAPACITY (FC) AND WATER HOLDING CAPACITY (WHC) ⁽¹⁾

Height of Water Column [cm]	pF ^(a)	bar ^(b)	Remarks
10 ⁷	7	10 ⁴	Dry Soil
1,6 · 10 ⁴	4,2	16	Wilting point
10 ⁴	4	10	
10 ³	3	1	
6 · 10 ²	2,8	0,6	
3,3 · 10 ²	2,5	0,33 ^(c)	} Range of Field capacity ^(d)
10 ²	2	0,1	
60	1,8	0,06	
33	1,5	0,033	
10	1	0,01	WHC (approximation)
1	0	0,001	Water saturated soil

^(a) pF = log of cm water column.

^(b) 1 bar = 10⁵ Pa.

^(c) Corresponds to an approximate water content of 10 % in sand, 35 % in loam and 45 % in clay.

^(d) Field capacity is not constant but varies with soil type between pF 1,5 and 2,5.

Water tension is measured in cm water column or in bar. Due to the large range of suction tension it is expressed simply as pF value which is equivalent to the logarithm of cm water column.

Field capacity is defined as the amount of water which can be stored against gravity by a natural soil two days after a longer raining period or after sufficient irrigation. It is determined in undisturbed soil in situ in the field. The measurement is thus not applicable to disturbed laboratory soil samples. FC values determined in disturbed soils may show great systematic variances.

Water holding capacity (WHC) is determined in the laboratory with undisturbed and disturbed soil by saturating a soil column with water by capillary transport. It is particularly useful for disturbed soils and can be up to 30 % greater than field capacity (1). It is also experimentally easier to determine than reliable FC-values.

Notes

⁽¹⁾ Mückenhausen, E., (1975) Die Bodenkunde und ihre geologischen, geomorphologischen, mineralogischen und petrologischen Grundlagen. DLG-Verlag, Frankfurt, Main.

▼ B*Appendix 2***SOIL MOISTURE CONTENTS (g water per 100 g dry soil) OF VARIOUS SOIL TYPES FROM VARIOUS COUNTRIES**

Soil type	Country	Soil moisture content at		
		WHC ⁽¹⁾	pF = 1,8	pF = 2,5
Sand	Germany	28,7	8,8	3,9
Loamy sand	Germany	50,4	17,9	12,1
Loamy sand	Switzerland	44,0	35,3	9,2
Silt loam	Switzerland	72,8	56,6	28,4
Clay loam	Brazil	69,7	38,4	27,3
Clay loam	Japan	74,4	57,8	31,4
Sandy loam	Japan	82,4	59,2	36,0
Silt loam	USA	47,2	33,2	18,8
Sandy loam	USA	40,4	25,2	13,3

⁽¹⁾ Water holding capacity.

▼B

Appendix 3

Figure 1

Example of a flow-through apparatus to study transformation of chemicals in soil ⁽¹⁾ ⁽²⁾

- | | | |
|--|---|--|
| 1: needle valve | 4: soil metabolism flask (water-logged only for anaerobic and paddy conditions) | 7, 8: sodium hydroxide trap for CO ₂ & other acidic volatiles |
| 2: gas washing bottle containing water | | 9: flow meter. |
| 3: ultramembrane (sterile conditions only), pore size 0.2 μm | 5: ethylene glycol trap for organic volatile compounds | |
| | 6: sulphuric acid trap for alkaline volatile compounds | |

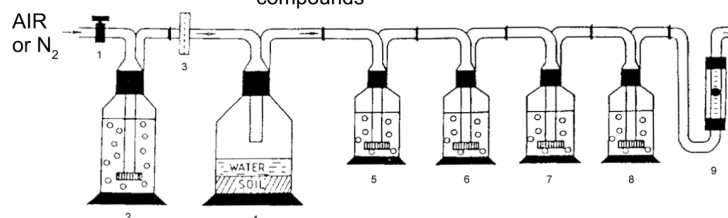
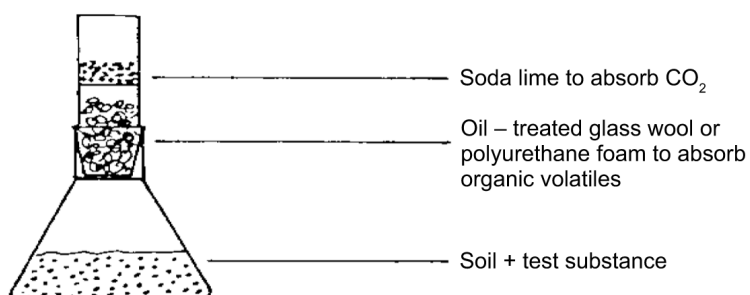

Figure 2

Example of a biometer-type flask for studying the transformation of chemicals in soil ⁽³⁾

⁽¹⁾ Guth, J.A., (1980) The study of transformations. In Interactions between Herbicides and the Soil (R.J. Hance, Ed.), Academic Press, p. 123-157.

⁽²⁾ Guth, J.A., (1981) Experimental approaches to studying the fate of pesticides in soil. In Progress in Pesticide Biochemistry, D.H. Hutson, T.R. Roberts, Eds. J. Wiley & Sons. Vol 1, p. 85-114.

⁽³⁾ Anderson, J.P.E., (1975) Einfluss von Temperatur und Feuchte auf Verdampfung, Abbau und Festlegung von Diallyl im Boden. Z. PflKrankh Pflschutz, Sonderheft VII, p. 141-146.

▼B**C.24. AEROBIC AND ANAEROBIC TRANSFORMATION IN AQUATIC SEDIMENT SYSTEMS****1. METHOD**

This test method is a replicate of the OECD TG 308 (2002).

1.1. INTRODUCTION

Chemicals can enter shallow or deep surface waters by such routes as direct application, spray drift, run-off, drainage, waste disposal, industrial, domestic or agricultural effluent and atmospheric deposition. This testing method describes a laboratory method to assess aerobic and anaerobic transformation of organic chemicals in aquatic sediment systems. It is based on existing Guidelines (1)(2)(3)(4)(5)(6). An OECD Workshop on Soil/Sediment Selection, held in Belgirate, Italy in 1995 (7) agreed, in particular, on the number and type of sediments for use in this test. It also made recommendations relating to collection, handling and storage of sediment samples, based on the ISO Guidance (8). Such studies are required for chemicals which are directly applied to water or which are likely to reach the aqueous environment by the routes described above.

The conditions in natural aquatic sediment systems are often aerobic in the upper water phase. The surface layer of sediment can be either aerobic or anaerobic, whereas the deeper sediment is usually anaerobic. To encompass all of these possibilities both aerobic and anaerobic tests are described in this document. The aerobic test simulates an aerobic water column over an aerobic sediment layer that is underlain with an anaerobic gradient. The anaerobic test simulates a completely anaerobic water-sediment system. If circumstances indicate that it is necessary to deviate significantly from these recommendations, for example by using intact sediment cores or sediments that may have been exposed to the test substance, other methods are available for this purpose (9).

1.2. DEFINITIONS

Standard International (SI) units should be used in any case.

Test substance: any substance, whether the parent or relevant transformation products.

Transformation products: all substances resulting from biotic and abiotic transformation reactions of the test substance including CO₂ and bound residues.

Bound residues: 'bound residues' represent compounds in soil, plant or animal that persist in the matrix in the form of the parent substance or its metabolite(s) after extractions. The extraction method must not substantially change the compounds themselves or the structure of the matrix. The nature of the bond can be clarified in part by matrix-altering extraction methods and sophisticated analytical techniques. To date, for example, covalent ionic and sorptive bonds, as well as entrapments, have been identified in this way. In general, the formation of bound residues reduces the bioaccessibility and the bio-availability significantly (10) (modified from IUPAC 1984 (11)).

▼ B

Aerobic transformation: (oxidising): reactions occurring in the presence of molecular oxygen (12).

Anaerobic transformation: (reducing): reactions occurring under exclusion of molecular oxygen (12).

Natural waters: are surface waters obtained from ponds, rivers, streams, etc.

Sediment: is a mixture of mineral and organic chemical constituents, the latter containing compounds of high carbon and nitrogen content and of high molecular masses. It is deposited by natural water and forms an interface with that water.

Mineralisation: is the complete degradation of an organic compound to CO₂, H₂O under aerobic conditions, and CH₄, CO₂ and H₂O under anaerobic conditions. In the context of this test method, when radio-labelled compound is used, mineralisation means extensive degradation of a molecule during which a labelled carbon atom is oxidised or reduced quantitatively with release of the appropriate amount of ¹⁴CO₂ or ¹⁴CH₄, respectively.

Half-life, t_{0,5}, is the time taken for 50 % transformation of a test substance when the transformation can be described by first-order kinetics; it is independent of the initial concentration.

DT₅₀ (Disappearance Time 50): is the time within which the initial concentration of the test substance is reduced by 50 %.

DT₇₅ (DISAPPEARANCE TIME 75): IS THE TIME WITHIN WHICH THE INITIAL CONCENTRATION OF THE TEST SUBSTANCE IS REDUCED BY 75 %.

DT₉₀ (Disappearance Time 90): is the time within which the initial concentration of the test substance is reduced by 90 %.

1.3. REFERENCE SUBSTANCES

Reference substances should be used for the identification and quantification of transformation products by spectroscopic and chromatographic methods.

1.4. INFORMATION ON THE TEST SUBSTANCE

Non-labelled or isotope-labelled test substance can be used to measure the rate of transformation although labelled material is preferred. Labelled material is required for studying the pathway of transformation and for establishing a mass balance. ¹⁴C-labelling is recommended, but the use of other isotopes, such as ¹³C, ¹⁵N, ³H, ³²P, may also be useful. As far as possible, the label should be positioned in the most stable part(s) of the molecule⁽¹⁾. The chemical and/or radiochemical purity of the test substance should be at least 95 %.

Before carrying out a test, the following information about the test substance should be available:

- (a) solubility in water (Method A.6);
- (b) solubility in organic solvents;
- (c) vapour pressure (Method A.4) and Henry's Law constant;

⁽¹⁾ For example, if the substance contains one ring, labelling on this ring is required; if the test substance contains two or more rings, separate studies may be needed to evaluate the fate of each labelled ring and to obtain suitable information on formation of transformation products.

▼ B

- (d) n-octanol/water partition coefficient (Method A.8);
- (e) adsorption coefficient (K_d , K_f or K_{oc} , where appropriate) (Method C.18);
- (f) hydrolysis (Method C.7);
- (g) dissociation constant (pK_a) (OECD Guideline 112) (13);
- (h) chemical structure of the test substance and position of the isotope-label(s), if applicable.

Note: the temperature at which these measurements were made should be reported.

Other useful information may include data on toxicity of the test substance to microorganisms, data on ready and/or inherent biodegradability, and data on aerobic and anaerobic transformation in soil.

Analytical methods (including extraction and clean-up methods) for identification and quantification of the test substance and its transformation products in water and in sediment should be available (see Section 1.7.2).

1.5. PRINCIPLE OF THE TEST METHOD

The method described in this test employs an aerobic and an anaerobic aquatic sediment (see Appendix 1) system which allows:

the measurement of the transformation rate of the test substance in a water-sediment system,

the measurement of the transformation rate of the test substance in the sediment,

the measurement of the mineralisation rate of the test substance and/or its transformation products (when ^{14}C -labelled test substance is used),

the identification and quantification of transformation products in water and sediment phases including mass balance (when labelled test substance is used),

the measurement of the distribution of the test substance and its transformation products between the two phases during a period of incubation in the dark (to avoid, for example, algal blooms) at constant temperature. Half-lives, DT_{50} , DT_{75} and DT_{90} values are determined where the data warrant, but should not be extrapolated far past the experimental period (see Section 1.2).

At least two sediments and their associated waters are required for both the aerobic and the anaerobic studies respectively (7). However, there may be cases where more than two aquatic sediments should be used, for example, for a chemical that may be present in freshwater and/or marine environments.

▼ B

1.6. APPLICABILITY OF THE TEST

The method is generally applicable to chemical substances (unlabelled or labelled) for which an analytical method with sufficient accuracy and sensitivity is available. It is applicable to slightly volatile, non-volatile, water-soluble or poorly water-soluble compounds. The test should not be applied to chemicals which are highly volatile from water (e.g. fumigants, organic solvents) and thus cannot be kept in water and/or sediment under the experimental conditions of this test.

The method has been applied so far to study the transformation of chemicals in fresh waters and sediments, but in principle can also be applied to estuarine/marine systems. It is not suitable to simulate conditions in flowing water (e.g. rivers) or the open sea.

1.7. QUALITY CRITERIA

1.7.1. **Recovery**

Extraction and analysis of, at least, duplicate water and sediment samples immediately after the addition of the test substance gives a first indication of the repeatability of the analytical method and of the uniformity of the application procedure for the test substance. Recoveries for later stages of the experiments are given by the respective mass balances (when labelled material is used). Recoveries should range from 90 % to 110 % for labelled chemicals (6) and from 70 % to 110 % for non-labelled chemicals.

1.7.2. **Repeatability and sensitivity of analytical method**

Repeatability of the analytical method (excluding the initial extraction efficiency) to quantify test substance and transformation products can be checked by duplicate analysis of the same extract of the water or the sediment samples which were incubated sufficiently long enough for formation of transformation products.

The limit of detection (LOD) of the analytical method for the test substance and for the transformation products should be at least 0,01 mg·kg⁻¹ in water or sediment (as test substance) or 1 % of the initial amount applied to a test system whichever is lower. The limit of quantification (LOQ) should also be specified.

1.7.3. **Accuracy of transformation data**

Regression analysis of the concentrations of the test substance as a function of time gives the appropriate information on the accuracy of the transformation curve and allows the calculation of the confidence limits for half-lives (if pseudo first-order kinetics apply) or DT₅₀ values and, if appropriate, DT₇₅ and DT₉₀ values.

1.8. DESCRIPTION OF THE METHOD

1.8.1. **Test system and apparatus**

The study should be performed in glass containers (e.g. bottles, centrifuge tubes), unless preliminary information (such as n-octanol-water partition coefficient, sorption data, etc.) indicates that the test substance may adhere to glass, in which case an alternative material (such as Teflon) may have to be considered. Where the test substance is known to adhere to glass, it may be possible to alleviate this problem using one or more of the following methods:

▼ B

- determine the mass of test substance and transformation products sorbed to glass,

- ensure a solvent wash of all glassware at the end of the test,

- use of formulated products (see also Section 1.9.2),

- use an increased amount of co-solvent for addition of test substance to the system; if a co-solvent is used it should be a co-solvent that does not solvolyse the test substance.

Examples of typical test apparatus, i.e. gas flow-through and biometer-type systems, are shown in Appendices 2 and 3, respectively (14). Other useful incubation systems are described in reference 15. The design of the experimental apparatus should permit the exchange of air or nitrogen and the trapping of volatile products. The dimensions of the apparatus must be such that the requirements of the test are complied with (see Section 1.9.1). Ventilation may be provided by either gentle bubbling or by passing air or nitrogen over the water surface. In the latter case gentle stirring of the water from above may be advisable for better distribution of the oxygen or nitrogen in the water. CO₂-free air should not be used as this can result in increases in the pH of the water. In either case, disturbance of the sediment is undesirable and should be avoided as far as possible. Slightly volatile chemicals should be tested in a biometer-type system with gentle stirring of the water surface. Closed vessels with a headspace of either atmospheric air or nitrogen and internal vials for the trapping of volatile products can also be used (16). Regular exchange of the headspace gas is required in the aerobic test in order to compensate for the oxygen consumption by the biomass.

Suitable traps for collecting volatile transformation products include but are not restricted to 1 mol·dm⁻³ solutions of potassium hydroxide or sodium hydroxide for carbon dioxide ⁽¹⁾ and ethylene glycol, ethanolamine or 2 % paraffin in xylene for organic compounds. Volatiles formed under anaerobic conditions, such as methane, can be collected, for example, by molecular sieves. Such volatiles can be combusted, for example, to CO₂ by passing the gas through a quartz tube filled with CuO at a temperature of 900 °C and trapping the CO₂ formed in an absorber with alkali (17).

Laboratory instrumentation for chemical analysis of test substance and transformation products is required (e.g. gas liquid chromatography (GLC), high performance liquid chromatography (HPLC), thin-layer chromatography (TLC), mass spectroscopy (MS), gas chromatography-mass spectroscopy (GC-MS), liquid chromatography-mass spectrometry (LC-MS), nuclear magnetic resonance (NMR), etc.), including detection systems for radiolabelled or non-labelled chemicals as appropriate. When radiolabelled material is used a liquid scintillation counter and combustion oxidiser (for the combustion of sediment samples prior to analysis of radioactivity) will also be required.

Other standard laboratory equipment for physical-chemical and biological determinations (see Section Table 1, Section 1.8.2.2), glassware, chemicals and reagents are required as appropriate.

⁽¹⁾ As these alkaline absorption solutions also absorb the carbon dioxide from the ventilation air and that formed by respiration in aerobic experiments, they have to be exchanged in regular intervals to avoid their saturation and thus loss of their absorption capacity.

▼ B**1.8.2. Selection and number of aquatic sediments**

The sampling sites should be selected in accordance with the purpose of the test in any given situation. In selecting sampling sites, the history of possible agricultural, industrial or domestic inputs to the catchment and the waters upstream must be considered. Sediments should not be used if they have been contaminated with the test substance or its structural analogues within the previous four years.

1.8.2.1. Sediment selection

Two sediments are normally used for the aerobic studies (7). The two sediments selected should differ with respect to organic carbon content and texture. One sediment should have a high organic carbon content (2,5-7,5 %) and a fine texture, the other sediment should have a low organic carbon content (0,5-2,5 %) and a coarse texture. The difference between the organic carbon contents should normally be at least 2 %. 'Fine texture' is defined as a [clay + silt] ⁽¹⁾ content of > 50 % and 'coarse texture' is defined as a [clay + silt] content of < 50 %. The difference in [clay + silt] content for the two sediments should normally be at least 20 %. In cases, where a chemical may also reach marine waters, at least one of the water-sediment systems should be of marine origin.

For the strictly anaerobic study, two sediments (including their associated waters) should be sampled from the anaerobic zones of surface water bodies (7). Both the sediment and the water phases should be handled and transported carefully under exclusion of oxygen.

Other parameters may be important in the selection of sediments and should be considered on a case-by-case basis. For example, the pH range of sediments would be important for testing chemicals for which transformation and/or sorption may be pH-dependent. pH-dependency of sorption might be reflected by the pK_a of the test substance.

1.8.2.2. Characterisation of water-sediment samples

Key parameters that must be measured and reported (with reference to the method used) for both water and sediment, and the stage of the test at which those parameters are to be determined are summarised in the Table hereafter. For information, methods for determination of these parameters are given in references (18)(19)(20)(21).

In addition, other parameters may need to be measured and reported on a case by case basis (e.g. for freshwater: particles, alkalinity, hardness, conductivity, NO_3/PO_4 (ratio and individual values); for sediments: cation exchange capacity, water holding capacity, carbonate, total nitrogen and phosphorus; and for marine systems: salinity). Analysis of sediments and water for nitrate, sulfate, bioavailable iron, and possibly other electron acceptors may be also useful in assessing redox conditions, especially in relation to anaerobic transformation.

⁽¹⁾ (Clay + silt) is the mineral fraction of the sediment with particle size of < 50 μm .

Measurement of parameters for characterisation of water-sediment samples (7)(22)(23)

Parameter	Stage of test procedure					
	field sampling	post-handling	start of acclimation	start of test	during test	end of test
Water						
Origin/source	x					
Temperature	x					
pH	x		x	x	x	x
TOC			x	x		x
O ₂ concentration*	x		x	x	x	x
Redox Potential*			x	x	x	x
Sediment						
Origin/source	x					
Depth of layer	x					
pH		x	x	x	x	x
Particle size distribution		x				
TOC		x	x	x		x
Microbial biomass (*)		x		x		x
Redox potential (**)	Observation (colour/smell)		x	x	x	x

(*) Microbial respiration rate method (26), fumigation method (27) or plate count measurements (e.g. bacteria, actinomycetes, fungi and total colonies) for aerobic studies; methanogenesis rate for anaerobic studies.

(**) Recent research results have shown that measurements of water oxygen concentrations and of redox potentials have neither a mechanistic nor a predictive value as far as growth and development of microbial populations in surface waters are concerned (24)(25). Determination of the biochemical oxygen demand (BOD, at field sampling, start and end of test) and of concentrations of micro/macro nutrients Ca, Mg and Mn (at start and end of test) in water and the measurement of total N and total P in sediments (at field sampling and end of test) may be better tools to interpret and evaluate aerobic biotransformation rates and routes.

1.8.3. Collection, handling and storage
1.8.3.1. Collection

The draft ISO guidance on sampling of bottom sediment (8) should be used for sampling of sediment. Sediment samples should be taken from the entire 5 to 10 cm upper layer of the sediment. Associated water should be collected from the same site or location and at the same time as the sediment. For the anaerobic study, sediment and associated water should be sampled and transported under exclusion of oxygen (28)(see Section 1.8.2.1). Some sampling devices are described in the literature (8)(23).

▼ B1.8.3.2. *Handling*

The sediment is separated from the water by filtration and the sediment wet-sieved to a 2 mm-sieve using excess location water that is then discarded. Then known amounts of sediments and water are mixed at the desired ratio (see Section 1.9.1) in incubation flasks and prepared for the acclimation period (see Section 1.8.4). For the anaerobic study, all handling steps have to be done under exclusion of oxygen (29)(30)(31)(32)(33).

1.8.3.3. *Storage*

Use of freshly sampled sediment and water is strongly recommended, but if storage is necessary, sediment and water should be sieved as described above and stored together, water-logged (6-10 cm water layer), in the dark, at $4 \pm 2^\circ\text{C}^4$ for a maximum of four weeks (7)(8)(23). Samples to be used for aerobic studies should be stored with free access of air (e.g. in open containers), whereas those for anaerobic studies under exclusion of oxygen. Freezing of sediment and water and drying-out of the sediment must not occur during transportation and storage.

1.8.4. **Preparation of the sediment/water samples for the test**

A period of acclimation should take place prior to adding the test substance, with each sediment/water sample being placed in the incubation vessel to be used in the main test, and the acclimation to be carried out under exactly the same conditions as the test incubation (see Section 1.9.1). The acclimation period is the time needed to reach reasonable stability of the system, as reflected by pH, oxygen concentration in water, redox potential of the sediment and water, and macroscopic separation of phases. The period of acclimation should normally last between one week and two weeks and should not exceed four weeks. Results of determinations performed during this period should be reported.

1.9. PERFORMANCE OF THE TEST

1.9.1. **Test conditions**

The test should be performed in the incubation apparatus (see Section 1.8.1) with a water sediment volume ratio between 3:1 and 4:1, and a sediment layer of 2,5 cm ($\pm 0,5$ cm).⁽¹⁾ A minimum amount of 50 g of sediment (dry weight basis) per incubation vessel is recommended.

The test should be performed in the dark at a constant temperature in the range of 10 to 30 °C. A temperature of $(20 \pm 2)^\circ\text{C}$ is appropriate. Where appropriate, an additional lower temperature (e.g. 10 °C) may be considered on a case-by-case basis, depending on the information required from the test. Incubation temperature should be monitored and reported.

⁽¹⁾ Recent studies have shown that storage at 4 °C can lead to a decrease of the organic carbon content of the sediment which may possibly result in a decrease of microbial activity (34).

▼B**1.9.2. Treatment and application of test substance**

One test concentration of chemical is used⁽¹⁾. For crop protection chemicals applied directly to water bodies, the maximum dosage on the label should be taken as, the maximum application rate calculated on the basis of the surface area of the water in the test vessel. In all other cases, the concentration to be used should be based on predictions from environmental emissions. Care must be taken to ensure that an adequate concentration of test substance is applied in order to characterise the route of transformation and the formation and decline of transformation products. It may be necessary to apply higher doses (e.g. 10 times) in situations where test substance concentrations are close to limits of detection at the start of the study and/or where major transformation products could not readily be detected when present at 10 % of the test substance application rate. However, if higher test concentrations are used they should not have a significant adverse effect on the microbial activity of the water-sediment system. In order to achieve a constant concentration of test substance in vessels of differing dimensions an adjustment to the quantity of the material applied may be considered appropriate, based on the depth of the water column in the vessel in relation to the depth of water in the field (which is assumed to be 100 cm, but other depths can be used). See Appendix 4 for an example calculation.

Ideally the test substance should be applied as an aqueous solution into the water phase of the test system. If unavoidable, the use of low amounts of water miscible solvents (such as acetone, ethanol) is permitted for application and distribution of the test substance, but this should not exceed 1 % v/v and should not have adverse effects on microbial activity of the test system. Care should be exercised in generating the aqueous solution of the test substance — use of generator columns and pre-mixing may be appropriate to ensure complete homogeneity. Following addition of the aqueous solution to the test system, gentle mixing of the water phase is recommended, disturbing the sediment as little as possible.

The use of formulated products is not routinely recommended as the formulation ingredients may affect the distribution of the test substance and/or transformation products between water and sediment phases. However, for poorly water-soluble test substances, the use of formulated material may be an appropriate alternative.

The number of incubation vessels depends on the number of sampling times (see Section 1.9.3). A sufficient number of test systems should be included so that two systems may be sacrificed at each sampling time. Where control units of each aquatic sediment system are employed, they should not be treated with the test substance. The control units can be used to determine the microbial biomass of the sediment and the total organic carbon of the water and sediment at the termination of the study. Two of the control units (i.e. one control unit for each aquatic sediment) can be used to monitor the required parameters in the sediment and water during the acclimation period (see Table in Section 1.8.2.2). Two additional control units have to be included in case the test substance is applied by means of a solvent to measure adverse effects on the microbial activity of the test system.

⁽¹⁾ Test with a second concentration can be useful for chemicals that reach surface waters by different entry routes resulting in significantly different concentrations, as long as the lower concentration can be analysed with sufficient accuracy.

▼ B**1.9.3. Test duration and sampling**

The duration of the experiment should normally not exceed 100 days (6), and should continue until the degradation pathway and water/sediment distribution pattern are established or when 90 % of the test substance has dissipated by transformation and/or volatilisation. The number of sampling times should be at least six (including zero time), with an optional preliminary study (see Section 1.9.4) being used to establish an appropriate sampling regime and the duration of the test, unless sufficient data is available on the test substance from previous studies. For hydrophobic test substances, additional sampling points during the initial period of the study may be necessary in order to determine the rate of distribution between water and sediment phases.

At appropriate sampling times, whole incubation vessels (in replicate) are removed for analysis. Sediment and overlying water are analysed separately⁽¹⁾. The surface water should be carefully removed with minimum disturbance of the sediment. The extraction and characterisation of the test substance and transformation products should follow appropriate analytical procedures. Care should be taken to remove material that may have adsorbed to the incubation vessel or to inter-connecting tubing used to trap volatiles.

1.9.4. Optional preliminary test

If duration and sampling regime cannot be estimated from other relevant studies on the test substance, an optional preliminary test may be considered appropriate, which should be performed using the same test conditions proposed for the definitive study. Relevant experimental conditions and results from the preliminary test, if performed, should be briefly reported.

1.9.5. Measurements and analysis

Concentration of the test substance and the transformation products at every sampling time in water and sediment should be measured and reported (as a concentration and as percentage of applied). In general, transformation products detected at ≥ 10 % of the applied radioactivity in the total water-sediment system at any sampling time should be identified unless reasonably justified otherwise. Transformation products for which concentrations are continuously increasing during the study should also be considered for identification, even if their concentrations do not exceed the limits given above, as this may indicate persistence. The latter should be considered on a case by case basis, with justifications being provided in the report.

Results from gases/volatiles trapping systems (CO₂ and others, i.e. volatile organic compounds) should be reported at each sampling time. Mineralisation rates should be reported. Non-extractable (bound) residues in sediment are to be reported at each sampling point.

⁽¹⁾ In cases where rapid re-oxidation of anaerobic transformation products may readily occur, anaerobic conditions should be maintained during sampling and analysis.

▼B**2. DATA****2.1. TREATMENT OF RESULTS**

Total mass balance or recovery (see Section 1.7.1) of added radioactivity is to be calculated at every sampling time. Results should be reported as a percentage of added radioactivity. Distribution of radioactivity between water and sediment should be reported as concentrations and percentages, at every sampling time.

Half-life, DT_{50} and, if appropriate, DT_{75} and DT_{90} of the test substance should be calculated along with their confidence limits (see Section 1.7.3). Information on the rate of dissipation of the test substance in the water and sediment can be obtained through the use of appropriate evaluation tools. These can range from application of pseudo-first order kinetics, empirical curve-fitting techniques which apply graphical or numerical solutions and more complex assessments using, for example, single- or multi-compartment models. Further details can be obtained from the relevant published literature (35)(36)(37).

All approaches have their strengths and weaknesses and vary considerably in complexity. An assumption of first-order kinetics may be an oversimplification of the degradation and distribution processes, but when possible gives a term (the rate constant or half-life) which is easily understood and of value in simulation modelling and calculations of predicted environmental concentrations. Empirical approaches or linear transformations can result in better fits of curves to data and therefore allow better estimation of half-lives, DT_{50} and, if appropriate, DT_{75} and DT_{90} values. The use of the derived constants, however, is limited. Compartment models can generate a number of useful constants of value in risk assessment that describe the rate of degradation in different compartments and the distribution of the chemical. They should also be used for estimation of rate constants for the formation and degradation of major transformation products. In all cases, the method chosen must be justified and the experimenter should demonstrate graphically and/or statistically the goodness of fit.

3. REPORTING**3.1. TEST REPORT**

The report must include the following information:

Test substance:

— common name, chemical name, CAS number, structural formula (indicating position of the label(s) when radiolabelled material is used) and relevant physical-chemical properties,

— purity (impurities) of test substance,

— radiochemical purity of labelled chemical and molar activity (where appropriate).

▼ B

Reference substances:

- chemical name and structure of reference substances used for the characterisation and/or identification of transformation products.

Test sediments and waters:

- location and description of aquatic sediment sampling site(s) including, if possible, contamination history,
- all information relating to the collection, storage (if any) and acclimation of water-sediment systems,
- characteristics of the water-sediment samples as listed in Table in section 1.8.2.2.

Test conditions:

- test system used (e.g. flow-through, biometer, way of ventilation, method of stirring, water volume, mass of sediment, thickness of both water and sediment layer, dimension of test vessels, etc.),
- application of test substance to test system: test concentration used, number of replicates and controls mode of application of test substance (e.g. use of solvent if any), etc.,
- incubation temperature,
- sampling times,
- extraction methods and efficiencies as well as analytical methods and detection limits,
- methods for characterisation/identification of transformation products,
- deviations from the test protocol or test conditions during the study.

Results:

- raw data figures of representative analyses (all raw data have to be stored in the GLP-archive),
- repeatability and sensitivity of the analytical methods used,
- rates of recovery (% values for a valid study are given in section 1.7.1),
- tables of results expressed as % of the applied dose and in $\text{mg} \cdot \text{kg}^{-1}$ in water, sediment and total system (% only) for the test substance and, if appropriate, for transformation products and non-extractable radioactivity,
- mass balance during and at the end of the studies,
- a graphical representation of the transformation in the water and sediment fractions and in total system (including mineralisation),
- mineralisation rates,

▼B

- half-life, DT₅₀ and, if appropriate, DT₇₅ and DT₉₀ values for the test substance and, where appropriate, for major transformation products including confidence limits in water, sediment and in total system,
- an assessment of the transformation kinetics of the test substance and, where appropriate, the major transformation products,
- a proposed pathway of transformation, where appropriate,
- discussion of results.

4. **REFERENCES**

- (1) BBA-Guidelines for the examination of plant protectors in the registration process., (1990) Part IV, Section 5-1: Degradability and fate of plant protectors in the water/sediment system. Germany.
- (2) Commission for registration of pesticides: Application for registration of a pesticide., (1991) Part G. Behaviour of the product and its metabolites in soil, water and air, Section G.2.1 (a). The Netherlands.
- (3) MAFF Pesticides Safety Directorate., (1992) Preliminary guideline for the conduct of biodegradability tests on pesticides in natural sediment/water systems. Ref No SC 9046. United-Kingdom.
- (4) Agriculture Canada: Environmental chemistry and fate., (1987) Guidelines for registration of pesticides in Canada. Aquatic (Laboratory) — Anaerobic and aerobic. Canada. p. 35-37.
- (5) US-EPA: Pesticide assessment guidelines, Subdivision N. Chemistry: Environmental fate (1982) Section 162-3, Anaerobic aquatic metabolism.
- (6) SETAC-Europe publication., (1995) Procedures for assessing the environmental fate and ecotoxicity of pesticides. Ed. Dr Mark R. Lynch. SETAC-Europe, Brussels.
- (7) OECD Test Guidelines Programme., (1995) Final Report of the OECD Workshop on Selection of Soils/sediments, Belgirate, Italy, 18-20 January 1995.
- (8) ISO/DIS 5667-12., (1994) Water quality — Sampling — Part 12: Guidance on sampling of bottom sediments.
- (9) US-EPA (1998a) Sediment/water microcosm biodegradation test. Harmonised Test Guidelines (OPPTS 835.3180). EPA 712-C-98-080.
- (10) DFG: Pesticide Bound Residues in Soil. Wiley-VCH (1998).
- (11) T.R. Roberts: Non-extractable pesticide residues in soils and plants. Pure Appl. Chem. 56, 945-956 (IUPAC 1984).
- (12) OECD Test Guideline 304A: Inherent Biodegradability in Soil (adopted 12 May 1981).
- (13) OECD (1993): Guidelines for Testing of Chemicals. Paris. OECD (1994-2000): Addenda 6-11 to Guidelines for the Testing of Chemicals.
- (14) Scholz, K., Fritz R., Anderson C. and Spiteller M. (1988) Degradation of pesticides in an aquatic model ecosystem. BCPC — Pests and Diseases, 3B-4, p. 149-158.

▼B

- (15) Guth, J.A., (1981) Experimental approaches to studying the fate of pesticides in soil. In Progress in Pesticide Biochemistry (D.H. Hutson, T.R. Roberts, Eds.), Vol. 1, 85-114. J. Wiley & Sons.
- (16) Madsen, T., Kristensen, P. (1997) Effects of bacterial inoculation and non-ionic surfactants on degradation of polycyclic aromatic hydrocarbons in soil. Environ. Toxicol. Chem. 16, p. 631-637.
- (17) Steber, J., Wierich, P. (1987) The anaerobic degradation of detergent range fatty alcohol ethoxylates. Studies with ¹⁴C-labelled model surfactants. Water Research 21, p. 661-667.
- (18) Black, C.A. (1965). Methods of Soil Analysis. Agronomy Monograph No 9. American Society of Agronomy, Madison.
- (19) APHA (1989) Standard Methods for Examination of Water and Wastewater (17th edition). American Public Health Association, American Water Works Association and Water Pollution Control Federation, Washington D.C.
- (20) Rowell, D.L. (1994) Soil Science Methods and Applications. Longman.
- (21) Light, T.S., (1972). Standard solution for redox potential measurements. Anal. Chemistry 44, p. 1038-1039.
- (22) SETAC-Europe publication (1991) Guidance document on testing procedures for pesticides in freshwater mesocosms. From the Workshop 'A Meeting of Experts on Guidelines for Static Field Mesocosms Tests', 3-4 July 1991.
- (23) SETAC-Europe publication. (1993) Guidance document on sediment toxicity tests and bioassays for freshwater and marine environments. From the Workshop on Sediment Toxicity Assessment (WOSTA), 8-10 November 1993. Eds.: I.R. Hill, P. Matthiessen and F. Heimbach.
- (24) Vink, J.P.M., van der Zee, S.E.A.T.M. (1997) Pesticide biotransformation in surface waters: multivariate analyses of environmental factors at field sites. Water Research 31, p. 2858-2868.
- (25) Vink, J.P.M., Schraa, G., van der Zee, S.E.A.T.M. (1999) Nutrient effects on microbial transformation of pesticides in nitrifying waters. Environ. Toxicol, p. 329-338.
- (26) Anderson, T.H., Domsch, K.H. (1985) Maintenance carbon requirements of actively-metabolising microbial populations under *in-situ* conditions. Soil Biol. Biochem. 17, p. 197-203.
- (27) ISO-14240-2., (1997) Soil quality — Determination of soil microbial biomass — Part 2: Fumigation-extraction method.
- (28) Beelen, P. Van and F. Van Keulen., (1990), The Kinetics of the Degradation of Chloroform and Benzene in Anaerobic Sediment from the River Rhine. Hydrobiol. Bull. 24 (1), p. 13-21.
- (29) Shelton, D.R. and Tiedje, J.M. (1984) General method for determining anaerobic biodegradation potential. App. Environ. Microbiol. 47, p. 850-857.
- (30) Birch, R.R., Biver, C., Campagna, R., Gledhill, W.E., Pagga, U., Steber, J., Reust, H. and Bontinck, W.J. (1989) Screening of chemicals for anaerobic biodegradation. Chemosphere 19, p. 1527-1550.
- (31) Pagga, U. and Beimborn, D.B. (1993) Anaerobic biodegradation tests for organic compounds. Chemosphere 27, p. 1499-1509.

▼B

- (32) Nuck, B.A. and Federle, T.W., (1986) A batch test for assessing the mineralisation of ¹⁴C-radiolabelled compounds under realistic anaerobic conditions. *Environ. Sci. Technol.* 30, p. 3597-3603.
- (33) US-EPA (1998b). Anaerobic biodegradability of organic chemicals. Harmonised Test Guidelines (OPPTS 835.3400). EPA 712-C-98-090.
- (34) Sijm, Haller and Schrap (1997) Influence of storage on sediment characteristics and drying sediment on sorption coefficients of organic contaminants. *Bulletin Environ. Contam. Toxicol.* 58, p. 961-968.
- (35) Timme, G., Frehse H. and Laska V. (1986) Statistical interpretation and graphic representation of the degradational behaviour of pesticide residues II. *Pflanzenschutz — Nachrichten Bayer*, 39, p. 187-203.
- (36) Timme, G., Frehse, H. (1980) Statistical interpretation and graphic representation of the degradational behaviour of pesticide residues I. *Pflanzenschutz — Nachrichten Bayer*, 33, p. 47-60.
- (37) Carlton, R.R., and Allen, R., (1994) The use of a compartment model for evaluating the fate of pesticides in sediment/water systems. *Brighton Crop Protection Conference — Pest and Diseases*, p. 1349-1354.

▼B*Appendix 1***GUIDANCE ON THE AEROBIC AND THE ANAEROBIC TEST SYSTEMS****Aerobic test system**

The aerobic test system described in this test method consists of an aerobic water layer (typical oxygen concentrations range from 7 to 10 mg·l⁻¹) and a sediment layer, aerobic at the surface and anaerobic below the surface (typical average redox potentials (E_h) in the anaerobic zone of the sediment range from — 80 to — 190 mV). Moistened air is passed over the surface of the water in each incubation unit to maintain sufficient oxygen in the head space.

Anaerobic test system

For the anaerobic test system, the test procedure is essentially the same as that outlined for the aerobic system with the exception that moistened nitrogen is passed above the surface of the water in each incubation unit to maintain a head space of nitrogen. The sediment and water are regarded as anaerobic once the redox potential (E_h) is lower than — 100 mV.

In the anaerobic test, assessment of mineralisation includes measurement of evolved carbon dioxide and methane.

▼B

Appendix 2

EXAMPLE OF A GAS FLOW-THROUGH APPARATUS

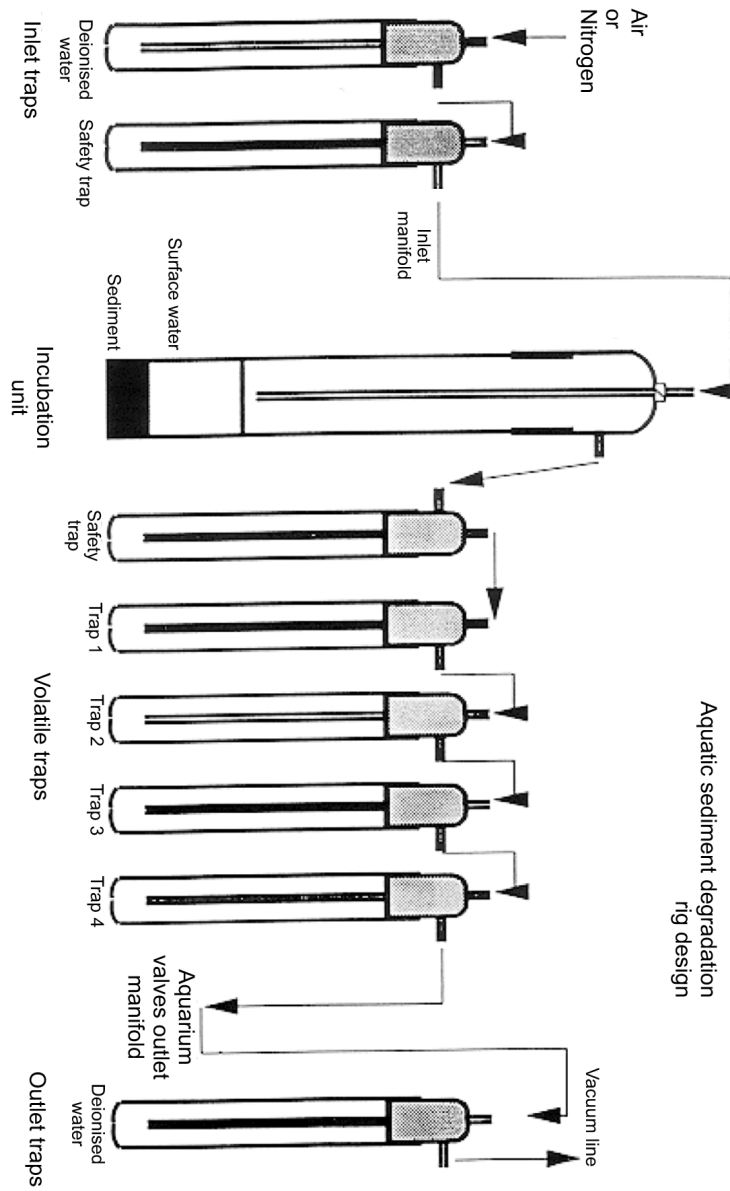

Safety trap, empty
 Trap 1:
 ethyleneglycol to trap organic volatiles
 Trap 2:
 sulphuric acid 0.1 M to trap alkaline volatiles

▼B

Appendix 3

EXAMPLE OF A BIOMETER APPARATUS

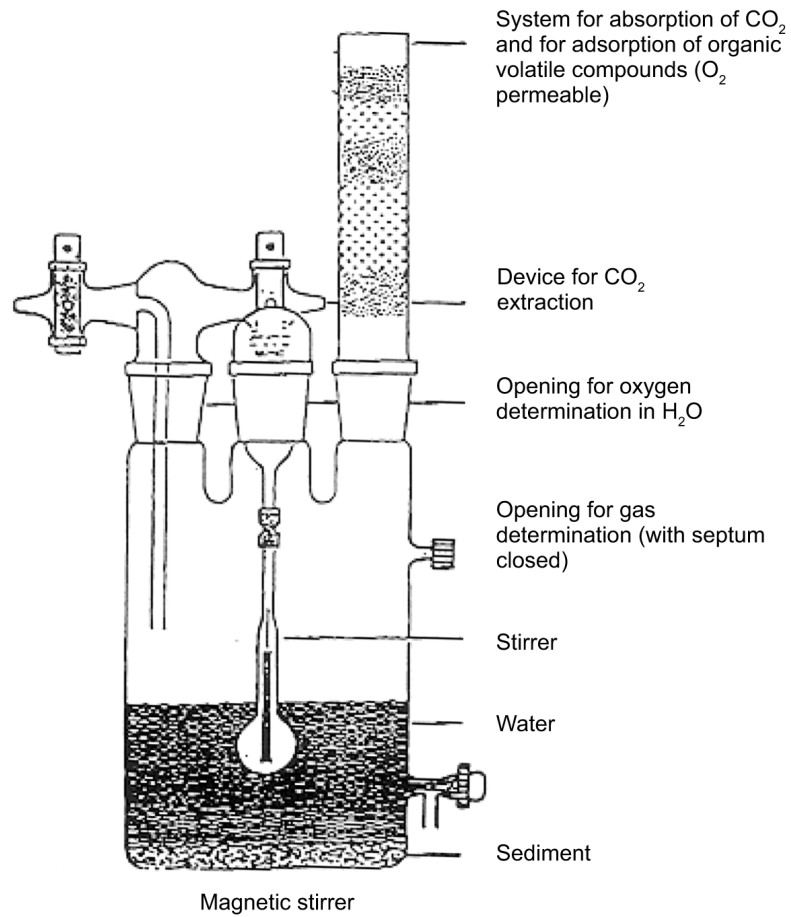

▼ B*Appendix 4***EXAMPLE CALCULATION FOR APPLICATION DOSE TO TEST VESSELS**

Cylinder internal diameter:	= 8 cm
Water column depth not including sediment:	= 12 cm
Surface area: $3,142 \times 4^2$	= 50,3 cm ²
Application rate: 500 g test substance/ha corresponds to 5 µg/cm ²	
Total µg: $5 \times 50,3$	= 251,5 µg
Adjust quantity in relation to a depth of 100 cm: $12 \times 251,5 \div 100$	= 30,18 µg
Volume of water column: $50,3 \times 12$	= 603 ml
Concentration in water: $30,18 \div 603$	= 0,050 µg/ml or 50 µg/l

▼ M1**C.25. AEROBIC MINERALISATION IN SURFACE WATER —
SIMULATION BIODEGRADATION TEST****1. METHOD**

This method is equivalent to OECD TG 309 (2004) (1).

1.1. INTRODUCTION

The purpose of this test is to measure the time course of biodegradation of a test substance at low concentration in aerobic natural water and to quantify the observations in the form of kinetic rate expressions. This simulation test is a laboratory shake flask batch test to determine rates of aerobic biodegradation of organic substances in samples of natural surface water (fresh, brackish or marine). It is based on the ISO/DIS 14592-1 (2) and it also includes elements from the testing methods C.23 and C.24 (3)(4). Optionally, with long test times, semi-continuous operation replaces batch operation in order to prevent deterioration of the test microcosm. The principal objective of the simulation test is to determine the mineralisation of the test substance in surface water, and mineralisation constitutes the basis for expressing degradation kinetics. However, an optional secondary objective of the test is to obtain information on the primary degradation and the formation of major transformation products. Identification of transformation products, and if possible quantification of their concentrations, are especially important for substances that are very slowly mineralised (e.g. with half-lives for total residual ^{14}C exceeding 60 days). Higher concentrations of the test substance (e.g. > 100 µg/l) should normally be used for identification and quantification of major transformation products due to analytical limitations.

A low concentration in this test means a concentration (e.g. less than 1 µg/l to 100 µg/l) which is low enough to ensure that the biodegradation kinetics obtained in the test reflect those expected in the environment. Compared to the total mass of biodegradable carbon substrates available in the natural water used for the test, the test substance present at low concentration will serve as a secondary substrate. This implies that the anticipated biodegradation kinetics is first order ('non-growth' kinetics) and that the test substance may be degraded by 'cometabolism'. First order kinetics implies that the rate of degradation (mg/L/day) is proportional to the concentration of substrate which declines over time. With true first order kinetics the specific degradation rate constant, k , is independent of time and concentration. That is, k does not vary appreciably during the course of an experiment and does not change with the added concentration between experiments. By definition, the specific degradation rate constant is equal to the relative change in concentration per time: $k = (1/C) \cdot (dC/dt)$. Although first order kinetics are normally expected under the prescribed conditions, there may be certain circumstances where other kinetics are more appropriate. Deviations from first order kinetics may e.g. be observed if mass transfer phenomena such as the diffusion rate, rather than the biological reaction rate, is limiting the rate of biotransformation. However, the data can nearly always be described by pseudo first order kinetics accepting a concentration dependent rate constant.

▼ M1

Information on biodegradability of the test substance at higher concentrations (e.g. from standard screening tests) as well as information on abiotic degradability, transformation products and relevant physico-chemical properties should be available prior to the test to help establish the experimental planning and interpret the results. The use of ^{14}C labelled test substances and the determination of the phase distribution of ^{14}C at the end of the test, enable ultimate biodegradability to be determined. When non-labelled test substance is used, ultimate biodegradation can only be estimated if a higher concentration is tested and all the major transformation products are known.

1.2. DEFINITIONS

Primary biodegradation: The structural change (transformation) of a chemical substance by microorganisms resulting in the loss of chemical identity.

Functional biodegradation: The structural change (transformation) of a chemical substance by microorganisms resulting in the loss of a specific property.

Ultimate aerobic biodegradation: The breakdown of a chemical substance by microorganisms in the presence of oxygen to carbon dioxide, water and mineral salts of any other elements present (mineralisation) and the production of new biomass and organic microbial biosynthesis products.

Mineralisation: The breakdown of a chemical substance or organic matter by microorganisms in the presence of oxygen to carbon dioxide, water and mineral salts of any other elements present.

Lag phase: The time from the start of a test until adaptation of the degrading micro organisms is achieved and the biodegradation degree of a chemical substance or organic matter has increased to a detectable level (e.g. 10 % of the maximum theoretical biodegradation, or lower, dependent on the accuracy of the measuring technique).

Maximum level of biodegradation: The degree of biodegradation of a chemical substance or organic matter in a test, recorded in per cent, above which no further biodegradation takes place during the test.

Primary substrate: A collection of natural carbon and energy sources that provide growth and maintenance of the microbial biomass.

Secondary substrate: A substrate component present in such a low concentration, that by its degradation, only insignificant amounts of carbon and energy are supplied to the competent microorganisms, as compared to the carbon and energy supplied by the degradation of main substrate components (primary substrates).

Degradation rate constant: A first order or pseudo first order kinetic rate constant, k (d^{-1}), which indicates the rate of degradation processes. For a batch experiment k is estimated from the initial part of the degradation curve obtained after the end of the lag phase.

▼ M1

Half-life, $t_{1/2}$ (d): Term used to characterise the rate of a first order reaction. It is the time interval that corresponds to a concentration decrease by a factor 2. The half-life and the degradation rate constant are related by the equation $t_{1/2} = \ln 2/k$.

Degradation half time, DT_{50} (d): Term used to quantify the outcome of biodegradation tests. It is the time interval, including the lag phase, needed to reach a value of 50 % biodegradation.

Limit of detection (LOD) and limit of quantification (LOQ): The limit of detection (LOD) is the concentration of a substance below which the identity of the substance cannot be distinguished from analytical artefacts. The limit of quantification (LOQ) is the concentration of a substance below which the concentration cannot be determined with an acceptable accuracy.

Dissolved organic carbon (DOC): That part of the organic carbon in a sample of water which cannot be removed by specified phase separation, for example by centrifugation at $40\,000\text{ ms}^{-2}$ for 15 min. or by membrane filtration using membranes with pores of $0,2\text{ }\mu\text{m}$ - $0,45\text{ }\mu\text{m}$ diameter.

Total organic ^{14}C activity (TOA): The total ^{14}C activity associated with organic carbon.

Dissolved organic ^{14}C activity (DOA): The total ^{14}C activity associated with dissolved organic carbon.

Particulate organic ^{14}C activity (POA): The total ^{14}C activity associated with particulate organic carbon.

1.3. APPLICABILITY OF THE TEST

This simulation test is applicable to non-volatile or slightly volatile organic substances tested at low concentrations. Using flasks open to the atmosphere (e.g. cotton wool plugged), substances with Henry's law constants less than about $1\text{ Pa}\cdot\text{m}^3/\text{mol}$ (approx. $10^{-5}\text{ atm}\cdot\text{m}^3/\text{mol}$) can be regarded as non-volatile in practice. Using closed flasks with a headspace, it is possible to test slightly volatile substances (with Henry's law constants $< 100\text{ Pa}\cdot\text{m}^3/\text{mol}$ or $< 10^{-3}\text{ atm}\cdot\text{m}^3/\text{mol}$) without losses from the test system. Loss of ^{14}C -labelled substances may occur, if the right precautions are not exercised, when the CO_2 is stripped off. In such situations, it may be necessary to trap CO_2 in an internal absorber with alkali or to use an external CO_2 absorber system (direct $^{14}\text{CO}_2$ determination; see Appendix 3). For the determination of biodegradation kinetics, the concentrations of the test substance must be below its water solubility. It should be noted, however, that literature values of water solubility may be considerably higher than the solubility of the test substance in natural waters. Optionally, the solubility of especially poorly water-soluble test substances may be established by use of the natural waters being tested.

The method can be used for simulating biodegradation in surface water free of coarse particles (pelagic test) or in turbid surface water which, e.g. might exist near a water/sediment interface (suspended sediment test).

▼ M1

1.4. PRINCIPLE OF THE TEST

The test is performed in batch by incubating the test substance with either surface water only (pelagic test) or surface water amended with suspended solids/sediment of 0,01 to 1 g/L dry weight (suspended sediment test) to simulate a water body with suspended solids or re-suspended sediment. The suspended solids/sediment concentration in the lower range of this interval is typical for most surface waters. The test flasks are incubated in darkness at an environmental temperature under aerobic conditions and agitation. At least two different concentrations of test substance should be used in order to determine the degradation kinetics. The concentrations should differ from each other by a factor of 5 to 10 and should represent the expected range of concentrations in the environment. The maximum concentration of the test substance should not exceed 100 µg/L, but maximum test concentrations below 10 µg/L or less are preferred to ensure that the biodegradation follows first order kinetics. The lowest concentration should not exceed 10 µg/L, but lowest test concentrations of 1-2 µg/L or less than 1 µg/L are preferred. Normally an adequate analysis of such low concentration can be achieved by use of commercially available ¹⁴C-labelled substances. Because of analytical limitations, it is frequently impossible to measure the concentration of the test substance with the required accuracy, if the test substance is applied at a concentration ≤ 100 µg/L (see second paragraph in section 1.7.2). Higher concentrations of test substance (> 100 µg/L and sometimes > 1 mg/L) may be used for the identification and quantification of major transformation products or if a specific analysis method with a low detection limit is not available. If high concentrations of test substance are tested, it may not be possible to use the results to estimate the first order degradation constant and half-life, as the degradation will probably not follow first order kinetics.

Degradation is followed at appropriate time intervals, by measuring either the residual ¹⁴C or the residual concentration of test substance when specific chemical analysis is used. ¹⁴C labelling of the most stable part of the molecule ensures the determination of the total mineralisation, while ¹⁴C labelling of a less stable part of the molecule, as well as the use of specific analysis, enable the assessment of only primary biodegradation. However, the most stable part does not necessarily include the relevant functional moiety of the molecule (that can be related to a specific property such as toxicity, bioaccumulation, etc.). If this is the case, it may be appropriate to use a test substance, which is ¹⁴C-labelled, in the functional part in order to follow the elimination of the specific property.

1.5. INFORMATION ON THE TEST SUBSTANCE

Both radiolabelled and non-labelled test substances can be used in this test. ¹⁴C-labelling technique is recommended and labelling should normally be in the most stable part(s) of the molecule (see also section 1.4). For substances containing more than one aromatic ring, one or more carbons in each ring should preferably be ¹⁴C-labelled. In addition, one or more carbons on both sides of easily degradable linkages should preferably be ¹⁴C-labelled. The chemical and/or radiochemical purity of the test substance should be >95 %. For radiolabelled substances, a specific activity of approx. 50 µCi/mg (1,85 MBq) or more is preferred in order to facilitate ¹⁴C measurements in tests conducted with low initial concentrations. The following information on the test substance should be available:

▼ M1

- solubility in water [Method A.6],
- solubility in organic solvent(s) (substances applied with solvent or with low solubility in water),
- dissociation constant (pKa) if the substance is liable to protonation or deprotonation [OECD TG 112] (5),
- vapour pressure [Method A.4] and Henry's law constant,
- chemical stability in water and in the dark (hydrolysis) [Method C.7].

When poorly water-soluble substances are being tested in seawater, it may also be useful to know the salting out constant (or 'Setschenow constant') K^s , which is defined by the expression: $\log(S/S') = K^s C_m$, where S and S' are the solubility of the substance in fresh water and seawater, respectively, and C_m is the molar salt concentration.

If the test is carried out as a 'suspended sediment test' the following information should also be available:

- n-octanol/water partition coefficient [Method A.8],
- adsorption coefficient [Method C.18].

Other useful information may include:

- environmental concentration, if known or estimated,
- toxicity of the test substance to microorganisms [Method C.11],
- ready and/or inherent biodegradability [Methods C.4 A-F, C.12, C.9, OECD TG 302 (5)],
- aerobic or anaerobic biodegradability in soil and sediment/water transformation studies [Methods C.23, C.24].

1.6. REFERENCE SUBSTANCE

A substance, which is normally easily degraded under aerobic conditions (e.g. aniline or sodium benzoate) should be used as reference substance. The expected time interval for degradation of aniline and sodium benzoate is usually less than 2 weeks. The purpose of the reference substances is to ensure that the microbial activity of the test water is within certain limits; i.e. that the water contains an active microbial population.

▼ M1

1.7. QUALITY CRITERIA

1.7.1. **Recovery**

Immediately after addition of the test substance, each initial test concentration should be verified by measurements of ^{14}C activity, or by chemical analyses in the case of non-labelled substances, in at least duplicate samples. This provides information on the applicability and repeatability of the analytical method and on the homogeneity of the distribution of the test substance. Normally, the measured initial ^{14}C activity or test substance concentration is used in the subsequent analyses of data rather than the nominal concentration as losses due to sorption and dosing errors thereby are compensated. For ^{14}C -labelled test substance, the level of recovery at the end of the experiment is given by mass balance (see last paragraph in section 1.8.9.4). Ideally, the radiolabelled mass balance should range from 90 % to 110 %, whereas the analytical accuracy should lead to an initial recovery of between 70 % and 110 % for non-labelled test substances. These ranges should be interpreted as targets and should not be used as criteria for acceptance of the test. Optionally, the analytical accuracy may be determined for the test substance at a lower concentration than the initial concentration and for major transformation products.

1.7.2. **Repeatability and sensitivity of analytical method**

Repeatability of the analytical method (including the efficiency of the initial extraction) to quantify the test substance, and transformation products, if appropriate, should be checked by five replicate analyses of the individual extracts of the surface water.

The limit of detection (LOD) of the analytical method for the test substance and for the transformation products should be at least 1 % of the initial amount applied to the test system if possible. The limit of quantification (LOQ) should be equal to or less than 10 % of the applied concentration. The chemical analyses of many organic substances and their transformation products frequently require that the test substance is applied at a relatively high concentration, i.e. > 100 $\mu\text{g/L}$.

1.8. DESCRIPTION OF THE TEST METHOD

1.8.1. **Equipment**

The test may be conducted in conical or cylindrical flasks of appropriate capacity (e.g. 0,5 or 1,0 litre) closed with silicone or rubber stoppers, or in serum flasks with CO_2 -tight lids (e.g. with butyl rubber septa). Another option is to perform the test by use of multiple flasks and to harvest whole flasks, at least in duplicate, at each sample interval (see last paragraph in section 1.8.9.1). For non-volatile test substances that are not radiolabelled, gas-tight stoppers or lids are not required; loose cotton plugs that prevent contamination from air are suitable (see second paragraph in section 1.8.9.1). Slightly volatile substances should be tested in a biometer-type system with gentle stirring of the water surface. To be sure that no bacterial contamination occurs, optionally the vessels can be sterilised by heating or autoclaving prior to use. In addition, the following standard laboratory equipment is used:

— shaking table or magnetic stirrers for continuous agitation of the test flasks,

▼ M1

- centrifuge,

- pH meter,

- turbidimeter for nephelometric turbidity measurements,

- oven or microwave oven for dry weight determinations,

- membrane filtration apparatus,

- autoclave or oven for heat sterilisation of glassware,

- facilities to handle ^{14}C -labelled substances,

- equipment to quantify ^{14}C -activity in samples from CO_2 -trapping solutions and, if required, from sediment samples,

- analytical equipment for the determination of the test (and reference) substance if specific chemical analysis is used (e.g. gas chromatograph, high-pressure liquid chromatograph).

1.8.2. Stock solutions of test substance

Deionised water is used to prepare stock solutions of the test and reference substances (see first paragraph in section 1.8.7). The deionised water should be free of substances that may be toxic to microorganisms, and dissolved organic carbon (DOC) should be no more than 1 mg/L (6).

1.8.3. Collection and transport of surface water

The sampling site for collection of the surface water should be selected in accordance with the purpose of the test in any given situation. In selecting sampling sites, the history of possible agricultural, industrial or domestic inputs must be considered. If it is known that an aquatic environment has been contaminated with the test substance or its structural analogues within the previous four years, it should not be used for the collection of test water, unless investigation of degradation rates in previously exposed sites is the express purpose of the investigator. The pH and temperature of the water should be measured at the site of collection. Furthermore, the depth of sampling and the appearance of the water sample (e.g. colour and turbidity) should be noted (see section 3). Oxygen concentration and/or redox potential in water and in the sediment surface layer should be measured in order to demonstrate aerobic conditions unless this is obvious as judged from appearance and historic experience with the site. The surface water should be transported in a thoroughly cleansed container. During transport, the temperature of the sample should not significantly exceed the temperature used in the test. Cooling to 4 °C is recommended if transport duration exceeds 2 to 3 hours. The water sample must not be frozen.

▼ M1**1.8.4. Storage and preparation of surface water**

The test should preferably be started within one day after sample collection. Storage of the water, if needed, should be minimised and must in any case not exceed a maximum of 4 weeks. The water sample should be kept at 4 °C with aeration until use. Prior to use, the coarse particles should be removed, e.g. by filtration through a nylon filter with about 100 µm mesh size or with a coarse paper filter, or by sedimentation.

1.8.5. Preparation of water amended with sediment (optional)

For the suspended sediment test, surface sediment is added to the flasks containing natural water (filtered to remove coarse particles as described in section 1.8.4) to obtain a suspension; the concentration of suspended solids should be between 0,01 and 1 g/L. The surface sediment should come from the same site as that from which the water sample was taken. Dependent on the particular aquatic environment, the surface sediment may either be characterised by a high organic carbon content (2,5-7,5 %) and a fine texture or by a low organic carbon content (0,5-2,5 %) and a coarse texture (3). The surface sediment can be prepared as follows: extract several sediment cores using a tube of transparent plastic, slice off the upper aerobic layers (from surface to a depth of max. 5 mm) immediately after sampling and pool them together. The resulting sediment sample should be transported in a container with a large air headspace to keep the sediment under aerobic conditions (cool to 4 °C if transport duration exceeds 2-3 hours). The sediment sample should be suspended in the test water at a ratio of 1:10 and kept at 4 °C with aeration until use. Storage of the sediment, if needed, should be minimised and must not in any case exceed a maximum of 4 weeks.

1.8.6. Semi-continuous procedure (optional)

Prolonged incubation (several months) may be necessary if a long lag time occurs before a significant degradation of the test substance can be measured. If this is known from previous testing of a substance, the test may be initiated by using a semi-continuous procedure, which allows periodical renewal of a part of the test water or suspension (see Appendix 2). Alternatively, the normal batch test may be changed into a semi-continuous test, if no degradation of the test substance has been achieved during approximately 60 days of testing using the batch procedure (see second paragraph in section 1.8.8.3).

1.8.7. Addition of the test (or reference) substance

For substances with high water solubility (> 1 mg/L) and low volatility (Henry's law constants < 1 Pa·m³/mol or < 10⁻⁵ atm·m³/mol), a stock solution can be prepared in deionised water (see section 1.8.2); the appropriate volume of the stock solution is added to the test vessels to achieve the desired concentration. The volume of any added stock solution should be held to the practical minimum (< 10 % of the final liquid volume, if possible). Another procedure is to dissolve the test substance in a larger volume of the test water, which may be seen as an alternative to the use of organic solvents.

▼ M1

If unavoidable, stock solutions of non-volatile substances with poor water-solubility should be prepared by use of a volatile organic solvent, but the amount of solvent added to the test system should not exceed 1 % v/v and should not have adverse effects on the microbial activity. The solvent should not affect the stability of the test substance in water. The solvent should be stripped off to an extremely small quantity so that it does not significantly increase the DOC concentration of the test water or suspension. This should be checked by substance-specific analysis or, if possible, DOC analysis (6). Care must be taken to limit the amount of solvent transferred to what is absolutely necessary, and to ensure that the amount of test substance can dissolve in the final volume of test water. Other techniques to introduce the test substance into the test vessels may be used as described in (7) and (8). When an organic solvent is used for application of the test substance, solvent controls containing the test water (with no additions) and test water with added reference substance should be treated similarly to active test vessels amended with test substance in solvent carrier. The purpose of the solvent controls is to examine possible adverse effects caused by the solvent towards the microbial population as indicated by the degradation of the reference substance.

1.8.8. Test conditions**1.8.8.1. Test temperature**

Incubation should take place in the dark (preferred) or in diffuse light at a controlled (± 2 °C) temperature, which may be the field temperature or a standard temperature of 20-25 °C. Field temperature may be either the actual temperature of the sample at the sampling time or an average field temperature at the sampling site.

1.8.8.2. Agitation

Agitation by means of continuous shaking or stirring must be provided to maintain particles and microorganisms in suspension. Agitation also facilitates oxygen transfer from the headspace to the liquid so that aerobic conditions can be adequately maintained. Place the flasks on a shaking table (approx. 100 rpm agitation) or use magnetic stirring. Agitation must be continuous. However, the shaking or stirring should be as gentle as possible, while still maintaining a homogeneous suspension.

1.8.8.3. Test duration

The duration of the test should normally not exceed 60 days unless the semi-continuous procedure with periodical renewal of the test suspension is applied (see section 1.8.6 and Appendix 2). However, the test period for the batch test may be extended to a maximum of 90 days, if the degradation of the test substance has started within the first 60 days. Degradation is monitored, at appropriate time intervals, by the determination of the residual ^{14}C activity or the evolved $^{14}\text{CO}_2$ (see section 1.8.9.4) and/or by chemical analysis (section 1.8.9.5). The incubation time must be sufficiently long to evaluate the degradation process. The extent of degradation should preferably exceed 50 %; for slowly degradable substances, the extent of degradation must be sufficient (normally greater than 20 % degradation) to ensure the estimation of a kinetic degradation rate constant.

▼ M1

Periodic measurements of pH and oxygen concentration in the test system must be conducted unless previous experience from similar tests with water and sediment samples collected from the same site make such measurements unnecessary. Under some conditions, the metabolism of primary substrates at much higher concentrations within the water or sediment could possibly result in enough CO₂ evolution and oxygen depletion to significantly alter the experimental conditions during the test.

1.8.9. Procedure**1.8.9.1. Preparation of flasks for pelagic test**

Transfer a suitable volume of test water to the test flasks, up to about one third of the flask volume and not less than about 100 ml. If multiple flasks are used (to allow harvesting of whole flasks at each sampling time), the appropriate volume of test water is also about 100 ml, as small sample volumes may influence the length of the lag phase. The test substance is added from a stock solution as described in sections 1.8.2 and 1.8.7. At least two different concentrations of test substance differing by a factor of 5 to 10 should be used in order to determine degradation kinetics and calculate the kinetic degradation rate constant. Both of the selected concentrations should be less than 100 µg/L and preferably in the range of < 1-10 µg/L.

Close the flasks with stoppers or lids impermeable to air and CO₂. For non-¹⁴C-labelled non-volatile test chemicals, loose cotton wool plugs that prevent contamination from air are suitable (see section 1.8.1) provided that any major degradation products are known to be non-volatile, and if indirect CO₂ determination is used (see Appendix 3).

Incubate the flasks at the selected temperature (see section 1.8.8.1). Withdraw samples for chemical analysis or ¹⁴C measurements at the beginning of the test (i.e. before biodegradation starts; see section 1.7.1) and then at suitable time intervals during the course of the test. Sampling may be performed by withdrawal of sub-samples (e.g. 5 ml aliquots) from each replicate or by harvest of whole flasks at each sampling time. The mineralisation of the test substance may either be determined indirectly or directly (see Appendix 3). Usually, a minimum of five sampling points are required during the degradation phase (i.e. after ended lag phase) in order to estimate a reliable rate constant, unless it can be justified that three sampling points are sufficient for rapidly degradable substances. For substances that are not rapidly degraded more measurements during the degradation phase can easily be made and, therefore, more data points should be used for the estimation of k. No fixed time schedule for sampling can be stated, as the rate of biodegradation varies; however the recommendation is to sample once a week if degradation is slow. If the test substance is rapidly degradable, sampling should take place once a day during the first three days and then every second or third day. Under certain circumstances, such as with very rapidly hydrolysing substances, it may be necessary to sample at hourly intervals. It is recommended that a preliminary study is conducted prior to the test in order to determine the appropriate sampling intervals. If samples have to be available for further specific analysis, it is advisable to take more samples and then select those to be analysed at the end of the experiment following a backwards strategy, i.e. the last samples are analysed first (see second paragraph in section 1.8.9.5 for guidance on stability of samples during storage).

▼ M11.8.9.2. *Number of flasks and samples*

Set up a sufficient number of test flasks to have:

- test flasks; at least duplicate flasks for each concentration of test substance (preferably a minimum of 3) or multiple test flasks for each concentration, if whole flasks are harvested at each sampling time (symbolised F_T),

- test flasks for mass balance calculation; at least duplicate flasks for each test concentration (symbolised F_M),

- blank control, no test substance; at least one blank test flask containing only the test water (symbolised F_B),

- reference control; duplicate flasks with reference substance (e.g. aniline or sodium benzoate, at 10 $\mu\text{g/l}$) (symbolised F_C). The purpose of the reference control is to confirm a minimum of microbial activity. If convenient, a radiolabelled reference substance may be used, also when the degradation of the test substance is monitored by chemical analyses,

- sterile control; one or two flasks containing sterilised test water for examining possible abiotic degradation or other non-biological removal of the test substance (symbolised F_S). The biological activity can be stopped by autoclaving (121 °C; 20 min.) the test water or by adding a toxicant (e.g. sodium azide (NaN_3) at 10-20 g/l, mercuric chloride (HgCl_2) at 100 mg/l or formalin at 100 mg/l) or by gamma irradiation. If HgCl_2 is used, it should be disposed of as toxic waste. For water with sediment added in large amount, sterile conditions are not easy to obtain; in this case repeated autoclaving (e.g. three times) is recommended. It should be considered that the sorption characteristics of the sediment may be altered by autoclaving,

- solvent controls, containing test water and test water with reference substance; duplicate flasks treated with the same amount of solvent and by use of the same procedure as that used for application of the test substance. The purpose is to examine possible adverse effects of the solvent by determining the degradation of the reference substance.

In the design of the test, the investigator should consider the relative importance of increased experimental replication versus increased number of sampling times. The exact number of flasks required will depend on the method used for measuring the degradation (see third paragraph in section 1.8.9.1; section 1.8.9.4 and Appendix 3).

▼ M1

Two subsamples (e.g. 5 ml aliquots) should be withdrawn from each test flask at each sampling time. If multiple flasks are used to allow harvesting of whole flasks, a minimum of two flasks should be sacrificed at each sampling time (see first paragraph in section 1.8.9.1).

1.8.9.3. *Preparation of flasks for suspended sediment test [optional]*

Add the necessary volumes of test water and sediment, if required, to the test vessels (see section 1.8.5). The preparation of flasks for suspended sediment test is the same as for the pelagic test (see sections 1.8.9.1 and 1.8.9.2). Use preferably serum bottles or similar shaped flasks. Place the closed flasks horizontally on a shaker. Obviously, open flasks for non-¹⁴C-labelled, non-volatile substances should be placed in upright position; in this case magnetic stirring and the use of magnetic bars coated with glass are recommended. If necessary, aerate the bottles to maintain proper aerobic conditions.

1.8.9.4. *Radiochemical determinations*

The evolved ¹⁴CO₂ is measured indirectly and directly (see Appendix 3). The ¹⁴CO₂ is determined indirectly by the difference between the initial ¹⁴C activity in the test water or suspension and the total residual activity at the sampling time as measured after acidifying the sample to pH 2-3 and stripping off CO₂. Inorganic carbon is thus removed and the residual activity measured derives from organic material. The indirect ¹⁴CO₂ determination should not be used, if major volatile transformation products are formed during the transformation of the test substance (see Appendix 3). If possible, the ¹⁴CO₂ evolution should be measured directly (see Appendix 3) at each sampling time in at least one test flask; this procedure enables both the mass balance and biodegradation process to be checked, but it is restricted to tests conducted with closed flasks.

If the evolved ¹⁴CO₂ is measured directly during the test, more flasks should be set up for this purpose at the start of the test. Direct ¹⁴CO₂ determination is recommended, if major volatile transformation products are formed during the transformation of the test substance. At each measuring point the additional test flasks are acidified to pH 2-3 and the ¹⁴CO₂ is collected in an internal or external absorber (see Appendix 3).

Optionally the concentrations of ¹⁴C-labelled test substance and major transformation products may be determined by use of radiochromatography (e.g. thin layer chromatography, RAD-TLC) or HPLC with radiochemical detection.

Optionally the phase distribution of the remaining radioactivity (see Appendix 1) and residual test substance and transformation products may be determined.

▼ M1

At the end of the test the mass balance should be determined by direct $^{14}\text{CO}_2$ measurement using separate test flasks from which no samples are taken in the course of the test (see Appendix 3).

1.8.9.5. Specific chemical analysis

If a sensitive specific analytical method is available, primary biodegradation can be assessed by measuring the total residual concentration of test substance instead of using radiolabelling techniques. If a radiolabelled test substance is used (to measure total mineralisation), specific chemical analyses can be made in parallel to provide useful additional information and check the procedure. Specific chemical analyses may also be used to measure transformation products formed during the degradation of the test substance, and this is recommended for substances that are mineralised with half-lives exceeding 60 days. The concentration of the test substance and the transformation products at every sampling time should be measured and reported (as a concentration and as percentage of applied). In general, transformation products detected at $\geq 10\%$ of the applied concentration at any sampling time should be identified unless reasonably justified otherwise. Transformation products for which concentrations are continuously increasing during the study should also be considered for identification, even if their concentrations do not exceed the limit given above, as this may indicate persistence. Analyses of transformation products in sterile controls should be considered, if rapid abiotic transformation of the test substance (e.g. hydrolysis) is thought possible. The need for quantification and identification of transformation products should be considered on a case by case basis, with justifications being provided in the report. Extraction techniques with organic solvent should be applied according to directions given in the respective analytical procedure.

All samples should be stored at 2 to 4 °C and air-tight if analysis is carried out within 24 hours (preferred). For longer storage, the samples should be frozen below -18 °C or chemically preserved. Acidification is not a recommended method to preserve the samples, because acidified samples may be unstable. If the samples are not analysed within 24 hours and are subject to longer storage, a storage stability study should be conducted to demonstrate the stability of chemicals of interest under -18 °C storage or preserved conditions. If the analytical method involves either solvent extraction or solid phase extraction (SPE), the extraction should be performed immediately after sampling or after storing the sample refrigerated for a maximum of 24 hours.

Depending on the sensitivity of the analytical method, larger sample volumes than those indicated in section 1.8.1 may be necessary. The test can easily be carried out with test volumes of one litre in flasks of 2-3 litre volume, which makes it possible to collect samples of approx. 100 ml.

▼ M1**2. DATA AND REPORTING****2.1. TREATMENT OF RESULTS****2.1.1. Plot of data**

Round off sampling times to a whole number of hours (unless the substance degrades substantially in a matter of minutes to hours) but not to a whole number of days. Plot the estimates of the residual activity of test substance (for ^{14}C -labelled substances) or the residual concentration (for non-labelled substances), against time both in a linear and in a semi-logarithmic plot (see Figures 1a, 1b). If degradation has taken place, compare the results from flasks F_T with those from flasks F_S . If the means of the results from the flasks with test substance (F_T) and the sterile flasks (F_S) deviate by less than 10 %, it can be assumed that the degradation observed is predominantly abiotic. If the degradation in flasks F_S is lower, the figures may be used to correct those obtained with flasks F_T (by subtraction) in order to estimate the extent of biodegradation. When optional analyses are performed for major transformation products, plots of their formation and decline should be provided in addition to a plot of the decline of the test substance.

Estimate the lag phase duration t_L from the degradation curve (semi-logarithmic plot) by extrapolating its linear part to zero degradation or alternatively by determining the time for approximately 10 % degradation (see Figures 1a and 1b). From the semi-logarithmic plot, estimate the first order rate constant, k , and its standard error by linear regression of \ln (residual ^{14}C activity or test substance concentration) versus time. With ^{14}C measurements in particular, use only data belonging to the initial linear part of the curve after the ended lag phase, and give preference to selecting few and representative data rather than selecting a greater number of more uncertain data. Uncertainty includes here errors inherent in the recommended direct use of measured residual ^{14}C activities (see below). It may sometimes be relevant to calculate two different rate constants, if the degradation follows a biphasic pattern. For this purpose two different phases of the degradation curve are defined. Calculations of the rate constant, k , and the half-life $t_{1/2} = \ln 2/k$, should be carried out for each of the individual replicate flasks, when sub-samples are withdrawn from the same flask, or by using the average values, when whole flasks are harvested at each sampling time (see last paragraph in section 1.8.9.2). When the first-mentioned procedure is used, the rate constant and half-life should be reported for each of the individual replicate flasks and as an average value with a standard error. If high concentrations of test substance have been used, the degradation curve may deviate considerably from a straight line (semi-logarithmic plot) and first order kinetics may not be valid. Defining a half-life has therefore no meaning. However, for a limited data range, pseudo first order kinetics can be applied and the degradation half-time DT_{50} (time to reach 50 % degradation) estimated. It must be borne in mind, however, that the time course of degradation beyond the selected data range cannot be predicted using the DT_{50} which is merely a descriptor of a given set of data. Analytical tools to facilitate statistical calculations and curve fitting are easily available and the use of this kind of software is recommended.

▼ M1

If specific chemical analyses are made, estimate rate constants and half-lives for primary degradation as above for total mineralisation. If the primary degradation is the limiting process data points from the entire course of degradation may sometimes be used. This is because measurements are direct by contrast to measurements of ^{14}C activity.

If ^{14}C -labelled substances are used, a mass balance should be expressed in percentage of the applied initial concentration, at least at the end of the test.

2.1.2. Residual activity

When the ^{14}C -labelled part of an organic substance is biodegraded, the major part of the ^{14}C is converted to $^{14}\text{CO}_2$, while another part is used for growth of biomass and/or synthesis of extra-cellular metabolites. Therefore, complete 'ultimate' biodegradation of a substance does not result in a 100 % conversion of its carbon into $^{14}\text{CO}_2$. The ^{14}C built into products formed by biosynthesis is subsequently released slowly as $^{14}\text{CO}_2$ due to 'secondary mineralisation'. For these reasons plots of residual organic ^{14}C activity (measured after stripping off CO_2) or of $^{14}\text{CO}_2$ produced versus time will show a 'tailing' after degradation has been completed. This complicates a kinetic interpretation of the data and for this purpose, only the initial part of the curve (after the lag phase has ended and before approx. 50 % degradation is reached) should normally be used for the estimation of a degradation rate constant. If the test substance is degraded, the total residual organic ^{14}C activity is always higher than the ^{14}C activity associated with the remaining intact test substance. If the test substance is degraded by a first order reaction and a constant fraction α is mineralised into CO_2 , the initial slope of the ^{14}C disappearance curve (total organic ^{14}C versus time) will be α times the slope of the corresponding curve for the concentration of test substance (or, to be precise, the part of the test substance labelled with ^{14}C). Using measurements of the total organic ^{14}C activity uncorrected, the calculated degradation rate constant will therefore be conservative. Procedures for estimating the concentrations of the test substance from the measured radiochemical activities based on various simplifying assumptions have been described in the literature (2)(9)(10)(11). Such procedures are most easily applied for rapidly degradable substances.

2.2. INTERPRETATION OF RESULTS

If k is found to be independent of the added concentration (i.e. if the calculated k is approximately the same at the different concentrations of test substance), it can be assumed that the first order rate constant is representative of the testing conditions used, i.e. the test substance, the water sample and the test temperature. To what extent the results can be generalised or extrapolated to other systems must be evaluated by expert judgement. If a high concentration of test substance is used, and the degradation therefore does not follow first order kinetics, the data cannot be used for direct estimation of a first order rate constant or a corresponding half-life. However, data derived from a test using a high concentration of test substance may still be usable for estimating the degree of total mineralisation and/or detection and quantification of transformation products.

▼ M1

If the rates of other loss processes than biodegradation are known (e.g. hydrolysis or volatilisation), they may be subtracted from the net loss rate observed during the test to give an approximated estimate of the biodegradation rate. Data for hydrolysis may, e.g. be obtained from the sterile control or from parallel testing using a higher concentration of the test substance.

The indirect and direct determination of $^{14}\text{CO}_2$ (section 1.8.9.4 and Appendix 3) can only be used to measure the extent of mineralisation of the test substance to CO_2 . Radiochromatography (RAD-TLC) or HPLC may be used to analyse the concentrations of ^{14}C -labelled test substance and the formation of major transformation products (third paragraph in section 1.8.9.4). To enable a direct estimation of the half-life, it is necessary that no major transformation products (defined as $\geq 10\%$ of the applied amount of test substance) be present. If major transformation products as defined here are present, a detailed evaluation of the data is required. This may include repeated testing and/or identification of the transformation products (see first paragraph in section 1.8.9.5) unless the fate of the transformation products can be reasonably assessed by use of experience (e.g. information on degradation pathway). As the proportion of test substance carbon converted to CO_2 varies (depending largely on the concentration of test substance and other substrates available, the test conditions and the microbial community), this test does not allow a straightforward estimation of ultimate biodegradation as in a DOC die-away test; but the result is similar to that obtained with a respirometric test. The degree of mineralisation will thus be less than or equal to the minimum level of ultimate biodegradation. To obtain a more complete picture of the ultimate biodegradation (mineralisation and incorporation into biomass), the analysis of the phase distribution of ^{14}C should be performed at the end of the test (see Appendix 1). The ^{14}C in the particulate pool will consist of ^{14}C incorporated into bacterial biomass and ^{14}C sorbed to organic particles.

2.3. VALIDITY OF THE TEST

If the reference substance is not degraded within the expected time interval (for aniline and sodium benzoate, usually less than two weeks), the validity of the test is suspected and must be further verified, or alternatively the test should be repeated with a new water sample. In an ISO ring-test of the method where seven laboratories located around Europe participated, adapted degradation rate constants for aniline ranged from 0,3 to 1,7 day^{-1} with an average of 0,8 d^{-1} at 20 °C and a standard error of $\pm 0,4 \text{ d}^{-1}$ ($t_{1/2} = 0,9$ days). Typical lag times were 1 to 7 days. The waters examined were reported to have a bacterial biomass corresponding to 10^3 - 10^4 colony forming units (CFU) per ml. Degradation rates in nutrient-rich Mid-European waters were greater than in Nordic oligotrophic waters, which may be due to the different trophic status or previous exposure to chemical substances.

The total recovery (mass balance) at the end of the experiment should be between 90 % and 110 % for radiolabelled substances, whereas the initial recovery at the beginning of the experiment should be between 70 % and 110 % for non-labelled substances. However, the indicated ranges should only be interpreted as targets and should not be used as criteria for acceptance of the test.

▼ M1**3. TEST REPORT**

The type of study, i.e. pelagic or suspended sediment test, must be clearly stated in the test report, which shall also contain at least the following information:

Test substance and reference substance(s):

- common names, chemical names (recommend IUPAC and/or CAS names), CAS numbers, structural formulas (indicating position of ¹⁴C if radiolabelled substance is used) and relevant physico-chemical properties of test and reference substance (see sections 1.5 and 1.6),
- chemical names, CAS numbers, structural formulas (indicating position of ¹⁴C if radiolabelled substance is used) and relevant physico-chemical properties of substances used as standards for identification and quantification of transformation products,
- purity (impurities) of test and reference substances,
- radiochemical purity of labelled chemical and specific activity (where appropriate).

Surface water:

The following minimum information for the water sample taken must be provided:

- location and description of sampling site including, if possible, contamination history,
- date and time of sample collection,
- nutrients (total N, ammonium, nitrite, nitrate, total P, dissolved orthophosphate),
- depth of collection,
- appearance of sample (e.g. colour and turbidity),
- DOC and TOC,
- BOD,
- temperature and pH at the place and time of collection,
- oxygen or redox potential (mandatory only if aerobic conditions are not obvious),
- salinity or conductivity (in the case of sea water and brackish water),
- suspended solids (in case of a turbid sample),
- possibly other relevant information about the sampling location at the time of sampling (e.g. actual or historical data on flow rate of rivers or marine currents, nearby major discharges and type of discharges, weather conditions preceding the sampling time),

and optionally:

- microbial biomass (e.g. acridine orange direct count or colony forming units),

▼ M1

- inorganic carbon,
- chlorophyll-a concentration as a specific estimate for algal biomass.

In addition, the following information on the sediment should be provided if the suspended sediment test is conducted:

- depth of sediment collection,
- appearance of the sediment (such as coloured, muddy, silty, or sandy),
- texture (e.g. % coarse sand, fine sand, silt and clay),
- dry weight in g/l of the suspended solids, TOC concentration or weight loss on ignition as a measure of the content of organic matter,
- pH,
- oxygen or redox potential (mandatory only if aerobic conditions are not obvious).

Test conditions:

- delay between collection and use in the laboratory test, sample storage and pre-treatment of the sample, dates of performance of the studies,
- amount of test substance applied, test concentration and reference substance,
- method of application of the test substance including any use of solvents,
- volume of surface water used and sediment (if used) and volume sampled at each interval for analysis,
- description of the test system used.

If dark conditions are not to be maintained, information on the 'diffuse light' conditions:

- information on the method(s) used for establishing sterile controls (e.g. temperature, time and number of autoclavings),
- incubation temperature,
- information on analytical techniques and the method(s) used for radiochemical measurements and for mass balance check and measurements of phase distribution (if conducted),
- number of replicates.

Results:

- percentages of recovery (see section 1.7.1),
- repeatability and sensitivity of the analytical methods used including the limit of detection (LOD) and the limit of quantification (LOQ) (see section 1.7.2),

▼ M1

- all measured data (including sampling time points) and calculated values in tabular form and the degradation curves; for each test concentration and for each replicate flask, report the linear correlation coefficient for the slope of the logarithmic plot, the estimated lag phase and a first-order or pseudo-first order rate constant (if possible), and the corresponding degradation half-life (or the half-life period, t_{50}),
- report relevant values as the averages of the results observed in individual replicates, e.g. length of lag phase, degradation rate constant and degradation half-life (or t_{50}),
- categorise the system as either non-adapted or adapted as judged from the appearance of the degradation curve and from the possible influence of the test concentration,
- the results of the final mass balance check and results on phase distribution measurements (if any),
- the fraction of ^{14}C mineralised and, if specific analyses are used, the final level of primary degradation,
- the identification, molar concentration and percentage of applied and major transformation products (see first paragraph in section 1.8.9.5), where appropriate,
- a proposed pathway of transformation, where appropriate,
- discussion of results.

4. LITERATURE

1. OECD TG 309 (2004) Aerobic Mineralisation in surface water — Simulation Biodegradation Test.
2. ISO/DIS 14592-1 (1999) Water quality — Evaluation of the aerobic biodegradability of organic compounds at low concentrations — Part 1: Shake flask batch test with surface water or surface water/sediment suspensions.
3. Testing Method C.23. Aerobic and anaerobic transformation in soil.
4. Testing Method C.24. Aerobic and anaerobic transformation in aquatic sediments.
5. OECD (1993). Guidelines for the Testing of Chemicals. OECD, Paris.
6. ISO 8245 (1999). Water quality — Guidelines on the determination of total organic carbon (TOC) and dissolved organic carbon (DOC).
7. ISO 10634 (1995). Water quality — Guidance for the preparation and treatment of poorly water-soluble organic compounds for the subsequent evaluation of their biodegradability in an aqueous medium.
8. OECD (2000). Guidance Document on aquatic toxicity testing of difficult substances and mixtures. Environmental Health and Safety Publications. Series on Testing and Assessment. No 22.

▼ M1

9. Simkins, S. and Alexander, M. (1984). Models for mineralisation kinetics with the variables of substrate concentration and population density. *Appl. Environ. Microbiol.*47, 394-401.
10. Ingerslev, F. and N. Nyholm. (2000). Shake-flask test for determination of biodegradation rates of ¹⁴C-labeled chemicals at low concentrations in surface water systems. *Ecotoxicol. Environ. Saf.* 45, 274-283.
11. ISO/CD 14592-1 (1999). Ring test report: Water Quality — Evaluation of the aerobic biodegradability of organic compounds at low concentrations part 1 — report of 1998/1999 ring-test. Shake flask batch test with surface water or surface water/sediment suspensions.

▼ M1*Appendix 1***Phase distribution of ^{14}C**

In order to check the procedure, the routine measurements of residual total organic ^{14}C activity (TOA) should be supplemented by mass balance measurements involving a direct determination of the evolved $^{14}\text{CO}_2$ after trapping in an absorber (see Appendix 3). In itself, a positive $^{14}\text{CO}_2$ formation is a direct evidence of biodegradation as opposed to abiotic degradation or other loss mechanisms, such as volatilisation and sorption. Additional useful information characterising the biodegradability behaviour can be obtained from measurements of the distribution of TOA between the dissolved state (dissolved organic ^{14}C activity, DOA) and the particulate state (particulate organic ^{14}C activity, POA) after separation of particulate by membrane filtration or centrifugation. POA consists of test substance sorbed onto the microbial biomass and onto other particles in addition to the test substance carbon that has been used for synthesis of new cellular material and thereby incorporated into the particulate biomass fraction. The formation of dissolved ^{14}C organic material can be estimated as the DOA at the end of biodegradation (plateau on the degradation versus time curve).

Estimate the phase distribution of residual ^{14}C in selected samples by filtering samples on a 0,22 μm or 0,45 μm membrane filter of a material that does not adsorb significant amounts of the test substance (polycarbonate filters may be suitable). If sorption of test substance onto the filter is too large to be ignored (to be checked prior to the experiment) high-speed centrifugation (2 000 g; 10 min.) can be used instead of filtration.

Proceed with the filtrate or centrifugate as described in Appendix 3 for unfiltered samples. Dissolve membrane filters in a suitable scintillation fluid and count as usually, normally using only the external standard ratio method to correct for quenching, or use a sample oxidiser. If centrifugation has been used, re-suspend the pellet formed of the particulate fraction in 1-2 ml of distilled water and transfer to a scintillation vial. Wash subsequently twice with 1 ml distilled water and transfer the washing water to the vial. If necessary, the suspension can be embedded in a gel for liquid scintillation counting.

▼ **M1***Appendix 2***Semi-continuous procedure**

Prolonged incubation for up to several months may be required in order to achieve a sufficient degradation of recalcitrant substances. The duration of the test should normally not exceed 60 days unless the characteristics of the original water sample are maintained by renewal of the test suspension. However, the test period may be extended to a maximum of 90 days without renewal of the test suspension, if the degradation of the test substance has started within the first 60 days.

During incubation for long periods, the diversity of the microbial community may be reduced due to various loss mechanisms and due to possible depletion of the water sample of essential nutrients and primary carbon substrates. It is therefore recommended that a semi-continuous test is used to adequately determine the degradation rate of slowly degrading substances. The test should be initiated by use of the semi-continuous procedure if, based on previous experience, an incubation period of three months is expected to be necessary to achieve 20 % degradation of the substance. Alternatively, the normal batch test may be changed into a semi-continuous test, if no degradation of the test substance has been achieved during approximately 60 days of testing using the batch procedure. The semi-continuous procedure may be stopped and the test continued as a batch experiment, when a substantial degradation has been recorded (e.g. > 20 %).

In the semi-continuous test, every two weeks, about one third of the volume of the test suspension is replaced by freshly collected water with the test substance added to the initial concentration. Sediment is likewise added to the replacement water to the initial concentration (between 0,01 and 1 g/l), if the optional suspended sediment test is performed. Carrying out the test with suspended sediment solids, it is important that a fully suspended system is maintained also during water renewal, and that the residence time is identical for solids and water, as otherwise the intended similarity to a homogenous aqueous system with no fixed phases can be lost. For these reasons, an initial concentration of suspended sediments in the lower range of the specified interval is preferred, when the semi-continuous procedure is used.

The prescribed addition of test substance implies that the initial concentration of test substance is not exceeded by the partial renewal of the test suspension and, hence, the adaptation, which is frequently seen with high concentrations of a test substance, is avoided. As the procedure comprises both a re-inoculation and a compensation of depleted nutrients and primary substrates, the original microbial diversity is restored, and the duration of the test can be extended to infinity in principle. When the semi-continuous procedure is used, it is important to note that the residual concentration of the test substance must be corrected for the amounts of test substance added and removed at each renewal procedure. The total and the dissolved test substance concentration can be used interchangeably for compounds that sorb little. Sorption is insignificant (< 5 %) under the specified conditions (0,1-1 g solids/l) for substances of $\log K_{ow} < 3$ (valid for neutral, lipophilic compounds). This is illustrated by the following calculation example. 0,1 g/l of solids roughly corresponds to 10 mg of carbon per litre (fraction of carbon, $f_C = 0,01$). Assuming that:

$\log K_{ow}$ (of the test substance) = 3

$$K_{oc} = 0,42 \times K_{ow}$$

Partition coefficient, $K_d = f_C \times K_{oc}$

then, the dissolved fraction of the total concentration (C-water (C_w)/C-total (C_t)) is:

$$C_w/C_t = 1/(1 + K_d \times SS) = 1/(1 + K_{oc} \times f_C \times SS) = 1/(1 + 0,42 \times 10^3 \times 0,01 \times 0,1 \times 10^{-3}) = 0,999$$

▼ **M1***Appendix 3***Determination of $^{14}\text{CO}_2$** **Indirect $^{14}\text{CO}_2$ determination**

For routine measurements, the indirect method is normally the least time-consuming and most precise method if the test substance is non-volatile and is not transformed into volatile transformation products. Simply transfer unfiltered samples e.g. 5 ml size to scintillation vials. A suitable activity in samples is 5 000 dpm-10 000 dpm (80-170 Bq) initially, and a minimum initial activity is about 1 000 dpm. The CO_2 should be stripped off after acidifying to pH 2-3 with 1-2 drops of concentrated H_3PO_4 or HCl. The CO_2 stripping can be performed by bubbling with air for about 1/2-1 hour. Alternatively, vials can be shaken vigorously for 1-2 hours (for instance on a microplate shaker) or with more gentle shaking be left overnight. The efficiency of the CO_2 stripping procedure must be checked (by prolonging the aeration or shaking period). A scintillation liquid, suitable for counting aqueous samples should then be added, the sample homogenised on a whirling mixer and the radioactivity determined by liquid scintillation counting, subtracting the background activity found in the test blanks (F_B). Unless the test water is very coloured or contains a high concentration of particles, the samples will normally show uniform quenching and it will be sufficient to perform quench corrections using an external standard. If the test water is highly coloured, quench correction by means of internal standard addition may be necessary. If the concentration of particles is high it may not be possible to obtain a homogeneous solution or gel, or the quench variation between samples may be large. In that case the counting method described below for test slurries can be used. If the test is carried out as a suspended sediment test, the $^{14}\text{CO}_2$ measurement could be done indirectly by taking a homogeneous 10-ml sample of the test water/suspension and separating the phases by centrifugation at a suitable speed (e.g. at 40 000 m/s^2 for 15 min.). The aqueous phase should then be then treated as described above. The ^{14}C activity in the particulate phase (POA) should be determined by re-suspending the sediment into a small volume of distilled water, transferring to scintillation vials, and adding scintillation liquid to form a gel (special scintillation liquids are available for that purpose). Depending on the nature of particles (e.g. their content of organic material), it may be feasible to digest the sample overnight with a tissue solubiliser and then homogenise on a whirling mixer prior to the addition of scintillation liquid. Alternatively, the POA can be determined by combustion in excess of oxygen by use of a sample oxidiser. When counting, internal standards should always be included, and it may be necessary to perform quench corrections using internal standard addition for each individual sample.

Direct $^{14}\text{CO}_2$ determination

If the evolved $^{14}\text{CO}_2$ is measured directly, it should be done by setting up more flasks at the start of the test, harvesting the test flasks at each measuring point by acidifying the test flasks to pH 2-3 and collecting the $^{14}\text{CO}_2$ in an internal (placed in each test flask at the start of the test) or external absorber. As absorbing medium either alkali (e.g. 1 N NaOH solution, or a NaOH pellet), ethanolamine or an ethanolamine-based, and commercially available absorbers can be used. For direct measurement of the $^{14}\text{CO}_2$, the flasks should be closed with e.g. butyl rubber septa.

▼ M1

Figure 1a

Example of arithmetic plot of data (residual activity versus time)

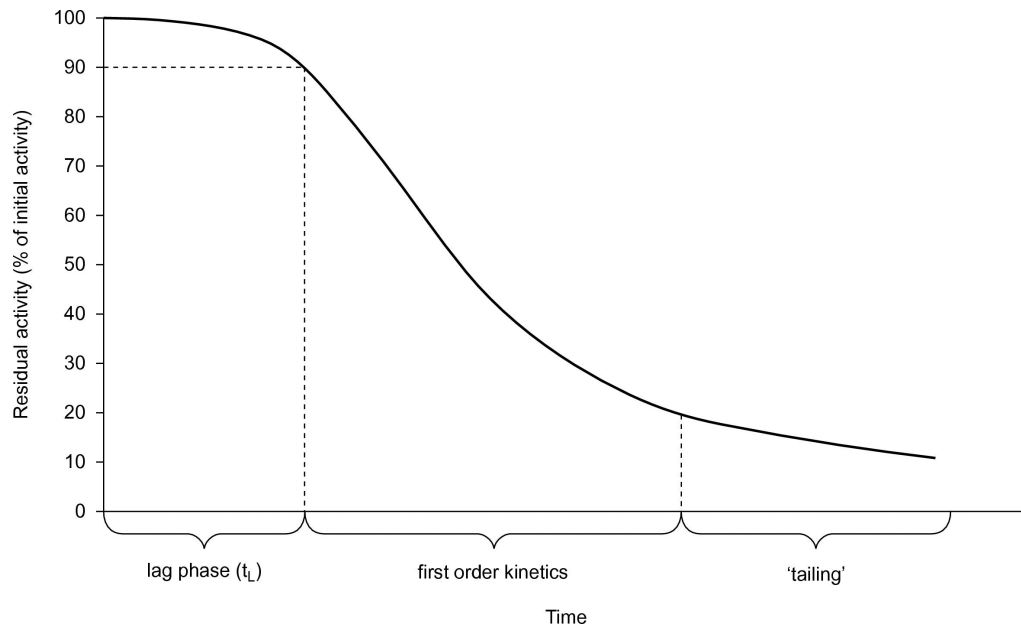
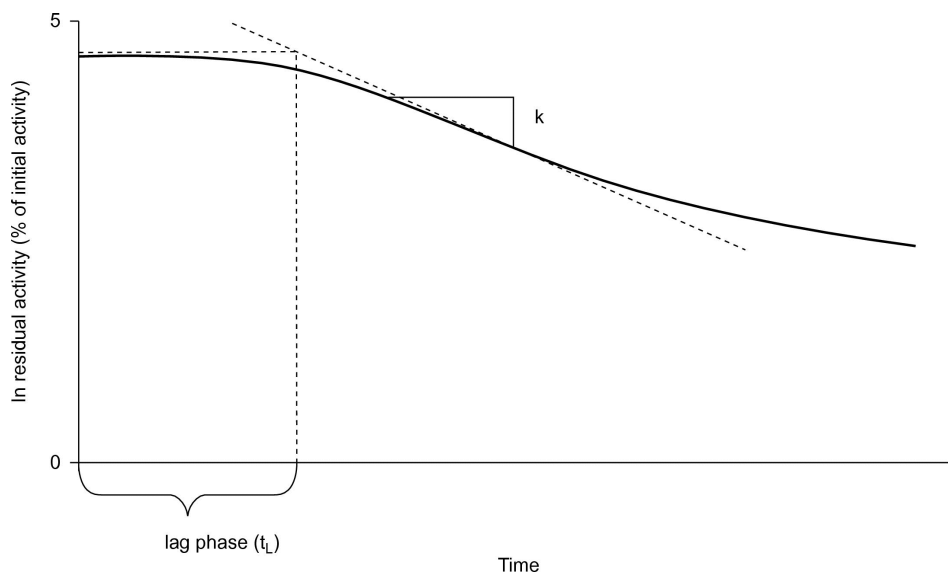

Figure 1b

Example of semi-logarithmic plot of data (ln to residual activity versus time)



▼M6**C.26. LEMNA SPECIES GROWTH INHIBITION TEST**

INTRODUCTION

1. This test method is equivalent to OECD Test Guideline (TG) 221 (2006). It is designed to assess the toxicity of chemicals to freshwater aquatic plants of the genus *Lemna* (duckweed). It is based on existing methods (1)(2)(3)(4)(5)(6) but includes modifications of those methods to reflect recent research and consultation on a number of key issues. This Test Method has been validated by an international ring-test (7).
2. This test method describes toxicity testing using *Lemna gibba* and *Lemna minor*, both of which have been extensively studied and are the subject of the standards referred to above. The taxonomy of *Lemna* spp. is difficult, being complicated by the existence of a wide range of phenotypes. Although genetic variability in the response to toxicants can occur with *Lemna*, there are currently insufficient data on this source of variability to recommend a specific clone for use with this test method. It should be noted that the test is not conducted axenically but steps are taken at stages during the test procedure to keep contamination by other organisms to a minimum.
3. Details of testing with renewal (semi-static and flow-through) and without renewal (static) of the test solution are described. Depending on the objectives of the test and the regulatory requirements, it is recommended to consider the application of semi-static and flow through methods, e.g. for chemicals that are rapidly lost from solution as a result of volatilisation, photodegradation, precipitation or biodegradation. Further guidance is given in (8).
4. Definitions used are given in Appendix 1.

PRINCIPLE OF THE TEST

5. Exponentially growing plant cultures of the genus *Lemna* are allowed to grow as monocultures in different concentrations of the test chemical over a period of seven days. The objective of the test is to quantify chemical-related effects on vegetative growth over this period based on assessments of selected measurement variables. Frond number is the primary measurement variable. At least one other measurement variable (total frond area, dry weight or fresh weight) is also measured, since some chemicals may affect other measurement variables much more than frond numbers. To quantify chemical-related effects, growth in the test solutions is compared with that of the controls and the concentration bringing about a specified x % inhibition of growth (e.g. 50 %) is determined and expressed as the EC_x (e.g. EC₅₀).
6. The test endpoint is inhibition of growth, expressed as logarithmic increase in measurement variable (average specific growth rate) during the exposure period. From the average specific growth rates recorded in a series of test solutions, the concentration bringing about a specified x % inhibition of growth rate (e.g. 50 %) is determined and expressed as the E_rC_x (e.g. E_rC₅₀).
7. An additional response variable used in this Test Method is yield, which may be needed to fulfil specific regulatory requirements in some countries. It is defined as measurement variables at the end of the exposure period minus the measurement variables at the start of the exposure period. From the yield recorded in a series of test solutions, the concentration bringing about a specified x % inhibition of yield (e.g., 50 %) is calculated and expressed as the E_yC_x (e.g. E_yC₅₀).

▼ M6

8. In addition, the lowest observed effect concentration (LOEC) and the no observed effect concentration (NOEC) may be statistically determined.

INFORMATION ON THE TEST CHEMICAL

9. An analytical method, with adequate sensitivity for quantification of the chemical in the test medium, should be available.
10. Information on the test chemical which may be useful in establishing the test conditions includes the structural formula, purity, water solubility, stability in water and light, pK_a , K_{ow} , vapour pressure and biodegradability. Water solubility and vapour pressure can be used to calculate Henry's Law constant, which will indicate if significant losses of the test chemical during the test period are likely. This will help indicate whether particular steps to control such losses should be taken. Where information on the solubility and stability of the test chemical is uncertain, it is recommended that these be assessed under the conditions of the test, i.e. growth medium, temperature, lighting regime to be used in the test.
11. When pH control of the test medium is particularly important, e.g. when testing metals or chemicals which are hydrolytically unstable, the addition of a buffer to the growth medium is recommended (see paragraph 21). Further guidance for testing chemicals with physical-chemical properties that make them difficult to test is provided in (8).

VALIDITY OF THE TEST

12. For the test to be valid, the doubling time of frond number in the control must be less than 2,5 days (60 h), corresponding to approximately a seven-fold increase in seven days and an average specific growth rate of $0,275\text{ d}^{-1}$. Using the media and test conditions described in this Test Method, this criterion can be attained using a static test regime (5). It is also anticipated that this criterion will be achievable under semi-static and flow-through test conditions. Calculation of the doubling time is shown in paragraph 49.

REFERENCE CHEMICAL

13. Reference chemical(s), such as 3,5-dichlorophenol used in the international ring test (7), may be tested as a means of checking the test procedure. It is advisable to test a reference chemical at least twice a year or, where testing is carried out at a lower frequency, in parallel to the determination of the toxicity of a test chemical.

DESCRIPTION OF THE METHOD

Apparatus

14. All equipment in contact with the test media should be made of glass or other chemically inert material. Glassware used for culturing and testing purposes should be cleaned of chemical contaminants that might leach into the test medium and should be sterile. The test vessels should be wide enough for the fronds of different colonies in the control vessels to grow without overlapping at the end of the test. It does not matter if the roots touch the bottoms of the test vessels, but a minimum depth of 20 mm and minimum volume of 100 ml in each test vessel is advised. The choice of test vessels is not critical as long as these requirements are met. Glass beakers, crystallising dishes or glass petri dishes of appropriate dimensions have all proved suitable. Test vessels must be covered to minimise evaporation and

▼ M6

accidental contamination, while allowing necessary air exchange. Suitable test vessels, and particularly covers, must avoid shadowing or changes in the spectral characteristics of light.

15. The cultures and test vessels should not be kept together. This is best achieved using separate environmental growth chambers, incubators, or rooms. Illumination and temperature must be controllable and maintained at a constant level (see paragraphs 35-36).

Test organism

16. The organism used for this test is either *Lemna gibba* or *Lemna minor*. Short descriptions of duckweed species that have been used for toxicity testing are given in Appendix 2. Plant material may be obtained from a culture collection, another laboratory or from the field. If collected from the field, plants should be maintained in culture in the same medium as used for testing for a minimum of eight weeks prior to use. Field sites used for collecting starting cultures must be free of obvious sources of contamination. If obtained from another laboratory or a culture collection they should be similarly maintained for a minimum of three weeks. The source of plant material and the species and clone (if known) used for testing should always be reported.
17. Monocultures, that are visibly free from contamination by other organisms such as algae and protozoa, should be used. Healthy plants of *L. minor* will consist of colonies comprising between two and five fronds whilst healthy colonies of *L. gibba* may contain up to seven fronds.
18. The quality and uniformity of the plants used for the test will have a significant influence on the outcome of the test and should therefore be selected with care. Young, rapidly growing plants without visible lesions or discoloration (chlorosis) should be used. Good quality cultures are indicated by a high incidence of colonies comprising at least two fronds. A large number of single fronds are indicative of environmental stress, e.g. nutrient limitation, and plant material from such cultures should not be used for testing.

Cultivation

19. To reduce the frequency of culture maintenance (e.g. when no *Lemna* tests are planned for a period), cultures can be held under reduced illumination and temperature (4 — 10 °C). Details of culturing are given in Appendix 3. Obvious signs of contamination by algae or other organisms may require surface sterilisation of a sub-sample of *Lemna* fronds, followed by transfer to fresh medium (see Appendix 3). In this eventuality the remaining contaminated culture should be discarded.
20. At least seven days before testing, sufficient colonies are transferred aseptically into fresh sterile medium and cultured for 7 - 10 days under the conditions of the test.

Test medium

21. Different media are recommended for *Lemna minor* and *Lemna gibba*, as described below. Careful consideration should be given to the inclusion of a pH buffer in the test medium (MOPS (4-morpholinepropane sulphonic acid, CAS No: 1132-61-2) in *L. minor* medium and NaHCO₃ in *L. gibba* medium) when it is suspected that it might react with the test chemical and influence the expression of its toxicity. Steinberg Medium (9) is also acceptable as long as the validity criteria are met.

▼ M6

22. A modification of the Swedish standard (SIS) *Lemna* growth medium is recommended for culturing and testing with *L. minor*. The composition of this medium is given in Appendix 4.
23. The growth medium, 20X — AAP, as described in Appendix 4, is recommended for culturing and testing with *L. gibba*.
24. Steinberg medium, as described in Appendix 4, is also suitable for *L. minor*, but may also be used for *L. gibba* as long as the validity criteria are met.

Test solutions

25. Test solutions are usually prepared by dilution of a stock solution. Stock solutions of the test chemical are normally prepared by dissolving the chemical in growth medium.
26. The highest tested concentration of the test chemical should not normally exceed the water solubility of the chemical under the test conditions. It should be noted however that *Lemna* spp. float on the surface and may be exposed to chemicals that collect at the water-air interface (e.g. poorly water-soluble or hydrophobic chemicals or surface-active chemicals). Under such circumstances exposure will result from material other than in solution and test concentrations may, depending on the characteristics of the test chemical, exceed water solubility. For test chemicals of low water solubility it may be necessary to prepare a concentrated stock solution or dispersion of the chemical using an organic solvent or dispersant in order to facilitate the addition of accurate quantities of the test chemical to the test medium and aid in its dispersion and dissolution. Every effort should be made to avoid the use of such materials. There should be no phytotoxicity resulting from the use of auxiliary solvents or dispersants. For example, commonly used solvents which do not cause phytotoxicity at concentrations up to 100 µl/l include acetone and dimethylformamide. If a solvent or dispersant is used, its final concentration should be reported and kept to a minimum (≤ 100 µl/l), and all treatments and controls should contain the same concentration of solvent or dispersant. Further guidance on the use of dispersants is given in (8).

Test and control groups

27. Prior knowledge of the toxicity of the test chemical to *Lemna*, e.g. from a range-finding test, will help in selecting suitable test concentrations. In the definitive toxicity test, there should normally be at least five test concentrations arranged in a geometric series. Preferably the separation factor between test concentrations should not exceed 3.2, but a larger value may be used where the concentration-response curve is flat. Justification should be provided if fewer than five concentrations are used. At least three replicates should be used at each test concentration.
28. In setting the range of test concentrations (for range-finding and/or for the definitive toxicity test), the following should be considered:
 - To determine an EC_x , test concentrations should bracket the EC_x value to ensure an appropriate level of confidence. For example, if estimating the EC_{50} , the highest test concentration should be greater than the EC_{50} value. If the EC_{50} value lies outside of the range of test concentrations, associated confidence intervals will be large and a proper assessment of the statistical fit of the model may not be possible.
 - If the aim is to estimate the LOEC/NOEC, the lowest test concentration should be low enough so that growth is not significantly less than that of the control. In addition, the highest test concentration should be high enough so that growth is significantly lower than that in the control. If

▼ M6

this is not the case, the test will have to be repeated using a different concentration range (unless the highest concentration is at the limit of solubility or the maximum required limit concentration, e.g. 100 mg/l).

29. Every test should include controls consisting of the same nutrient medium, number of fronds and colonies, environmental conditions and procedures as the test vessels but without the test chemical. If an auxiliary solvent or dispersant is used, an additional control treatment with the solvent/dispersant present at the same concentration as that in the vessels with the test chemical should be included. The number of replicate control vessels (and solvent vessels, if applicable) should be at least equal to, and ideally twice, the number of vessels used for each test concentration.
30. If determination of NOEC is not required, the test design may be altered to increase the number of concentrations and reduce the number of replicates per concentration. However, the number of control replicates must be at least three.

Exposure

31. Colonies consisting of 2 to 4 visible fronds are transferred from the inoculum culture and randomly assigned to the test vessels under aseptic conditions. Each test vessel should contain a total of 9 to 12 fronds. The number of fronds and colonies should be the same in each test vessel. Experience gained with this method and ring-test data have indicated that using three replicates per treatment, with each replicate containing 9 to 12 fronds initially, is sufficient to detect differences in growth of approximately 4 to 7 % of inhibition calculated by growth rate (10 to 15 % calculated by yield) between treatments (7).
32. A randomised design for location of the test vessels in the incubator is required to minimise the influence of spatial differences in light intensity or temperature. A blocked design or random repositioning of the vessels when observations are made (or repositioning more frequently) is also required.
33. If a preliminary stability test shows that the test chemical concentration cannot be maintained (i.e. the measured concentration falls below 80 % of the measured initial concentration) over the test duration (7 days), a semi-static test regime is recommended. In this case, the colonies should be exposed to freshly prepared test and control solutions on at least two occasions during the test (e.g. days 3 and 5). The frequency of exposure to fresh medium will depend on the stability of the test chemical; a higher frequency may be needed to maintain near-constant concentrations of highly unstable or volatile chemicals. In some circumstances, a flow-through procedure may be required (8)(10).
34. The exposure scenario through a foliar application (spray) is not covered in this test method; instead, see (11).

Incubation conditions

35. Continuous warm or cool white fluorescent lighting should be used to provide a light intensity selected from the range of 85-135 $\mu\text{E} \cdot \text{m}^{-2}\text{s}^{-1}$ when measured in a photosynthetically active radiation (400-700 nm) at points the same distance from the light source as the *Lemna* fronds (equivalent to 6 500-10 000 lux). Any differences from the selected light intensity over the test area should not exceed the range of $\pm 15\%$. The method of light detection and measurement, in particular the type of sensor, will affect the measured value. Spherical sensors (which respond to

▼ M6

light from all angles above and below the plane of measurement) and ‘cosine’ sensors (which respond to light from all angles above the plane of measurement) are preferred to unidirectional sensors, and will give higher readings for a multi-point light source of the type described here.

36. The temperature in the test vessels should be 24 ± 2 °C. The pH of the control medium should not increase by more than 1,5 units during the test. However, deviation of more than 1,5 units would not invalidate the test when it can be shown that validity criteria are met. Additional care is needed on pH drift in special cases such as when testing unstable chemicals or metals. See (8) for further guidance.

Duration

37. The test is terminated 7 days after the plants are transferred into the test vessels.

Measurements and analytical determinations

38. At the start of the test, frond number in the test vessels is counted and recorded, taking care to ensure that protruding, distinctly visible fronds are accounted for. Frond numbers appearing normal or abnormal, need to be determined at the beginning of the test, at least once every 3 days during the exposure period (i.e. on at least 2 occasions during the 7 day period), and at test termination. Changes in plant development, e.g. in frond size, appearance, indication of necrosis, chlorosis or gibbosity, colony break-up or loss of buoyancy, and in root length and appearance, should be noted. Significant features of the test medium (e.g. presence of undissolved material, growth of algae in the test vessel) should also be noted.
39. In addition to determinations of frond number during the test, effects of the test chemical on one (or more) of the following measurement variables are also assessed:
- (i) total frond area,
 - (ii) dry weight,
 - (iii) fresh weight.
40. Total frond area has an advantage, in that it can be determined for each test and control vessel at the start, during, and at the end of the test. Dry or fresh weight should be determined at the start of the test from a sample of the inoculum culture representative of what is used to begin the test, and at the end of the test with the plant material from each test and control vessel. If frond area is not measured, dry weight is preferred over fresh weight.
41. Total frond area, dry weight and fresh weight may be determined as follows:
- (i) *Total frond area*: The total frond area of all colonies may be determined by image analysis. A silhouette of the test vessel and plants can be captured using a video camera (i.e. by placing the vessel on a light box) and the resulting image digitised. By calibration with flat shapes of known area, the total frond area in a test vessel may then be determined. Care should be taken to exclude interference caused by the rim of the test vessel. An alternative but more laborious approach is to photocopy test vessels and plants, cut out the resulting silhouette of colonies and determine their area using a leaf area analyser or graph paper. Other techniques (e.g. paper weight ratio between silhouette area of colonies and unit area) may also be appropriate.

▼ M6

- (ii) *Dry weight:* All colonies are collected from each of the test vessels and rinsed with distilled or deionised water. They are blotted to remove excess water and then dried at 60 °C to a constant weight. Any root fragments should be included. The dry weight should be expressed to an accuracy of at least 0,1 mg.

- (iii) *Fresh weight:* All colonies are transferred to pre-weighed polystyrene (or other inert material) tubes with small (1 mm) holes in the rounded bottoms. The tubes are then centrifuged at 3 000 rpm for 10 minutes at room temperature. Tubes, containing the now dried colonies, are re-weighed and the fresh weight is calculated by subtracting the weight of the empty tube.

Frequency of measurements and analytical determinations

- 42. If a static test design is used, the pH of each treatment should be measured at the beginning and at the end of the test. If a semi-static test design is used, the pH should be measured in each batch of 'fresh' test solution prior to each renewal and also in the corresponding 'spent' solutions.

- 43. Light intensity should be measured in the growth chamber, incubator or room at points the same distance from the light source as the *Lemna* fronds. Measurements should be made at least once during the test. The temperature of the medium in a surrogate vessel held under the same conditions in the growth chamber, incubator or room should be recorded at least daily.

- 44. During the test, the concentrations of the test chemical are determined at appropriate intervals. In static tests, the minimum requirement is to determine the concentrations at the beginning and at the end of the test.

- 45. In semi-static tests where the concentration of the test chemical is not expected to remain within $\pm 20\%$ of the nominal concentration, it is necessary to analyse all freshly prepared test solutions and the same solutions at each renewal (see paragraph 33). However, for those tests where the measured initial concentration of the test chemical is not within $\pm 20\%$ of nominal but where sufficient evidence can be provided to show that the initial concentrations are repeatable and stable (i.e. within the range 80 - 120 % of the initial concentration), chemical determinations may be carried out on only the highest and lowest test concentrations. In all cases, determination of test chemical concentrations prior to renewal need only be performed on one replicate vessel at each test concentration (or the contents of the vessels pooled by replicate).

- 46. If a flow-through test is used, a similar sampling regime to that described for semi-static tests, including analysis at the start, mid-way through and at the end of the test, is appropriate, but measurement of 'spent' solutions is not appropriate in this case. In this type of test, the flow-rate of diluent and test chemical or test chemical stock solution should be checked daily.

- 47. If there is evidence that the concentration of the chemical being tested has been satisfactorily maintained within $\pm 20\%$ of the nominal or measured initial concentration throughout the test, analysis of the results can be based on nominal or measured initial values. If the deviation from the nominal or measured initial concentration is not within $\pm 20\%$, analysis of the results should be based on the geometric mean concentration during exposure or models describing the decline of the concentration of the test chemical (8).

▼ M6**Limit test**

48. Under some circumstances, e.g. when a preliminary test indicates that the test chemical has no toxic effects at concentrations up to 100 mg/l or up to its limit of solubility in the test medium (whichever is the lower), a limit test involving a comparison of responses in a control group and one treatment group (100 mg/l or a concentration equal to the limit of solubility), may be undertaken. It is strongly recommended that this be supported by analysis of the exposure concentration. All previously described test conditions and validity criteria apply to a limit test, with the exception that the number of treatment replicates should be doubled. Growth in the control and treatment group may be analysed using a statistical test to compare means, e.g. a Student's t-test.

DATA AND REPORTING**Doubling time**

49. To determine the doubling time (T_d) of frond number and adherence to this validity criterion by the study (paragraph 12), the following formula is used with data obtained from the control vessels:

$$T_d = \ln 2/\mu$$

where μ is the average specific growth rate determined as described in paragraphs 54-55.

Response variables

50. The purpose of the test is to determine the effects of the test chemical on the vegetative growth of *Lemna*. This Test Method describes two response variables, as different jurisdictions have different preferences and regulatory needs. In order for the test results to be acceptable in all jurisdictions, the effects should be evaluated using both response variables (a) and (b) described below.
- (a) *Average specific growth rate*: this response variable is calculated on the basis of changes in the logarithms of frond numbers, and in addition, on the basis of changes in the logarithms of another measurement parameter (total frond area, dry weight or fresh weight) over time (expressed per day) in the controls and each treatment group. It is sometimes referred to as relative growth rate (12).
- (b) *Yield*: this response variable is calculated on the basis of changes in frond number, and in addition, on the basis of changes in another measurement parameter (total frond area, dry weight or fresh weight) in the controls and in each treatment group until the end of the test.
51. It should be noted that toxicity values calculated by using these two response variables are not comparable and this difference must be recognised when using the results of the test. EC_x values based upon average specific growth rate (E_rC_x) will generally be higher than results based upon yield (E_yC_x) if the test conditions of this Test Method are adhered to, due to the mathematical basis of the respective approaches. This should not be interpreted as a difference in sensitivity between the two response variables, simply that the values are different mathematically. The concept of average specific growth rate is based on the general exponential growth pattern of duckweed in non-limited cultures, where toxicity is estimated on the basis of the effects on the growth rate, without being dependent on the absolute level of the specific growth rate of the control, slope of the concentration-response curve or on test duration. In contrast, results based upon the yield response variable are dependent upon all these other variables. E_yC_x is dependent on the specific growth rate of the duckweed species used in each test and on the maximum specific growth rate that can vary between species and even different clones. This response variable should not be used for comparing the sensitivity to

▼M6

toxicants among duckweed species or even different clones. While the use of average specific growth rate for estimating toxicity is scientifically preferred, toxicity estimates based on yield are also included in this Test Method to satisfy current regulatory requirements in some jurisdictions.

52. Toxicity estimates should be based on frond number and one additional measurement variable (total frond area, dry weight or fresh weight), because some chemicals may affect other measurement variables much more than the frond number. This effect would not be detected by calculating frond number only.
53. The number of fronds as well as any other recorded measurement variable, i.e. total frond area, dry weight or fresh weight, are tabulated together with the concentrations of the test chemical for each measurement occasion. Subsequent data analysis e.g. to estimate a LOEC, NOEC or EC_x should be based on the values for the individual replicates and not calculated means for each treatment group.

Average specific growth rate

54. The average specific growth rate for a specific period is calculated as the logarithmic increase in the growth variables -frond numbers and one other measurement variable (total frond area, dry weight or fresh weight) — using the formula below for each replicate of control and treatments:

$$\mu_{i-j} = \frac{\ln(N_j) - \ln(N_i)}{t}$$

where:

- μ_{i-j} : average specific growth rate from time i to j
- N_i : measurement variable in the test or control vessel at time i
- N_j : measurement variable in the test or control vessel at time j
- t: time period from i to j

For each treatment group and control group, calculate a mean value for growth rate along with variance estimates.

55. The average specific growth rate should be calculated for the entire test period (time 'i' in the above formula is the beginning of the test and time 'j' is the end of the test). For each test concentration and control, calculate a mean value for average specific growth rate along with the variance estimates. In addition, the section-by-section growth rate should be assessed in order to evaluate effects of the test chemical occurring during the exposure period (e.g. by inspecting log-transformed growth curves). Substantial differences between the section-by-section growth rate and the average growth rate indicate deviation from constant exponential growth and that close examination of the growth curves is warranted. In this case, a conservative approach would be to compare specific growth rates from treated cultures during the time period of maximum inhibition to those for controls during the same time period.
56. Percent inhibition of growth rate (I_p) may then be calculated for each test concentration (treatment group) according to the following formula:

▼ M6

$$\% I_r = \frac{(\mu_C - \mu_T)}{\mu_C} \times 100$$

where:

- % I_r : percent inhibition in average specific growth rate
- μ_C : mean value for μ in the control
- μ_T : mean value for μ in the treatment group

Yield

57. Effects on yield are determined on the basis of two measurement variables, frond number and one other measurement variable (total frond area, dry weight or fresh weight) present in each test vessel at the start and at the end of the test. For dry weight or fresh weight, the starting biomass is determined on the basis of a sample of fronds taken from the same batch used to inoculate the test vessels (see paragraph 20). For each test concentration and control, calculate a mean value for yield along with variance estimates. The mean percent inhibition in yield (% I_y) may be calculated for each treatment group as follows:

$$\% I_y = \frac{(b_c - b_T)}{b_c} \times 100$$

where:

- % I_y : percent reduction in yield
- b_c : final biomass minus starting biomass for the control group
- b_T : final biomass minus starting biomass in the treatment group

Plotting concentration-response curves

58. Concentration-response curves relating mean percentage inhibition of the response variable (I_r , or I_y calculated as shown in paragraph 56 or 57) and the log concentration of the test chemical should be plotted.

EC_x estimation

59. Estimates of the EC_x (e.g., EC₅₀) should be based upon both average specific growth rate (E_rC_x) and yield (E_yC_x), each of which should in turn be based upon frond number and one additional measurement variable (total frond area, dry weight, or fresh weight). This is because there are test chemicals that impact frond number and other measurement variables differently. The desired toxicity parameters are therefore four EC_x values for each inhibition level x calculated: E_rC_x (frond number); E_rC_x (total frond area, dry weight, or fresh weight); E_yC_x (frond number); and E_yC_x (total frond area, dry weight, or fresh weight).

Statistical procedures

60. The aim is to obtain a quantitative concentration-response relationship by regression analysis. It is possible to use a weighted linear regression after having performed a linearising transformation of the response data, for instance into probit or logit or Weibull units (13), but non-linear regression procedures are preferred techniques that better handle unavoidable data irregularities and deviations from smooth distributions. Approaching either zero or total inhibition such irregularities may be magnified by the transformation, interfering with the analysis (13). It should be noted that standard methods of analysis using probit, logit, or Weibull transforms are intended for use on quantal (e.g. mortality or survival) data, and must be modified to

▼ M6

accommodate growth rate or yield data. Specific procedures for determination of EC_x values from continuous data can be found in (14), (15), and (16).

61. For each response variable to be analysed, use the concentration-response relationship to calculate point estimates of EC_x values. When possible, the 95 % confidence limits for each estimate should be determined. Goodness of fit of the response data to the regression model should be assessed either graphically or statistically. Regression analysis should be performed using individual replicate responses, not treatment group means.
62. EC_{50} estimates and confidence limits may also be obtained using linear interpolation with bootstrapping (17), if available regression models/methods are unsuitable for the data.
63. For estimation of the LOEC and hence the NOEC, it is necessary to compare treatment means using analysis of variance (ANOVA) techniques. The mean for each concentration must then be compared with the control mean using an appropriate multiple comparison or trend test method. Dunnett's or Williams' test may be useful (18)(19)(20)(21). It is necessary to assess whether the ANOVA assumption of homogeneity of variance holds. This assessment may be performed graphically or by a formal test (22). Suitable tests are Levene's or Bartlett's. Failure to meet the assumption of homogeneity of variances can sometimes be corrected by logarithmic transformation of the data. If heterogeneity of variance is extreme and cannot be corrected by transformation, analysis by methods such as step-down Jonkheere trend tests should be considered. Additional guidance on determining the NOEC can be found in (16).
64. Recent scientific developments have led to a recommendation of abandoning the concept of NOEC and replacing it with regression based point estimates EC_x . An appropriate value for x has not been established for this *Lemma* test. However, a range of 10 to 20 % appears to be appropriate (depending on the response variable chosen), and preferably both the EC_{10} and EC_{20} should be reported.

Reporting

65. The test report must include the following:

Test chemical:

- physical nature and physical-chemical properties, including water solubility limit;
- chemical identification data (e.g., CAS Number), including purity (impurities).

Test species:

- scientific name, clone (if known) and source.

Test conditions:

- test procedure used (static, semi-static or flow-through);
- date of start of the test and its duration;
- test medium;
- description of the experimental design: test vessels and covers, solution volumes, number of colonies and fronds per test vessel at the beginning of the test;
- test concentrations (nominal and measured as appropriate) and number of replicates per concentration;

▼ M6

- methods of preparation of stock and test solutions including the use of any solvents or dispersants;
- temperature during the test;
- light source, light intensity and homogeneity;
- pH values of the test and control media;
- test chemical concentrations and the method of analysis with appropriate quality assessment data (validation studies, standard deviations or confidence limits of analyses);
- methods for determination of frond number and other measurement variables, e.g. dry weight, fresh weight or frond area;
- all deviations from this Test Method.

Results:

- raw data: number of fronds and other measurement variables in each test and control vessel at each observation and occasion of analysis;
- means and standard deviations for each measurement variable;
- growth curves for each concentration (recommended with log transformed measurement variable, see paragraph 55);
- doubling time/growth rate in the control based on the frond number;
- calculated response variables for each treatment replicate, with mean values and coefficient of variation for replicates;
- graphical representation of the concentration/effect relationship;
- estimates of toxic endpoints for response variables e.g. EC₅₀, EC₁₀, EC₂₀, and associated confidence intervals. If calculated, LOEC and/or NOEC and the statistical methods used for their determination;
- if ANOVA has been used, the size of the effect which can be detected (e.g. the least significant difference);
- any stimulation of growth found in any treatment;
- any visual signs of phytotoxicity as well as observations of test solutions;
- discussion of the results, including any influence on the outcome of the test resulting from deviations from this Test Method.

LITERATURE

- (1) ASTM International. (2003). Standard Guide for Conducting Static Toxicity Test With *Lemna gibba* G3. E 1415-91 (Reapproved 1998). pp. 733-742. In, Annual Book of ASTM Standards, Vol. 11.05 Biological Effects and Environmental Fate; Biotechnology; Pesticides, ASTM, West Conshohocken, PA.
- (2) US EPA — United States Environmental Protection Agency. (1996). OPPTS 850.4400 Aquatic Plant Toxicity Test Using *Lemna* spp., 'Public draft'. EPA 712-C-96-156. 8pp.
- (3) AFNOR — Association Française de Normalisation. (1996). XP T 90-337: Détermination de l'inhibition de la croissance de *Lemna minor*. 10pp.
- (4) SSI — Swedish Standards Institute. (1995). Water quality — Determination of growth inhibition (7-d) *Lemna minor*, duckweed. SS 02 82 13. 15pp. (in Swedish).

▼ **M6**

- (5) Environment Canada. (1999). Biological Test Method: Test for Measuring the Inhibition of Growth Using the Freshwater Macrophyte, *Lemna minor*. EPS 1/RM/37 - 120 pp.
- (6) Environment Canada. (1993) Proposed Guidelines for Registration of Chemical Pesticides: Non-Target Plant Testing and Evaluation. Canadian Wildlife Service, Technical Report Series No. 145.
- (7) Sims I., Whitehouse P. and Lacey R. (1999) The OECD *Lemna* Growth Inhibition Test. Development and Ring-testing of draft OECD Test Guideline. R&D Technical Report EMA 003. WRc plc — Environment Agency.
- (8) OECD (2000). Guidance Document on Aquatic Toxicity Testing of Difficult Substances and Mixtures. OECD Environmental Health and Safety Publications, Series on Testing and Assessment No.23. Organisation for Economic Co-operation and Development, Paris.
- (9) International Organisation for Standardisation. ISO DIS 20079. Water Quality — Determination of the Toxic Effect of Water Constituents and Waste Water to Duckweed (*Lemna minor*) — Duckweed Growth Inhibition Test.
- (10) Walbridge C. T. (1977). A flow-through testing procedure with duckweed (*Lemna minor* L.). Environmental Research Laboratory — Duluth, Minnesota 55804. US EPA Report No. EPA-600/3-77 108. September 1977.
- (11) Lockhart W. L., Billeck B. N. and Baron C. L. (1989). Bioassays with a floating plant (*Lemna minor*) for effects of sprayed and dissolved glyphosate. *Hydrobiologia*, 118/119, 353 — 359.
- (12) Huebert, D.B. and Shay J.M. (1993) Considerations in the assessment of toxicity using duckweeds. *Environmental Toxicology and Chemistry*, 12, 481-483.
- (13) Christensen, E.R., Nyholm, N. (1984): Ecotoxicological Assays with Algae: Weibull Dose-Response Curves. *Env. Sci. Technol.* 19, 713-718.
- (14) Nyholm, N. Sørensen, P.S., Kusk, K.O. and Christensen, E.R. (1992): Statistical treatment of data from microbial toxicity tests. *Environ. Toxicol. Chem.* 11, 157-167.
- (15) Bruce R.D. and Versteeg D.J. (1992) A statistical procedure for modelling continuous toxicity data. *Environmental Toxicology and Chemistry*, 11, 1485-1494.
- (16) OECD. (2006). Current Approaches in the Statistical Analysis of Ecotoxicity Data: A Guidance to Application. Organisation for Economic Co-operation and Development, Paris.
- (17) Norberg-King T.J. (1988) An interpolation estimate for chronic toxicity: The ICp approach. National Effluent Toxicity Assessment Center Technical Report 05-88. US EPA, Duluth, MN.
- (18) Dunnett, C.W. (1955) A multiple comparisons procedure for comparing several treatments with a control. *J. Amer. Statist. Assoc.*, 50, 1096-1121.
- (19) Dunnett, C.W. (1964) New tables for multiple comparisons with a control. *Biometrics*, 20, 482-491.
- (20) Williams, D.A. (1971) A test for differences between treatment means when several dose levels are compared with a zero dose control. *Biometrics*, 27: 103-117.
- (21) Williams, D.A. (1972) The comparison of several dose levels with a zero dose control. *Biometrics*, 28: 519-531.
- (22) Brain P. and Cousens R. (1989). An equation to describe dose-responses where there is stimulation of growth at low doses. *Weed Research*, 29, 93-96.

▼ M6*Appendix 1***Definitions**

The following definitions and abbreviations are used for the purposes of this Test Method:

Biomass is the dry weight of living matter present in a population. In this test, surrogates for biomass, such as frond counts or frond area are typically measured and the use of the term 'biomass' thus refers to these surrogate measures as well.

Chemical means a substance or a mixture.

Chlorosis is yellowing of frond tissue.

Clone is an organism or cell arisen from a single individual by asexual reproduction. Individuals from the same clone are, therefore, genetically identical.

Colony means an aggregate of mother and daughter fronds (usually 2 to 4) attached to each other. Sometimes referred to as a plant.

EC_x is the concentration of the test chemical dissolved in test medium that results in a x % (e.g. 50 %) reduction in growth of *Lemna* within a stated exposure period (to be mentioned explicitly if deviating from full or normal test duration). To unambiguously denote an EC value deriving from growth rate or yield the symbol 'E_rC' is used for growth rate and 'E_yC' is used for yield, followed by the measurement variable used, e.g. E_rC (frond number).

Flow-through is a test in which the test solutions are replaced continuously.

Frond is an individual/single 'leaf-like' structure of a duckweed plant. It is the smallest unit, i.e. individual, capable of reproduction.

Gibbosity means fronds exhibiting a humped or swollen appearance.

Growth is an increase in the measurement variable, e.g. frond number, dry weight, wet weight or frond area, over the test period.

Growth rate (average specific growth rate) is the logarithmic increase in biomass during the exposure period.

Lowest Observed Effect Concentration (LOEC) is the lowest tested concentration at which the chemical is observed to have a statistically significant reducing effect on growth (at $p < 0,05$) when compared with the control, within a given exposure time. However, all test concentrations above the LOEC must have a harmful effect equal to or greater than those observed at the LOEC. When these two conditions cannot be satisfied, a full explanation must be given for how the LOEC (and hence the NOEC) has been selected.

Measurement variables are any type of variables which are measured to express the test endpoint using one or more different response variables. In this method frond number, frond area, fresh weight and dry weight are measurement variables.

Monoculture is a culture with one plant species.

Necrosis is dead (i.e. white or water-soaked) frond tissue.

No Observed Effect Concentration (NOEC) is the test concentration immediately below the LOEC.

Phenotype is the observable characteristics of an organism determined by the interaction of its genes with its environment.

Response variable are variables for the estimation of toxicity derived from any measured variables describing biomass by different methods of calculation. For this Test Method growth rates and yield are response variables derived from measurement variables like frond number, frond area, fresh weight or dry weight.

▼ M6

Semi-static (renewal) test is a test in which the test solution is periodically replaced at specific intervals during the test.

Static test is a test method without renewal of the test solution during the test.

Test chemical is any substance or mixture tested using this test method.

Test endpoint describes the general factor that will be changed relative to control by the test chemical as aim of the test. In this test method the test endpoint is inhibition of growth which may be expressed by different response variables which are based on one or more measurement variables.

Test medium is the complete synthetic growth medium on which test plants grow when exposed to the test chemical. The test chemical will normally be dissolved in the test medium.

Yield is value of a measurement variable to express biomass at the end of the exposure period minus the measurement variable at the start of the exposure period.

▼ **M6***Appendix 2***Description of *Lemna* spp.**

The aquatic plant commonly referred to as duckweed, *Lemna* spp., belongs to the family Lemnaceae which has a number of world-wide species in four genera. Their different appearance and taxonomy have been exhaustively described (1)(2). *Lemna gibba* and *L. minor* are species representative of temperate areas and are commonly used for toxicity tests. Both species have a floating or submerged discoid stem (frond) and a very thin root emanates from the centre of the lower surface of each frond. *Lemna* spp. rarely produce flowers and the plants reproduce by vegetatively producing new fronds (3). In comparison with older plants the younger ones tend to be paler, have shorter roots and consist of two to three fronds of different sizes. The small size of *Lemna*, its simple structure, asexual reproduction and short generation time makes plants of this genus very suitable for laboratory testing (4)(5).

Because of probable interspecies variation in sensitivity, only comparisons of sensitivity within a species are valid.

Examples of *Lemna* species which have been used for testing: Species Reference

Lemna aequinoctialis: Eklund, B. (1996). The use of the red alga *Ceramium strictum* and the duckweed *Lemna aequinoctialis* in aquatic ecotoxicological bioassays. Licentiate in Philosophy Thesis 1996:2. Dep. of Systems Ecology, Stockholm University.

Lemna major: Clark, N. A. (1925). The rate of reproduction of *Lemna major* as a function of intensity and duration of light. J. phys. Chem., 29: 935-941.

Lemna minor: United States Environmental Protection Agency (US EPA). (1996). OPPTS 850.4400 Aquatic Plant Toxicity Test Using *Lemna* spp., 'Public draft'. EPA 712-C-96-156. 8pp.

Association Française de Normalisation (AFNOR). (1996). XP T 90-337: Détermination de l'inhibition de la croissance de *Lemna minor*. 10pp.

Swedish Standards Institute (SIS). (1995). Water quality — Determination of growth inhibition (7-d) *Lemna minor*, duckweed. SS 02 82 13. 15pp. (in Swedish).

Lemna gibba: ASTM International. (2003). Standard Guide for Conducting Static Toxicity Test With *Lemna gibba* G3. E 1415-91 (Reapproved 1998). pp. 733-742.

United States Environmental Protection Agency (US EPA). (1996). OPPTS 850.4400 Aquatic Plant Toxicity Test Using *Lemna* spp., 'Public draft'. EPA 712-C-96-156. 8pp.

Lemna paucicostata: Nasu, Y., Kugimoto, M. (1981). *Lemna* (duckweed) as an indicator of water pollution. I. The sensitivity of *Lemna paucicostata* to heavy metals. Arch. Environ. Contam. Toxicol., 10:1959-1969.

Lemna perpusilla: Clark, J. R. et al. (1981). Accumulation and depuration of metals by duckweed (*Lemna perpusilla*). Ecotoxicol. Environ. Saf., 5:87-96.

Lemna trisulca: Huebert, D. B., Shay, J. M. (1993). Considerations in the assessment of toxicity using duckweeds. Environ. Toxicol. and Chem., 12:481-483.

Lemna valdiviana: Hutchinson, T.C., Czyrska, H. (1975). Heavy metal toxicity and synergism to floating aquatic weeds. Verh.-Int. Ver. Limnol., 19:2102-2111.

Sources of *Lemna* species

University of Toronto Culture Collection of Algae and Cyanobacteria
 Department of Botany, University of Toronto
 Toronto, Ontario, Canada, M5S 3 B2
 Tel: +1-416-978-3641
 Fax: +1-416-978-5878
 e-mail: jacreman@botany.utoronto.ca

▼M6

North Carolina State University
Forestry Dept
Duckweed Culture Collection
Campus Box 8002
Raleigh, NC 27695-8002
United States
phone 001 (919) 515-7572
astomp@unity.ncsu.edu

Institute of Applied Environmental Research (ITM) Stockholm University
SE-106 91
STOCKHOLM
SWEDEN
Tel: +46 8 674 7240
Fax +46 8 674 7636

Federal Environmental Agency (UBA)
FG III 3.4
Schichauweg 58
12307 Berlin
Germany
e-mail: lemna@uba.de

LITERATURE

- (1) Hillman, W.S. (1961). The Lemnaceae or duckweeds: A review of the descriptive and experimental literature. *The Botanical Review*, 27:221-287.
- (2) Landolt, E. (1986). Biosystematic investigations in the family of duckweed (*Lemnaceae*). Vol. 2. Geobotanischen Inst. ETH, Stiftung Rubel, Zürich, Switzerland.
- (3) Björndahl, G. (1982). Growth performance, nutrient uptake and human utilization of duckweeds (*Lemnaceae* family). ISBN 82-991150-0-0. The Agricultural Research Council of Norway, University of Oslo.
- (4) Wang, W. (1986). Toxicity tests of aquatic pollutants by using common duckweed. *Environmental Pollution, Ser B*, 11:1-14.
- (5) Wang, W. (1990). Literature review on duckweed toxicity testing. *Environmental Research*, 52:7-22.

▼ M6*Appendix 3***Maintenance of stock culture**

Stock cultures can be maintained under lower temperatures (4-10 °C) for longer times without needing to be re-established. The *Lemna* growth medium may be the same as that used for testing but other nutrient rich media can be used for stock cultures.

Periodically, a number of young, light-green plants are removed to new culture vessels containing fresh medium using an aseptic technique. Under the cooler conditions suggested here, sub-culturing may be conducted at intervals of up to three months.

Chemically clean (acid-washed) and sterile glass culture vessels should be used and aseptic handling techniques employed. In the event of contamination of the stock culture e.g. by algae or fungi, steps are necessary to eliminate the contaminating organisms. In the case of algae and most other contaminating organisms, this can be achieved by surface sterilisation. A sample of the contaminated plant material is taken and the roots cut off. The material is then shaken vigorously in clean water, followed by immersion in a 0,5 % (v/v) sodium hypochlorite solution for between 30 seconds and 5 minutes. The plant material is then rinsed with sterile water and transferred, as a number of batches, into culture vessels containing fresh growth medium. Many fronds will die as a result of this treatment, especially if longer exposure periods are used, but some of those surviving will usually be free of contamination. These can then be used to re-inoculate new cultures.

▼ **M6***Appendix 4***Media**

Different growth media are recommended for *L. minor* and *L. gibba*. For *L. minor*, a modified Swedish Standard (SIS) medium is recommended whilst for *L. gibba*, 20X AAP medium is recommended. Compositions of both media are given below. When preparing these media, reagent or analytical-grade chemicals should be used and deionised water.

Swedish Standard (SIS) *Lemna* growth medium

— Stock solutions I - V are sterilised by autoclaving (120 °C, 15 minutes) or by membrane filtration (approximately 0,2 µm pore size).

— Stock VI (and optional VII) are sterilised by membrane filtration only; these should not be autoclaved.

— Sterile stock solutions should be stored under cool and dark conditions. Stocks I - V should be discarded after six months whilst stocks VI (and optional VII) have a shelf life of one month.

Stock solution No.	Substance	Concentration in stock solution (g/l)	Concentration in prepared medium (mg•l)	Prepared medium	
				Element	Concentration (mg•l)
I	NaNO ₃	8,50	85	Na; N	32; 14
	KH ₂ PO ₄	1,34	13,4	K; P	6,0; 2,4
II	MgSO ₄ · 7H ₂ O	15	75	Mg; S	7,4; 9,8
III	CaCl ₂ · 2H ₂ O	7,2	36	Ca; Cl	9,8; 17,5
IV	Na ₂ CO ₃	4,0	20	C	2,3
V	H ₃ BO ₃	1,0	1,00	B	0,17
	MnCl ₂ · 4H ₂ O	0,20	0,20	Mn	0,056
	Na ₂ MoO ₄ · 2H ₂ O	0,010	0,010	Mo	0,0040
	ZnSO ₄ · 7H ₂ O	0,050	0,050	Zn	0,011
	CuSO ₄ · 5H ₂ O	0,0050	0,0050	Cu	0,0013
	Co(NO ₃) ₂ · 6H ₂ O	0,010	0,010	Co	0,0020
VI	FeCl ₃ · 6H ₂ O	0,17	0,84	Fe	0,17
	Na ₂ -EDTA 2H ₂ O	0,28	1,4	—	—
VII	MOPS (buffer)	490	490	—	—

To prepare one litre of SIS medium, the following are added to 900 ml of deionised water:

▼ M6

- 10 ml of stock solution I
- 5 ml of stock solution II
- 5 ml of stock solution III
- 5 ml of stock solution IV
- 1 ml of stock solution V
- 5 ml of stock solution VI
- 1 ml of stock solution VII (optional)

Note: A further stock solution VII (MOPS buffer) may be needed for certain test chemicals (see paragraph 11).

The pH is adjusted to $6,5 \pm 0,2$ with either 0,1 or 1 mol HCl or NaOH, and the volume adjusted to one litre with deionised water.

20X AAP growth medium

Stock solutions are prepared in sterile distilled or deionised water.

Sterile stock solutions should be stored under cool and dark conditions. Under these conditions the stock solutions will have a shelf life of at least 6 - 8 weeks.

Five nutrient stock solutions (A1, A2, A3, B and C) are prepared for 20X — AAP medium, using reagent-grade chemicals. The 20 ml of each nutrient stock solution is added to approximately 850 ml deionised water to produce the growth medium. The pH is adjusted to $7,5 \pm 0,1$ with either 0,1 or 1 mol HCl or NaOH, and the volume adjusted to one litre with deionised water. The medium is then filtered through a 0,2 μm (approximate) membrane filter into a sterile container.

Growth medium intended for testing should be prepared 1-2 days before use to allow the pH to stabilise. The pH of the growth medium should be checked prior to use and readjusted if necessary by the addition of 0,1 or 1 mol NaOH or HCl as described above.

Stock solution No.	Sustance	Concentration in stock solution (g/l) (*)	Concentration in prepared medium (mg/l) (*)	Prepared medium	
				Element	Concentration (mg/l) (*)
A1	NaNO ₃	26	510	Na;N	190;84
	MgCl ₂ · 6H ₂ O	12	240	Mg	58,08
	CaCl ₂ · 2H ₂ O	4,4	90	Ca	24,04
A2	MgSO ₄ · 7H ₂ O	15	290	S	38,22
A3	K ₂ HPO ₄ · 3H ₂ · O	1,4	30	K;P	9,4;3,7
B	H ₃ BO ₃	0,19	3,7	B	0,65
	MnCl ₂ · 4H ₂ O	0,42	8,3	Mn	2,3
	FeCl ₃ · 6H ₂ O	0,16	3,2	Fe	0,66

▼ **M6**

Stock solution No.	Sustance	Concentration in stock solution (g/l) (*)	Concentration in prepared medium (mg/l) (*)	Prepared medium	
				Element	Concentration (mg/l) (*)
	Na ₂ EDTA.2H ₂ O	0,30	6,0	—	—
	ZnCl ₂	3,3 mg/l	66 µg/l	Zn	31 µg/l
	CoCl ₂ · 6H ₂ O	1,4 mg/l	29 µg/l	Co	7,1 µg/l
	Na ₂ MoO ₄ · 2H ₂ O	7,3 mg/l	145 µg/l	Mo	58 µg/l
	CuCl ₂ · 2H ₂ O	0,012 mg/l	0,24 µg/l	Cu	0,080 µg/l
C	NaHCO ₃	15	300	Na ₂ C	220; 43

(*) Unless noted

Note: The theoretically appropriate final bicarbonate concentration (which will avoid appreciable pH adjustment) is 15 mg/L, not 300 mg/L. However, the historical use of 20X-AAP medium, including the ring test for this guideline, is based upon 300 mg/L. (I. Sims, P. Whitehouse and R. Lacey, (1999) The OECD *Lemna* Growth Inhibition Test. Development and Ring-testing of draft OECD Test Guideline. R&D Technical Report EMA 003. WRc plc — Environment Agency.)

STEINBERG medium (After ISO 20079)

Concentrations and stock solutions

The modified Steinberg medium is used in ISO 20079 for *Lemna minor* alone (as only *Lemna minor* is allowed there) but tests showed good results could be reached with *Lemna gibba* too.

When preparing the medium, reagent- or analytical grade chemicals and deionised water should be used.

Prepare the nutrient medium from stock solutions or the 10 fold concentrated medium which allows maximum concentration of the medium without precipitation.

Table 1

pH-stabilised STEINBERG medium (modified acc. to Altenburger)

Component		Nutrient medium	
Macroelements	mol weight	mg/l	mmol/l
KNO ₃	101,12	350,00	3,46
Ca(NO ₃) ₂ · 4H ₂ O	236,15	295,00	1,25
KH ₂ PO ₄	136,09	90,00	0,66
K ₂ HPO ₄	174,18	12,60	0,072
MgSO ₄ · 7H ₂ O	246,37	100,00	0,41

▼ **M6**

Component		Nutrient medium	
Microelements	mol weight	µg/l	µmol/l
H ₃ BO ₃	61,83	120,00	1,94
ZnSO ₄ · 7H ₂ O	287,43	180,00	0,63
Na ₂ MoO ₄ · 2H ₂ O	241,92	44,00	0,18
MnCl ₂ · 4H ₂ O	197,84	180,00	0,91
FeCl ₃ · 6H ₂ O	270,21	760,00	2,81
EDTA Disodium-dihydrate	372,24	1 500,00	4,03

Table 2

Stock solutions (Macroelements)

1. Macroelements (50-fold concentrated)	g/l
Stock solution 1:	
KNO ₃	17,50
KH ₂ PO ₄	4,5
K ₂ HPO ₄	0,63
Stock solution 2:	
MgSO ₄ · 7H ₂ O	5,00
Stock solution 3:	
Ca(NO ₃) ₂ · 4H ₂ O	14,75

Table 3

Stock solutions (Microelements)

2. Microelements (1 000-fold concentrated)	mg/l
Stock solution 4:	
H ₃ BO ₃	120,0
Stock solution 5:	
ZnSO ₄ · 7H ₂ O	180,0
Stock solution 6:	
Na ₂ MoO ₄ · 2H ₂ O	44,0
Stock solution 7:	
MnCl ₂ · 4H ₂ O	180,0
Stock solution 8:	
FeCl ₃ · 6H ₂ O	760,00
EDTA Disodium-dihydrate	1 500,00

— Stock solutions 2 and 3 and separately 4 to 7 may be pooled (taking into account the required concentrations).

▼ M6

- For longer shelf life treat stock solutions in an autoclave at 121 °C for 20 min or alternatively carry out a sterile filtration (0,2 µm). For stock solution 8 sterile filtration (0,2 µm) is strongly recommended.

Preparation of the final concentration of STEINBERG medium (modified)

- Add 20 ml of stock solutions 1, 2 and 3 (see table 2) to about 900 ml deionised water to avoid precipitation.
- Add 1,0 ml of stock solutions 4, 5, 6, 7 and 8 (see table 3).
- The pH should be to 5,5 +/- 0,2 (adjust by addition of a minimised volume of NaOH solution or HCl).
- Adjust with water to 1 000 ml.
- If stock solutions are sterilised and appropriate water is used no further sterilisation is necessary. If sterilisation is done with the final medium stock solution 8 should be added after autoclaving (at 121 °C for 20 min).

Preparation of 10-fold-concentrated STEINBERG medium (modified) for intermediate storage

- Add to 20 ml of stock solutions 1, 2 and 3 (see table 2) to about 30 ml water to avoid precipitation.
- Add 1,0 ml of stock solutions 4, 5, 6, 7 and 8 (see table 3). Adjust with water to 100 ml.
- If stock solutions are sterilised and appropriate water is used no further sterilisation is necessary. If sterilisation is done with the final medium stock solution 8 should be added after autoclaving (at 121 °C for 20 min).
- The pH of the medium (final concentration) should be 5,5 ± 0,2.

▼ **M4****C.27. SEDIMENT-WATER CHIRONOMID TOXICITY TEST USING SPIKED SEDIMENT**

INTRODUCTION

1. This Test Method is equivalent to OECD Test Guideline (TG) 218 (2004). This Test Method is designed to assess the effects of prolonged exposure of chemicals to the sediment-dwelling larvae of the freshwater dipteran *Chironomus* sp. It is based on existing toxicity test protocols for *Chironomus riparius* and *Chironomus tentans* which have been developed in Europe (1)(2)(3) and North America (4)(5)(6)(7)(8) and ring-tested (1)(6)(9). Other well documented chironomid species may also be used, e.g. *Chironomus yoshimatsui* (10)(11).
2. The exposure scenario used in this Test Method is spiking of sediment with the test substance. The selection of the appropriate exposure scenario depends on the intended application of the test. The scenario of spiking sediment is intended to simulate accumulated levels of chemicals persisting in the sediment. This exposure system involves spiking sediment of a sediment-water test system.
3. Substances that need to be tested towards sediment-dwelling organisms usually persist in this compartment over long time periods. The sediment-dwelling organisms may be exposed via a number of routes. The relative importance of each exposure route, and the time taken for each to contribute to the overall toxic effects, is dependent on the physical-chemical properties of the chemical concerned. For strongly adsorbing substances (e.g. with $\log K_{ow} > 5$) or for substances covalently binding to sediment, ingestion of contaminated food may be a significant exposure route. In order not to underestimate the toxicity of highly lipophilic substances, the use of food added to the sediment before application of the test substance may be considered. In order to take all potential routes of exposure into account the focus of this Test Method is on long-term exposure. The test duration is in the range of 20-28 days for *C. riparius* and *C. yoshimatsui*, and 28-65 days for *C. tentans*. If short-term data are required for a specific purpose, for example to investigate the effects of an unstable chemical, additional replicates may be removed after a 10-day period.
4. The measured endpoints are the total number of adults emerged and the time to emergence. It is recommended that measurements of larval survival and growth should only be made after a 10-day period if additional short-term data are required, using additional replicates as appropriate.
5. The use of formulated sediment is recommended. Formulated sediment has several advantages over natural sediments:
 - the experimental variability is reduced because it forms a reproducible ‘standardised matrix’ and the need to find uncontaminated and clean sediment sources is eliminated;
 - the tests can be initiated at any time without encountering seasonal variability in the test sediment and there is no need to pre-treat the sediment to remove indigenous fauna; the use of formulated sediment also reduces the cost associated with the field collection of sufficient amounts of sediment for routine testing;
 - the use of formulated sediment allows for comparisons of toxicity and ranking substances accordingly.
6. Definitions used are given in Appendix 1.

▼M4

PRINCIPLE OF THE TEST

7. First instar chironomid larvae are exposed to a concentration range of the test chemical in sediment — water systems. The test substance is spiked into the sediment and first instar larvae are subsequently introduced into test beakers in which the sediment and water concentrations have been stabilised. Chironomid emergence and development rate is measured at the end of the test. Larval survival and weight may also be measured after 10 days if required (using additional replicates as appropriate). These data are analysed either by using a regression model in order to estimate the concentration that would cause \times % reduction in emergence or larval survival or growth (e.g. EC₁₅, EC₅₀ etc.), or by using statistical hypothesis testing to determine a NOEC/LOEC. The latter requires comparison of effect values with control values using statistical tests.

INFORMATION ON THE TEST SUBSTANCE

8. The water solubility of the test substance, its vapour pressure, measured or calculated partitioning into sediment and stability in water and sediment should be known. A reliable analytical method for the quantification of the test substance in overlying water, pore water and sediment with known and reported accuracy and limit of detection should be available. Useful information includes the structural formula and purity of the test substance. Chemical fate of the test substance (e.g. dissipation, abiotic and biotic degradation, etc.) also is useful information. Further guidance for testing substances with physical-chemical properties that make them difficult to perform the test is provided in (12)

REFERENCE CHEMICALS

9. Reference chemicals may be tested periodically as a means of assuring that the test protocol and test conditions are reliable. Examples of reference toxicants used successfully in ring-tests and validation studies are: lindane, trifluralin, pentachlorophenol, cadmium chloride and potassium chloride (1)(2)(5)(6)(13).

VALIDITY OF THE TEST

10. For the test to be valid the following conditions apply:
 - the emergence in the controls must be at least 70 % at the end of the test. (1)(6);
 - *C. riparius* and *C. yoshimatsui* emergence to adults from control vessels should occur between 12 and 23 days after their insertion into the vessels; for *C. tentans*, a period of 20 to 65 days is necessary.
 - at the end of the test, pH and the dissolved oxygen concentration should be measured in each vessel. The oxygen concentration should be at least 60 per cent of the air saturation value (ASV) at the temperature used, and the pH of overlying water should be in the 6-9 range in all test vessels;
 - the water temperature should not differ by more than $\pm 1,0$ °C. The water temperature could be controlled by isothermal room and in that case the room temperature should be confirmed in an appropriate time interval.

▼ **M4****DESCRIPTION OF THE METHOD****Test vessels**

11. The study is conducted in glass 600 ml beakers measuring 8 cm in diameter. Other vessels are suitable, but they should guarantee a suitable depth of overlying water and sediment. The sediment surface should be sufficient to provide 2 to 3 cm² per larvae. The ratio of the depth of the sediment layer to the depth of the overlying water should be 1:4. Test vessels and other apparatus that will come into contact with the test system should be made entirely of glass or other chemically inert material (e.g. Teflon).

Selection of species

12. The species to be used in the test is preferably *Chironomus riparius*. *Chironomus tentans* is also suitable but more difficult to handle and requires a longer test period. *Chironomus yohimatsui* may also be used. Details of culture methods are given in Appendix 2 for *Chironomus riparius*. Information on culture conditions is also available for other species, i.e. *Chironomus tentans* (4) and *Chironomus yohimatsui* (11). Identification of species must be confirmed before testing but is not required prior to every test if organisms come from an in-house culture.

Sediment

13. Formulated sediment (also called reconstituted, artificial or synthetic sediment) should preferably be used. However, if natural sediment is used, it should be characterised (at least pH, organic carbon content, determination of other parameters such as C/N ratio and granulometry are also recommended), and it should be free from any contamination and other organisms that might compete with, or consume the chironomids. It is also recommended that, before it is used in a chironomid toxicity test, the natural sediment be conditioned for seven days under the same conditions which prevail in the subsequent test. The following formulated sediment, based on the artificial soil used in Test Method C.8 (14), is recommended for use in this test (1)(15)(16):
 - (a) 4-5 % (dry weight) peat: as close to pH 5,5 to 6,0 as possible; it is important to use peat in powder form, finely ground (particle size ≤ 1 mm) and only air dried.
 - (b) 20 % (dry weight) kaolin clay (kaolinite content preferably above 30 %).
 - (c) 75-76 % (dry weight) quartz sand (fine sand should predominate with more than 50 per cent of the particles between 50 and 200 µm).
 - (d) Deionised water is added to obtain moisture content of the final mixture in a range of 30-50 %.
 - (e) Calcium carbonate of chemically pure quality (CaCO₃) is added to adjust the pH of the final mixture of the sediment to 7,0 ± 0,5. Organic carbon content of the final mixture should be 2 % (± 0,5 %) and is to be adjusted by the use of appropriate amounts of peat and sand, according to (a) and (c).
14. The source of peat, kaolin clay and sand should be known. The sediment components should be checked for the absence of chemical contamination (e.g. heavy metals, organochlorine compounds, organophosphorous compounds, etc.). An example for the preparation of the formulated sediment is described in Appendix 3. Mixing of dry constituents is also acceptable if it is demonstrated that after addition of overlying water a separation of sediment constituents (e.g. floating of peat particles) does not occur, and that the peat or the sediment is sufficiently conditioned.

▼ M4**Water**

15. Any water which conforms to the chemical characteristics of acceptable dilution water as listed in Appendices 2 and 4 is suitable as test water. Any suitable water, natural water (surface or ground water), reconstituted water (see Appendix 2) or dechlorinated tap water are acceptable as culturing water and test water if chironomids will survive in it for the duration of the culturing and testing without showing signs of stress. At the start of the test, the pH of the test water should be between 6 and 9 and the total hardness not higher than 400 mg/l as CaCO₃. However, if there is an interaction suspected between hardness ions and the test substance, lower hardness water should be used (and thus, Elendt Medium M4 must not be used in this situation). The same type of water should be used throughout the whole study. The water quality characteristics listed in Appendix 4 should be measured at least twice a year or when it is suspected that these characteristics may have changed significantly.

Stock solutions — Spiked sediments

16. Spiked sediments of the chosen concentration are usually prepared by addition of a solution of the test substance directly to the sediment. A stock solution of the test substance dissolved in deionised water is mixed with the formulated sediment by rolling mill, feed mixer or hand mixing. If poorly soluble in water, the test substance can be dissolved in as small a volume as possible of a suitable organic solvent (e.g. hexane, acetone or chloroform). This solution is then mixed with 10 g of fine quartz sand for one test vessel. The solvent is allowed to evaporate and it has to be totally removed from sand; the sand is then mixed with the suitable amount of sediment per test beaker. Only agents which volatilise readily can be used to solubilise, disperse or emulsify the test substance. It should be born in mind that the sand provided by the test substance and sand mixture, has to be taken into account when preparing the sediment (i.e. the sediment should thus be prepared with less sand). Care should be taken to ensure that the test substance added to sediment is thoroughly and evenly distributed within the sediment. If necessary, subsamples can be analysed to determine degree of homogeneity.

TEST DESIGN

17. The test design relates to the selection of the number and spacing of the test concentrations, the number of vessels at each concentration and the number of larvae per vessel. Designs for EC point estimation, for estimation of NOEC, and for conducting a limit test are described.

Design for analysis by regression

18. The effect concentration (e.g. EC₁₅, EC₅₀) and the concentration range, over which the effect of the test substance is of interest, should be spanned by the concentrations included in the test. Generally, the accuracy and especially validity, with which estimates of effect concentrations (EC_x) can be made, is improved when the effect concentration is within the range of concentrations tested. Extrapolating much below the lowest positive concentration or above the highest concentration should be avoided. A preliminary range-finding test is helpful for selecting the range of concentrations to be used (see paragraph 27).

▼M4

19. If the EC_x is to be estimated, at least five concentrations and three replicates for each concentration should be tested. In any case, it is advisable that sufficient test concentrations are used to allow good model estimation. The factor between concentrations should not be greater than two (an exception could be made in cases when the dose response curve has a shallow slope). The number of replicates at each treatment can be reduced if the number of test concentrations with different responses is increased. Increasing the number of replicates or reducing the size of the test concentration intervals tends to lead to narrower confidence intervals for the test. Additional replicates are required if 10-day larval survival and growth are to be estimated.

Design for estimation of a NOEC/LOEC

20. If the LOEC or NOEC are to be estimated, five test concentrations with at least four replicates should be used and the factor between concentrations should not be greater than two. The number of replicates should be sufficient to ensure adequate statistical power to detect a 20 % difference from the control at the 5 % level of significance ($p = 0,05$). With the development rate, an Analysis of Variance (ANOVA) is usually appropriate, such as Dunnett-test and Williams-test (17)(18)(19)(20). In the emergence ratio the Cochran-Armitage, Fisher's exact (with Bonferroni correction), or Mantel-Haenszel tests may be used.

Limit test

21. A limit test may be performed (one test concentration and control) if no effects were seen in the preliminary range-finding test. The purpose of the limit test is to perform a test at a concentration sufficiently high to enable decision makers to exclude possible toxic effects of the test substance, and the limit is set at a concentration which is not expected to appear in any situation. 1 000 mg/kg (dry weight) is recommended. Usually, at least six replicates for both the treatment and control are necessary. Adequate statistical power to detect a 20 % difference from the control at the 5 % level of significance ($p = 0,05$) should be demonstrated. With metric response (development rate and weight), the t-test is a suitable statistical method if data meet the requirements of this test (normality, homogeneous variances). The unequal-variance t-test or a non parametric test, such as the Wilcoxon-Mann-Whitney test may be used, if these requirements are not fulfilled. With the emergence ratio, the Fisher exact test is appropriate.

PROCEDURE**Conditions of exposure***Preparation of spiked sediment — water system*

22. The spiking procedure described in Test Method C.8: Toxicity for Earthworms is recommended for application of the test substance (14). The spiked sediments are placed in the vessels and overlying water is added to produce a sediment-water volume ratio of 1:4 (see paragraphs 11 and 15). The depth of the sediment layer should be in the range of 1,5-3 cm. To avoid separation of sediment ingredients and re-suspension of fine material during addition of test water in the water column, the sediment can be covered with a plastic disc while water is poured onto it, and the disc removed immediately afterwards. Other devices may also be appropriate.
23. The test vessels should be covered (e.g. by glass plates). If necessary, during the study the water levels will be topped to the original volume in order to compensate for water evaporation. This should be performed using distilled or deionised water to prevent build-up of salts.

▼ M4*Stabilisation*

24. Once the spiked sediment with overlying water has been prepared, it is desirable to allow partitioning of the test substance from the aqueous phase to the sediment (3)(4)(6)(13). This should preferably be done under the conditions of temperature and aeration used in the test. Appropriate equilibration time is sediment and chemical specific, and can be in the order of hours to days and in rare cases up to several weeks (4-5 weeks). As this would leave time for degradation of many chemicals, equilibrium is not awaited but an equilibration period of 48 hours is recommended. At the end of this further equilibration period, the concentration of the test substance should be measured in the overlying water, the pore water and the sediment, at least at the highest concentration and a lower one (see paragraph 38). These analytical determinations of the test substance allow for calculation of mass balance and expression of results based on measured concentrations.

Addition of test organisms

25. Four to five days before adding the test organisms to the test vessels, egg masses should be taken from the cultures and placed in small vessels in culture medium. Aged medium from the stock culture or freshly prepared medium may be used. If the latter is used, a small amount of food e.g. green algae and/or a few droplets of filtrate from a finely ground suspension of flaked fish food should be added to the culture medium (see Appendix 2). Only freshly laid egg masses should be used. Normally, the larvae begin to hatch a couple of days after the eggs are laid (2 to 3 days for *Chironomus riparius* at 20 °C and 1 to 4 days for *Chironomus tentans* at 23 °C and *Chironomus yoshimatui* at 25 °C) and larval growth occurs in four instars, each of 4-8 days duration. First instar larvae (2-3 or 1-4 days post hatching) should be used in the test. The instar of midges can possibly be checked using head capsule width (6).
26. Twenty first instar larvae are allocated randomly to each test vessel containing the spiked sediment and water, using a blunt pipette. Aeration of the water has to be stopped while adding the larvae to test vessels and remain so for another 24 hours after addition of larvae (see paragraphs 25 and 32). According to the test design used (see paragraphs 19 and 20), the number of larvae used per concentration is at least 60 for the EC point estimation and 80 for determination of NOEC.

Test concentrations

27. A range-finding test may be helpful to determine the range of concentrations for the definitive test. For this purpose a series of widely spaced concentrations of the test substance are used. In order to provide the same density of surface per chironomids, which is to be used for the definitive test, chironomids are exposed to each concentration of the test substance for a period which allows estimation of appropriate test concentrations, and no replicates are required.
28. The test concentrations for the definitive test are decided based on the result of the range-finding test. At least five concentrations should be used and selected as described in paragraphs 18 to 20.

▼ M4*Controls*

29. Control vessels without any test substance but including sediment should be included in the test with the appropriate number of replicates (see paragraphs 19-20). If a solvent has been used for application of test substance (see paragraph 16), a sediment solvent control should be added.

Test system

30. Static systems are used. Semi-static or flow-through systems with intermittent or continuous renewal of overlying water might be used in exceptional cases as for instance if water quality specifications become inappropriate for the test organism or affect chemical equilibrium (e.g. dissolved oxygen levels fall too low, the concentration of excretory products rises too high or minerals leach from sediment and affect pH and/or water hardness). However, other methods for ameliorating the quality of overlying water, such as aeration, will normally suffice and be preferable.

Food

31. It is necessary to feed the larvae, preferably daily or at least three times per week. Fish-food (a suspension in water or finely ground food, e.g. TetraMin or TetraPhyll; see details in Appendix 2) in the amount of 0,25-0,5 mg (0,35-0,5 mg for *C. yoshimatui*) per larvae per day seems adequate for young larvae for the first 10 days. Slightly more food may be necessary for older larvae: 0,5-1 mg per larvae per day should be sufficient for the rest of the test. The food ration should be reduced in all treatments and control if fungal growth is seen or if mortality is observed in controls. If fungal development cannot be stopped the test is to be repeated. When testing strongly adsorbing substances (e.g. with $\log K_{ow} > 5$), or substances covalently binding to sediment, the amount of food necessary to ensure survival and natural growth of the organisms may be added to the formulated sediment before the stabilisation period. For this, plant material must be used instead of fish food, e.g. addition of 0,5 % (dry weight) finely ground leaves of e.g. stinging nettle (*Urtica dioica*), mulberry (*Morus alba*), white clover (*Trifolium repens*), spinach (*Spinacia oleracea*) or of other plant material (*Cerophyl* or alpha-cellulose) may be used.

Incubation conditions

32. Gentle aeration of the overlying water in test vessels is supplied preferably 24 hours after addition of the larvae and is pursued throughout the test (care should be taken that dissolved oxygen concentration does not fall below 60 per cent of ASV). Aeration is provided through a glass Pasteur pipette fixed 2-3 cm above the sediment layer (i.e. one or few bubbles/sec). When testing volatile chemicals, consideration may be given not to aerate the sediment-water system.
33. The test is conducted at a constant temperature of 20 °C (± 2 °C). For *C. tentans* and *C. yoshimatui* recommended temperatures are 23 °C and 25 °C (± 2 °C), respectively. A 16 hours photoperiod is used and the light intensity should be 500 to 1 000 lux.

▼ M4*Exposure duration*

34. The exposure commences with the addition of larvae to the spiked and control vessels. The maximum exposure duration is 28 days for *C. riparius* and *C. yoshimatsui*, and 65 days for *C. tentans*. If midges emerge earlier, the test can be terminated after a minimum of five days after emergence of the last adult in the control.

Observations*Emergence*

35. The development time and the total number of fully emerged male and female midges are determined. Males are easily identified by their plumose antennae.

36. The test vessels should be observed at least three times per week to make visual assessment of any abnormal behaviour (e.g. leaving sediment, unusual swimming), compared with the control. During the period of expected emergence a daily count of emerged midges is necessary. The sex and number of fully emerged midges are recorded daily. After identification the midges are removed from the vessels. Any egg masses deposited prior to the termination of the test should be recorded and then removed to prevent re-introduction of larvae into the sediment. The number of visible pupae that have failed to emerge is also recorded. Guidance on measurement of emergence is provided in Appendix 5.

Growth and survival

37. If data on 10-day larval survival and growth are to be provided, additional test vessels should be included at the start, so that they may be used subsequently. The sediment from these additional vessels is sieved using a 250 µm sieve to retain the larvae. Criteria for death are immobility or lack of reaction to a mechanical stimulus. Larvae not recovered should also be counted as dead (larvae which have died at beginning of the test may have been degraded by microbes). The (ash free) dry weight of the surviving larvae per test vessel is determined and the mean individual dry weight per vessel calculated. It is useful to determine which instar the surviving larvae belong to; for that measurement of the width of the head capsule of each individual can be used.

Analytical measurements*Concentration of the test substance*

38. Prior to test commencement (i.e. addition of larvae), samples of bulk sediment are removed from at least one vessel per treatment for the analytical determination of the test substance concentration in the sediment. It is recommended that, as a minimum, samples of the overlying water, the pore water and the sediment be analysed at the start (see paragraph 24) and at the end of the test, at the highest concentration and a lower one. These determinations of test substance concentration inform about the behaviour/partitioning of the test substance in the water-sediment system.

39. When intermediate measurements are made (e.g. at day 7) and if the analysis needs large samples which cannot be taken from test vessels without influencing the test system, analytical determinations should be performed on samples from additional test vessels treated in the same way (including the presence of test organisms) but not used for biological observations.

▼M4

40. Centrifugation at e.g. 10 000 g and 4 °C for 30 min. is the recommended procedure to isolate interstitial water. However, if the test substance is demonstrated not to adsorb to filters, filtration may also be acceptable. In some cases it might not be possible to analyse concentrations in the pore water as the sample size is too small.

Physical-chemical parameters

41. pH and temperature of the test vessels should be measured in an appropriate manner (see paragraph 10). Hardness and ammonia should be measured in the controls and one test vessel at the highest concentration at the start and the end of the test.

DATA AND REPORTING

Treatment of results

42. The purpose of this test is to determine the effect of the test substance on the development rate and the total number of fully emerged male and female midges, or in the case of the 10-day test effects on survival and weight of the larvae. If there are no indications of statistically different sensitivities of sexes, male and female results may be pooled for statistical analyses. The sensitivity differences between sexes can be statistically judged by e.g. a χ^2 -r \times 2 table test. Larval survival and mean individual dry weight per vessel must be determined after 10 days where required.
43. Effect concentrations expressed and based on dry weight, are calculated preferably based on measured sediment concentrations at the beginning of the test (see paragraph 38).
44. To compute a point estimate for the EC₅₀ or any other EC_x, the per-vessel statistics may be used as true replicates. In calculating a confidence interval for any EC_x the variability among vessels should be taken into account, or it should be shown that this variability is so small that it can be ignored. When the model is fitted by Least Squares, a transformation should be applied to the per-vessel statistics in order to improve the homogeneity of variance. However, EC_x values should be calculated after the response is transformed back to the original value.
45. When the statistical analysis aims at determining the NOEC/LOEC by hypothesis testing, the variability among vessels needs to be taken into account, e.g. by a nested ANOVA. Alternatively, more robust tests (21) can be appropriate in situations where there are violations of the usual ANOVA assumptions.

Emergence ratio

46. Emergence ratios are quantal data, and can be analyzed by the Cochran-Armitage test applied in step-down manner where a monotonic dose-response is expected and these data are consistent with this expectation. If not, a Fisher's exact or Mantel-Haenszel test with Bonferroni-Holm adjusted p-values can be used. If there is evidence of greater variability between replicates within the same concentration than a binomial distribution would indicate (often referenced as 'extra-binomial' variation), then a robust Cochran-Armitage or Fisher exact test such as proposed in (21), should be used.

▼ **M4**

The sum of midges emerged per vessel, n_e , is determined and divided by the number of larvae introduced, n_a :

$$ER = \frac{n_e}{n_a}$$

where:

ER = emergence ratio

n_e = number of midges emerged per vessel

n_a = number of larvae introduced per vessel

47. An alternative that is most appropriate for large sample sizes, when there is extra binomial variance, is to treat the emergence ratio as a continuous response and use procedures such as William's test when a monotonic dose-response is expected and is consistent with these ER data. Dunnett's test would be appropriate where monotonicity does not hold. A large sample size is defined here as the number emerged and the number not emerging both exceeding five, on a per replicate (vessel) basis.
48. To apply ANOVA methods values of ER should first be transformed by the arcsin-sqrt-transformation or Freeman-Tukey transformation to obtain an approximate normal distribution and to equalise variances. The Cochran-Armitage, Fisher's exact (Bonferroni), or Mantel-Haenszel tests can be applied when using the absolute frequencies. The arcsin-sqrt transformation is applied by taking the inverse sine (\sin^{-1}) of the square root of ER.
49. For emergence ratios, EC_x -values are calculated using regression analysis (or e.g. probit (22), logit, Weibull, appropriate commercial software etc.). If regression analysis fails (e.g. when there are less than two partial responses), other non-parametric methods such as moving average or simple interpolation are used.

Development rate

50. The mean development time represents the mean time span between the introduction of larvae (day 0 of the test) and the emergence of the experimental cohort of midges. (For the calculation of the true development time, the age of larvae at the time of introduction should be considered). The development rate is the reciprocal of the development time (unit: 1/day) and represents that portion of larval development which takes place per day. The development rate is preferred for the evaluation of these sediment toxicity studies as its variance is lower, and it is more homogeneous and closer to normal distribution as compared to development time. Hence, powerful parametric test procedures may be used with development rate rather than with development time. For development rate as a continuous response, EC_x -values can be estimated by using regression analysis (e.g. (23), (24)).
51. For the following statistical tests, the number of midges observed on inspection day x are assumed to be emerged at the mean of the time interval between day x and day $x - 1$ (l = length of the inspection interval, usually 1 day). The mean development rate per vessel (\bar{x}) is calculated according to:

$$\bar{x} = \sum_{i=1}^m \frac{f_i x_i}{n_e}$$

▼ M4

where:

\bar{x} : mean development rate per vessel

i : index of inspection interval

m : maximum number of inspection intervals

f_i : number of midges emerged in the inspection interval i

n_c : total number of midges emerged at the end of experiment ($= \sum f_i$)

x_i : development rate of the midges emerged in interval i

$$x_i = \frac{1}{\left(\text{day}_i - \frac{l_i}{2}\right)}$$

where:

day_i : inspection day (days since application)

l_i : length of inspection interval i (days, usually 1 day)

Test report

52. The test report must at least provide the following information:

Test substance:

- physical nature and, where relevant, physical-chemical properties (water solubility, vapour pressure, partition coefficient in soil (or in sediment if available), stability in water, etc.);
- chemical identification data (common name, chemical name, structural formula, CAS number, etc.) including purity and analytical method for quantification of test substance.

Test species:

- test animals used: species, scientific name, source of organisms and breeding conditions;
- information on handling of egg masses and larvae;
- age of test animals when inserted into test vessels.

Test conditions:

- sediment used, i.e. natural or formulated sediment;
- for natural sediment, location and description of sediment sampling site, including, if possible, contamination history; characteristics: pH, organic carbon content, C/N ratio and granulometry (if appropriate).
- preparation of the formulated sediment: ingredients and characteristics (organic carbon content, pH, moisture, etc. at the start of the test);
- preparation of the test water (if reconstituted water is used) and characteristics (oxygen concentration, pH, conductivity, hardness, etc. at the start of the test);
- depth of sediment and overlying water;
- volume of overlying and pore water; weight of wet sediment with and without pore water;

▼ M4

- test vessels (material and size);
- method of spiking sediment: test concentrations used, number of replicates and use of solvent if any;
- stabilisation equilibrium phase of the spiked sediment-water system: duration and conditions;
- incubation conditions: temperature, light cycle and intensity, aeration (frequency and intensity);
- detailed information on feeding including type of food, preparation, amount and feeding regime.

Results:

- the nominal test concentrations, the measured test concentrations and the results of all analyses to determine the concentration of the test substance in the test vessel;
- water quality within the test vessels, i.e. pH, temperature, dissolved oxygen, hardness and ammonia;
- replacement of evaporated test water, if any;
- number of emerged male and female midges per vessel and per day;
- number of larvae which failed to emerge as midges per vessel;
- mean individual dry weight of larvae per vessel, and per instar, if appropriate;
- percent emergence per replicate and test concentration (male and female midges pooled);
- mean development rate of fully emerged midges per replicate and treatment rate (male and female midges pooled);
- estimates of toxic endpoints e.g. EC_x (and associated confidence intervals), NOEC and/or LOEC, and the statistical methods used for their determination;
- discussion of the results, including any influence on the outcome of the test resulting from deviations from this Test Method.

LITERATURE:

- (1) BBA (1995). Long-term toxicity test with *Chironomus riparius*: Development and validation of a new test system. Edited by M. Streloke and H.Köpp. Berlin 1995.
- (2) Fleming R *et al.* (1994). Sediment Toxicity Tests for Poorly Water-Soluble Substances. Final Report to them European Commission. Report No: EC 3738. August 1994. WRc, UK.
- (3) SETAC (1993). Guidance Document on Sediment toxicity Tests and Bioassays for Freshwater and Marine Environments. From the WOSTA Workshop held in the Netherlands.
- (4) ASTM International/E1706-00 (2002). Test Method for Measuring the Toxicity of Sediment-Associated Contaminants with Freshwater Invertebrates. pp 1125-1241. In ASTM International 2002 Annual Book of Standards. Volume 11.05. Biological Effects and Environmental Fate;Biotechnology; Pesticides. ASTM. International, West Conshohocken, PA.
- (5) Environment Canada (1997). Test for Growth and Survival in Sediment using Larvae of Freshwater Midges (*Chironomus tentans* or *Chironomus riparius*). Biological Test Method. Report SPE 1/RM/32. December 1997.

▼ **M4**

- (6) US-EPA (2000). Methods for Measuring the Toxicity and Bioaccumulation of Sediment-associated Contaminants with Freshwater Invertebrates. Second edition. EPA 600/R-99/064. March 2000. Revision to the first edition dated June 1994.
- (7) US-EPA/OPPTS 850.1735. (1996): Whole Sediment Acute Toxicity Invertebrates.
- (8) US-EPA/OPPTS 850.1790. (1996): Chironomid Sediment toxicity Test.
- (9) Milani D, Day KE, McLeay DJ, and Kirby RS (1996). Recent intra- and inter-laboratory studies related to the development and standardisation of Environment Canada's biological test methods for measuring sediment toxicity using freshwater amphipods (*Hyalella azteca*) and midge larvae (*Chironomus riparius*). Technical Report. Environment Canada. National Water Research Institute. Burlington, Ontario, Canada.
- (10) Sugaya Y (1997). Intra-specific variations of the susceptibility of insecticides in *Chironomus yoshimatsui*. Jp. J. Sanit. Zool. 48 (4): 345-350.
- (11) Kawai K (1986). Fundamental studies on Chironomid allergy. I. Culture methods of some Japanese Chironomids (Chironomidae, Diptera). Jp. J. Sanit. Zool. 37(1): 47-57.
- (12) OECD (2000). Guidance Document on Aquatic Toxicity Testing of Difficult Substances and Mixtures. OECD Environment, Health and Safety Publications, Series on Testing and Assessment No 23.
- (13) Environment Canada (1995). Guidance Document on Measurement of Toxicity Test Precision Using Control Sediments Spiked with a Reference Toxicant. Report EPS 1/RM/30. September 1995.
- (14) Test Method C.8 of this Annex, Toxicity for Earthworms.
- (15) Suedel BC and JH Rodgers (1994). Development of formulated reference sediments for freshwater and estuarine sediment testing. Environ. Toxicol. Chem. 13: 1163-1175.
- (16) Naylor C and C Rodrigues (1995). Development of a test method for *Chironomus riparius* using a formulated sediment. Chemosphere 31: 3291-3303.
- (17) Dunnett CW (1964). A multiple comparisons procedure for comparing several treatments with a control. J. Amer. Statis. Assoc., 50: 1096-1121.
- (18) Dunnett CW (1964). New tables for multiple comparisons with a control. Biometrics, 20: 482-491.
- (19) Williams DA (1971). A test for differences between treatment means when several dose levels are compared with a zero dose control. Biometrics, 27: 103-117.
- (20) Williams DA (1972). The comparison of several dose levels with a zero dose control. Biometrics, 28: 510-531.
- (21) Rao JNK and Scott AJ (1992). A simple method for the analysis of clustered binary data. Biometrics 48: 577-585.
- (22) Christensen ER (1984). Dose-response functions in aquatic toxicity testing and the Weibull model. Water Research 18: 213-221.
- (23) Bruce and Versteeg (1992). A statistical procedure for modelling continuous toxicity data. Environmental Toxicology and Chemistry 11: 1485-1494.
- (24) Slob W (2002). Dose-response modelling of continuous endpoints. Toxicol. Sci. 66: 298-312.

▼M4*Appendix 1*

DEFINITIONS

For the purpose of this Test Method the following definitions are used:

Formulated sediment or reconstituted, artificial or synthetic sediment, is a mixture of materials used to mimic the physical components of a natural sediment.

Overlying water is the water placed over sediment in the test vessel.

Interstitial water or pore water is the water occupying space between sediment and soil particles.

Spiked sediment is sediment to which test substance has been added.

Test chemical: Any substance or mixture tested using this Test Method.

▼ M4*Appendix 2***Recommendations for culture of *Chironomus riparius***

1. *Chironomus* larvae may be reared in crystallising dishes or larger containers. Fine quartz sand is spread in a thin layer of about 5 to 10 mm deep over the bottom of the container. Kieselguhr (e.g. Merck, Art 8117) has also been shown to be a suitable substrate (a thinner layer of up to a very few mm is sufficient). Suitable water is then added to a depth of several cm. Water levels should be topped up as necessary to replace evaporative loss, and prevent desiccation. Water can be replaced if necessary. Gentle aeration should be provided. The larval rearing vessels should be held in a suitable cage which will prevent escape of the emerging adults. The cage should be sufficiently large to allow swarming of emerged adults, otherwise copulation may not occur (minimum is ca. 30 × 30 × 30 cm).
2. Cages should be held at room temperature or in a constant environment room at 20 ± 2 °C with a photo period of 16 hour light (intensity ca. 1 000 lux), 8 hours dark. It has been reported that air humidity of less than 60 % RH can impede reproduction.

Dilution water

3. Any suitable natural or synthetic water may be used. Well water, dechlorinated tap water and artificial media (e.g. Elendt 'M4' or 'M7' medium, see below) are commonly used. The water has to be aerated before use. If necessary, the culture water may be renewed by pouring or siphoning the used water from culture vessels carefully without destroying the tubes of larvae.

Feeding larvae

4. *Chironomus* larvae should be fed with a fish flake food (TetraMin® TetraPhyll® or other similar brand of proprietary fish food), at approximately 250 mg per vessel per day. This can be given as a dry ground powder or as a suspension in water: 1,0 g of flake food is added to 20 ml of dilution water and blended to give a homogenous mix. This preparation may be fed at a rate of about 5 ml per vessel per day (shake before use). Older larvae may receive more.
5. Feeding is adjusted according to the water quality. If the culture medium becomes 'cloudy', the feeding should be reduced. Food additions must be carefully monitored. Too little food will cause emigration of the larvae towards the water column, and too much food will cause increased microbial activity and reduced oxygen concentrations. Both conditions can result in reduced growth rates.
6. Some green algae (e.g. *Scenedesmus subspicatus*, *Chlorella vulgaris*) cells may also be added when new culture vessels are set up.

Feeding emerged adults

7. Some experimenters have suggested that a cotton wool pad soaked in a saturated sucrose solution may serve as a food for emerged adults.

▼ M4**Emergence**

8. At 20 ± 2 °C adults will begin to emerge from the larval rearing vessels after approximately 13-15 days. Males are easily distinguished by having plumose antennae.

Egg masses

9. Once adults are present within the breeding cage, all larval rearing vessels should be checked three times weekly for deposition of the gelatinous egg masses. If present, the egg masses should be carefully removed. They should be transferred to a small dish containing a sample of the breeding water. Egg masses are used to start a new culture vessel (e.g. 2-4 egg masses/vessel) or are used for toxicity tests.

10. First instar larvae should hatch after 2-3 days.

Set-up of new culture vessels

11. Once cultures are established it should be possible to set up a fresh larval culture vessel weekly or less frequently depending on testing requirements, removing the older vessels after adult midges have emerged. Using this system a regular supply of adults will be produced with a minimum of management.

Preparation of test solutions 'M4' and 'M7'

12. Elendt (1990) has described the 'M4' medium. The 'M7' medium is prepared as the 'M4' medium except for the substances indicated in Table 1, for which concentrations are four times lower in 'M7' than in 'M4'. A publication on the 'M7' medium is in preparation (Elendt, personal communication). The test solution should not be prepared according to Elendt and Bias (1990) for the concentrations of $\text{NaSiO}_3 \cdot 5 \text{H}_2\text{O}$, NaNO_3 , KH_2PO_4 and K_2HPO_4 given for the preparation of the stock solutions are not adequate.

Preparation of the 'M7'-medium

13. Each stock solution (I) is prepared individually and a combined stock solution (II) is prepared from these stock solutions (I) (see Table 1). Fifty ml from the combined stock solution (II) and the amounts of each macro nutrient stock solution which are given in Table 2 are made up to 1 litre of deionised water to prepare the 'M7' medium. A vitamin stock solution is prepared by adding three vitamins to deionised water as indicated in Table 3, and 0,1 ml of the combined vitamin stock solution are added to the final 'M7' medium shortly before use. (The vitamin stock solution is stored frozen in small aliquots). The medium is aerated and stabilised.

LITERATURE:

BBA (1995). Long-term toxicity test with *Chironomus riparius*: Development and validation of a new test system. Edited by M. Strelöke and H. Köpp. Berlin 1995.

▼ **M4**

Table 1

Stock solutions of trace elements for medium M4 and M7

Stock solutions (I)	Amount (mg) made up to 1 litre of deionised water	To prepare the combined stock solution (II): mix the following amounts (ml) of stock solutions (I) and make up to 1 litre of deionised water		Final concentrations in test solutions (mg/l)	
		M4	M7	M4	M7
H ₃ BO ₃ ⁽¹⁾	57 190	1,0	0,25	2,86	0,715
MnCl ₂ · 4 H ₂ O ⁽¹⁾	7 210	1,0	0,25	0,361	0,090
LiCl ⁽¹⁾	6 120	1,0	0,25	0,306	0,077
RbCl ⁽¹⁾	1 420	1,0	0,25	0,071	0,018
SrCl ₂ · 6 H ₂ O ⁽¹⁾	3 040	1,0	0,25	0,152	0,038
NaBr ⁽¹⁾	320	1,0	0,25	0,016	0,004
Na ₂ MoO ₄ · 2 H ₂ O ⁽¹⁾	1 260	1,0	0,25	0,063	0,016
CuCl ₂ · 2 H ₂ O ⁽¹⁾	335	1,0	0,25	0,017	0,004
ZnCl ₂	260	1,0	1,0	0,013	0,013
CaCl ₂ · 6 H ₂ O	200	1,0	1,0	0,010	0,010
KI	65	1,0	1,0	0,0033	0,0033
Na ₂ SeO ₃	43,8	1,0	1,0	0,0022	0,0022
NH ₄ VO ₃	11,5	1,0	1,0	0,00058	0,00058
Na ₂ EDTA · 2 H ₂ O ⁽¹⁾ ⁽²⁾	5 000	20,0	5,0	2,5	0,625
FeSO ₄ · 7 H ₂ O ⁽¹⁾ ⁽²⁾	1 991	20,0	5,0	1,0	0,249

⁽¹⁾ These substances differ in M4 and M7, as indicated above.

⁽²⁾ These solutions are prepared individually, then poured together and autoclaved immediately.

Table 2

Macro nutrient stock solutions for medium M4 and M7

	Amount made up to 1 litre of deionised water (mg)	Amount of macro nutrient stock solutions added to prepare medium M4 and M7 (ml/l)	Final concentrations in test solutions M4 and M7 (mg/l)
CaCl ₂ · 2 H ₂ O	293 800	1,0	293,8
MgSO ₄ · 7 H ₂ O	246 600	0,5	123,3
KCl	58 000	0,1	5,8
NaHCO ₃	64 800	1,0	64,8
NaSiO ₃ · 9 H ₂ O	50 000	0,2	10,0
NaNO ₃	2 740	0,1	0,274
KH ₂ PO ₄	1 430	0,1	0,143
K ₂ HPO ₄	1 840	0,1	0,184

▼ **M4**

Table 3

Vitamin stock solution for medium M4 and M7. All three vitamin solutions are combined to make a single vitamin stock solution

	Amount made up to 1 litre of deionised water (mg)	Amount of vitamin stock solution added to prepare medium M4 and M7 (ml/l)	Final concentrations in test solutions M4 and M7 (mg/l)
Thiamine hydrochloride	750	0,1	0,075
Cyanocobalamin (B12)	10	0,1	0,0010
Biotine	7,5	0,1	0,00075

LITERATURE:

Elendt, B.P. (1990). Selenium Deficiency in Crustacean. *Protoplasma* 154: 25-33.

Elendt, B.P. & W.-R. Bias (1990). Trace Nutrient Deficiency in *Daphnia magna* Cultured in Standard Medium for Toxicity Testing. Effects on the Optimization of Culture Conditions on Life History Parameters of *D. magna*. *Water Research* 24 (9): 1157-1167.

▼ **M4***Appendix 3***PREPARATION OF FORMULATED SEDIMENT****Sediment composition**

The composition of the formulated sediment should be as follows:

Constituent	Characteristics	% of sediment dry weight
Peat	Sphagnum moss peat, as close to pH 5,5-6,0 as possible, no visible plant remains, finely ground (particle size \leq 1 mm) and air dried	4 - 5
Quartz sand	Grain size: > 50 % of the particles should be in the range of 50-200 μ m	75 - 76
Kaolinite clay	Kaolinite content \geq 30 %	20
Organic carbon	Adjusted by addition of peat and sand	2 (\pm 0,5)
Calcium carbonate	CaCO ₃ , pulverised, chemically pure	0,05 - 0,1
Water	Conductivity \leq 10 μ S/cm	30 - 50

Preparation

The peat is air dried and ground to a fine powder. A suspension of the required amount of peat powder in deionised water is prepared using a high-performance homogenising device. The pH of this suspension is adjusted to $5,5 \pm 0,5$ with CaCO₃. The suspension is conditioned for at least two days with gentle stirring at 20 ± 2 °C, to stabilise pH and establish a stable microbial component. pH is measured again and should be $6,0 \pm 0,5$. Then the peat suspension is mixed with the other constituents (sand and kaolin clay) and deionised water to obtain a homogeneous sediment with a water content in a range of 30-50 per cent of dry weight of the sediment. The pH of the final mixture is measured once again and is adjusted to 6,5 to 7,5 with CaCO₃ if necessary. Samples of the sediment are taken to determine the dry weight and the organic carbon content. Then, before it is used in the chironomid toxicity test, it is recommended that the formulated sediment be conditioned for seven days under the same conditions which prevail in the subsequent test.

Storage

The dry constituents for preparation of the artificial sediment may be stored in a dry and cool place at room temperature. The formulated (wet) sediment should not be stored prior to its use in the test. It should be used immediately after the 7 days conditioning period that ends its preparation.

LITERATURE:

Chapter C.8 of this Annex. Toxicity for Earthworms.

Meller M, Egeler P, Rombke J, Schallnass H, Nagel R, Streit B (1998). Short-term Toxicity of Lindane, Hexachlorobenzene and Copper Sulfate on Tubificid Sludgeworms (Oligochaeta) in Artificial Media. *Ecotox. and Environ. Safety* 39: 10-20.

▼ M4*Appendix 4***Chemical Characteristics of an Acceptable Dilution Water**

Substance	Concentrations
Particulate matter	< 20 mg/l
Total organic carbon	< 2 mg/l
Unionised ammonia	< 1 µg/l
Hardness as CaCO ₃	< 400 mg/l (*)
Residual chlorine	< 10 µg/l
Total organophosphorus pesticides	< 50 ng/l
Total organochlorine pesticides plus polychlorinated biphenyls	< 50 ng/l
Total organic chlorine	< 25 ng/l

(*) However, it should be noted that if there is an interaction suspected between hardness ions and the test substance, lower hardness water should be used (and thus, Elendt Medium M4 must not be used in this situation).

▼ **M4***Appendix 5***Guidance for monitoring emergence of chironomid larvae**

Emergence traps are placed on the test beakers. These traps are needed from day 20 to the end of the test. Example of trap used is drawn below:

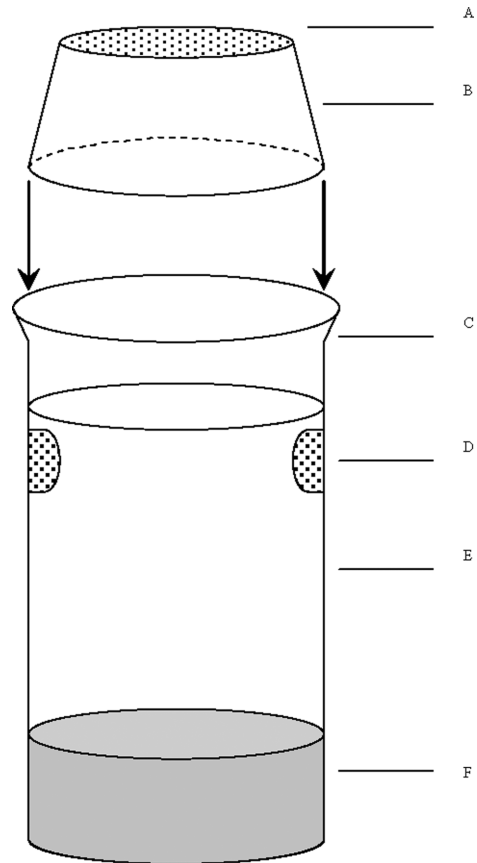

A: the nylon screen

D: the water exchange screen ports

B: the inverted plastic cups

E: water

C: the lipless exposure beaker

F: sediment

▼ M4**C. 28. SEDIMENT-WATER CHIRONOMID TOXICITY TEST USING SPIKED WATER**

INTRODUCTION

1. This Test Method is equivalent to OECD TG 219 (2004). This Test Method is designed to assess the effects of prolonged exposure of chemicals to the sediment-dwelling larvae of the freshwater dipteran *Chironomus* sp. It is mainly based on the BBA guideline using a sediment-water test system with artificial soil, and water column exposure scenario (1). It also takes into account existing toxicity test protocols for *Chironomus riparius* and *Chironomus tentans* which have been developed in Europe and North America (2)(3)(4)(5)(6)(7)(8) and ring-tested (1)(6)(9). Other well documented chironomid species may also be used, e.g. *Chironomus yoshimatsui* (10)(11).
2. The exposure scenario used in this Test Method is water spiking. The selection of the appropriate exposure scenario depends on the intended application of the test. The water exposure scenario, involving spiking of the water column, is intended to simulate a pesticide spray drift event and covers the initial peak of concentrations in pore water. It is also useful for other types of exposure (including chemical spills) except accumulation processes lasting longer than the test period.
3. Substances that need to be tested towards sediment-dwelling organisms usually persist in this compartment over long time periods. The sediment-dwelling organisms may be exposed via a number of routes. The relative importance of each exposure route, and the time taken for each to contribute to the overall toxic effects, is dependent on the physical-chemical properties of the chemical concerned. For strongly adsorbing substances (e.g. with $\log K_{ow} > 5$) or for substances covalently binding to sediment, ingestion of contaminated food may be a significant exposure route. In order not to underestimate the toxicity of highly lipophilic substances, the use of food added to the sediment before application of the test substance may be considered. In order to take all potential routes of exposure into account the focus of this Test Method is on long-term exposure. The test duration is in the range of 20–28 days for *C. riparius* and *C. yoshimatsui*, and 28–65 days for *C. tentans*. If short-term data are required for a specific purpose, for example to investigate the effects of unstable chemicals, additional replicates may be removed after a 10-day period.
4. The measured endpoints are the total number of adults emerged and the time to emergence. It is recommended that measurements of larval survival and growth should only be made after a 10-day period if additional short-term data are required, using additional replicates as appropriate.
5. The use of formulated sediment is recommended. Formulated sediment has several advantages over natural sediments:
 - the experimental variability is reduced because it forms a reproducible ‘standardised matrix’ and the need to find uncontaminated and clean sediment sources is eliminated;
 - the tests can be initiated at any time without encountering seasonal variability in the test sediment and there is no need to pre-treat the sediment to remove indigenous fauna; the use of formulated sediment also reduces the cost associated with the field collection of sufficient amounts of sediment for routine testing;

▼M4

- the use of formulated sediment allows for comparisons of toxicity and ranking substances accordingly: toxicity data from tests with natural and artificial sediments were comparable for several chemicals (2).
6. Definitions used are given in Appendix 1.

PRINCIPLE OF THE TEST

7. First instar chironomid larvae are exposed to a concentration range of the test substance in sediment-water systems. The test starts by placing first instar larvae into the test beakers containing the sediment-water system and subsequently spiking the test substance into the water. Chironomid emergence and development rate is measured at the end of the test. Larval survival and weight may also be measured after 10 days if required (using additional replicates as appropriate). These data are analysed either by using a regression model in order to estimate the concentration that would cause x % reduction in emergence, larvae survival or growth (e.g. EC₁₅, EC₅₀, etc.), or by using statistical hypothesis testing to determine a NOEC/LOEC. The latter requires comparison of effect values with control values using statistical tests.

INFORMATION ON THE TEST SUBSTANCE

8. The water solubility of the test substance, its vapour pressure, measured or calculated partitioning into sediment and stability in water and sediment should be known. A reliable analytical method for the quantification of the test substance in overlying water, pore water and sediment with known and reported accuracy and limit of detection should be available. Useful information includes the structural formula and purity of the test substance. Chemical fate of the test substance (e.g. dissipation, abiotic and biotic degradation, etc.) also is useful information. Further guidance for testing substances with physical-chemical properties that make them difficult to perform the test is provided in (12).

REFERENCE CHEMICALS

9. Reference chemicals may be tested periodically as a means of assuring that the test protocol and test conditions are reliable. Examples of reference toxicants used successfully in ring-tests and validation studies are: lindane, trifluralin, pentachlorophenol, cadmium chloride and potassium chloride. (1)(2)(5)(6)(13).

VALIDITY OF THE TEST

10. For the test to be valid the following conditions apply:
- the emergence in the controls must be at least 70 % at the end of the test. (1)(6);
 - *C. riparius* and *C. yoshimatsui* emergence to adults from control vessels should occur between 12 and 23 days after their insertion into the vessels; for *C. tentans*, a period of 20 to 65 days is necessary.
 - at the end of the test, pH and the dissolved oxygen concentration should be measured in each vessel. The oxygen concentration should be at least 60 % of the air saturation value (ASV) at the temperature used, and the pH of overlying water should be in the 6-9 range in all test vessels;

▼ M4

- the water temperature should not differ by more than $\pm 1,0$ °C. The water temperature could be controlled by isothermal room and in that case the room temperature should be confirmed in an appropriate time intervals.

DESCRIPTION OF THE METHOD**Test vessels**

11. The study is conducted in glass 600 ml beakers measuring 8 cm in diameter. Other vessels are suitable, but they should guarantee a suitable depth of overlying water and sediment. The sediment surface should be sufficient to provide 2 to 3 cm² per larvae. The ratio of the depth of the sediment layer to the depth of the overlying water should be 1:4. Test vessels and other apparatus that will come into contact with the test system should be made entirely of glass or other chemically inert material (e.g. Teflon).

Selection of species

12. The species to be used in the test is preferably *Chironomus riparius*. *Chironomus tentans* is also suitable but more difficult to handle and requires a longer test period. *Chironomus yohimatsui* may also be used. Details of culture methods are given in Appendix 2 for *Chironomus riparius*. Information on culture conditions is also available for other species, i.e. *Chironomus tentans* (4) and *Chironomus yohimatsui* (11). Identification of species must be confirmed before testing but is not required prior to every test if organisms come from an in-house culture.

Sediment

13. Formulated sediment (also called reconstituted, artificial or synthetic sediment) should preferably be used. However, if natural sediment is used, it should be characterised (at least pH, organic carbon content, determination of other parameters such as C/N ratio and granulometry are also recommended), and it should be free from any contamination and other organisms that might compete with, or consume the chironomids. It is also recommended that, before it is used in a chironomid toxicity test, the natural sediment be conditioned for seven days under the same conditions which prevail in the subsequent test. The following formulated sediment, based on the artificial soil used in Test Method C.8 (14), is recommended for use in this test (1)(15)(16):

- a) 4-5 % (dry weight) peat: as close to pH 5,5 to 6,0 as possible; it is important to use peat in powder form, finely ground (particle size ≤ 1 mm) and only air dried.
- b) 20 % (dry weight) kaolin clay (kaolinite content preferably above 30 %).
- c) 75-76 % (dry weight) quartz sand (fine sand should predominate with more than 50 % of the particles between 50 and 200 μm).
- d) Deionised water is added to obtain moisture of the final mixture in a range of 30-50 %.
- e) Calcium carbonate of chemically pure quality (CaCO_3) is added adjust the pH of the final mixture of the sediment to $7,0 \pm 0,5$.
- f) Organic carbon content of the final mixture should be 2 % ($\pm 0,5$ %) and is to be adjusted by the use of appropriate amounts of peat and sand, according to (a) and (c).

▼ M4

14. The source of peat, kaolin clay and sand should be known. The sediment components should be checked for the absence of chemical contamination (e.g. heavy metals, organochlorine compounds, organophosphorous compounds, etc.). An example for the preparation of the formulated sediment is described in Appendix 3. Mixing of dry constituents is also acceptable if it is demonstrated that after addition of overlying water a separation of sediment constituents (e.g. floating of peat particles) does not occur, and that the peat or the sediment is sufficiently conditioned.

Water

15. Any water which conforms to the chemical characteristics of acceptable dilution water as listed in Appendices 2 and 4 is suitable as test water. Any suitable water, natural water (surface or ground water), reconstituted water (see Appendix 2) or dechlorinated tap water are acceptable as culturing water and test water if chironomids will survive in it for the duration of the culturing and testing without showing signs of stress. At the start of the test, the pH of the test water should be between 6 and 9 and the total hardness not higher than 400 mg/l as CaCO₃. However, if there is an interaction suspected between hardness ions and the test substance, lower hardness water should be used (and thus, Elendt Medium M4 must not be used in this situation). The same type of water should be used throughout the whole study. The water quality characteristics listed in Appendix 4 should be measured at least twice a year or when it is suspected that these characteristics may have changed significantly.

Stock solutions — Spiked water

16. Test concentrations are calculated on the basis of water column concentrations, i.e. the water overlying the sediment. Test solutions of the chosen concentrations are usually prepared by dilution of a stock solution. Stock solutions should preferably be prepared by dissolving the test substance in test medium. The use of solvents or dispersants may be required in some cases in order to produce a suitably concentrated stock solution. Examples of suitable solvents are acetone, ethanol, methanol, ethylene glycol monoethyl ether, ethylene glycol dimethyl ether, dimethylformamide and triethylene glycol. Dispersants which may be used are Cremophor RH40, Tween 80, methylcellulose 0,01 % and HCO-40. The solubilising agent concentration in the final test medium should be minimal (i.e. ≤ 0,1 ml/l) and should be the same in all treatments. When a solubilising agent is used, it must have no significant effects on survival or no visible adverse effect on the chironomid larvae as revealed by a solvent-only control. However, every effort should be made to avoid the use of such materials.

TEST DESIGN

17. The test design relates to the selection of the number and spacing of the test concentrations, the number of vessels at each concentration and the number of larvae per vessel. Designs for EC point estimation, for estimation of NOEC, and for conducting a limit test are described. The analysis by regression is preferred to the hypothesis testing approach.

Design for analysis by regression

18. The effect concentration (e.g. EC₁₅, EC₅₀) and the concentration range, over which the effect of the test substance is of interest, should be spanned by the concentrations included in the test. Generally, the accuracy and especially validity, with which estimates of effect concentrations (EC_x) can be made, is improved when the effect concentration is within the range of concentrations tested. Extrapolation much below the lowest positive concentration or above

▼ M4

the highest concentration should be avoided. A preliminary range-finding test is helpful for selecting the range of concentrations to be used (see paragraph 27).

19. If the EC_x is to be estimated, at least five concentrations and three replicates for each concentration should be tested. In any case, it is advisable that sufficient test concentrations are used to allow a good model estimation. The factor between concentrations should not be greater than two (an exception could be made in cases when the dose response curve has a shallow slope). The number of replicates at each treatment can be reduced if the number of test concentrations with different responses is increased. Increasing the number of replicates or reducing the size of the test concentration intervals tends to lead to narrower confidence intervals for the test. Additional replicates are required if 10-day larval survival and growth are to be estimated.

Design for estimation of a NOEC/LOEC

20. If the LOEC/NOEC are to be estimated, five test concentrations with at least four replicates should be used and the factor between concentrations should not be greater than two. The number of replicates should be sufficient to ensure adequate statistical power to detect a 20 % difference from the control at the 5 % level of significance ($p = 0,05$). With the development rate, an Analysis of Variance (ANOVA) is usually appropriate, such as Dunnett-test and Williams-test (17)(18)(19)(20). In the emergence ratio the Cochran-Armitage, Fisher's exact (with Bonferroni correction), or Mantel-Haenszel tests may be used.

Limit test

21. A limit test may be performed (one test concentration and control) if no effects were seen in the preliminary range-finding test. The purpose of the limit test is to indicate that the toxic value of the test substance is greater than the limit concentration tested. No suggestion for a recommended concentration can be made in this Test Method; this is left to the regulators' judgement. Usually, at least six replicates for both the treatment and control are necessary. Adequate statistical power to detect a 20 % difference from the control at the 5 % level of significance ($p = 0,05$) should be demonstrated. With metric response (development rate and weight), the t-test is a suitable statistical method if data meet the requirements of this test (normality, homogeneous variances). The unequal-variance t-test or a non parametric test, such as the Wilcoxon-Mann-Whitney test may be used, if these requirements are not fulfilled. With the emergence ratio, the Fisher exact test is appropriate.

PROCEDURE**Conditions of exposure***Preparation of spiked water-sediment system*

22. Appropriate amounts of formulated sediment (see paragraphs 13-14 and Appendix 3) are added in the test vessels to form a layer of at least 1,5 cm. Water is added to a depth of 6 cm (see paragraph 15). The ratio of the depth of the sediment layer and the depth of the water should not exceed 1:4 and the sediment layer should not be deeper than 3 cm. The sediment-water system should be left under gentle aeration for seven days prior to addition of test organisms (see paragraph 14 and Appendix 3). To avoid separation of sediment ingredients and re-suspension of fine material during addition of test water in the water column, the sediment can be covered with a plastic disc while water is poured onto it, and the disc is removed immediately afterwards. Other devices may also be appropriate.

▼M4

23. The test vessels should be covered (e.g. by glass plates). If necessary, during the study the water levels will be topped to the original volume in order to compensate for water evaporation. This should be performed using distilled or deionised water to prevent build-up of salts.

Addition of test organisms

24. Four to five days before adding the test organisms to the test vessels, egg masses should be taken from the cultures and placed in small vessels in culture medium. Aged medium from the stock culture or freshly prepared medium may be used. If the latter is used, a small amount of food e.g. green algae and/or a few droplets of filtrate from a finely ground suspension of flaked fish food should be added to the culture medium (see Appendix 2). Only freshly laid egg masses should be used. Normally, the larvae begin to hatch a couple of days after the eggs are laid (2 to 3 days for *Chironomus riparius* at 20 °C and 1 to 4 days for *Chironomus tentans* at 23 °C and *Chironomus yoshimatui* at 25 °C) and larval growth occurs in four instars, each of 4-8 days duration. First instar larvae (2-3 or 1-4 days post hatching) should be used in the test. The instar of midges can possibly be checked using head capsule width (6).
25. Twenty first instar larvae are allocated randomly to each test vessel containing the spiked sediment and water, using a blunt pipette. Aeration of the water has to be stopped while adding the larvae to test vessels and remain so for another 24 hours after addition of larvae (see paragraphs 24 and 32). According to the test design used (see paragraphs 19 and 20), the number of larvae used per concentration is at least 60 for the EC point estimation and 80 for determination of NOEC.
26. Twenty-four hours after adding the larvae, the test substance is spiked into the overlying water column, and slight aeration is again supplied. Small volumes of test substance solutions are applied below the surface of the water using a pipette. The overlying water should then be mixed with care not to disturb the sediment.

Test concentrations

27. A range-finding test may be helpful to determine the range of concentrations for the definitive test. For this purpose a series of widely spaced concentrations of the test substance are used. In order to provide the same density of surface per chironomids, which is to be used for the definitive test, chironomids are exposed to each concentration of the test substance for a period which allows estimation of appropriate test concentrations, and no replicates are required.
28. The test concentrations for the definitive test are decided based on the result of the range-finding test. At least five concentrations should be used and selected as described in paragraphs 18 to 20.

Controls

29. Control vessels without any test substance but including sediment should be included in the test with the appropriate number of replicates (see paragraphs 19-20). If a solvent has been used for application of test substance (see paragraph 16), a sediment solvent control should be added.

▼ **M4***Test system*

30. Static systems are used. Semi-static or flow-through systems with intermittent or continuous renewal of overlying water might be used in exceptional cases as for instance if water quality specifications become inappropriate for the test organism or affect chemical equilibrium (e.g. dissolved oxygen levels fall too low, the concentration of excretory products rises too high or minerals leach from sediment and affect pH and/or water hardness). However, other methods for ameliorating the quality of overlying water, such as aeration, will normally suffice and be preferable.

Food

31. It is necessary to feed the larvae, preferably daily or at least three times per week. Fish-food (a suspension in water or finely ground food, e.g. TetraMin or TetraPhyll; see details in Appendix 2) in the amount of 0,25-0,5 mg (0,35-0,5 mg for *C. yoshimatui*) per larvae per day seems adequate for young larvae for the first 10 days. Slightly more food may be necessary for older larvae: 0,5-1 mg per larvae per day should be sufficient for the rest of the test. The food ration should be reduced in all treatments and control if fungal growth is seen or if mortality is observed in controls. If fungal development cannot be stopped the test is to be repeated. When testing strongly adsorbing substances (e.g. with $\log K_{ow} > 5$), or substances covalently binding to sediment, the amount of food necessary to ensure survival and natural growth of the organisms may be added to the formulated sediment before the stabilisation period. For this, plant material must be used instead of fish food, e.g. addition of 0,5 % (dry weight) finely ground leaves of e.g. stinging nettle (*Urtica dioica*), mulberry (*Morus alba*), white clover (*Trifolium repens*), spinach (*Spinacia oleracea*) or of other plant material (*Cerophyl* or alpha-cellulose) may be used.

Incubation conditions

32. Gentle aeration of the overlying water in test vessels is supplied preferably 24 hours after addition of the larvae and is pursued throughout the test (care should be taken that dissolved oxygen concentration does not fall below 60 % of ASV). Aeration is provided through a glass Pasteur pipette fixed 2-3 cm above the sediment layer (i.e. one or few bubbles/sec). When testing volatile chemicals, consideration may be given not to aerate the sediment-water system.
33. The test is conducted at a constant temperature of 20 °C (± 2 °C). For *C. tentans* and *C. yoshimatui*, recommended temperatures are of 23 °C and 25 °C (± 2 °C), respectively. A 16 hours photoperiod is used and the light intensity should be 500 to 1 000 lux.

Exposure duration

34. The exposure commences with the addition of larvae to the spiked and control vessels. The maximum exposure duration is 28 days for *C. riparius* and *C. yoshimatsui*, and 65 days for *C. tentans*. If midges emerge earlier, the test can be terminated after a minimum of five days after emergence of the last adult in the control.

OBSERVATIONS

Emergence

35. The development time and the total number of fully emerged male and female midges are determined. Males are easily identified by their plumose antennae.

▼ M4

36. The test vessels should be observed at least three times per week to make visual assessment of any abnormal behaviour (e.g. leaving sediment, unusual swimming), compared with the control. During the period of expected emergence a daily count of emerged midges is necessary. The sex and number of fully emerged midges are recorded daily. After identification the midges are removed from the vessels. Any egg masses deposited prior to the termination of the test should be recorded and then removed to prevent re-introduction of larvae into the sediment. The number of visible pupae that have failed to emerge is also recorded. Guidance on measurement of emergence is provided in Appendix 5.

Growth and survival

37. If data on 10-day larval survival and growth are to be provided, additional test vessels should be included at the start, so that they may be used subsequently. The sediment from these additional vessels is sieved using a 250 µm sieve to retain the larvae. Criteria for death are immobility or lack of reaction to a mechanical stimulus. Larvae not recovered should also be counted as dead (larvae which have died at beginning of the test may have been degraded by microbes). The (ash free) dry weight of the surviving larvae per test vessel is determined and the mean individual dry weight per vessel calculated. It is useful to determine which instar the surviving larvae belong to; for that measurement of the width of the head capsule of each individual can be used.

Analytical measurements*Concentration of the test substance*

38. As a minimum, samples of the overlying water, the pore water and the sediment must be analysed at the start (preferably one hour after application of test substance) and at the end of the test, at the highest concentration and a lower one. These determinations of test substance concentration inform on the behaviour/partitioning of the test substance in the water-sediment system. Sampling of sediment at the start of the test may influence the test system (e.g. removing test larvae), thus additional test vessels should be used to perform analytical determinations at the start and during the test if appropriate (see paragraph 39). Measurements in sediment might not be necessary if the partitioning of the test substance between water and sediment has been clearly determined in a water/sediment study under comparable conditions (e.g. sediment to water ratio, type of application, organic carbon content of sediment).
39. When intermediate measurements are made (e.g. at day 7) and if the analysis needs large samples which cannot be taken from test vessels without influencing the test system, analytical determinations should be performed on samples from additional test vessels treated in the same way (including the presence of test organisms) but not used for biological observations.
40. Centrifugation at e.g. 10 000 g and 4 °C for 30 min. is the recommended procedure to isolate interstitial water. However, if the test substance is demonstrated not to adsorb to filters, filtration may also be acceptable. In some cases it might not be possible to analyse concentrations in the pore water as the sample size is too small.

▼ **M4***Physical-chemical parameters*

41. The pH, dissolved oxygen in the test water and temperature of the test vessels should be measured in an appropriate manner (see paragraph 10). Hardness and ammonia should be measured in the controls and one test vessel at the highest concentration at the start and the end of the test.

DATA AND REPORTING

Treatment of results

42. The purpose of this test is to determine the effect of the test substance on the development rate and the total number of fully emerged male and female midges, or in the case of the 10-day test effects on survival and weight of the larvae. If there are no indications of statistically different sensitivities of sexes, male and female results may be pooled for statistical analyses. The sensitivity differences between sexes can be statistically judged by e.g. a χ^2 -r \times 2 table test. Larval survival and mean individual dry weight per vessel must be determined after 10 days where required.
43. Effect concentrations expressed as concentrations in the overlaying water, are calculated preferably based on measured concentrations at the beginning of the test (see paragraph 38).
44. To compute a point estimate for the EC₅₀ or any other EC_x, the per-vessel statistics may be used as true replicates. In calculating a confidence interval for any EC_x the variability among vessels should be taken into account, or it should be shown that this variability is so small that it can be ignored. When the model is fitted by Least Squares, a transformation should be applied to the per-vessel statistics in order to improve the homogeneity of variance. However, EC_x values should be calculated after the response is transformed back to the original value.
45. When the statistical analysis aims at determining the NOEC/LOEC by hypothesis testing, the variability among vessels needs to be taken into account, e.g. by a nested ANOVA. Alternatively, more robust tests (21) can be appropriate in situations where there are violations of the usual ANOVA assumptions.

Emergence ratio

46. Emergence ratios are quantal data, and can be analyzed by the Cochran-Armitage test applied in step-down manner where a monotonic dose-response is expected and these data are consistent with this expectation. If not, a Fisher's exact or Mantel-Haenszel test with Bonferroni-Holm adjusted p-values can be used. If there is evidence of greater variability between replicates within the same concentration than a binomial distribution would indicate (often referenced as 'extra-binomial' variation), then a robust Cochran-Armitage or Fisher exact test such as proposed in (21), should be used.
47. The sum of midges emerged per vessel, n_e , is determined and divided by the number of larvae introduced, n_a :

$$ER = \frac{n_e}{n_a}$$

▼ **M4**

where:

ER = emergence ratio

n_e = number of midges emerged per vessel

n_a = number of larvae introduced per vessel

48. An alternative that is most appropriate for large sample sizes, when there is extra binomial variance, is to treat the emergence ratio as a continuous response and use procedures such as William's test when a monotonic dose-response is expected and is consistent with these ER data. Dunnett's test would be appropriate where monotonicity does not hold. A large sample size is defined here as the number emerged and the number not emerging both exceeding five, on a per replicate (vessel) basis.
49. To apply ANOVA methods values of ER should first be transformed by the arcsin square root transformation or Freeman-Tukey transformation to obtain an approximate normal distribution and to equalise variances. The Cochran-Armitage, Fisher's exact (Bonferroni), or Mantel-Haenszel tests can be applied when using the absolute frequencies. The arcsin square root transformation is applied by taking the inverse sine (\sin^{-1}) of the square root of ER.
50. For emergence ratios, EC_x -values are calculated using regression analysis (or e.g. probit (22), logit, Weibull, appropriate commercial software etc.). If regression analysis fails (e.g. when there are less than two partial responses), other non-parametric methods such as moving average or simple interpolation are used.

Development rate

51. The mean development time represents the mean time span between the introduction of larvae (day 0 of the test) and the emergence of the experimental cohort of midges. (For the calculation of the true development time, the age of larvae at the time of introduction should be considered). The development rate is the reciprocal of the development time (unit: 1/day) and represents that portion of larval development which takes place per day. The development rate is preferred for the evaluation of these sediment toxicity studies as its variance is lower, and it is more homogeneous and closer to normal distribution as compared to development time. Hence, powerful parametric test procedures may be used with development rate rather than with development time. For development rate as a continuous response, EC_x -values can be estimated by using regression analysis (e.g. (23)(24)).
52. For the following statistical tests, the number of midges observed on inspection day x are assumed to be emerged at the mean of the time interval between day x and day $x - 1$ (l = length of the inspection interval, usually 1 day). The mean development rate per vessel (\bar{x}) is calculated according to:

$$\bar{x} = \sum_{i=1}^m \frac{f_i x_i}{n_e}$$

where:

\bar{x} : mean development rate per vessel

i : index of inspection interval

m : maximum number of inspection intervals

▼ M4

f_i : number of midges emerged in the inspection interval i

n_e : total number of midges emerged at the end of experiment ($= \sum f_i$)

x_i : development rate of the midges emerged in interval i

$$x_i = 1 / \left(\text{day}_i - \frac{l_i}{2} \right)$$

where:

day_i : inspection day (days since application)

l_i : length of inspection interval i (days, usually 1 day)

Test report

53. The test report must at least provide the following information:

Test substance:

- physical nature and, where relevant, physical-chemical properties (water solubility, vapour pressure, partition coefficient in soil (or in sediment if available), stability in water, etc.);
- chemical identification data (common name, chemical name, structural formula, CAS number, etc.) including purity and analytical method for quantification of test substance.

Test species:

- test animals used: species, scientific name, source of organisms and breeding conditions;
- information on handling of egg masses and larvae;
- age of test animals when inserted into test vessels.

Test conditions:

- sediment used, i.e. natural or formulated sediment;
- for natural sediment, location and description of sediment sampling site, including, if possible, contamination history; characteristics: pH, organic carbon content, C/N ratio and granulometry (if appropriate).
- preparation of the formulated sediment: ingredients and characteristics (organic carbon content, pH, moisture, etc. at the start of the test);
- preparation of the test water (if reconstituted water is used) and characteristics (oxygen concentration, pH, conductivity, hardness, etc. at the start of the test);
- depth of sediment and overlying water;
- volume of overlying and pore water; weight of wet sediment with and without pore water;
- test vessels (material and size);
- method of preparation of stock solutions and test concentrations;

▼ M4

- application of test substance: test concentrations used, number of replicates and use of solvent if any;
- incubation conditions: temperature, light cycle and intensity, aeration (frequency and intensity);
- detailed information on feeding including type of food, preparation, amount and feeding regime.

Results:

- the nominal test concentrations, the measured test concentrations and the results of all analyses to determine the concentration of the test substance in the test vessel;
- water quality within the test vessels, i.e. pH, temperature, dissolved oxygen, hardness and ammonia;
- replacement of evaporated test water, if any;
- number of emerged male and female midges per vessel and per day;
- number of larvae which failed to emerge as midges per vessel;
- mean individual dry weight of larvae per vessel, and per instar, if appropriate;
- percent emergence per replicate and test concentration (male and female midges pooled);
- mean development rate of fully emerged midges per replicate and treatment rate (male and female midges pooled);
- estimates of toxic endpoints e.g. EC_x (and associated confidence intervals), NOEC and/or LOEC, and the statistical methods used for their determination;
- discussion of the results, including any influence on the outcome of the test resulting from deviations from this Test Method.

LITERATURE:

- (1) BBA (1995). Long-term toxicity test with *Chironomus riparius*: Development and validation of a new test system. Edited by M. Streløke and H. Köpp. Berlin 1995.
- (2) Fleming R *et al.* (1994). Sediment Toxicity Tests for Poorly Water-Soluble Substances. Final Report to them European Commission. Report No: EC 3738. August 1994. WRc, UK.
- (3) SETAC (1993). Guidance Document on Sediment toxicity Tests and Bioassays for Freshwater and Marine Environments. From the WOSTA Workshop held in the Netherlands.
- (4) ASTM International/E1706-00 (2002). Test Method for Measuring the Toxicity of Sediment-Associated Contaminants with Freshwater Invertebrates. pp 1125-1241. In ASTM International 2002 Annual Book of Standards. Volume 11.05. Biological Effects and Environmental Fate; Biotechnology; Pesticides. ASTM International, West Conshohocken, PA.
- (5) Environment Canada (1997). Test for Growth and Survival in Sediment using Larvae of Freshwater Midges (*Chironomus tentans* or *Chironomus riparius*). Biological Test Method. Report SPE 1/RM/32. December 1997.
- (6) US-EPA (2000). Methods for Measuring the Toxicity and Bioaccumulation of Sediment-associated Contaminants with Freshwater Invertebrates. Second edition. EPA 600/R-99/064. March 2000. Revision to the first edition dated June 1994.

▼ M4

- (7) US-EPA/OPPTS 850.1735. (1996): Whole Sediment Acute Toxicity Invertebrates.
- (8) US-EPA/OPPTS 850.1790. (1996): Chironomid Sediment toxicity Test.
- (9) Milani D, Day KE, McLeay DJ, Kirby RS (1996). Recent intra- and inter-laboratory studies related to the development and standardisation of Environment Canada's biological test methods for measuring sediment toxicity using freshwater amphipods (*Hyalella azteca*) and midge larvae (*Chironomus riparius*). Technical Report. Environment Canada. National Water Research Institute. Burlington, Ontario, Canada.
- (10) Sugaya Y (1997). Intra-specific variations of the susceptibility of insecticides in *Chironomus yoshimatsui*. Jp. J. Sanit. Zool. 48 (4): 345-350.
- (11) Kawai K (1986). Fundamental studies on Chironomid allergy. I. Culture methods of some Japanese Chironomids (Chironomidae, Diptera). Jp. J. Sanit. Zool. 37(1): 47-57.
- (12) OECD (2000). Guidance Document on Aquatic Toxicity Testing of Difficult Substances and Mixtures. OECD Environment, Health and Safety Publications, Series on Testing and Assessment No 23.
- (13) Environment Canada (1995). Guidance Document on Measurement of Toxicity Test Precision Using Control Sediments Spiked with a Reference Toxicant. Report EPS 1/RM/30. September 1995.
- (14) Chapter C.8 of this Annex, Toxicity for Earthworms,
- (15) Suedel BC and Rodgers JH (1994). Development of formulated reference sediments for freshwater and estuarine sediment testing. Environ. Toxicol. Chem. 13: 1163-1175.
- (16) Naylor C and Rodrigues C (1995). Development of a test method for *Chironomus riparius* using a formulated sediment. Chemosphere 31: 3291-3303.
- (17) Dunnett CW (1964). A multiple comparisons procedure for comparing several treatments with a control. J. Amer. Statis. Assoc. 50: 1096-1121.
- (18) Dunnett CW (1964). New tables for multiple comparisons with a control. Biometrics 20: 482-491.
- (19) Williams DA (1971). A test for differences between treatment means when several dose levels are compared with a zero dose control. Biometrics 27: 103-117.
- (20) Williams DA (1972). The comparison of several dose levels with a zero dose control. Biometrics 28: 510-531.
- (21) Rao JNK and Scott AJ (1992). A simple method for the analysis of clustered binary data. Biometrics 48: 577-585.
- (22) Christensen ER (1984). Dose-response functions in aquatic toxicity testing and the Weibull model. Water Research 18: 213-221.
- (23) Bruce and Versteeg (1992). A statistical procedure for modelling continuous toxicity data. Environmental Toxicology and Chemistry 11:1485-1494.
- (24) Slob W (2002). Dose-response modelling of continuous endpoints. Toxicol. Sci. 66: 298-312.

▼ M4*Appendix 1*

DEFINITIONS

For the purpose of this method the following definitions are used:

Formulated sediment or reconstituted, artificial or synthetic sediment, is a mixture of materials used to mimic the physical components of a natural sediment.

Overlying water is the water placed over sediment in the test vessel.

Interstitial water or pore water is the water occupying space between sediment and soil particles.

Spiked water is the test water to which test substance has been added.

Test chemical: Any substance or mixture tested using this Test Method.

▼ M4*Appendix 2***Recommendations for culture of *Chironomus riparius***

1. *Chironomus* larvae may be reared in crystallising dishes or larger containers. Fine quartz sand is spread in a thin layer of about 5 to 10 mm deep over the bottom of the container. Kieselguhr (e.g. Merck, Art 8117) has also been shown to be a suitable substrate (a thinner layer of up to a very few mm is sufficient). Suitable water is then added to a depth of several cm. Water levels should be topped up as necessary to replace evaporative loss, and prevent desiccation. Water can be replaced if necessary. Gentle aeration should be provided. The larval rearing vessels should be held in a suitable cage which will prevent escape of the emerging adults. The cage should be sufficiently large to allow swarming of emerged adults, otherwise copulation may not occur (minimum is ca. 30 × 30 × 30 cm).
2. Cages should be held at room temperature or in a constant environment room at 20 ± 2 °C with a photo period of 16 hour light (intensity ca. 1 000 lux), 8 hours dark. It has been reported that air humidity of less than 60 % RH can impede reproduction.

Dilution water

3. Any suitable natural or synthetic water may be used. Well water, dechlorinated tap water and artificial media (e.g. Elendt 'M4' or 'M7' medium, see below) are commonly used. The water has to be aerated before use. If necessary, the culture water may be renewed by pouring or siphoning the used water from culture vessels carefully without destroying the tubes of larvae.

Feeding larvae

4. *Chironomus* larvae should be fed with a fish flake food (TetraMin[®], TetraPhyll[®] or other similar brand of proprietary fish food), at approximately 250 mg per vessel per day. This can be given as a dry ground powder or as a suspension in water: 1,0 g of flake food is added to 20 ml of dilution water and blended to give a homogenous mix. This preparation may be fed at a rate of about 5 ml per vessel per day (shake before use.) Older larvae may receive more.
5. Feeding is adjusted according to the water quality. If the culture medium becomes 'cloudy', the feeding should be reduced. Food additions must be carefully monitored. Too little food will cause emigration of the larvae towards the water column, and too much food will cause increased microbial activity and reduced oxygen concentrations. Both conditions can result in reduced growth rates.
6. Some green algae (e.g. *Scenedesmus subspicatus*, *Chlorella vulgaris*) cells may also be added when new culture vessels are set up.

Feeding emerged adults

7. Some experimenters have suggested that a cotton wool pad soaked in a saturated sucrose solution may serve as a food for emerged adults.

▼ M4**Emergence**

8. At 20 ± 2 °C adults will begin to emerge from the larval rearing vessels after approximately 13-15 days. Males are easily distinguished by having plumose antennae.

Egg masses

9. Once adults are present within the breeding cage, all larval rearing vessels should be checked three times weekly for deposition of the gelatinous egg masses. If present, the egg masses should be carefully removed. They should be transferred to a small dish containing a sample of the breeding water. Egg masses are used to start a new culture vessel (e.g. 2-4 egg masses/vessel) or are used for toxicity tests.
10. First instar larvae should hatch after 2-3 days.

Set-up of new culture vessels

11. Once cultures are established it should be possible to set up a fresh larval culture vessel weekly or less frequently depending on testing requirements, removing the older vessels after adult midges have emerged. Using this system a regular supply of adults will be produced with a minimum of management.

Preparation of test solutions 'M4' and 'M7'

12. Elendt (1990) has described the 'M4' medium. The 'M7' medium is prepared as the 'M4' medium except for the substances indicated in Table 1, for which concentrations are four times lower in 'M7' than in 'M4'. A publication on the 'M7' medium is in preparation (Elendt, personal communication). The test solution should not be prepared according to Elendt and Bias (1990) for the concentrations of $\text{NaSiO}_3 \cdot 5 \text{H}_2\text{O}$, NaNO_3 , KH_2PO_4 and K_2HPO_4 given for the preparation of the stock solutions are not adequate.

Preparation of the 'M7'-medium

13. Each stock solution (I) is prepared individually and a combined stock solution (II) is prepared from these stock solutions (I) (see Table 1). 50 ml from the combined stock Solution (II) and the amounts of each macro nutrient stock solution which are given in Table 2 are made up to 1 l of deionised water to prepare the 'M7' medium. A vitamin stock solution is prepared by adding three vitamins to deionised water as indicated in Table 3, and 0,1 ml of the combined vitamin stock solution are added to the final 'M7' medium shortly before use. (The vitamin stock solution is stored frozen in small aliquots). The medium is aerated and stabilised.

Table 1

Stock solutions of trace elements for medium M4 and M7

Stock solutions (I)	Amount (mg) made up to 1 litre of deionised water	To prepare the combined stock solution (II): mix the following amounts (ml) of stock solutions (I) and make up to 1 litre of deionised water		Final concentrations in test solutions (mg/l)	
		M4	M7	M4	M7
H_3BO_3 (1)	57 190	1,0	0,25	2,86	0,715
$\text{MnCl}_2 \cdot 4 \text{H}_2\text{O}$ (1)	7 210	1,0	0,25	0,361	0,090
LiCl (1)	6 120	1,0	0,25	0,306	0,077

▼ **M4**

Stock solutions (I)	Amount (mg) made up to 1 litre of deionised water	To prepare the combined stock solution (II): mix the following amounts (ml) of stock solutions (I) and make up to 1 litre of deionised water		Final concentrations in test solutions (mg/l)	
		M4	M7	M4	M7
RbCl ⁽¹⁾	1 420	1,0	0,25	0,071	0,018
SrCl ₂ · 6 H ₂ O ⁽¹⁾	3 040	1,0	0,25	0,152	0,038
NaBr ⁽¹⁾	320	1,0	0,25	0,016	0,004
Na ₂ MoO ₄ · 2 H ₂ O ⁽¹⁾	1 260	1,0	0,25	0,063	0,016
CuCl ₂ · 2 H ₂ O ⁽¹⁾	335	1,0	0,25	0,017	0,004
ZnCl ₂	260	1,0	1,0	0,013	0,013
CaCl ₂ · 6 H ₂ O	200	1,0	1,0	0,010	0,010
KI	65	1,0	1,0	0,0033	0,0033
Na ₂ SeO ₃	43,8	1,0	1,0	0,0022	0,0022
NH ₄ VO ₃	11,5	1,0	1,0	0,00058	0,00058
Na ₂ EDTA · 2 H ₂ O ⁽¹⁾ ⁽²⁾	5 000	20,0	5,0	2,5	0,625
FeSO ₄ · 7 H ₂ O ⁽¹⁾ ⁽²⁾	1 991	20,0	5,0	1,0	0,249

⁽¹⁾ These substances differ in M4 and M7, as indicated above.

⁽²⁾ These solutions are prepared individually, then poured together and autoclaved immediately.

Table 2

Macro nutrient stock solutions for medium M4 and M7

	Amount made up to 1 litre of deionised water (mg)	Amount of macro nutrient stock solutions added to prepare medium M4 and M7 (ml/l)	Final concentrations in test solutions M4 and M7 (mg/l)
CaCl ₂ · 2 H ₂ O	293 800	1,0	293,8
MgSO ₄ · 7 H ₂ O	246 600	0,5	123,3
KCl	58 000	0,1	5,8
NaHCO ₃	64 800	1,0	64,8
NaSiO ₃ · 9 H ₂ O	50 000	0,2	10,0
NaNO ₃	2 740	0,1	0,274
KH ₂ PO ₄	1 430	0,1	0,143
K ₂ HPO ₄	1 840	0,1	0,184

▼ **M4**

Table 3

Vitamin stock solution for medium M4 and M7

All three vitamin solutions are combined to make a single vitamin stock solution.

	Amount made up to 1 litre of deionised water (mg)	Amount of vitamin stock solution added to prepare medium M4 and M7 (ml/l)	Final concentrations in test solutions M4 and M7 (mg/l)
Thiamine hydrochloride	750	0,1	0,075
Cyanocobalamin (B12)	10	0,1	0,0010
Biotine	7,5	0,1	0,00075

LITERATURE:

BBA (1995). Long-term toxicity test with *Chironomus riparius*: Development and validation of a new test system. Edited by M. Streloke and H.Köpp. Berlin 1995.

Eldnt BP (1990). Selenium Deficiency in Crustacean. *Protoplasma* 154: 25-33.

Eldnt BP and Bias W-R (1990). Trace Nutrient Deficiency in *Daphnia magna* Cultured in Standard Medium for Toxicity Testing. Effects on the Optimization of Culture Conditions on Life History Parameters of *D. magna*. *Water Research* 24 (9): 1157-1167.

▼ **M4***Appendix 3*

PREPARATION OF FORMULATED SEDIMENT

Sediment composition

The composition of the formulated sediment should be as follows:

Constituent	Characteristics	% of sediment dry weight
Peat	Sphagnum moss peat, as close to pH 5,5-6,0 as possible, no visible plant remains, finely ground (particle size \leq 1 mm) and air dried	4-5
Quartz sand	Grain size: > 50 % of the particles should be in the range of 50-200 μ m	75-76
Kaolinite clay	Kaolinite content \geq 30 %	20
Organic carbon	Adjusted by addition of peat and sand	2 (\pm 0,5)
Calcium carbonate	CaCO ₃ , pulverised, chemically pure	0,05-0,1
Water	Conductivity \leq 10 μ S/cm	30-50

Preparation

The peat is air dried and ground to a fine powder. A suspension of the required amount of peat powder in deionised water is prepared using a high-performance homogenising device. The pH of this suspension is adjusted to $5,5 \pm 0,5$ with CaCO₃. The suspension is conditioned for at least two days with gentle stirring at 20 ± 2 °C, to stabilise pH and establish a stable microbial component. pH is measured again and should be $6,0 \pm 0,5$. Then the peat suspension is mixed with the other constituents (sand and kaolin clay) and deionised water to obtain a homogeneous sediment with a water content in a range of 30-50 per cent of dry weight of the sediment. The pH of the final mixture is measured once again and is adjusted to 6,5 to 7,5 with CaCO₃ if necessary. Samples of the sediment are taken to determine the dry weight and the organic carbon content. Then, before it is used in the chironomid toxicity test, it is recommended that the formulated sediment be conditioned for seven days under the same conditions which prevail in the subsequent test.

Storage

The dry constituents for preparation of the artificial sediment may be stored in a dry and cool place at room temperature. The formulated (wet) sediment should not be stored prior to its use in the test. It should be used immediately after the 7 days conditioning period that ends its preparation.

LITERATURE:

Chapter C.8 of this Annex, Toxicity for Earthworms

Meller M, Egeler P, Rombke J, Schallnass H, Nagel R and Streit B (1998). Short-term Toxicity of Lindane, Hexachlorobenzene and Copper Sulfate on Tubificid Sludgeworms (Oligochaeta) in Artificial Media. *Ecotox. and Environ. Safety* 39: 10-20.

▼ M4*Appendix 4***Chemical Characteristics of Acceptable Dilution Water**

Substance	Concentrations
Particulate matter	< 20 mg/l
Total organic carbon	< 2 mg/l
Unionised ammonia	< 1 µg/l
Hardness as CaCO ₃	< 400 mg/l (*)
Residual chlorine	< 10 µg/l
Total organophosphorus pesticides	< 50 ng/l
Total organochlorine pesticides plus polychlorinated biphenyls	< 50 ng/l
Total organic chlorine	< 25 ng/l

(*) However, it should be noted that if there is an interaction suspected between hardness ions and the test substance, lower hardness water should be used (and thus, Elendt Medium M4 must not be used in this situation).

▼ **M4***Appendix 5***Guidance for monitoring emergence of chironomid larvae**

Emergence traps are placed on the test beakers. These traps are needed from day 20 to the end of the test. Example of trap used is drawn below:

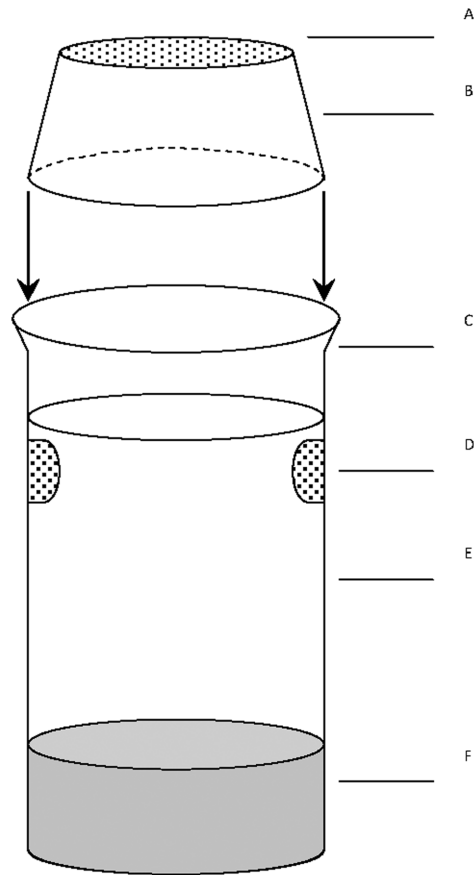

A: the nylon screen

D: the water exchange screen ports

B: the inverted plastic cups

E: water

C: the lipless exposure beaker

F: sediment

▼ M4**C.29. READY BIODEGRADABILITY — CO₂ IN SEALED VESSELS (HEADSPACE TEST)**

INTRODUCTION

1. This Test Method is equivalent to OECD Test Guideline (TG) 310 (2006). This Test Method is a screening method for the evaluation of ready biodegradability of chemicals and provides similar information to the six test methods described in chapter C.4 of this Annex A to F. Therefore, a chemical that shows positive results in this Test Method can be considered readily biodegradable and consequently rapidly degradable in the environment.
2. The well established carbon dioxide (CO₂) method (1), based on Sturm's original test (2) for assessing biodegradability of organic chemicals, by the measurement of the carbon dioxide produced by microbial action, has normally been the first choice for testing poorly soluble chemicals and those which strongly adsorb. It is also chosen for soluble (but not volatile) chemicals, since the evolution of carbon dioxide is considered by many to be the only unequivocal proof of microbial activity. Removal of dissolved organic carbon can be effected by physico-chemical processes — adsorption, volatilisation, precipitation, hydrolysis — as well as by microbial action and many non-biological reactions consume oxygen; rarely is CO₂ produced from organic chemicals abiotically. In the original and modified Sturm test (1)(2) CO₂ is removed from the liquid phase to the absorbing vessels by sparging (i.e. bubbling air treated to remove CO₂ through the liquid medium), while in the version of Larson (3)(4) CO₂ is transferred from the reaction vessel to the absorbers by passing CO₂-free air through the headspace and, additionally, by shaking the test vessel continuously. Only in the Larson modification is the reaction vessel shaken; stirring is specified only for insoluble substances in ISO 9439 (5) and in the original US version (6), both of which specify sparging rather than headspace replacement. In another official US EPA method (7) based on Gledhill's method (8), the shaken reaction vessel is closed to the atmosphere and CO₂ produced is collected in an internal alkaline trap directly from the gaseous phase, as in classical Warburg/Barcroft respirometer flasks.
3. However, inorganic carbon (IC) has been shown to accumulate in the medium during the application of the standard, modified Sturm test to a number of chemicals (9). A concentration of IC as high as 8 mg/l was found during the degradation of 20 mg C/l of aniline. Thus, the collection of CO₂ in the alkaline traps did not give a true reflection of the amount of CO₂ produced microbiologically at intermediate times during the degradation. As a result, the specification that > 60 % theoretical maximum CO₂ production (ThCO₂) must be collected within a '10-d window' (the 10 days immediately following the attainment of 10 % biodegradation) for a test chemical to be classified as readily biodegraded will not be met for some chemicals which would be so classified using dissolved organic carbon (DOC) removal.
4. When the percentage degradation is a lower value than expected, IC is possibly accumulated in the test solution. Then, the degradability may be assessed with the other ready biodegradability tests.

▼ M4

5. Other drawbacks of the Sturm methodology (cumbersome, time-consuming, more prone to experimental error and not applicable to volatile chemicals) had earlier prompted a search for a sealed vessel technique, other than Gledhill's, rather than gas flow-through (10)(11). Boatman et al (12) reviewed the earlier methods and adopted an enclosed headspace system in which the CO₂ was released into the headspace at the end of incubation by acidifying the medium. CO₂ was measured by gas chromatography (GC)/IC analysis in automatically taken samples of the headspace but dissolved inorganic carbon (DIC) in the liquid phase was not taken into account. Also, the vessels used were very small (20 ml) containing only 10 ml of medium, which caused problems e.g. when adding the necessarily very small amounts of insoluble test chemicals, and/or there may be insufficient or no microorganisms present in the inoculated medium that are competent to degrade the test chemicals.
6. These difficulties have been overcome by the independent studies of Struijs and Stoltenkamp (13) and of Birch and Fletcher (14), the latter being inspired by their experience with apparatus used in the anaerobic biodegradation test (15). In the former method (13) CO₂ is measured in the headspace after acidification and equilibration, while in the latter (14) DIC in both the gaseous and liquid phases was measured, without treatment; over 90 % of the IC formed was present in the liquid phase. Both methods had advantages over the Sturm test in that the test system was more compact and manageable, volatile chemicals can be tested and the possibility of delay in measuring CO₂ produced is avoided.
7. The two approaches were combined in the ISO Headspace CO₂ Standard (16), which was ring-tested (17) and it is this Standard which forms the basis of the present Test Method. Similarly, the two approaches have been used in the US EPA method (18). Two methods of measuring CO₂ have been recommended, namely CO₂ in headspace after acidification (13) and IC in the liquid phase after the addition of excess alkali. The latter method was introduced by Peterson during the CONCAWE ring test (19) of this headspace method modified to measure inherent biodegradability. The changes made in the 1992 (20) revision of the methods in chapter C.4 of this Annex for Ready Biodegradability have been incorporated into this Test Method, so that the conditions (medium, duration etc.) are otherwise the same as those in the revised Sturm test (20). Birch and Fletcher (14) have shown that very similar results were obtained with this headspace test as were obtained with the same chemicals in the OECD Ring Test (21) of the revised Test Methods.

PRINCIPLE OF THE TEST

8. The test chemical, normally at 20 mg C/l, as the sole source of carbon and energy, is incubated in a buffer-mineral salts medium which has been inoculated with a mixed population of micro-organisms. The test is performed in sealed bottles with a headspace of air, which provides a reservoir of oxygen for aerobic biodegradation. The CO₂ evolution resulting from the ultimate aerobic biodegradation of the test chemical is determined by measuring the IC produced in the test bottles in excess of that produced in blank vessels containing inoculated medium only. The extent of biodegradation is expressed as a percentage of the theoretical maximum IC production (ThIC), based on the quantity of test chemical (as organic carbon) added initially.
9. The DOC removal and/or the extent of primary biodegradation of the test chemical can also be measured (20).

▼ M4

INFORMATION ON THE TEST CHEMICAL

10. The organic carbon content (% w/w) of the test chemical needs to be known, either from its chemical structure or by measurement, so that the percentage degradation may be calculated. For volatile test chemicals, a measured or calculated Henry's law constant is helpful for determining a suitable headspace to liquid volume ratio. Information on the toxicity of the test chemical to micro-organisms is useful in selecting an appropriate test concentration and for interpreting results showing poor biodegradability: it is recommended to include the inhibition control unless it is known that the test chemical is not inhibitory to microbial activities (see paragraph 24).

APPLICABILITY OF THE METHOD

11. The test is applicable to water-soluble and insoluble test chemicals, though good dispersion of the test chemical should be ensured. Using the recommended headspace to liquid volume ratio of 1:2, volatile chemicals with a Henry's law constant of up to $50 \text{ Pa}\cdot\text{m}^3\cdot\text{mol}^{-1}$ can be tested as the proportion of test chemical in the headspace will not exceed 1 % (13). A smaller headspace volume may be used when testing chemicals, which are more volatile, but their bioavailability may be limiting especially if they are poorly soluble in water. However, users must ensure that the headspace to liquid volume ratio and the test chemical concentration are such that sufficient oxygen is available to allow complete aerobic biodegradation to occur (e.g. avoid using a high substrate concentration and a small headspace volume). Guidance on this matter can be found in (13)(23).

REFERENCE CHEMICALS

12. In order to check the test procedure, a reference chemical of known biodegradability should be tested in parallel. For this purpose, aniline, sodium benzoate or ethylene glycol may be used when testing water-soluble test chemicals and 1-octanol for poorly soluble test chemicals (13). Biodegradation of these chemicals must reach > 60 % ThIC within 14 days.

REPRODUCIBILITY

13. In the ISO ring test of the method (17), the following results were obtained using the recommended conditions, including 20 mg C test chemical/l.

Test Chemical	Mean Percentage Biodegradation (28d)	Coefficient of variation (%)	Number of Laboratories
Aniline	90	16	17
1-Octanol	85	12	14

Within-test variability (replicability), using aniline, was low with coefficients of variability not greater than 5 % in nearly all test runs. In the two cases in which the replicability was worse, the greater variability was probably due to high IC production in the blanks. Replicability was worse with 1-octanol but was still less than 10 % for 79 % of test runs. This greater within-test variability may have been due to dosing errors, as a small volume (3 to 4 μl) of 1-octanol had to be injected into sealed test bottles. Higher coefficients of variation would result when lower concentrations of test chemical are used, especially at concentrations lower than 10 mg C/l. This could be partially overcome by reducing the concentration of total inorganic carbon (TIC) in the inoculum.

▼ **M4**

14. In an EU ring-test (24) of five surfactants added at 10 mg C/l, the following results were obtained:

Test Chemical	Mean Percentage biodegradation (28d)	Coefficient of variation (%)	Number of laboratories
Tetrapropylene Benzene sulphonate	17	45	10
Di-iso-octylsulpho-Succinate (anionic)	72	22	9
Hexadecyl-trimethyl (*) Ammonium chloride (cationic)	75	13	10
Iso-Nonylphenol - (ethoxylate) ₉ (non-ionic)	41	32	10
Coco-amide-propyl Dimethylhydroxy Sulphobetaine (amphoteric)	60	23	11

(*) SiO₂ was added to neutralize toxicity.

The results show that generally, the variability was higher for the less well-degraded surfactants. Within-test variability was less than 15 % for over 90 % of cases, the highest reaching 30-40 %.

NOTE: Most surfactants are not single molecular species but are mixtures of isomers, homologues, etc. which degrade after different characteristic lag periods and at different kinetic rates resulting in 'blurred', extenuated curves, so that the 60 % pass value may not be reached within 'the 10-d window', even though each individual molecular species would reach > 60 % within 10 days if tested alone. This may be observed with other complex mixtures as well.

DESCRIPTION OF THE METHOD

Apparatus

15. Normal laboratory apparatus and:
- Glass serum bottles, sealed with butyl rubber stoppers and crimp-on aluminium seals. The recommended size is '125 ml' which have a total volume of around 160 ml (in this case the volume of each bottle should be known to be 160 ± 1 ml). A smaller size of vessel may be used when the results fulfil the conditions described in paragraph 66 and 67;
 - Carbon analyser or other instrument (e.g. gas chromatograph) for measuring inorganic carbon;

▼M4

- (c) Syringes of high precision for gaseous and liquid samples;
- (d) Orbital shaker in a temperature-controlled environment;
- (e) A supply of CO₂ free air — this can be prepared by passing air through soda lime granules or by using an 80 % N₂/20 % O₂ gas mixture (optional) (see paragraph 28);
- (f) Membrane-filtration device of 0,20–0,45 µm porosity (optional);
- (g) Organic carbon analyser (optional).

Reagents

16. Use analytical grade reagents throughout.

Water

17. Distilled or de-ionised water should be used containing ≤ 1 mg/l as total organic carbon. This represents ≤ 5 % of the initial organic carbon content introduced by the recommended dose of the test chemical.

Stock solutions for the mineral salts medium

18. The stock solutions and the mineral salts medium are similar to those in ISO 14593 (16) and C.4 'ready biodegradability' tests (20). The use of a higher concentration of ammonium chloride (2,0 g/l instead of 0,5 g/l) should only be necessary in very exceptional cases, e.g. when the test chemical concentration is > 40 mg C/l. Stock solutions should be stored under refrigeration and disposed of after six months, or earlier if there is evidence of precipitation or microbial growth. Prepare the following stock solutions:

- (a) Potassium dihydrogen phosphate (KH₂PO₄) 8,50 g

Dipotassium hydrogen phosphate (K₂HPO₄) 21,75 g

Disodium hydrogen phosphate dihydrate (Na₂HPO₄·2H₂O) 33,40 g

Ammonium chloride (NH₄Cl) 0,50 g

Dissolve in water and make up to 1 litre. The pH of this solution should be 7,4 (± 0,2). If this is not the case, then prepare a new solution.

- (b) Calcium chloride dihydrate (CaCl₂·2H₂O) 36,40 g

Dissolve in water and make up to 1 litre.

- (c) Magnesium sulphate heptahydrate (MgSO₄·7H₂O) 22,50 g

Dissolve in water and make up to 1 litre.

- (d) Iron (III) chloride hexahydrate (FeCl₃·6H₂O) 0,25 g

Dissolve in water and make up to 1 litre and add one drop of concentrated HCl.

Preparation of mineral medium

19. Mix 10 ml of solution (a) with approximately 800 ml water (paragraph 17), then add 1 ml of solutions (b), (c) and (d) and make up to 1 litre with water (paragraph 17).

Other reagents

20. Concentrated ortho-phosphoric acid (H₃PO₄) (> 85 % mass per volume).

▼ M4*Sodium hydroxide solution 7M*

21. Dissolve 280 g of sodium hydroxide (NaOH) in 1 litre of water (paragraph 17). Determine the concentration of DIC of this solution and consider this value when calculating the test result (see paragraphs 55 and 61), especially in the light of the validity criterion in paragraph 66 (b). Prepare a fresh solution if the concentration of DIC is too high.

Test chemical

22. Prepare a stock solution of a sufficiently water-soluble test chemical in water (paragraph 17) or in the test medium (paragraph 19) at a concentration preferably 100-fold greater than the final concentration to be used in the test; it may be necessary to adjust the pH of the stock solution. The stock solution should be added to the mineral medium to give a final organic carbon concentration of between 2 and 40 mg C/l, preferably 20 mg C/l. If concentrations lower than these are used, the precision obtained may be impaired. Soluble and insoluble liquid chemicals may be added to the vessels directly using high precision syringes. Poorly soluble and insoluble test chemicals may require special treatment (25). The choices are:

- (a) direct addition of known weighed amounts;
- (b) ultrasonic dispersion before addition;
- (c) dispersion with the aid of emulsifying agents to be required to establish whether they have any inhibitory or stimulatory effects on microbial activity before addition;
- (d) adsorption of liquid test chemicals, or a solution in a suitable volatile solvent, on to an inert medium or support (e.g. glass fibre filter), followed by evaporation of the solvent, if used, and direct addition of known amounts;
- (e) addition of known volume of a solution of the test chemical in an easily volatile solvent to an empty test vessel, followed by evaporation of the solvent.

Agents or solvents used in (c), (d) and (e) have to be tested for any stimulatory or inhibitory effect on microbial activity (see paragraph 42(b).)

Reference chemical

23. Prepare a stock solution of the (soluble) reference chemical in water (paragraph 17) at a concentration preferably 100-fold greater than the final concentration to be used (20 mg C/l) in the test.

Inhibition check

24. Test chemicals frequently show no significant degradation under the conditions used in ready biodegradation assessments. One possible cause is that the test chemical is inhibitory to the inoculum at the concentration at which it is applied in the test. An inhibition check may be included in the test design to facilitate identification (in retrospect) of inhibition as a possible cause or contributory factor. Alternatively, the inhibition check may rule out such interferences and show that zero or slight degradation is attributable solely to non-amenability to microbial attack under the conditions of the test. In order to obtain information on the toxicity of the test chemical to (aerobic) micro-organisms, prepare a solution in the test medium containing the test chemical and the reference chemical (paragraph 19), each at the same concentrations as added, respectively (see paragraph 22 and 23).

▼ **M4***Inoculum*

25. The inoculum may be derived from a variety of sources: activated sludge; sewage effluent (non-chlorinated); surface waters and soils; or from a mixture of these (20). The biodegradative activity of the source should be checked by using a reference chemical. Whatever the source, micro-organisms previously exposed to the test chemical should not be used if the procedure is to be used as a test for ready biodegradability.

Warning: Activated sludge, sewage and sewage effluent contain pathogenic organisms and must be handled with caution.

26. Based on experience, the optimal volume for the inoculum is that which:

- is sufficient to give adequate biodegradative activity;
- degrades the reference chemical by the stipulated percentage (see paragraph 66);
- gives 10^2 to 10^5 colony-forming units per millilitre in the final mixture;
- normally gives a concentration of 4 mg/l suspended solids in the final mixture when activated sludge is used, concentrations up to 30 mg/l may be used but may significantly increase CO₂ production of the blanks (26);
- contributes less than 10 % of the initial concentration of organic carbon introduced by the test chemical;
- is generally 1-10 ml of inoculum for 1 litre of test solution.

Activated sludge

27. Activated sludge is freshly collected from the aeration tank of a sewage treatment plant or laboratory-scale unit treating predominantly domestic sewage. If necessary, coarse particles should be removed by sieving (e.g. using a 1 mm² mesh sieve) and the sludge should be kept aerobic until used.
28. Alternatively, after removal of any coarse particles, settle or centrifuge (e.g. 1 100 × g for 10 minutes). Discard the supernatant liquid. The sludge may be washed in the mineral solution. Suspend the concentrated sludge in mineral medium to yield a concentration of 3-5 g suspended solids/l. Thereafter aerate until required.
29. Sludge should be taken from a properly working conventional treatment plant. If sludge has to be taken from a high rate treatment plant, or is thought to contain inhibitors, it should be washed. Settle or centrifuge the re-suspended sludge after thorough mixing, discard the supernatant liquid and again suspend the washed sludge in a further volume of mineral medium. Repeat this procedure until the sludge is considered to be free from excess substrate or inhibitor.
30. After complete re-suspension is achieved, or with untreated sludge, withdraw a sample just before use for the determination of the dry weight of the suspended solids.
31. A further alternative is to homogenise activated sludge (3-5 g suspended solids/l). Treat the sludge in a Waring blender for 2 minutes at medium speed. Settle the blended sludge for 30 minutes or longer if required and decant liquid for use as inoculum at the rate of about 10 mg/l of mineral medium.

▼M4

32. Still further reduction of the blank CO₂ evolution can be achieved by aerating the sludge overnight with CO₂-free air. Use 4 mg/l activated sludge solids as the concentration of the inoculum in this test (13).

Secondary sewage effluent

33. Alternatively, the inoculum can be derived from the secondary effluent of a treatment plant or laboratory-scale unit receiving predominantly domestic sewage. Maintain the sample under aerobic conditions and use on the day of collection, or pre-condition if necessary. The effluent should be filtered through a coarse filter to remove gross particulate matter and the pH value is measured.
34. To reduce its IC content, the filtrate is sparged with CO₂-free air (paragraph 15-e) for 1 h while maintaining the pH at 6,5 using orthophosphoric acid (paragraph 20). The pH value is restored to its original value with sodium hydroxide (paragraph 21) and after settling for about 1 h a suitable volume of the supernatant is taken for inoculation. This sparging procedure reduces the IC content of the inoculum. For example, when the maximum recommended volume of filtered sparged effluent (100 ml) per litre was used as inoculum, the amount of IC present in blank control vessels was in the range 0,4 to 1,3 mg/l (14), representing 2-6,5 % of test chemical C at 20 mg C/l and 4-13 % at 10 mg C/l.

Surface waters

35. A sample is taken of an appropriate surface water. It should be kept under aerobic conditions and used on the day of collection. The sample should be concentrated, if necessary, by filtration or centrifugation. The volume of inoculum to be used in each test vessel should meet the criteria given in paragraph 26.

Soils

36. A sample is taken of an appropriate soil, collected to a depth of up to 20 cm below the soil surface. Stones, plant remains and invertebrates should be removed from the sample of soil before it is sieved through a 2 mm mesh (if the sample is too wet to sieve immediately, then partially air dry to facilitate sieving). It should be kept under aerobic conditions and used on the day of collection (If the sample is transported in a loosely-tied black polythene bag, it can be stored at 2 to 4 °C in the bag for up to one month).

Preconditioning of inoculum

37. Inoculum may be pre-conditioned to the experimental conditions, but not pre-adapted to the test chemical. Pre-conditioning can reduce the blank CO₂ evolution. Pre-conditioning consists of aerating activated sludge after diluting in test medium to 30 mg/l with moist CO₂-free air for up to 5-7 days at the test temperature.

TEST PROCEDURE*Number of bottles*

38. The number of bottles (paragraph 15-a) needed for a test will depend on the frequency of analysis and the test duration.
39. It is recommended that triplicate bottles be analysed after a sufficient number of time intervals such that the 10-d window may be identified. Also at least five test bottles (paragraph 15-a) from sets (a), (b) and (c) (see paragraph 42) are analysed at the end of the test, to enable 95 % confidence intervals to be calculated for the mean percentage biodegradation value.

▼ M4*Inoculated medium*

40. The inoculum is used at a concentration of 4 mg/l activated sludge dry solids. Prepare immediately before use sufficient inoculated medium by adding, for example, 2 ml suitably treated activated sludge (paragraphs 27 to 32) at 2 000 mg/l to 1 litre of mineral salts medium (paragraph 19). When secondary sewage effluent is to be used add up to 100 ml effluent (paragraph 33) to 900 ml mineral salts medium (paragraph 19) and dilute to 1 litre with medium.

Preparation of bottles

41. Aliquots of inoculated medium are dispensed into replicate bottles to give a headspace to liquid ratio of 1:2 (e.g. add 107 ml to 160 ml-capacity bottles). Other ratios may be used, but see the warning given in paragraph 11. When using either type of inoculum, care must be taken to ensure that the inoculated medium is adequately mixed to ensure that it is uniformly distributed to the test bottles.
42. Sets of bottles (paragraph 15a) are prepared to contain the following:
- (a) Test vessels (denoted F_T) containing the test chemical;
 - (b) Blank controls (denoted F_B) containing only the test medium plus inoculum; any chemicals, solvents, agents or glass fibre filters used to introduce the test chemical into the test vessels must also be added;
 - (c) Vessels (denoted F_C) for checking the procedure containing the reference chemical;
 - (d) If needed, vessels (denoted F_I) for checking a possible inhibitory effect of the test chemical containing both the test chemical and reference chemical at the same concentrations (paragraph 24) as in bottles F_T and F_C , respectively;
 - (e) Vessels (denoted F_S) for checking a possible abiotic degradation as (a) plus 50 mg/l $HgCl_2$ or sterilised by some other means (e.g. by autoclaving).
43. Water-soluble test chemicals and reference chemicals are added as aqueous stock solutions (paragraphs 22, 23 and 24) to give a concentration of 10 to 20 mg C/l.
44. Insoluble test chemicals and insoluble reference chemicals are added to bottles in a variety of ways (see paragraph 22a-e) according to the nature of the test chemical, either before or after addition of the inoculated medium, depending on the method of treatment of the test chemical. If one of the procedures given in paragraph 22a-e is used, then the blank bottles F_B (paragraph 42b) should be treated in a similar fashion but excluding the test chemical or reference chemical.
45. Volatile test chemicals should be injected into sealed bottles (paragraph 47) using a micro syringe. The dose is calculated from the volume injected and the density of the test chemical.
46. Water should be added to vessels, where necessary, to give the same liquid volume in each vessel. It must be ensured that the headspace to liquid ratio (usually 1:2) and concentration of the test chemical are such that sufficient oxygen is available in the headspace to allow for complete biodegradation.

▼ M4

47. All bottles are then sealed for example, with butyl rubber septa and aluminium caps. Volatile tests chemicals should be added at this stage (paragraph 45). If the decrease in DOC concentration of the test solution is to be monitored and for time zero analyses to be performed for initial IC concentration (sterile controls, paragraph 42e) or other determinands, remove an appropriate sample from the test vessel. The test vessel and its contents are then discarded.

48. The sealed bottles are placed on a rotary shaker (paragraph 15d), with a shaking rate sufficient to keep the bottle contents well mixed and in suspension (e.g. 150 to 200 rpm), and incubated in the dark at 20 °C, to be kept within ± 1 °C.

Sampling

49. The pattern of sampling will depend on the lag period and kinetic rate of biodegradation of the test chemical. Bottles are sacrificed for analysis on the day of sampling, which should be at least weekly or more frequently (e.g. twice per week) if a complete degradation curve is required. The requisite number of replicate bottles is taken from the shaker, representing F_T , F_B and F_C and, if used F_I and F_S (see paragraph 42). The test normally runs for 28d. If the biodegradation curve indicates that a plateau has been attained before 28d, the test may be concluded earlier than 28d. Take samples from the five bottles reserved for the 28th day of the test for analysis and use the results to calculate the confidence limits or coefficient of variation of percentage biodegradation. Bottles representing the checks for inhibition and for abiotic degradation need not be sampled as frequently as the other bottles; day 1 and day 28 would be sufficient.

Inorganic carbon (IC) analysis

50. CO₂ production in the bottles is determined by measuring the increase in the concentration of inorganic carbon (IC) during incubation. There are two recommended methods available for measuring the amount of IC produced in the test, and these are described immediately below. Since the methods can give slightly different results only one should be used in a test run.

51. Method (a) is recommended if the medium is likely to contain remnants of, for example, a glass-filter paper and/or insoluble test chemical. This analysis can be performed using a gas chromatograph if a carbon analyser is not available. It is important that the bottles should be at or close to the test temperature when the headspace gas is analysed. Method (b) can be easier for laboratories using carbon analysers to measure IC. It is important that the sodium hydroxide solution (paragraph 21) used to convert CO₂ to carbonate is either freshly prepared or its IC content is known, so that this can be taken into account when calculating the test results (see paragraph 66-b.)

Method (a): acidification to pH < 3

52. Before each batch of analyses, the IC analyser is calibrated using an appropriate IC standard (e.g. 1 % w/w CO₂ in N₂). Concentrated orthophosphoric acid (paragraph 20) is injected through the septum of each bottle sampled to lower the pH of the medium to < 3 (e.g. add 1 ml to 107 ml test medium). The bottles are placed back on the shaker. After shaking for one hour at the test temperature the bottles are removed from the shaker, aliquots (e.g. 1 ml) of gas are withdrawn from the headspace of each bottle and injected into the IC analyser. The measured IC concentrations are recorded as mg C/l.

▼ M4

53. The principle of this method is that after acidification to $\text{pH} < 3$ and equilibration at $20\text{ }^\circ\text{C}$, the equilibrium constant for the distribution of CO_2 between the liquid and gaseous phases in the test bottles is 1,0 when measured as a concentration (13). This should be demonstrated for the test system at least once as follows:

Set up bottles containing 5 and 10 mg/l as IC using a solution of anhydrous sodium carbonate (Na_2CO_3) in CO_2 -free water prepared by acidifying water to $\text{pH} 6,5$ with concentrated ortho-phosphoric acid (paragraph 20), sparging overnight with CO_2 -free air and raising the pH to neutrality with alkali. Ensure that the ratio of the headspace volume to the liquid volume is the same as in the tests (e.g. 1:2). Acidify and equilibrate as described in paragraph 52, and measure the IC concentrations of both the headspace and liquid phases. Check that the two concentrations are the same within experimental error. If they are not, the operator should review the procedures. This check on the distribution of IC between liquid and gaseous phases need not be made every time the test is performed; it could presumably be made while performing the calibration.

54. If DOC removal is to be measured (water-soluble test chemicals only), samples should be taken of the liquid phase from separate (non-acidified) bottles, membrane-filtered and injected into the DOC analyser. These bottles can be used for other analyses as necessary, to measure primary biodegradation.

Method (b): conversion of CO_2 to carbonate

55. Before each batch of analyses, the IC analyser is calibrated using an appropriate standard — for example, a solution of sodium bicarbonate (NaHCO_3) in CO_2 free water (see paragraph 53) in the range 0 to 20 mg/l as IC. Sodium hydroxide solution (7M, paragraph 21) (e.g. 1 ml to 107 ml medium) is injected through the septum of each bottle sampled and the bottles are shaken for 1 h at the test temperature. Use the same NaOH solution on all bottles sacrificed on a particular day, but not necessarily on all sampling occasions throughout a test. If absolute blank IC values are required at all sampling occasions, IC determinations of the NaOH solution will be required each time it is used. The bottles are removed from the shaker and allowed to settle. Suitable volumes (e.g. 50 to 1 000 μl) of the liquid phase in each vessel are withdrawn by syringe. The samples are injected into the IC analyser and the concentrations of IC are recorded. It should be ensured that the analyser used is equipped properly to deal with the alkaline samples produced in this method.
56. The principle of this method is that after the addition of alkali and shaking, the concentration of IC in the headspace is negligible. This should be checked for the test system at least once by using IC standards, adding alkali and equilibrating, and measuring the concentration of IC in both the headspace and liquid phases (see paragraph 53). The concentration in the headspace should approach zero. This check on the virtually complete absorption of CO_2 need not be made every time the test is performed.
57. If DOC removal is to be measured (water-soluble test chemicals only), samples should be taken of the liquid phase from separate bottles (containing no added alkali), membrane filtered and injected into the DOC analyser. These bottles can be used for other analyses, as necessary, to measure primary biodegradability.

▼ M4**DATA AND REPORTING****Calculating of results**

58. Assuming 100 % mineralisation of the test chemical to CO₂, the ThIC in excess of that produced in the blank controls equals the TOC added to each test bottle at the start of the test, that is:

$$\text{ThIC} = \text{TOC}$$

The total mass (mg) of inorganic carbon (TIC) in each bottle is:

$$\begin{aligned} \text{TIC} &= (\text{mg C in the liquid} + \text{mg C in the headspace}) && \text{Equation [1]} \\ &= (V_L \times C_L) + (V_H \times C_H) \end{aligned}$$

where:

V_L = volume of liquid in the bottle (litre);

C_L = concentration of IC in the liquid (mg/l as carbon);

V_H = volume of the headspace (litre);

C_H = concentration of IC in the headspace (mg/l as carbon).

The calculations of TIC for the two analytical methods used for measuring IC in this test are described below in paragraphs 60 and 61. Percentage biodegradation (% D) in each case is given by:

$$\%D = \frac{(\text{TIC}_t - \text{TIC}_b)}{\text{TOC}} \times 100 \quad \text{Equation [2]}$$

where:

TIC_t = mg TIC in test bottle at time t;

TIC_b = mean mg TIC in blank bottles at time t;

TOC = mg TOC added initially to the test vessel.

The percentage biodegradation % D is calculated for the test (F_T), reference (F_C) and, if included inhibition monitoring control (F_I) bottles from the respective amounts of TIC produced up to each sampling time.

59. If there has been a significant increase in the TIC content of the sterile controls (F_S) over the test period, then it may be concluded that abiotic degradation of the test chemical has occurred and this must be taken into account in the calculation of D in Equation [2].

Acidification to pH < 3

60. Since acidification to pH < 3 and equilibration results in the equalisation of the concentration of TIC in the liquid and gaseous phases, only the concentration of IC in the gas phase needs to be measured. Thus, from Equation [1] TIC = (V_L + V_H) × C_H = V_B × C_H, where V_B = volume of the serum bottle.

Conversion of CO₂ to carbonate

61. In this method calculations are performed as in Equation [1], but the negligible amount of IC in the gaseous phase is ignored, that is V_H × C_H = 0, and TIC = V_L × C_L.

▼ M4**Expression of Results**

62. A biodegradation curve is obtained by plotting percentage biodegradation, D , against time of incubation and if possible, the lag phase, biodegradation phase, 10-d window and plateau phase, that is the phase in which the maximal degradation has been reached and the biodegradation curve has levelled out, are indicated. If comparable results are obtained for parallel test vessels F_T (< 20 % difference), a mean curve is plotted (see Appendix 2, Fig.1); if not, curves are plotted for each vessel. The mean value of the percentage biodegradation in the plateau phase is determined or the highest value is assessed (e.g. when the curve decreases in the plateau phase), but it is important to assess that in the latter case the value is not an outlier. Indicate this maximum level of biodegradation as 'degree of biodegradation of the test chemical' in the test report. If the number of test vessels was insufficient to indicate a plateau phase, the measured data of the last day of the test are used to calculate a mean value. This last value, the mean of five replicates, serves to indicate the precision with which the percentage biodegradation was determined. Also report the value obtained at the end of the 10-d window.
63. In the same way, a curve for the reference chemical, F_C , is plotted and, if included, for the abiotic elimination check, F_S and the inhibition control, F_I .
64. The amounts of TIC present in the blank controls (F_B) are recorded as are those in flasks F_S (abiotic check), if these vessels were included in the test.
65. Calculate D for the F_I vessels, based on the theoretical IC yield anticipated from only the reference component of the mixture. If, at day 28, $[(D_{FC}^{(1)} - D_{FI}^{(2)})/D_{FC}] \times 100 > 25 \%$, it may be assumed that the test chemical inhibited the activity of the inoculum, and this may account for low values of D_{FI} obtained under the conditions of the test. In this case the test could be repeated using a lower test concentration and preferably reducing the DIC in the inoculum and TIC formed in the blank controls, since the lower concentration will otherwise reduce the precision of the method. Alternatively, another inoculum may be used. If in flask F_S (abiotic) a significant increase (> 10 %) in the amount of TIC is observed, abiotic degradation processes may have occurred.

Validity of results**▼ M7**

66. A test is considered valid if:
- (a) the mean percentage degradation in vessels F_C containing the reference chemical is > 60 % by the 14th day of incubation; and
 - (b) the mean amount of TIC present in the blank controls F_B at the end of the test is < 3mg C/l.

If these limits are not met, the test should be repeated with an inoculum from another source and/or the procedures used should be reviewed. For example, if high blank IC production is a problem the procedure given in paragraphs 27 to 32 should be followed.

⁽¹⁾ The percentage degradation in Vessels F_C containing the reference substance.

⁽²⁾ The percentage degradation in Vessels F_I .

▼ M4

67. If the test chemical does not reach 60 % ThIC and was shown not to be inhibitory (paragraph 65), the test could be repeated with increased concentration of inoculum (up to 30 mg/l activated sludge and 100 ml effluent/l) or inocula from other sources, especially if degradation had been in the range 20 to 60 %.

Interpretation of results

68. Biodegradation > 60 % ThIC within the 10-d window in this test demonstrates that the test chemical is readily biodegradable under aerobic conditions.
69. If the pass value of 60 % ThIC is not attained, determine the pH value in media in bottles which have not been made acid or alkaline; a value of less than 6,5 could indicate that nitrification had occurred. In such a case repeat the test with a buffer solution of higher concentration.

Test Report

70. Compile a table of % D for each test (F_T), reference (F_C) and, if included, inhibition control bottle (F_I) for each day sampled. If comparable results are obtained for replicate bottles, plot a curve of mean % D against time. Record the amount of TIC in the blanks (F_B) and in the sterile controls (F_S) DOC and/or other determinands, and their percentage removal.
71. Determine the mean value of % D in the plateau phase, or use the highest value if the biodegradation curve decreases in the plateau phase, and report this as the 'degree of biodegradation of the test chemical'. It is important to ensure that in the latter case the highest value is not an outlier.
72. The test report must include the following information:

Test chemical:

- common name, chemical name, CAS number, structural formula and relevant physical-chemical properties;
- purity (impurities) of test chemical.

Test conditions:

- reference to this Test Method;
- description of the test system used (e.g. volume of the vessel, head space to liquid ratio, method of stirring, etc.);
- application of test chemical and reference chemical to test system: test concentration used and amount of carbon dosed into each test bottle, any use of solvents;
- details of the inoculum used, any pre-treatment and pre-conditioning;
- incubation temperature;
- validation of the principle of IC analysis;
- main characteristics of the IC analyser employed (and any other analytical methods used);
- number of replicates.

Results:

- raw data and calculated values of biodegradability in tabular form;

▼M4

- the graph of percentage degradation against time for the test and reference chemicals, the lag phase, degradation phase, 10-d window and slope;
- percentage removal at plateau, at end of test, and after 10-d window;
- reasons for any rejection of the test results;
- any other facts that are relevant to the procedure followed;
- discussion of results.

LITERATURE:

- (1) Chapter C.4 of this Annex Determination of 'Ready' Biodegradability — CO₂ Evolution Test (Method C.4-C).
- (2) Sturm RN (1973). Biodegradability of Nonionic surfactants: screening test for predicting rate and ultimate biodegradation. *J.A., Oil Chem Soc.* 50: 159-167.
- (3) Larson RJ (1979). Estimation of biodegradation potential of xenobiotic organic chemicals. *Appl Env. Microbiol.* 38: 1153-1161.
- (4) Larson RJ, Hansmann MA and Bookland EA (1996). Carbon dioxide recovery in ready biodegradability tests: mass transfer and kinetic constants, *Chemosphere* 33: 1195-1210.
- (5) ISO 9439 (1990; revised 1999). Water Quality — Evaluation of ultimate aerobic biodegradability of organic compounds in aqueous medium — Carbon dioxide evolution Test (Sturm).
- (6) US EPA (1996). Fate, Transport and Transformation Test Guideline. 835.3110 Carbon dioxide evolution test. Office, Prevention Pesticides and Toxic Substances Washington, DC.
- (7) US EPA (1996). Fate, Transport and Transformation Test Guideline. 835.3100. Aerobic aquatic biodegradation. Office, Prevention Pesticides and Toxic Substances Washington, DC.
- (8) Gledhill WE (1975). Screening test for assessment of biodegradability: Linear alkyl benzene sulfonate. *Appl Microbiol.* 30: 922-929.
- (9) Weytjens D, Van Ginneken I and Painter HA (1994). The recovery of carbon dioxide in the Sturm test for ready biodegradability. *Chemosphere* 28: 801-812.
- (10) Ennis DM and Kramer A (1975). A rapid microtechnique for testing biodegradability of nylons and polyamides. *J. Food Sci.* 40: 181-185.
- (11) Ennis DM, Kramer A, Jameson CW, Mazzoccki PH and Bailey PH (1978). *Appl. Env. Microbiol.* 35: 51-53.
- (12) Boatman RJ, Cunningham SL and Ziegler DA (1986). A method for measuring the biodegradation of organic chemicals, *Env. Toxicol. Chem.* 5: 233-243.
- (13) Struijs J and Stoltenkamp J (1990). Head space determination of evolved carbon dioxide in a biodegradability screening test. *Ecotox. Env. Safety* 19: 204-211.
- (14) Birch RR and Fletcher RJ (1991). The application of dissolved inorganic carbon measurements to the study of aerobic biodegradability. *Chemosphere* 23: 507-524.
- (15) Birch RR, Biver C, Campagna R, Gledhill WE, Pagga U, Steber J, Reust H, and Bontinck WJ (1989). Screening of chemicals for anaerobic biodegradation. *Chemosphere* 19: 1527-1550.

▼ M4

- (16) ISO 14593, (1999) Water Quality — Evaluation of ultimate aerobic biodegradability of organic compounds in an aerobic medium-method by analysis of inorganic carbon in sealed vessels (CO₂ headspace test).
- (17) Battersby NS (1997). The ISO headspace CO₂ biodegradation test, Chemosphere 34: 1813-1822.
- (18) US EPA (1996). Fate, Transport and Transportation. 835.3120. Sealed vessel carbon dioxide production test. Office, Prevention Pesticides and Toxic Substance, Washington, DC.
- (19) Battersby NS, Ciccognani D, Evans MR, King D, Painter HA, Peterson DR and Starkey M (1999). An 'inherent' biodegradability test for oil products: description and results of an international ring test. Chemosphere 38: 3219-3235.
- (20) Chapter C.4 of this Annex, Determination of 'Ready' Biodegradability.
- (21) OECD (1988). OECD Ring-test of methods for determining ready biodegradability: Chairman's report (M. Hashimoto; MITI) and final report (M. Kitano and M. Takatsuki; CITI). Paris.
- (22) Chapter C.11 of this Annex, Activated sludge respiration inhibition test.
- (23) Struijs J, Stoltenkamp-Wouterse MJ and Dekkers ALM (1995). A rationale for the appropriate amount of inoculum in ready biodegradability tests. Biodegradation 6: 319-327.
- (24) EU (1999). Ring-test of the ISO Headspace CO₂ method: application to surfactants: Surfactant Ring Test-1, Report EU4697, Water Research Centre, May 1999, Medmenham, SL7 2HD, UK.
- (25) ISO 10634 (1996) Water Quality — Guidance for the preparation and treatment of poorly water-soluble organic compounds for the subsequent evaluation of their biodegradability in an aqueous medium.

▼ M4*Appendix 1*

ABBREVIATIONS AND DEFINITIONS

IC: Inorganic carbon

ThCO₂: Theoretical carbon dioxide (mg) is the quantity of carbon dioxide calculated to be produced from the known or measured carbon content of the test chemical when fully mineralised; also expressed as mg carbon dioxide evolved per mg test chemical.

DOC: Dissolved organic carbon is the organic carbon present in solution or that which passes through a 0,45 micrometre filter or remains in the supernatant after centrifuging at approx. 4 000 g (about 40 000 m sec⁻²) for 15 min.

DIC: Dissolved inorganic carbon

ThIC: Theoretical inorganic carbon

TIC: Total inorganic carbon

Readily biodegradable: An arbitrary classification of chemicals which have passed certain specified screening tests for ultimate biodegradability; these tests are so stringent that it is assumed that such chemicals will rapidly and completely biodegrade in aquatic environments under aerobic conditions.

10-d window: The 10 days immediately following the attainment of 10 % biodegradation.

Inherent biodegradability: A classification of chemicals for which there is unequivocal evidence of biodegradation (primary or ultimate) in any test of biodegradability.

Ultimate aerobic biodegradation: The level of degradation achieved when the test chemical is totally utilised by micro-organisms resulting in the production of carbon dioxide, water, mineral salts and new microbial cellular constituents (biomass).

Mineralisation: Mineralisation is the complete degradation of an organic chemical to CO₂ and H₂O under aerobic conditions, and CH₄, CO₂ and H₂O under anaerobic conditions.

Lag phase: The time from the start of a test until acclimatization and/or adaptation of the degrading microorganisms is achieved and the biodegradation degree of a test chemical or organic matter has increased to a detectable level (e.g. 10 % of the maximum theoretical biodegradation, or lower, dependent on the accuracy of the measuring technique).

Degradation phase: The time from the end of the lag period to the time when 90 % of the maximum level of degradation has been reached.

Plateau phase: Plateau phase is the phase in which the maximal degradation has been reached and the biodegradation curve has levelled out.

Test chemical: Any substance or mixture tested using this Test Method.

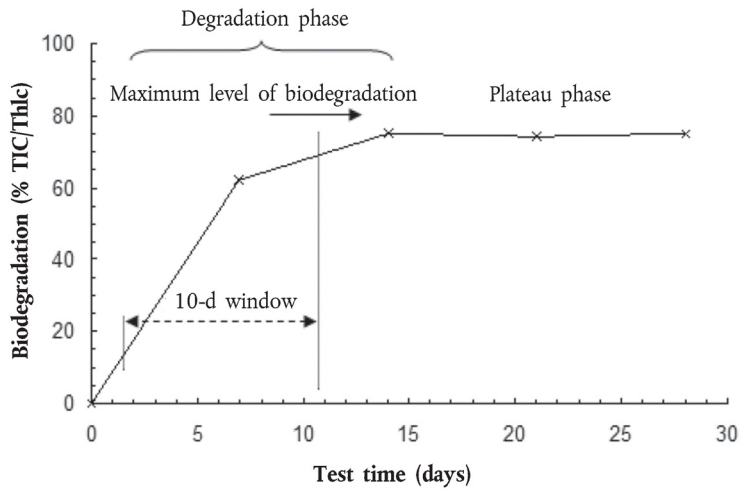
▼ **M4***Appendix 2***Example of a biodegradation curve***Figure 1***Biodegradation of 1-octanol in the CO₂ headspace test**

Glossary

Biodegradation:

Degradation phase:

Maximum level of biodegradation:

Plateau phase:

10-d(ay) window:

Test time (days):

▼ **M4****C. 30. BIOACCUMULATION IN TERRESTRIAL OLIGOCHAETES**

INTRODUCTION

1. This Test Method is equivalent to OECD Test Guideline (TG) 317 (2010). Among the Test Methods relating to environmental fate, the Bioconcentration: Flow-through Fish Test (chapter C.13 of this Annex (49)) and the Bioaccumulation in Sediment-dwelling Benthic Oligochaetes (53) were published in 1996 and 2008 respectively. The extrapolation of aquatic bioaccumulation data to terrestrial organisms like earthworms is difficult, if possible at all. Model calculations based on a test chemical's lipophilicity, e.g. (14) (37), are currently used for the assessment of bioaccumulation of chemicals in soil, as e.g. in the EU Technical Guidance Document (19). The need for a compartment-specific test method has already been addressed, e.g. (55). Such a method is especially important for the evaluation of secondary poisoning in terrestrial food chains (4). Several national test methods address the issue of bioaccumulation in organisms other than fish e.g. (2) and (72). A method on the measurement of bioaccumulation from contaminated soils in earthworms (*Eisenia fetida*, Savigny) and potworms has been developed by the American Society for Testing and Materials (3). An internationally accepted method for the determination of bioaccumulation in spiked soil will improve the risk assessment of chemicals in terrestrial ecosystems e.g. (25) (29).

2. Soil-ingesting invertebrates are exposed to soil bound chemicals. Among these animals, terrestrial oligochaetes play an important role in the structure and function of soils (15) (20). Terrestrial oligochaetes live in soil and partly at the soil surface (especially the litter layer); they frequently represent the most abundant species in terms of biomass (54). By bioturbation of the soil and by serving as prey these animals can have a strong influence on the bioavailability of chemicals to other organisms like invertebrates (e.g. predatory mites and beetles; e.g. (64)) or vertebrate (e.g. foxes and gulls) predators (18) (62). Some species of terrestrial oligochaetes currently used in ecotoxicological testing are described in Appendix 5.

3. The ASTM Standard Guide for Conducting Laboratory Soil Toxicity or Bioaccumulation Tests with the Lumbricid Earthworm *Eisenia fetida* and the Enchytraeid Potworm *Enchytraeus albidus* (3) provides many essential and useful details for the performance of the present soil bioaccumulation Test Method. Further documents that are referred to in this Test Method are chapter C.13 of this Annex, Bioconcentration: Flow-through Fish Test (49) and OECD TG 315: Bioaccumulation in Sediment-dwelling Benthic Oligochaetes (53). Practical experience with soil bioaccumulation studies and publications from LITERATURE e.g. (1) (5) (11) (12) (28) (40) (43) (45) (57) (59) (76) (78) (79) are also major sources of information for this Test Method.

4. This Test Method is mostly applicable to stable, neutral organic chemicals, which tend to adsorb to soils. Testing for bioaccumulation of soil-associating, stable metallo-organic compounds may be possible with this Test Method. It is also applicable to metals and other trace elements.

PRE-REQUISITE

5. Tests for measuring the bioaccumulation of a chemical in terrestrial oligochaetes have been performed with heavy metals (see e.g. (63)) and persistent, organic chemicals having log K_{ow} values between 3,0 and 6,0, e.g. (40). Such tests also apply to:

— Chemicals that show a log K_{ow} of more than 6,0 (super-hydrophobic chemicals);

▼M4

- Chemicals which belong to a class of organic chemicals known to have the potential to bioaccumulate in living organisms, e.g. surface active or highly adsorptive chemicals;
 - Chemicals that indicate the potential for bioaccumulation from structural features, e.g. analogues of chemicals with known bioaccumulation potential; and
 - Metals.
6. Information on the test chemical such as common name, chemical name (preferably IUPAC name), structural formula, CAS registry number, purity, safety precautions, proper storage conditions and analytical methods should be obtained before beginning the study. In addition, the following information should be known:
- (a) solubility in water;
 - (b) octanol-water partition coefficient, K_{ow} ;
 - (c) soil-water partition coefficient, expressed as K_{oc} ;
 - (d) vapour pressure;
 - (e) degradability (e.g. in soil, water);
 - (f) known metabolites.
7. Radiolabelled or non-radiolabelled test chemicals can be used. However, to facilitate analysis it is recommended to use a radiolabelled test chemical. The decision will be made based on the detection limits or a requirement to measure parent test chemical and metabolites. If a radiolabelled test chemical is used and total radioactive residues are measured, it is important that the radiolabelled residues in both the soil and the test organisms are characterised for percentages of parent test chemical and labelled non-parent, e.g. in samples taken at steady state or at the end of the uptake phase, to allow a bioaccumulation factor (BAF) calculation for the parent test chemical and for the soil metabolites of concern (see paragraph 50). The method described here may have to be modified, e.g. to provide sufficient biomass, for measuring non-radiolabelled organic test chemical or metals. When total radioactive residues are measured (by liquid scintillation counting following extraction, combustion or tissue solubilisation), the bioaccumulation factor is based on the parent test chemical and metabolites. The BAF calculation should preferably be based on the concentration of the parent test chemical in the organisms and total radioactive residues. Subsequently, the biota-soil accumulation factor (BSAF), normalized to the lipid content of worm and organic carbon content (OC) of soil should be calculated from the BAF for reasons of comparability between results from different bioaccumulation tests.
8. Toxicity of the test chemical to the species used in the test should be known, e.g. an effect concentration (EC_x) or lethal concentration (LC_x) for the time of the uptake phase (e.g. (19)). The selected concentration of the test chemical should preferably be about 1 % of its acute asymptotic LC₅₀, and at least 10-fold higher than its detection limit in soil by the analytical method used. If available, preference should be given to toxicity values derived from long-term studies on sublethal endpoints (51) (52). If such data are not available, an acute toxicity test will provide useful information (see e.g. (23)).

▼M4

9. An appropriate analytical method of known accuracy, precision, and sensitivity for the quantification of the chemical in the test solutions, in the soil, and in the biological material should be available, together with details of sample preparation and storage as well as material safety data sheets. Analytical detection limits of the test item in soil and worm tissue should also be known. If a ¹⁴C-labelled test chemical is used, the specific radioactivity (i.e. Bq mol⁻¹) and the percentage of radioactivity associated with impurities should be known. The specific radioactivity of the test chemical should be high enough to facilitate analysis, and the test concentrations used should not elicit toxic effects.

10. The test can be performed with an artificial soil or with natural soils. Information on characteristics of the natural soil used, e.g. origin of soil or its constituents, pH, organic carbon content, particle size distribution (percent sand, silt, and clay), and water holding capacity (WHC), should be known before the start of the test (3) (48).

PRINCIPLE OF THE TEST

11. The parameters which characterise the bioaccumulation of a test chemical include the bioaccumulation factor (BAF), the uptake rate constant (k_u) and the elimination rate constant (k_e). Definitions are provided in Appendix 1.

12. The test consists of two phases: the uptake (exposure) phase and the elimination (post-exposure) phase. During the uptake phase, replicated groups of worms are exposed to soil, which has been spiked with the test chemical. In addition to the test animals, groups of control worms are held under identical conditions without the test chemical. The dry weight and lipid content of the test organisms are measured. This can be done using worms of the control group. Analytical background values (blank) can be obtained by analysing samples of the control worms and soil. For the elimination phase, the worms are transferred to a soil free of the test chemical. An elimination phase is always required unless uptake of the test chemical during the exposure phase has been insignificant. An elimination phase provides information on the rate at which the test chemical is excreted by the test organisms (e.g. (27)). If a steady state has not been reached during the uptake phase, the determination of the kinetic parameters – kinetic bioaccumulation factor BAF_k, uptake and elimination rate constant(s) – should preferably be based on simultaneous fitting of the results of the uptake and elimination phases. The concentration of the test chemical in/on the worms is monitored throughout both phases of the test.

13. During the uptake phase, measurements are made at sampling times up to 14 days (enchytraeids) or 21 days (earthworms) until the steady state is reached (11) (12) (67). The steady state occurs when a plot of the concentration in worms against time is parallel to the time axis, and three successive concentration analyses made on samples taken at intervals of at least two days do not vary more than ± 20 % of each other based on statistical comparisons (e.g. analysis of variance, regression analysis).

14. The elimination phase consists of transferring the test organisms to vessels containing the same substrate without the test chemical. During the elimination phase, measurements are made at sampling times during 14 days (enchytraeids) or 21 days (earthworms) unless earlier analytical determination showed 90 % reduction of the test chemical residues in worms. The concentration of the test chemical in the worms at the end of the elimination phase is reported as non-eliminated residues. The steady state

▼ **M4**

bioaccumulation factor (BAFs) is calculated preferably both as the ratio of the concentration in worms (Ca) and in the soil (Cs) at apparent steady state, and as a kinetic bioaccumulation factor, BAFK, as the ratio of the rate constant of uptake from soil (ks) and the elimination rate constant (ke) (see Appendix 1 for definitions) assuming first-order kinetics (see Appendix 2 for calculations). If first-order kinetics is obviously not applicable, other models should be employed.

15. The uptake rate constant, the elimination rate constant (or constants, where other models are involved), the kinetic bioaccumulation factor (BAFK), and where possible, the confidence limits of each of these parameters are calculated from computerised model equations (see Appendix 2 for guidance). The goodness of fit of any model can be determined from e.g. the correlation coefficient or the coefficient of determination (coefficients close to one indicate a good fit) or chi-squared. Also the size of the standard error or confidence limit around the estimated parameters may be indicative of the goodness of fit of the model.

16. To reduce variability in test results for test chemicals with high lipophilicity, bioaccumulation factors should be expressed in relation to lipid content and organic carbon content (kg soil organic carbon (OC) kg⁻¹ worm lipid content). This approach is based on the fact that for some chemical classes, there is a clear relationship between the potential for bioaccumulation and lipophilicity; this has been well established for fish (47). There is a relationship between the lipid content of fish and the bioaccumulation of such chemicals. For benthic organisms, similar correlations have been found e.g. (30) (44). Likewise for terrestrial oligochaetes this correlation has been demonstrated e.g. (5) (6) (7) (14). If sufficient worm tissue is available, the lipid content of the test animals can be determined on the same biological material as the one used to determine the concentration of the test chemical. Alternatively, control animals can be used to measure the lipid content.

VALIDITY OF THE TEST

17. For a test to be valid the following criteria should be fulfilled for both controls and treatments:
 - At the end of the test, the overall mortality during uptake and elimination phase should not exceed 10 % (earthworms) or 20 % (enchytraeids) of the total number of the introduced worms.

 - For *Eisenia fetida* and *Eisenia andrei*, the mean mass loss as measured at the end of the uptake and at the end of the elimination phase should not exceed 20 % compared to the initial fresh weight (f.w.) at start of each phase.

DESCRIPTION OF THE METHOD

Test species

18. Several species of terrestrial oligochaetes are recommended for bioaccumulation testing. The most commonly used species *Eisenia fetida* or *Eisenia andrei* (Lumbricidae), or *Enchytraeus albidus*, *Enchytraeus crypticus*, or *Enchytraeus luxuriosus* (Enchytraeidae) are described in Appendix 5.

▼ M4**Apparatus**

19. Care should be taken to avoid the use of materials, for all parts of the equipment, which can dissolve, adsorb the test chemical or leach other chemicals, and have an adverse effect on the test animals. Standard rectangular or cylindrical vessels, made of chemically inert material and of suitable capacity can be used in compliance with the loading rate, i.e. the number of test worms. Stainless steel, plastic or glass may be used for any equipment having contact with the test media. The test vessels should be appropriately covered to prevent escaping of the worms, while allowing sufficient air supply. For chemicals with high adsorption coefficients, such as synthetic pyrethroids, silanised glass may be required. In these situations the equipment will have to be discarded after use (49). Radiolabelled test items and volatile chemicals should be prevented from escaping. Traps (e.g. glass gas washing bottles) should be employed containing suitable absorbents to retain any residues evaporating from the test vessels.

Soil

20. The test soil should be of a quality that will allow the survival and preferably the reproduction of the test organisms for the duration of the acclimation and test periods without them showing any abnormal appearance or behaviour. The worms should burrow in the soil.
21. The artificial soil described in the chapter C.8 of this Annex (48) is recommended for use as the substrate in the tests. Preparation of the artificial soil for use in the bioaccumulation tests and recommendations for the storage of artificial soil are given in Appendix 4. Air-dried artificial soil may be stored at room temperature until use.
22. However, natural soils from unpolluted sites may serve as test and/or culture soil. Natural soils should be characterised at least by origin (collection site), pH, organic carbon content, particle size distribution (percent sand, silt, and clay), maximum water holding capacity (WHC_{max}), and percent water content (3). Analysis of the soil or its constituents for micro-pollutants prior to use should provide useful information. If field soil from agricultural land is used, it should not have been treated with crop protection products or with manure from treated animals as fertilizers for at least one year and with organic fertilizers for at least six months prior to sampling (50). Manipulation procedures for natural soils prior to use in ecotoxicological tests with oligochaetes in the laboratory are described in (3). For natural soils the storage time in the laboratory should be kept as short as possible.

Application of the test chemical

23. The test chemical is incorporated into the soil. The physicochemical properties of the test chemical should be taken into consideration. A water-soluble test chemical should be completely dissolved in water before it be mixed with the soil. The recommended spiking procedure for poorly water-soluble test chemical involves coating of one or more of the (artificial) soil constituents with the test chemical. For example, the quartz sand, or a portion thereof, can be soaked with a solution of the test chemical in a suitable organic solvent, which is then slowly evaporated to dryness. The coated fraction can then be mixed into the wet soil. The major advantage of this procedure is that no solvent is introduced into the soil. When a natural soil is used, the test chemical may be added by spiking an air-dried portion

▼ M4

of the soil as described above for the artificial soil, or by stirring the test chemical into the wet soil, with subsequent evaporating step if a solubilising agent is used. In general, the contact of wet soil with solvents should be avoided as far as possible. The following should be considered (3):

- If a solvent other than water is used, it should be one that is water-miscible and/or can be driven off (for example, evaporated), leaving only the test chemical on the soil.
 - If a solvent control is used, there is no need for negative control. The solvent control should contain the highest concentration of solvent added to the soil and should use solvent from the same batch used to make the stock solution. Toxicity and volatility of the solvent, and solubility of the test chemical in the chosen solvent should be the main criteria used for the selection of a suitable solubilising agent.
24. For chemicals that are poorly soluble in water and in organic solvents, 2,0-2,5 g of finely ground quartz sand per test vessel can be mixed with the quantity of test chemical, e.g. using mortar and pestle, to obtain the desired test concentration. This mixture of quartz sand and test chemical is added to the pre-moistened soil and thoroughly mixed with an appropriate amount of de-ionised water to obtain the required moisture content. The final mixture is distributed to the test vessels. The procedure is repeated for each test concentration, and an appropriate control with 2,0-2,5 g of finely ground quartz sand per test vessel is also prepared.
 25. The concentration of the test chemical in the soil should be determined after spiking. The homogenous distribution of the test chemical into the soil should be verified before introducing the test organisms. The method used for spiking, and the reasons for choosing a specific spiking procedure should be reported (24).
 26. Equilibrium between the soil and the pore-water phase should ideally be established before adding the organisms; a time period of four days at 20 °C is recommended. For many poorly water-soluble organic chemicals the time required to reach a true equilibrium between adsorbed and dissolved fractions can be counted in days or months. Depending on the purpose of the study, for example when the environmental conditions are to be mimicked, the spiked soil may be 'aged' for a longer period, e.g. for metals three weeks at 20 °C (22).

Culturing of the test organisms

27. Worms should be preferably kept in permanent laboratory culture. Guidance on laboratory culture methods for *Eisenia fetida* and *Eisenia andrei*, and Enchytraeid species, is provided in Appendix 5 (see also (48) (51) (52)).
28. The worms used in the tests should be free from observable diseases, abnormalities and parasites.

PERFORMANCE OF THE TEST

29. The test organisms are exposed to the test chemical during the uptake phase. The uptake phase should be of 14 days (enchytraeids) or 21 days (earthworms) unless it is demonstrated that steady state has been reached.

▼ M4

30. For the elimination phase, the worms are transferred to a soil free of test chemical. The first sample should be taken at 4-24 h after the start of elimination phase. Examples of sampling schedules for a 21-day uptake phase and a 21-day elimination phase are given in Appendix 3.

Test organisms

31. For many species of terrestrial enchytraeids the individual weight is very low (e.g. 5-10 mg wet weight per individual for *Enchytraeus albidus* and less for *Enchytraeus crypticus* or *Enchytraeus luxuriosus*); in order to perform the weight measurements and chemical analysis, it may be necessary to pool the worms of the replicate test vessels (i.e. all the worms of a replicate vessel will be used for obtaining one analytical tissue result). 20 individual enchytraeids are added to each replicate, and at least three replicates should be used. If the analytical detection limit of the test chemical is high, more worms may be necessary. For test species with higher individual weight (*Eisenia fetida* and *Eisenia andrei*), replicate vessels containing one individual can be used.
32. The earthworms used in a test should be of similar weight (e.g. *Eisenia fetida* and *Eisenia andrei* should have an individual weight of 250-600 mg). Enchytraeids (e.g. *Enchytraeus albidus*) should have a length of approximately 1 cm. All worms used in a particular test should come from the same source, and should be adult animals with clitellum (see Appendix 5). Since the weight and age of an animal might have an effect on the BAF-values (e.g. due to varying lipid content and/or presence of eggs), these parameters should be recorded accurately and taken into account in the interpretation of results. In addition, cocoons can be deposited during the exposure period, which will also have an impact on the BAF values. It is recommended that a sub-sample of the test worms be weighed before the test in order to estimate the mean wet and dry weights.
33. A high soil-to-worm ratio should be used in order to minimise the decrease of the test chemical concentration in the soil during the uptake phase. For *Eisenia fetida* and *Eisenia andrei* a minimum amount of 50 g dry weight (d.w.) of soil per worm, and for enchytraeids, a minimum of 10-20 g d.w. of soil per test vessel are recommended. The vessels should contain a soil layer of 2-3 cm (enchytraeids) or 4-5 cm (earthworms).
34. The worms used in a test are removed from the culture (e.g. enchytraeids by using jeweller's tweezers). Adult animals are transferred to non-treated test soil for acclimation, and fed (see paragraph 36). If the test conditions differ from the culture conditions, an acclimation phase of 24-72 h should be sufficient to adapt the worms to the test conditions. After acclimation, earthworms are rinsed by transfer to glass dishes (e.g. petri dishes) containing clean water, and subsequently weighed before they are added to the test soil. Prior to weighing, excess water should be removed from the worms by gently touching them against the edge of the dish or by blotting them cautiously dry by using a slightly moistened paper towel.
35. Burrowing behaviour of the test organisms should be observed and recorded. In tests with earthworms, the animals (control and treatments) normally burrow in the soil within a period of a few hours; this should be checked no later than 24 h after addition of the worms to the test vessels. If the earthworms fail to burrow in the soil (e.g. more than 10 % over more than half of the uptake phase), this indicates that either the test conditions are not appropriate or the test organisms are not healthy. In such a case the test

▼ M4

should be stopped and repeated. Enchytraeids mainly live in the interstitial pores of the soil, and frequently their integument may be only partly in contact with the surrounding substrate; exposure of burrowing and non-burrowing enchytraeids is assumed to be equivalent and non-burrowing of the enchytraeids does not necessarily require the repetition of the test.

Feeding

36. Feeding should be envisaged when a soil with low total organic carbon content is used. When an artificial soil is used, a weekly feeding rate (i.e. the worms should be fed once a week) of 7 mg of dried dung per g soil dry weight is recommended for earthworms, and a weekly rate of 2-2,5 mg of ground oat flakes per g soil dry weight is recommended for enchytraeids (11). The first food ration should be mixed with the soil immediately before the test organisms are added. Preferably the same type of food like in the cultures should be used (see Appendix 5).

Light and temperature

37. The tests should be carried out under a controlled 16/8 hours light/dark cycle, preferably 400 to 800 lx in the area of the test vessels (3). The test temperature should be 20 ± 2 °C throughout the test.

Test concentrations

38. A single concentration is used. Situations where additional concentration(s) is(are) required should be justified. If toxicity (EC_x) of the test chemical is close to the analytical detection limit, the use of radiolabelled test chemical with high specific radioactivity is recommended. For metals, the concentration should be above the background level in tissue and soil.

Replicates

39. For the kinetic measurements (uptake and elimination phase), the minimum number of treated replicate vessels should be three per sampling point. The total number of replicates prepared should be sufficient to cover all sampling times during the uptake and the elimination phase.

40. For the biological observations and measurements (e.g. dry-to-wet weight ratio, lipid content) and for the analysis of background concentrations in worms and soil, at least 12 replicate vessels of a negative control (four sampled at start, four at end of uptake, and four at end of elimination) should be provided if no solvent other than water is used. If any solubilising agent is used for application of the test chemical, a solvent control (four replicate vessels should be sampled at start, four at the end of the uptake phase, and four at the end of the elimination phase) containing all constituents except for test item should be run in addition to the treated replicates. In this case, four additional replicate vessels of a negative control (no solvent) may also be provided for optional sampling at the end of the uptake phase. These replicates can be compared biologically with the solvent control in order to gain information on a possible influence of the solvent on the test organisms. It is recommended establishing a sufficient number of additional reserve replicate vessels (e.g. eight) for treatment and control(s).

▼M4**Frequency of soil quality measurements**

41. Soil pH, soil moisture content and the temperature (continuously) in the test room should be measured at the start and end of the uptake and elimination phases. Once per week the soil moisture content should be controlled by weighing the test vessels and comparing actual weights with initial weights at test start. Water losses should be compensated by adding deionised water.

Sampling and analysis of worms and soil

42. An example of schedule for the uptake and elimination phases in earthworm and enchytraeid bioaccumulation tests is given in Appendix 3.
43. The soil is sampled from the test vessels for the determination of test chemical concentration before inserting the worms, and during the uptake and elimination phases. During the test the concentrations of test chemical are determined in the worms and the soil. In general, total soil concentrations are measured. As an option, concentrations in pore water may be measured; in such case, rationale and appropriate methods should be provided prior to initiation of a study, and included in the report.
44. The worms and soil are sampled at least at six occasions during the uptake and the elimination phases. If the stability of a test chemical is demonstrated, the number of soil analyses can be reduced. It is recommended analysing at least three replicates at the beginning and at the end of the uptake phase. If the concentration in soil measured at the end of the uptake phase deviates from the initial concentration by more than 30 %, the soil samples taken at other dates should also be analysed.
45. Remove the worms of a given replicate from the soil at each sampling time (e.g. after spreading the soil of the replicate on a shallow tray and picking the worms using soft jewellers' tweezers), rinse them quickly with water in a shallow glass or steel tray. Remove excess water (see paragraph 34). Transfer the worms carefully to a pre-weighed vessel, weigh them instantly, including gut content.
46. The earthworms (*Eisenia* sp.) should then be allowed to purge their gut overnight e.g. on a moist filter paper in a covered petri dish (see paragraph 34). After purging, the weight of the worms should be determined in order to assess a possible decrease in biomass during the test (see validity criteria in paragraph 17). Weighing and tissue analysis of Enchytraeids is carried out without purging, as this is technically difficult due to the small size of these worms. After final weight determination, the worms should be killed immediately, using the most appropriate method (e.g. using liquid nitrogen, or freezing at temperatures below – 18 °C).
47. During the elimination phase, the worms replace contaminated gut contents with clean soil. This means, measurements in un-purged worms (enchytraeids in this context) sampled immediately before the elimination phase include contaminated gut soil. For aquatic oligochaetes it is assumed that after the initial 4-24 h of the elimination phase, most of the contaminated gut content has been replaced by clean sediment e.g. (46). Similar findings have been reported for earthworms in studies on the accumulation of radiolabelled cadmium and zinc (78). In the non-purged enchytraeids, the concentration of this first sample of the elimination phase may be considered as the tissue concentration after gut purge. To account for dilution of the test item concentration by uncontaminated soil during the elimination phase, the weight of the gut content may be estimated from worm wet weight/worm ash weight or worm dry weight/worm ash weight ratios.

▼ M4

48. The soil and worm samples should be preferably analysed immediately after removal (i.e. within 1-2 days) in order to prevent degradation or other losses, and it is recommended calculating the approximate uptake and elimination rates as the test proceeds. If the analysis is delayed, the samples should be stored by an appropriate method, e.g. by deep-freezing (≤ -18 °C).

49. It should be checked that the precision and reproducibility of the chemical analysis, as well as the recovery of the test chemical from soil and worm samples are satisfactory for the given method; the extraction efficiency, the limit of detection (LOD) and the limit of quantification (LOQ) should be reported. Likewise it should be checked that the test chemical is not detectable in the control vessels in concentrations higher than background. When the concentration of the test chemical in the test organism C_a is > 0 in the control worms, this should be included in the calculation of the kinetic parameters (see Appendix 2). All samples should be handled throughout the test to minimise contamination and loss (e.g. resulting from adsorption of the test chemical on the sampling device).

50. When working with radiolabelled test chemicals, it is possible to analyse parent and metabolites. Quantification of parent test chemical and metabolites at steady state or at the end of the uptake phase provides important information. The samples should then be 'cleaned up' so that the parent test chemical can be quantified separately. If single metabolites exceed 10 % of total radioactivity in the analysed sample(s), the identification of these metabolites is recommended.

51. The overall recovery, and the recovery of test chemical in worms, soil, and if used, in traps containing absorbents to retain evaporated test chemical, should be recorded and reported.

52. Pooling of the individuals sampled from a given test vessel is acceptable for enchytraeid worms which are smaller than earthworms. If pooling involves the reduction of the number of replicates, this limits the statistical procedures which can be applied to the data. If a specific statistical procedure and power are required, then an adequate number of replicate test vessels should be included in the test to accommodate the desired pooling, procedure and power.

53. It is recommended that the BAF be expressed both as a function of total dry weight and, when required (i.e. for highly hydrophobic chemicals), as a function of the lipid content. Suitable methods should be used for determination of lipid content (some existing methods – e.g. (31) (58) – should be adapted for this purpose). These methods use a chloroform/methanol extraction technique. However, to avoid the use of chlorinated solvents, a modification of the Bligh and Dyer method (9) as described in (17) should be used. Since the various methods may not give identical values, it is important to give details of the method used. When possible, i.e. if sufficient worm tissue is available, the lipid analysis should ideally be made on the same sample or extract as the one used for analysis of the test chemical, since the lipids often have to be removed from the extract before it can be analysed chromatographically (49). Alternatively, control animals may be used to measure the lipid content, which can then be used to normalise BAF values. This latter approach reduces the contamination of equipment with the test chemical.

▼ **M4****DATA AND REPORTING****Treatment of results**

54. The uptake curve of the test chemical is obtained by plotting its concentration in/on the worms during the uptake phase against time on arithmetic scales. When the curve has reached a plateau, or steady state (see definitions in Appendix 1), the steady state bioaccumulation factor BAF_{ss} is calculated from:

$$\frac{C_a \text{ at steady state or at end of uptake phase (mean)}}{C_s \text{ at steady state or at end of uptake phase (mean)}}$$

C_a is the concentration of test chemical in the test organism

C_s is the concentration of test chemical in the soil

55. When no steady state is reached, the BAF_K, based on the rate constants, should be determined instead of BAF_{ss}, as described below:

- Determine the accumulation factor (BAF_K) as the ratio k_s/k_e .
- Uptake and elimination rates are preferably calculated simultaneously (see Equation 11 in Appendix 2)
- The elimination rate constant (k_e) is usually determined from the elimination curve (i.e. a plot of the concentration of the test item in the worms during the elimination phase). The uptake rate constant k_s is then calculated given k_e and a value of C_a which is derived from the uptake curve – See Appendix 2 for a description of these methods. The preferred method for obtaining BAF_K and the rate constants, k_s , and k_e , is to use non-linear parameter estimation methods on a computer. If the elimination is obviously not first-order, then more complex models should be employed.

Test report

56. The test report should include the following information:

Test chemical:

- Any available information on acute or long term toxicity (e.g. EC_x, LC_x, NOEC) of the test chemical towards soil-dwelling oligochaetes;
- purity, physical nature and, physicochemical properties e.g. log K_{ow}, water solubility;
- chemical identification data; source of the test item, identity and concentration of any solvent used;
- if radiolabelled test chemical is used, the precise position of the labelled atoms, the specific radioactivity, and the radiochemical purity.

Test species:

- scientific name, strain, source, any pre-treatment, acclimation, age, size-range, etc..

▼ M4*Test conditions:*

- test procedure used;
- type and characteristics of illumination used and photoperiod(s);
- test design (e.g. number and size of test vessels, soil mass and height of soil layer, number of replicates, number of worms per replicate, number of test concentrations, duration of uptake and elimination phases, sampling frequency);
- rationale for the choice of test vessel material;
- method of test item preparation and application as well as reasons for choosing a specific method;
- the nominal test concentrations, the means of the measured values and their standard deviations in the test vessels, and the method by which these values were obtained;
- source of the constituents of the artificial soil or – if natural media are used – origin of the soil, description of any pre-treatment, results of the controls (survival, biomass development, reproduction), soil characteristics (pH, total organic carbon content, particle size distribution (percent sand, silt, and clay), WHC_{max} , percent water content at start and at end of the test, and any other measurements made);
- detailed information on the treatment of soil and worm samples, including details of preparation, storage, spiking procedures, extraction, and analytical procedures (and precision) for the test item in worms and soil, and lipid content (if measured), and recoveries of the test item.

Results:

- mortality of the control worms and the worms in each test vessel and any observed abnormal behaviour (e.g. soil avoidance, lack of reproduction in a bioaccumulation test with enchytraeids);
- the dry weight to wet weight ratio of the soil and the test organisms (useful for normalisation);
- the wet weights of the worms at each sampling time; for earthworms, the wet weights at start of the test, and at each sampling time before and after gut purging;
- the lipid content of the test organisms (if determined);
- curves, showing the uptake and elimination kinetics of the test chemical in the worms, and the time to steady state;
- C_a and C_s (with standard deviation and range, if appropriate) for all sampling times (C_a expressed in $g\ kg^{-1}$ wet and dry weight of whole body, C_s expressed in $g\ kg^{-1}$ wet and dry weight of soil). If a biota-soil accumulation factor (BSAF) is required (e.g. for comparison of results from two or more tests performed with animals of differing lipid content), C_a may additionally be expressed as $g\ kg^{-1}$ lipid content of the organism, and C_s may be expressed as $g\ kg^{-1}$ organic carbon (OC) of the soil;
- BAF (expressed in $kg\ soil\ kg^{-1}$ worm), soil uptake rate constant k_s (expressed in $g\ soil\ kg^{-1}$ of worm day^{-1}), and elimination rate constant k_e (expressed in day^{-1}); BSAF (expressed in $kg\ soil\ OC\ kg^{-1}$ worm lipid content) may be reported additionally;

▼ **M4**

- if measured: percentages of parent chemical, metabolites, and bound residues (i.e. the percentage of test chemical that cannot be extracted with common extraction methods) detected in soil and test animals;
- methods used for the statistical analyses of data.

Evaluation of results:

- compliance of the results with the validity criteria as listed in paragraph 17;
- unexpected or unusual results, e.g. incomplete elimination of the test chemical from the test animals.

LITERATURE:

- (1) Amorim M (2000). Chronic and toxicokinetic behavior of Lindane (γ -HCH) in the Enchytraeid *Enchytraeus albidus*. Master thesis, University Coimbra.
- (2) ASTM (2000). Standard guide for the determination of the bioaccumulation of sediment-associated contaminants by benthic invertebrates. American Society for Testing and Materials, E 1688-00a.
- (3) ASTM International (2004). Standard guide for conducting laboratory soil toxicity or bioaccumulation tests with the Lumbricid earthworm *Eisenia fetida* and the Enchytraeid potworm *Enchytraeus albidus*. ASTM International, E1676-04: 26 pp.
- (4) Beek B, Boehling S, Bruckmann U, Franke C, Joehncke U, Studinger G (2000). The assessment of bioaccumulation. In Hutzinger, O. (editor), The Handbook of Environmental Chemistry, Vol. 2 Part J (Vol. editor: B. Beek): Bioaccumulation — New Aspects and Developments. Springer-Verlag Berlin Heidelberg: 235-276.
- (5) Belfroid A, Sikkenk M, Seinen W, Van Gestel C, Hermens J (1994). The toxicokinetic behavior of chlorobenzenes in earthworms (*Eisenia andrei*): Experiments in soil. Environ. Toxicol. Chem. 13: 93-99.
- (6) Belfroid A, Van Wezel A, Sikkenk M, Van Gestel C, Seinen W & Hermens J (1993). The toxicokinetic behavior of chlorobenzenes in earthworms (*Eisenia andrei*): Experiments in water. Ecotox. Environ. Safety 25: 154-165.
- (7) Belfroid A, Meiling J, Drenth H, Hermens J, Seinen W, Van Gestel C (1995). Dietary uptake of superlipophilic compounds by earthworms (*Eisenia andrei*). Ecotox. Environ. Safety 31: 185-191.
- (8) Bell AW (1958). The anatomy of *Enchytraeus albidus*, with a key to the species of the genus *Enchytraeus*. Ann. Mus. Novitat. 1902: 1-13.
- (9) Bligh EG and Dyer WJ (1959). A rapid method of total lipid extraction and purification. Can. J. Biochem. Pysiol. 37: 911-917.
- (10) Bouche M (1972). Lombriciens de France. Ecologie et Systematique. INRA, Annales de Zoologie-Ecologie animale, Paris, 671 p.
- (11) Bruns E, Egeler Ph, Moser T, Römbke J, Scheffczyk A, Spörlein P (2001a). Standardisierung und Validierung eines Bioakkumulationstests mit terrestrischen Oligochaeten. Report to the German Federal Environmental Agency (Umweltbundesamt Berlin), R & D No.: 29864416.
- (12) Bruns E, Egeler Ph, Römbke J, Scheffczyk A, Spörlein P (2001b). Bioaccumulation of lindane and hexachlorobenzene by the oligochaetes *Enchytraeus luxuriosus* and *Enchytraeus albidus* (Enchytraeidae, Oligochaeta, Annelida). Hydrobiologia 463: 185-196.
- (13) Conder JM and Lanno RP (2003). Lethal critical body residues as measures of Cd, Pb, and Zn bioavailability and toxicity in the earthworm *Eisenia fetida*. J. Soils Sediments 3: 13-20.

▼ **M4**

- (14) Connell DW and Markwell RD (1990). Bioaccumulation in the Soil to Earthworm System. *Chemosphere* 20: 91-100.
- (15) Didden WAM (1993). Ecology of Terrestrial Enchytraeidae. *Pedobiologia* 37: 2-29.
- (16) Didden W (2003). Oligochaeta, In: Bioindicators and biomonitors. Markert, B.A., Breure, A.M. & Zechmeister, H.G. (eds.). Elsevier Science Ltd, The Netherlands, pp. 555-576.
- (17) De Boer J, Smedes F, Wells D, Allan A (1999). Report on the QUASH interlaboratory study on the determination of total-lipid in fish and shellfish. Round 1 SBT-2, Exercise 1000, EU, Standards, Measurement and Testing Programme.
- (18) Dietrich DR, Schmid P, Zweifel U, Schlatter C, Jenni-Eiermann S, Bachmann H, Bühler U, Zbinden N (1995). Mortality of birds of prey following field application of granular carbofuran: A Case Study. *Arch. Environ. Contam. Toxicol.* 29: 140-145.
- (19) Regulation (EC) No 1907/2006 of the European Parliament and of the Council of 18 December 2006 concerning the Registration, Evaluation, Authorisation and Restriction of Chemicals (REACH), establishing a European Chemicals Agency, amending Directive 1999/45/EC and repealing Council Regulation (EEC) No 793/93 and Commission Regulation (EC) No 1488/94 as well as Council Directive 76/769/EEC and Commission Directives 91/155/EEC, 93/67/EEC, 93/105/EC and 2000/21/EC (OJ L 396, 30.12.2006, p. 1).
- (20) Edwards CA and Bohlen PJ (1996). *Biology and ecology of earthworms*. Third Edition, Chapman & Hall, London, 426 pp.
- (21) OECD (2008), *Bioaccumulation in Sediment-dwelling Benthic Oligochaetes*, Test Guideline No 315, Guidelines for the testing of chemicals, OECD, Paris
- (22) Egeler Ph, Gilberg D, Scheffczyk A, Moser Th and Römbke J (2009). Validation of a Soil Bioaccumulation Test with Terrestrial Oligochaetes by an International Ring Test (Validierung einer Methode zur standardisierten Messung der Bioakkumulation mit terrestrischen Oligochaeten). Report to the Federal Environmental Agency (Umweltbundesamt Dessau-Rosslau), R & D No.: 20467458: 149 pp. Available for download at: <http://www.oecd.org/dataoecd/12/20/42552727.pdf>.
- (23) Elmegaard N and Jagers op Akkerhuis GAJM (2000). Safety factors in pesticide risk assessment, Differences in species sensitivity and acute-chronic relations. National Environmental Research Institute, NERI Technical Report 325: 57 pp.
- (24) Environment Canada (1995). Guidance document on measurement of toxicity test precision using control sediments spiked with a reference toxicant. Environmental Protection Series Report EPS 1/RM/30.
- (25) EPPO (2003). Environmental Risk Assessment scheme for plant protection products. Soil organisms and functions, EPPO (European Plant Protection Organization) Standards, Bull, OEPP/EPPO 33: 195-208.
- (26) Franke C (1996). How meaningful is the bioconcentration factor for risk assessment? *Chemosphere* 32: 1897-1905.
- (27) Franke C, Studinger G, Berger G, Böhling S, Bruckmann U, Cohors-Fresenborg D, Jöhncke U (1994). The assessment of bioaccumulation. *Chemosphere* 29: 1501-1514.
- (28) Füll C (1996). Bioakkumulation und Metabolismus von -1,2,3,4,5,6-Hexachlorcyclohexan (Lindan) und 2-(2,4-Dichlorphenoxy)-propionsäure (Dichlorprop) beim Regenwurm *Lumbricus rubellus* (Oligochaeta, Lumbricidae). Dissertation University Mainz, 156 pp.

▼ **M4**

- (29) Füll C, Schulte C, Kula C (2003). Bewertung der Auswirkungen von Pflanzenschutzmitteln auf Regenwürmer. UWSF — Z. Umweltchem, Ökotox. 15: 78-84.
- (30) Gabric A.J, Connell DW, Bell PRF (1990). A kinetic model for bioconcentration of lipophilic compounds by oligochaetes. Wat. Res. 24: 1225-1231.
- (31) Gardner WS, Frez WA, Cichocki EA, Parrish CC (1985). Micromethods for lipids in aquatic invertebrates. Limnology and Oceanography 30: 1099-1105.
- (32) Hawker DW and Connell DW (1988). Influence of partition coefficient of lipophilic compounds on bioconcentration kinetics with fish. Wat. Res. 22: 701-707.
- (33) Hund-Rinke K and Wiechering H (2000). Earthworm avoidance test for soil assessments: An alternative for acute and reproduction tests. J. Soils Sediments 1: 15-20.
- (34) Hund-Rinke K, Römbke J, Riepert F, Achazi R (2000). Beurteilung der Lebensraumfunktion von Böden mit Hilfe von Regenwurmtests. In: Toxikologische Beurteilung von Böden. Heiden, S., Erb, R., Dott, W. & Eisen-träger, A. (eds.), Spektrum Verl., Heidelberg, 59-81.
- (35) ISO 11268-2 (1998) Soil Quality – Effects of pollutants on earthworms (*Eisenia fetida*). Part 2: Determination of effects on reproduction.
- (36) Jaenike J (1982). '*Eisenia foetida*' is two biological species. Megadrilogica 4: 6-8.
- (37) Jager T (1998). Mechanistic approach for estimating bioconcentration of organic chemicals in earthworms (Oligochaeta). Environ. Toxicol. Chem. 17: 2080-2090.
- (38) Jager T, Sanchez PA, Muijs B, van der Welde E, Posthuma L (2000). Toxicokinetics of polycyclic aromatic hydrocarbons in *Eisenia andrei* (Oligochaeta) using spiked soil. Environ. Toxicol. Chem. 19: 953-961.
- (39) Jager T, Baerselman R, Dijkman E, De Groot AC, Hogendoorn EA, DeJong A, Kruitbosch JAW, Peijnenburg W J G. M (2003a). Availability of polycyclic aromatic hydrocarbons to earthworms (*Eisenia andrei*, Oligochaeta) in field-polluted soils and soil-sediment mixtures. Environ. Toxicol. Chem. 22: 767-775.
- (40) Jager T, Fleuren RLJ, Hoogendoorn E, de Korte G (2003b). Elucidating the routes of exposure for organic chemicals in the earthworm, *Eisenia andrei* (Oligochaeta). Environ. Sci. Technol. 37: 3399-3404.
- (41) Janssen MPM, Bruins A, De Vries TH, Van Straalen NM (1991). Comparison of cadmium kinetics in four soil arthropod species. Arch. Environ. Contam. Toxicol. 20: 305-312.
- (42) Kasprzak K (1982). Review of enchytraeid community structure and function in agricultural ecosystems. Pedobiologia 23: 217-232.
- (43) Khalil AM (1990). Aufnahme und Metabolismus von ¹⁴C-Hexachlorbenzol und ¹⁴C-Pentachlornitrobenzol in Regenwürmern. Dissertation University München, 137 pp.
- (44) Landrum PF (1989). Bioavailability and toxicokinetics of polycyclic aromatic hydrocarbons sorbed to sediments for the amphipod *Pontoporeia hoyi*. Environ. Sci. Toxicol. 23: 588-595.
- (45) Marinussen MPJC, Van der Zee SEATM, De Haan FA (1997). Cu accumulation in *Lumbricus rubellus* under laboratory conditions compared with accumulation under field conditions. Ecotox. Environ. Safety 36: 17-26.
- (46) Mount DR, Dawson TD, Burkhard LP (1999). Implications of gut purging for tissue residues determined in bioaccumulation testing of sediment with *Lumbriculus variegatus*. Environ. Toxicol. Chem. 18: 1244-1249.

▼ **M4**

- (47) Nendza M (1991). QSARs of bioaccumulation: Validity assessment of log K_{ow} /log BCF correlations, In: R. Nagel and R. Loskill (eds.): Bioaccumulation in aquatic systems, Contributions to the assessment, Proceedings of an international workshop, Berlin 1990, VCH, Weinheim.
- (48) Chapter C.8 of this Annex, Toxicity for Earthworms
- (49) Chapter C.13 of this Annex, Bioconcentration: flow-through fish test.
- (50) Chapter C.21 of this annex, Soil Microorganisms: Nitrogen Transformation Test.
- (51) OECD (2004a), Enchytraeid reproduction test, Test Guideline No 220, Guidelines for the testing of chemicals, OECD, Paris.
- (52) OECD (2004b), Earthworm reproduction test (*Eisenia fetida*/*Eisenia Andrei*), Test Guideline No 222, Guidelines for the testing of chemicals, OECD, Paris.
- (53) OECD (2008), Bioaccumulation in Sediment-dwelling Benthic Oligochaetes, Test Guideline No 315, Guidelines for the testing of chemicals, OECD, Paris.
- (54) Petersen H and Luxton M (1982). A comparative analysis of soil fauna populations and their role in decomposition processes. *Oikos* 39: 287-388.
- (55) Phillips DJH (1993). Bioaccumulation. In: Handbook of Ecotoxicology Vol. 1. Calow P. (ed.). Blackwell Scientific Publ., Oxford. 378-396.
- (56) Pflugmacher J (1992). Struktur-Aktivitätsbestimmungen (QSAR) zwischen der Konzentration von Pflanzenschutzmitteln und dem Octanol-Wasser-Koeffizienten UWSF- *Z. Umweltchem. Ökotox.* 4: 77-81.
- (57) Posthuma L, Weltje L, Anton-Sanchez FA (1996). Joint toxic effects of cadmium and pyrene on reproduction and growth of the earthworm *Eisenia fetida*. RIVM Report No 607506001, Bilthoven.
- (58) Randall RC, Lee II H, Ozretich RJ, Lake JL, Pruell RJ (1991). Evaluation of selected lipid methods for normalising pollutant bioaccumulation. *Environ.Toxicol. Chem.* 10: 1431-1436.
- (59) Römbke J, Egele, P, Füll C (1998). Literaturstudie über Bioakkumulationstests mit Oligochaeten im terrestrischen Medium. UBA-Texte 28/98, 84 S.
- (60) Römbke J and Moser Th (1999). Organisation and performance of an international ring-test for the validation of the Enchytraeid reproduction test. UBA-Texte 4/99: 373 pp.
- (61) Römbke J, Riepert F, Achazi R (2000). Enchytraeen als Testorganismen, In: Toxikologische Beurteilung von Böden. Heiden, S., Erb, R., Dott, W. & Eisentraeger, A. (eds.). Spektrum Verl., Heidelberg. 105-129.
- (62) Romijn CA.FM, Luttik R, Van De Meent D, Slooff W, Canton JH (1993). Presentation of a General Algorithm to Include Effect Assessment on Secondary Poisoning in the Derivation of Environmental Quality Criteria, Part 2: Terrestrial food chains. *Ecotox. Envir. Safety* 27: 107-127.
- (63) Sample BE, Suter DW, Beauchamp JJ, Efroymson RA (1999). LITERATURE-derived bioaccumulation models for earthworms: Development and validation. *Environ. Toxicol. Chem.* 18: 2110-2120.
- (64) Schlosser H-J and Riepert F (1992). Entwicklung eines Prüfverfahrens für Chemikalien an Bodenraubmilben (*Gamasina*), Teil 2: Erste Ergebnisse mit Lindan und Kaliumdichromat in subletaler Dosierung. *Zool. Beitr. NF* 34: 413-433.
- (65) Schmelz R and Collado R (1999). *Enchytraeus luxuriosus* sp. nov., a new terrestrial oligochaete species (Enchytraeide, Clitellata, Annelida). *Carolinea* 57: 93-100.

▼ **M4**

- (66) Sims R W and Gerard BM (1985). Earthworms, In: Kermack, D. M. & Barnes, R. S. K. (Hrsg.): Synopses of the British Fauna (New Series) No 31.171 S. London: E. J. Brill/Dr W. Backhuys.
- (67) Sousa JP, Loureiro S, Pieper S, Frost M, Kratz W, Nogueira AJA, Soares AMVM (2000). Soil and plant diet exposure routes and toxicokinetics of lindane in a terrestrial isopod. *Environ. Toxicol. Chem.* 19: 2557–2563.
- (68) Spacie A and Hamelink JL (1982). Alternative models for describing the bioconcentration of organics in fish. *Environ. Toxicol. Chem.* 1, 309-320.
- (69) Stephenson GL, Kaushik A, Kaushik NK, Solomon KR, Steele T, Scroggins RP (1998). Use of an avoidance-response test to assess the toxicity of contaminated soils to earthworms. In: *Advances in earthworm ecotoxicology*. S. Sheppard, J. Bembridge, M. Holmstrup, L. Posthuma (eds.). Setac Press, Pensacola, 67-81.
- (70) Sterenborg I, Vork NA, Verkade SK, Van Gestel CAM, Van Straalen NM (2003). Dietary zinc reduces uptake but not metallothionein binding and elimination of cadmium in the springtail *Orchesella cincta*. *Environ. Toxicol. Chemistry* 22: 1167-1171.
- (71) UBA (Umweltbundesamt) (1991). Bioakkumulation — Bewertungskonzept und Strategien im Gesetzesvollzug. UBA-Texte 42/91. Berlin.
- (72) US EPA (2000). Methods for measuring the toxicity and bioaccumulation of sediment-associated contaminants with freshwater invertebrates. Second Edition, EPA 600/R-99/064, US, Environmental Protection Agency, Duluth, MN, March 2000.
- (73) Van Brummelen TC and Van Straalen NM (1996). Uptake and elimination of benzo(a)pyrene in the terrestrial isopod *Porcellio scaber*. *Arch. Environ. Contam. Toxicol.* 31: 277-285.
- (74) Van Gestel CAM. (1992). The influence of soil characteristics on the toxicity of chemicals for earthworms; a review, In: *Ecotoxicology of Earthworms* (Ed. Becker, H, Edwards, PJ, Greig-Smith, PW & Heimbach, F). Intercept Press, Andover (GB).
- (75) Van Gestel CA and Ma W-C (1990). An approach to quantitative structure-activity relationships (QSARs) in earthworm toxicity studies. *Chemosphere* 21: 1023-1033.
- (76) Van Straalen NM, Donker MH, Vijver MG, van Gestel CAM (2005). Bioavailability of contaminants estimated from uptake rates into soil invertebrates. *Environmental Pollution* 136: 409-417.
- (77) Venter JM and Reinecke AJ (1988). The life-cycle of the compost-worm *Eisenia fetida* (Oligochaeta). *South African J. Zool.* 23: 161-165.
- (78) Vijver MG, Vink JPM, Jager T, Wolterbeek HT, van Straalen NM, van Gestel CAM (2005). Biphasic elimination and uptake kinetics of Zn and Cd in the earthworm *Lumbricus rubellus* exposed to contaminated floodplain soil. *Soil Biol, Biochem.* 37: 1843-1851.
- (79) Widianarko B and Van Straalen NM (1996). Toxicokinetics-based survival analysis in bioassays using nonpersistent chemicals, *Environ. Toxicol. Chem.* 15: 402–406.

▼ **M4***Appendix 1*

DEFINITIONS

Bioaccumulation is the increase in concentration of the test chemical in or on an organism relative to the concentration of the test chemical in the surrounding medium. Bioaccumulation results from both bioconcentration and biomagnification processes (see below).

Bioconcentration is the increase in concentration of the test chemical in or on an organism, resulting from the uptake of the chemical exclusively from the surrounding medium (i.e. via the body surface and ingested soil), relative to the concentration of the test chemical in the surrounding medium.

Biomagnification is the increase in concentration of the test chemical in or on an organism, resulting mainly from uptake from contaminated food or prey, relative to the concentration of the test chemical in the food or prey. Biomagnification can lead to a transfer or accumulation of the test item within food webs.

The **elimination** of a test chemical is the loss of this chemical from the test organism tissue by active or passive processes that occurs independently of presence or absence of the test item in the surrounding medium.

The **bioaccumulation factor** (BAF) at any time during the uptake phase of this bioaccumulation test is the concentration of test chemical in/on the test organism (C_a in $\text{g}\cdot\text{kg}^{-1}$ dry weight of worm) divided by the concentration of the chemical in the surrounding medium (C_s as $\text{g}\cdot\text{kg}^{-1}$ of dry weight of soil); the BAF has the units of $\text{kg soil}\cdot\text{kg}^{-1}$ worm.

The **steady state bioaccumulation factor** (BAF_{ss}) is the BAF at steady state and does not change significantly over a prolonged period of time, the concentration of the test chemical in the surrounding medium (C_s as $\text{g}\cdot\text{kg}^{-1}$ of dry weight of soil) being constant during this period of time.

Bioaccumulation factors calculated directly from the ratio of the soil uptake rate constant and the elimination rate constant (k_s and k_e , see below) are termed kinetic bioaccumulation factor (BAF_k).

The **biota-soil accumulation factor** (BSAF) is the lipid-normalised concentration of the test chemical in/on the test organism divided by the organic carbon-normalised concentration of the test chemical in the soil at steady state. C_a is then expressed as $\text{g}\cdot\text{kg}^{-1}$ lipid content of the organism, and C_s as $\text{g}\cdot\text{kg}^{-1}$ organic content of the soil; the BSAF has the units of $\text{kg OC}\cdot\text{kg}^{-1}$ lipid.

A **plateau** or **steady state** is defined as the equilibrium between the uptake and elimination processes that occur simultaneously during the exposure phase. The steady state is reached in the plot of BAF against time when the curve becomes parallel to the time axis and three successive analyses of BAF made on samples taken at intervals of at least two days are within 20 % of each other, and there are no statistically significant differences among the three sampling periods. For test chemicals which are taken up slowly, more appropriate intervals would be seven days (49).

The **organic carbon-water partitioning coefficient** (K_{oc}) is the ratio of a chemical's concentration in/on the organic carbon fraction of a soil and the chemical's concentration in water at equilibrium.

The **octanol-water partitioning coefficient** (K_{ow}) is the ratio of a chemical's solubility in n-octanol and water at equilibrium, also sometimes expressed as P_{ow} . The logarithm of K_{ow} ($\log K_{\text{ow}}$) is used as an indication of a chemical's potential for bioaccumulation by aquatic organisms.

▼ M4

The **uptake or exposure phase** is the time during which the test organisms are exposed to the test chemical.

The **soil uptake rate constant** (k_s) is the numerical value defining the rate of increase in the concentration of the test item in/on the test organism resulting from uptake from the soil phase. k_s is expressed in g soil kg^{-1} of worm d^{-1} .

The **elimination phase** is the time, following the transfer of the test organisms from a contaminated medium to a medium free of the test item, during which the elimination (or the net loss) of the chemical from the test organisms is studied.

The **elimination rate constant** (k_e) is the numerical value defining the rate of reduction in the concentration of the test item in/on the test organism, following the transfer of the test organisms from a medium containing the test item to a chemical-free medium; k_e is expressed in d^{-1} .

Test chemical: Any substance or mixture tested using this Test Method.

▼ **M4***Appendix 2***Calculation of uptake and elimination parameters**

The main endpoint of a bioaccumulation test is the bioaccumulation factor, BAF. The measured BAF can be calculated by dividing the concentration in the test organism, C_a , by the concentration in the soil, C_s , at steady state. If the steady state is not reached during the uptake phase, the BAF_K is calculated from the rate constants instead of BAFss. However, it should be noted if the BAF is based on steady state concentrations or not.

The usual means for obtaining the kinetic bioaccumulation factor (BAF_K), the soil uptake rate constant (k_s) and the elimination rate constant (k_e) is to use non-linear parameter estimation methods on a computer, e.g. based on the models described in (68). Given a set of sequential time concentration data and the model equations:

$$C_a = \frac{k_s}{k_e} \times C_s (1 - e^{-k} e^t) \quad 0 < t < t_c \quad \text{[equation 1]}$$

or

$$C_a = \frac{k_s}{k_e} \times C_s (e^{-k} e^{(t-t_c)} - e^{-k} e^t) \quad t > t_c \quad \text{[equation 2]}$$

where:

C_a = concentration of chemical in worms [g kg⁻¹ wet or dry weight]

k_s = uptake rate constant in tissue [g soil kg⁻¹ of worm d⁻¹]

C_s = concentration of chemical in soil [g kg⁻¹ of wet or dry weight]

k_e = elimination rate constant [d⁻¹]

t_c = time at the end of the uptake phase,

these computer programs calculate values for BAF_K , k_s and k_e .

When the background concentration in the non-exposed worms e.g. on day 0 differs significantly from zero (this may e.g. be the case for metals), this background concentration ($C_{a,0}$) should be included in these equations, to make them read:

$$C_a = C_{a,0} + \frac{k_s}{k_e} \times C_s (1 - e^{-k} e^t) \quad 0 < t < t_c \quad \text{[equation 3]}$$

and

$$C_a = C_{a,0} + \frac{k_s}{k_e} \times C_s (e^{-k} e^{(t-t_c)} - e^{-k} e^t) \quad t > t_c \quad \text{[equation 4]}$$

In cases where a significant decrease of the test chemical concentration in the soil is observed over time during the uptake phase, the following models can be used e.g. (67) (79):

$$C_s = C_0 (e^{-k} 0^t) \quad \text{[equation 5]}$$

▼ M4

where:

C_s = concentration of chemical in the soil [g kg-1 wet or dry weight]

k_0 = degradation rate constant in soil [d-1]

C_0 = initial concentration of chemical in soil [g kg-1 of wet or dry weight]

$$C_a = \frac{k_s}{k_e - k_0} \times (e^{-k_0 t} - e^{-k} e^t) \quad 0 < t < t_c \quad [\text{equation 6}]$$

$$C_a = \frac{k_s}{k_e - k_0} \times e^{-k_0 t_c} - e^{-k} e^{t_c} * e^{-k(t-t_c)} \quad t > t_c \quad [\text{equation 7}]$$

where:

C_a = concentration of chemical in worms [g kg-1 wet or dry weight]

k_s = uptake rate constant in tissue [g soil kg-1 of worm d-1]

k_0 = degradation rate constant in soil [d-1]

k_e = elimination rate constant [d-1]

t_c = time at the end of the uptake phase.

When steady state is reached during the uptake phase (i.e. $t = \infty$), equation 1

$$C_a = \frac{k_s}{k_e} \times C_s (1 - e^{-k} e^t) \quad 0 < t < t_c \quad [\text{equation 1}]$$

may be reduced to:

$$C_a = \frac{k_s}{k_e} \times C_s$$

or

$$C_a/C_s = k_s/k_e = \text{BAF}_K \quad [\text{equation 8}]$$

Then $k_s/k_e \times C_s$ is an approach to the concentration of the test item in the worm tissue at steady state ($C_{a,ss}$).

The biota-soil accumulation factor (BSAF) can be calculated as follows:

$$\text{BSAF} = \text{BAF}_K * \frac{f_{oc}}{f_{lip}} \quad [\text{equation 9}]$$

where f_{oc} is the fraction of soil organic carbon, and f_{lip} is the fraction of worm lipid, both preferably determined on samples taken from the test, and based either on dry weight or on wet weight, respectively.

The elimination kinetics can be modelled using the data from the elimination phase and applying the following model equation and a computer-based non-linear parameter estimation method. If the data points plotted against time indicate a constant exponential decline of the test item concentration in the animals, a one-compartment model (equation 9) can be used to describe the time course of elimination.

$$C_a(t) = C_{a,ss} \times e^{-k} e^t \quad [\text{equation 10}]$$

▼ M4

Elimination processes sometimes appear to be biphasic, showing a rapid decline of C_a during the early phases, that changes to a slower loss of test items in the later phases of the elimination, e.g. (27) (68). The two phases can be interpreted by the assumption, that there are two different compartments in the organism, from which the test item is lost with different velocities. In these cases, specific LITERATURE should be studied e.g. (38) (39) (40) (78).

Using the model equations above, the kinetic parameters (k_s and k_e) may also be calculated in one run by applying the first order kinetics model to all data from both the uptake and elimination phase simultaneously. For a description of a method that may allow for such a combined calculation of uptake and elimination rate constants, references (41), (73) and (70) may be consulted.

$$C_a = \left[\frac{K_s}{K_e} \cdot C_s (1 - e^{-k_e t}) \times (m = 1) \right] + \left[\frac{K_s}{k_e} \times C_s (e^{-K_e(t-t_e)} - e^{-K_e t}) \times (m = 2) \right] \quad \text{[equation 11]}$$

Note: When uptake and elimination parameters are estimated simultaneously from the combined uptake and the elimination data, 'm' as shown in equation 11 is a descriptor that allows the computer program to assign the equation's sub-terms to the data sets of the respective phase and to perform the evaluation correctly (m = 1 for uptake phase; m = 2 for elimination phase).

Nevertheless, these model equations should be used with caution, especially when changes in the test chemical's bioavailability, or (bio)degradation occur during the test (see e.g. (79)).

▼ **M4***Appendix 3*

EXAMPLES OF SCHEDULES FOR SOIL BIOACCUMULATION TESTS

Earthworm test

(a) Uptake phase with 8 sampling dates used for calculation of kinetics

Day	Activity
- 6	Conditioning of the prepared soil for 48 h;
- 4	Spiking of the soil fraction with the test chemical solution; evaporating of any solvent; mixing of the soil constituents; distributing the soil to the test vessels; equilibration at test conditions for 4 days (3 weeks for metal-spiked soil);
- 3 to - 1	Separation of the test organisms from the culture for acclimation; preparation and moisturising of the soil constituents;
0	Measuring temperature, and soil pH; removing soil samples from treated vessels and solvent controls for determination of test chemical concentration; addition of food ration; weighing and randomised distribution of the worms to the test vessels; retaining of sufficient subsamples of worms for determination of analytical background values, wet and dry weight, and lipid content; weighing of all test vessels to control soil moisture; controlling air supply, if closed test system is used;
1	Controlling air supply, recording worm behaviour and temperature; taking soil and worm samples for determination of test item concentration;
2	Same as day 1;
3	Controlling air supply, worm behaviour and temperature;
4	Same as day 1;
5-6	Same as day 3;
7	Same as day 1; addition of food ration; control soil moisture by re-weighing the test vessels and compensate evaporated water;
8-9	Same as day 3;
10	Same as day 1;
11-13	Same as day 3;
14	Same as day 1; addition of food ration; control soil moisture by re-weighing the test vessels and compensate evaporated water;
15-16	Same as day 3;
17	Same as day 1;
18-20	Same as day 3;

▼ **M4**

Day	Activity
21	Same as day 1; measuring temperature and soil pH; control soil moisture by re-weighing the test vessels; end of uptake phase; transfer worms from remaining exposed replicates to vessels containing clean soil for elimination phase (no gut-purging); sampling of soil and worms from solvent controls.
	Pre-exposure activities (equilibration phase) should be scheduled taking into account the properties of the test chemical.
	Activities described for day 3 should be performed daily (at least on workdays).

(b) Elimination phase

Day	Activity
- 6	Preparation and moisturising of the soil constituents; conditioning of the prepared soil for 48 h;
- 4	Mixing of the soil constituents; distributing the soil to the test vessels; incubation at test conditions for 4 days;
0 (end of uptake phase)	Measuring temperature and soil pH; weighing and randomised distribution of the worms to the test vessels; addition of food ration; transfer worms from remaining exposed replicates to vessels containing clean soil; taking soil and worm samples after 4-6 h for determination of test chemical concentration;
1	Controlling air supply, recording worm behaviour and temperature; taking soil and worm samples for determination of test chemical concentration;
2	Same as day 1;
3	Controlling air supply, worm behaviour and temperature;
4	Same as day 1;
5-6	Same as day 3;
7	Same as day 1; addition of food ration; control soil moisture by re-weighing the test vessels and compensate evaporated water;
8-9	Same as day 3;
10	Same as day 1;
11-13	Same as day 3;
14	Same as day 1; addition of food ration; control soil moisture by re-weighing the test vessels and compensate evaporated water;
15-16	Same as day 3;
17	Same as day 1;

▼ **M4**

Day	Activity
18-20	Same as day 3;
21	Same as day 1; measuring temperature and soil pH; control soil moisture by re-weighing the test vessels; sampling of soil and worms from solvent controls.
	Preparation of the soil prior to start of elimination phase should be done in the same manner as before the uptake phase.
	Activities described for day 3 should be performed daily (at least on workdays).

Enchytraeid test

(a) Uptake phase with 8 sampling dates used for calculation of kinetics

Day	Activity
- 6	Conditioning of the prepared soil for 48 h;
- 4	Spiking of the soil fraction with the test chemical solution; evaporating of any solvent; mixing of the soil constituents; distributing the soil to the test vessels; equilibration at test conditions for 4 days (3 weeks for metal-spiked soil);
- 3 to - 1	Separation of the test organisms from the culture for acclimation; preparation and moisturising of the soil constituents;
0	Measuring temperature, and soil pH; removing soil samples from treated vessels and solvent controls for determination of test chemical concentration; addition of food ration to soil; weighing and randomised distribution of the worms to the test vessels; retaining of sufficient subsamples of worms for determination of analytical background values, wet and dry weight, and lipid content; weighing of all test vessels to control soil moisture; controlling air supply, if closed test system is used;
1	Controlling air supply, recording worm behaviour and temperature; taking soil and worm samples for determination of test item concentration;
2	Same as day 1;
3	Controlling air supply, worm behaviour and temperature;
4	Same as day 1;
5-6	Same as day 3;
7	Same as day 1; addition of food ration to soil; control soil moisture by re-weighing the test vessels and compensate evaporated water;
9	Same as day 1;
10	Same as day 3;

▼ **M4**

Day	Activity
11	Same as day 1;
12-13	Same as day 3;
14	Same as day 1; addition of food ration to soil; measuring temperature and soil pH; control soil moisture by re-weighing the test vessels; end of uptake phase; transfer worms from remaining exposed replicates to vessels containing clean soil for elimination phase (no gut-purging); sampling of soil and worms from solvent controls.
	Pre-exposure activities (equilibration phase) should be scheduled taking into account the properties of the test chemical.
	Activities described for day 3 should be performed daily (at least on workdays).

▼ **M4***Appendix 4***Artificial soil – preparation and storage recommendations**

Since natural soils from a particular source may not be available throughout the year, and indigenous organisms as well as the presence of micro-pollutants can influence the test, an artificial substrate, the artificial soil according to Chapter C.8 of this Annex, Toxicity for Earthworms (48), is recommended for use in this test. Several test species can survive, grow, and reproduce in this soil, and maximum standardisation as well as intra- and interlaboratory comparability of test and culture conditions are provided.

Soil constituents:

Peat:	10 %	Sphagnum-peat, in accordance with the OECD Guideline 207 (48);
Quartz sand:	70 %	Industrial quartz sand (air dried); grain size: more than 50 % of the particles should be in the range of 50-200 µm, but all particles should be ≤ 2 mm;
Kaolinite clay:	20 %	Kaolinite content ≥ 30 %;
Calcium carbonate:	≤ 1 %	CaCO ₃ , pulverised, chemically pure.

As an option, the organic carbon content of the artificial soil may be reduced, e.g. by lowering the peat content to 4-5 % of dry soil and increasing the sand content accordingly. By such a reduction in organic carbon content, the possibilities of adsorption of test chemical to the soil (organic carbon) may be decreased, and the availability of the test chemical to the worms may increase (74). It has been demonstrated that *Enchytraeus albidus* and *Eisenia fetida* can comply with the validity criteria on reproduction when tested in field soils with lower organic carbon content, e.g. 2,7 % (33), (61), and there is experience that this can also be achieved in artificial soil with 5 % peat.

Preparation

The dry constituents of the soil are mixed thoroughly (e.g. in a large-scale laboratory mixer). This should be done about one week before starting the test. The mixed dry soil constituents should be moistened with deionised water at least 48 h before application of the test item in order to equilibrate/stabilise the acidity. For the determination of pH a mixture of soil and 1 M KCl solution in a 1:5 ratio is used. If the pH value is not within the required range ($6,0 \pm 0,5$), a sufficient amount of CaCO₃ is added to the soil, or a new batch of soil is prepared.

The maximum water holding capacity (WHC) of the artificial soil is determined according to ISO 11268-2 (35). At least two days before starting the test, the dry artificial soil is moistened by adding enough deionised or reconstituted water to obtain approximately half of the final water content. The final water content should be 40 % to 60 % of the maximum WHC. At the start of the test, the pre-moistened soil is divided into as many batches as the number of test concentrations and controls used for the test, and the moisture content is adjusted to 40-60 % of WHC_{max} by using the solution of the test item and/or by adding deionised or reconstituted water. The moisture content is determined at the beginning and at the end of the test (at 105 °C). It should be optimal for the species' requirements (the moisture content can also be checked as follows: when the soil is gently squeezed in the hand, small drops of water should appear between the fingers).

▼ M4**Storage**

The dry constituents of the artificial soil may be stored at room temperature until use. The prepared, pre-moistened soil may be stored in a cool place for up to three days prior to spiking; care should be taken to minimise evaporation of water. Soil spiked with the test item should be used immediately unless there is information indicating that the particular soil can be stored without affecting the toxicity and bioavailability of the test item. Samples of spiked soil may then be stored under the conditions recommended for the particular test item until analysis.

▼ **M4***Appendix 5***Species of terrestrial oligochaetes recommended for testing bioaccumulation from soil****Earthworms**

The recommended test species is *Eisenia fetida* (Savigny 1826), belonging to the family Lumbricidae. Since 1972 it is divided into two subspecies (*Eisenia fetida* and *Eisenia andrei* (10)). According to Jaenike (36), they are true, separate species. *Eisenia fetida* is easily recognised by its bright intersegmental yellow stripes whereas *Eisenia andrei* has a uniform, dark red colour. Originating probably from the region of the Black Sea, they are distributed worldwide today, especially in anthropogenically modified habitats like compost heaps. Both can be used for ecotoxicological as well as bioaccumulation tests.

Eisenia fetida and *Eisenia andrei* are commercially available, e.g. as fish bait. In comparison to other lumbricid earthworms, they have a short life-cycle, reaching maturity within ca. 2-3 months (at room temperature). Their optimum temperature is approximately at 20-24 °C. They prefer relatively moist substrates with a nearly neutral pH and a high content of organic material. Since these species have been widely used in standardised ecotoxicological tests for about 25 years, their culturing is well established (48) (77).

Both species can be bred in a wide range of animal wastes. The breeding medium recommended by ISO (35) is a 50:50 mixture of horse or cattle manure and peat. The medium should have a pH value of about 6 to 7 (regulated with calcium carbonate), a low ionic conductivity (less than 6 mS/cm or less than 0,5 % salt concentration) and should not be contaminated excessively with ammonia or animal urine. Also, a commercial gardening soil free of additives, or artificial soil according to OECD (48), or a 50:50 mixture of both can be used. The substrate should be moist but not too wet. Breeding boxes of 10 litre to 50 litre volume are suitable.

To obtain worms of standard age and mass, it is best to start the culture with cocoons. Therefore, adult worms are added to a breeding box containing fresh substrate to produce cocoons. Practical experience has shown that a population density of approximately 100 adult worms per kg substrate (wet weight) leads to good reproduction rates. After 28 days, the adult worms are removed. The earthworms hatched from the cocoons are used for testing when mature after at least 2 months but less than 12 months.

Worms of the species described above can be considered healthy if they move through the substrate, do not try to leave the substrate, and reproduce continuously. Very slow motioning or a yellow posterior end (in the case of *Eisenia fetida*) indicates substrate exhaustion. In this case, fresh substrate and/or a lower number of animals per box is recommended.

Additional selected references

Gerard BM (1964). Synopsis of the British fauna. No 6 Lumbricidae. Linnean Soc. London, 6: 1-58.

Graff O (1953). Die Regenwürmer Deutschlands. Schr. Forsch. Anst. Landwirtschaft. 7: 1-81.

Römbke J, Egeler P, Füll C (1997). Literaturstudie über Bioakkumulationstests mit Oligochaeten im terrestrischen Medium. Bericht für das UBA F + E 206 03 909, 86 S.

Rundgren S (1977). Seasonality of emergence in lumbricids in southern Sweden. Oikos 28: 49-55.

Satchell JE (1955). Some aspects of earthworm ecology. Soil Zoology (Kevan): 180-201.

▼ M4

Sims RW and Gerard BM (1985). A synopsis of the earthworms. Linnean Soc. London 31: 1-171.

Tomlin AD (1984). The earthworm bait market in North America. In: Earthworm Ecology — from Darwin to vermiculture. Satchell, J.E. (ed.), Chapman & Hall, London. 331-338 pp.

Enchytraeids

The recommended test species is *Enchytraeus albidus* Henle 1837 (white potworm). *Enchytraeus albidus* is one of the biggest (up to 15 mm) species of the annelid oligochaete family Enchytraeidae and it is worldwide distributed e.g. (8). *Enchytraeus albidus* is found in marine, limnic and terrestrial habitats, mainly in decaying organic matter (seaweed, compost) and rarely in meadows (42). This broad ecological tolerance and some morphological variations indicate that there might be different races for this species.

Enchytraeus albidus is commercially available, sold as food for fish. It should be checked whether the culture is contaminated by other, usually smaller species (60). If contamination occurs, all worms should be washed with water in a Petri dish. Large adult specimens of *Enchytraeus albidus* are then selected (by using a stereomicroscope) to start a new culture. All other worms are discarded. Its life cycle is short as maturity is reached between 33 days (at 18 °C) and 74 days (at 12 °C). Only cultures which have been kept in the laboratory for at least 5 weeks (one generation) without problems should be used for a test.

Other species of the *Enchytraeus* genus are also suitable, especially *Enchytraeus luxuriosus*. This species is a true soil inhabitant, which has been newly described in (65). If other species of *Enchytraeus* are used, they should be clearly identified and the rationale for the selection of the species should be reported.

Enchytraeus crypticus (Westheide & Graefe 1992) is a species belonging to the same group as *Enchytraeus luxuriosus*. It has not been found to exist with certainty in the field, having only been described from earthworm cultures and compost heaps (Römbke 2003). Its original ecological requirements are therefore not known. However, recent laboratory studies in various field soils have confirmed that this species has a broad tolerance towards soil properties like pH and texture (Jänsch et al. 2005). In recent years, this species has often been used in ecotoxicological studies because of the simplicity of its breeding and testing, e.g. Kuperman et al. 2003). However, it is small (3-12 mm; 7 mm on average (Westheide & Müller 1996), and this makes handling more difficult compared with *Enchytraeus albidus*. When using this species instead of *Enchytraeus albidus*, the size of the test vessel can but needs not to be smaller. In addition, it should be considered that this species reproduces very rapidly having a generation time of less than 20 days at 20 ± 2 °C (Achazi et al. 1999) and even quicker at higher temperatures.

Enchytraeids of the species *Enchytraeus albidus* (as well as other *Enchytraeus* species) can be bred in large plastic boxes (e.g. 30 × 60 × 10 cm or 20 × 12 × 8 cm which is suitable for culture of worms of small size) filled with a mixture of artificial soil and commercially available, uncontaminated garden soil free of additives. Compost material should be avoided since it could contain toxic chemicals like heavy metals. Fauna should be removed from the breeding soil before use by three times deep-freezing. Pure artificial soil can also be used but the reproduction rate could be slower compared to that obtained with mixed substrates. The substrate should have a pH of 6,0 ± 0,5. The culture is kept in an incubator at a temperature of 15 ± 2 °C without light. In any case, a temperature higher than 23 °C should be avoided. The artificial/natural soil moisture should be moist but not wet. When the soil is gently pressed by hand, only small drops of water should appear. In any case, anoxic conditions should be avoided (e.g. if a lid is used, the number of lid holes should be high enough to provide sufficient exchange of air). The breeding soil should be aerated by carefully mixing it once per week.

▼ M4

The worms should be fed at least once per week ad libitum with rolled oats which are placed into a cavity on the soil surface and covered with soil. If food from the last feeding date remains in the container, the amount of food given should be adjusted accordingly. If fungi grow on the remaining food, it should be replaced by a new quantity of rolled oats. In order to stimulate reproduction, the rolled oats may be supplemented with commercially available, vitamin amended protein powder every two weeks. After three months, the animals are transferred to a freshly prepared culture or breeding substrate. The rolled oats, which have to be stored in sealed vessels, should be autoclaved or heated before use in order to avoid infections by flour mites (e.g. *Glyzyphagus* sp., Astigmata, Acarina) or predacious mites (e.g. *Hypoaspis (Cosmolaelaps) miles*, Gamasida, Acarina). After disinfecting, the food is ground up so that it can easily be strewn on the soil surface. Another possible food source is baker's yeast or the fish food TetraMin[®].

In general, the culturing conditions are sufficient if worms do not try to leave the substrate, move quickly through the soil, exhibit a shiny outer surface without soil particles clinging to it, are more or less whitish coloured, and if worms of different ages are visible. Actually, worms can be considered healthy if they reproduce continuously.

Additional selected references

Achazi RK, Fröhlich E, Henneken M, Pilz C (1999). The effect of soil from former irrigation fields and of sewage sludge on dispersal activity and colonizing success of the annelid *Enchytraeus crypticus* (Enchytraeidae, Oligochaeta). Newsletter on Enchytraeidae 6: 117-126.

Jänsch S, Amorim MJB, Römbke J (2005). Identification of the ecological requirements of important terrestrial ecotoxicological test species. Environ. Reviews 13: 51-83.

Kuperman RG, Checkai RT, Simini M, Phillips CT, Kolakowski JE, Kurnas CW, Sunahara GI (2003). Survival and reproduction of *Enchytraeus crypticus* (Oligochaeta, Enchytraeidae) in a natural sandy loam soil amended with the nitro-heterocyclic explosives RDX and HMX. Pedobiologia 47: 651-656.

Römbke J (2003). Ecotoxicological laboratory tests with enchytraeids: A review. Pedobiologia 47: 607-616.

Westheide W and Graefe U (1992). Two new terrestrial *Enchytraeus* species (Oligochaeta, Annelida). J. Nat. Hist. 26: 479-488.

Westheide W and Müller MC (1996). Cinematographic documentation of enchytraeid morphology and reproductive biology. Hydrobiologia 334: 263-267.

▼ M6**C.31. TERRESTRIAL PLANT TEST: SEEDLING EMERGENCE AND SEEDLING GROWTH TEST**

INTRODUCTION

1. This test method is equivalent to OECD Test Guideline (TG) 208 (2006). Test methods are periodically reviewed in the light of scientific progress and applicability to regulatory use. This updated test method is designed to assess potential effects of chemicals on seedling emergence and growth. As such it does not cover chronic effects or effects on reproduction (i.e. seed set, flower formation, fruit maturation). Conditions of exposure and properties of the chemical to be tested must be considered to ensure that appropriate test methods are used (e.g. when testing metals/metal compounds the effects of pH and associated counter ions should be considered) (1). This test method does not address plants exposed to vapours of chemicals. The test method is applicable to the testing of general chemicals, biocides and crop protection products (also known as plant protection products or pesticides). It has been developed on the basis of existing methods (2) (3) (4) (5) (6) (7). Other references pertinent to plant testing were also considered (8) (9) (10). Definitions used are given in Appendix 1.

PRINCIPLE OF THE TEST

2. The test assesses effects on seedling emergence and early growth of higher plants following exposure to the test chemical in the soil (or other suitable soil matrix). Seeds are placed in contact with soil treated with the test chemical and evaluated for effects following usually 14 to 21 days after 50 % emergence of the seedlings in the control group. Endpoints measured are visual assessment of seedling emergence, dry shoot weight (alternatively fresh shoot weight) and in certain cases shoot height, as well as an assessment of visible detrimental effects on different parts of the plant. These measurements and observations are compared to those of untreated control plants.
3. Depending on the expected route of exposure, the test chemical is either incorporated into the soil (or possibly into artificial soil matrix) or applied to the soil surface, which properly represents the potential route of exposure to the chemical. Soil incorporation is done by treating bulk soil. After the application the soil is transferred into pots, and then seeds of the given plant species are planted in the soil. Surface applications are made to potted soil in which the seeds have already been planted. The test units (controls and treated soils plus seeds) are then placed under appropriate conditions to support germination/growth of plants.
4. The test can be conducted in order to determine the dose-response curve, or at a single concentration/rate as a limit test according to the aim of the study. If results from the single concentration/rate test exceed a certain toxicity level (e.g. whether effects greater than x % are observed), a range-finding test is carried out to determine upper and lower limits for toxicity followed by a multiple concentration/rate test to generate a dose-response curve. An appropriate statistical analysis is used to obtain effective concentration EC_x or effective application rate ER_x (e.g. EC_{25} , ER_{25} , EC_{50} , ER_{50}) for the most sensitive parameter(s) of interest. Also, the no observed effect concentration (NOEC) and lowest observed effect concentration (LOEC) can be calculated in this test.

INFORMATION ON THE TEST CHEMICAL

5. The following information is useful for the identification of the expected route of exposure to the chemical and in designing the test: structural formula, purity, water solubility, solubility in organic solvents,

▼M6

1-octanol/water partition coefficient, soil sorption behaviour, vapour pressure, chemical stability in water and light, and biodegradability.

VALIDITY OF THE TEST

6. In order for the test to be considered valid, the following performance criteria must be met in the controls:
 - the seedling emergence is at least 70 %;
 - the seedlings do not exhibit visible phytotoxic effects (e.g. chlorosis, necrosis, wilting, leaf and stem deformations) and the plants exhibit only normal variation in growth and morphology for that particular species;
 - the mean survival of emerged control seedlings is at least 90 % for the duration of the study;
 - environmental conditions for a particular species are identical and growing media contain the same amount of soil matrix, support media, or substrate from the same source.

REFERENCE CHEMICAL

7. A reference chemical may be tested at regular intervals, to verify that performance of the test and the response of the particular test plants and the test conditions have not changed significantly over time. Alternatively, historical biomass or growth measurement of controls could be used to evaluate the performance of the test system in particular laboratories, and can serve as an intra-laboratory quality control measure.

DESCRIPTION OF THE METHOD

Natural soil — Artificial substrate

8. Plants may be grown in pots using a sandy loam, loamy sand, or sandy clay loam that contains up to 1,5 percent organic carbon (approx. 3 percent organic matter). Commercial potting soil or synthetic soil mix that contains up to 1,5 percent organic carbon may also be used. Clay soils should not be used if the test chemical is known to have a high affinity for clays. Field soil should be sieved to 2 mm particle size in order to homogenise it and remove coarse particles. The type and texture, % organic carbon, pH and salt content as electronic conductivity of the final prepared soil should be reported. The soil should be classified according to a standard classification scheme (11). The soil could be pasteurised or heat treated in order to reduce the effect of soil pathogens.
9. Natural soil may complicate interpretation of results and increase variability due to varying physical/chemical properties and microbial populations. These variables in turn alter moisture-holding capacity, chemical-binding capacity, aeration, and nutrient and trace element content. In addition to the variations in these physical factors, there will also be variation in chemical properties such as pH and redox potential, which may affect the bioavailability of the test chemical (12) (13) (14).
10. Artificial substrates are typically not used for testing of crop protection products, but they may be of use for the testing of general chemicals or where it is desired to minimize the variability of the natural soils and increase the comparability of the test results. Substrates used should be composed of inert materials that minimize interaction with the test chemical, the solvent carrier, or both. Acid washed quartz sand, mineral wool and glass beads (e.g. 0,35 to 0,85 mm in diameter) have been found to be suitable inert materials that minimally absorb the test chemical (15), ensuring that the chemical will be maximally available to the seedling via

▼ M6

root uptake. Unsuitable substrates would include vermiculite, perlite or other highly absorptive materials. Nutrients for plant growth should be provided to ensure that plants are not stressed through nutrient deficiencies, and where possible this should be assessed via chemical analysis or by visual assessment of control plants.

Criteria for selection of test species

11. The species selected should be reasonably broad, e.g., considering their taxonomic diversity in the plant kingdom, their distribution, abundance, species specific life-cycle characteristics and region of natural occurrence, to develop a range of responses (8) (10) (16) (17) (18) (19) (20). The following characteristics of the possible test species should be considered in the selection:

- the species have uniform seeds that are readily available from reliable standard seed source(s) and that produce consistent, reliable and even germination, as well as uniform seedling growth;
- plant is amenable to testing in the laboratory, and can give reliable and reproducible results within and across testing facilities;
- the sensitivity of the species tested should be consistent with the responses of plants found in the environment exposed to the chemical;
- they have been used to some extent in previous toxicity tests and their use in, for example, herbicide bioassays, heavy metal screening, salinity or mineral stress tests or allelopathy studies indicates sensitivity to a wide variety of stressors;
- they are compatible with the growth conditions of the test method;
- they meet the validity criteria of the test.

Some of the historically most used test species are listed in Appendix 2 and potential non-crop species in Appendix 3.

12. The number of species to be tested is dependent on relevant regulatory requirements, therefore it is not specified in this test method.

Application of the test chemical

13. The chemical should be applied in an appropriate carrier (e.g. water, acetone, ethanol, polyethylene glycol, gum Arabic, sand). Mixtures (formulated products or formulations) containing active ingredients and various adjuvants can be tested as well.

Incorporation into soil/artificial substrate

14. Chemicals which are water soluble or suspended in water can be added to water, and then the solution is mixed with soil with an appropriate mixing device. This type of test may be appropriate if exposure to the chemical is through soil or soil pore-water and that there is concern for root uptake. The water-holding capacity of the soil should not be exceeded by the addition of the test chemical. The volume of water added should be the same for each test concentration, but should be limited to prevent soil agglomerate clumping.

▼M6

15. Chemicals with low water solubility should be dissolved in a suitable volatile solvent (e.g. acetone, ethanol) and mixed with sand. The solvent can then be removed from the sand using a stream of air while continuously mixing the sand. The treated sand is mixed with the experimental soil. A second control is established which receives only sand and solvent. Equal amounts of sand, with solvent mixed and removed, are added to all treatment levels and the second control. For solid, insoluble test chemicals, dry soil and the chemical are mixed in a suitable mixing device. Hereafter, the soil is added to the pots and seeds are sown immediately.

16. When an artificial substrate is used instead of soil, chemicals that are soluble in water can be dissolved in the nutrient solution just prior to the beginning of the test. Chemicals that are insoluble in water, but which can be suspended in water by using a solvent carrier, should be added with the carrier, to the nutrient solution. Water-insoluble chemicals, for which there is no non-toxic water-soluble carrier available, should be dissolved in an appropriate volatile solvent. The solution is mixed with sand or glass beads, placed in a rotary vacuum apparatus, and evaporated, leaving a uniform coating of chemical on sand or beads. A weighed portion of beads should be extracted with the same organic solvent and the chemical assayed before the potting containers are filled.

Surface application

17. For crop protection products, spraying the soil surface with the test solution is often used for application of the test chemical. All equipment used in conducting the tests, including equipment used to prepare and administer the test chemical, should be of such design and capacity that the tests involving this equipment can be conducted in an accurate way and it will give a reproducible coverage. The coverage should be uniform across the soil surfaces. Care should be taken to avoid the possibilities of chemicals being adsorbed to or reacting with the equipment (e.g. plastic tubing and lipophilic chemicals or steel parts and elements). The test chemical is sprayed onto the soil surface simulating typical spray tank applications. Generally, spray volumes should be in the range of normal agricultural practice and the volumes (amount of water etc. should be reported). Nozzle type should be selected to provide uniform coverage of the soil surface. If solvents and carriers are applied, a second group of control plants should be established receiving only the solvent/carrier. This is not necessary for crop protection products tested as formulations.

Verification of test chemical concentration/rate

18. The concentrations/rates of application must be confirmed by an appropriate analytical verification. For soluble chemicals, verification of all test concentrations/rates can be confirmed by analysis of the highest concentration test solution used for the test with documentation on subsequent dilution and use of calibrated application equipment (e.g., calibrated analytical glassware, calibration of sprayer application equipment). For insoluble chemicals, verification of compound material must be provided with weights of the test chemical added to the soil. If demonstration of homogeneity is required, analysis of the soil may be necessary.

PROCEDURE**Test design**

19. Seeds of the same species are planted in pots. The number of seeds planted per pot will depend upon the species, pot size and test duration. The number of plants per pot should provide adequate growth conditions and avoid overcrowding for the duration of the test. The maximum plant density would be around 3 - 10 seeds per 100 cm² depending to the size of the seeds. As an example, one to two corn, soybean, tomato, cucumber, or sugar beet plants per 15 cm container; three rape or pea plants per 15 cm container; and 5 to 10 onion, wheat, or other small seeds per 15 cm container are recommended.

▼ M6

The number of seeds and replicate pots (the replicate is defined as a pot, therefore plants within the same pot do not constitute a replicate) should be adequate for optimal statistical analysis (21). It should be noted that variability will be greater for test species using fewer large seeds per pot (replicate), when compared to test species where it is possible to use greater numbers of small seeds per pot. By planting equal seed numbers in each pot this variability may be minimized.

20. Control groups are used to assure that effects observed are associated with or attributed only to the test chemical exposure. The appropriate control group should be identical in every respect to the test group except for exposure to the test chemical. Within a given test, all test plants including the controls should be from the same source. To prevent bias, random assignment of test and control pots is required.
21. Seeds coated with an insecticide or fungicide (i.e. 'dressed' seeds) should be avoided. However, the use of certain non-systemic contact fungicides (e.g. captan, thiram) is permitted by some regulatory authorities (22). If seed-borne pathogens are a concern, the seeds may be soaked briefly in a weak 5 % hypochlorite solution, then rinsed extensively in running water and dried. No remedial treatment with other crop protection product is allowed.

Test conditions

22. The test conditions should approximate those conditions necessary for normal growth for the species and varieties tested (Appendix 4 provides examples of test condition). The emerging plants should be maintained under good horticultural practices in controlled environment chambers, phytotrons, or greenhouses. When using growth facilities these practices usually include control and adequately frequent (e.g. daily) recording of temperature, humidity, carbon dioxide concentration, light (intensity, wave length, photosynthetically active radiation) and light period, means of watering, etc., to assure good plant growth as judged by the control plants of the selected species. Greenhouse temperatures should be controlled through venting, heating and/or cooling systems. The following conditions are generally recommended for greenhouse testing:

- temperature: 22 °C ± 10 °C;
- humidity: 70 % ± 25 %;
- photoperiod: minimum 16 hour light;
- light intensity: 350 ± 50 µE/m²/s. Additional lighting may be necessary if intensity decreases below 200 µE/m²/s, wavelength 400 - 700 nm except for certain species whose light requirements are less.

Environmental conditions should be monitored and reported during the course of the study. The plants should be grown in non-porous plastic or

▼ M6

glazed pots with a tray or saucer under the pot. The pots may be repositioned periodically to minimize variability in growth of the plants (due to differences in test conditions within the growth facilities). The pots must be large enough to allow normal growth.

23. Soil nutrients may be supplemented as needed to maintain good plant vigour. The need and timing of additional nutrients can be judged by observation of the control plants. Bottom watering of test containers (e.g. by using glass fiber wicks) is recommended. However, initial top watering can be used to stimulate seed germination and, for soil surface application it facilitates movement of the chemical into the soil.
24. The specific growing conditions should be appropriate for the species tested and the test chemical under investigation. Control and treated plants must be kept under the same environmental conditions, however, adequate measures should be taken to prevent cross exposure (e.g. of volatile chemicals) among different treatments and of the controls to the test chemical.

Testing at a single concentration/rate

25. In order to determine the appropriate concentration/rate of a chemical for conducting a single-concentration or rate (challenge/limit) test, a number of factors must be considered. For general chemicals, these include the physical/chemical properties of the chemical. For crop protection products, the physical/chemical properties and use pattern of the test chemical, its maximum concentration or application rate, the number of applications per season and/or the persistence of the test chemical need to be considered. To determine whether a general chemical possesses phytotoxic properties, it may be appropriate to test at a maximum level of 1 000 mg/kg dry soil.

Range-finding test

26. When necessary a range-finding test could be performed to provide guidance on concentrations/rates to be tested in definitive dose-response study. For the range-finding test, the test concentrations/rates should be widely spaced (e.g. 0,1, 1,0, 10, 100 and 1 000 mg/kg dry soil). For crop protection products concentrations/rates could be based on the recommended or maximum concentration or application rate, e.g. 1/100, 1/10, 1/1 of the recommended/maximum concentration or application rate.

Testing at multiple concentrations/rates

27. The purpose of the multiple concentration/rate test is to establish a dose-response relationship and to determine an EC_x or ER_x value for emergence, biomass and/or visual effects compared to un-exposed controls, as required by regulatory authorities.
28. The number and spacing of the concentrations or rates should be sufficient to generate a reliable dose-response relationship and regression equation and give an estimate of the EC_x or ER_x . The selected concentrations/rates should encompass the EC_x or ER_x values that are to be determined. For example, if an EC_{50} value is required it would be desirable to test at rates that produce a 20 to 80 % effect. The recommended number of test concentrations/rates to achieve this is at least five in a geometric series plus untreated control, and spaced by a factor not exceeding three. For each treatment and control group, the number of replicates should be at least four and the total number of seeds should be at least 20. More replicates of certain plants with low a germination rate or variable growth habits may be needed to increase the

▼ M6

statistical power of the test. If a larger number of test concentrations/rates are used, the number of replicates may be reduced. If the NOEC is to be estimated, more replicates may be needed to obtain the desired statistical power (23).

Observations

29. During the observation period, i.e. 14 to 21 days after 50 % of the control plants (also solvent controls if applicable) have emerged, the plants are observed frequently (at least weekly and if possible daily) for emergence and visual phytotoxicity and mortality. At the end of the test, measurement of percent emergence and biomass of surviving plants should be recorded, as well as visible detrimental effects on different parts of the plant. The latter include abnormalities in appearance of the emerged seedlings, stunted growth, chlorosis, discoloration, mortality, and effects on plant development. The final biomass can be measured using final average dry shoot weight of surviving plants, by harvesting the shoot at the soil surface and drying them to constant weight at 60 °C. Alternatively, the final biomass can be measured using fresh shoot weight. The height of the shoot may be another endpoint, if required by regulatory authorities. A uniform scoring system for visual injury should be used to evaluate the observable toxic responses. Examples for performing qualitative and quantitative visual ratings are provided in references (23) (24).

DATA AND REPORTING

Statistical analysis*Single concentration/rate test*

30. Data for each plant species should be analyzed using an appropriate statistical method (21). The level of effect at the test concentration/rate should be reported, or the lack of reaching a given effect at the test concentration/rate (e.g., < x % effect observed at y concentration or rate)

Multiple concentration/rate test

31. A dose-response relationship is established in terms of a regression equation. Different models can be used: for example, for estimating EC_x or ER_x (e.g. EC_{25} , ER_{25} , EC_{50} , ER_{50}) and its confidence limits for emergence as quantal data, logit, probit, Weibull, Spearman-Kärber, trimmed Spearman-Kärber methods, etc. could be appropriate. For the growth of the seedlings (weight and height) as continuous endpoints EC_x or ER_x and its confidence limits can be estimated by using appropriate regression analysis (e.g. Bruce-Versteeg non-linear regression analysis (25)). Wherever possible, the R^2 should be 0,7 or higher for the most sensitive species and the test concentrations/rates used encompass 20 % to 80 % effects. If the NOEC is to be estimated, application of powerful statistical tests should be preferred and these should be selected on the basis of data distribution (21) (26).

Test report

32. The test report should present results of the studies as well as a detailed description of test conditions, a thorough discussion of results, analysis of the data, and the conclusions drawn from the analysis. A tabular summary and abstract of results should be provided. The report must include the following:

▼ M6*Test chemical:*

- chemical identification data, relevant properties of the chemical tested (e.g. log P_{ow} , water solubility, vapour pressure and information on environmental fate and behaviour, if available);
- details on preparation of the test solution and verification of test concentrations as specified in paragraph 18.

Test species:

- details of the test organism: species/variety, plant families, scientific and common names, source and history of the seed as detailed as possible (i.e. name of the supplier, percentage germination, seed size class, batch or lot number, seed year or growing season collected, date of germination rating), viability, etc.;
- number of mono- and di-cotyledon species tested;
- rationale for selecting the species;
- description of seed storage, treatment and maintenance.

Test conditions:

- testing facility (e.g. growth chamber, phytotron and greenhouse);
- description of test system (e.g., pot dimensions, pot material and amounts of soil);
- soil characteristics (texture or type of soil: soil particle distribution and classification, physical and chemical properties including % organic matter, % organic carbon and pH);
- soil/substrate (e.g. soil, artificial soil, sand and others) preparation prior to test;
- description of nutrient medium if used;
- application of the test chemical: description of method of application, description of equipment, exposure rates and volumes including chemical verification, description of calibration method and description of environmental conditions during application;
- growth conditions: light intensity (e.g. PAR, photosynthetically active radiation), photoperiod, max/min temperatures, watering schedule and method, fertilization;
- number of seeds per pot, number of plants per dose, number of replicates (pots) per exposure rate;
- type and number of controls (negative and/or positive controls, solvent control if used);
- duration of the test.

Results:

- table of all endpoints for each replicate, test concentration/rate and species;
- the number and percent emergence as compared to controls;
- biomass measurements (shoot dry weight or fresh weight) of the plants as percentage of the controls;

▼ M6

- shoot height of the plants as percentage of the controls, if measured;
- percent visual injury and qualitative and quantitative description of visual injury (chlorosis, necrosis, wilting, leaf and stem deformation, as well as, any lack of effects) by the test chemical as compared to control plants;
- description of the rating scale used to judge visual injury, if visual rating is provided;
- for single rate studies, the percent injury should be reported;
- EC_x or ER_x (e.g. EC₅₀, ER₅₀, EC₂₅, ER₂₅) values and related confidence limits. Where regression analysis is performed, provide the standard error for the regression equation, and the standard error for individual parameter estimate (e.g. slope, intercept);
- NOEC (and LOEC) values if calculated;
- description of the statistical procedures and assumptions used;
- graphical display of these data and dose-response relationship of the species tested.

Deviations from the procedures described in this test method and any unusual occurrences during the test.

LITERATURE

- (1) Schrader G., Metge K., and Bahadir M. (1998). Importance of salt ions in ecotoxicological tests with soil arthropods. *Applied Soil Ecology*, 7, 189-193.
- (2) International Organisation of Standards. (1993). ISO 11269-1. Soil Quality – Determination of the Effects of Pollutants on Soil Flora — Part 1: Method for the Measurement of Inhibition of Root Growth.
- (3) International Organisation of Standards. (1995). ISO 11269-2. Soil Quality – Determination of the Effects of Pollutants on Soil Flora — Part 2: Effects of Chemicals on the Emergence and Growth of Higher Plants.
- (4) American Standard for Testing Material (ASTM). (2002). E 1963-98. Standard Guide for Conducting Terrestrial Plant Toxicity Tests.
- (5) U.S. EPA. (1982). FIFRA, 40CFR, Part 158.540. Subdivision J, Parts 122-1 and 123-1.
- (6) US EPA. (1996). OPPTS Harmonized Test Guidelines, Series 850. Ecological Effects Test Guidelines:
 - 850.4000: Background — Non-target Plant Testing;
 - 850.4025: Target Area Phytotoxicity;
 - 850.4100: Terrestrial Plant Toxicity, Tier I (Seedling Emergence);
 - 850.4200: Seed Germination/Root Elongation Toxicity Test;
 - 850.4225: Seedling Emergence, Tier II;
 - 850.4230: Early Seedling Growth Toxicity Test.
- (7) AFNOR, X31-201. (1982). Essai d'inhibition de la germination de semences par une substance. AFNOR X31-203/ISO 11269-1. (1993) Determination des effets des polluants sur la flore du sol: Méthode de mesurage de l'inhibition de la croissance des racines.
- (8) Boutin, C., Freemark, K.E. and Keddy, C.J. (1993). Proposed guidelines for registration of chemical pesticides: Non-target plant testing and evaluation. Technical Report Series No.145. Canadian Wildlife Service (Headquarters), Environment Canada, Hull, Québec, Canada.

▼ **M6**

- (9) Forster, R., Heimbach, U., Kula, C., and Zwerger, P. (1997). Effects of Plant Protection Products on Non-Target Organisms — A contribution to the Discussion of Risk Assessment and Risk Mitigation for Terrestrial Non-Target Organisms (Flora and Fauna). Nachrichtenbl. Deut. Pflanzenschutzd. No 48.
- (10) Hale, B., Hall, J.C., Solomon, K., and Stephenson, G. (1994). A Critical Review of the Proposed Guidelines for Registration of Chemical Pesticides; Non-Target Plant Testing and Evaluation, Centre for Toxicology, University of Guelph, Ontario Canada.
- (11) Soil Texture Classification (US and FAO systems): Weed Science, 33, Suppl. 1 (1985) and Soil Sc. Soc. Amer. Proc. 26:305 (1962).
- (12) Audus, L.J. (1964). Herbicide behaviour in the soil. In: Audus, L.J. ed. *The Physiology and biochemistry of Herbicides*, London, New York, Academic Press, NY, Chapter 5, pp. 163-206.
- (13) Beall, M.L., Jr. and Nash, R.G. (1969). Crop seedling uptake of DDT, dieldrin, endrin, and heptachlor from soil, J. Agro. 61:571-575.
- (14) Beetsman, G.D., Kenney, D.R. and Chesters, G. (1969). Dieldrin uptake by corn as affected by soil properties, J. Agro. 61:247-250.
- (15) U.S. Food and Drug Administration (FDA). (1987). Environmental Assessment Technical Handbook. Environmental Assessment Technical Assistance Document 4.07, Seedling Growth, 14 pp., FDA, Washington, DC.
- (16) McKelvey, R.A., Wright, J.P., Honegger, J.L. and Warren, L.W. (2002). A Comparison of Crop and Non-crop Plants as Sensitive Indicator Species for Regulatory Testing. Pest Management Science vol. 58:1161-1174
- (17) Boutin, C.; Elmegaard, N. and Kjær, C. (2004). Toxicity testing of fifteen non-crop plant species with six herbicides in a greenhouse experiment: Implications for risk assessment. Ecotoxicology vol. 13(4): 349-369.
- (18) Boutin, C., and Rogers, C.A. (2000). Patterns of sensitivity of plant species to various herbicides — An analysis with two databases. Ecotoxicology vol. 9(4): 255-271.
- (19) Boutin, C. and Harper, J.L. (1991). A comparative study of the population dynamics of five species of *Veronica* in natural habitats. J. Ecol. 9:155-271.
- (20) Boutin, C., Lee, H.-B., Peart, T.E., Batchelor, S.P. and Maguire, R.J.. (2000). Effects of the sulfonylurea herbicide metsulfuron methyl on growth and reproduction of five wetland and terrestrial plant species. Envir. Toxicol. Chem. 19 (10): 2532-2541.
- (21) OECD (2006). Guidance Document, Current Approaches in the Statistical Analysis of Ecotoxicity Data: A Guidance to Application. Series on Testing and Assessment No 54, Organisation for Economic Co-operation and Development, Paris.
- (22) Hatzios, K.K. and Penner, D. (1985). Interactions of herbicides with other agrochemicals in higher plants. Rev. Weed Sci. 1:1-63.
- (23) Hamill, P.B., Marriage, P.B. and G. Friesen. (1977). A method for assessing herbicide performance in small plot experiments. Weed Science 25:386-389.
- (24) Frans, R.E. and Talbert, R.E. (1992). Design of field experiments and the measurement and analysis of plant response. In: B. Truelove (Ed.) Research Methods in Weed Science, 2nd ed. Southern weed Science Society, Auburn, 15-23.
- (25) Bruce, R.D. and Versteeg, D. J.(1992). A Statistical Procedure for Modelling Continuous Toxicity Data. Environmental Toxicology and Chemistry 11, 1485-1492.
- (26) Chapter C.33 of this Annex: Earthworm Reproduction Test (*Eisenia fetida*/*Eisenia andrei*).

▼ M6*Appendix 1***Definitions**

Active ingredient (a.i.) (or active substance (a.s.)) is a material designed to provide a specific biological effect (e.g., insect control, plant disease control, weed control in the treatment area), also known as technical grade active ingredient, active substance.

Chemical means a substance or a mixture.

Crop Protection Products (CPPs) or plant protection product (PPPs) or pesticides are materials with a specific biological activity used intentionally to protect crops from pests (e.g., fungal diseases, insects and competitive plants).

EC_x, x % Effect Concentration or ER_x, x % Effect Rate is the concentration or the rate that results in an undesirable change or alteration of x % in the test endpoint being measured relative to the control (e.g., 25 % or 50 % reduction in seedling emergence, shoot weight, final number of plants present, or increase in visual injury would constitute an EC₂₅/ER₂₅ or EC₅₀/ER₅₀ respectively).

Emergence is the appearance of the coleoptile or cotyledon above the soil surface.

Formulation is the commercial formulated product containing the active substance (active ingredient), also known as final preparation⁽¹⁾ or typical end-use product (TEP).

LOEC (Lowest Observed Effect Concentration) is the lowest concentration of the test chemical at which effect was observed. In this test, the concentration corresponding to the LOEC, has a statistically significant effect ($p < 0,05$) within a given exposure period when compared to the control, and is higher than the NOEC value.

Non-target plants: Those plants that are outside the target plant area. For crop protection products, this usually refers to plants outside the treatment area.

NOEC (No Observed Effect Concentration) is the highest concentration of the test chemical at which no effect was observed. In this test, the concentration corresponding to the NOEC, has no statistically significant effect ($p < 0,05$) within a given exposure period when compared with the control.

Phytotoxicity: Detrimental deviations (by measured and visual assessments) from the normal pattern of appearance and growth of plants in response to a given chemical.

Replicate is the experimental unit which represents the control group and/or treatment group. In these studies, the pot is defined as the replicate.

Visual assessment: Rating of visual damage based on observations of plant stand, vigour, malformation, chlorosis, necrosis, and overall appearance compared with a control.

Test Chemical: Any substance or mixture tested using this test method.

⁽¹⁾ Final Preparation: The formulated product containing the active chemical (active ingredient) sold in commerce.

▼ **M6**

Appendix 2

List of species historically used in plant testing

Family	Species	Common names
<i>DICOTYLEDONAE</i>		
Apiaceae (Umbelliferae)	<i>Daucus carota</i>	Carrot
Asteraceae (Compositae)	<i>Helianthus annuus</i>	Sunflower
Asteraceae (Compositae)	<i>Lactuca sativa</i>	Lettuce
Brassicaceae (Cruciferae)	<i>Sinapis alba</i>	White Mustard
Brassicaceae (Cruciferae)	<i>Brassica campestris</i> var. <i>chinensis</i>	Chinese cabbage
Brassicaceae (Cruciferae)	<i>Brassica napus</i>	Oilseed rape
Brassicaceae (Cruciferae)	<i>Brassica oleracea</i> var. <i>capitata</i>	Cabbage
Brassicaceae (Cruciferae)	<i>Brassica rapa</i>	Turnip
Brassicaceae (Cruciferae)	<i>Lepidium sativum</i>	Garden cress
Brassicaceae (Cruciferae)	<i>Raphanus sativus</i>	Radish
Chenopodiaceae	<i>Beta vulgaris</i>	Sugar beet
Cucurbitaceae	<i>Cucumis sativus</i>	Cucumber
Fabaceae (Leguminosae)	<i>Glycine max (G. soja)</i>	Soybean
Fabaceae (Leguminosae)	<i>Phaseolus aureus</i>	Mung bean
Fabaceae (Leguminosae)	<i>Phaseolus vulgaris</i>	Dwarf bean, French bean, Garden bean
Fabaceae (Leguminosae)	<i>Pisum sativum</i>	Pea
Fabaceae (Leguminosae)	<i>Trigonella foenum-graecum</i>	Fenugreek
Fabaceae (Leguminosae)	<i>Lotus corniculatus</i>	Birdsfoot trefoil
Fabaceae (Leguminosae)	<i>Trifolium pratense</i>	Red Clover
Fabaceae (Leguminosae)	<i>Vicia sativa</i>	Vetch
Linaceae	<i>Linum usitatissimum</i>	Flax
Polygonaceae	<i>Fagopyrum esculentum</i>	Buckwheat
Solanaceae	<i>Solanum lycopersicon</i>	Tomato

▼ **M6**

Family	Species	Common names
<i>MONOCOTYLEDONAE</i>		
Liliaceae (Amaryllidaceae)	<i>Allium cepa</i>	Onion
Poaceae (Gramineae)	<i>Avena sativa</i>	Oats
Poaceae (Gramineae)	<i>Hordeum vulgare</i>	Barley
Poaceae (Gramineae)	<i>Lolium perenne</i>	Perennial ryegrass
Poaceae (Gramineae)	<i>Oryza sativa</i>	Rice
Poaceae (Gramineae)	<i>Secale cereale</i>	Rye
Poaceae (Gramineae)	<i>Sorghum bicolor</i>	Grain sorghum, Shattercane
Poaceae (Gramineae)	<i>Triticum aestivum</i>	Wheat
Poaceae (Gramineae)	<i>Zea mays</i>	Corn

List of potential non-crop species

OECD Potential Species for Plant Toxicity Testing

Note: The following table provides information for 52 non-crop species (references are given in brackets for each entry). Emergence rates provided are from published literature and are for general guidance only. Individual experience may vary depending upon seed source and other factors.

FAMILY Species Botanical Name (English Common Name)	Lifespan (1) & Habitat	Seed Weight (mg)	Photoperiod for germination or growth (2)	Planting Depth (mm) (3)	Time to Germinate (days) (4)	Special Treatments (5)	Toxicity Test (6)	Seed Suppliers (7)	Other References (8)
APIACEAE <i>Torilis japonica</i> (Japanese Hedge-parsley)	A, B disturbed areas, hedgerows, pastures (16, 19)	1,7-1,9 (14, 19)	L = D (14)	0 (1, 19)	5 (50 %) (19)	cold stratification (7, 14, 18, 19) maturation may be necessary (19) germination inhibited by darkness (1, 19) no special treatments (5)	POST (5)		
ASTERACEAE <i>Bellis perennis</i> (English Daisy)	P grassland, arable fields, turf (16, 19)	0,09-0,17 (4, 19)	L = D (14)	0 (4)	3 (50 %) (19) 11 (100 %) (18)	germination not affected by irradiance (18, 19) no special treatments (4, 14)	POST (4)	A, D, F	7
<i>Centaurea cyanus</i> (Cornflower)	A fields, roadsides, open habitats (16)	4,1 -4,9 (4, 14)	L = D (14)	0-3 (2, 4, 14)	14-21 (100 %) (14)	no special treatments (2, 4)	POST (2,4)	A, D, E, F	7
<i>Centaurea nigra</i> (Black Knapweed)	P fields, roadsides, open habitats (16, 19)	2,4-2,6 (14, 19)	L = D (14)	0 (19)	3 (50 %) (19) 4 (97 %) (18)	maturation may be necessary (18, 19) germination inhibited by darkness (19) no special treatments (5, 14, 26)	POST (5, 22, 26)	A	
<i>Inula helenium</i> Elecampane	P moist, disturbed sites (16)	1-1,3 (4, 14, 29)		0 (4, 29)		no special treatments (4)	POST (4)	A, F	

▼M6

FAMILY Species Botanical Name (English Common Name)	Lifespan (1) & Habitat	Seed Weight (mg)	Photoperiod for germination or growth (2)	Planting Depth (mm) (3)	Time to Germinate (days) (4)	Special Treatments (5)	Toxicity Test (6)	Seed Suppliers (7)	Other References (8)
<i>Leontodon hispidus</i> (Big Hawkbit)	P fields, roadsides, disturbed areas (16, 19)	0,85 -1,2 (14, 19)	L = D (14)	0 (19)	4 (50 %) (19) 7 (80 %) (18)	germination inhibited by darkness (17, 18, 19) no special treatments (5, 23)	POST (5, 22, 23)		
<i>Rudbeckia hirta</i> (Black-eyed Susan)	B, P disturbed (16)	0,3 (4, 14)	L = D (14)	0 (4, 33)	< 10 (100 %) (33)	no special treatments (4, 14, 33)	POST (4, 33)	C, D, E, F	
<i>Solidago canadensis</i> Canada Goldenrod	P pasture, open areas (16)	0,06-0,08 (4, 14)	L = D (11)	0 (4)	14-21 (11)	mix with equal part sand and soak in 500 ppm GA for 24 hrs (11) no special treatments (4)	POST (4)	E, F	
<i>Xanthium pensylvanicum</i> (Common Cocklebur)	A fields, open habitats (16)	25-61 (14, 29)		0(1) 5(29)		germination may be inhibited by darkness (1) soak in warm water for 12 hrs (29)	PRE & POST (31)	A	
<i>Xanthium spinosum</i> (Spiny Cocklebur)	A open habitats (16)	200 (14)	L = D (14) L > D (6)	10 (6)		scarification (14) no special treatments (6)	PRE & POST (6)	A	
<i>Xanthium strumarium</i> (Italian Cocklebur)	A fields, open habitats (16)	67,4 (14)	L = D (14)	10-20 (6, 21)		no special treatments (6, 14, 21)	PRE & POST (6, 21, 28, 31)	A	
BRASSICACEAE <i>Cardamine pratensis</i> (Cuckoo Flower)	P fields, roadsides, turf (16, 19)	0,6 (14, 19)	L = D (14)	0 (19)	5 (50 %) (19) 15 (98 %) (18)	germination inhibited by darkness (18, 19) no special treatments (5, 14, 22)	POST (5, 22)	F	

▼M6

FAMILY Species Botanical Name (English Common Name)	Lifespan (1) & Habitat	Seed Weight (mg)	Photoperiod for germination or growth (2)	Planting Depth (mm) (3)	Time to Germinate (days) (4)	Special Treatments (5)	Toxicity Test (6)	Seed Suppliers (7)	Other References (8)
CARYOPHYLLACEAE <i>Lychnis flos-cuculi</i> (Ragged Robin)	P (16)	0,21 (14)	L = D (14)		< 14 (100 %) (14, 25)	maturation may be necessary (18) no special treatments (5, 14, 15, 22-26)	POST (5, 15, 22-26)	F	
CHENOPODIACEAE <i>Chenopodium album</i> (Lamb's Quarters)	A field margins, disturbed areas (16, 19)	0,7- 1,5 (14, 19, 34)	L = D (14)	0 (1, 19)	2 (50 %) (19)	treatment differs depending on seed colour (19) dry storage dormancy (19) germination inhibited by darkness (1, 18, 19) cold stratification (18) no special treatments (14, 34)	PRE & POST (28, 31, 34)	A	32
CLUSIACEAE <i>Hypericum perforatum</i> (Common St. John's Wort)	P fields, arable land, open habitats (16, 19)	0,1 -0,23 (14, 19)	L = D (14)	0 (1, 19)	3 (19) 11 (90 %) (18)	germination inhibited by darkness (1, 18, 19) no special treatments (5, 14, 15, 25, 27)	POST (5, 15, 25, 27)	A, E, F	
CONVOLVULACEAE <i>Ipomoea hederacea</i> (Purple Morning Glory)	A roadsides, open habitats, cornfields (16)	28,2 (14)	L > D (6, 10)	10-20 (6, 10, 21)	4 (100 %) (10)	germination not affected by irradiance (1) no special treatments (6, 21)	PRE & POST (6, 12, 21, 28)	A	
CYPERACEAE <i>Cyperus rotundus</i> (Purple Nutsedge)	P arable land, pastures, roadsides (16, 30)	0,2 (14)	L = D (14)	0 (1) 10-20 (6, 10)	12 (91 %) (10)	germination inhibited by darkness (1) no special treatments (6, 10, 14)	PRE & POST (6, 28, 31)	B	7
FABACEAE <i>Lotus corniculatus</i> (Bird's-foot Trefoil)	P grassy areas, roadsides, open habitats (16, 19)	1-1,67 (14, 19)	L = D (14)		1 (50 %) (19)	scarification (14, 19) germination not affected by irradiance (18, 19) no special treatments (23, 25)	POST (5, 23, 25)	A, D, E, F	

▼M6

FAMILY Species Botanical Name (English Common Name)	Lifespan (1) & Habitat	Seed Weight (mg)	Photoperiod for germination or growth (2)	Planting Depth (mm) (3)	Time to Germinate (days) (4)	Special Treatments (5)	Toxicity Test (6)	Seed Suppliers (7)	Other References (8)
<i>Senna obtusifolia</i> (Cassia, Sicklepod)	A moist woods (16)	23-28 (9)	L = D (14) L > D (9)	10-20 (6,9)		soak seeds in water for 24 hours (9) scarification (14) seed viability differs depending on colour (1) no special treatments (6)	POST (6,9)	A	
<i>Sesbania exaltata</i> (Hemp)	A alluvial soil (16)	11- 13 (9, 14)	L > D (9)	10-20 (9, 21)		soak seeds in water for 24 hours (9) germination not affected by irradiance (1) no special treatments (21)	PRE & POST (9, 21, 28, 31)	A	
<i>Trifolium pratense</i> (Red Clover)	P fields, roadsides, arable land (16, 19)	1,4- 1,7 (14, 19)	L = D (14)		1 (50 %) (19)	scarification (14, 18) may need maturation (19) germination not affected by irradiance (1, 19) no special treatments (5)	POST (5)	A, E, F	
LAM IAC E AE <i>Leonurus cardiaca</i> (Motherwort)	P open areas (16)	0,75 -1,0 (4, 14)	L = D (14)	0 (4)		no special treatments (4, 14)	POST (4)	F	
<i>Mentha spicata</i> (Spearmint)	P moist areas (16)	2,21 (4)		0 (4)		no special treatments (4)	POST (4)	F	
<i>Nepeta cataria</i> (Catnip)	P disturbed areas (16)	0,54 (4, 14)	L = D (14)	0 (4)		no special treatments (2, 4, 14)	POST (2,4)	F	

▼ M6

FAMILY Species Botanical Name (English Common Name)	Lifespan (1) & Habitat	Seed Weight (mg)	Photoperiod for germination or growth (2)	Planting Depth (mm) (3)	Time to Germinate (days) (4)	Special Treatments (5)	Toxicity Test (6)	Seed Suppliers (7)	Other References (8)
<i>Prunella vulgaris</i> (Self-heal)	P arable fields, grassy areas, disturbed sites (16, 19)	0,58 -1,2 (4, 14, 19)	L = D (14)	0 (4, 19)	5 (50 %) (19) 7 (91 %) (18)	germination inhibited by darkness (18, 19) greater germination with larger seeds (1) no special treatments (4, 14, 22)	POST (4, 22)	A, F	
<i>Stachys officinalis</i> (Hedge-nettle)	P grasslands, field margins (19)	14-18 (14, 19)	L = D (14)		7 (50 %) (19)	no special treatments (5, 14, 22)	POST (5, 22)	F	
MALVACEAE <i>Abutilón theophrasti</i> (Velvetleaf)	A fields, open habitats (16)	8,8 (14)	L = D (14)	10-20 (6, 10, 21)	4 (84 %) (10)	scarification (14) no special treatments (5, 10, 21)	PRE & POST (6, 22, 28, 31)	A, F	
<i>Sida spinosa</i> (Prickly Sida)	A fields, roadsides (16)	3,8 (14)	L = D (14)	10-20 (6, 21)		scarification (14) germination not affected by irradiance (1) no special treatments (6, 21)	PRE & POST (6, 21, 28, 31)	A, F	
PAPAVERACEAE <i>Papaver rhoeas</i> (Poppy)	A fields, arable land, disturbed sites (16, 19)	0,1 -0,3 (4, 14, 19, 29)	L = D (14)	0 (4, 29)	4 (50 %) (19)	cold stratification & scarification (1, 19, 32) no special treatments (4, 14, 29)	POST (4)	A, D, E, F, G	
POACEAE <i>Agrostis tenuis</i> (Common Bentgrass)	lawns, pastures (16)	0,07 (14)	L > D (10)	20 (10)	10 (62 %) (10)	germination inhibited by darkness (1, 17-19) no special treatments (10)	POST (10)	A, E	
<i>Alopecurus myosuroides</i> (Foxtail)	A fields, open habitats (16)	0,9-1,6 (29, 34)	L = D (14)	2 (29)	< 24 (30 %) (34)	scarification (14) treat with 101 mg/L KNO ₃ (14) warm stratification (1) germination inhibited by darkness (1) no special treatments (34)	PRE & POST (28, 34)	A	32

▼ M6

FAMILY Species Botanical Name (English Common Name)	Lifespan (1) & Habitat	Seed Weight (mg)	Photoperiod for germination or growth (2)	Planting Depth (mm) (3)	Time to Germinate (days) (4)	Special Treatments (5)	Toxicity Test (6)	Seed Suppliers (7)	Other References (8)
<i>Avena fatua</i> (Wild Oats)	A cultivated areas, open habitats (16)	7-37,5 (14, 30)	L = D (14) L > D (6)	10-20 (6, 10)	3 (70 %) (18)	scarification (7, 32) darkness inhibits germination (1) cold stratification (1, 18) no special treatments (6, 10, 14)	PRE & POST (6, 10, 28, 31)	A	
<i>Bromus tectorum</i> (Downy Brome)	A fields, roadsides, arable land (16)	0,45-2,28 (14, 29)	L = D (14)	3 (29)		maturation period (1, 7, 32) germination inhibited by light (1) no special treatments (14)	PRE & POST (28, 31)	A	
<i>Cynosurus cristatus</i> (Dog's-tail Grass)	P fields, roadsides, open habitats (16, 19)	0,5-0,7 (14, 19, 29)	L = D (14)	0 (29)	3 (50 %) (19)	germination not affected by irradiance (19) no special treatments (14, 29)	POST (5)	A	
<i>Digitaria sanguinalis</i> (Crabgrass)	A fields, turf, open habitats (16)	0,52-0,6 (14, 30)	L = D (14)	10-20 (21)	7 (75 %) 14 (94 %) (7)	scarification, cold stratification, & maturation (1, 7, 14, 32) treat with 101 mg/L KNO ₃ (14) germination inhibited by darkness (1) no special treatments (21)	PRE & POST (18, 25, 31)	A	
<i>Echinochloa crusgalli</i> (Barnyard Grass)	A (16)	1,5 (14)	L = D (14) L > D (3)	10-20 (7, 21)		scarification (7, 32) germination not affected by irradiance (1) no special treatments (3, 14, 21)	PRE & POST (3, 21, 28, 31)	A	
<i>Elymus canadensis</i> (Canada Wild Rye)	P riparian, disturbed sites (16)	4-5 (14, 30)	L = D (11)	1 (11)	14-28 (11)	no special treatments (2, 11)	POST (2)	C, D, E	
<i>Festuca pratensis</i> (Fescue)	P fields, moist areas (16, 19)	1,53-2,2 (16, 19)	L = D (14) L > D (10)	20 (10)	9 (74 %) (10) 2 (50 %) (19)	no special treatments (10, 19)	POST (10)	A	7

▼ M6

FAMILY Species Botanical Name (English Common Name)	Lifespan (1) & Habitat	Seed Weight (mg)	Photoperiod for germination or growth (2)	Planting Depth (mm) (3)	Time to Germinate (days) (4)	Special Treatments (5)	Toxicity Test (6)	Seed Suppliers (7)	Other References (8)
<i>Hordeum pusillum</i> (Little Barley)	A pastures, roadsides, open habitats (16)	3,28 (14)				warm stratification (1) germination not affected by irradiance (1)	PRE (31)		7
<i>Phieum pratense</i> (Timothy)	P pastures, arable fields, disturbed sites (16, 19)	0,45 (14, 19)	L > D (10, 14)	0-10 (10, 19)	2 (74 %) (10) 8 (50 %) (19)	germination inhibited by darkness (19) germination not affected by irradiance (17) no special treatments (10, 14, 17, 19)	POST (10)	A, E	
POLYGONACEAE <i>Polygonum convolvulus</i> (Black Bindweed)	A open habitats, roadsides (16)	5-8 (4, 14, 29)	L = D (20)	0-2 (4, 29)		cold stratification for 4 — 8 weeks (1, 2, 4, 20, 29) germination not affected by irradiance (1)	PRE & POST 1, 2, 20, 28, 31	A	32
<i>Polygonum lapathifolium</i> (Pale Persicaria)	A moist soil (16)	1,8-2,5 (14)	L > D (6)		5 (94 %) (18)	germination not affected by irradiance (1) germination inhibited by darkness (18) cold stratification (1) no special treatments (5)	PRE & POST (6)	A, E	
<i>Polygonum pennsylvanicum</i> (Pennsylvania Smartweed)	A fields, open habitats (16)	3,6-7 (14, 29)		2 (29)		cold stratification for 4 wks at 0 — 5oC (1, 29) germination inhibited by darkness (1)	PRE (31)	A, E	
<i>Polygonum periscaria</i> (Smartweed)	A disturbed areas, arable land (16, 19)	2,1 -2,3 (14, 19)	L > D (13)	0 (19)	< 14 (13) 2 (50 %) (19)	scarification, cold stratification, GA treatment (14) cold stratification, maturation (17-19) germination inhibited by darkness (19) no special treatments (13)	POST (13)	A	32

▼ M6

FAMILY Species Botanical Name (English Common Name)	Lifespan (1) & Habitat	Seed Weight (mg)	Photoperiod for germination or growth (2)	Planting Depth (mm) (3)	Time to Germinate (days) (4)	Special Treatments (5)	Toxicity Test (6)	Seed Suppliers (7)	Other References (8)
<i>Rumex crispus</i> (Curly Dock)	P arable fields, roadsides open areas (16, 19)	1,3-1,5 (4, 14, 19)	L = D (14, 33)	0 (4, 19, 33)	3 (50 %) (19) 6 (100 %) (33)	germination inhibited by darkness (18, 19) maturation may be necessary (18) no special treatments (4, 14, 33)	POST (4, 33)	A, E	32
PRIMULACEAE <i>Anagallis arvensis</i> (Scarlett Pimpernel)	A arable fields, open areas, disturbed sites (16, 19)	0,4-0,5 (4, 14, 19)	L = D (14)		1 (50 %) (19)	cold stratification, GA treatment (1,14, 18, 19, 32) light required for germination (1) no special treatments (2, 4)	POST (2,4)	A, F	
RANUNCULACEAE <i>Ranunculus acris</i> (Common Buttercup)	P arable fields, roadsides, open areas (16, 19)	1,5-2 (14, 19, 29)	L = D (14)	1 (29)	41 -56 (19, 29)	no special treatments (5, 14, 22, 24 -26)	POST (5, 22, 24- 26)		32
ROSACEAE <i>Geum urbanum</i> (Yellow Avens)	P hedgerows, moist areas (16, 19)	0,8 — 1,5 (14, 19)	L = D (14)	0 (19)	5 (50 %) (19) 16 (79 %) (18)	germination inhibited by darkness (18, 19) warm stratifi- cation (1) no special treatments (5, 14, 22, 25, 26)	POST (5, 22, 25, 26)	A	
RUBIACEAE <i>Galium aparine</i> (Cleavers)	A arable fields, moist areas, disturbed sites (16, 19)	7-9 (14, 19)	L = D (14)		5 (50 %) (19) 6 (100 %) (18)	cold stratification (1, 18, 19) germination not affected by irradiance (18, 19) light inhibits germination (1) no special treatments (6, 14)	PRE & POST (6, 28)	A	32

▼ **M6**

FAMILY Species Botanical Name (English Common Name)	Lifespan ⁽¹⁾ & Habitat	Seed Weight (mg)	Photoperiod for germination or growth ⁽²⁾	Planting Depth (mm) ⁽³⁾	Time to Germinate (days) ⁽⁴⁾	Special Treatments ⁽⁵⁾	Toxicity Test ⁽⁶⁾	Seed Suppliers ⁽⁷⁾	Other References ⁽⁸⁾
<i>Galium mollugo</i> (Hedge Bedstraw)	P hedgebanks, open areas (8)	7 (29)	L = D (14)	2 (29)		no special treatments (5, 14, 22, 24, 26, 29)	POST (5, 22, 24, 26)	A	
SCROPHULARIACEAE <i>Digitalis purpurea</i> (Foxglove)	B, P hedgerows, open areas (16, 19)	0,1 -0,6 (4, 14, 19)	L = D (14)	0 (4, 19)	6 (50 %) (19) 8 (99 %) (18)	germination inhibited by darkness (1, 17-19) no special treatments (4, 22-26)	POST (4, 22 — 26)	D, G, F	
<i>Veronica persica</i> (Speedwell)	A arable fields, open areas, disturbed sites (16, 19)	0,5-0,6 (14, 19)	L = D (14)	0 (19)	3(19) 5 (96 %) (18)	germination inhibited by darkness (18, 19) cold stratification (18) no special treatments (14)	PRE & POST (28)	A	32

⁽¹⁾ A = Annuals, B = Biennials, P = Perennials.

⁽²⁾ References 11,14 and 33 refer to proportion of light (L) and darkness (D) required to induce seed germination. References 3, 6, 9, 10, 13, 20 refer to growing conditions in greenhouses.

⁽³⁾ 0 mm indicates seeds were sown on the soil surface or that seeds need light to germinate.

⁽⁴⁾ The numbers provided represent the number of days in which a percent of seeds germinated according to provided reference, e.g., 3 days (50 %) germination (reference 19).

⁽⁵⁾ Duration of maturation and or stratification not always available. Except for cold treatment requirements, temperature conditions are not specified since in greenhouse testing there is limited temperature control. Most seeds will germinate under normal fluctuation of temperatures found in greenhouses.

⁽⁶⁾ Indicates species was utilized in either a pre-emergence (PRE) and/or post-emergence (POST) plant toxicity test involving herbicides.

⁽⁷⁾ Provides example(s) of commercial seed suppliers.

⁽⁸⁾ Provides two alternative reference(s) that were consulted.

▼ **M6****Seed Suppliers Cited**

Supplier ID	Supplier Information
A	Herbiseed New Farm, Mire Lane, West End, Twyford RG10 0NJ ENGLAND +44 (0) 1189 349 464 www.herbiseed.com
B	Tropilab Inc. 8240 Ulmerton Road, Largo, FL 33771-3948 USA (727) 344 - 4050 www.tropilab.com
C	Pterophylla — Native Plants & Seeds #316 Regional Road 60, RR#1, Walsingham, ON N0E 1X0 CANADA (519) 586 - 3985
D	Applewood Seed Co. 5380 Vivian St., Arvada, CO 80002 USA (303) 431 - 7333 www.applewoodseed.com
E	Ernst Conservation Seeds 9006 Mercer Pike, Meadville, PA 16335 USA (800) 873 - 3321 www.ernstseed.com
F	Chiltern Seeds Bortree Stile, Ulverston, Cumbria LA12 7PB ENGLAND +44 1229 581137 www.chilternseeds.co.uk
G	Thompson & Morgan P.O. Box 1051, Fort Erie, ON L2A 6C7 CANADA (800) 274 - 7333 www.thompson-morgan.com

REFERENCES CITED

- (1) Baskin, C.C. & Baskin, J.M. 1998. Seeds. Academic Press, Toronto
- (2) Blackburn, L.G. & Boutin, C. 2003. Subtle effects of herbicide use in the context of genetically modified crops: a case study with glyphosate (Round-Up®). *Ecotoxicology*, 12:271-285.
- (3) Boutin, C., Lee, H-B., Peart, T., Batchelor, P.S., & Maguire, R.J. 2000. Effects of the sulfonylurea herbicide metsulfuron methyl on growth and reproduction of five wetland and terrestrial plant species. *Environmental Toxicology & Chemistry*, 19(10):2532-2541.
- (4) Boutin, C., Elmegaard, N., & Kjaer, C. 2004. Toxicity testing of fifteen non-crop plant species with six herbicides in a greenhouse experiment: implications for risk assessment. *Ecotoxicology*, 13:349-369.
- (5) Breeze, V., Thomas, G., & Butler, R. 1992. Use of a model and toxicity data to predict the risks to some wild plant species from drift of four herbicides. *Annals of Applied Biology*, 121:669-677.
- (6) Brown, R.A., & Farmer, D. 1991. Track-sprayer and glasshouse techniques for terrestrial plant bioassays with pesticides. In: *Plants for toxicity assessment: 2nd volume*. ASTM STP 1115, J.W. Gorsuch, W.R. Lower, W. Wang, & M.A. Lewis, eds. American Society for Testing & Materials, Philadelphia. pp 197 - 208.

▼ **M6**

- (7) Buhler, D.D. & Hoffman, M.L. 1999. Anderson's guide to practical methods of propagating weeds and other plants. Weed Science Society of America, Lawrence, K.
- (8) Clapham, A.R., Tutin, T.G., & Warburg, E.F. 1981. Excursion flora of the British Isles, 3rd ed. Cambridge University Press, Cambridge
- (9) Clay, P.A. & Griffin, J.L. 2000. Weed seed production and seedling emergence response to late-season glyphosate applications. *Weed Science*, 48:481-486.
- (10) Cole, J.F.H. & Canning, L. 1993. Rationale for the choice of species in the regulatory testing of the effects of pesticides on terrestrial non-target plants. BCPC — Weeds. pp. 151 - 156.
- (11) Fiely, M. (Ernst Conservation Seeds). 2004. Personal communication. (www.ernstseed.com)
- (12) Fletcher, J.S., Johnson, F.L., & McFarlane, J.C. 1990. Influence of greenhouse versus field testing and taxonomic differences on plant sensitivity to chemical treatment. *Environmental Toxicology & Chemistry*, 9:769-776.
- (13) Fletcher, J.S., Pflieger, T.G., Ratsch, H.C., & Hayes, R. 1996. Potential impact of low levels of chlorsulfuron and other herbicides on growth and yield of nontarget plants. *Environmental Toxicology & Chemistry*, 15(7):1189-1196.
- (14) Flynn, S., Turner, R.M., and Dickie, J.B. 2004. Seed Information Database (release 6.0, Oct 2004) Royal Botanic Gardens, Kew (www.rbgekew.org.uk/data/sid)
- (15) Franzaring, J., Kempenaar, C., & van der Eerden, L.J.M. 2001. Effects of vapours of chlorpropham and ethofumesate on wild plant species. *Environmental Pollution*, 114:21-28.
- (16) Gleason, H.A. & Cronquist, A. 1991. Manual of vascular plants of north-eastern United States and adjacent Canada, 2nd ed. New York Botanical Garden, Bronx, NY
- (17) Grime, J.P. 1981. The role of seed dormancy in vegetation dynamics. *Annals of Applied Biology*, 98:555-558.
- (18) Grime, J.P., Mason, G., Curtis, A.V., Rodman, J., Band, S.R., Mowforth, M.A.G., Neal, A.M., & Shaw, S. 1981. A comparative study of germination characteristics in a local flora. *Journal of Ecology*, 69:1017-1059.
- (19) Grime, J.P., Hodgson, J.G., & Hunt, R. 1988. Comparative plant ecology: a functional approach to common British species. Unwin Hyman Ltd., London
- (20) Kjaer, C. 1994. Sublethal effects of chlorsulfuron on black bindweed (*Polygonum convolvulus* L.). *Weed Research*, 34:453-459.
- (21) Klingaman, T.E., King, C.A., & Oliver, L.R. 1992. Effect of application rate, weed species, and weed stage of growth on imazethapyr activity. *Weed Science*, 40:227-232.
- (22) Marrs, R.H., Williams, C.T., Frost, A.J., & Plant, R.A. 1989. Assessment of the effects of herbicide spray drift on a range of plant species of conservation interest. *Environmental Pollution*, 59:71-86.
- (23) Marrs, R.H., Frost, A.J., & Plant, R.A. 1991. Effects of herbicide spray drift on selected species of nature conservation interest: the effects of plant age and surrounding vegetation structure. *Environmental Pollution*, 69:223-235.
- (24) Marrs, R.H., Frost, A.J., & Plant, R.A. 1991. Effects of mecoprop drift on some plant species of conservation interest when grown in standardized mixtures in microcosms. *Environmental Pollution*, 73:25-42.
- (25) Marrs, R.H., Frost, A.J., Plant, R.A., & Lunnis, P. 1993. Determination of buffer zones to protect seedlings of non-target plants from the effects of glyphosate spray drift. *Agriculture, Ecosystems, & Environment*, 45:283-293.

▼ M6

- (26) Marrs, R.H. & Frost, A.J. 1997. A microcosm approach to detection of the effects of herbicide spray drift in plant communities. *Journal of Environmental Management*, 50:369-388.
- (27) Marshall, E.J.P. & Bernie, J.E. 1985. Herbicide effects on field margin flora. *BCPC — Weeds*. pp. 1021-1028.
- (28) McKelvey, R.A., Wright, J.P., & Honegger, J.L. 2002. A comparison of crop and non-crop plants as sensitive species for regulatory testing. *Pest Management Science*, 58:1161-1174.
- (29) Morton, S. (Herbiseed). 2004. Personal communication. (<http://www.herbiseed.com>)
- (30) USDA, NRCS. 2004. The Plants Database, version 3.5. (<http://plants.usda.gov>). National Plant Data Centre, Baton Rouge, LA 70874-4490 USA
- (31) USEPA. 1999. One-Liner Database. [U.S. E.P.A./Office of Pesticide Programs/Environmental Fate and Effects Division/Environmental Epidemiology Branch].
- (32) Webster, R.H. 1979. Technical Report No. 56: Growing weeds from seeds and other propagules for experimental purposes. Agricultural Research Council Weed Research Organization, Oxford.
- (33) White, A. L. & Boutin, C. (National Wildlife Research Centre, Environment Canada). 2004. Personal communication.
- (34) Zwerger, P. & Pestemer, W. 2000. Testing the phytotoxic effects of herbicides on higher terrestrial non-target plants using a plant life-cycle test. *Z. PflKrankh. PflSchutz, Sonderh.*, 17:711-718.

▼ M6*Appendix 4***Examples for appropriate growth conditions for certain crop species**

The following conditions have been found suitable for 10 crop species, and can be used as a guidance for tests in growth chambers with certain other species as well:

Carbon dioxide concentration: 350 ± 50 ppm;

Relative humidity: 70 ± 5 % during light periods and 90 ± 5 % during dark periods;

Temperature: 25 ± 3 °C during the day, 20 ± 3 °C during the night;

Photoperiod: 16 hour light/8 hour darkness, assuming an average wavelength of 400 to 700 nm;

Light: luminance of 350 ± 50 $\mu\text{E}/\text{m}^2/\text{s}$, measured at the top of the canopy.

The crop species are:

- tomato (*Solanum lycopersicon*);
- cucumber (*Cucumis sativus*);
- lettuce (*Lactuca sativa*);
- soybean (*Glycine max*);
- cabbage (*Brassica oleracea* var. *capitata*);
- carrot (*Daucus carota*);
- oats (*Avena sativa*);
- perennial ryegrass (*Lolium perenne*);
- corn (*Zea mays*);
- onion (*Allium cepa*).

▼ M6**C.32. ENCHYTRAEID REPRODUCTION TEST**

INTRODUCTION

1. This test method is equivalent to OECD test guideline (TG) 220 (2004). It is designed to be used for assessing the effects of chemicals on the reproductive output of the enchytraeid worm, *Enchytraeus albidus* Henle 1873, in soil. It is based principally on a method developed by the Umweltbundesamt, Germany (1) that has been ring-tested (2). Other methods for testing the toxicity of chemicals to Enchytraeidae and earthworms have also been considered (3)(4)(5)(6)(7)(8).

INITIAL CONSIDERATIONS

2. Soil-dwelling annelids of the genus *Enchytraeus* are ecologically relevant species for ecotoxicological testing. Whilst enchytraeids are often found in soils containing earthworms it is also true that they are often abundant in many soils where earthworms are absent. Enchytraeids can be used in laboratory tests as well as in semi-field and field studies. From a practical point of view, many *Enchytraeus* species are easy to handle and breed, and their generation time is significantly shorter than that of earthworms. The duration for a reproduction test with enchytraeids is therefore only 4-6 weeks while for earthworms (*Eisenia fetida*) it is 8 weeks.
3. Basic information on the ecology and ecotoxicology of enchytraeids in the terrestrial environment can be found in (9)(10)(11)(12).

PRINCIPLE OF THE TEST

4. Adult enchytraeid worms are exposed to a range of concentrations of the test chemical mixed into an artificial soil. The test can be divided into two steps: (a) a range-finding test, in case no sufficient information is available, in which mortality is the main endpoint assessed after two weeks exposure and (b) a definitive reproduction test in which the total number of juveniles produced by parent animal and the survival of parent animals are assessed. The duration of the definitive test is six weeks. After the first three weeks, the adult worms are removed and morphological changes are recorded. After an additional three weeks, the number of offspring, hatched from the cocoons produced by the adults, is counted. The reproductive output of the animals exposed to the test chemical is compared to that of the control(s) in order to determine (i) the no observed effect concentration (NOEC) and/or (ii) EC_x (e.g. EC_{10} , EC_{50}) by using a regression model to estimate the concentration that would cause a x % reduction in reproductive output. The test concentrations should bracket the EC_x (e.g. EC_{10} , EC_{50}) so that the EC_x then comes from interpolation rather than extrapolation.

INFORMATION ON THE TEST CHEMICAL

5. The water solubility, the $\log K_{ow}$, the soil water partition coefficient (e.g. Chapter C.18 or C.19 of this Annex) and the vapour pressure of the test chemical should preferably be known. Additional information on the fate of the test chemical in soil, such as the rates of photolysis and hydrolysis is desirable.
6. This test method can be used for water soluble or insoluble chemicals. However, the mode of application of the test chemical will differ accordingly. The test method is not applicable to volatile chemicals, i.e. chemicals for which the Henry's constant or the air/water partition coefficient is greater than one, or chemicals for which the vapour pressure exceeds 0,0133 Pa at 25 °C.

▼M6

VALIDITY OF THE TEST

7. For the test to be valid, the following performance criteria should be met in the controls:
- adult mortality should not exceed 20 % at the end of the range-finding test and after the first three weeks of the reproduction test.
 - assuming that 10 adults per vessel were used in setting up the test, an average of at least 25 juveniles per vessel should have been produced at the end of the test.
 - the coefficient of variation around the mean number of juveniles should not be higher than 50 % at the end of the reproduction test.

Where a test fails to meet the above validity criteria the test should be terminated unless a justification for proceeding with the test can be provided. The justification should be included in the test report.

REFERENCE CHEMICAL

8. A reference chemical should be tested either at regular intervals or possibly included in each test to verify that the response of the test organisms has not changed significantly over time. A suitable reference chemical is carbendazim, which has been shown to affect survival and reproduction of enchytraeids (13)(14), or other chemicals whose toxicity data are well known could be also used. A formulation of carbendazim known by the trade name of Derosal™ supplied by AgrEvo Company (Frankfurt, Germany) and containing 360 g/l (32,18 %) active ingredient was used in a ring-test (2). The EC₅₀ for reproduction determined in the ring test was in the range of 1,2 ± 0,8 mg active ingredient (a.i) /kg dry mass (2). If a positive toxic standard is included in the test series, one concentration is used and the number of replicates should be the same as that in the controls. For carbendazim, the testing of 1,2 mg a.i./kg dry weight (tested as a liquid formulation) is recommended.

DESCRIPTION OF THE TEST

Equipment

9. The test vessels should be made of glass or other chemically inert material. Glass jars (e.g. volume: 0,20 - 0,25 litre; diameter: ≈ 6 cm) are suitable. The vessels should have transparent lids (e.g. glass or polyethylene) that are designed to reduce water evaporation whilst allowing gas exchange between the soil and the atmosphere. The lids should be transparent to allow light transmission.
10. Normal laboratory equipment is required, specifically the following:
- drying cabinet;
 - stereomicroscope;
 - pH-meter and photometer;
 - suitable accurate balances;
 - adequate equipment for temperature control;
 - adequate equipment for humidity control (not essential if exposure vessels have lids);
 - incubator or small room with air-conditioner;
 - tweezers, hooks or loops;
 - photo basin.

Preparation of the artificial soil

11. An artificial soil is used in this test (5)(7) with the following composition (based on dry weights, dried to a constant weight at 105 °C):

▼ **M6**

- 10 % sphagnum peat, air-dried and finely ground (a particle size of 2 ± 1 mm is acceptable); it is recommended to check that a soil prepared with a fresh batch of peat is suitable for culturing the worms before it is used in a test;
- 20 % kaolin clay (kaolinite content preferably above 30 %);
- approximately 0,3 to 1,0 % calcium carbonate (CaCO_3 , pulverised, analytical grade) to obtain a pH of $6,0 \pm 0,5$; the amount of calcium carbonate to be added may depend principally on the quality/nature of the peat;
- approximately 70 % air-dried quartz sand (depending on the amount of CaCO_3 needed), predominantly fine sand with more than 50 % of the particles between 50 and 200 microns.

It is advisable to demonstrate the suitability of an artificial soil for culturing the worms and for achieving the test validity criteria before using the soil in a definitive test. It is especially recommended to make such a check to ensure that the performance of the test is not compromised if the organic carbon content of the artificial soil is reduced, e.g. by lowering the peat content to 4-5 % and increasing the sand content accordingly. By such a reduction in organic carbon content, the possibilities of adsorption of test chemical to the soil (organic carbon) may be decreased and the availability of the test chemical to the worms may increase. It has been demonstrated that *Enchytraeus albidus* can comply with the validity criteria on reproduction when tested in field soils with lower organic carbon content than mentioned above (e.g. 2,7 %) (15), and there is experience — though limited — that this can also be achieved in artificial soil with 5 % peat.

Note: When using natural soil in additional (e.g. higher tier) testing, the suitability of the soil and achieving the test validity criteria should also be demonstrated.

12. The dry constituents of the soil are mixed thoroughly (e.g. in a large-scale laboratory mixer). This should be done at least one week before starting the test. The mixed soil should be stored for two days in order to equilibrate/stabilise the acidity. For the determination of pH a mixture of soil and 1 M potassium chloride (KCl) or 0,01 M calcium chloride (CaCl_2) solution in a 1:5 ratio is used (see (16) and Appendix 3). If the soil is more acidic than the required range (see paragraph 11), it can be adjusted by addition of an appropriate amount of CaCO_3 . If the soil is too alkaline it can be adjusted by the addition of more of the mixture, referred to in paragraph 11, but excluding the CaCO_3 .
13. The maximum water holding capacity (WHC) of the artificial soil is determined in accordance with procedures described in Appendix 2. One or two days before starting the test, the dry artificial soil is pre-moistened by adding enough de-ionised water to obtain approximately half of the final water content, that being 40 to 60 % of the maximum water holding capacity. At the start of the test, the pre-moistened soil is divided into portions corresponding with the number of test concentrations (and reference chemical where appropriate) and controls used for the test. The moisture content is adjusted to 40-60 % of the maximum WHC by the addition of the test chemical solution and/or by adding distilled or de-ionised water (see paragraphs 19-21). The moisture content is determined

▼ **M6**

at the beginning and at the end of the test (by drying to constant weight at 105 °C) and should be within the optimal range for the survival of the worms. A rough check of the soil moisture content can be obtained by gently squeezing the soil in the hand, if the moisture content is correct small drops of water should appear between the fingers.

Selection and preparation of test animals

14. The recommended test species is *Enchytraeus albidus* Henle 1837 (white potworm), a member of the family *Enchytraeidae* (order *Oligochaeta*, phylum *Annelida*). *E. albidus* is one of the largest species of enchytraeids, with specimens of up to 35 mm in length being recorded (17)(18). *E. albidus* has a world-wide distribution and is found in marine, freshwater and terrestrial habitats, mainly in decaying organic matter (seaweed, compost) and rarely in meadows (9). Its broad ecological tolerance and some morphological variations might indicate that different races exist.

15. *E. albidus* is commercially available, as a fish food. It should be checked whether the culture is contaminated by other, usually smaller, species (1) (19). If contamination occurs, all worms should be washed with water in a petri dish. Large adult specimens of *E. albidus* should then be selected (using a stereomicroscope) to start a new culture and all other worms are discarded. *E. albidus* can be bred easily in a wide range of organic materials (see Appendix 4). The life-cycle of *E. albidus* is short since maturity is reached between 33 days (at 18 °C) and 74 days (at 12 °C) (1). Only cultures that have been kept without problems in the laboratory for at least 5 weeks (one generation) will be used for the test.

16. Other species of the *Enchytraeus* genus are also suitable, e.g. *E. buchholzi* Vejdovsky 1879 or *E. crypticus* Westheide & Graefe 1992 (see Appendix 5). If other species of *Enchytraeus* are used, they must be clearly identified and the rationale for the selection of the species should be reported.

17. The animals used in the tests are adult worms. They should have eggs (white spots) in the clitellum region, and they should be approximately the same size (about 1 cm long). Synchronisation of the breeding culture is not necessary.

18. If the enchytraeids are not bred in the same soil type and under the conditions (including feeding) used for the final test they must be acclimatised for at least 24 hours and up to three days. A larger number of adults than that needed for performing the test should initially be acclimatised to allow scope for rejection of damaged or otherwise unsuitable specimens. At the end of the acclimatisation period, only worms containing eggs and exhibiting no behavioural abnormalities (e.g. trying to escape from the soil) are selected for the test. The worms are carefully removed using jeweller's tweezers, hooks or loops and placed in a petri dish containing a small amount of fresh water. Reconstituted fresh water as proposed in Chapter C.20 of this Annex (*Daphnia magna* Reproduction Test) is preferred for this purpose since de-ionised, de-mineralised or tap water could be harmful to the worms. The worms are inspected under a stereomicroscope and any that do not contain eggs are discarded. Care is taken to remove and discard any mites or springtails that might have infected the cultures. Healthy worms not used for the test are returned to the stock culture.

▼ M6**Preparation of test concentrations***Test chemical soluble in water*

19. A solution of the test chemical is prepared in deionised water in a quantity sufficient for all replicates of one test concentration. It is recommended to use an appropriate quantity of water to reach the required moisture content, i.e. 40 to 60 % of the maximum WHC (see paragraph 13). Each solution of test chemical is mixed thoroughly with one batch of pre-moistened soil before being introduced into the test vessel.

Test chemical insoluble in water

20. For chemicals insoluble in water but soluble in organic solvents, the test chemical can be dissolved in the smallest possible volume of a suitable vehicle (e.g. acetone). Only volatile solvents should be used. The vehicle is sprayed on or mixed with a small amount, for example 2,5 g, of fine quartz sand. The vehicle is eliminated by evaporation under a fume hood for at least one hour. This mixture of quartz sand and test chemical is added to the pre-moistened soil and thoroughly mixed after adding an appropriate amount of de-ionised water to obtain the moisture required. The final mixture is introduced into the test vessels.
21. For chemicals that are poorly soluble in water and organic solvents, the equivalent of 2,5 g of finely ground quartz sand per test vessel is mixed with the quantity of test chemical to obtain the desired test concentration. This mixture of quartz sand and test chemical is added to the pre-moistened soil and thoroughly mixed after adding an appropriate amount of de-ionised water to obtain the required moisture content. The final mixture is divided between the test vessels. The procedure is repeated for each test concentration and an appropriate control is also prepared.
22. Chemicals should not normally be tested at concentrations higher than 1 000 mg/kg dry mass of soil. Testing at higher concentrations may however be required in accordance with the objectives of a specific test.

PERFORMANCE OF THE TESTS**Test groups and controls**

23. For each test concentration, an amount of test soil corresponding to 20 g dry weight is placed into the test vessel (see paragraphs 19-21). Controls, without the test chemical, are also prepared. Food is added to each vessel in accordance with procedures described in paragraph 29. Ten worms are randomly allocated to each test vessel. The worms are carefully transferred into each test vessel and placed on the surface of the soil using, for example, jeweller's tweezers, hooks or loops. The number of replicates for test concentrations and for controls depends on the test design used (see paragraph 34). The test vessels are positioned randomly in the test incubator and these positions are re-randomised weekly.
24. If a vehicle is used for application of the test chemical, one control series containing quartz sand sprayed or mixed with solvent should be run in addition to the test series. The solvent or dispersant concentration should be the same as that used in the test vessels containing the test chemical. A control series containing additional quartz sand (2,5 g per vessel) should be run for chemicals requiring administration in accordance with the procedures described in paragraph 21.

▼ M6**Test conditions**

25. The test temperature is 20 ± 2 °C. To discourage worms from escaping from the soil, the test is carried out under controlled light-dark cycles (preferably 16 hours light and 8 hours dark) with illumination of 400 to 800 lux in the area of the test vessels.
26. In order to check the soil humidity, the vessels are weighed at the beginning of the test and thereafter once a week. Weight loss is replenished by the addition of an appropriate amount of deionised water. It should be noted that loss of water can be reduced by maintaining a high air-humidity (> 80 %) in the test incubator.
27. The moisture content and the pH, should be measured at the beginning and the end of both the range-finding test and the definitive test. Measurements should be made in control and treated (all concentrations) soil samples prepared and maintained in the same way as the test cultures but not containing worms. Food should only be added to these soil samples at the start of the test to facilitate microbial activity. The amount of food added should be the same as that added to the test cultures. It is not necessary to add further food to these vessels during the test.

Feeding

28. A food capable of maintaining the enchytraeid population can be used. Rolled oats, preferably autoclaved before use to avoid microbial contamination (heating is also appropriate), have been found to be a suitable feeding material.
29. Food is first provided by mixing 50 mg of ground rolled oats with the soil in each vessel before introducing the worms. Thereafter, food is supplied weekly up to Day 21. Feeding is not carried out on Day 28 since the adults have been removed at this stage and the juvenile worms need relatively little additional food beyond this point. Feeding during the test comprises 25 mg of ground rolled oats per vessel placed carefully on the surface of the soil so as to avoid injuring the worms. In order to reduce fungal growth, the oats flakes should be buried in the soil by covering with small amounts of soil. If food remains uneaten the ration should be reduced.

Design for the range-finding test

30. When necessary, a range-finding test is conducted with, for example, five test chemical concentrations of 0,1, 1,0, 10, 100, and 1 000 mg/kg (dry weight of soil). One replicate for each treatment and control is sufficient.
31. The duration of the range-finding test is two weeks. At the end of the test, mortality of the worms is assessed. A worm is recorded as dead if it has no reaction to a mechanical stimulus at the anterior end. Additional information to mortality may also be useful in deciding on the range of concentrations to be used in the definitive test. Changes in adult behaviour (e.g. the inability to dig into the soil; lying motionless against the glass wall of the test vessel) and morphology (e.g. the presence of open wounds) should therefore also be recorded along with the presence of any juveniles. The latter can be determined using the staining method described in Appendix 6.
32. The LC_{50} can be approximately determined by calculating the geometrical mean of mortality data. In setting the concentration range for the definitive test, effects on the reproduction are assumed to be lower than the LC_{50} by a factor of up to 10. However, this is an empirical relationship and in any specific case it might be different. Additional observations made in the

▼ M6

range-finding test such as the occurrence of juveniles can help refine the test chemical concentration range to be used for the definitive test.

33. In order for an accurate determination of the LC₅₀ performing the test using at least four replicates each of the test chemical concentration and an adequate number of concentrations to cause at least four statistically significantly different mean responses at these concentrations) is recommended. A similar number of the concentrations and replicates for the controls are used when they are applicable.

Design for the definitive reproduction test

34. Three designs are proposed based on recommendations arising from a ring test (2)

— For determination of the NOEC, at least five concentrations in a geometric series should be tested. Four replicates for each test concentration plus eight controls are recommended. The concentrations should be spaced by a factor not exceeding 1,8.

— For determination of the EC_x (e.g. EC₁₀, EC₅₀), at least five concentrations should be tested and the concentrations should bracket EC_x in order to enable EC_x interpolation and not extrapolation. At least four replicates for each test concentration and four control replicates are recommended. The spacing factor may vary, i.e. less than or equal to 1,8 in the expected effect range and above 1,8 at the higher and lower concentrations.

— A combined approach allows for determination of both the NOEC and EC_x. Eight treatment concentrations in a geometric series should be used. Four replicates for each treatment plus eight controls are recommended. The concentrations should be spaced by a factor not exceeding 1,8.

35. Ten adult worms per test vessel should be used (see paragraph 23). Food is added to the test vessels at the beginning of the test and then once a week (see paragraph 29) up to and including Day 21. On Day 21 the soil samples are carefully hand searched and living adult worms are observed and counted and changes in behaviour (e.g. inability to dig into the soil; lying motionless against the glass wall of the test vessel) and in morphology (e.g. open wounds) are recorded. All adult worms are then removed from the test vessels and the test soil. The test soil containing any cocoons that had been produced are incubated for three additional weeks under the same test conditions except that feeding takes place only on Day 35 (i.e. 25 mg ground rolled oats per vessel).

36. After six weeks, the newly hatched worms are counted. The method based on Bengal red staining (see Appendix 6) is recommended although other wet (but not heat) extraction and floatation techniques (see Appendix 6) have also proved suitable (4)(10)(11)(20). Bengal red staining is recommended because wet extraction from a soil substrate can be hampered by turbidity caused by suspended clay particles.

Limit test

37. If no effects are observed at the highest concentration in the range-finding test (i.e. 1 000 mg/kg), the reproduction test can be performed as a limit test, using 1 000 mg/kg in order to demonstrate that the NOEC for reproduction is greater than this value.

▼ **M6****Summary and timetable for the test**

38. The steps of the test can be summarised as follows:

Time	Range-finding test	Definitive test
Day -7 or earlier	— Prepare artificial soil (mixing of dry constituents)	— Prepare artificial soil (mixing of dry constituents)
Day -5	— Check pH of artificial soil — Measure max WHC of soil	— Check pH of artificial soil — Measure max WHC of soil
Day -5 to -3	— Sort worms for acclimatisation	— Sort worms for acclimatisation
Day -3 to 0	— Acclimatise worms for at least 24 hours	— Acclimatise worms for at least 24 hours
Day -1	— Pre-moisten artificial soil and distribute into batches	— Pre-moisten artificial soil and distribute into batches
Day 0	— Prepare stock solutions — Apply test chemical — Weigh test substrate into test vessels — Mix in food — Introduce worms — Measure soil pH and moisture content	— Prepare stock solutions — Apply test chemical — Weigh test substrate into test vessels — Mix in food — Introduce worms — Measure soil pH and moisture content
Day 7	— Check soil moisture content	— Check soil moisture content — Feed
Day 14	— Determine adult mortality — Estimate number of juveniles — Measure soil pH and moisture content	— Check soil moisture content — Feed
Day 21		— Observe adult behaviour — Remove adults — Determine adult mortality — Check soil moisture content — Feed
Day 28		— Check soil moisture content — No feeding
Day 35		— Check soil moisture content — Feed
Day 42		— Count juvenile worms — Measure soil pH and moisture content

▼ M6**DATA AND REPORTING****Treatment of results**

39. Although an overview is given in Appendix 7, no definitive statistical guidance for analysing test results is given in this test method.

40. In the range finding test, the main endpoint is mortality. Changes in behaviour (e.g. inability to dig into the soil; lying motionless against the glass wall of the test vessel) and morphology (e.g. open wounds) of the adult worms should however also be recorded along with the presence of any juveniles. Probit analysis (21) or logistic regression should normally be applied to determine the LC_{50} . However, in cases where this method of analysis is unsuitable (e.g., if less than three concentrations with partial kills are available), alternative methods can be used. These methods could include moving averages (22), the trimmed Spearman-Kärber method (23) or simple interpolation (e.g., geometrical mean of LC_0 and LC_{100} , as computed by the square root of LC_0 multiplied by LC_{100}).

41. In the definitive test, test endpoint is fecundity (i.e. number of juveniles produced). However, as in the range-finding test, all other harmful signs should be recorded in the final report. The statistical analysis requires the arithmetic mean and the standard deviation per treatment and per control for reproduction to be calculated.

42. If an analysis of variance has been performed, the standard deviation, s , and the degrees of freedom, df , may be replaced by the pooled variance estimate obtained from the ANOVA and by its degrees of freedom, respectively — provided variance does not depend on the concentration. In this case, use the single variances of control and treatments. Those values are usually calculated by commercial statistical software using the per-vessel results as replicates. If pooling of data for the negative and solvent controls appears reasonable rather than testing against one of those, they should be tested to see that they are not significantly different (for appropriate tests see paragraph 45 and Appendix 7).

43. Further statistical testing and inference depends on whether the replicate values are normally distributed and are homogeneous with regard to their variance.

NOEC Estimation

44. The application of powerful tests should be preferred. One should use information e.g. from previous experience with ring-testing or other historic data on whether data are approximately normally distributed. Variance homogeneity (homoscedasticity) is more critical. Experience tells that the variance often increases with increasing mean. In these cases, a data transformation could lead to homoscedasticity. However, such a transformation should be based on experience with historic data rather than on data under investigation. With homogeneous data, multiple t -tests such as Williams' test ($\alpha = 0,05$, one-sided) (24)(25) or in certain cases Dunnett's test (26)(27) should be performed. It should be noted that, in the case of unequal replication, the table t -values must be corrected as suggested by Dunnett and Williams. Sometimes, because of large variation, the responses do not increase/decrease regularly. In this case of strong deviation from monotonicity the Dunnett's test is more appropriate. If there are deviations from homoscedasticity, it may be reasonable to investigate possible effects on variances more closely to decide whether the t tests can be applied without losing much power (28). Alternatively, a multiple U -test, e.g. the

▼ M6

Bonferroni-U-test according to Holm (29), or when these data exhibit heteroscedasticity but are otherwise consistent with a underlying monotone dose-response, an other non-parametric test [e.g. Jonckheere-Terpstra (30) (31) or Shirley (32) (33)] can be applied and would generally be preferred to unequal-variance t-tests. (see also the scheme in Appendix 7).

45. If a limit test has been performed and the prerequisites of parametric test procedures (normality, homogeneity) are fulfilled, the pair-wise Student t-test can be used or otherwise the Mann-Whitney-U-test procedure (29).

EC_x Estimation

46. To compute any EC_x value, the per-treatment means are used for regression analysis (linear or non-linear), after an appropriate dose-response function has been obtained. For the growth of worms as a continuous response, EC_x-values can be estimated by using suitable regression analysis (35). Among suitable functions for quantal data (mortality/survival and number of offspring produced) are the normal sigmoid, logistic or Weibull functions, containing two to four parameters, some of which can also model hormetic responses. If a dose-response function was fitted by linear regression analysis a significant r^2 (coefficient of determination) and/or slope should be found with the regression analysis before estimating the EC_x by inserting a value corresponding to x % of the control mean into the equation found by regression analysis. 95 %-confidence limits are calculated according to Fieller (cited in Finney (21)) or other modern appropriate methods.
47. Alternatively, the response is modelled as a percent or proportion of model parameter which is interpreted as the control mean response. In these cases, the normal (logistic, Weibull) sigmoid curve can often be easily fitted to the results using the probit regression procedure (21). In these cases the weighting function has to be adjusted for metric responses as given by Christensen (36). However, if hormesis has been observed, probit analysis should be replaced by a four-parameter logistic or Weibull function, fitted by a non-linear regression procedure (36). If a suitable dose-response function cannot be fitted to the data, one may use alternative methods to estimate the EC_x, and its confidence limits, such as Moving Averages after Thompson (22) and the Trimmed Spearman-Kärber procedure (23).

TEST REPORT

48. The test report must include the following information:

Test chemical:

- physical nature and, where relevant physical-chemical properties (e.g. water solubility, vapour pressure);
- chemical identification of the test chemical according to IUPAC nomenclature, CAS-number, batch, lot, structural formula and purity;
- expiry date of sample.

Test species:

- test animals used: species, scientific name, source of organisms and breeding conditions.

Test conditions:

- ingredients and preparation of the artificial soil;

▼ **M6**

- method of application of the test chemical;
- description of the test conditions, including temperature, moisture content, pH, etc.;
- full description of the experimental design and procedures.

Test results:

- mortality of adult worms after two weeks and the number of juveniles at the end of the range-finding test;
- mortality of adult worms after three weeks exposure and the full record of juveniles at the end of the definitive test;
- any observed physical or pathological symptoms and behavioural changes in the test organisms;
- the LC₅₀, the NOEC and/or EC_x (e.g. EC₅₀, EC₁₀) for reproduction if some of them are applicable with confidence intervals, and a graph of the fitted model used for its calculation all information and observations helpful for the interpretation of the results.

Deviations from procedures described in this test method and any unusual occurrences during the test.

LITERATURE

- (1) Römbke, J. (1989). Entwicklung eines Reproduktionstests an Bodenorganismen — Enchytraeen. Abschlußbericht des Battelle-Instituts e.V. Frankfurt für das Umweltbundesamt (Berlin), FE-Vorhaben 106 03 051/01.
- (2) Römbke, J. and Moser, T. (1999). Organisation and Performance of an International Ringtest for the Validation of the Enchytraeid Reproduction Test. UBA-Texte 4/99, 150 + 223 pp.
- (3) Westheide, W. and Bethge-Beilfuss, D. (1991). The sublethal enchytraeid test system: guidelines and some results, In: Modern Ecology: Basic and Applied Aspects. Ed. by Esser, G. and Overdieck, D. pp 497-508. Elsevier, Amsterdam,
- (4) Dirven-Van Breemen, E., Baerselmann, R. and Notenboom, J. (1994). Onderzoek naar de Geschiktheid van de Potwormsoorten *Enchytraeus albidus* en *Enchytraeus crypticus* (Oligochaeta, Annelida) in Bodemecotoxicologisch Onderzoek. RIVM Rapport Nr. 719102025. 46 pp.
- (5) Chapter C.8 of this Annex, Toxicity for Earthworms.
- (6) ISO (International Organization for Standardization) (1993). Soil Quality — Effects of pollutants on earthworms (*Eisenia fetida*). Part 1: Determination of acute toxicity using Artificial Soil substrate, No. 11268-1. ISO, Geneve.
- (7) ISO (International Organization for Standardization) (1996). Soil Quality — Effects of pollutants on earthworms (*Eisenia fetida*). Part 2: Determination of effects on reproduction, No. 11268-2. ISO, Geneve.
- (8) Rundgren, S. and A.K. Augustsson (1998). Test on the enchytraeid *Cognettia sphagnetorum* (Vejdovsky 1877). In: Løkke, H. and C.A.M. Van Gestel, Handbook of soil invertebrate toxicity tests. John Wiley and Sons, Chichester, 73-94.
- (9) Kasprzak, K. (1982). Review of enchytraeid community structure and function in agricultural ecosystems. *Pedobiologia* 23, 217-232.
- (10) Römbke, J. (1995). Enchytraeen (Oligochaeta) als Bioindikator, UWSF — Z. Umweltchem. Ökotox. 7, 246-249.
- (11) Dunger, W. and Fiedler, H.J. (1997). Methoden der Bodenbiologie. G. Fischer Verlag, Stuttgart, New York.

▼ **M6**

- (12) Didden, W.A.M. (1993). Ecology of terrestrial Enchytraeidae. *Pedobiologia* 37, 2-29.
- (13) Becker, H. (1991). Bodenorganismen — Prüfungskategorien der Forschung. UWSF — Z. Umweltchem. Ökotox. 3, 19-24.
- (14) Römbke, J. and Federschmidt, A. (1995). Effects of the fungicide Carbendazim on Enchytraeidae in laboratory and field tests, Newsletter on Enchytraeidae 4, 79-96.
- (15) Römbke, J., Riepert, F. & Achazi R. (2000): Enchytraeen als Testorganismen. In: Toxikologische Beurteilung von Böden. Heiden, S., Erb, R., Dott, W. & Eisentraeger, A. (eds.). Spektrum Verl., Heidelberg. 59-81.
- (16) ISO (International Organization for Standardization) (1994). Soil Quality — Determination of pH, No. 10390. ISO, Geneva.
- (17) Bell, A.W. (1958). The anatomy of *Enchytraeus albidus*, with a key to the species of the genus *Enchytraeus*. *Ann. Mus. Novitat.* 1902, 1-13.
- (18) Nielsen, C.O. and Christensen, B. (1959). The Enchytraeidae, critical revision and taxonomy of European species. *Natura Jutlandica* 8-9, 1-160.
- (19) Bouguenec, V. and Giani, N. (1987). Deux nouvelles especes d'*Enchytraeus* (*Oligochaeta*, Enchytraeidae) et redescription d'*E. bigeminus*. Remarques sur le genre *Enchytraeus*. *Ann. Limnol.* 23, 9-22.
- (20) Korinkova, J. and Sigmund, J. (1968). The colouring of bottom-fauna samples before sorting, *Vestnik Ceskoslovensko Spolecnosti Zoologicke* 32, 300-305.
- (21) Finney, D.J. (1971). *Probit Analysis* (3rd ed.), pp. 19-76. Cambridge Univ. Press.
- (22) Finney, D.J. (1978). *Statistical Method in Biological Assay*. — Charles Griffin & Company Ltd, London.
- (23) Hamilton, M.A., R.C. Russo and R.V. Thurston. (1977). Trimmed Spearman-Kärber Method for estimating median lethal concentrations in toxicity bioassays. *Environ. Sci. Technol.* 11(7), 714-719; Correction *Environ. Sci. Technol.* 12(1998), 417.
- (24) Williams, D.A., (1971). A test for differences between treatment means when several dose levels are compared with a zero dose control. *Biometrics* 27, 103-117.
- (25) Williams, D.A., (1972). The comparison of several dose levels with a zero dose control. *Biometrics* 28, 519-531.
- (26) Dunnett, C.W., (1955). A multiple comparison procedure for comparing several treatments with a control. *Amer. Statist. Ass. J.* 50, 1096-1121.
- (27) Dunnett, C.W., (1964) New tables for multiple comparisons with a control. *Biometrics* 20, 482-491.
- (28) Hoeven, N. van der, (1998). Power analysis for the NOEC: What is the probability of detecting small toxic effects on three different species using the appropriate standardized test protocols? *Ecotoxicology* 7: 355-361
- (29) Holm, S., (1979): A simple sequentially rejective multiple test procedure. *Scand. J. Statist.* 6, 65-70.
- (30) Jonckheere, A. R. (1954); A Distribution-free k-Sample Test Against Ordered Alternatives, *Biometrika* 41, 133-145.
- (31) Terpstra, T. J. (1952); The Asymptotic Normality and Consistency of Kendall's Test Against Trend, When Ties are Present in One Ranking, *Indagationes Math.* 14, 327-333.
- (32) Shirley, E. A. (1979); The comparison of treatment to control group means in toxicology studies, *Applied Statistics* 28, 144-151.

▼ M6

- (33) Williams, D.A. (1986); A Note on Shirley's Nonparametric Test for Comparing Several Dose Levels with a Zero-Dose Control, *Biometrics* 42, 183-186.
- (34) Sokal, R.R. and F.J. Rohlf. (1981). *Biometry. The Principle and practice of statistics in biological research.* 2nd edition. W.H. Freeman and Company. New York.
- (35) Christensen, E.R., (1984). Dose-response functions in aquatic toxicity testing and the Weibull model. *Water Research* 18, 213-221.
- (36) Van Ewijk, P.H. and J.A. Hoekstra. (1993). Calculation of the EC50 and its confidence interval when sub-toxic stimulus is present. *Ecotox, Environ. Safety.* 25, 25-32.

▼ M6*Appendix 1***Definitions**

For the purpose of this test method the following definitions are applicable:

Chemical means a substance or a mixture.

EC_x (Effect concentration for x % effect) is the concentration that causes an x % of an effect on test organisms within a given exposure period when compared with a control. In this test the effect concentrations are expressed as a mass of test chemical per dry mass of the test soil.

LC₀ (No lethal concentration) is the concentration of a test chemical that does not kill any of exposed test organisms within a given time period. In this test the LC₀ is expressed as a mass of test chemical per dry mass of the test soil.

LC₅₀ (Median lethal concentration) is the concentration of a test chemical kills 50 % of exposed test organisms within a given time period. In this test the LC₅₀ is expressed as a mass of test chemical per dry mass of the test soil.

LC₁₀₀ (Totally lethal concentration) is the concentration of a test chemical kills 100 % of exposed test organisms within a given time period. In this test the LC₁₀₀ is expressed as a mass of test chemical per dry mass of the test soil.

LOEC (Lowest Observed Effect Concentration) is the lowest test chemical concentration that has a statistically significant effect ($p < 0,05$). In this test the LOEC is expressed as a mass of test chemical per dry mass of the test soil. All test concentrations above the LOEC should normally show an effect that is statistically different from the control. Any deviations from the above in identifying the LOEC must be justified in the test report.

NOEC (No Observed Effect Concentration) is the highest test chemical concentration immediately below the LOEC at which no effect is observed. In this test, the concentration corresponding to the NOEC, has no statistically significant effect ($p < 0,05$) within a given exposure period when compared with the control.

Reproduction rate is the mean number of juvenile worms produced per a number of adults over the test period.

Test chemical is any substance or mixture tested using this test method.

▼ M6*Appendix 2***Determination of the maximum water holding capacity****Determination of the water holding capacity of the artificial soil**

The following method has been found appropriate. It is described in Annex C of the ISO DIS 11268-2.

Collect a defined quantity (e.g. 5 g) of the test soil substrate using a suitable device (auger tube etc.). Cover the bottom of the tube with a piece of filter paper and, after filling with water, place it on a rack in a water bath. The tube should be gradually submerged until the water level is above to the top of the soil. It should then be left in the water for about three hours. Since not all water absorbed by the soil capillaries can be retained, the soil sample should be allowed to drain for a period of two hours by placing the tube onto a bed of very wet finely ground quartz sand contained within a closed vessel (to prevent drying). The sample should then be weighed, dried to constant mass at 105 °C. The water holding capacity (WHC) can then be calculated as follows:

$$\text{WHC (in \% of dry mass)} = \frac{S - T - D}{D} \times 100$$

Where:

S = water-saturated substrate + mass of tube + mass of filter paper

T = tare (mass of tube + mass of filter paper)

D = dry mass of substrate

REFERENCES:

ISO (International Organization for Standardization) (1996). Soil Quality -Effects of pollutants on earthworms (*Eisenia fetida*). Part 2: Determination of effects on reproduction, No. 11268-2. ISO, Geneva.

▼M6*Appendix 3***Determination of soil pH**

The following method for determining the pH of a soil sample is based on the description in ISO 10390 (Soil Quality — Determination of pH).

A defined quantity of soil is dried at room temperature for at least 12 hours. A suspension of the soil (containing at least 5 grams of soil) is then made up in five times its volume of either 1 M of analytical grade potassium chloride (KCl) or a 0,01 M solution of analytical grade calcium chloride (CaCl₂). The suspension is then shaken thoroughly for five minutes. After shaking, the suspension is left to settle for at least 2 hours but not for longer than 24 hours. The pH of the liquid phase is then measured using a pH-meter, that has been calibrated before each measurement using an appropriate series of buffer solutions (e.g. pH 4,0 and 7,0).

REFERENCES:

ISO (International Organization for Standardization) (1994). Soil Quality — Determination of pH, No. 10390. ISO, Geneva.

▼ M6

Appendix 4

Culturing conditions of *Enchytraeus* sp.

Enchytraeids of the species *Enchytraeus albidus* (as well as other *Enchytraeus* species) can be cultured in large plastic boxes (e.g. 30 × 60 × 10 cm) filled with a 1:1 mixture of artificial soil and natural, uncontaminated garden soil. Compost material must be avoided since it could contain toxic chemicals such as heavy metals. Fauna should be removed from the soil before use (e.g. by deep-freezing). A substrate comprising only of artificial soil can also be used but the reproduction rate may be lower than that obtained with a mixed soil substrate. The substrate used for culturing should have a pH of $6,0 \pm 0,5$.

The culture is kept in the dark at a temperature of 15 to 20 °C \pm 2 °C. Temperatures higher than 23 °C must be avoided. The soil must be kept moist but not wet. The correct soil moisture content is indicated when small drops of water appear between the fingers when the soil is gently squeezed. The production of anoxic conditions must be avoided by ensuring that covers to culture containers allow adequate gaseous exchange with the atmosphere. The soil should be carefully broken up each week to facilitate aeration.

The worms can be fed on rolled oats. The oats should be stored in sealed vessels and autoclaved or heated before use in order to avoid infestation with flour mites (e.g. *Glyzyphagus* sp., *Astigmata*, *Acarina*) or predacious mites [e.g. *Hypoaspis (Cosmolaelaps) miles*, *Gamasida*, *Acarina*]. After a heat treatment, the food should be ground so that it can easily be strewn on the soil surface. From time to time, the rolled oats can be supplemented by the addition of vitamins, milk and cod-liver oil. Other suitable food sources are baker's yeast and the fish food 'Tetramin'.

Feeding takes place approximately twice a week. An appropriate quantity of rolled oats is strewn on the soil surface or carefully mixed into the substrate when breaking up the soil to facilitate aeration. The absolute amount of food provided depends on the number of worms present in the substrate. As a guide, the amount of food should be increased if it is all consumed within one day of being provided. Conversely, if food still remains on the surface at the time of the second feeding (one-week later) it should be reduced. Food contaminated with fungal growth should be removed and replaced. After three months, the worms should be transferred into a freshly prepared substrate.

Culturing conditions are deemed satisfactory if the worms: (a) do not try to leave the soil substrate, (b) move quickly through the soil, (c) exhibit a shiny outer surface without adhering soil particles, (d) are more or less whitish in colour, (e) exhibit a variety of age ranges in the cultures and (f) reproduce continuously.

▼ **M6***Appendix 5***Test performance with other *Enchytraeus* species****Selection of species**

Species other than *E. albidus* may be used but the test procedure and the validity criteria should be adapted accordingly. Since many *Enchytraeus*-species are readily available and can be satisfactorily maintained in the laboratory, the most important criterion for selecting a species other than *E. albidus* is ecological relevance and, additionally, comparable sensitivity. There may also be formal reasons for a change of species. For example, in countries where *E. albidus* does not occur and cannot be imported (e.g. due to quarantine restrictions), it will be necessary to use another *Enchytraeus* species.

Examples of suitable alternative species

- *Enchytraeus crypticus* (Westheide & Graefe 1992): In recent years, this species has often been used in ecotoxicological studies because of the simplicity of its breeding and testing. However, it is small and this makes handling more difficult compared with *E. albidus* (especially at stages prior to use of the staining method). *E. crypticus* has not been found to exist with certainty in the field, having only been described from earthworm cultures. Its ecological requirements are therefore not known.
- *Enchytraeus buchholzi* (Vejdovsky 1879): This name probably covers a group of closely related species that are morphologically difficult to distinguish. Its use for testing is not recommended until the individuals used in a test can be identified to species. *E. buchholzi* is usually found in meadows and disturbed sites such as roadsides.
- *Enchytraeus luxuriosus*: This species was originally known as *E. 'minutus'*, but has been recently described (1). It was first found by U. Graefe (Hamburg) in a meadow close to St. Peter-Ording (Schleswig-Holstein, Germany). *E. luxuriosus* is approximately half the size of *E. albidus* but larger than the other species discussed here; this could make it a good alternative to *E. albidus*.
- *Enchytraeus bulbosus* (Nielsen & Christensen 1963): This species has hitherto been reported from German and Spanish mineral soils, where it is common but not usually very abundant. In comparison to other small species of this genus, it is relatively easy to identify. Nothing is known about its behaviour in laboratory tests or its sensitivity to chemicals. It has, however, been found to be easy to culture (E. Belotti, personal communication).

Breeding conditions

All the *Enchytraeus*-species mentioned above can be cultured in the same substrates used for *E. albidus*. Their smaller size means that the culture vessels can be smaller and that, while the same food can be used, the ration size must be adjusted. The life-cycle of these species is shorter than for *E. albidus* and feeding should be carried out more frequently.

Test conditions

The test conditions are generally the same as those applying to *E. albidus*, except that:

- the size of the test vessel can (but need not) be smaller;
- the duration of the reproduction test can (but need not) be shorter, i.e. four instead of six weeks; however, the duration of the Range-Finding Test should not be changed;
- in view of the small size of the juvenile worms the use of the staining method is strongly recommended for counting;
- the validity criterion relating to 'number of juveniles per test vessel in the control' should be changed to '50'.

▼ **M6**

REFERENCES

- (1) Schmelz, R.M. and Collado, R. (1999). *Enchytraeus luxuriosus* sp.nov., a new terrestrial oligochaete species (Enchytraeidae, Clitellata, Annelida). *Carolinae* 57, 93-100.

▼M6*Appendix 6***Detailed description of extraction techniques****Staining with Bengal red**

This method, originally developed in limnic ecology (1) was first proposed for the counting of juvenile enchytraeids in the Enchytraeidae reproduction test by W. de Coen (University of Ghent, Belgium). Independently, a modified version (Bengalred mixed with formaldehyde instead of ethanol) was developed by RIVM Bilthoven (2)(3).

At the end of the Definitive Test (i.e. after six weeks), the soil in the test vessels is transferred to a shallow container. A Bellaplast vessel or a photo basin with ribbed bottom is useful for this purpose, the latter because the 'ribs' restrict movement of the worms within the field of observation. The juveniles are fixed with ethanol (approx. 5 ml per replicate). The vessels are then filled with water up to a layer of 1 to 2 cm. A few drops (200 to 300 µl) of Bengal red (1 % solution in ethanol) are added (0,5 % eosin is an alternative) and the two components are mixed carefully. After 12 hours, the worms should be stained a reddish colour and should be easy to count because they will be lying on the substrate surface. Alternatively, the substrate/alcohol mixture can be washed through a sieve (mesh size: 0,250 mm) before counting the worms. Using this procedure, the kaolinite, peat, and some of the sand will be washed out and the reddish coloured worms will be easier to see and count. The use of illuminated lenses (lens size at least 100 × 75 mm with a magnification factor 2 to 3×) will also facilitates counting.

The staining technique reduces counting time to a few minutes per vessel and as a guide it should be possible for one person to assess all the vessels from one test in a maximum of two days.

Wet extraction

The wet extraction should be started immediately the test finishes. The soil from each test vessel is placed into plastic sieves with a mesh size of approximately 1 mm. The sieves are then suspended in plastic bowls without touching the bottom. The bowls are carefully filled up with water until the samples in the sieves are completely under the water surface. To ensure a recovery rate of more than 90 % of the worms present, an extraction period of 3 days at 20 ± 2 °C should be used. At the end of the extraction period the sieves are removed and the water (except for a small amount) is slowly decanted, taking care not to disturb the sediment at the bottom of the bowls. The plastic bowls are then shaken slightly to suspend the sediment in the overlying water. The water is transferred to a petri dish and, after the soil particles have settled, the enchytraeids can be identified, removed and counted using a stereomicroscope and soft steel forceps.

Flotation

A method based on flotation has been described in a note by R. Kuperman (4). After fixing the contents of a test vessel with ethanol, the soil is flooded with Ludox (AM-30 colloidal silica, 30 wt. % suspension in water) up to 10 to 15 mm above the soil surface. After thoroughly mixing the soil with the flotation agent for 2 – 3 minutes, the juvenile worms floating on the surface can easily be counted.

REFERENCES

- (1) Korinkova, J. and Sigmund, J. (1968). The colouring of bottom-fauna samples before sorting, *Vestnik Československo Spolecnosti Zoologicke* 32, 300-305.

▼ M6

- (2) Dirven-Van Breemen, E., Baerselmann, R. and Notenboom, J. (1994). Onderzoek naar de Geschiktheid van de Potwormsoorten *Enchytraeus albidus* en *Enchytraeus crypticus* (*Oligochaeta, Annelida*) in Bodemecotoxicologisch Onderzoek. RIVM Rapport Nr. 719102025. 46 pp.
- (3) Posthuma, L., Baerselmann, R., Van Veen, R.P.M. and Dirven-Van Breemen, E.M. (1997). Single and joint toxic effects of copper and zinc on reproduction of *Enchytraeus crypticus* in relation to sorption of metals in soils. *Ecotox. Envir. Safety* **38**, 108-121.
- (4) Phillips, C.T., Checkai, R.T. and Kuperman, R.G. (1998). An alternative to the O'Connor Method for Extracting Enchytraeids from Soil. SETAC 19th Annual Meeting, Charlotte, USA. Abstract Book No. PMP069, p. 157.

▼ **M6**

Appendix 7

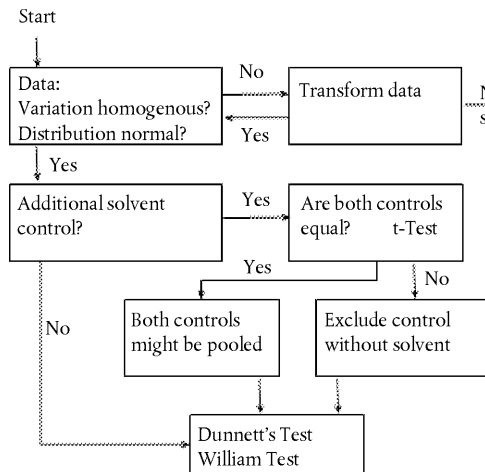
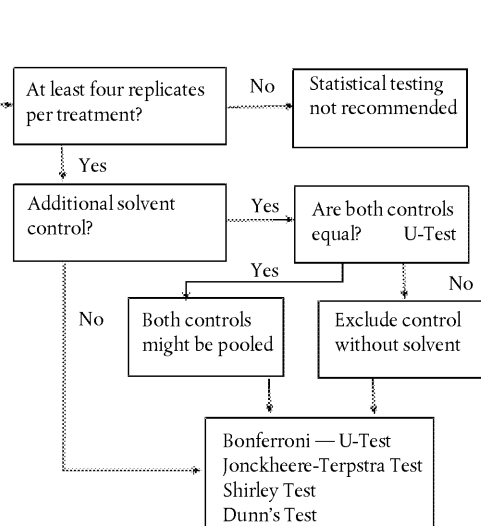
Overview of the statistical assessment of data (NOEC determination)**Parametric Tests****Non-parametric Tests**

▼M6**C.33. EARTHWORM REPRODUCTION TEST (*EISENIA FETIDA*/
EISENIA ANDREI)**

INTRODUCTION

1. This test method is equivalent to OECD test guideline (TG) 222 (2004). It is designed to be used for assessing the effects of chemicals in soil on the reproductive output (and other sub-lethal end points) of the earthworm species *Eisenia fetida* (Savigny 1826) or *Eisenia andrei* (Andre 1963) (1)(2). The test has been ring-tested (3). A test method for the earthworm acute toxicity test exists (4). A number of other international and national guidelines for earthworm acute and chronic tests have been published (5)(6)(7)(8).
2. *Eisenia fetida* /*Eisenia andrei* are considered to be a one of representatives of soil fauna and earthworms in particular. Background information on the ecology of earthworms and their use in ecotoxicological testing is available (7)(9)(10)(11)(12).

PRINCIPLE OF THE TEST

3. Adult worms are exposed to a range of concentrations of the test chemical either mixed into the soil or, in case of pesticides, applied into or onto the soil using procedures consistent with the use pattern of the chemical. The method of application is specific to the purpose of the test. The range of test concentrations is selected to encompass those likely to cause both sub-lethal and lethal effects over a period of eight weeks. Mortality and growth effects on the adult worms are determined after 4 weeks of exposure. The adults are then removed from the soil and effects on reproduction assessed after a further 4 weeks by counting the number of offspring present in the soil. The reproductive output of the worms exposed to the test chemical is compared to that of the control(s) in order to determine the (i) no observed effect concentration (NOEC) and/or (ii) EC_x (e.g. EC_{10} , EC_{50}) by using a regression model to estimate the concentration that would cause a x % reduction in reproductive output. The test concentrations should bracket the EC_x (e.g. EC_{10} , EC_{50}) so that the EC_x then comes from interpolation rather than extrapolation (see Appendix 1 for definitions).

INFORMATION ON THE TEST CHEMICAL

4. The following information relating to the test chemical should be available to assist in the design of appropriate test procedures:
 - water solubility;
 - $\log K_{ow}$;
 - vapour pressure;
 - and information on fate and behaviour in the environment, where possible (e.g. rate of photolysis and rate of hydrolysis where relevant to application patterns).
5. This test method is applicable to all chemicals irrespective of their water solubility. The test method is not applicable to volatile chemicals, defined here as chemicals for which Henry's constant or the air/water partition coefficient is greater than one, or to chemicals with vapour pressures exceeding 0,0133 Pa at 25 °C.
6. No allowance is made in this test method for possible degradation of the test chemical over the period of the test. Consequently it cannot be assumed that exposure concentrations will be maintained at initial values throughout the test. Chemical analysis of the test chemical at the start and the end of the test is recommended in that case.

▼ M6

REFERENCE CHEMICAL

7. The NOEC and/or the EC_x of a reference chemical must be determined to provide assurance that the laboratory test conditions are adequate and to verify that the response of the test organisms does not change statistically over time. It is advisable to test a reference chemical at least once a year or, when testing is carried out at a lower frequency, in parallel to the determination of the toxicity of a test chemical. Carbendazim or benomyl are suitable reference chemicals that have been shown to affect reproduction (3). Significant effects should be observed between (a) 1 and 5 mg active ingredient (a.i.)/kg dry mass or (b) 250-500 g/ha or 25-50 mg/m². If a positive toxic standard is included in the test series, one concentration is used and the number of replicates should be the same as that in the controls.

VALIDITY OF THE TEST

8. The following criteria should be satisfied in the controls for a test result to be considered valid:
- each replicate (containing 10 adults) to have produced ≥ 30 juveniles by the end of the test;
 - the coefficient of variation of reproduction to be ≤ 30 %;
 - adult mortality over the initial 4 weeks of the test to be ≤ 10 %.

Where a test fails to meet the above validity criteria the test should be terminated unless a justification for proceeding with the test can be provided. The justification should be included in the report.

DESCRIPTION OF THE TEST

Equipment

9. Test containers made of glass or other chemically inert material of about one to two litres capacity should be used. The containers should have a cross-sectional area of approximately 200 cm² so that a moist substrate depth of about 5-6 cm is achieved when 500 to 600 g dry mass of substrate is added. The design of the container cover should permit gaseous exchange between the substrate and the atmosphere and access to light (e.g. by means of a perforated transparent cover) whilst preventing the worms from escaping. If the amount of test substrate used is substantially more than 500 to 600 g per test container the number of worms should be increased proportionately.
10. Normal laboratory equipment is required, specifically the following:
- drying cabinet;
 - stereomicroscope;
 - pH-meter and photometer;
 - suitable accurate balances;
 - adequate equipment for temperature control;
 - adequate equipment for humidity control (not essential if exposure vessels have lids);
 - incubator or small room with air-conditioner;
 - tweezers, hooks or loops;
 - water bath.

▼ M6**Preparation of the artificial soil**

11. An artificial soil is used in this test (5)(7) with the following composition (based on dry weights, dried to a constant weight at 105 °C):
 - 10 per cent sphagnum peat (as close to pH 5,5 to 6,0 as possible, no visible plant remains, finely ground, dried to measured moisture content);
 - 20 per cent kaolin clay (kaolinite content preferably above 30 per cent);
 - 0,3 to 1,0 % calcium carbonate (CaCO₃, pulverised, analysis grade) to obtain an initial pH of 6,0 ± 0,5.
 - 70 % air-dried quartz sand (depending on the amount of CaCO₃ needed), predominantly fine sand with more than 50 % of the particles between 50 and 200 microns.

Note 1: The amount of CaCO₃ required will depend on the components of the soil substrate including food, and should be determined by measurements of soil sub-samples immediately before the test. pH is measured in a mixed sample in a 1 M solution of potassium chloride (KCl) or a 0,01 M solution of calcium chloride (CaCl₂) (13).

Note 2: The organic carbon content of the artificial soil may be reduced, e.g. by lowering the peat content to 4-5 % and increasing the sand content accordingly. By such a reduction in organic carbon content, the possibilities of adsorption of test chemical to the soil (organic carbon) may be decreased and the availability of the test chemical to the worms may increase. It has been demonstrated that *Eisenia fetida* can comply with the validity criteria on reproduction when tested in field soils with lower organic carbon content (e.g. 2,7 %) (14), and there is experience that this can also be achieved in artificial soil with 5 % peat. Therefore, it is not necessary before using such a soil in a definitive test to demonstrate the suitability of the artificial soil for allowing the test to comply with the validity criteria unless the peat content is lowered more than specified above.

Note 3: When using natural soil in additional (e.g. higher tier) testing the suitability of the soil and achieving the test validity criteria should also be demonstrated.

12. The dry constituents of the soil are mixed thoroughly (e.g. in a large-scale laboratory mixer) in a well ventilated area. Before starting the test, the dry artificial soil is moistened by adding enough de-ionised water to obtain approximately half of the final water content, that being 40 % to 60 % of the maximum water holding capacity (corresponding to 50 ± 10 % moisture dry mass). This will produce a substrate that has no standing or free water when it is compressed in the hand. The maximum water holding capacity (WHC) of the artificial soil is determined in accordance with procedures described in Appendix 2, ISO 11274 (15) or equivalent EU standard.
13. If the test chemical is applied on the soil surface or mixed into soil without water, the final amount of water can be mixed into the artificial soil during preparation of the soil. If the test chemical is mixed into the soil together with some water, the additional water can be added together with the test chemical (see paragraph 19).
14. Soil moisture content is determined at the beginning and at the end of the test in accordance with ISO 11465 (16) or equivalent EU standard, and soil

▼ M6

pH in accordance with Appendix 3 or ISO 10390 (13) or equivalent EU standard. These determinations should be carried out in a sample of control soil and a sample of each test concentration soil. The soil pH should not be adjusted when acidic or basic chemicals are tested. The moisture content should be monitored throughout the test by weighing the containers periodically (see paragraph 26 and 30).

Selection and preparation of test animals

15. The species used in the test is *Eisenia fetida* or *Eisenia andrei* (1)(2). Adult worms between two months and one year old and with a clitellum are required to start the test. The worms should be selected from a synchronised culture with a relatively homogeneous age structure (Appendix 4). Individuals in a test group should not differ in age by more than 4 weeks.
16. The selected worms should be acclimatised for at least one day with the type of artificial soil substrate to be used for the test. During this period the worms should be fed on the same food to be used in the test (see paragraphs 31 to 33).
17. Groups of 10 worms should be weighed individually randomly assigning the groups to the test containers at the start of the test. The worms are washed prior to weighing (with deionised water) and the excess water removed by placing the worms briefly on filter paper. The wet mass of individual worms should be between 250 and 600 mg.

Preparation of test concentrations

18. Two methods of application of the test chemical can be used: mixing the test chemical into the soil (see paragraphs 19-21) or application to the soil surface (see paragraphs 22-24). The selection of the appropriate method depends on the purpose of the test. In general, mixing of the test chemical into the soil is recommended. However application procedures that are consistent with normal agricultural practice may be required (e.g. spraying of liquid formulation or use of special pesticide formulations such as granules or seed dressings). Solvents used to aid treatment of the soil with the test chemical should be selected on the basis of their low toxicity to earthworm and appropriate solvent control must be included in the test design (see paragraph 27).

Mixing the test chemical into the soil*Test chemical soluble in water*

19. A solution of the test chemical in de-ionised water is prepared immediately before starting the test in a quantity sufficient for all replicates of one concentration. A co-solvent may be required to facilitate for the preparation of the test solution. It is convenient to prepare an amount of solution necessary to reach the final moisture content (40 to 60 % of maximum water holding capacity). The solution is mixed thoroughly with the soil substrate before introducing it into a test container.

Test chemical insoluble in water

20. The test chemical is dissolved in a small volume of a suitable organic solvent (e.g. acetone) and then sprayed onto, or mixed into, a small quantity of fine quartz sand. The solvent is then removed by evaporation in a fume hood for at least a few minutes. The treated sand is then mixed thoroughly with the pre-moistened artificial soil. De-ionised water is then added (an amount required) to achieve a final moisture content of 40 to 60 % of the maximum water holding capacity is then added and mixed in. The soil is then ready for placing in test containers vessels. Care should be taken that some solvents may be toxic to earthworms.

▼ M6*Test chemical insoluble in water and organic solvents*

21. A mixture comprised of 10 g of finely ground industrial quartz sand with a quantity of the test chemical necessary to achieve the test concentration in the soil is prepared. The mixture is then mixed thoroughly with the pre-moistened artificial soil. De-ionised water is then added to an amount required to achieve a final moisture content of 40 to 60 % of the maximum water holding capacity is then added and mixed in. The soil is then ready for placing to the test containers.

Application of the test chemical to the soil surface

22. The soil is treated after the worms are added. The test containers are first filled with the moistened soil substrate and the weighed worms are placed on the surface. Healthy worms normally burrow immediately into substrate and consequently any remaining on the surface after 15 minutes are defined as damaged and must be replaced. If worms are replaced, the new ones and those substituted should be weighed so that total live weight of the exposure group of worms and the total weight of the container with worms at the start is known.
23. The test chemical is applied. It should not be added to the soil within half an hour of introducing the worms (or if worms are present on the soil surface) so as to avoid any direct exposure to the test chemical by skin contact. When the test chemical is a pesticide it may be appropriate to apply it to the soil surface by spraying. The test chemical should be applied to the surface of the soil as evenly as possible using a suitable laboratory-scale spraying device to simulate spray application in the field. Before application the cover of the test container should be removed and replaced by a liner which protects the side walls of the container from spray. The liner can be made from a test container with the base removed. The application should take place at a temperature within 20 ± 2 °C of variation and for aqueous solutions, emulsions or dispersions at a water application rate of between 600 and 800 $\mu\text{l}/\text{m}^2$. The rate should be verified using an appropriate calibration technique. Special formulations like granules or seed dressings should be applied in a manner consistent with agricultural use.
24. Test containers should be left uncovered for a period of one hour to allow any volatile solvent associated with the application of the test chemical to evaporate. Care should be taken that no worm will escape from the test vessels within this time.

PROCEDURE**Test groups and controls**

25. A loading of 10 earthworms in 500-600 g dry mass of artificial soil (i.e. 50-60 g of soil per worm) is recommended. If larger quantities of soil are used, as might be the case if testing pesticides with special modes of application such as seed dressings, the loading of 50-60 g of soil per worm should be maintained by increasing the number of worms. Ten worms are prepared for each control and treatment container. The worms are washed with water and wiped and then placed on absorbent paper for a short period to allow excess water to drain.
26. To avoid systematic errors in distributing the worms to the test containers the homogeneity of the test population should be determined by individually weighing 20 worms sampled randomly from the population from which the test worms are to be taken. Having ensured homogeneity, batches of worms are then selected, weighed and assigned to test containers using a randomisation procedure. After the addition of the test worms, the weight of each test container should be measured to ensure that there is an initial weight

▼ M6

that can be used as the basis for monitoring soil moisture content throughout the test as described in paragraph 30. The test containers are then covered as described in paragraph 9 and placed in the test chamber.

27. Appropriate controls are prepared for each of the methods of test chemical application described in paragraphs 18 to 24. The relevant procedures described are followed for preparing the controls except that the test chemical is not added. Thus, where appropriate, organic solvents, quartz sand or other vehicles are applied to the controls in concentrations/amounts consistent with those used in the treatments. Where a solvent or other vehicle is used to add the test chemical an additional control without the vehicle or test chemical should also be prepared and tested to ensure that the vehicle has no bearing on the result.

Test conditions

28. The test temperature is 20 ± 2 °C. The test is carried out under controlled light-dark cycles (preferably 16 hours light and 8 hours dark) with illumination of 400 to 800 lux in the area of the test containers.
29. The test containers are not aerated during the test but the design of the test vessel covers should provide opportunity for gaseous exchange whilst limiting evaporation of moisture (see paragraph 9).
30. The water content of the soil substrate in the test containers is maintained throughout the test by re-weighing the test containers (minus their covers) periodically. Losses are replenished as necessary with de-ionised water. The water content should not vary by more than 10 % from that at the start of the test.

Feeding

31. Any food of a quality shown to be suitable for at least maintaining worm weight during the test is considered acceptable. Experience has shown that oatmeal, cow or horse manure is a suitable food. Checks should be made to ensure that cows or horses from which manure is obtained are not subject to medication or treatment with chemicals, such as growth promoters, nematicides or similar veterinary products that could adversely affect the worms during the test. Self-collected cow manure is recommended, since experience has shown that commercially available cow manure used as garden fertiliser may have adverse effects on the worms. The manure should be air-dried, finely ground and pasteurised before use.
32. Each fresh batch of food should be fed to a non-test worm culture before use in a test to ensure that it is of suitable quality. Growth and cocoon production should not be reduced compared to worms kept in a substrate that does not contain the new batch of food (conditions as described in test method C.8(4)).
33. Food is first provided one day after adding the worms and applying the test chemical to the soil. Approximately 5 g of food is spread on the soil surface of each container and moistened with de-ionised water (about 5 ml to 6 ml per container). Thereafter food is provided once a week during the 4-week test period. If food remains uneaten the ration should be reduced so as to avoid fungal growth or moulding. The adults are removed from the soil on

▼M6

day 28 of the test. A further 5 g of food is then administered to each test container. No further feeding takes place during the remaining 4 weeks of the test.

Selection of test concentrations

34. Prior knowledge of the toxicity of the test chemical should help in selecting appropriate test concentrations, e.g. from an acute test (4) and/or from range-finding studies. When necessary, a range-finding test is conducted with, for example, five test concentrations of 0,1, 1,0, 10, 100, and 1 000 mg/kg (dry mass of soil). One replicate for each treatment and control is sufficient. The duration of the range-finding test is two weeks and the mortality is assessed at the end of the test.

Experimental design

35. Since a single summary statistic cannot be prescribed for the test, this test method makes provision for the determination of the NOEC and the EC_x. A NOEC is likely to be required by regulatory authorities for the foreseeable future. More widespread use of the EC_x, resulting from statistical and ecological considerations, may be adopted in the near future. Therefore, three designs are proposed, based on recommendations arising from a ring test of an enchytraeid reproduction test method (17).

36. In setting the range of concentrations, the following should be borne in mind:

- For determination of the NOEC, at least five/twelve concentrations in a geometric series should be tested. Four replicates for each test concentration plus eight controls are recommended. The concentrations should be spaced by a factor not exceeding 2,0.

- For determination of the EC_x (e.g. EC₁₀, EC₅₀), an adequate number of concentrations to cause at least four statistically significantly different mean responses at these concentrations is recommended. At least two replicates for each test concentration and six control replicates are recommended. The spacing factor may vary, i.e. less than or equal to 1,8 in the expected effect range and above 1,8 at the higher and lower concentrations.

- A combined approach allows for determination of both the NOEC and EC_x. Eight treatment concentrations in a geometric series should be used. Four replicates for each treatment plus eight controls are recommended. The concentrations should be spaced by a factor not exceeding 1,8.

Test duration and measurements

37. On Day 28 the living adult worms are observed and counted. Any unusual behaviour (e.g. inability to dig into the soil; lying motionless) and in morphology (e.g. open wounds) are also recorded. All adult worms are then removed from the test vessels and counted and weighed. Transfer of the soil containing the worms to a clean tray prior to the assessment may facilitate searching for the adults. The worms extracted from the soil should be washed prior to weighing (with de-ionised water) and the excess water removed by placing the worms briefly on filter paper. Any worms not found at this time are to be recorded as dead, since it is to be assumed that such worms have died and decomposed prior to the assessment.

▼ M6

38. If the soil has been removed from the containers it is then returned (minus the adult worms but containing any cocoons that have been produced). The soil is then incubated for four additional weeks under the same test conditions except that feeding only takes place once at the start of this phase of the test (see paragraph 33).
39. At the end of the second 4-week period, the number of juveniles hatched from the cocoons in the test soil and cocoon numbers are determined using procedures described in Appendix 5. All signs of harm or damage to the worm should also be recorded throughout the test period.

Limit test

40. If no effects are observed at the highest concentration in the range-finding test (i.e. 1 000 mg/kg), the reproduction test would be performed as a limit test, using a test concentration of 1 000 mg/kg. A limit test will provide the opportunity to demonstrate that the NOEC for reproduction is greater than the limit concentration whilst minimising the number of worms used in the test. Eight replicates should be used for both the treated soil and the control.

DATA AND REPORTING**Treatment of results**

41. Although an overview is given in Appendix 6, no definitive statistical guidance for analysing test results is given in this test method.
42. One endpoint is mortality. Changes in behaviour (e.g. inability to dig into the soil; lying motionless against the glass wall of the test vessel) and morphology (e.g. open wounds) of the adult worms should however also be recorded along with the presence of any juveniles. Probit analysis (18) or logistic regression should normally be applied to determine the LC_{50} . However, in cases where this method of analysis is unsuitable (e.g., if less than three concentrations with partial kills are available), alternative methods can be used. These methods could include moving averages (19), the trimmed Spearman-Kärber method (20) or simple interpolation (e.g., geometrical mean of LC_0 and LC_{100} , as computed by the square root of LC_0 multiplied by LC_{100}).
43. The other endpoint is fecundity (e.g. number of juveniles produced). However, as in the range-finding test, all other harmful signs should be recorded in the final report. The statistical analysis requires the arithmetic mean \bar{x} and the standard deviation per treatment and per control for reproduction to be calculated.
44. If an analysis of variance has been performed, the standard deviation, s , and the degrees of freedom (df) may be replaced by the pooled variance estimate obtained from the ANOVA and by its degrees of freedom, respectively — provided variance does not depend on the concentration. In this case, use the single variances of control and treatments. Those values are usually calculated by commercial statistical software using the per-vessel results as replicates. If pooling data for the negative and solvent controls appears reasonable rather than testing against one of those, they should be tested to see that they are not significantly different (for the appropriate test, consider paragraph 47 and Appendix 6).
45. Further statistical testing and inference depends on whether the replicate values are normally distributed and are homogeneous with regard to their variance.

▼ M6**NOEC Estimation**

46. The application of powerful tests should be preferred. One should use information e.g. from previous experience with ring-testing or other historic data on whether data are approximately normally distributed. Variance homogeneity (homoscedasticity) is more critical. Experience tells that the variance often increases with increasing mean. In these cases, a data transformation could lead to homoscedasticity. However, such a transform should be based on experience with historic data rather than on data under investigation. With homogeneous data, multiple t-tests such as Williams' test ($\alpha = 0,05$, one-sided) (21)(22) or in certain cases Dunnett's test (23)(24) should be performed. It should be noted that, in the case of unequal replication, the table t-values must be corrected as suggested by Dunnett and Williams. Sometimes, because of large variation, the responses do not increase/decrease regularly. In this case of strong deviation from monotonicity the Dunnett's test is more appropriate. If there are deviations from homoscedasticity, it may be reasonable to investigate possible effects on variances more closely to decide whether the t- tests can be applied without losing much power (25). Alternatively, a multiple U-test, e.g. the Bonferroni-U-test according to Holm (26), or when these data exhibit heteroscedasticity but are otherwise consistent with a underlying monotone dose-response, an other non-parametric test (e.g. Jonckheere-Terpstra (27)(28) or Shirley (29) (30)) can be applied and would generally be preferred to unequal-variance t-tests. (see also the scheme in Appendix 6).
47. If a limit test has been performed and the prerequisites of parametric test procedures (normality, homogeneity) are fulfilled, the pair-wise Student-t-test can be used or otherwise the Mann-Whitney-U-test procedure (31).

EC_x Estimation

48. To compute any EC_x value, the per-treatment means are used for regression analysis (linear or non-linear), after an appropriate dose-response function has been obtained. For the growth of worms as a continuous response, EC_x-values can be estimated by using suitable regression analysis (32). Among suitable functions for quantal data (mortality/survival) and number of offspring produced are the normal sigmoid, logistic or Weibull functions, containing two to four parameters, some of which can also model hormetic responses. If a dose-response function was fitted by linear regression analysis a significant r^2 (coefficient of determination) and/or slope should be found with the regression analysis before estimating the EC_x by inserting a value corresponding to x % of the control mean into the equation found by regression analysis. 95 %-confidence limits are calculated according to Fieller (cited in Finney (18)) or other modern appropriate methods.
49. Alternatively, the response is modeled as a percent or proportion of model parameter which is interpreted as the control mean response. In these cases, the normal (logistic, Weibull) sigmoid curve can often be easily fitted to the results using the probit regression procedure (18). In these cases the weighting function has to be adjusted for metric responses as given by Christensen (33). However, if hormesis has been observed, probit analysis should be replaced by a four-parameter logistic or Weibull function, fitted by a non-linear regression procedure (34). If a suitable dose-response function cannot be fitted to the data, one may use alternative methods to estimate the EC_x, and its confidence limits, such as Moving Averages after Thompson (19) and the Trimmed Spearman-Kärber procedure (20).

TEST REPORT

50. The test report must include the following information:

▼ M6*Test chemical:*

- a definitive description of the test chemical, batch, lot and CAS-number, purity;
- properties of the test chemical (e.g. log K_{ow}, water solubility, vapour pressure, Henry's constant (H) and information on fate and behaviour).

Test organisms:

- test animals used: species, scientific name, source of organisms and breeding conditions;
- age, size (mass) range of test organisms.

Test conditions

- preparation details for the test soil;
- the maximum water holding capacity of the soil;
- a description of the technique used to apply the test chemical to the soil;
- details of auxiliary chemicals used for administering the test chemical;
- calibration details for spraying equipment if appropriate;
- description of the experimental design and procedure;
- size of test containers and volume of test soil;
- test conditions: light intensity, duration of light-dark cycles, temperature;
- a description of the feeding regime, the type and amount of food used in the test, feeding dates;
- pH and water content of the soil at the start and end of the test.

Test results:

- adult mortality (%) in each test container at the end of the first 4 weeks of the test;
- the total mass of adults at the beginning of the test in each test container;
- changes in body weight of live adults (% of initial weight) in each test container after the first four weeks of the test;
- the number of juveniles produced in each test container at the end of the test;
- a description of obvious or pathological symptoms or distinct changes in behaviour;
- the results obtained with the reference test chemical;
- the LC₅₀, the NOEC and/or EC_x (e.g. EC₅₀, EC₁₀) for reproduction if some of them are applicable with confidence intervals, and a graph of the fitted model used for its calculation all information and observations helpful for the interpretation of the results;
- a plot of the dose-response-relationship;
- the results applicable to each test container;

Deviations from procedures described in this test method and any unusual occurrences during the test.

LITERATURE

- (1) Jaenicke, J. (1982). '*Eisenia foetida*' is two biological species. *Megadriologica* 4, 6-8.
- (2) Oien, N. and J. Stenerson (1984). Esterases of earthworm — III. Electrophoresis reveals that *Eisenia foetida* (Savigny) is two species. *Comp. Biochem. Physiol.* 78c (2), 277 - 282.

▼ **M6**

- (3) Kula, C. (1996). Development of a test method on sublethal effects of pesticides on the earthworm species *Eisenia fetida/Eisenia andrei* — comparison of two ringtests. In: Riepert, F., Kula, C. (1996): Development of laboratory methods for testing effects of chemicals and pesticides on collembola and earthworms. Mitt. Biol. Bundesamst. f. Land- Forstwirtschaft. Berlin-Dahlem, 320, p. 50-82.
- (4) Chapter C.8 of this Annex, Earthworm acute toxicity test.
- (5) ISO (International Organization for Standardization) (1996). Soil Quality — Effects of pollutants on earthworms (*Eisenia fetida*). Part 2: Determination of effects on reproduction, No.11268-2. ISO, Geneve.
- (6) ISO (International Organization for Standardization) (1993). Soil Quality — Effects of pollutants on earthworms (*Eisenia fetida*). Part 1: Determination of acute toxicity using artificial soil substrate, No.11268-1. ISO, Geneve.
- (7) SETAC (1998). Advances in Earthworm Ecotoxicology. Sheppard, S.C., Bembridge, J.D., Holmstrup, M., and L. Posthuma, (eds). SETAC Press, 456 pp.
- (8) EPA (1996). Ecological effects test guidelines. Earthworm Subchronic Toxicity Test (850.62.00). United States Environmental Protection Agency. Office of Prevention, Pesticides and Toxic Substances. EPA712-C-96-167, April 1996.
- (9) Bouché, M.B. (1972). Lombriciens de France, Ecologie et systématique. Publication de l'Institut National de la Recherche Agronomique.
- (10) Edwards, C.A. (1983). Development of a standardized laboratory method for assessing the toxicity of chemical substances to earthworms. Report EUR 8714 EN, Commission of European Communities.
- (11) Greig-Smith, P.W., H. Becker, P.J. Edwards and F. Heimbach (eds.) (1992). Ecotoxicology of Earthworms. Intercept.
- (12) Edwards, C.A. and J. P. Bohlen, (1996). Biology and ecology of Earthworms, 3rd Edition. Chapman and Hall, London.
- (13) ISO (International Organization for Standardization) (1994). Soil Quality — Determination of pH, No. 10390. ISO, Geneve.
- (14) Hund-Rinke, K, Römbke, J., Riepert, F. & Achazi R. (2000): Beurteilung der Lebensraumfunktion von Böden mit Hilfe von Regenwurmtests. In: Toxikologische Beurteilung von Böden. Heiden, S., Erb, R., Dott, W. & Eisentraeger, A. (eds.). Spektrum Verl., Heidelberg. 59-81.
- (15) ISO (International Organization for Standardization) (1992). Soil Quality —Determination of water retention characteristics —Laboratory methods, No. 11274. ISO, Geneve.
- (16) ISO (International Organization for Standardization) (1993). Soil Quality —Determination of dry matter and water content on a mass basis — Gravimetric method, No. 11465. ISO, Geneve.
- (17) Römbke, J. and Th. Moser (1999). Organisation and Performance of an International Ringtest for the validation of the Enchytraeid Reproduction Test. UBA-Texte 4/99, 150+ 223 pp.

▼ M6

- (18) Finney, D.J. (1971). *Probit Analysis* (3rd ed.), pp. 19-76. Cambridge Univ. Press.
- (19) Finney, D.J. (1978). *Statistical Method in Biological Assay*. — Charles Griffin & Company Ltd, London.
- (20) Hamilton, M.A., R.C. Russo and R.V. Thurston. (1977). Trimmed Spearman-Kärber Method for estimating median lethal concentrations in toxicity bioassays. *Environ. Sci. Technol.* 11(7), 714-719; Correction *Environ. Sci. Technol.* 12(1998), 417.
- (21) Williams, D.A., (1971). A test for differences between treatment means when several dose levels are compared with a zero dose control. *Biometrics* 27, 103-117.
- (22) Williams, D.A., (1972). The comparison of several dose levels with a zero dose control. *Biometrics* 28, 519-531.
- (23) Dunnett, C.W., (1955). A multiple comparison procedure for comparing several treatments with a control. *Amer. Statist. Ass. J.* 50, 1096-1121.
- (24) Dunnett, C.W., (1964) New tables for multiple comparisons with a control. *Biometrics* 20, 482-491.
- (25) Hoeven, N. van der, (1998). Power analysis for the NOEC: What is the probability of detecting small toxic effects on three different species using the appropriate standardized test protocols? *Ecotoxicology* 7: 355-361
- (26) Holm, S., (1979): A simple sequentially rejective multiple test procedure. *Scand. J. Statist.* 6, 65-70.
- (27) Jonckheere, A. R. (1954); A Distribution-free k-Sample Test Against Ordered Alternatives, *Biometrika* 41, 133-145.
- (28) Terpstra, T. J. (1952); The Asymptotic Normality and Consistency of Kendall's Test Against Trend, When Ties are Present in One Ranking, *Indagationes Math.* 14, 327-333.
- (29) Shirley, E. A. (1979); The comparison of treatment to control group means in toxicology studies, *Applied Statistics* 28, 144-151.
- (30) Williams, D.A. (1986); A Note on Shirley's Nonparametric Test for Comparing Several Dose Levels with a Zero-Dose Control, *Biometrics* 42, 183-186.
- (31) Sokal, R.R. and F.J. Rohlf. (1981). *Biometry. The Principle and practice of statistics in biological research.* 2nd edition. W.H. Freeman and Company. New York.
- (32) Bruce R.D. and Versteeg D.J. (1992) A statistical procedure for modelling continuous toxicity data. *Environmental Toxicology and Chemistry* 11:1485-1494
- (33) Christensen, E.R., (1984). Dose-response functions in aquatic toxicity testing and the Weibull model. *Water Research* 18, 213-221.
- (34) Van Ewijk, P.H. and J.A. Hoekstra. (1993). Calculation of the EC50 and its confidence interval when sub-toxic stimulus is present. *Ecotox, Environ. Safety.* 25, 25-32.

▼ M6*Appendix 1***Definitions**

The following definitions are applicable to this test method:

Chemical means a substance or a mixture.

EC_x (Effect concentration for x % effect) is the concentration that causes an x % of an effect on test organisms within a given exposure period when compared with a control. For example, an EC₅₀ is a concentration estimated to cause an effect on a test end point in 50 % of an exposed population over a defined exposure period. In this test the effect concentrations are expressed as a mass of test chemical per dry mass of the test soil or as a mass of the test chemical per unit area of the soil.

LC₀ (No lethal concentration) is the concentration of a test chemical that does not kill any of exposed test organisms within a given time period. In this test the LC₀ is expressed as a mass of test chemical per dry mass of the test soil.

LC₅₀ (Median lethal concentration) is the concentration of a test chemical that kills 50 % of exposed test organisms within a given time period. In this test the LC₅₀ is expressed as a mass of test chemical per dry mass of the test soil or as a mass of test chemical per unit area of soil.

LC₁₀₀ (Totally lethal concentration) is the concentration of a test chemical kills 100 % of exposed test organisms within a given time period. In this test the LC₁₀₀ is expressed as a mass of test chemical per dry mass of the test soil.

LOEC (Lowest Observed Effect Concentration) is the lowest test chemical concentration that has a statistically significant effect ($p < 0,05$) In this test the LOEC is expressed as a mass of test chemical per dry mass of the test soil or as a mass of test chemical per unit area of soil. All test concentrations above the LOEC should normally show an effect that is statistically different from the control. Any deviations from the above must be justified in the test report.

NOEC (No Observed Effect Concentration) is the highest test chemical concentration immediately below the LOEC at which no effect is observed. In this test, the concentration corresponding to the NOEC, has no statistically significant effect ($p < 0,05$) within a given exposure period when compared with the control.

Reproduction rate: Mean number of juvenile worms produced per a number of adults over the test period.

Test chemical means any substance or mixture tested using this test method.

▼ M6*Appendix 2***Determination of the maximum water holding capacity of the soil**

The following method for determining the maximum water holding capacity of the soil has been found to be appropriate. It is described in Annex C of the ISO DIS 11268-2 (1).

Collect a defined quantity (e.g. 5 g) of the test soil substrate using a suitable sampling device (auger tube etc.). Cover the bottom of the tube with a piece of filter paper fill with water and then place it on a rack in a water bath. The tube should be gradually submerged until the water level is above to the top of the soil. It should then be left in the water for about three hours. Since not all water absorbed by the soil capillaries can be retained, the soil sample should be allowed to drain for a period of two hours by placing the tube onto a bed of very wet finely ground quartz sand contained within a covered vessel (to prevent drying). The sample should then be weighed, dried to constant mass at 105 °C. The water holding capacity (WHC) can then be calculated as follows:

$$\text{WHC (in \% of dry mass)} = \frac{S - T - D}{D} \times 100$$

Where:

S = water-saturated substrate + mass of tube + mass of filter paper

T = tare (mass of tube + mass of filter paper)

D = dry mass of substrate

REFERENCES:

- (1) ISO (International Organization for Standardisation) (1996). Soil Quality — Effects of pollutants on earthworms (*Eisenia fetida*). Part 2: Determination of effects on reproduction, No.11268-2. ISO, Geneve.

▼M6*Appendix 3***Determination of soil pH**

The following method for determining the pH of a soil is based on the description given in ISO DIS 10390: Soil Quality — Determination of pH (1).

A defined quantity of soil is dried at room temperature for at least 12 h. A suspension of the soil (containing at least 5 grams of soil) is then made up in five times its volume of either a 1 M solution of analytical grade potassium chloride (KCl) or a 0,01 M solution of analytical grade calcium chloride (CaCl₂). The suspension is then shaken thoroughly for five minutes and then left to settle for at least 2 hours but not for longer than 24 hours. The pH of the liquid phase is then measured using a pH-meter that has been calibrated before each measurement using an appropriate series of buffer solutions (e.g. pH 4,0 and 7,0).

REFERENCES:

- (1) ISO (International Organization for Standardization) (1994). Soil Quality — Determination of pH, No. 10390. ISO, Geneva.

▼ M6*Appendix 4***Culturing of *Eisenia fetida*/*Eisenia andrei***

Breeding should preferably be carried out in a climatic chamber at $20\text{ °C} \pm 2\text{ °C}$. At this temperature and with the provision of sufficient food, the worms become mature after about 2 to 3 months.

Both species can be cultured in a wide range of animal wastes. The recommended breeding medium is a 50:50 mixture of horse or cattle manure and peat. Checks should be made to ensure that cows or horses from which manure is obtained are not subject to medication or treatment with chemicals, such as growth promoters, nematicides or similar veterinary products that could adversely affect the worms during the test. Self-collected manure obtained from an 'organic' source is recommended, since experience has shown that commercially available manure used as garden fertiliser may have adverse effects on the worms. The medium should have a pH value of approximately 6 to 7 (adjusted with calcium carbonate), a low ionic conductivity (less than 6 mS/cm or 0,5 % salt concentration) and should not be contaminated excessively with ammonia or animal urine. The substrate should be moist but not too wet. Breeding boxes of 10 to 50-litre capacity are suitable.

To obtain worms of standard age and size (mass), it is best to start the culture with cocoons. Once the culture has been established it is maintained by placing adult worms in a breeding box with fresh substrate for 14 days to 28 days to allow further cocoons to be produced. The adults are then removed and the juveniles produced from the cocoons used as the basis for the next culture. The worms are fed continuously with animal waste and transferred into fresh substrate from time to time. Experience has shown that air-dried finely ground cow or horse manure or oatmeal is a suitable food. It should be ensured that cows or horses from which manure is obtained are not subject to medication treatment with chemicals, such as growth promoters, that could adversely affect the worms during long term culture. The worms hatched from the cocoons are used for testing when they are between 2 and 12 months old and considered to be adults.

Worms can be considered to be healthy if they move through the substrate, do not try to leave the substrate and reproduce continuously. Substrate exhaustion is indicated by worms moving very slowly and having a yellow posterior end. In this case the provision of fresh substrate and/or a reduction in stocking density is recommended.

▼ M6*Appendix 5***Techniques for counting juvenile worms hatched from cocoons**

Hand sorting of worms from the soil substrate is very time-consuming. Two alternative methods are therefore recommended:

- (a) The test containers are placed in a water bath initially at a temperature of 40 °C but rising to 60 °C. After a period of about 20 minutes the juvenile worms should appear at the soil surface from which they can be easily removed and counted.
- (b) The test soil may be washed through a sieve using the method developed by van Gestel et al. (1) providing the peat and the manure or oatmeal added to the soil were ground to a fine powder. Two 0,5 mm mesh size sieves (diameter 30 cm) are placed on top of each other. The contents of a test container are washed through the sieves with a powerful stream of tap water, leaving the young worms and cocoons mainly on the upper sieve. It is important to note that the whole surface of the upper sieve should be kept wet during this operation so that the juvenile worms float on a film of water, thereby preventing them from creeping through the sieve pores. Best results are obtained when a showerhead is used.

Once all the soil substrate has been washed through the sieve, juveniles and cocoons can be rinsed from the upper sieve into a bowl. The contents of the bowl are then left to stand allowing empty cocoons to float on the water surface and full cocoons and young worms to sink to the bottom. The standing water can then be poured off and the young worms and cocoons transferred to a petri dish containing a little water. The worms can be removed for counting using a needle or a pair of tweezers.

Experience has shown that method (a) is better suited to extraction of juvenile worms that might be washed through even a 0,5 mm sieve.

The efficiency of the method used to remove the worms (and cocoons if appropriate) from the soil substrate should always be determined. If juveniles are collected using the hand sorting technique it is advisable to carry out the operation twice on all samples.

REFERENCES:

- (1) Van Gestel, C.A.M., W.A. van Dis, E.M. van Breemen, P.M. Sparenburg (1988). Comparison of two methods determining the viability of cocoons produced in earthworm toxicity experiments. *Pedobiologia* 32:367-371.

▼ M6

Appendix 6

Overview of the statistical assessment of data (NOEC determination)

Parametric Tests

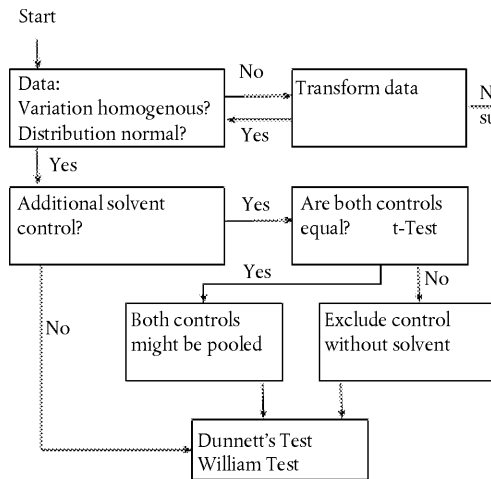

Non-parametric Tests

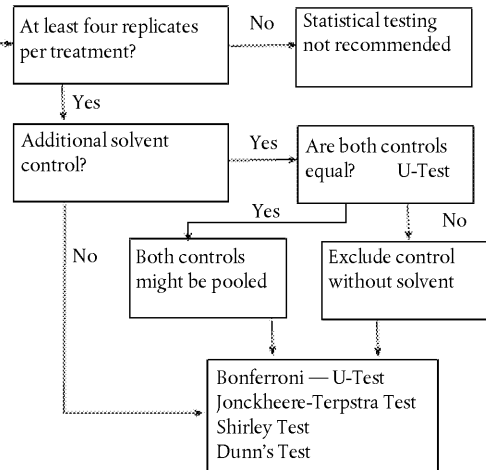

▼ M6**C.34. DETERMINATION OF THE INHIBITION OF THE ACTIVITY OF ANAEROBIC BACTERIA — REDUCTION OF GAS PRODUCTION FROM ANAEROBICALLY DIGESTING (SEWAGE) SLUDGE**

INTRODUCTION

1. This test method is equivalent to the OECD test guideline (TG) 224 (2007). Chemicals discharged to the aquatic environment pass through both aerobic and anaerobic zones, where they may be degraded and/or can inhibit bacterial activity; in some cases they can remain in anaerobic zones undisturbed for decades or longer. In waste water treatment the first stage, primary settlement, is aerobic in the supernatant liquid and anaerobic in the subnatant sludge. This is followed in the secondary stage by an aerobic zone in the activated sludge aeration tank and an anaerobic zone in the subnatant sludge in the secondary settlement tank. Sludge from both of these stages is usually subjected to anaerobic treatment, producing methane and carbon dioxide which are normally used to produce electricity. In the wider environment, chemicals reaching sediments in bays, estuaries and the sea are likely to remain in these anaerobic zones indefinitely if they are not biodegradable. Larger proportions of some chemicals will preferably reach these zones because of their physical properties, such as low solubility in water, high adsorption to suspended solids, as well as inability to be biodegraded aerobically.
2. While it is desirable that chemicals discharged to the environment should be biodegradable under both aerobic and anaerobic conditions, it is essential that such chemicals do not inhibit the activity of microorganisms in either zone. In the UK there have been a few cases of complete inhibition of methane production caused by, for example, pentachlorophenol in industrial discharges, leading to very costly transportation of inhibited sludge from the digesters to 'safe' sites and importation of healthy digesting sludge from neighbouring installations. But there have been many cases of less severe disruption of digestion by several other chemicals, including aliphatic halohydrocarbons (dry-cleaning) and detergents, leading to significant impairment of digester efficiency.
3. Only one test method, C.11 (1), deals with inhibition of bacterial activity (Respiration of activated sludge), which assesses the effect of test chemicals on the rate of oxygen uptake in the presence of substrate. The method has been widely used to give early warning of possible harmful effects of chemicals on the aerobic treatment of wastewaters, as well as indicating non-inhibitory concentrations of test chemicals to be used in the various tests for biodegradability. Test method C.43 (2) offers a limited opportunity for determining the toxicity of a test chemical to gas production by anaerobic sludge, diluted to one tenth of its normal concentration of solids to allow the required precision in the assessment of percentage biodegradation. Because diluted sludge could be more sensitive to inhibitory chemicals, the ISO group decided to prepare a method using undiluted sludge. At least three texts were examined (from Denmark, Germany and the UK) and finally two ISO standards were prepared, one using undiluted sludge, ISO 13 641-1 (3) and the other using one hundredth diluted sludge, ISO 13 641-2 (4), to represent muds and sediments having low bacterial populations. Both methods were subjected to a ring-test (5); part 1 was confirmed as an acceptable standard but there was disagreement over part 2. The UK considered that, because a significant proportion of participants reported very little or no gas production, partly because the percentage gas space was too high (at 75 %) for optimal sensitivity, the method requires further investigation.
4. Earlier work in the UK (6)(7) described a manometric method using undiluted digesting sludge, plus raw sewage sludge as the substrate, in 500 ml flasks; the apparatus was cumbersome and the stench of the raw sludge was offensive. Later the more compact and convenient apparatus of Shelton and Tiedje (8) as developed by Battersby and Wilson (9) was successfully applied by Wilson et al. (10). Kawahara et al (11) successfully prepared more standard sludges in the laboratory for use in tests for anaerobic biodegradability and inhibition on a number of chemicals. Also,

▼ M6

raw sludge as the substrate was replaced to carry out a test either with one hundredth diluted anaerobic sludge or with muds, sediments etc. of low bacterial activity.

5. This method can provide information that is useful in predicting the likely effect of a test chemical on gas production in anaerobic digesters. However, only longer tests simulating working digesters more closely can indicate whether adaptation of the microorganisms to the test chemical can occur or whether chemicals likely to be absorbed and adsorbed onto sludge can build up to a toxic concentration over a longer period than allowed in this test.

PRINCIPLE OF THE TEST

6. Aliquots of a mixture of anaerobically digesting sludge (20 g/l to 40 g/l total solids) and a degradable substrate solution are incubated alone and simultaneously with a range of concentrations of the test chemical in sealed vessels for up to 3 days. The amount of gas (methane plus carbon dioxide) produced is measured by the increase in pressure (Pa) in the bottles. The percentage inhibition of gas production brought about by the various concentrations of the test chemical is calculated from the amounts produced in the respective test and control bottles. The EC₅₀ and other effective concentrations are calculated from plots of percentage inhibition against the concentration of the test chemicals or, more usually, its logarithm.

INFORMATION ON THE TEST CHEMICAL

7. Test chemicals should normally be used in the purest form readily available, since impurities in some chemicals, e.g. chlorophenols, can be much more toxic than the test chemical itself. However, the needs to test chemicals in the form in which they are produced/made commercially available should be considered. The use of formulated products is not routinely recommended, but for poorly soluble test chemicals the use of formulated material may be appropriate. Properties of the test chemical which should be available include solubility in water and some organic solvents, vapour pressure, adsorption coefficient, hydrolysis and biodegradability under anaerobic conditions.

APPLICABILITY OF THE METHOD

8. The test is applicable to chemicals which are soluble or insoluble in water, including volatile chemicals. But special care is necessary with materials of low water-solubility (see ref. (12)) and of high volatility. Also, inocula from other anaerobic sites, e.g. muds, saturated soils, sediments, may be used. Anaerobic bacterial systems that have previously been exposed to toxic chemicals may be adapted to maintaining their activity in the presence of xenobiotic chemicals. Inocula from adapted bacterial systems may show a higher tolerance to the test chemicals compared to inocula obtained from non-adapted systems.

REFERENCE CHEMICALS

9. To check the procedure, a reference chemical is tested by setting up appropriate vessels in parallel as part of normal test runs; 3, 5-dichlorophenol has been shown to be a consistent inhibitor of anaerobic gas production, as well as of oxygen consumption by activated sludge and other biochemical reactions. Two other chemicals have been shown to be more inhibitory to methane production than 3, 5-dichlorophenol, namely methylene bis-thiocyanate and pentachlorophenol but results with them have not been validated. Pentachlorophenol is not recommended since it is not readily available in a pure form.

▼ **M6**

REPRODUCIBILITY OF THE RESULTS

10. In an international ring test (5) there was only fair reproducibility in EC₅₀ values between the 10 participating laboratories for 3, 5-dichlorophenol and 2-bromo-ethane sulphonic acid. (The range for the former was 32 mg/l to 502 mg/l and for the latter 220-2 190 mg/l.)

Number of laboratories	As mg/l			As mg/g sludge		
	mean	s.d.	cv(%)	mean	s.d.	cv(%)
	3, 5-Dichlorophenol					
10	153	158	103	5	4,6	92
	2-Bromo-ethane sulphonic acid					
10	1 058	896	85	34	26	76

EC₅₀ data from ring test — undiluted sludge

11. The high coefficients of variation between laboratories to a large extent reflect differences in the sensitivity of the sludge microorganisms due to either pre-exposure or no pre-exposure to the test chemical or other chemically related chemicals. The precision with which the EC₅₀ value based on the sludge concentration was determined was barely better than the 'volumetric' value (mg/l). The three laboratories which reported the precision of their EC₅₀ values for 3,5-dichlorophenol showed much lower coefficients of variation (22, 9, and 18 % respectively for EC₅₀ mg/g) than those of the means of all ten laboratories. The individual means for the three laboratories were 3,1, 3,2 and 2,8 mg/g, respectively. The lower, acceptable coefficients of variation within laboratories compared with the much higher coefficients between laboratory values, namely 9-22 % cf. 92 %, indicate that there are significant differences in the properties of the individual sludges.

DESCRIPTION OF THE METHOD

Apparatus

12. Usual laboratory equipment and the following are required:

- (a) **Incubator** — spark-proof and controlled at 35 °C ± 2 °C;
- (b) **Pressure-resistant glass test vessels** of an appropriate nominal size⁽¹⁾, each fitted with a gas-tight coated septum, capable of withstanding about 2 bar or 2 × 10⁵ Pa (for coating use e.g. PTFE = polytetrafluoro-ethene). Glass serum bottles of nominal volume 125 ml, with an actual volume of around 160 ml, sealed with serum septa⁽²⁾ and crimped aluminium rings are recommended; but bottles of total volume between 0,1 and 1 litre may be used successfully;

⁽¹⁾ The recommended size is 0,1 litre to 1 litre.

⁽²⁾ The use of gas-tight silicone septa is recommended. It is further recommended that the gas-tightness of caps, especially butyl rubber septa, be tested because several commercially available septa are not sufficiently gas-tight against methane and some septa do not stay tight when they are pierced with a needle under the conditions of the test.

— Gas tight coated septa are recommended and must be used for volatile chemicals (some commercial septa are relatively thin, less than 0,5 cm, and do not stay gas tight after piercing with syringe needle);

— Butyl rubber septa (about 1 cm) are recommended, if the test substances are not volatile (these normally stay gas tight after piercing.)

— Prior to the test it is recommended that the septa are carefully examined for their ability to stay gas tight after piercing.

▼ M6

- (c) Precision pressure-meter ⁽¹⁾ and needle attachment

Total gas production (methane plus carbon dioxide) measured by means of a pressure-meter adapted to enable measurement and venting of the gas produced. An example of a suitable instrument is a hand-held precision pressure-meter connected to a syringe needle; a three-way gas-tight valve facilities the release of excess pressure (Appendix 1). It is necessary to keep the internal volume of the pressure transducer tubing and valve as low as possible, so that errors introduced by neglecting the volume of the equipment are insignificant;

- (d) Insulated containers, for transport of digesting sludge;
- (e) Three-way pressure valves;
- (f) Sieve, having a 1 mm square mesh;
- (g) Reservoir, for digesting sludge, a glass or high-density polyethylene bottle, capacity about 5 litre, fitted with a stirrer and facilities for passing a stream of nitrogen gas (see paragraph 13) through the headspace;
- (h) membrane filters (0,2 µm) for sterilising the substrate;
- (i) micro syringes, for the gas-tight connection of the pressure transducer (see paragraph 12(c)) to the headspace in the bottles (see paragraph 12(b)); also for adding insoluble liquid test materials into the bottles;
- (j) glove box, optional but recommended, with a slight positive pressure of nitrogen.

Reagents

13. Use analytical grade reagents throughout. Nitrogen gas, of high purity with a content of less than 5 µl/l oxygen, should be used throughout.

Water

14. If dilution is necessary at any stage, use deionised water previously de-aerated. Analytical controls on this water are not necessary, but ensure that the deionising apparatus is regularly maintained. Use deionised water also for the preparation of stock solutions. Prior to the addition of the anaerobic inoculum to any solution or dilution of test material, make sure that these are oxygen-free. This is done either by blowing nitrogen gas through the dilution water (or through the dilutions) for 1 hour before adding the inoculum, or alternatively by heating the dilution water to the boiling point and cooling to room temperature in an oxygen-free atmosphere.

Digested Sludge

15. Collect actively digesting sludge from a digester at a wastewater treatment plant, or alternatively, from a laboratory digester, treating sludge from

⁽¹⁾ The meter should be used and calibrated at regular intervals, according to the manufacturer's instructions. If a pressure-meter of the prescribed quality is used e.g. capsulated with a steel membrane, no calibration is necessary in the laboratory. It should be calibrated by a licensed institute at the recommended intervals. The accuracy of the calibration can be checked in the laboratory with a one-point measurement at 1×10^5 Pa against a pressure-meter with a mechanical display. When this point is measured correctly, the linearity will also be unaltered. If other measurement devices are used (without certified calibration by the manufacturer), conversion is recommended over the total range at regular intervals (Appendix 2).

▼ M6

predominantly domestic sewage. Practical information regarding sludge from a laboratory digester can be found elsewhere (11). If use of an adapted inoculum is intended, digesting sludge from an industrial sewage treatment plant may be considered. Use wide-necked bottles constructed from high-density polyethylene or a similar material, which can expand, for sludge collection. Add sludge to the sample bottles to within about 1 cm from the top of the bottles, seal them tightly, preferably with a safety valve (paragraph 12(e)), and place in insulated containers (paragraph 12(d)) to minimise temperature shock, until being transferred to an incubator maintained at $35\text{ °C} \pm 2\text{ °C}$. When opening the bottles, take care to release excess gas pressure either by cautiously loosening the seal, or by means of the three-way pressure-release valve (paragraph 12(e)). It is preferable to use the sludge within a few hours of collection, otherwise store at $35\text{ °C} \pm 2\text{ °C}$ under a headspace of nitrogen for up to 3 days, when little loss of activity normally occurs.

Warning — Digesting sludge produces flammable gases which present fire and explosion risks: it also contains potentially pathogenic organisms, so take appropriate precautions when handling sludge. For safety reasons, do not use glass vessels for collecting sludge.

Inoculum

16. Immediately prior to use, mix the sludge by gentle stirring and pass it through a 1 mm^2 mesh sieve (paragraph 12(f)) into a suitable bottle (paragraph 12(g)) through the headspace of which a stream of nitrogen is passed. Set aside a sample for measurement of the concentration of total dry solids (see e.g. ISO 11 923 (13) or equivalent EU standard). In general, use the sludge without dilution. The solids concentration is usually between 2 % and 4 % (w/v). Check the pH value of the sludge and, if necessary, adjust to $7 \pm 0,5$.

Test substrate

17. Dissolve 10 g nutrient broth (e.g. Oxoid), 10 g of yeast extract and 10 g of D-glucose in deionised water and dilute to 100 ml. Sterilise by filtration through a $0,2\text{ }\mu\text{m}$ membrane filter (paragraph 12(h)) and use immediately or store at 4 °C for not longer than 1 day.

Test chemical

18. Prepare a separate stock solution for each water-soluble test chemical to contain, for example, 10 g/l of the chemical in oxygen-free dilution water (paragraph 14). Use appropriate volumes of these stock solutions to prepare the reaction mixtures containing graded concentrations. Alternatively, prepare a dilution series of each stock solution so that the volume added to the test bottles is the same for each required final concentration. The pH of the stock solutions should be adjusted to $7 \pm 0,2$ if necessary.
19. For test chemicals which are insufficiently soluble in water, consult ISO 10 634 (12) or equivalent EU standard. If an organic solvent is needed to be used, avoid solvents such as chloroform and carbon tetrachloride, which are known strongly to inhibit methane production. Prepare a solution of an appropriate concentration of water-insoluble chemical in a suitable volatile solvent, for example, acetone, di-ethylether. Add the required volumes of solvent solution to the empty test bottles (paragraph 12(b)) and evaporate the solvent before the addition of sludge. For other treatments use ISO 10 634 (12) or equivalent EU standard, but be aware that any surfactants used to produce emulsions may be inhibitory to anaerobic gas production. If it is thought that the presence of organic solvents and emulsifying agents causes artefacts, the test chemical could be added directly to the test mixture as a powder or liquid. Volatile chemicals and water-insoluble liquid test chemicals may be injected into inoculated serum bottles, using micro-syringes (paragraph 12(i)).

▼ M6

20. Add test chemicals to the bottles to give a geometric series of concentrations, for example, 500 mg/l, 250 mg/l, 125 mg/l, 62,5 mg/l, 31,2 mg/l and 15,6 mg/l. If the range of toxicity is not known from similar chemicals, first carry out a preliminary range-finding test with concentration of 1 000 mg/l, 100 mg/l and 10 mg/l to ascertain the appropriate range.

Reference chemical

21. Prepare an aqueous solution of 3,5-dichlorophenol (10 g/l) by gradually adding the minimum amount of 5 mol/l of sodium hydroxide solution to the solid, while shaking, until it has dissolved. Then add de-oxygenated dilution water (paragraph 14) to the required volume; sonication may aid dissolution. Other reference chemicals may be used when the average range of the EC₅₀ has been obtained in at least three tests with different inocula (different sources or different times of collection).

INTERFERENCE/ERRORS

22. Some constituents of sludge presumably could react with potential inhibitors making them unavailable to micro-organisms so giving lower, or no, inhibition. Also, if the sludge already contains a chemical which is inhibitory, erroneous results would be obtained when that chemical was subjected to the test. Apart from these possibilities, there are a number of identified factors which can lead to false results. These are listed in Appendix 3, together with methods of eliminating or at least reducing errors.

TEST PROCEDURE

23. The number of necessary replicates depends on the degree of precision required for the inhibition indices. If the bottle seals are sufficiently gas-tight over the duration of the test, set up just one batch (at least triplicates) of test bottles at each concentration required. Similarly, set up one batch of bottles with reference chemical and one set of controls. However, if the seals of the bottles are reliable for only one or a few piercings, set up a batch (e.g. triplicates) of the test bottles for each interval (t) for which results are required for all concentrations of a test chemical to be tested. Similarly, set up 't' batches of bottles for the reference chemical and for the controls.
24. The use of a glove box (paragraph 12(j)) is recommended. At least 30 minutes before starting the test, start a flow of nitrogen gas through the glove box containing all the necessary equipment. Ensure that the temperature of the sludge is within 35 °C ± 2 °C during handling and sealing of the bottles.

Preliminary Test

25. If the activity of the sludge is unknown, it is recommended to carry out a preliminary test. Set up controls to give, for example, concentrations of solids of 10 g/l, 20 g/l and 40 g/l plus substrate but use no test chemical. Also, use different volumes of reaction mixture in order to have three or four ratios of volume of headspace to volume of liquid. From the results of gas volumes produced at various time intervals, the most suitable conditions which allow two daily measurements yielding significant volumes of gas and release of pressure per day at optimal sensitivity⁽¹⁾ without fear of explosions.

Addition of test chemicals

26. Add water-soluble test chemicals to empty test bottles (paragraph 12(b)) as aqueous solutions (paragraph 18). Use at least triplicate sets of bottles for each of a range of concentrations (paragraph 20). In the case of insoluble and poorly soluble test chemical, inject solutions of these in organic solvents using a micro-syringe into empty bottles to give replicate sets of each five concentrations of test chemical. Evaporate the solvent by passing a jet of

⁽¹⁾ This applies to the experimental set-up and experimental conditions whereby the volumes of gas produced — from control blanks and from vessels indicating 70 - 80 % inhibition — may be estimated with acceptable margins of error.

▼M6

nitrogen gas over the surface of the solutions in the test bottles. Alternatively, add insoluble solid chemicals as weighed amounts of the solid directly to the test bottles.

27. If insoluble and poorly water-soluble liquid test chemicals are not added using a solvent, add them directly by micro-syringe to the test bottles after addition of inoculum and test substrate (see paragraph 30). Volatile test chemicals may be added in the same way.

Addition of inoculum and substrate

28. Stir an appropriate volume of sieved digesting sludge (see paragraph 16) in a 5 litre bottle (paragraph 12(g)), while passing a stream of nitrogen gas through the headspace. Flush test bottles, containing aqueous solutions or evaporated solvent solutions of test chemicals, with a stream of nitrogen gas, for about two minutes to remove air. Dispense aliquots, e.g. 100 ml, of the well-mixed sludge into the test bottles using a large-tipped pipette or a measuring cylinder. It is essential to fill the pipette in one step to the exact volume of sludge required because of the ease of settlement of sludge solids. If more is taken up, empty the pipette and start again.
29. Then add sufficient substrate solution (paragraph 17) to give a concentration of 2 g/l of each of the nutrient broth, yeast extract and D-glucose in the mixture, while nitrogen is still flushing through. The following is an example for test batches.

Final mass concentration of test chemical in test bottles (mg/l)	Volume of test chemical (ml)		Reagents and media (ml)		
	Stock solution (a) 10 g/l para. 18	Stock solution (b) 1 g/l para. 18	Dilution water para. 14	Inoculum para. 16	Substrate para. 17
0	—	0	1,0	100	2
1	—	0,1	0,9	100	2
3,3	—	0,33	0,67	100	2
10	0,1	—	0,9	100	2
33	0,33	—	0,67	100	2
100	1,0	—	0	100	2

Total volume of bottle = 160 ml. Volume of liquid = 103 ml

Gas volume = 57 ml, or 35,6 % of total volume.

30. Similarly flush out with nitrogen gas sufficient empty test bottles to deal with any volatile and insoluble liquid test chemical (see paragraph 27).

▼ M6**Controls and reference chemical**

31. Set up at least triplicate sets of bottles, containing sludge and substrate only, to act as controls. Set up further replicate bottles containing sludge and substrate plus sufficient stock solution of the reference chemical, 3,5-dichlorophenol (paragraph 21) to result in a final concentration of 150 mg/l. This concentration should inhibit gas production by about 50 %. Alternatively, set up a range of concentrations of the reference chemical. In addition, set up four extra bottles for pH measurement which contain sludge, de-oxygenated water and substrate. Add the test chemical to two bottles at the highest concentration being tested and add de-oxygenated water to the remaining two bottles.

32. Ensure that all bottles — test and reference chemicals, and controls — contain the same volume (V_R) of liquid; where necessary, add de-oxygenated deionised water (paragraph 14) to make up the volume. The headspace should be between 10 % and 40 % of the bottle volume, the actual value being selected from the data obtained from the preliminary test. After adding all constituents to the bottles, remove the needle supplying the gas and seal each bottle with a rubber stopper and an aluminium cap (Paragraph 12(b)) moistening the stopper with a drop of deionised water to aid insertion. Mix the contents of each bottle by shaking.

Incubation of bottles

33. Transfer the bottles to the thermostatically controlled incubator, preferably equipped with a shaking device, and maintained at $35\text{ °C} \pm 2\text{ °C}$. The bottles are incubated in the dark. After about 1 hour, equalise the pressure in the bottles to atmosphere by inserting the syringe needle, attached to the pressure-meter (paragraph 12(c)), through the seal of each bottle in turn, open the valve until the pressure-meter reads zero and finally close the valve. The needle should be inserted at an angle of about 45° to prevent gas leaking from the bottles. If the bottles are incubated without shaking facility, shake manually twice each day during the total incubation period to equilibrate the system. Incubate the bottles and invert them to prevent any loss of gas through the septum. Inversion is, however, not appropriate in cases in which insoluble test chemicals may adhere to the bottom of the flask.

Pressure measurement

34. When the bottles have reached $35\text{ °C} \pm 2\text{ °C}$, measure and record the pH of the contents of two of the four bottles set up for the purpose and discard the contents; continue incubating remaining bottles in the dark. Measure and record the pressure in the bottles twice a day over the following 48 hours to 72 hours by inserting the needle of the pressure-meter through the seal of each bottle, in turn, drying the needle between measurements. Keep all parts of the bottle at the incubation temperature during the measurement, which should be carried out as quickly as possible. Allow the pressure reading to stabilise and record it. Then open the valve for ventilation and close it when the pressure reads zero. Continue the test usually for 48 hours from the time of first equalising the pressure, designated 'time 0'. The number of readings and ventilations should be limited for volatile chemicals to one (at the end of incubation) or two to minimise loss of test chemical (10).

35. If the pressure reading is negative, do not open the valve. Moisture sometimes accumulates in the syringe needle and tubing, indicated by a small negative pressure reading. In this case remove the needle, shake the tubing, dry with a tissue and fit a new needle.

pH measurement

36. Measure and record the pH of the contents of each bottle after the final pressure measurement.

▼ M6**DATA AND REPORTING****Expression of results**

37. Calculate the sum and average of the pressures recorded at each time interval for each set of replicate bottles and calculate the mean cumulative gross gas pressure at each time interval for each set of replicates. Plot curves of mean cumulative gas production (Pa) against time for control, test and reference bottles. Select a time on the linear part of the curve, usually 48 hours, and calculate the percentage inhibition (I) for each concentration from equation [1]:

$$I = (1 - P_t/P_c) \times 100 \quad [1],$$

where

I = percentage inhibition, in %;

P_t = the gas pressure produced with test material at selected time, in Pascal (Pa);

P_c = the gas pressure produced in the control at the same time, in Pascal (Pa).

It would be advisable to draw both plots, i.e. Plot I against concentration and also against logarithm of the concentration so that the curve which is nearer to linearity may be selected. Assess the EC_{50} (mg/l) value visually or by regression analysis from that curve nearer to linearity. For comparative purposes it may be more useful to express the concentration of the chemical as mg chemical/g of total dry solids. To obtain this concentration, divide the volumetric concentration (mg/l) by the volumetric concentration of dry sludge solids (g/l) (paragraph 16).

38. Calculate either the percentage inhibition achieved by the single concentration of the reference chemical used or the EC_{50} if a sufficient number of concentrations have been investigated.
39. Convert the mean pressure of the gas produced in the control P_c (Pa) to the volume by reference to the pressure-meter calibration curve (Appendix 2) and from this calculate the yield of gas, expressed as the volume produced in 48 hours from 100 ml undiluted sludge at a solids concentration of 2 % (20 g/l) to 4 % (40 g/l).

Validity criteria

40. Results from the ISO inter-laboratory trial (5) showed the reference chemical (3,5-dichlorophenol) caused 50 % inhibition of gas production in a range of concentrations of 32 mg/l to 510 mg/l mean 153 mg/l (paragraph 10). This range is so wide that firm limits for inhibition cannot confidentially be set as validity criteria; this should be possible when developments have shown how to produce more consistent inocula. The volumes of gas produced in control bottles in 48 hour ranged from 21 ml/g sludge dry matter to 149 ml/g (mean 72 ml/g). There was no obvious relation between volume of gas produced and the corresponding EC_{50} value. The final pH varied between 6,1 and 7,5.
41. The test is considered to be valid when an inhibition of greater than 20 % is obtained in the reference control containing 150 mg/l of 3,5-dichlorophenol, more than 50 ml of gas per g of dry matter is produced in the blank control and the pH value is within the range of 6,2 to 7,5 at the end of the test.

Test Report

42. The test report must include the following information:

Test chemical

— common name, chemical name, CAS number, structural formula and relevant physico-chemical properties;

▼ M6

- purity (impurities) of test chemical.

Test conditions

- volumes of liquid contents and of headspace in test vessels;
- descriptions of the test vessels and gas measurement (e.g. type of pressure-meter);
- application of test chemical and reference chemical to the test system, test concentrations used and use of any solvents;
- details of the inoculum used: name of sewage treatment plant, description of the source of waste water treated (e.g. operating temperature, sludge retention time, predominantly domestic sewage or industrial waste, etc.), concentration of solids, gas production activity of anaerobic digester, previous exposure or possible pre-adaptation to toxic chemicals or site of collection of mud, sediment etc;
- incubation temperature and range;
- number of replicates.

Results

- pH values at end of test;
- all the measured data collected in the test, blank and reference chemical control vessels, as appropriate (e.g. pressure in Pa or millibars) in tabular form;
- percentage inhibition in test and reference bottles, and the inhibition-concentration curves;
- calculation of EC₅₀ values, expressed as mg/l and mg/g;
- gas production per g sludge in 48 hours;
- reasons for any rejection of the test results;
- discussion of results, including any deviations from the procedures in this test method and discuss any deviations in the test results due to interferences and errors from what would be expected;
- address also whether the purpose of the test was to measure the toxicity to either pre-exposed or non pre-exposed microorganisms.

LITERATURE

- (1) Chapter C.11 of this Annex: Activated Sludge, Respiration Inhibition Test.
- (2) Chapter C.43 of this Annex: Anaerobic biodegradability of organic compounds in digested sludge: method by measurement of gas production.
- (3) International Organisation for Standardisation (2003) ISO 13 641-1 Water Quality — Determination of inhibition of gas production of anaerobic bacteria — Part 1: General Test.
- (4) International Organisation for Standardisation (2003) ISO 13 641-2 Water Quality — Determination of inhibition of gas production of anaerobic bacteria — Part 2: Test for low biomass concentrations.
- (5) ISO (2000) Ring test of ISO 13 641-1 and ISO 13 641-2. Determination of inhibition of activity of anaerobic bacteria. BL 6958/A. Evans MR, Painter HA. Brixham Environmental Laboratory, AstraZeneca UK Ltd., Brixham, TQ5 8BA UK.

▼ M6

- (6) Swanwick JD, Foulkes M (1971). Inhibition of anaerobic digestion of sewage sludge by chlorinated hydrocarbons. *Wat. Pollut. Control*, 70, 58-70.
- (7) HMSO (1986) Determination of the inhibitory effects of chemicals and waste waters on the anaerobic digestion of sewage sludge. ISBN 0 117519 43 X, In: Methods for the Examination of Waters and Associated Materials UK.
- (8) Shelton DR, Tiedje JM (1984). General method for determining anaerobic biodegradation potential. *Appl. Env. Microbiol.* 47 850-857.
- (9) Battersby NS and Wilson V (1988). Evaluation of a serum bottle technique for assessing the anaerobic biodegradability of organic compounds under methanogenic conditions. *Chemosphere* 17, 2441-2460.
- (10) Wilson V, Painter HA and Battersby NS (1992). A screening method for assessing the inhibition of the anaerobic gas production from sewage sludge. *Proc. Int. Symp. on Ecotoxicology. Ecotoxicological Relevance of Test Methods*, GSF Forschungszentrum, Neuherberg, Germany (1990). Eds. Steinberg C and Kettrup A, pp117-132 (1992).
- (11) Kawahara K, Yakabe Y, Chida T, and Kida K (1999). Evaluation of laboratory-made sludge for an anaerobic biodegradability test and its use for assessment of 13 chemicals. *Chemosphere*, 39 (12), 2007-2018.
- (12) International Organization for Standardization (1995) ISO 10 634 Water Quality — Guidance for the preparation and treatment of poorly water-soluble organic compounds for the subsequent evaluation of their biodegradability in an aqueous medium.
- (13) International Organization for Standardization (1997) ISO 11 923 Water Quality — Determination of suspended solids by filtration through glass-fibre filters.

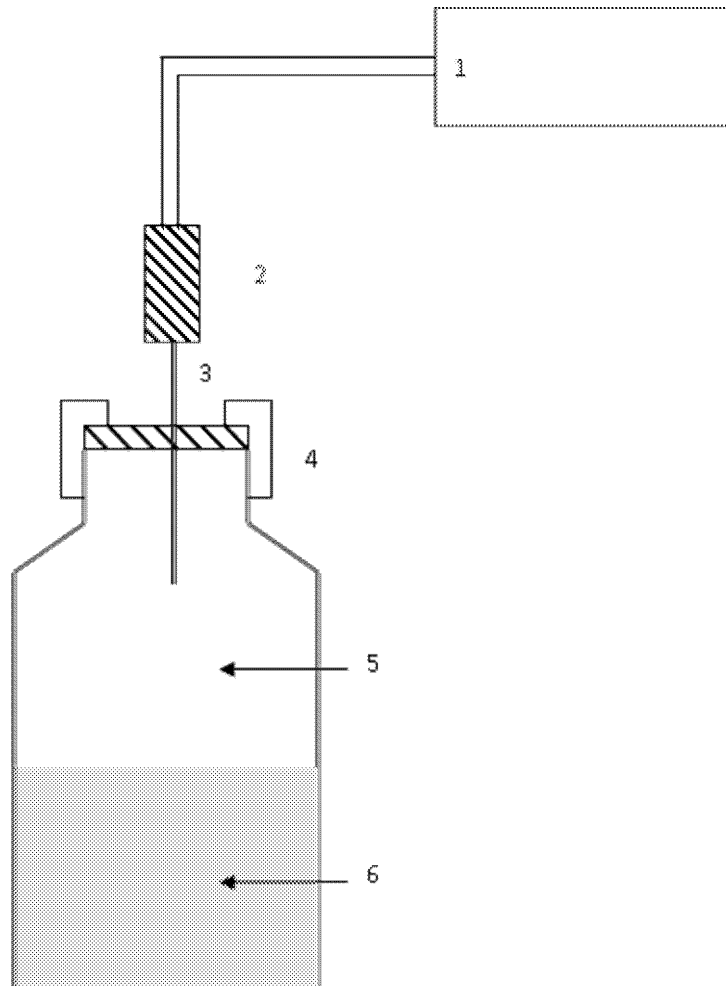
▼ **M6***Appendix 1***Example of an apparatus to measure biogas production by gas pressure***Key:*

- 1 — Pressure-meter
- 2 — 3-way gas-tight valve
- 3 — Syringe needle
- 4 — Gastight seal (crimp cap and septum)
- 5 — Head space
- 6 — Digested sludge inoculum

Test vessels in an environment of $35\text{ °C} \pm 2\text{ °C}$

▼M6*Appendix 2***Conversion of the pressure-meter**

The pressure-meter readings may be related to gas volumes by means of a standard curve and from this the volume of gas produced per g dry sludge per 48 hours may be calculated. This activity index is used as one of the criteria by which to assess the validity of test results. The calibration curve is produced by injecting known volumes of gas at $35\text{ °C} \pm 2\text{ °C}$ in serum bottles containing a volume of water equal to that of the reaction mixture, V_R ;

- Dispense V_R ml aliquots of water, kept at $35\text{ °C} \pm 2\text{ °C}$ into five serum bottles. Seal the bottles and place in a water bath at $35\text{ °C} \pm 2\text{ °C}$ for 1 hour to equilibrate;
- Switch on the pressure-meter, allow to stabilise, and adjust to zero;
- Insert the syringe needle through the seal of one of the bottles, open the valve until the pressure-meter reads zero and close the valve;
- Repeat the procedure with the remaining bottles;
- Inject 1 ml of air at $35\text{ °C} \pm 2\text{ °C}$ into each bottle. Insert the needle (on the meter) through the seal of one of the bottles and allow the pressure reading to stabilise. Record the pressure, open the valve until the pressure reads zero and then close the valve;
- Repeat the procedure with the remaining bottles;
- Repeat the total procedure using 2 ml, 3 ml, 4 ml, 5 ml, 6 ml, 8 ml, 10 ml, 12 ml, 16 ml, 20 ml, and 50 ml of air;
- Plot a conversion curve of pressure (Pa) against gas volume injected (ml). The response of the instrument is linear over the range 0 Pa to 70 000 Pa, and 0 ml to 50 ml of gas production.

▼ M6*Appendix 3***Identified factors which can lead to false results**(a) *Quality of the bottle-caps*

Different types of septa for the serum bottles are available commercially; many of them, including butyl rubber, lose tightness when pierced with a needle under the conditions of this test. Sometimes the pressure falls very slowly once the septum has been pierced with the syringe needle. The use of gas-tight septa is recommended to overcome leaks (paragraph 12(b)).

(b) *Moisture in the syringe needle*

Moisture sometimes accumulates in the syringe needle and tubing, and is indicated by a small negative pressure reading. To rectify this remove the needle and shake the tubing, dry with a tissue and fit a new needle (paragraphs 12(c) and 35).

(c) *Oxygen contamination*

Anaerobic methods are subject to error from contamination by oxygen, which can cause lower gas production. In this method this possibility should be minimised by the use of strictly anaerobic techniques, including use of a glove box.

(d) *Gross substrates in sludge*

The anaerobic gas production and the sensitivity of the sludge are influenced by substrates which are transferred with the inoculum into the test bottles. Digested sludge from domestic anaerobic digesters still often contains recognisable matter like hair and plant residues of cellulose, which tend to make it difficult to take representative samples. By sieving the sludge gross insoluble matter can be removed, which makes representative sampling more likely (paragraph 16).

(e) *Volatile test chemicals*

Volatile test chemicals will be released into the headspace of the test bottles. This may result in the loss of some of the test material from the system during venting after pressure measurements, yielding falsely high EC₅₀ values. By suitable choice of ratio of headspace volume to liquid volume and by not venting after taking pressure measurements, the error can be reduced (10).

(f) *Non-linearity of gas production*

If the plot of mean cumulative gas production against incubation time is not approximately linear over the 48h period, the accuracy of the test may be lowered. To overcome this, it may be advisable to use digesting sludge from a different source and/or to add an increased concentration of the test substrate-nutrient broth, yeast extract and glucose (paragraph 29).

▼ M6*Appendix 4***Application to environmental samples of low biomass concentration — anaerobic muds, sediments, etc.**

INTRODUCTION

- A.1 In general, the specific microbial activity (volume of gas produced per g dry solids) of naturally occurring anaerobic muds, sediments, soils, etc, is much lower than that of anaerobic sludge derived from sewage. Because of this, when the inhibitory effects of chemicals on these less active samples are to be measured some of the experimental conditions have to be modified. For these less active samples there are two general course of action possible:
- (a) Carry out a modified preliminary test (paragraph 25) with the undiluted sample of mud, soil, etc at $35\text{ °C} \pm 2\text{ °C}$ or at the temperature at the sample site of collection, for more accurate simulation (as in Part 1 of ISO 13 641);
- (b) Or make the test with a dilute (1 in 100) digester sludge to simulate the low activity expected from the environment sample, but maintain the temperature at $35\text{ °C} \pm 2\text{ °C}$ (as in Part 2 of ISO 13 641).
- A.2 Option (a) may be achieved by following the method described here (equivalent to Part 1 of ISO 13 641), but it is essential to make a preliminary test (paragraph 25) to ascertain optimal conditions, unless these are already known from previous testing. The mud or sediment sample should be thoroughly mixed, e.g. in a blender, and, if necessary, diluted with a small proportion of de-aerated dilution water (paragraph 14) so that it is sufficiently mobile to be transferred by a coarse-tipped pipette or a measuring cylinder. If it is considered that nutrients may be lacking, the mud sample may be centrifuged (under anaerobic conditions) and re-suspended in the mineral medium containing yeast extract (A.11)
- A.3 Option (b). This reasonably mimics the low activity of environmental samples but lacks the high concentration of suspended solids present in these samples. The role of these solids in inhibition is not known, but it is possible that reaction between the test chemicals and constituents of the mud, as well as adsorption of the test chemicals onto the solids, could result in a lowering of toxicity of the test chemical.
- A.4 Temperature is another important factor: for strict simulation, tests should be made at the temperature of the sample site, since different groups of methane-producing consortia of bacteria are known to operate within different temperature ranges, namely thermophiles ($\sim 30\text{-}35\text{ °C}$), mesophiles ($20\text{-}25\text{ °C}$) and psychrophiles ($< 20\text{ °C}$), which may display different inhibitory patterns.
- A.5 Duration. In the general test, Part 1, using undiluted sludge, the production of gas in the 2-4 days was always sufficient, while in Part 2 with one-hundred diluted sludge insufficient gas, if any, was produced in this period in the ring test. Madsen et al (1996), in describing this latter test, say at least 7 days should be allowed.

Testing with low biomass concentration (Option b)

The following changes and amendments should be made, adding to or replacing some existing paragraphs and sub-paragraphs of the main text.

▼ M6

A.6 Add to Paragraph 6: Principle of the test;

‘This technique may be used with 1 in 100 diluted anaerobic sludge, partially to simulate the low activity of muds and sediments. The incubation temperature may be either 35 °C or that of the site from which the sample was collected. Since the bacterial activity is much less than in undiluted sludge, the incubation period should be extended to at least 7 days.’

A.7 Add to paragraph 12 (a):

‘the incubator should be capable of operating down to temperatures of 15 °C.’

A.8 Add an extra reagent after Paragraph 13:

‘Phosphoric acid (H₃PO₄), 85 % by mass in water.’

A.9 Add at end of Paragraph 16:

‘Use a final concentration of 0,20 ± 0,05 g/l of total dry solids in the test.’

A.10 Paragraph 17. Test substrate

This substrate is not to be used, but is replaced by yeast extract (see paragraphs 17; A.11, A.12, A.13).

A.11 A mineral medium, including trace elements, for diluting anaerobic sludge, is required and for convenience the organic substrate, yeast extract, is added to this medium.

Add after Paragraph 17

‘(a) Test mineral medium, with yeast extract.

This is prepared from a 10-fold concentrated test medium (paragraph 17 (b); A.12) with a trace element solution (paragraph 17 (c); A.13). Use freshly supplied sodium sulphide nonahydrate (paragraph 17 (b); A.12) or wash and dry it before use, to ensure that it has sufficient reducing capacity. If the test is performed without using a glove box (paragraph 12 (j)), the concentration of sodium sulphide in the stock solution should be increased to 2 g/l (from 1 g/l). Sodium sulphide may also be added from an appropriate stock solution through the septum of the closed test bottles, as this procedure will decrease the risk of oxidation, to obtain a final concentration of 0,2 g/l. Alternatively titanium (III) citrate (paragraph 17 (b)) may be used. Add it through the septum of closed test bottles to obtain a concentration of 0,8 mmol/l to 1,0 mmol/l. Titanium (III) citrate is a highly effective and a low-toxicity reducing agent, which is prepared as follows: Dissolve 2,94 g of trisodium citrate dihydrate in 50 ml of oxygen-free dilution water (paragraph 14) (which results in a 200 mmol/l solution) and add 5 ml of a titanium (III) chloride solution (15 g/100 ml dilution water). Neutralise to pH 7 ± 0,5 with sodium carbonate and dispense to an appropriate serum bottle under a stream of nitrogen gas. The concentration of titanium (III) citrate in this stock solution is 164 mmol/l. Use the test medium immediately or store at 4 °C for no longer than 1 day.

A.12 (b) Tenfold concentrated test medium, prepared with the following:

anhydrous potassium dihydrogenphosphate (KH ₂ PO ₄)	2,7 g
Disodium hydrogen phosphate (Na ₂ HPO ₄)	4,4 g
(or 11,2 g dodecahydrate)	5,3 g
ammonium chloride (NH ₄ Cl)	

▼ **M6**

calcium chloride dihydrate (CaCl ₂ ·2H ₂ O)	0,75 g
magnesium chloride hexahydrate (MgCl ₂ ·6H ₂ O)	1,0 g
iron (II) chloride tetrahydrate (FeCl ₂ ·4H ₂ O)	0,2 g
resazurin (redox indicator)	0,01 g
sodium sulphide nonahydrate (Na ₂ S·9H ₂ O)	1,0 g
(or titanium (III) citrate) final concentration	0,8 mmol/l to 1,0 mmol/l
trace element solution (see paragraph 17 (c); A.13)	10,0 ml
yeast extract	100 g
Dissolve in dilution water (paragraph 14) and make up to:	1 000 ml

A.13 (c) Trace element solution, prepared with the following:

manganese (II) chloride tetrahydrate (MnCl ₂ ·4H ₂ O)	0,5 g
ortho-boric acid (H ₃ BO ₃)	0,05 g
zinc chloride (ZnCl ₂)	0,05 g
copper (II) chloride (CuCl ₂)	0,03 g
sodium molybdate dihydrate (Na ₂ MoO ₄ ·2H ₂ O)	0,01 g
cobalt (II) chloride hexahydrate (CoCl ₂ ·6H ₂ O)	1,0 g
nickel (II) chloride hexahydrate (NiCl ₂ ·6H ₂ O)	0,1 g
disodium selenite (Na ₂ SeO ₃)	0,05 g
Dissolve in dilution water (paragraph 14) and make up to:	1 000 ml

A.14 Paragraph 25: Preliminary test

It is essential that a preliminary test is made as described in paragraph 24, except that the concentration of sludge solids should be one hundredth of those given, that is 0,1 g/l, 0,2 g/l and 0,4 g/l. The duration of incubation should be at least 7 days.

Note: In the ring test (5) the headspace volume was much too high at 75 % total volume; it should be in the recommended range of 10 %-40 %. The relevant criterion is that the volume of gas produced at around 80 % inhibition should be measurable with acceptable precision (e.g. ± 5 % to ± 10 %).

A.15 Paragraph 26 to 30: Addition of test chemical, inoculum and substrate.

The additions are made in the same way as described in these paragraphs, but the substrate solution (paragraph 17) is replaced by the test medium plus yeast extract substrate (A.11).

Also, the final concentration of dry sludge solids is reduced from 2 g/l - 4 g/l to 0,2 ± 0,05 g/l (A.9). Two examples of the addition of components to the test mixture are given in Table A.1, which replaces the table in paragraph 29.

A.16 Paragraph 33: Incubation of bottles

Because of the expected lower rate of gas production, incubation is carried on for at least 7 days.

▼ **M6**

A.17 Paragraph 34: Pressure measurements

The same procedure for measuring the pressure in the headspace of the bottles is used as described in paragraph 34 if the amounts in the gaseous phase are required. If total amounts of CO₂ plus CH₄ are to be measured, the pH of the liquid phase is reduced to about pH 2 by the injection of H₃PO₄ into each relevant bottle and measuring the pressure after 30 minutes shaking at the temperature of the test. However, more information on the quality of the inoculum may be obtained by measuring the pressure in each bottle before and after acidification. For example when the rate of CO₂ production is much higher than that of methane, the sensitivity of the fermentative bacteria may be altered and/or methanogenic bacteria are preferentially affected by the test chemical.

A.18 Paragraph 36: pH measurement

If H₃PO₄ is to be used some extra bottles, to which no H₃PO₄ is added, would have to be set up especially for the pH measurement.

REFERENCE:

Madsen, T, Rasmussen, HB; and Nilsson, L (1996), Methods for screening anaerobic biodegradability and toxicity of organic chemicals. Project No.336, Water Quality Institute, Danish Environment Protection Agency, Copenhagen.

Table A.1.

Examples of the test set-up for test batches

Reaction Mixture constituents	Example 1	Example 2	Normal order of addition
Concentration of prepared inoculum (g/l)	0,42	2,1	—
Volume of inoculum added (ml)	45	9	4
Concentration of inoculum in test bottles (g/l)	0,20	0,20	—
Volume of test medium added (ml)	9	9	2
Volume of dilution water added (ml)	36	72	3
Concentration of yeast extract in test bottles (g/l)	9,7	9,7	—
Volume of test chemical stock solution (ml)	3	3	1
Total liquid volume (ml)	93	93	—

▼ **M6**

Appendix 5

Definitions

For the purpose of this test method the following definitions are used:

Chemical means a substance or a mixture.

Test chemical means any substance or mixture tested using this test method.

▼ M6**C.35. SEDIMENT-WATER *LUMBRICULUS* TOXICITY TEST USING SPIKED SEDIMENT**

INTRODUCTION

1. This test method is equivalent to OECD test guideline (TG) 225 (2007). Sediment-ingesting endobenthic animals are subject to potentially high exposure to sediment bound chemicals and should therefore be given preferential attention, e.g. (1), (2), (3). Among these sediment-ingesters, the aquatic oligochaetes play an important role in the sediments of aquatic systems. By bioturbation of the sediment and by serving as prey these animals can have a strong influence on the bioavailability of such chemicals to other organisms, e.g. benthivorous fish. In contrast to epibenthic organisms, endobenthic aquatic oligochaetes (e.g. *Lumbriculus variegatus*) burrow in the sediment, and ingest sediment particles below the sediment surface. This ensures exposure of the test organisms to the test chemical via all possible uptake routes (e.g. contact with, and ingestion of contaminated sediment particles, but also via porewater and overlying water).
2. This test method is designed to assess the effects of prolonged exposure of the endobenthic oligochaete *Lumbriculus variegatus* (Müller) to sediment-associated chemicals. It is based on existing sediment toxicity and bioaccumulation test protocols, e.g. (3), (4), (5), (6), (7), (8), (9), (10). The method is described for static test conditions. The exposure scenario used in this test method is spiking of sediment with the test chemical. Using spiked sediment is intended to simulate a sediment contaminated with the test chemical.
3. Chemicals that need to be tested towards sediment-dwelling organisms usually persist in this compartment over long time periods. Sediment-dwelling organisms may be exposed via several routes. The relative importance of each exposure route, and the time taken for each to contribute to the overall toxic effects, depends on the physical-chemical properties of the chemical concerned and its ultimate fate in the animal. For strongly adsorbing chemicals (e.g. with $\log K_{ow} > 5$) or for chemicals covalently binding to sediment, ingestion of contaminated food may be a significant exposure route. In order not to underestimate the toxicity of such chemicals, the food necessary for reproduction and growth of the test organisms is added to the sediment before application of the test chemical (11). The test method described is sufficiently detailed so that the test can be carried out whilst allowing for adaptations in the experimental design depending on the conditions in particular laboratories and the varied characteristics of test chemicals.
4. The test method is aimed to determine effects of a test chemical on the reproduction and the biomass of the test organisms. The measured biological parameters are the total number of surviving worms and the biomass (dry weight) at the end of the exposure. These data are analysed either by using a regression model in order to estimate the concentration that would cause an effect of x % (e.g. EC₅₀, EC₂₅, and EC₁₀), or by using statistical hypothesis testing to determine the No Observed Effect Concentration (NOEC) and the Lowest Observed Effect Concentration (LOEC).
5. Chapter C.27 of this Annex, 'Sediment-water chironomid toxicity test using spiked sediment' (6), provided many essential and useful details for the performance of the presented sediment toxicity test method. Hence, this document serves as a basis on which modifications necessary for conducting sediment toxicity tests with *Lumbriculus variegatus* were worked out. Further documents that are referred to are e.g. the ASTM Standard Guide for Determination of the Bioaccumulation of Sediment-Associated Contaminants by Benthic Invertebrates (3), the U.S. EPA Methods for Measuring the Toxicity and Bioaccumulation of Sediment-Associated Contaminants with Freshwater Invertebrates (7), and the ASTM Standard

▼ M6

Guide for Collection, Storage, Characterization, and Manipulation of Sediments for Toxicological Testing and for selection of samplers used to collect benthic invertebrates (12). In addition, practical experience obtained during ring-testing the test method (13), ring-test report), and details from literature are major sources of information for drawing up this document.

PREREQUISITE AND GUIDANCE INFORMATION

6. Information on the test chemical such as safety precautions, proper storage conditions and analytical methods should be obtained before beginning the study. Guidance for testing chemicals with physical-chemical properties that make them difficult to perform the test is provided in (14).
7. Before carrying out a test, the following information about the test chemical should be known:
 - common name, chemical name (preferably IUPAC name), structural formula, CAS registry number, purity;
 - vapour pressure;
 - solubility in water.
8. The following additional information is considered useful before starting the test:
 - octanol-water partition coefficient, K_{ow} ;
 - organic carbon-water partitioning coefficient, expressed as K_{oc} ;
 - hydrolysis;
 - phototransformation in water;
 - biodegradability;
 - surface tension.
9. Information on certain characteristics of the sediment to be used should be acquired before the start of the test (7). For details see paragraphs 22 to 25.

PRINCIPLE OF THE TEST

10. Worms of similar physiological state (synchronised as described in Appendix 5) are exposed to a series of toxicant concentrations applied to the sediment phase of a sediment-water system. Artificial sediment and reconstituted water should be used as media. Test vessels without the addition of the test chemical serve as controls. The test chemical is spiked into the sediment in bulk for each concentration level in order to minimise variability between replicates of each concentration level, and the test organisms are subsequently introduced into the test vessels in which the sediment and water concentrations have been equilibrated (see paragraph 29). The test animals are exposed to the sediment-water systems for a period of 28 days. In view of the low nutrient content of the artificial sediment, the sediment should be amended with a food source (see paragraphs 22 to 23, and Appendix 4) to ensure that the worms will grow and reproduce under control conditions. In this way it is ensured that the test animals are exposed through the water and sediment as well as by their food.
11. The preferred endpoint of this type of study is the EC_x (e.g. EC_{50} , EC_{25} , and EC_{10} ; effect concentration, affecting x % of the test organisms) for reproduction and biomass, respectively, compared to the control. It should however be noted, that considering the high uncertainty of low EC_x (e.g. EC_{10} , EC_{25}) with extremely high 95 %-confidence limits (e.g. (15)) and the

▼ M6

statistical power calculated during hypothesis testing, the EC₅₀ is regarded the most robust endpoint. In addition, the No Observed Effect Concentration (NOEC), and the Lowest Observed Effect Concentration (LOEC) may be calculated for biomass, and reproduction, if the test design and the data support these calculations (see paragraphs 34 to 38). The purpose of the study, EC_x or NOEC derivation, will determine the test design.

REFERENCE TESTING

12. Performance of the control organisms is expected to demonstrate sufficiently the ability of a laboratory to perform the test, and if historical data are available, the repeatability of the test. In addition, reference toxicity tests may be conducted in regular intervals using a reference toxicant to assess the sensitivity of the test organisms. 96 h reference toxicity tests in water only may satisfactorily demonstrate the sensitivity and condition of the test animals (4)(7). Information on the toxicity of pentachlorophenol (PCP) in complete tests (28 d exposure to spiked sediment) is included in Appendix 6, and in the report on the ring test of the Test Method (13). The acute, water-only toxicity of PCP is described e.g. in (16). This information can be used for comparison of test organism sensitivity in reference tests with PCP as reference toxicant. Potassium chloride (KCl) or copper sulphate (CuSO₄) have been recommended as reference toxicants with *L. variegatus* (4)(7). To date, establishment of quality criteria based on toxicity data for KCl is difficult due to lack of literature data for *L. variegatus*. Information on the toxicity of copper towards *L. variegatus* can be found in (17) to (21).

VALIDITY OF THE TEST

13. For a test to be valid, the following requirements should be fulfilled:
- A ring-test (13) has shown that for *Lumbricus variegatus*, the average number of living worms per replicate in the controls should have increased by a factor of at least 1,8 at the end of exposure compared to the number of worms per replicate at the start of exposure.
 - The pH of the overlying water should be between 6 and 9 throughout the test.
 - The oxygen concentration in the overlying water should not be below 30 % of air saturation value (ASV) at test temperature during the test.

DESCRIPTION OF THE TEST METHOD

Test system

14. Static systems without renewal of the overlying water are recommended. If the sediment-to-water ratio (see paragraph 15) is appropriate, gentle aeration will normally suffice to keep the water quality at acceptable levels for the test organisms (e.g. maximise dissolved oxygen levels, minimise build-up of excretory products). Semi-static or flow-through systems with intermittent or continuous renewal of overlying water should only be used in exceptional cases, since regular renewal of overlying water is expected to affect chemical equilibrium (e.g. losses of test chemical from the test system).

Test vessels and apparatus

15. The exposure should be conducted in glass beakers of e.g. 250 ml measuring 6 cm in diameter. Other suitable glass vessels may be used, but they should guarantee a suitable depth of overlying water and sediment. Each vessel should receive a layer of approximately 1,5 – 3 cm of formulated sediment. The ratio of the depth of the sediment layer to the

▼ M6

depth of the overlying water should be 1:4. The vessels should be of suitable capacity in compliance with the loading rate, i.e. the number of test worms added per weight unit of sediment, (see also paragraph 39).

16. Test vessels and other apparatus that will come into contact with the test chemical should be made entirely of glass or other chemically inert material. Care should be taken to avoid the use of materials, for all parts of the equipment that can dissolve, absorb test chemicals or leach other chemicals and have an adverse effect on the test animals. Polytetrafluoroethylene (PTFE), stainless steel and/or glass should be used for any equipment having contact with the test media. For organic chemicals known to adsorb to glass, silanised glass may be required. In these situations the equipment will have to be discarded after use.

Test species

17. The test species used in this type of study is the freshwater oligochaete *Lumbriculus variegatus* (Müller). This species is tolerant to a wide range of sediment types, and is widely used for sediment toxicity and bioaccumulation testing [e.g. (3), (5), (7), (9), (13), (15), (16), (22), (23), (24), (25), (26), (27), (28), (29), (30), (31), (32), (33), (34), (35)]. The origin of the test animals, the confirmation of species identity (e.g. (36)) as well as the culture conditions should be reported. Identification of species is not required prior to every test if the organisms come from an in-house culture.

Culturing of the test organisms

18. In order to have a sufficient number of worms for conducting sediment toxicity tests, it is useful to keep the worms in permanent laboratory culture. Guidance for laboratory culture methods for *Lumbriculus variegatus*, and sources of starter cultures are given in Appendix 5. For details on culturing this species see references (3), (7), (27).
19. To ensure that the tests are performed with animals of the same species, the establishment of single species cultures is strongly recommended. Ensure that the cultures and especially the worms used in the tests are free from observable diseases and abnormalities.

Water

20. Reconstituted water according to Chapter C.1 of this Annex (37) is recommended for use as overlying water in the tests; it can also be used for the laboratory cultures of the worms (see Appendix 2 for preparation). If required, natural water may be used. The chosen water must be of a quality that will allow the growth and reproduction of the test species for the duration of the acclimation and test periods without showing any abnormal appearance or behaviour. *Lumbriculus variegatus* has been demonstrated to survive, grow, and reproduce in this type of water (30), and maximum standardisation of test and culture conditions is provided. If a reconstituted water is used, its composition should be reported, and the water should be characterised prior to use at least by pH, oxygen content, and hardness (expressed as mg CaCO₃/l). Analysis of the water for micropollutants prior to use might provide useful information (see, e.g., Appendix 3).
21. The pH of the overlying water should be in the range of 6,0 to 9,0 (see paragraph 13). If increased ammonia development is expected, it is considered useful to keep the pH between 6,0 and 8,0. For testing of e.g. weak organic acids, it is advisable to adjust the pH by buffering the water to be used in the test, as described e.g. by (16). The total hardness of the water to be used in the test should be between 90 and 300 mg CaCO₃ per liter for natural water. Appendix 3 summarises additional criteria for acceptable dilution water according to OECD Guideline No. 210 (38).

▼ **M6****Sediment**

22. Since uncontaminated natural sediments from a particular source may not be available throughout the year, and indigenous organisms as well as the presence of micropollutants can influence the test, a formulated sediment (also called reconstituted, artificial or synthetic sediment) should preferably be used. Use of a formulated sediment minimises variability of test conditions as well as introduction of indigenous fauna. The following formulated sediment is based on the artificial sediment according to (6), (39) and (40). It is recommended for use in this type of test ((6), (10), (30), (41), (42), (43)):
- (a) 4-5 % (dry weight) sphagnum peat; it is important to use peat in powder form, degree of decomposition: 'medium', finely ground (particle size \leq 0,5 mm), and only air-dried.
 - (b) 20 ± 1 % (dry weight) kaolin clay (kaolinite content preferably above 30 %).
 - (c) 75-76 % (dry weight) quartz sand (fine sand, grain size: \leq 2 mm, but $>$ 50 % of the particles should be in the range of 50-200 μ m).
 - (d) Deionised water, 30–50 % of sediment dry weight, in addition to the dry sediment components.
 - (e) Calcium carbonate of chemically pure quality (CaCO_3) is added to adjust the pH of the final mixture of the sediment.
 - (f) The total organic carbon content (TOC) of the final mixture should be 2 % (\pm 0,5 %) of sediment dry weight and should be adjusted by the use of appropriate amounts of peat and sand, according to (a) and (c).
 - (g) Food, e.g. powdered leaves of Stinging Nettle (*Urtica* sp., in accordance with pharmacy standards, for human consumption), or a mixture of powdered leaves of *Urtica* sp. with alpha-cellulose (1:1), at 0,4 - 0,5 % of sediment d.w., in addition to the dry sediment components; for details see Appendix 4.
23. The source of peat, kaolin clay, food material, and sand should be known. In addition to item g), Chapter C.27 of this Annex (6) lists alternative plant materials to be used as a source of nutrition: dehydrated leaves of mulberry (*Morus alba*), white clover (*Trifolium repens*), spinach (*Spinacia oleracea*), or cereal grass.
24. The chosen food source should be added prior to or during spiking the sediment with the test chemical. The chosen food source should allow for at least acceptable reproduction in the controls. Analysis of the artificial sediment or its constituents for micro-pollutants prior to use might provide useful information. An example for the preparation of the formulated sediment is described in Appendix 4. Mixing of dry constituents is also acceptable if it is demonstrated that after addition of overlying water a separation of sediment constituents (e.g. floating of peat particles) does not occur, and that the peat or the sediment is sufficiently conditioned (see also paragraph 25 and Appendix 4). The artificial sediment should be characterised at least by origin of the constituents, grain size distribution (percent sand, silt, and clay), total organic carbon content (TOC), water content, and pH. Measurement of redox potential is optional.
25. If required, e.g. for specific testing purposes, natural sediments from unpolluted sites may also serve as test and/or culture sediment (3). However,

▼ M6

if natural sediment is used, it should be characterised at least by origin (collection site), pH and ammonia of the pore water, total organic carbon content (TOC) and nitrogen content, particle size distribution (percent sand, silt, and clay), and percent water content (7), and it should be free from any contamination and other organisms that might compete with, or prey on the test organisms. Measurement of redox potential and cation exchange capacity is optional. It is also recommended that, before it is spiked with the test chemical, the natural sediment be conditioned for seven days under the same conditions which prevail in the subsequent test. At the end of this conditioning period, the overlying water should be removed and discarded.

26. The sediment to be used must be of a quality that will allow the survival and reproduction of the control organisms for the duration of the exposure period without showing any abnormal appearance or behaviour. The control worms should burrow in the sediment, and they should ingest the sediment. Reproduction in the controls should at least be according to the validity criterion as described in paragraph 13. The presence or absence of fecal pellets on the sediment surface, which indicate sediment ingestion by the worms, should be recorded and can be helpful for the interpretation of the test results with respect to exposure pathways. Additional information on sediment ingestion can be obtained by using methods described in (24), (25), (44), and (45), which specify sediment ingestion or particle selection in the test organisms.
27. Manipulation procedures for natural sediments prior to use in the laboratory are described in (3), (7), and (12). The preparation and storage of the artificial sediment recommended to be used in the *Lumbriculus* test is described in Appendix 4.

Application of the test chemical

28. The test chemical is to be spiked to the sediment. As most test chemicals are expected to have low water solubility, they should be dissolved in a suitable organic solvent (e.g. acetone, n-hexane, cyclohexane) at a volume as small as possible in order to prepare the stock solution. The stock solution should be diluted with the same solvent to prepare the test solutions. Toxicity and volatility of the solvent, and the solubility of the test chemical in the chosen solvent should be the main criteria for the selection of a suitable solubilising agent. For each concentration level the same volume of the corresponding solution should be used. The sediment should be spiked in bulk for each concentration level in order to minimise between-replicate variability of the test chemical concentration. Each of the test solutions is then mixed with quartz sand as described in paragraph 22 (e.g. 10 g of quartz sand per test vessel). In order to soak the quartz sand completely, a volume of 0,20 - 0,25 ml per g of sand has been found sufficient. Thereafter, the solvent must be evaporated to dryness. In order to minimise losses of the test chemical through co-evaporation (e.g. depending on the chemical's vapour pressure), the coated sand should be used immediately after drying. The dry sand is mixed with the suitable amount of formulated sediment of the corresponding concentration level. The amount of sand provided by the test-chemical-and-sand mixture has to be taken into account when preparing the sediment (i.e. the sediment should thus be prepared with less sand). The major advantage of this procedure is that virtually no solvent is introduced to the sediment (7). Alternatively, e.g. for field sediment, the test chemical may be added by spiking a dried and finely ground portion of the sediment as described above for the quartz sand, or by stirring the test chemical into the wet sediment, with subsequent evaporating of any solubilising agent used. Care should be taken to ensure that the test chemical added to sediment is thoroughly and evenly distributed within the sediment. If necessary, subsamples may be analysed to confirm the target concentrations in the sediment, and to determine degree of homogeneity. It may also be useful to analyse subsamples of the test solutions to confirm the target concentrations in the sediment. Since a solvent is used for coating the test chemical on the quartz sand, a solvent control should be employed which is prepared with the same amount of the solvent as the test sediments. The method used for

▼ M6

spiking, and the reasons for choosing a specific spiking procedure other than described above should be reported. The method of spiking may be adapted to the test chemical's physical-chemical properties, e.g. to avoid losses due to volatilisation during spiking or equilibration. Additional guidance on spiking procedures is given in Environment Canada (1995) (46).

29. Once the spiked sediment has been prepared, distributed to the replicate test vessels, and topped with the test water, it is desirable to allow partitioning of the test chemical from the sediment to the aqueous phase (e.g. (3)(7)(9)). This should preferably be done under the conditions of temperature and aeration used in the test. Appropriate equilibration time is sediment and chemicals specific, and can be in the order of hours to days and in rare cases up to several weeks (4-5 weeks) (e.g. (27)(47)). In this test, equilibrium is not awaited but an equilibration period of 48 hours to 7 days is recommended. Thus, time for degradation of the test chemical will be minimised. Depending on the purpose of the study, e.g., when environmental conditions are to be mimicked, the spiked sediment may be equilibrated or aged for a longer period.
30. At the end of this equilibration period, samples should be taken at least of the overlying water and the bulk sediment, at least at the highest concentration and a lower one, for analysis of the test chemical concentration. These analytical determinations of the test chemical should allow for calculation of mass balance and expression of results based on measured initial concentrations. In general, sampling disturbs or destroys the sediment water system. Therefore it is usually not possible to use the same replicates for sampling of sediment and worms. Additional 'analytical' vessels of appropriate dimensions have to be set up, which are treated in the same way (including the presence of test organisms) but not used for biological observations. The vessel dimensions should be selected to provide the sample amounts required by the analytical method. Details of sampling are described in paragraph 53.

PERFORMANCE OF THE TEST

Preliminary test

31. If no information is available on the toxicity of the test chemical towards *Lumbriculus variegatus*, it may be useful to conduct a preliminary experiment in order to determine the range of concentrations to be tested in the definitive test, and to optimise the test conditions of the definitive test. For this purpose a series of widely spaced concentrations of the test chemical are used. The worms are exposed to each concentration of the test chemical for a period (e.g. 28 d as in the definitive test) which allows estimation of appropriate test concentrations; no replicates are required. The behaviour of the worms, for example sediment avoidance, which may be caused by the test chemical and/or by the sediment, should be observed and recorded during a preliminary test. Concentrations higher than 1 000 mg/kg sediment dry weight should not be tested in the preliminary test.

Definitive test

32. In the definitive test, at least five concentrations should be used and selected e.g. based on the result of the preliminary range-finding test (paragraph 31), and as described in paragraphs 35, 36, 37 and 38.

▼ M6

33. A control (for replication see paragraphs 36, 37 and 38) containing all constituents, except for the test chemical, is run in addition to the test series. If any solubilising agent is used for application of the test chemical, it should have no significant effect on the test organisms as revealed by an additional solvent-only control.

Test design

34. The test design relates to the selection of the number and spacing of the test concentrations, the number of vessels at each concentration and the number of worms added per vessel. Designs for EC_x estimation, for estimation of NOEC, and for conducting a limit test are described in paragraphs 35, 36, 37 and 38.
35. The effect concentration (e.g. EC₅₀, EC₂₅, EC₁₀) and the concentration range, over which the effect of the test chemical is of interest, should be bracketed by the concentrations included in the test. Extrapolating much below the lowest concentration affecting the test organisms or above the highest tested concentration should be avoided. If — in exceptional cases — such an extrapolation is done, a full explanation must be given in the report.
36. If the EC_x is to be estimated, at least five concentrations and a minimum of three replicates for each concentration should be tested; six replicates are recommended for the control or — if used — the solvent control in order to improve the estimation of control variability. In any case, it is advisable that sufficient test concentrations are used to allow a good model estimation. The factor between concentrations should not be greater than two (an exception can be made in cases when the concentration response curve has a shallow slope). The number of replicates at each treatment can be reduced if the number of test concentrations with responses in the range of 5 – 95 % are increased. Increasing the number of replicates or reducing the size of the test concentration intervals tends to lead to narrower confidence intervals for the test.
37. If the LOEC/NOEC values are to be estimated, at least five test concentrations with at least four replicates (six replicates are recommended for the control or — if used — the solvent control in order to improve the estimation of control variability) should be used, and the factor between concentrations should not be greater than two. Some information on the statistical power found during hypothesis testing in the ring test of the test method is given in Appendix 6.
38. A limit test may be performed (using one test concentration and controls) if no effects are expected up to 1 000 mg/kg sediment d.w. (e.g. from a preliminary range-finding test), or if testing at a single concentration will be adequate to confirm a NOEC value of interest. In the latter case, a detailed rationale for selection of limit concentration should be included in the test report. The purpose of the limit test is to perform a test at a concentration sufficiently high to enable decision makers to exclude possible toxic effects of the chemical, and the limit is set at a concentration which is not expected to appear in any situation. 1 000 mg/kg (dry weight) is recommended. Usually, at least six replicates for both the treatment and controls are necessary. Some information on the statistical power found during hypothesis testing in the ring test of the test method is given in Appendix 6.

Exposure conditions*Test organisms*

39. The test is conducted with at least 10 worms for each replicate used for determination of biological parameters. This number of worms corresponds to approximately 50 - 100 mg of wet biomass. Assuming a dry content of 17,1 % (48), this results in approximately 9 - 17 mg of dry biomass per vessel. U.S. EPA (2000 (7)) recommends to use a loading rate not exceeding 1: 50 (dry biomass: TOC). For the formulated sediment described in paragraph 22,

▼ M6

this corresponds to approximately 43 g sediment (dry weight) per 10 worms at a TOC content of 2,0 % of dry sediment. In cases where more than 10 worms are used per vessel, the amount of sediment and overlying water should be adjusted accordingly.

40. The worms used in a test should all come from the same source, and should be animals of similar physiological state (see Appendix 5). Worms of similar size should be selected (see paragraph 39). It is recommended that a sub-sample of the batch or stock of worms is weighed before the test in order to estimate the mean weight.
41. The worms to be used in a test are removed from the culture (see Appendix 5 for details). Large (adult) animals that do not show signs of recent fragmentation are transferred to glass dishes (e.g. petri dishes) containing clean water. They are subsequently synchronised as described in Appendix 5. After regenerating for a period of 10 to 14 d, intact complete worms of similar size, which are actively swimming or crawling after a gentle mechanical stimulus, should be used for the test. If the test conditions differ from the culture conditions (e.g. in temperature, light regime, and overlying water), an acclimation phase of e.g. 24 h at temperature, light regime, and using the same overlying water as in the test should be sufficient to adapt the worms to the test conditions. The adapted oligochaetes should be allocated randomly to the test vessels.

Feeding

42. Since food is added to the sediment prior to (or during) application of the test chemical, the worms are not fed additionally during the test.

Light and temperature

43. The photoperiod in the culture and the test is usually 16 hours (3), (7). Light intensity should be kept low (e.g. 100-500 lx) to imitate natural conditions at the sediment surface, and measured at least once during the exposure period. The temperature should be $20\text{ °C} \pm 2\text{ °C}$ throughout the test. On one given measuring date the difference of temperature between test vessels should not be higher than $\pm 1\text{ °C}$. The test vessels should be placed in the test incubator or the test area in a randomised way, e.g. in order to minimise bias of reproduction due to vessel location.

Aeration

44. The overlying water of the test vessels should be gently aerated (e.g. 2 - 4 bubbles per second) via a pasteur pipette positioned approx. 2 cm above the sediment surface so as to minimise perturbation of the sediment. Care should be taken that the dissolved oxygen concentration does not fall below 30 % of air saturation value (ASV). Air supply should be controlled and — if necessary — adjusted at least once daily on workdays.

Water quality measurements

45. The following water quality parameters should be measured in the overlying water:

Temperature:	at least in one test vessel of each concentration level and one test vessel of the controls once per week and at the start and the end of the exposure period; if possible, temperature in the surrounding medium (ambient air or water bath) may be recorded additionally e.g. at hourly intervals;
--------------	--

▼ **M6**

Dissolved oxygen content:	at least in one test vessel of each concentration level and one test vessel of the controls once per week and at the start and the end of the exposure period; expressed as mg/l and % ASV (air saturation value);
Air supply:	should be controlled at least once daily on workdays and — if necessary — adjusted;
pH:	at least in one test vessel of each concentration level and one test vessel of the controls once per week and at the start and the end of the exposure period;
Total water hardness:	at least in one replicate of the controls and one test vessel at the highest concentration at the start and the end of the exposure period; expressed as mg/l CaCO ₃ ;
Total ammonia content:	at least in one replicate of the controls and in one test vessel of each concentration level at the start of the exposure period, and subsequently 3 × per week; expressed as mg/l NH ₄ ⁺ or NH ₃ or total ammonia-N.

If measurement of water quality parameters requires removal of significant water samples from the vessels, it may be advisable to set up separate vessels for water quality measurements so as not to alter the water-to-sediment volume ratio.

Biological observations

46. During the exposure, the test vessels should be observed in order to assess visually any behavioural differences in the worms (e.g. sediment avoidance, fecal pellets visible on the sediment surface) compared with the controls. Observations should be recorded.
47. At the end of the test, each replicate is examined (additional vessels designated for chemical analyses may be excluded from examination). An appropriate method should be used to recover all worms from the test vessel. Care should be taken that all worms are recovered uninjured. One possible method is sieving the worms from the sediment. A stainless steel mesh of appropriate mesh size can be used. Most of the overlying water is carefully decanted, and the remaining sediment and water is agitated to result in a slurry, which can be passed through the sieve. Using a 500 µm mesh, most of the sediment particles will pass the sieve very quickly; however, sieving should be done quickly, in order to prevent the worms from crawling into or through the mesh. Using a 250 µm mesh will prevent the worms from crawling into or through the mesh; however, care should be taken that as little as possible of the sediment particles is retained on the mesh. The sieved slurry of each replicate vessel may be passed through the sieve a second time in order to ensure that all worms are recovered. An alternative method could be warming of the sediment by placing the test vessels in a water bath at 50 – 60 °C; the worms will leave the sediment and can be collected from the sediment surface by use of a fire-polished wide-mouth pipette. Another alternative method could be to produce a sediment slurry and pour this slurry onto a shallow pan of suitable size. From the shallow layer of slurry the worms can be picked up by a steel needle or watchmakers' tweezers (to be used rather like a fork than forceps to avoid injuring the worms) and transferred to clean water. After separating the worms from the sediment slurry, these are rinsed in test medium and counted.
48. Independently of the method used, laboratories should demonstrate that their personnel are able to recover an average of at least 90 % of the organisms

▼ M6

from whole sediment. For example, a certain number of test organisms could be added to control sediment or test sediments, and recovery could be determined after 1 h (7).

49. The total number of living and dead individuals per replicate should be recorded and assessed. The following groups of worms are considered to be dead:

- a) there is no reaction after a gentle mechanical stimulus
- b) there are signs of decomposition (in combination with 'a')
- c) number of missing worms

Additionally, the living worms can be assigned to one of three groups:

- a) large complete worms (adults) without regenerated body regions
- b) complete worms with regenerated, lighter-coloured body regions (i.e., with new posterior part, with new anterior part, or with both new posterior and anterior parts)
- c) incomplete worms (i.e., recently fragmented worms with non-regenerated body regions)

These additional observations are not mandatory, but can be used for additional interpretation of the biological results (for example, a high number of worms assigned to group c may indicate a delay of reproduction or regeneration in a given treatment). Additionally, if any differences in appearance (e.g. lesions of the integument, oedematous body sections) are observed between treated and control worms, these should be recorded.

- 50. Immediately after counting/assessment, the living worms found in each replicate are transferred to dried, pre-weighed and labelled weigh pans (one per replicate), and killed using a drop of ethanol per weigh pan. The weigh pans are placed in a drying oven at 100 ± 5 °C to dry overnight, after which they are weighed after cooling in a desiccator, and worm dry weight is determined (preferably in g, at least 4 post-decimal digits).
- 51. In addition to the total dry weight, the ash-free dry weight may be determined as described in (49) in order to account for inorganic components originating from ingested sediment present in the alimentary tract of the worms.
- 52. The biomass is determined as total biomass per replicate including adult and young worms. Dead worms should not be taken into account for the determination of biomass per replicate.

Verification of test chemical concentrations

Sampling

- 53. Samples for chemical analysis of the test chemical should be taken at least of the highest concentration and a lower one, at least at the end of the equilibration phase (before adding the test organisms), and at the end of the test. At least the bulk sediment and the overlying water should be sampled for analysis. At least two samples should be taken per matrix and treatment on each sampling date. One of the duplicate samples may be stored as a reserve (to be analysed e.g. in the event that initial analysis falls outside the ± 20 % range from the nominal concentration). In case of

▼M6

specific chemical properties, e.g. if rapid degradation of the test chemical is expected, the analytical schedule may be refined (e.g. more frequent sampling, analysis of more concentration levels) on the basis of expert judgment. Samples may then be taken on intermediate sampling dates (e.g. on day seven after start of exposure).

54. The overlying water should be sampled by carefully decanting or siphoning off the overlying water so as to minimise perturbation of the sediment. The volume of the samples should be recorded.
55. After the overlying water has been removed, the sediment should be homogenised and transferred to a suitable container. The weight of the wet sediment sample is recorded.
56. If analysis of the test chemical in the pore water is required additionally, the homogenised and weighed sediment samples should be centrifuged to obtain the pore water. For example, approximately 200 ml of wet sediment can be filled into 250 ml centrifugation beakers. Thereafter the samples should be centrifuged without filtration to isolate the porewater, e.g. at $10\,000 \pm 600 \times g$ for 30 - 60 min at a temperature not exceeding the temperature used in the test. After centrifugation, the supernatant is decanted or pipetted taking care that no sediment particles are introduced, and the volume is recorded. The weight of the remaining sediment pellet is recorded. It may facilitate the estimation of the mass balance or recovery of the test chemical in the water-sediment system, if the sediment dry weight is determined at each sampling date. In some cases it might not be possible to analyse concentrations in the pore water as the sample size is too small.
57. Failing immediate analysis, all samples should be stored by an appropriate method, e.g. under the storage conditions recommended for minimum degradation of the particular test chemical (e.g., environmental samples are commonly stored at -18 °C in the dark). Obtain information on the proper storage conditions for the particular test chemical — for example, duration and temperature of storage, extraction procedures, etc. — before beginning the study.

Analytical method

58. Since the whole procedure is governed essentially by the accuracy, precision and sensitivity of the analytical method used for the test chemical, check experimentally that the precision and reproducibility of the chemical analysis, as well as the recovery of the test chemical from water and sediment samples are satisfactory for the particular method at least at the lowest and highest test concentrations. Also, check that the test chemical is not detectable in the control chambers in concentrations higher than the limit of quantification. If necessary, correct the nominal concentrations for the recoveries of quality control spikes (e.g. where recovery is outside 80 - 120 % of spiked amount). Handle all samples throughout the test in such a manner so as to minimise contamination and loss (e.g. resulting from adsorption of the test chemical on the sampling device).
59. The recovery of test chemical, the limit of quantification, and the limit of detection in sediment and water should be recorded and reported.

DATA AND REPORTING**Treatment of results**

60. The main mandatory response variables of the test to be evaluated statistically are the biomass and the total number of worms per replicate. Optionally, reproduction (as increase of worm numbers) and growth (as increase of dry biomass) could be also evaluated. In this case, an estimate of the dry weight of the worms at start of exposure should be obtained e.g. by measurement of the dry weight of a representative sub-sample of the batch of synchronised worms to be used for the test.

▼ M6

61. Although mortality is not an endpoint of this test, mortalities should be evaluated as far as possible. In order to estimate mortalities, the number of worms that do not react to a gentle mechanical stimulus or showed signs of decomposition, and the missing worms should be considered dead. Mortalities should at least be recorded and considered when interpreting the test results.
62. Effect concentrations should be expressed in mg/kg sediment dry weight. If the recovery of test chemical measured in the sediment, or in sediment and overlying water at start of exposure, is between 80 and 120 % of the nominal concentrations, the effect concentrations (EC_x , NOEC, LOEC) may be expressed based on nominal concentrations. If recovery deviates from the nominal concentrations by more than ± 20 % of the nominal concentrations, the effect concentrations (EC_x , NOEC, LOEC) should be based on the initially measured concentrations at the beginning of the exposure, e.g. taking into account the mass balance of the test chemical in the test system (see paragraph 30). In these cases, additional information can be obtained from analysis of stock and/or application solutions in order to confirm that the test sediments were prepared correctly.

 EC_x

63. EC_x -values for the parameters described in paragraph 60 are calculated using appropriate statistical methods (e.g. probit analysis, logistic or Weibull function, trimmed Spearman-Kärber method, or simple interpolation). Guidance on statistical evaluation is given in (15) and (50). An EC_x is obtained by inserting a value corresponding to x % of the control mean into the equation found. To compute the EC_{50} or any other EC_x , the per-treatment means (\bar{X}) should be subjected to regression analysis.

NOEC/LOEC

64. If a statistical analysis is intended to determine the NOEC/LOEC, per-vessel statistics (individual vessels are considered replicates) are necessary. Appropriate statistical methods should be used. In general, adverse effects of the test item compared to the control are investigated using one-tailed (smaller) hypothesis testing at $p \leq 0,05$. Examples are given in the following paragraphs. Guidance on selection of appropriate statistical methods is given in (15) and (50).
65. Normal distribution of data can be tested e.g. with the Kolmogorov-Smirnov goodness-of-fit test, the Range-to-standard-deviation ratio test (R/s-test) or the Shapiro-Wilk test, (two-sided, $p \leq 0,05$). Cochran's test, Levene test or Bartlett's test, (two-sided, $p \leq 0,05$) may be used to test variance homogeneity. If the prerequisites of parametric test procedures (normality, variance homogeneity) are fulfilled, One-way Analysis of Variance (ANOVA) and subsequent multi-comparison tests can be performed. Pairwise comparisons (e.g. Dunnett's t-test) or step-down trend tests (e.g. Williams' test) can be used to calculate whether there are significant differences ($p \leq 0,05$) between the controls and the various test item concentrations. Otherwise, non-parametric methods (e.g. Bonferroni-U-test according to Holm or Jonckheere-Terpstra trend test) should be used to determine the NOEC and the LOEC.

Limit test

66. If a limit test (comparison of control and one treatment only) has been performed and the prerequisites of parametric test procedures (normality, homogeneity) are fulfilled, metric responses (total worm number, and biomass as worm dry weight) can be evaluated by the Student test (t-test). The unequal-variance t-test (Welch t-test) or a non parametric test, such as the Mann-Whitney-U-test may be used, if these requirements are not fulfilled. Some information on the statistical power found during hypothesis testing in the ring test of the method is given in Appendix 6.

▼ M6

67. To determine significant differences between the controls (control and solvent control), the replicates of each control can be tested as described for the limit test. If these tests do not detect significant differences, all control and solvent control replicates may be pooled. Otherwise all treatments should be compared with the solvent control.

Interpretation of results

68. The results should be interpreted with caution if there were deviations from this test method, and where measured concentrations of test concentrations occur at levels close to the detection limit of the analytical method used. Any deviations from this test method must be noted.

Test report

69. The test report should include at least the following information:

— *Test chemical:*

- chemical identification data (common name, chemical name, structural formula, CAS number, etc.) including purity and analytical method for quantification of test chemical; source of the test chemical, identity and concentration of any solvent used.
- any information available on the physical nature and physical-chemical properties as obtained prior to start of the test, (e.g. water solubility, vapour pressure, partition coefficient in soil (or in sediment if available), log K_{ow} , stability in water, etc.);

— *Test species:*

- scientific name, source, any pre-treatment, acclimation, culture conditions, etc..

— *Test conditions:*

- test procedure used (e.g. static, semi-static or flow-through);
- test design (e.g. number, material and size of test chambers, water volume per vessel, sediment mass and volume per vessel, (for flow-through or semi-static procedures: water volume replacement rate), any aeration used before and during the test, number of replicates, number of worms per replicate at start of exposure, number of test concentrations, length of conditioning, equilibration and exposure periods, sampling frequency);
- depth of sediment and overlying water;
- method of test chemical pre-treatment and spiking/application;
- the nominal test concentrations, details about the sampling for chemical analysis, and the analytical methods by which concentrations of the test chemical were obtained;
- sediment characteristics as described in paragraphs 24 - 25, and any other measurements made; preparation of formulated sediment;
- preparation of the test water (if reconstituted water is used) and characteristics (oxygen concentration, pH, conductivity, hardness, and any other measurements made) before the start of the test;
- detailed information on feeding including type of food, preparation, amount and feeding regimen;

▼ M6

- light intensity and photoperiod(s);
 - methods used for determination of all biological parameters (e.g. sampling, inspection, weighing of test organisms) and all abiotic parameters (e.g. water and sediment quality parameters);
 - volumes and/or weights of all samples for chemical analysis;
 - detailed information on the treatment of all samples for chemical analysis, including details of preparation, storage, spiking procedures, extraction, and analytical procedures (and precision) for the test chemical, and recoveries of the test chemical.
- *Results:*
- water quality within the test vessels (pH, temperature, dissolved oxygen concentration, hardness, ammonia concentrations, and any other measurements made);
 - total organic carbon content (TOC), dry weight to wet weight ratio, pH of the sediment, and any other measurements made;
 - total number, and if determined, number of complete and incomplete worms in each test chamber at the end of the test;
 - dry weight of the worms of each test chamber at the end of the test, and if measured, dry weight of a sub-sample of the worms at start of the test;
 - any observed abnormal behaviour in comparison to the controls (e.g., sediment avoidance, presence or absence of fecal pellets);
 - any observed mortalities;
 - estimates of toxic endpoints (e.g. EC_x, NOEC and/or LOEC), and the statistical methods used for their determination;
 - the nominal test concentrations, the measured test concentrations and the results of all analyses made to determine the concentration of the test chemical in the test vessels;
 - any deviations from the validity criteria.
- *Evaluation of results:*
- compliance of the results with the validity criteria as listed in paragraph 13;
 - discussion of the results, including any influence on the outcome of the test resulting from deviations from this test method.

LITERATURE

- (1) EC (2003). Technical Guidance Document in support of Commission Directive 93/67/EEC on Risk Assessment for new notified substances, Commission Regulation (EC) No 1488/94 on Risk Assessment for existing substances and Directive 98/8/EC of the European Parliament and of the Council concerning the placing of biocidal products on the market; Part I — IV. Office for Official Publications of the EC (European Commission), Luxembourg.
- (2) OECD (1992a). Report of the OECD workshop on effects assessment of chemicals in sediment. OECD Monographs No. 60. Organisation for Economic Co-operation and Development (OECD), Paris.

▼ M6

- (3) ASTM International (2000). Standard guide for the determination of the bioaccumulation of sediment-associated contaminants by benthic invertebrates, E 1688-00a. In ASTM International 2004 Annual Book of Standards. Volume 11.05. Biological Effects and Environmental Fate; Biotechnology; Pesticides. ASTM International, West Conshohocken, PA.
- (4) ASTM International (2002). Standard Test Method for Measuring the Toxicity of Sediment-Associated Contaminants with Freshwater Invertebrates, E1706-00. In ASTM International 2004 Annual Book of Standards. Volume 11.05. Biological Effects and Environmental Fate; Biotechnology; Pesticides. ASTM International, West Conshohocken, PA.
- (5) Phipps, G.L., Ankley, G.T., Benoit, D.A. and Mattson, V.R. (1993). Use of the aquatic Oligochaete *Lumbriculus variegatus* for assessing the toxicity and bioaccumulation of sediment-associated contaminants. Environ.Toxicol. Chem. 12, 269-279.
- (6) Chapter C.27 of this Annex, 'Sediment-water chironomid toxicity test using spiked sediment'.
- (7) U.S. EPA (2000). Methods for measuring the toxicity and bioaccumulation of sediment-associated contaminants with freshwater invertebrates. Second Edition. EPA 600/R-99/064, U.S. Environmental Protection Agency, Duluth, MN, March 2000.
- (8) Environment Canada (1997). Test for Growth and Survival in Sediment using Larvae of Freshwater Midges (*Chironomus tentans* or *Chironomus riparius*). Biological Test Method. Report SPE 1/RM/32. December 1997.
- (9) Hill, I.R., Matthiessen, P., Heimbach, F. (eds), 1993, Guidance document on Sediment Toxicity Tests and Bioassays for freshwater and Marine Environments, From the SETAC-Europe Workshop On Sediment Toxicity Assessment, 8-10 November 1993, Renesse (NL).
- (10) BBA (1995). Long-term toxicity test with *Chironomus riparius*: Development and validation of a new test system. Edited by M. Strelke and H.Köpp. Berlin 1995.
- (11) Riedhammer C. & B. Schwarz-Schulz (2001). The Newly Proposed EU Risk Assessment Concept for the Sediment Compartment. J. Soils Sediments 1(2), 105-110.
- (12) ASTM International (2004). Standard guide for collection, storage, characterisation, and manipulation of sediment for toxicological testing and for selection of samplers used to collect benthic invertebrates. American Society for Testing and Materials, E 1391-03.
- (13) Egeler, Ph., Meller, M., Schallnaß, H.J. & Gilberg, D. (2005). Validation of a sediment toxicity test with the endobenthic aquatic oligochaete *Lumbriculus variegatus* by an international ring test. In co-operation with R. Nagel and B. Karaoglan. Report to the Federal Environmental Agency (Umweltbundesamt Berlin), R&D No.: 202 67 429.
- (14) OECD (2000). Guidance Document on Aquatic Toxicity Testing of Difficult Substances and Mixtures. OECD Environment, Health and Safety Publications, Series on Testing and Assessment No. 23.
- (15) Environment Canada (2003). Guidance Document on Statistical Methods for Environmental Toxicity Tests; fifth draft, March 2003; Report EPS 1/RM/___
- (16) Nikkilä A., Halme A., Kukkonen J.V.K. (2003). Toxicokinetics, toxicity and lethal body residues of two chlorophenols in the oligochaete worm, *Lumbriculus variegatus*, in different sediments. Chemosphere 51: 35-46.
- (17) Baily H.C., & Liu D.H.W. (1980). *Lumbriculus variegatus*, a Benthic Oligochaete, as a Bioassay Organism. p. 205-215. In J.C. Eaton, P.R. Parrish, and A.C. Hendricks (eds). Aquatic Toxicology, ASTM STP 707. American Society for Testing and Materials.

▼M6

- (18) Chapman K. K., Benton M. J., Brinkhurst R. O. & Scheuerman P. R. (1999). Use of the aquatic oligochaetes *Lumbriculus variegatus* and *Tubifex tubifex* for assessing the toxicity of copper and cadmium in a spiked-artificial-sediment toxicity test. *Environmental Toxicology*. 14(2): 271-278.
- (19) Meyer J.S., Boese C.J. & Collyard S.A. (2002). Whole-body accumulation of copper predicts acute toxicity to an aquatic oligochaete (*Lumbriculus variegatus*) as pH and calcium are varied. *Comp. Biochem. Physiol. Part C* 133:99-109.
- (20) Schubauer-Berigan M.K., Dierkes J.R., Monson P.D. & Ankley G.T. (1993). pH-dependent toxicity of cadmium, copper, nickel, lead and zinc to *Ceriodaphnia dubia*, *Pimephales promelas*, *Hyalella azteca* and *Lumbriculus variegatus*. *Environ. Toxicol. Chem.* 12(7):1261-1266.
- (21) West, C.W., V.R. Mattson, E.N. Leonard, G.L. Phipps & G.T. Ankley (1993). Comparison of the relative sensitivity of three benthic invertebrates to copper-contaminated sediments from the Keweenaw Waterway. *Hydrobiol.* 262:57-63.
- (22) Ingersoll, C.G., Ankley, G.T., Benoit D.A., Brunson, E.L., Burton, G.A., Dwyer, F.J., Hoke, R.A., Landrum, P. F., Norberg-King, T. J. and Winger, P.V. (1995). Toxicity and bioaccumulation of sediment-associated contaminants using freshwater invertebrates: A review of methods and applications. *Environ. Toxicol. Chem.* 14, 1885-1894.
- (23) Kukkonen, J. and Landrum, P.F. (1994). Toxicokinetics and toxicity of sediment-associated Pyrene to *Lumbriculus variegatus* (Oligochaeta). *Environ. Toxicol. Chem.* 13, 1457-1468.
- (24) Leppänen, M.T. & Kukkonen, J.V.K. (1998a). Relationship between reproduction, sediment type and feeding activity of *Lumbriculus variegatus* (Müller): Implications for sediment toxicity testing. *Environ. Toxicol. Chem.* 17: 2196-2202.
- (25) Leppänen, M.T. & Kukkonen, J.V.K. (1998b). Factors affecting feeding rate, reproduction and growth of an oligochaete *Lumbriculus variegatus* (Müller). *Hydrobiologia* 377: 183-194.
- (26) Landrum, P.F., Gedeon, M.L., Burton, G.A., Greenberg, M.S., & Rowland, C.D. (2002). Biological Responses of *Lumbriculus variegatus* Exposed to Fluoranthene-Spiked Sediment. *Arch. Environ. Contam. Toxicol.* 42: 292-302.
- (27) Brunson, E.L., Canfield, T.J., Ingersoll, C.J. & Kemble, N.E. (1998). Assessing the bioaccumulation of contaminants from sediments of the Upper Mississippi river using field-collected oligochaetes and laboratory-exposed *Lumbriculus variegatus*. *Arch. Environ. Contam. Toxicol.* 35, 191-201.
- (28) Ingersoll, C.G., Brunson, E.L., Wang N., Dwyer, F.J., Ankley, G.T., Mount D.R., Huckins J., Petty. J. and Landrum, P. F. (2003). Uptake and depuration of non-ionic organic contaminants from sediment by the oligochaete, *Lumbriculus variegatus*. *Environmental Toxicology and Chemistry* 22, 872-885.
- (29) Rodriguez, P. & Reynoldson, T.B. (1999). Laboratory methods and criteria for sediment bioassessment. In: A. Mudroch, J.M. Azcue & P. Mudroch (eds.): *Manual of Bioassessment of aquatic sediment quality*. Lewis Publishers, Boca Raton, CRC Press LLC.
- (30) Liebig, M., Egeler, Ph. Oehlmann, J., & Knacker, Th. (2005). Bioaccumulation of ¹⁴C-17 α -ethinylestradiol by the oligochaete *Lumbriculus variegatus* in artificial sediment. *Chemosphere* 59, 271-280.
- (31) Brust, K., O. Licht, V. Hultsch, D. Jungmann & R. Nagel (2001). Effects of Terbutryn on Aufwuchs and *Lumbriculus variegatus* in Artificial Indoor Streams. *Environ. Toxicol. Chemistry*, Vol. 20, pp. 2000–2007.
- (32) Oetken, M., K.-U. Ludwichowski & R. Nagel (2000). Sediment tests with *Lumbriculus variegatus* and *Chironomus riparius* and 3,4-dichloroaniline (3,4-DCA) within the scope of EG-AltstoffV. By order of the Federal Environmental Agency (Umweltbundesamt Berlin), FKZ 360 12 001, March 2000.

▼ M6

- (33) Leppänen M.T. & Kukkonen J.V.K. (1998). Relative importance of ingested sediment and porewater as bioaccumulation routes for pyrene to oligochaete (*Lumbriculus variegatus*, Müller). *Environ. Sci. Toxicol.* 32, 1503-1508.
- (34) Dermott R. & Munawar M. (1992). A simple and sensitive assay for evaluation of sediment toxicity using *Lumbriculus variegatus* (Müller). *Hydrobiologia* 235/236: 407-414.
- (35) Drewes C.D. & Fournier C.R. (1990). Morphallaxis in an aquatic oligochaete, *Lumbriculus variegatus*: Reorganisation of escape reflexes in regenerating body fragments. *Develop. Biol.* 138: 94-103.
- (36) Brinkhurst, R.O. (1971). A guide for the identification of British aquatic oligochaeta. *Freshw. Biol. Assoc., Sci. Publ. No. 22.*
- (37) Chapter C.1 of this Annex, Fish, Acute Toxicity Test.
- (38) OECD (1992c). Guidelines for Testing of Chemicals No. 210. Fish, Early-life Stage Toxicity Test. OECD, Paris.
- (39) Egeler, Ph., Römbke, J., Meller, M., Knacker, Th., Franke, C., Studinger, G. & Nagel, R. (1997). Bioaccumulation of lindane and hexachlorobenzene by tubificid sludgeworms (Oligochaeta) under standardised laboratory conditions. *Chemosphere* 35, 835-852.
- (40) Meller, M., P. Egeler, J. Roembke, H. Schallnass, R. Nagel and B. Streit. (1998). Short-term Toxicity of Lindane, Hexachlorobenzene and Copper Sulphate on Tubificid Sludgeworms (Oligochaeta) in Artificial Media. *Ecotox. and Environ. Safety*, 39, 10-20.
- (41) Egeler, Ph., Römbke, J., Knacker, Th., Franke, C. & Studinger, G. (1999). Workshop on 'Bioaccumulation: Sediment test using benthic oligochaetes', 26.-27.4.1999, Hochheim/Main, Germany. Report on the R+D-project No. 298 67 419, Umweltbundesamt, Berlin.
- (42) Suedel, B.C. and Rodgers, J.H. (1993). Development of formulated reference sediments for freshwater and estuarine sediment testing. *Environ. Toxicol. Chem.* 13, 1163-1175.
- (43) Naylor, C. and C. Rodrigues. (1995). Development of a test method for *Chironomus riparius* using a formulated sediment. *Chemosphere* 31: 3291-3303.
- (44) Kaster, J.L., Klump, J.V., Meyer, J., Krezoski, J. & Smith, M.E. (1984). Comparison of defecation rates of *Limnodrilus hoffmeisteri* using two different methods. *Hydrobiologia* 11, 181-184.
- (45) Martinez-Madrid, M., Rodriguez, P., Perez-Iglesias, J.I. & Navarro, E. (1999). Sediment toxicity bioassays for assessment of contaminated sites in the Nervion river (Northern Spain). 2. *Tubifex tubifex* (Müller) reproduction sediment bioassay. *Ecotoxicology* 8, 111-124.
- (46) Environment Canada (1995). Guidance document on measurement of toxicity test precision using control sediments spiked with a reference toxicant. Environmental Protection Series Report EPS 1/RM/30.
- (47) Landrum, P.F. (1989). Bioavailability and toxicokinetics of polycyclic aromatic hydrocarbons sorbed to sediments for the amphipod *Pontoporeia hoyi*. *Environ. Sci. Technol.* 23, 588-595.
- (48) Brooke, L.T., Ankley, G.T., Call, D.J. & Cook, P.M. (1996). Gut content and clearance for three species of freshwater invertebrates. *Environ. Toxicol. Chem.* 15, 223-228.
- (49) Mount, D.R., Dawson, T.D. & Burkhard, L.P. (1999). Implications of gut purging for tissue residues determined in bioaccumulation testing of sediment with *Lumbriculus variegatus*. *Environ. Toxicol. Chem.* 18, 1244-1249.

▼ M6

- (50) OECD 2006. Current approaches in the statistical analysis of ecotoxicity data: A guidance to application. OECD Series on Testing and Assessment No. 54, OECD, Paris, France.
- (51) Liebig M., Meller M. & Egeler P. (2004). Sedimenttoxizitätstests mit aquatischen Oligochaeten — Einfluss verschiedener Futterquellen im künstlichen Sediment auf Reproduktion und Biomasse von *Lumbriculus variegatus*. Proceedings 5/2004: Statusseminar Sedimentkontakttests. March 24-25, 2004. BfG (Bundesanstalt für Gewässerkunde), Koblenz, Germany. pp. 107-119.

Additional literature on statistical procedures:

- Dunnett, C.W. (1955). A multiple comparison procedure for comparing several treatments with a control. Amer. Statist. Ass. J. 50, 1096-1121.
- Dunnett, C.W. (1964). New tables for multiple comparisons with a control. Biometrics 20, 482-491.
- Finney, D.J. (1971). Probit Analysis (3rd ed.), pp. 19-76. Cambridge Univ. Press.
- Finney, D.J. (1978). Statistical Method in Biological Assay. Charles Griffin & Company Ltd, London.
- Hamilton, M.A., R.C. Russo and R.V. Thurston. (1977). Trimmed Spearman-Kärber Method for estimating median lethal concentrations in toxicity bioassays. Environ. Sci. Technol. 11(7), 714-719; Correction: Environ. Sci. Technol. 12 (1998), 417.
- Holm, S. (1979). A simple sequentially rejective multiple test procedure. Scand. J. Statist. 6, 65-70.
- Sokal, R.R. and F.J. Rohlf. (1981) Biometry. The principles and practice of statistics in biological research. 2nd edition. W.H. Freeman and Company. New York.
- Miller, R.G., Jr. (1986). Beyond ANOVA, basics of applied statistics. John Wiley & Sons. New York.
- Shapiro S.S. & Wilk M.B (1965). An analysis of variance test for normality (complete samples). Biometrika 52: 591-611.
- Williams, D.A. (1971). A test for differences between treatment means when several dose levels are compared with a zero dose control. Biometrics 27, 103-117.
- Williams, D.A. (1972). The comparison of several dose levels with a zero dose control. Biometrics 28, 519-531.

▼ M6*Appendix 1***Definitions**

For the purpose of this test method the following definitions are used:

A **chemical** means a substance or a mixture.

The **conditioning period** is used to stabilise the microbial component of the sediment and to remove e.g. ammonia originating from sediment components; it takes place prior to spiking of the sediment with the test chemical. Usually, the overlying water is discarded after conditioning.

The **EC_x** is the concentration of the test chemical in the sediment that results in X % (e.g. 50 %) effect on a biological parameter within a stated exposure period.

The **equilibration period** is used to allow for distribution of the test chemical between the solid phase, the pore water and the overlying water; it takes place after spiking of the sediment with the test chemical and prior to addition of the test organisms.

The **exposure phase** is the time during which the test organisms are exposed to the test chemical.

Formulated sediment or reconstituted, artificial or synthetic sediment, is a mixture of materials used to mimic the physical components of a natural sediment.

The **Lowest Observed Effect Concentration (LOEC)** is the lowest tested concentration of a test chemical at which the chemical is observed to have a significant toxic effect (at $p \leq 0,05$) when compared with the control. However, all test concentrations above the LOEC must have an effect equal to or greater than those observed at the LOEC. If these two conditions cannot be satisfied, a full explanation must be given for how the LOEC (and hence the NOEC) has been selected.

The **No Observed Effect Concentration (NOEC)** is the test concentration immediately below the LOEC which, when compared with the control, has no statistically significant effect ($p \leq 0,05$), within a given exposure period.

The **octanol-water partitioning coefficient** (K_{ow} ; also sometimes expressed as P_{ow}) is the ratio of the solubility of a chemical in n-octanol and water at equilibrium and represents the lipophilicity of a chemical (Chapter A.24 of this Annex). The K_{ow} or its logarithm of K_{ow} ($\log K_{ow}$) is used as an indication of the potential of a chemical for bioaccumulation by aquatic organisms.

The **organic carbon-water partitioning coefficient** (K_{oc}) is the ratio of a chemical's concentration in/on the organic carbon fraction of a sediment and the chemical's concentration in water at equilibrium.

Overlying water is the water covering the sediment in the test vessel.

Pore water or interstitial water is the water occupying space between sediment or soil particles.

Spiked sediment is sediment to which test chemical has been added.

Test chemical means any substance or mixture tested using this test method.

▼M6*Appendix 2***Composition of the recommended reconstituted water**

(adopted from Chapter C.1 of this Annex (1))

(a) *Calcium chloride solution*

Dissolve 11,76 g $\text{CaCl}_2 \cdot 2\text{H}_2\text{O}$ in deionised water; make up to 1 l with deionised water

(b) *Magnesium sulphate solution*

Dissolve 4,93 g $\text{MgSO}_4 \cdot 7\text{H}_2\text{O}$ in deionised water; make up to 1 l with deionised water

(c) *Sodium bicarbonate solution*

Dissolve 2,59 g NaHCO_3 in deionised water; make up to 1 l with deionised water

(d) *Potassium chloride solution*

Dissolve 0,23 g KCl in deionised water; make up to 1 l with deionised water

All chemicals must be of analytical grade.

The conductivity of the distilled or deionised water should not exceed $10 \mu\text{Scm}^{-1}$.

25 ml each of solutions (a) to (d) are mixed and the total volume made up to 1 l with deionised water. The sum of the calcium and magnesium ions in these solutions is 2,5 mmol/l.

The proportion Ca:Mg ions is 4:1 and Na:K ions 10:1. The acid capacity $K_{\text{S4.3}}$ of this solution is 0,8 mmol/l.

Aerate the dilution water until oxygen saturation is achieved, then store it for approximately two days without further aeration before use.

REFERENCE

(1) Chapter C.1 of this Annex, Fish Acute Toxicity Test.

▼ M6*Appendix 3***Physical-chemical characteristics of an acceptable dilution water**

Component	Concentrations
Particulate matter	< 20 mg/l
Total organic carbon	< 2 µg/l
Unionised ammonia	< 1 µg/l
Residual chlorine	< 10 µg/l
Total organophosphorous pesticides	< 50 ng/l
Total organochlorine pesticides plus polychlorinated biphenyls	< 50 ng/l
Total organic chlorine	< 25 ng/l

Adopted from OECD (1992) (1)

REFERENCE

- (1) OECD (1992). Guidelines for Testing of Chemicals No. 210. Fish, Early-life Stage Toxicity Test. OECD, Paris.

▼ **M6***Appendix 4***Recommended artificial sediment — guidance on preparation and storage****Sediment constituents**

Constituent	Characteristics	% of sediment dry weight
Peat	Sphagnum moss peat, degree of decomposition: 'medium', air dried, no visible plant remains, finely ground (particle size $\leq 0,5$ mm)	$5 \pm 0,5$
Quartz sand	Grain size: ≤ 2 mm, but > 50 % of the particles should be in the range of 50-200 μm	75 - 76
Kaolinite clay	Kaolinite content ≥ 30 %	20 ± 1
Food source	e.g. Urtica powder (Folia urticae), leaves of Urtica dioica (stinging nettle), finely ground (particle size $\leq 0,5$ mm); in accordance with pharmacy standards, for human consumption; in addition to dry sediment	0,4 - 0,5 %
Organic carbon	Adjusted by addition of peat and sand	$2 \pm 0,5$
Calcium carbonate	CaCO_3 , pulverised, chemically pure, in addition to dry sediment	0,05 - 1
Deionised Water	Conductivity ≤ 10 $\mu\text{S/cm}$, in addition to dry sediment	30 - 50

Note: If elevated ammonia concentrations are expected, e.g. if the test chemical is known to inhibit nitrification, it may be useful to replace 50 % of the nitrogen-rich urtica powder by cellulose (e.g., α -Cellulose powder, chemically pure, particle size $\leq 0,5$ mm; (1) (2)).

Preparation

The peat is air dried and ground to a fine powder. A suspension of the required amount of peat powder in deionised water is prepared using a high-performance homogenising device. The pH of this suspension is adjusted to $5,5 \pm 0,5$ with CaCO_3 . The suspension is conditioned for at least two days with gentle stirring at 20 ± 2 °C, to stabilise pH and establish a stable microbial component. pH is measured again and should be $6,0 \pm 0,5$. Then the peat suspension is mixed with the other constituents (sand and kaolin clay) and deionised water to obtain an homogeneous sediment with a water content in a range of 30–50 per cent of dry weight of the sediment. The pH of the final mixture is measured again and is adjusted to 6,5 to 7,5 with CaCO_3 if necessary. However, if ammonia development is expected, it may be useful to keep the pH of the sediment below 7,0 (e.g. between 6,0 and 6,5). Samples of the sediment are taken to determine the dry weight and the organic carbon content. If ammonia development is expected, the formulated sediment may be conditioned for seven days under the same conditions which prevail in the subsequent test (e.g. sediment-water ratio 1 : 4, height of sediment layer as in test vessels) before it is spiked with the test chemical, i.e. it should be topped with water, which should be aerated. At the end of the conditioning period, the overlying water should be removed and discarded. Thereafter, the spiked quartz sand is mixed with the sediment for each treatment

▼ M6

level, the sediment is distributed to the replicate test vessels, and topped with the test water. The vessels are then incubated at the same conditions which prevail in the subsequent test. This is where the equilibration period starts. The overlying water should be aerated.

The chosen food source should be added prior to or during spiking the sediment with the test chemical. It can be mixed initially with the peat suspension (see above). However, excessive degradation of the food source prior to addition of the test organisms — e.g. in case of long equilibration period — can be avoided by keeping the time period between food addition and start of exposure as short as possible. In order to ensure that the food is spiked with the test chemical, the food source should be mixed with the sediment not later than on the day the test chemical is spiked to the sediment.

Storage

The dry constituents of the artificial sediment may be stored in a dry, cool place or at room temperature. The prepared sediment spiked with the test chemical should be used in the test immediately. Samples of spiked sediment may be stored under the conditions recommended for the particular test chemical until analysis.

REFERENCES

- (1) Egeler, Ph., Meller, M., Schallnaß, H.J. & Gilberg, D. (2005). Validation of a sediment toxicity test with the endobenthic aquatic oligochaete *Lumbriculus variegatus* by an international ring test. In co-operation with R. Nagel and B. Karaoglan. Report to the Federal Environmental Agency (Umweltbundesamt Berlin), R&D No.: 202 67 429.
- (2) Liebig M., Meller M. & Egeler P. (2004). Sedimenttoxizitätstests mit aquatischen Oligochaeten — Einfluss verschiedener Futterquellen im künstlichen Sediment auf Reproduktion und Biomasse von *Lumbriculus variegatus*. Proceedings 5/2004: Statusseminar Sedimentkontakttests. March 24-25, 2004. BfG (Bundesanstalt für Gewässerkunde), Koblenz, Germany. pp. 107-119.

▼ **M6***Appendix 5***Culture methods for *Lumbriculus variegatus***

Lumbriculus variegatus (MÜLLER), Lumbriculidae, Oligochaeta is an inhabitant of freshwater sediments and is widely used in ecotoxicological testing. It can easily be cultured under laboratory conditions. An outline of culture methods is given in the following.

Culture methods

Culture conditions for *Lumbriculus variegatus* are outlined in detail in Phipps et al. (1993) (1), Brunson et al. (1998) (2), ASTM (2000) (3), U.S. EPA (2000) (4). A short summary of these conditions is given below. A major advantage of *L. variegatus* is its quick reproduction, resulting in rapidly increasing biomass in laboratory cultured populations (e.g. (1), (3), (4), (5)).

The worms can be cultured in large aquaria (57 - 80 l) at 23 °C with a 16 L:8 D photoperiod (100 – 1 000 lx) using daily renewed natural water (45 - 50 l per aquarium). The substrate is prepared by cutting unbleached brown paper towels into strips, which may then be blended with culture water for a few seconds to result in small pieces of paper substrate. This substrate can then directly be used in the *Lumbriculus* culture aquaria by covering the bottom area of the tank, or be stored frozen in deionised water for later use. New substrate in the tank will generally last for approximately two months.

Each worm culture is started with 500 – 1 000 worms, and fed a 10 ml suspension containing 6 g of trout starter food 3 times per week under renewal or flow-through conditions. Static or semi-static cultures should receive lower feeding rates to prevent bacterial and fungal growth. .

Under these conditions the number of individuals in the culture generally doubles in approximately 10 to 14 d.

Alternatively *Lumbriculus variegatus* can also be cultured in a system consisting of a layer of quartz sand as used for the artificial sediment (1 - 2 cm depth), and reconstituted water. Glass or stainless steel containers with a height of 12 to 20 cm can be used as culture vessels. The water body should be gently aerated (e.g. 2 bubbles per second) via a pasteur pipette positioned approx. 2 cm above the sediment surface. To avoid accumulation e.g. of ammonia, the overlying water should be exchanged using a flow-through system, or, at least once a week, manually. The oligochaetes can be held at room temperature with a photo period of 16 hours light (intensity 100 – 1 000 lx) and 8 hours dark. In the semi-static culture (water renewal once per week), the worms are fed with TetraMin twice a week (e.g. 0,6 - 0,8 mg per cm² of sediment surface), which can be applied as a suspension of 50 mg TetraMin per ml de-ionized water.

Lumbriculus variegatus can be removed from the cultures e.g. by transferring substrate with a fine mesh net, or organisms using a fire polished wide mouth (approximately 5 mm diameter) glass pipette, to a separate beaker. If substrate is co-transferred to this beaker, the beaker containing worms and substrate is left overnight under flow-through conditions, which will remove the substrate from the beaker, while the worms remain at the bottom of the vessel. They can then be introduced to newly prepared culture tanks, or processed further for the test as outlined in (3) and (4), or in the following.

An issue to be regarded critically when using *L. variegatus* in sediment tests is its reproduction mode (architomy or morphallaxis, e.g. (6)). This asexual reproduction results in two fragments, which do not feed for a certain period until the head or tail part is regenerated (e.g., (7), (8)). This means that in *L. variegatus* exposure via ingestion of contaminated sediment does not take place continuously.

▼ M6

Therefore, a synchronisation should be performed to minimise uncontrolled reproduction and regeneration, and subsequent high variation in test results. Such variation can occur, when some individuals, which have fragmented and therefore do not feed for a certain time period, are less exposed to the test chemical than other individuals, which do not fragment during the test (9), (10), (11). 10 to 14 days before the start of exposure, the worms should be artificially fragmented (synchronisation). Large (adult) worms, which preferably do not show signs of recent morphallaxis should be selected for synchronisation. These worms can be placed onto a glass slide in a drop of culture water, and dissected in the median body region with a scalpel. Care should be taken that the posterior ends are of similar size. The posterior ends should then be left to regenerate new heads in a culture vessel containing the same substrate as used in the culture and reconstituted water until the start of exposure. Regeneration of new heads is indicated when the synchronised worms are burrowing in the substrate (presence of regenerated heads may be confirmed by inspecting a representative subsample under a binocular microscope). The test organisms are thereafter expected to be in a similar physiological state. This means, that when reproduction by morphallaxis occurs in synchronised worms during the test, virtually all animals are expected to be equally exposed to the spiked sediment. Feeding of the synchronised worms should be done once as soon as the worms are starting to burrow in the substrate, or 7 d after dissection. The feeding regimen should be comparable to the regular cultures, but it may be advisable to feed the synchronised worms with the same food source as is to be used in the test. The worms should be held at test temperature, at 20 ± 2 °C. After regenerating, intact complete worms, which are actively swimming or crawling upon a gentle mechanical stimulus, should be used for the test. Injuries or autotomy in the worms should be prevented, e.g. by using pipettes with fire polished edges, or stainless steel dental picks for handling these worms.

Sources of starter cultures for *Lumbriculus variegatus* (addresses in the U.S. adopted from (4))

Europe

ECT Oekotoxikologie GmbH
Böttgerstr. 2-14
D-65439 Flörsheim/Main
Germany

Bayer Crop Science AG
Development — Ecotoxicology
Alfred-Nobel-Str. 50
D-40789 Monheim
Germany

University of Joensuu
Laboratory of Aquatic Toxicology
Dept. of Biology
Yliopistokatu 7, P.O. Box 111
FIN-80101 Joensuu
Finland

Dresden University of Technology
Institut für Hydrobiologie
Fakultät für Forst-, Geo- und Hydro-
wissenschaften
Mommensenstr. 13
D-01062 Dresden
Germany

C.N.R.- I.R.S.A.
Italian National Research Council
Water Research Institute
Via Mornera 25
I-20047 Brugherio MI

U.S.A.

U.S. Environmental Protection Agency
Mid-Continent Ecological Division
6201 Congdon Boulevard
Duluth, MN 55804

Michigan State University
Department of Fisheries and Wildlife
No. 13 Natural Resources Building
East Lansing, MI 48824-1222

▼ M6

U.S. Environmental Protection Agency	Wright State University
Environmental Monitoring System Laboratory	Institute for Environmental Quality
26 W. Martin Luther Dr.	Dayton, OH 45435
Cincinnati, OH 45244	

Columbia Environmental Research Center	Great Lakes Environmental Research Laboratory, NOAA
U.S. Geological Survey	2205 Commonwealth Boulevard
4200 New Haven Road	Ann Arbor, MI 48105-1593
Columbia, MO 65201	

REFERENCES

- (1) Phipps, G.L., Ankley, G.T., Benoit, D.A. and Mattson, V.R. (1993). Use of the aquatic Oligochaete *Lumbriculus variegatus* for assessing the toxicity and bioaccumulation of sediment-associated contaminants. *Environ.Toxicol. Chem.* 12, 269-279.
- (2) Brunson, E.L., Canfield, T.J., Ingersoll, C.J. & Kemble, N.E. (1998). Assessing the bioaccumulation of contaminants from sediments of the Upper Mississippi river using field-collected oligochaetes and laboratory-exposed *Lumbriculus variegatus*. *Arch. Environ. Contam. Toxicol.* 35, 191-201.
- (3) ASTM International (2000). Standard guide for the determination of the bioaccumulation of sediment-associated contaminants by benthic invertebrates, E 1688-00a. In ASTM International 2004 Annual Book of Standards. Volume 11.05. Biological Effects and Environmental Fate; Biotechnology; Pesticides. ASTM International, West Conshohocken, PA.
- (4) U.S. EPA (2000). Methods for measuring the toxicity and bioaccumulation of sediment-associated contaminants with freshwater invertebrates. Second Edition. EPA 600/R-99/064, U.S. Environmental Protection Agency, Duluth, MN, March 2000.
- (5) Kukkonen, J. and Landrum, P.F. (1994). Toxicokinetics and toxicity of sediment-associated Pyrene to *Lumbriculus variegatus* (Oligochaeta). *Environ. Toxicol. Chem.* 13, 1457-1468.
- (6) Drewes C.D. & Fournier C.R. (1990). Morphallaxis in an aquatic oligochaete, *Lumbriculus variegatus*: Reorganisation of escape reflexes in regenerating body fragments. *Develop. Biol.* 138: 94-103.
- (7) Leppänen, M.T. & Kukkonen, J.V.K. (1998a). Relationship between reproduction, sediment type and feeding activity of *Lumbriculus variegatus* (Müller): Implications for sediment toxicity testing. *Environ. Toxicol. Chem.* 17: 2196-2202.
- (8) Leppänen, M.T. & Kukkonen, J.V.K. (1998b). Factors affecting feeding rate, reproduction and growth of an oligochaete *Lumbriculus variegatus* (Müller). *Hydrobiologia* 377: 183-194.
- (9) Brust, K., O. Licht, V. Hultsch, D. Jungmann & R. Nagel (2001). Effects of Terbutryn on Aufwuchs and *Lumbriculus variegatus* in Artificial Indoor Streams. *Environ. Toxicol. Chemistry*, Vol. 20, pp. 2000–2007.
- (10) Oetken, M., K.-U. Ludwichowski & R. Nagel (2000). Sediment tests with *Lumbriculus variegatus* and *Chironomus riparius* and 3,4-dichloroaniline (3,4-DCA) within the scope of EG-AltstoffV. By order of the Federal Environmental Agency (Umweltbundesamt Berlin), FKZ 360 12 001, March 2000.
- (11) Leppänen M.T. & Kukkonen J.V.K. (1998). Relative importance of ingested sediment and porewater as bioaccumulation routes for pyrene to oligochaete (*Lumbriculus variegatus*, Müller). *Environ. Sci. Toxicol.* 32, 1503-1508.

▼ **M6**

Appendix 6

Summary of the ring test results
‘Sediment Toxicity Test with *Lumbriculus variegatus*’

Table 1

Results of individual ring test runs: Mean worm numbers in the controls and solvent controls at the end of the test; SD = standard deviation; CV = coefficient of variation

	mean worm number in the controls	SD	CV (%)	n	mean worm number in the solvent controls	SD	CV (%)	n
	32,3	7,37	22,80	3	39,0	3,61	9,25	3
	40,8	6,55	16,05	6	36,0	5,29	14,70	3
	41,5	3,54	8,52	2	38,5	7,05	18,31	4
	16,3	5,99	36,67	6	30,8	6,70	21,80	4
	24,3	10,69	43,94	3	26,3	3,06	11,60	3
	28,5	8,29	29,08	4	30,7	1,15	3,77	3
	28,3	3,72	13,14	6	28,8	2,56	8,89	6
	25,3	5,51	21,74	3	27,7	1,53	5,52	3
	23,8	2,99	12,57	4	21,3	1,71	8,04	4
	36,8	8,80	23,88	6	35,0	4,20	11,99	6
	33,0	3,58	10,84	6	33,5	1,73	5,17	4
	20,7	2,73	13,22	6	15,0	6,68	44,56	4
	42,0	7,07	16,84	6	43,7	0,58	1,32	3
	18,2	3,60	19,82	6	21,7	4,04	18,65	3
	32,0	3,95	12,34	6	31,3	4,79	15,32	4
interlab- oratory mean	29,59		20,10		30,61		13,26	
SD	8,32		10,03		7,57		10,48	
n	15				15			
min	16,3				15,0			
max	42,0				43,7			
CV (%)	28,1				24,7			

▼ **M6**

Table 2

Results of individual ring test runs: Mean total dry weights of worms per replicate in the controls and solvent controls at the end of the test; SD = standard deviation; CV = coeff. of variation

	total dry weight of worms per replicate (controls)	SD	CV (%)	n	total dry weight of worms per replicate (solvent controls)	SD	CV (%)	n
	24,72	6,31	25,51	3	27,35	4,08	14,93	3
	30,17	2,04	6,75	6	33,83	10,40	30,73	3
	23,65	3,61	15,25	2	28,78	4,68	16,28	4
	12,92	6,83	52,91	6	24,90	6,84	27,47	4
	21,31	4,17	19,57	3	25,87	5,30	20,49	3
	22,99	4,86	21,16	4	24,64	5,09	20,67	3
	18,91	1,91	10,09	6	19,89	1,77	8,89	6
	24,13	1,63	6,75	3	25,83	2,17	8,41	3
	22,15	3,18	14,34	4	22,80	2,60	11,40	4
	35,20	8,12	23,07	6	31,42	8,45	26,90	6
	41,28	5,79	14,02	6	41,42	4,37	10,55	4
	15,17	5,78	38,09	6	10,50	3,42	32,53	4
	35,69	8,55	23,94	6	38,22	1,23	3,21	3
	19,57	5,21	26,65	6	28,58	6,23	21,81	3
	29,40	2,16	7,34	6	31,15	2,70	8,67	4
interlaboratory mean	25,15		20,36		27,68		17,53	
SD	7,87		12,56		7,41		9,10	
n	15				15			
min	12,9				10,5			
max	41,3				41,4			
CV (%)	31,3				26,8			

▼M6

Table 3

Toxicity of PCP: Summary of endpoints in the ring test; interlaboratory means for EC₅₀, NOEC and LOEC; SD = standard deviation; CV = coefficient of variation

biological parameter		Inter-laboratory mean (mg/kg)	min	max	Inter-laboratory factor	SD	CV (%)	geometr. mean (mg/kg)
total number of worms	EC₅₀	23,0	4,0	37,9	9,4	10,7	46,3	19,9
	NOEC	9,9	2,1	22,7	10,7	7,2	72,3	7,6
	LOEC	27,9	4,7	66,7	14,2	19,4	69,4	20,9
	MDD (%)	22,5	7,1	39,1				
total dry weight of worms	EC₅₀	20,4	7,3	39,9	5,5	9,1	44,5	18,2
	NOEC	9,3	2,1	20,0	9,4	6,6	70,4	7,4
	LOEC	25,7	2,1	50,0	23,5	16,8	65,5	19,4
	MDD (%)	24,8	10,9	44,7				
mortality/survival	LC₅₀	25,3	6,5	37,2	5,7	9,4	37,4	23,1
	NOEC	16,5	2,1	40,0	18,8	10,3	62,4	12,8
	LOEC	39,1	4,7	66,7	14,2	18,1	46,2	32,6
reproduction (increase of number of worms per replicate)	EC₅₀	20,0	6,7	28,9	4,3	7,6	37,9	18,3
	NOEC	7,9	2,1	20,0	9,4	5,2	66,0	6,4
	LOEC	22,5	2,1	50,0	23,5	15,4	68,6	16,0
	MDD (%)	29,7	13,9	47,9				
growth (biomass increase per replicate)	EC₅₀	15,3	5,7	29,9	5,2	7,1	46,5	13,7
	NOEC	8,7	2,1	20,0	9,4	6,0	68,1	6,9
	LOEC	24,0	2,1	50,0	23,5	15,7	65,5	17,3
	MDD (%)	32,2	13,6	65,2				

MDD: minimum detectable difference from the control values during hypothesis testing; used as a measure of statistical power.

REFERENCE

Egeler, Ph., Meller, M., Schallnaß, H.J. & Gilberg, D. (2005). Validation of a sediment toxicity test with the endobenthic aquatic oligochaete *Lumbriculus variegatus* by an international ring test. In co-operation with R. Nagel and B. Karaoglan. Report to the Federal Environmental Agency (Umweltbundesamt Berlin), R&D No.: 202 67 429.

▼ **M6****C.36. PREDATORY MITE (*HYPOASPIS (GEOLAE LAPS) ACULEIFER*) REPRODUCTION TEST IN SOIL**

INTRODUCTION

1. This test method is equivalent to OECD test guideline (TG) 226 (2008). This test method is designed to be used for assessing the effects of chemicals in soil on the reproductive output of the soil mite species *Hypoaspis (Geolaelaps) aculeifer* Canestrini (Acari: Laelapidae), hence allowing for the estimation of the inhibition of the specific population growth rate (1,2). Reproductive output here means the number of juveniles at the end of the testing period. *H. aculeifer* represents an additional trophic level to the species for which test methods are already available. A reproduction test without discrimination and quantification of the different stages of the reproductive cycle is considered adequate for the purpose of this test method. For chemicals substances with another exposure scenario than via the soil other approaches might be appropriate (3).
2. *Hypoaspis (Geolaelaps) aculeifer* is considered to be a relevant representative of soil fauna and predatory mites in particular. It is worldwide distributed (5) and can easily be collected and reared in the laboratory. A summary on the biology of *H. aculeifer* is provided in Appendix 7. Background information on the ecology of the mite species and the use in ecotoxicological testing is available (4), (5), (6), (7), (8), (9), (10), (11), (12).

PRINCIPLE OF THE TEST

3. Adult females are exposed to a range of concentrations of the test chemical mixed into the soil. The test is started with 10 adult females per replicate vessel. Males are not introduced in the test, because experience has shown that females mate immediately or shortly after hatching from the deutonymph stage, if males are present. In addition, inclusion of males would prolong the test in a way that the demanding discrimination of age stages would become necessary. Thus, mating itself is not part of the test. The females are introduced into the test 28-35 days after the start of the egg laying period in the synchronisation (see Appendix 4), as the females can then be considered as already mated and having passed the pre-oviposition stage. At 20 °C the test ends at day 14 after introducing the females (day 0), which allows the first control offspring to reach the deutonymph stage (see Appendix 4). For the main measured variable, the number of juveniles per test vessels and additionally the number of surviving females are determined. The reproductive output of the mites exposed to the test chemical is compared to that of the controls in order to determine the EC_x (e.g. EC₁₀, EC₅₀) or the no observed effect concentration (NOEC) (see Appendix 1 for definitions), depending on the experimental design (see paragraph 29). An overview of the test schedule is given in Appendix 8.

INFORMATION ON THE TEST CHEMICAL

4. The water solubility, the log K_{ow}, the soil water partition coefficient and the vapour pressure of the test chemical should preferably be known. Additional information on the fate of the test chemical in soil, such as the rates of biotic and abiotic degradation, is desirable.
5. This test method can be used for water soluble or insoluble chemicals. However, the mode of application of the test chemical will differ accordingly. The test method is not applicable to volatile chemicals, i.e. chemicals for which the Henry's constant or the air/water partition coefficient is greater than one, or chemicals for which the vapour pressure exceeds 0,0133 Pa at 25 °C.

▼M6

VALIDITY OF THE TEST

6. The following criteria should be satisfied in the untreated controls for a test result to be considered valid:
 - Mean adult female mortality should not exceed 20 % at the end of the test;
 - The mean number of juveniles per replicate (with 10 adult females introduced) should be at least 50 at the end of the test;
 - The coefficient of variation calculated for the number of juvenile mites per replicate should not be higher than 30 % at the end of the definitive test.

REFERENCE CHEMICAL

7. The EC_x and/or NOEC of a reference chemical must be determined to provide assurance that the laboratory test conditions are adequate and to verify that the response of the test organisms did not change over time. Dimethoate (CAS 60-51-5) is a suitable reference chemical that has shown to affect population size (4). Boric acid (CAS 10043-35-3) may be used as an alternative reference chemical. Less experience has been gained with this chemical. Two design options are possible:
 - The reference chemical can be tested in parallel to the determination of the toxicity of each test chemical at one concentration, which has to be demonstrated beforehand in a dose response study to result in an effect of > 50 % reduction of offspring. In this case, the number of replicates should be the same as that in the controls (see paragraph 29).
 - Alternatively, the reference chemical is tested 1 - 2 times a year in a dose-response test. Depending on the design chosen, the number of concentrations and replicates and the spacing factor differ (see paragraph 29), but a response of 10 - 90 % effect should be achieved (spacing factor of 1,8). The EC₅₀ for dimethoate based on the number of juveniles should fall in the range between 3,0 and 7,0 mg a.s./kg soil (dw). Based on the results obtained with boric acid so far, the EC₅₀ based on the number of juveniles should fall in the range between 100 and 500 mg/kg dw soil.

DESCRIPTION OF THE TEST

Test vessels and equipment

8. Test vessels of 3 - 5 cm diameter (height of soil \geq 1,5 cm), made of glass or other chemically inert material and having a close fitting cover, should be used. Screw lids are preferred and in that case, the vessels could be aerated twice a week. Alternatively, covers that permit direct gaseous exchange between the substrate and the atmosphere (e.g. gauze) can be used. Since moisture content must be kept high enough during the test, it is essential to control the weight of each experimental vessel during the test and replenish water if necessary. This may be especially important if no screw lids are available. If a non-transparent test vessel is used, the cover should be made of material that allows for access to light (e.g. by means of a perforated transparent cover) whilst preventing the mites from escaping. The size and type of the test vessel depends on the extraction method (see Appendix 5 for details). If heat extraction is applied directly to the test vessel, then a bottom mesh of appropriate mesh size could be added (sealed until extraction), and soil depth should be sufficient to allow for a temperature and moisture gradient.

▼ M6

9. Standard laboratory equipment is required, specifically the following:
- preferably glass vessels with screw lids;
 - drying cabinet;
 - stereomicroscope;
 - brushes for transferring mites
 - pH-meter and luxmeter;
 - suitable accurate balances;
 - adequate equipment for temperature control;
 - adequate equipment for air humidity control (not essential if exposure vessels are covered by lids);
 - temperature-controlled incubator or small room;
 - equipment for extraction (see Appendix 5) (13)
 - overhead light panel with light control
 - collection jars for extracted mites.

Preparation of the artificial soil

10. For this test, an artificial soil is used. The artificial soil consists of the following components (all values based on dry mass):
- 5 % sphagnum peat, air-dried and finely ground (a particle size of 2 ± 1 mm is acceptable);
 - 20 % kaolin clay (kaolinite content preferably above 30 %);
 - approximately 74 % air-dried industrial sand (depending on the amount of CaCO_3 needed), predominantly fine sand with more than 50 % of the particles between 50 and 200 microns. The exact amount of sand depends on the amount of CaCO_3 (see below), together they should add up to 75 %.
 - < 1,0 % calcium carbonate (CaCO_3 , pulverised, analytical grade) to obtain a pH of $6,0 \pm 0,5$; the amount of calcium carbonate to be added may depend principally on the quality/nature of the peat (see Note 1).

Note 1: The amount of CaCO_3 required will depend on the components of the soil substrate and should be determined by measuring the pH of soil sub-samples immediately before the test (14).

Note 2: The peat content of the artificial soil deviates from other test methods on soil organisms, where in most cases 10 % peat is used (e.g. (15)). However, according to EPPO (16) a typical agricultural soil has not more than 5 % organic matter, and the reduction in peat content thus reflects the decreased possibilities of a natural soil for sorption of the test chemical to organic carbon.

Note 3: If required, e.g. for specific testing purposes, natural soils from unpolluted sites may also serve as test and/or culture substrate. However, if natural soil is used, it should be characterised at least by origin (collection

▼M6

site), pH, texture (particle size distribution) and organic matter content. If available, the type and name of the soil according to soil classification should be included, and the soil should be free from any contamination. In case the test chemical is a metal or organo-metal, the cation exchange capacity (CEC) of the natural soil should also be determined. Special attention should be paid to meet the validity criteria as background information on natural soils typically is rare.

11. The dry constituents of the soil are mixed thoroughly (e.g. in a large-scale laboratory mixer). For the determination of pH a mixture of soil and 1 M potassium chloride (KCl) or 0,01 M calcium chloride (CaCl₂) solution in a 1:5 ratio is used (see (14) and Appendix 3). If the soil is more acidic than the required range (see paragraph 10), it can be adjusted by addition of an appropriate amount of CaCO₃. If the soil is too alkaline it can be adjusted by the addition of more of the mixture comprising the first three components described in paragraph 10, but excluding the CaCO₃.
12. The maximum water holding capacity (WHC) of the artificial soil is determined in accordance with procedures described in Appendix 2. Two to seven days before starting the test, the dry artificial soil is pre-moistened by adding enough distilled or de-ionised water to obtain approximately half of the final water content, that being 40 to 60 % of the maximum WHC. The moisture content is adjusted to 40-60 % of the maximum WHC by the addition of the test chemical solution and/or by adding distilled or de-ionised water (see paragraphs 16-18). An additional rough check of the soil moisture content should be obtained by gently squeezing the soil in the hand, if the moisture content is correct small drops of water should appear between the fingers.
13. Soil moisture content is determined at the beginning and at the end of the test by drying to constant weight at 105 °C in accordance with ISO 11465 (17) and soil pH in accordance with Appendix 3 or ISO 10390 (14). These measurements should be carried out in additional samples without mites, both from the control soil and from each test concentration soil. The soil pH should not be adjusted when acidic or basic chemicals are tested. The moisture content should be monitored throughout the test by weighing the vessels periodically (see paragraphs 20 and 24).

Selection and preparation of test animals

14. The species used in the test is *Hypoaspis (Geolaelaps) aculeifer* (Canestrini, 1883). Adult female mites, obtained from a synchronised cohort are required to start the test. Mites should be introduced ca. 7-14 days after becoming adult, 28 - 35 days after the start of the egg laying in the synchronisation (see paragraph 3 and Appendix 4). The source of the mites or the supplier and maintenance of the laboratory culture should be recorded. If a laboratory culture is kept, it is recommended that the identity of the species is confirmed at least once a year. An identification sheet is included as Appendix 6.

Preparation of test concentrations

15. The test chemical is mixed into the soil. Organic solvents used to aid treatment of the soil with the test chemical should be selected on the basis of their low toxicity to mites and appropriate solvent control must be included in the test design (see paragraph 29).

Test chemical soluble in water

16. A solution of the test chemical is prepared in deionised water in a quantity sufficient for all replicates of one test concentration. It is recommended to use an appropriate quantity of water to reach the required moisture content, i.e. 40 to 60 % of the maximum WHC (see paragraph 12). Each solution of test chemical is mixed thoroughly with one batch of pre-moistened soil before being introduced into the test vessel.

▼ M6*Test chemical insoluble in water*

17. For chemicals insoluble in water but soluble in organic solvents, the test chemical can be dissolved in the smallest possible volume of a suitable vehicle (e.g. acetone). Only volatile solvents should be used. When such vehicles are used, all test concentrations and the control should contain the same minimum amount of the vehicle. The vehicle is sprayed on or mixed with a small amount, for example 10 g, of fine quartz sand. The total sand content of the substrate should be corrected for this amount. The vehicle is eliminated by evaporation under a fume hood for at least one hour. This mixture of quartz sand and test chemical is added to the pre-moistened soil and thoroughly mixed by adding an appropriate amount of de-ionised water to obtain the moisture required. The final mixture is introduced into the test vessels. Note that some solvents may be toxic to mites. It is therefore recommended to use an additional water control without vehicle if the toxicity of the solvent to mites is not known. If it is adequately demonstrated that the solvent (in the concentrations to be applied) has no effects, the water control may be excluded.

Test chemical poorly soluble in water and organic solvents

18. For chemicals that are poorly soluble in water and organic solvents, the equivalent of 2,5 g of finely ground quartz sand per test vessel (for example 10 g of fine quartz sand for four replicates) is mixed with the quantity of test chemical to obtain the desired test concentration. The total sand content of the substrate should be corrected for this amount. This mixture of quartz sand and test chemical is added to the pre-moistened soil and thoroughly mixed after adding an appropriate amount of deionised water to obtain the required moisture content. The final mixture is divided between the test vessels. The procedure is repeated for each test concentration and an appropriate control is also prepared.

PROCEDURE**Test groups and controls**

19. Ten adult females in 20 g dry mass of artificial soil are recommended for each control and treatment vessel. Test organisms should be added within two hours after preparation of the final test substrate (i.e. after application of the test item). In specific cases (e.g. when ageing is considered to be a determining factor), the time between preparation of the final test substrate and the addition of the mites can be prolonged (for details of such ageing, see (18)). However, in such cases a scientific justification must be provided.
20. After the addition of the mites to the soil, the mites are provided with food and the initial weight of each test vessel should be measured to be used as reference for monitoring soil moisture content throughout the test as described in paragraph 24. The test vessels are then covered as described in paragraph 8 and placed in the test chamber.
21. Appropriate controls are prepared for each of the methods of test chemical application described in paragraphs 15 to 18. The relevant procedures described are followed for preparing the controls except that the test chemical is not added. Thus, where appropriate, organic solvents, quartz sand or other vehicles are applied to the controls in concentrations/amounts like in the treatments. Where a solvent or other vehicle is used to add the test chemical, an additional control without the vehicle or test chemical should also be prepared and tested in case the toxicity of the solvent is not known (see paragraph 17).

▼ M6**Test conditions**

22. The test temperature should be 20 ± 2 °C. Temperature should be recorded at least daily and adjusted, if necessary. The test is carried out under controlled light-dark cycles (preferably 16 hours light and 8 hours dark) with illumination of 400 to 800 lux in the vicinity of the test vessels. For reasons of comparability, these conditions are the same as in other soil ecotoxicological tests (e.g. (15)).
23. Gaseous exchange should be guaranteed by aerating the test vessels at least twice a week in case screw lids are used. If gauze covers are used, special attention should be paid to the maintenance of the soil moisture content (see paragraphs 8 and 24).
24. The water content of the soil substrate in the test vessels is maintained throughout the test by weighing and if needed re-watering the test vessels periodically (e.g. once per week). Losses are replenished as necessary with de-ionised water. The moisture content during the test should not differ by more than 10 % from the start value.

Feeding

25. Cheese mites (*Tyrophagus putrescentiae* (Schrank, 1781)) have been shown to be a suitable food source. Small collembolans (e.g. juvenile *Folsomia candida* Willem, 1902 or *Onychiurus fimatus* (19), (20), enchytraeids (e.g. *Enchytraeus crypticus* Westheide & Graefe, 1992) or nematodes (e.g. *Turbatrix silusiae* de Man, 1913)) may be also suitable (21). It is recommended to check the food before using it in a test. The type and amount of food should secure an adequate number of juveniles in order to fulfil the validity criteria (paragraph 6). For the prey selection, the mode of action of the test item should be considered (e.g. an acaricide may be toxic to the food mites too, see paragraph 26).
26. Food should be provided *ad libitum* (i.e. each time a small amount (tip of a spatula)). For this purpose, also low suction exhaustor as proposed in the collembolan test or a fine paint brush can also be used. Supplying food at the beginning of the test and two to three times a week will usually be sufficient. When the test item appears to be toxic to the prey, an increased feeding rate and/or an alternative food source should be considered.

Selection of test concentrations

27. Prior knowledge of the toxicity of the test chemical should help in selecting appropriate test concentrations, e.g. from range-finding studies. When necessary, a range-finding test is conducted with five concentrations of the test chemical in the range of 0,1 – 1 000 mg/kg dry soil, with at least one replicate for treatments and control. The duration of the range finding test is 14 days, after which mortality of the adult mites and the number of juveniles is determined. The concentration range in the final test should preferably be chosen so that it includes concentrations at which juvenile numbers are affected while survival of the maternal generation is not. This, however, may not be possible for chemicals that cause lethal and sub-lethal effects at almost similar concentrations. The effect concentration (e.g. EC₅₀, EC₂₅, EC₁₀) and the concentration range, over which the effect of the test chemical is of interest, should be bracketed by the concentrations included in the test. Extrapolating much below the lowest concentration affecting the test organisms or above the highest tested concentration should be done only in exceptional cases, and a full explanation should be given in the report.

Experimental design*Dose response tests*

28. Three test designs are proposed, based on the recommendations arising from another ring test (Enchytraeid reproduction test (22)). The general suitability

▼ M6

of all these designs was confirmed by the outcome of *H. aculeifer* validation.

29. In setting the range of concentrations, the following should be borne in mind:
- For determination of the EC_x (e.g. EC₁₀, EC₅₀), twelve concentrations should be tested. At least two replicates for each test concentration and six control replicates are recommended. The spacing factor may vary, i.e. less than or equal to 1,8 in the expected effect range and above 1,8 at the higher and lower concentrations.
 - For determination of the NOEC, at least five concentrations in a geometric series should be tested. Four replicates for each test concentration plus eight controls are recommended. The concentrations should be spaced by a factor not exceeding 2,0.
 - A combined approach allows for determination of both the NOEC and EC_x. Eight treatment concentrations in a geometric series should be used. Four replicates for each treatment plus eight controls are recommended. The concentrations should be spaced by a factor not exceeding 1,8.

Limit test

30. If no effects are observed at the highest concentration in the range-finding test (i.e. 1 000 mg/kg dw soil), the definitive reproduction test can be performed as a limit test, using a test concentration of 1 000 mg/kg dw soil. A limit test will provide the opportunity to demonstrate that the NOEC or the EC₁₀ for reproduction is greater than the limit concentration, whilst minimising the number of mites used in the test. Eight replicates should be used for both the treated soil and the control.

Test duration and measurements

31. Any observed differences between the behaviour and the morphology of the mites in the control and the treated vessels should be recorded.
32. On day 14 the surviving mites are extracted from the soil via heat/light extraction or by another appropriate method (see Appendix 5). The numbers of juveniles (i.e. larvae, protonymphs and deutonymphs) and adults are counted separately. Any adult mites not found at this time are to be recorded as dead, assuming that such mites have died and decomposed prior to the assessment. Extraction efficiency must be validated once or twice a year in controls with known numbers of adults and juveniles. Efficiency should be above 90 % on average combined for all developmental stages (see Appendix 5). Adult and juvenile counts are not adjusted for efficiency.

DATA AND REPORTING**Treatment of results**

33. Information on the statistical methods that may be used for analysing the test results is given in paragraphs 36 to 41. In addition, OECD Document 54 on the 'Current Approaches in the Statistical Analysis of Ecotoxicity Data: a Guidance to Application' (31) should be consulted.
34. Test main endpoint is the reproductive output, here the number of juveniles produced per replicate test vessel (with 10 adult females introduced). The statistical analysis requires the arithmetic mean (\bar{X}) and the variance (s^2) for

▼M6

the reproductive output to be calculated per treatment and per control. X and s^2 are used for ANOVA procedures such as the Student t test, Dunnett test, or Williams' test as well as for the computation of 95 % confidence intervals.

Note: This main endpoint is equivalent with fecundity measured as the number of living juveniles produced during the test divided by the number of parental females introduced at the start of the test.

35. The number of surviving females in the untreated controls is a major validity criterion and has to be documented. As in the range-finding test, all other harmful signs should be recorded in the final report as well.

EC_x

36. EC_x-values including their associated lower and upper 95 % confidence limits for the parameter described in paragraph 34 are calculated using appropriate statistical methods (e.g. probit analysis, logistic or Weibull function, trimmed Spearman-Kärber method, or simple interpolation). An EC_x is obtained by inserting a value corresponding to x % of the control mean into the equation found. To compute the EC₅₀ or any other EC_x, the per treatment means (X) should be subjected to regression analysis.

NOEC/LOEC

37. If a statistical analysis is intended to determine the NOEC/LOEC, per-vessel statistics (individual vessels are considered replicates) are necessary. Appropriate statistical methods should be used (according to OECD Document 54 on the Current Approaches in the Statistical Analysis of Ecotoxicity Data: A Guidance to Application). In general, adverse effects of the test item compared to the control are investigated using one-tailed (smaller) hypothesis testing at $p \leq 0,05$. Examples are given in the following paragraphs.
38. Normal distribution of data can be tested e.g. with the Kolmogorov-Smirnov goodness-of-fit test, the Range-to-standard-deviation ratio test (R/s-test) or the Shapiro-Wilk test (two-sided, $p \leq 0,05$). Cochran's test, Levene test or Bartlett's test, (two-sided, $p \leq 0,05$) may be used to test variance homogeneity. If the prerequisites of parametric test procedures (normality, variance homogeneity) are fulfilled, One-way Analysis of Variance (ANOVA) and subsequent multi-comparison tests can be performed. Multiple comparisons (e.g. Dunnett's t-test) or step-down trend tests (e.g. Williams' test in case of a monotonous dose-response relationship) can be used to calculate whether there are significant differences ($p \leq 0,05$) between the controls and the various test item concentrations (selection of the recommended test according to OECD Document 54 on the Current Approaches in the Statistical Analysis of Ecotoxicity Data: a Guidance to Application). Otherwise, non-parametric methods (e.g. Bonferroni-U-test according to Holm or Jonckheere-Terpstra trend test) should be used to determine the NOEC and the LOEC.

Limit test

39. If a limit test (comparison of control and one treatment only) has been performed and the prerequisites of parametric test procedures (normality, homogeneity) are fulfilled, metric responses can be evaluated by the Student test (t-test). The unequal-variance t-test (Welch t-test) or a non parametric test, such as the Mann-Whitney-U-test may be used, if these requirements are not fulfilled.
40. To determine significant differences between the controls (control and solvent control), the replicates of each control can be tested as described for the limit test. If these tests do not detect significant differences, all

▼ M6

control and solvent control replicates may be pooled. Otherwise all treatments should be compared with the solvent control.

Test report

41. The test report should at least include the following information:

— *Test chemical*

- the identity of the test chemical, name, batch, lot and CAS-number, purity;
- physico-chemical properties of the test chemical (e.g. log K_{ow} , water solubility, vapour pressure, Henry's constant (H) and preferably information on the fate of the test chemical in soil).

— *Test organisms*

- identification and supplier of the test organisms, description of the culturing conditions;
- age range of test organisms.

— *Test conditions*

- description of the experimental design and procedure;
- preparation details for the test soil; detailed specification if natural soil is used (origin, history, particle size distribution, pH, organic matter content and if available the soil classification)
- the maximum water holding capacity of the soil;
- a description of the technique used to apply the test chemical to the soil;
- details of auxiliary chemicals used for administering the test chemical;
- size of test vessels and dry mass of test soil per vessel;
- test conditions: light intensity, duration of light-dark cycles, temperature;
- a description of the feeding regime, the type and amount of food used in the test, feeding dates;
- pH and water content of the soil at the start and during the test (control and each treatment)
- detailed description of the extraction method and extraction efficiency.

— *Test results*

- the number of juveniles determined in each test vessel at the end of the test;
- number of adult females and adult mortality (%) in each test vessel at the end of the test
- a description of obvious symptoms or distinct changes in behaviour;
- the results obtained with the reference test chemical;
- summary statistics (EC_x and/or NOEC) including 95 %-confidence limits and a description of the method of calculation;

▼ **M6**

- a plot of the concentration-response-relationship;
- deviations from procedures described in this test method and any unusual occurrences during the test.

LITERATURE

- (1) Casanueva, M.E. (1993). Phylogenetic studies of the free-living and arthropod associated Laelapidae (Acari: Mesostigmata). *Gayana Zool.* 57, 21-46.
- (2) Tenorio, J. M. (1982). Hypoaspidae (Acari: Gamasida: Laelapidae) of the Hawaiian Islands. *Pacific Insects* 24, 259-274.
- (3) Bakker, F.M., Feije, R., Grove, A. J., Hoogendorn, G., Jacobs, G., Loose, E.D. and van Stratum, P. (2003). A laboratory test protocol to evaluate effects of plant protection products on mortality and reproduction of the predatory mite *Hypoaspis aculeifer* Canestrini (Acari: Laelapidae) in standard soil. *JSS — Journal of Soils and Sediments* 3, 73-77.
- (4) Karg, W. (1993). Die freilebenden Gamasina (Gamasides), Raubmilben. 2nd edition In: Dahl, F. (Hrsg.): *Die Tierwelt Deutschlands* 59. Teil, G. Fischer, Jena, 523 pp.
- (5) Ruf, A. (1991). Do females eat males?: Laboratory studies on the population development of *Hypoaspis aculeifer* (Acari: Parasitiformes). In: F. Dusbabek & V. Bukva (eds.): *Modern Acarology*. Academia Prague & SPD Academic Publishing bv, The Hague, Vol. 2, 487-492
- (6) Ruf, A. (1995). Sex ratio and clutch size control in the soil inhabiting predatory mite *Hypoaspis aculeifer* (Canestrini 1883) (Mesostigmata, Dermanyssidae). *Proc. 2nd Symp. EURAAC*: p 241-249.
- (7) Ruf, A. (1996). Life-history patterns in soil-inhabiting mesostigmatid mites. *Proc. IXth Internat. Congr. Acarol. 1994*, Columbus, Ohio: p 621-628.
- (8) Krogh, P.H. and Axelsen, J.A. (1998). Test on the predatory mite *Hypoaspis aculeifer* preying on the collembolan *Folsomia fimetaria*. In: Lokke, H. and van Gestel, C.A.M.: *Handbook of soil invertebrate toxicity tests*. John Wiley Sons, Chichester, p 239-251.
- (9) Løkke, H., Janssen, C.R., Lanno, R.P., Rømbke, J., Rundgren, S. and Van Straalen, N.M. (2002). Soil Toxicity Tests — Invertebrates. In: *Test Methods to Determine Hazards of Sparingly Soluble Metal Compounds in Soils*. Fairbrother, A., Glazebrook, P.W., Van Straalen, N.M. and Tarazona, J.V. (eds.). SETAC Press, Pensacola, USA. 128 pp.
- (10) Schlosser, H.-J. and Riepert, F. (1991/92). Entwicklung eines Prüfverfahrens für Chemikalien an Bodenraubmilben (Gamasina). Teil 1: Biologie der Bodenraubmilbe *Hypoaspis aculeifer* Canestrini, 1883 (Gamasina) unter Laborbedingungen. *Zool. Beiträge*, 34, 395-433.
- (11) Schlosser, H.-J. and Riepert, F. (1992). Entwicklung eines Prüfverfahrens für Chemikalien an Bodenraubmilben (Gamasina). Teil 2: Erste Ergebnisse mit Lindan und Kaliumdichromat in subletaler Dosierung. *Zool. Beitr. N.F.* 34, 413-433.
- (12) Heckmann, L.-H., Maraldo, K. and Krogh, P. H. (2005). Life stage specific impact of dimethoate on the predatory mite *Hypoaspis aculeifer* Canestrini (Gamasida: Laelapidae). *Environmental Science & Technology* 39, 7154-7157.
- (13) Petersen, H. (1978). Some properties of two high-gradient extractors for soil microarthropods, and an attempt to evaluate their extraction efficiency. *Natura Jutlandica* 20, 95-122.
- (14) ISO (International Organization for Standardization) (1994). *Soil Quality — Determination of pH*, No. 10390. ISO, Geneva.

▼ **M6**

- (15) Chapter C.8 of this Annex -. Toxicity for Earthworms.
- (16) EPPO (2003): EPPO Standards. Environmental risk assessment scheme for plant protection products. Chapter 8. Soil Organisms and Functions. Bull. OEPP/EPPO Bull. 33, 195-209.
- (17) ISO (International Organization for Standardization) (1993). Soil Quality –Determination of dry matter and water content on a mass basis — Gravimetric method, No. 11465. ISO, Geneve.
- (18) Fairbrother, A., Glazebrook, P.W., Van Straalen, N.M. and Tarazona, J.V. 2002. Test methods to determine hazards of sparingly soluble metal compounds in soils. SETAC Press, Pensacola, FL, USA.
- (19) Chi, H. 1981. Die Vermehrungsrate von *Hypoaspis aculeifer* Canestrini (Acarina, Laelapidae) bei Ernährung mit *Onychiurus fimatus* Gisin (Collenbola). Ges.allg. angew. Ent. 3:122-125.
- (20) Schlosser, H.J., und Riepert, F. 1992. Entwicklung eines Prüfverfahrens für Chemikalien an Bodenraubmilben (Gamasina). Zool.Beitr. N.F. 34(3):395-433.
- (21) Heckmann, L.-H., Ruf, A., Nienstedt, K. M. and Krogh, P. H. 2007. Reproductive performance of the generalist predator *Hypoaspis aculeifer* (Acari: Gamasida) when foraging on different invertebrate prey. Applied Soil Ecology 36, 130-135.
- (22) Chapter C.32 of this Annex- Enchytraeid reproduction test.
- (23) ISO (International Organization for Standardization) (1994). Soil Quality — Effects of pollutants on earthworms (*Eisenia fetida*). Part 2: Determination of effects on reproduction, No. 11268-2. ISO, Geneve.
- (24) Southwood, T.R.E. (1991). Ecological methods. With particular reference to the study of insect populations. (2nd ed.). Chapman & Hall, London, 524 pp.
- (25) Dunger, W. and Fiedler, H.J. (1997). Methoden der Bodenbiologie (2nd ed.). G. Fischer, Jena, 539 pp.
- (26) Lesna, I. and Sabelis, M.W. (1999). Diet-dependent female choice for males with 'good genes' in a soil predatory mite. Nature 401, 581-583.
- (27) Ruf, A. (1989). Die Bedeutung von Arrhenotokie und Kannibalismus für die Populationsentwicklung von *Hypoaspis aculeifer* (Canestrini 1883) (Acari, Gamasina). Mitt. Deut. Ges. Allg. Angew. Ent. 7, 103-107.
- (28) Ruf, A. (1993). Die morphologische Variabilität und Fortpflanzungsbiologie der Raubmilbe *Hypoaspis aculeifer* (Canestrini 1883) (Mesostigmata, Dermanyssidae). Dissertation, Universität Bremen.
- (29) Ignatowicz, S. (1974). Observations on the biology and development of *Hypoaspis aculeifer* Canestrini, 1885 (Acarina, Gamasides). Zoologica Poloniae 24, 11-59.
- (30) Kevan, D.K. McE. and Sharma, G.D. (1964). Observations on the biology of *Hypoaspis aculeifer* (Canestrini, 1884), apparently new to North America (Acarina: Mesostigmata: Laelaptidae). Acarologia 6, 647-658.
- (31) OECD (2006c). Current Approaches in the Statistical Analysis of Ecotoxicity Data: A Guidance to Application. OECD environmental Health and Safety Publications Series on Testing and Assessment No.54. ENV/JM/MONO(2006)18

▼ M6*Appendix 1***Definitions**

The following definitions are applicable to this test method (in this test all effect concentrations are expressed as a mass of test chemical per dry mass of the test soil):

Chemical is a substance or a mixture

NOEC (no observed effect concentration) is the test chemical concentration at which no effect is observed. In this test, the concentration corresponding to the NOEC, has no statistically significant effect ($p < 0,05$) within a given exposure period when compared with the control.

LOEC (lowest observed effect concentration) is the lowest test chemical concentration that has a statistically significant effect ($p < 0,05$) within a given exposure period when compared with the control.

EC_x (effect concentration for x % effect) is the concentration that causes an x % of an effect on test organisms within a given exposure period when compared with a control. For example, an EC₅₀ is a concentration estimated to cause an effect on a test end point in 50 % of an exposed population over a defined exposure period.

Test Chemical is any substance or mixture tested using this test method.

▼ M6*Appendix 2***Determination of the maximum water holding capacity of the soil**

The following method for determining the maximum water holding capacity of the soil is considered to be appropriate. It is described in Annex C of ISO DIS 11268-2 (Soil Quality — Effects of pollutants on earthworms (*Eisenia fetida*). Part 2: Determination of effects on reproduction (23)).

Collect a defined quantity (e.g. 5 g) of the test soil substrate using a suitable sampling device (auger tube etc.). Cover the bottom of the tube with a piece of filter paper filled with water and then place it on a rack in a water bath. The tube should be gradually submerged until the water level is above to the top of the soil. It should then be left in the water for about three hours. Since not all water absorbed by the soil capillaries can be retained, the soil sample should be allowed to drain for a period of two hours by placing the tube onto a bed of very wet finely ground quartz sand contained within a covered vessel (to prevent drying). The sample should then be weighed, dried to constant mass at 105 °C. The water holding capacity (WHC) can then be calculated as follows:

$$\text{WHC (in\% of dry mass)} = \frac{S - T - D}{D} \times 100$$

Where:

S = water-saturated substrate + mass of tube + mass of filter paper

T = tare (mass of tube + mass of filter paper)

D = dry mass of substrate

▼M6*Appendix 3***Determination of soil pH**

The following method for determining the pH of a soil is based on the description given in ISO DIS 10390: Soil Quality — Determination of pH (16).

A defined quantity of soil is dried at room temperature for at least 12 h. A suspension of the soil (containing at least 5 grams of soil) is then made up in five times its volume of either a 1 M solution of analytical grade potassium chloride (KCl) or a 0,01 M solution of analytical grade calcium chloride (CaCl₂). The suspension is then shaken thoroughly for five minutes and then left to settle for at least 2 hours but not for longer than 24 hours. The pH of the liquid phase is then measured using a pH-meter that has been calibrated before each measurement using an appropriate series of buffer solutions (e.g. pH 4,0 and 7,0).

▼ **M6**

Appendix 4

Rearing of *Hypoaspis (Geolaelaps) aculeifer*, food mites and synchronisation of culture**Rearing of *Hypoaspis (Geolaelaps) aculeifer*:**

Cultures can be maintained in plastic vessels or glass jars filled with plaster of Paris / charcoal powder (9:1) mixture. The plaster can be kept moist by adding few drops of distilled or deionised water if required. Rearing temperatures are optimal between 20 ± 2 °C, light / dark regime is not relevant for this species. Prey can be *Tyrophagus putrescentiae* or *Caloglyphus* sp. mites (food mites should be handled with care since they could cause allergies in humans), but nematodes, enchytraeids and collembolans are also suited as prey items. Their source should be recorded. Population development can start with a single female because males develop in unfertilised eggs. Generations are largely overlapping. A female can live at least 100 days and can deposit approximately 100 eggs during its lifetime. A maximum oviposition rate is reached between 10 and 40 days (after becoming adults) and amounts to $2,2 \text{ eggs female}^{-1} \text{ day}^{-1}$. Developmental time from egg to adult female is approximately 20 days at 20 °C. More than one culture should be maintained and held beforehand.

Rearing of *Tyrophagus putrescentiae*:

The mites are kept in a glass vessel filled with fine brewers yeast powder which is put in a plastic bucket filled with KNO_3 -solution in order to avoid escaping. The food mites are placed on top of this powder. Afterwards, they are carefully mixed with the powder (which has to be replaced twice a week) using a spatula.

Synchronisation of culture:

Specimens that are used in the test should be of similar age (ca. 7 days after reaching the adult stage). At a rearing temperature of 20 °C this is achieved by

Transfer females to a clean rearing vessel and add sufficient food

— Allow for two to three days of egg laying, remove females

— Take adult females for testing between the 28th and 35th day after start placing female adults in clean rearing vessels.

Adult females can be easily distinguished from males and other developmental stages by their larger size, bloated shape and their brown dorsal shield (males are slimmer and flat), immatures are white to cream-coloured. The development of the mites follows approximately the pattern described below at 20 °C (figure): Egg 5d, Larva 2d, Protonymph 5d, Deutonymph 7d, preoviposition period of female 2d. Afterwards, the mites are adult.

Figure

Development of *Hypoaspis (Geolaelaps) aculeifer* at 20 °C. (removal = females used for the test)

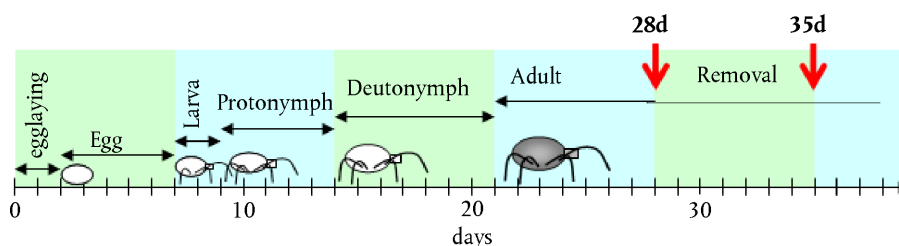

▼ M6

The adult test animals are removed from the synchronised culture and introduced into the test vessels between the 28th and the 35th day after the parental females have started egg laying (i.e. 7 – 14 days after they became adult). This ensures that the test animals have already passed their preoviposition period and have been mated by males that are also present in the culture vessel. Observations in laboratory cultures suggest, that females mate immediately or shortly after becoming adult if males are present (Ruf, Vaninnen, pers. obs.). The period of seven days is chosen to facilitate integration in laboratory routine and to buffer individual developmental variability among mites. The oviposition should be started with at least the same number of females that is eventually needed for the test (If for example 400 females are needed in the test, at least 400 females should be allowed to oviposit for two to three days. At least 1 200 eggs should be the starting point for the synchronised population (sex ratio ca. 0,5, mortality ca. 0,2). To avoid cannibalism, it is more feasible to keep not more than 20-30 ovipositing females in one vessel.

▼ **M6***Appendix 5***Extraction methods**

For micro-arthropods a heat extraction is an appropriate method to separate specimens from the soil / substrate (see figure below). The method is based on the activity of the organisms, so only mobile specimens will have the chance to be recorded. The principle of the heat extraction is to make conditions for the organisms gradually worse in the sample, so that they will leave the substrate and fall in a fixing liquid (e.g. ethanol). Crucial points are the duration of the extraction and the gradient of good to moderate to bad conditions for the organisms. The duration of extraction for ecotoxicological tests have to be as short as possible, because any population growth during the time of extraction would falsify the results. On the other hand the temperature and moisture conditions in the sample have to be always in a range that allows the mites to move. The heating of a soil sample leads to a desiccation of substrate. If the desiccation is too quick, some mites might also desiccated before they managed to escape.

Therefore the following procedure is proposed (24) (25):

Apparatus: Tullgren funnel or comparable methods like e.g. McFadyen (heating from above, sample is put over a funnel)

Heating regime: 25 °C for 12 h, 35 °C for 12 h, 45 °C for 24 hours (in total 48 h). The temperature should be measured in the substrate.

Fixation liquid: 70 % ethanol

Details: Take glass vial that was used for the test. Remove lid and wrap a piece of mesh or fabric around the opening. The fabric should have a mesh size of 1,0 to 1,5 mm. Fix the fabric with an elastic band. Carefully turn the vial upside down and place it in the extraction apparatus. The fabric prevents substrate from trickling in the fixation liquid but allows mites to leave the sample. Start the heating regime after all vials are inserted. End the extraction after 48 hours. Remove fixation vials and count mites by means of a dissecting microscope.

The extraction efficiency of the chosen method must have been proven once or twice a year using vessels containing a known number of juvenile and adult mites kept in untreated test substrate. Efficiency should be ≥ 90 % on average combined for all developmental stages.

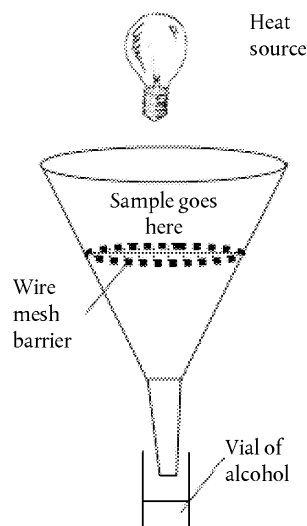
Tullgren-type extracting device

▼ **M6**

How to prepare the test vial after the test is finished, before extraction

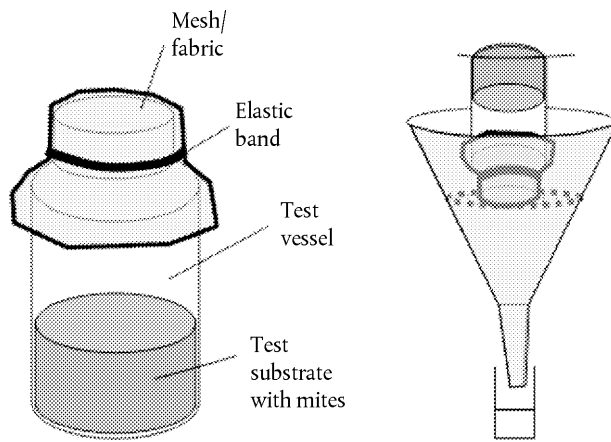

▼ M6

Appendix 6

Identification of *Hypoaspis (Geolaelaps) aculeifer*

Subclass/order/suborder:	Family:	Genus/subgenus/species:
Acari/Parasitiformes/Gamasida	Laelapidae	<i>Hypoaspis (Geolaelaps) aculeifer</i>

Author and Date:	F. Faraji, Ph.D. (MITOX), 23 January 2007
------------------	---

Literature used:	<p>Karg, W. (1993). Die freilebenden Gamasina (Gamasides), Raubmilben. Tierwelt Deutschlands 59, 2nd revised edition; 1-523.</p> <p>Hughes, A.M. (1976). The mites of stored food and houses. Ministry of Agriculture, Fisheries and Food, Technical Bulletin 9: 400pp.</p> <p>Krantz, G.W. (1978). A manual of Acarology. Oregon State University Book Stores, Inc., 509 pp.</p>
------------------	---

Deterministic characteristics:	<p>Tectum with rounded denticulate edge; hypostomal grooves with more than 6 denticles; caudal dorsal setae of Z4 not very long; dorsal setae setiform; genital shield normal, not very enlarged and not reaching the anal shield; posterior half of dorsal shield without unpaired setae; legs II and IV with some thick macrosetae; dorsal seta Z5 about two times longer than J5; fixed digit of chelicera with 12-14 teeth and movable digit with 2 teeth; Idiosoma 520-685 µm long.</p> <p><i>Hypoaspis miles</i> is also used in biological control and might get confused with <i>H. aculeifer</i>. The main difference is:</p> <p><i>H. miles</i> belongs to subgenus <i>Cosmolaelaps</i> and has knife-like dorsal setae while <i>H. aculeifer</i> belongs to subgenus <i>Geolaelaps</i> and has setiform dorsal setae.</p>
--------------------------------	--

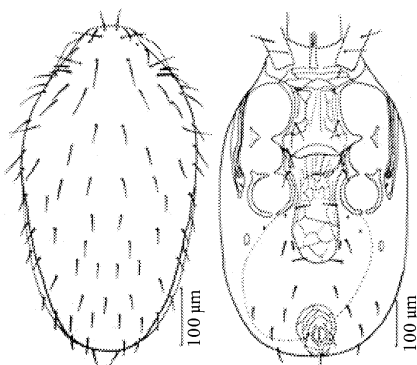
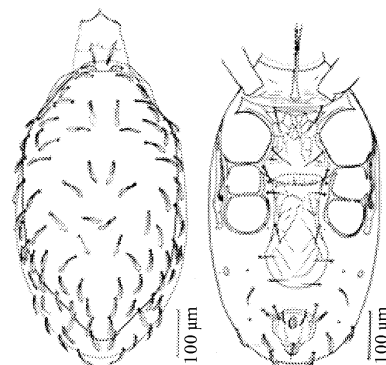
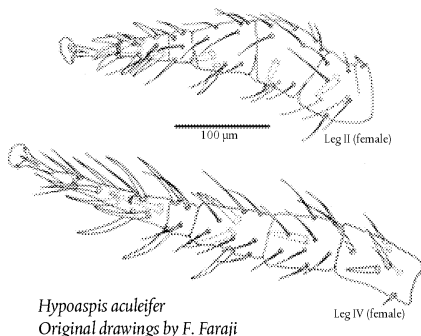
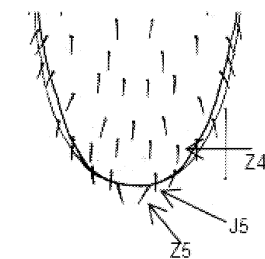
*Hypoaspis aculeifer* After Hughes, 1976*Hypoaspis miles* After Hughes, 1976*Hypoaspis aculeifer*
Original drawings by F. Faraji*Hypoaspis aculeifer*,
dorsal shield with characteristic setae

▼ **M6***Appendix 7***Basic information on the biology of *Hypoaspis (Geolaelaps) aculeifer***

Hypoaspis aculeifer belongs to the family Lealapidae, order Acari (mites), class Arachnida, tribe Arthropoda. They are living in all kinds of soil and feed on other mites, nematodes, enchytraeids and collembolans (26). In case of food shortage they switch to cannibalism (27). Predatory mites are segmented in idiosoma and gnathosoma. A clear differentiation of the idiosoma in prosoma (head) and opisthosoma (abdomen) is missing. The gnathosoma (head shield) contains the instruments for feeding such as palps and chelicera. The chelicerae are trifurcated and tusked with teeth of different shape. Beside ingestion the males are using their chelicerae mainly to transfer the spermatophores to the females. A dorsal shield covers nearly completely the idiosoma. A big part of the female idiosoma is occupied by the reproductive organs, which are in particular distinct shortly before egg deposition. Ventrally, two shields can be found, the sternal and the genital shield. All legs are provided with bristles and thorns. The bristles are used to anchor when moving in or on top of the soil. The first pair of legs is used mainly as antenna. The second pair of legs is used not only for moving but also to clinch the prey. The thorns of the fourth pair of legs can serve as protection as well as 'moving motor' (28). Males are 0,55 - 0,65 mm long and have a weight of 10 - 15 µg. Females are 0,8 - 0,9 mm long and are weighing 50 - 60 µg (8) (28) (Fig 1).

Figure 1

Female, male, protonymph and larvae of *H. aculeifer*.



At 23 °C, the mites become sexually mature after 16 days (females) and 18 days (males), respectively (6). The females carry over the sperms by the solenostome where they will be then transferred to the ovaries. In the ovaries the sperms mature and will be stored. Fertilisation takes place only after maturation of the sperms in the ovaries. The fertilised or unfertilised eggs will be deposited by the females in clumps or separately, preferably in crevices or holes. Copulated females can bear juveniles of both sexes whereas from eggs of uncopulated females only male juveniles are hatching. During development to the adult four phases of development (egg — larvae, larvae — protonymph, protonymph — deutonymph, deutonymph — adult) are passed through.

The egg is milky white, hyaline, elliptical and approximately 0,37 mm long with a solid mantle. According to (8), the larvae are between 0,42 - 0,45 mm in size. They have only three pairs of legs. In the head region palps and chelicerae are developed. The chelicerae, having some few small denticles, are used to hatch from the egg. After the first moult, 1 - 2 days after hatching, the protonymphs are developed. They are also white, the size is 0,45 - 0,62 mm (8) and they have four pairs of legs. On the chelicerae the teeth are completely present. Beginning with that stadium the mites start to forage. For that reason the cuticula of the prey is pierced with the chelicerae and a secretion for the extra intestinal digestion is emitted into the prey. The food mash can then be sucked by the mite. The

▼ M6

chelicers can also be used to rip bigger particles out of food nuggets (28). After one further moult the deutonymphs are developed. They are 0,60 - 0,80 mm (8) in size and yellow to light brown in colour. Beginning with that phase they can be separated into females and males. After further ecdysis, during which time the animals are inactive and the brown shield is developing (approx. after 14 days) the mites are adult (28) (29) (30). Their life span is between 48 and 100 days at 25 °C (27).

▼ **M6***Appendix 8***Summary and time schedule of the main actions to be taken in order to perform the Hypoaspis test**

Time (days) test start = day 0	Activity / task
Day – 35 to – 28	Transfer females from stock culture to clean vessels to start synchronisation 2 days later: removal of females Twice or three times a week: supply with sufficient food
Day – 5 (+/- 2)	Prepare artificial soil
Day – 4 (+/- 2)	Determine WHC of artificial soil Dry over night Next day: weigh samples and calculate WHC
Day – 4 (+/- 2)	Pre moisture artificial soil to achieve 20 - 30 % of WHC
Day 0	Start test: add test chemical to artificial soil Introduce 10 females to each replicate Weigh each replicate Set up abiotic controls for moisture content and pH, 2 replicates for each treatment Dry moisture controls over night Next day: weigh moisture controls Next day: measure pH of dried abiotic controls
Day 3, 6, 9, 12 (approx.)	Supply each replicate with sufficient amount of prey organisms Weigh each replicate and eventually add evaporated water
Day 14	Terminate test, set up extraction with all replicates plus extraction efficiency controls Dry water content controls over night Next day: weigh water content controls Next day: measure pH of dried controls
Day 16	Terminate extraction
Day 16 +	Record number of adults and juveniles in extracted material Report results on template tables Report testing procedure in test protocol sheets.

▼ M6**C.37. 21-DAY FISH ASSAY: A SHORT-TERM SCREENING FOR OESTROGENIC AND ANDROGENIC ACTIVITY, AND AROMATASE INHIBITION**

INTRODUCTION

1. This test method is equivalent to OECD test guideline (TG) 230 (2009). The need to develop and validate a fish assay capable of detecting certain endocrine active chemicals originates from the concerns that environmental levels of chemicals may cause adverse effects in both humans and wildlife due to the interaction of these chemicals with the endocrine system. In 1998, the OECD initiated a high-priority activity to revise existing guidelines and to develop new guidelines for the screening and testing of potential endocrine disrupters. One element of the activity was to develop a Test Guideline for the screening of chemicals active on the endocrine system of fish species. The 21-day Fish Endocrine Screening Assay underwent an extensive validation programme consisting of inter-laboratory studies with selected chemicals to demonstrate the relevance and reliability of the assay for the detection of oestrogenic and aromatase inhibiting chemicals (1, 2, 3, 4, 5) in the three fish species investigated (the fathead minnow, the Japanese medaka and the zebrafish); the detection of androgenic activity is possible in the fathead minnow and the medaka, but not in the zebrafish. This test method does not allow the detection of anti-androgenic chemicals. The validation work has been peer-reviewed by a panel of experts nominated by the National Coordinators of the Test Guideline Programme (6). The assay is not designed to identify specific mechanisms of hormonal disruption because the test animals possess an intact hypothalamic-pituitary-gonadal (HPG) axis, which may respond to chemicals that impact on the HPG axis at different levels. The Fish Short Term Reproduction assay (OECD TG 229) includes fecundity and, as appropriate, gonadal histopathology for the fathead minnow, as well as all endpoints included in this test method. OECD TG 229 provides a screening of chemicals which affect reproduction through various mechanisms including endocrine modalities. This should be considered prior to selecting the most appropriate test method.
2. This test method describes an *in vivo* screening assay where sexually mature male and spawning female fish are held together and exposed to a chemical during a limited part of their life-cycle (21 days). At termination of the 21-day exposure period, depending on the species used, one or two biomarker endpoint(s) are measured in males and females as indicators of oestrogenic, aromatase inhibition or androgenic activity of the test chemical; these endpoints are vitellogenin and secondary sexual characteristics. Vitellogenin is measured in fathead minnow, Japanese medaka and zebrafish, whereas secondary sex characteristics are measured in fathead minnow and Japanese medaka only.
3. This bioassay serves as an *in vivo* screening assay for certain endocrine modes of action and its application should be seen in the context of the 'OECD Conceptual Framework for the Testing and Assessment of Endocrine Disrupting Chemicals' (28).

INITIAL CONSIDERATIONS AND LIMITATIONS

4. Vitellogenin is normally produced by the liver of female oviparous vertebrates in response to circulating endogenous oestrogen. It is a precursor of egg yolk proteins and, once produced in the liver, travels in the bloodstream to the ovary, where it is taken up and modified by developing eggs. Vitellogenin is almost undetectable in the plasma of immature female and male fish because they lack sufficient circulating oestrogen; however, the liver is capable of synthesizing and secreting vitellogenin in response to exogenous oestrogen stimulation.

▼ M6

5. The measurement of vitellogenin serves for the detection of chemicals with various oestrogenic modes of action. The detection of oestrogenic chemicals is possible via the measurement of vitellogenin induction in male fish, and it has been abundantly documented in the scientific peer-reviewed literature (e.g. (7)). Vitellogenin induction has also been demonstrated following exposure to aromatizable androgens (8, 9). A reduction in the circulating level of oestrogen in females, for instance through the inhibition of the aromatase converting the endogenous androgen to the natural oestrogen 17 β -estradiol, causes a decrease in the vitellogenin level, which is used to detect chemicals having aromatase inhibiting properties (10, 11). The biological relevance of the vitellogenin response following oestrogenic/aromatase inhibition is established and has been broadly documented. However, it is possible that production of VTG in females can also be affected by general toxicity and non-endocrine toxic modes of action, e.g. hepatotoxicity.
6. Several measurement methods have been successfully developed and standardised for routine use. This is the case of species-specific Enzyme-Linked Immunosorbent Assay (ELISA) methods using immunochemistry for the quantification of vitellogenin produced in small blood or liver samples collected from individual fish (12, 13, 14, 15, 16, 17, 18). Fathead minnow blood, zebrafish blood or head/tail homogenate, and medaka liver are sampled for VTG measurement. In medaka, there is a good correlation between VTG measured from blood and from liver (19). Appendix 6 provides the recommended procedures for sample collection for vitellogenin analysis. Kits for the measurement of vitellogenin are widely available; such kits should be based on a validated species-specific ELISA method.
7. Secondary sex characteristics in male fish of certain species are externally visible, quantifiable and responsive to circulating levels of endogenous androgens; this is the case for the fathead minnow and the medaka — but not for zebrafish, which does not possess quantifiable secondary sex characteristics. Females maintain the capacity to develop male secondary sex characteristics, when they are exposed to androgenic chemicals in water. Several studies are available in the scientific literature to document this type of response in fathead minnow (20) and medaka (21). A decrease in secondary sex characteristics in males should be interpreted with caution because of low statistical power, and should be based on expert judgement and weight of evidence. There are limitations to the use of zebrafish in this assay, due to the absence of quantifiable secondary sex characteristics responsive to androgenic acting chemicals.
8. In the fathead minnow, the main indicator of exogenous androgenic exposure is the number of nuptial tubercles located on the snout of the female fish. In the medaka, the number of papillary processes constitutes the main marker of exogenous exposure to androgenic chemicals in female fish. Appendix 5A and Appendix 5B indicate the recommended procedures to follow for the evaluation of sex characteristics in fathead minnow and in medaka, respectively.
9. Definitions used in this test method are given in Appendix 1.

PRINCIPLE OF THE TEST

10. In the assay, male and female fish in a reproductive status are exposed together in test vessels. Their adult and reproductive status enables a clear differentiation of each sex, and thus a sex-related analysis of each endpoint, and ensures their sensitivity towards exogenous chemicals. At test termination, sex is confirmed by macroscopic examination of the gonads following ventral opening of the abdomen with scissors. An overview of the relevant bioassay conditions is provided in Appendix 2. The assay is normally initiated with fish sampled from a population that is in spawning condition; senescent animals should not be used. Guidance on the age of fish and on the reproductive status is provided in the section on Selection of fish. The assay is conducted using three chemical exposure

▼ M6

concentrations as well as a water control, and a solvent control if necessary. Two vessels or replicates per treatment are used (each vessel containing 5 males and 5 females) in medaka and zebrafish, whereas four vessels or replicates per treatment are used (each vessel containing 2 males and 4 females) in fathead minnow. This is to accommodate the territorial behaviour of male fathead minnow while maintaining sufficient power of the assay. The exposure is conducted for 21 days and sampling of fish is performed at day 21 of exposure.

11. On sampling at day 21, all animals are killed humanely. Secondary sex characteristics are measured in fathead minnow and medaka (see Appendix 5A and Appendix 5B); blood samples are collected for determination of vitellogenin in zebrafish and fathead minnow, alternatively head/tail can be collected for the determination of vitellogenin in zebrafish (Appendix 6); liver is collected for VTG analysis in medaka (Appendix 6).

TEST ACCEPTANCE CRITERIA

12. For the test results to be acceptable the following conditions apply:
 - the mortality in the water (or solvent) controls should not exceed 10 % at the end of the exposure period;
 - the dissolved oxygen concentration should be at least 60 % of the air saturation value (ASV) throughout the exposure period;
 - the water temperature should not differ by more than $\pm 1,5$ °C between test vessels at any one time during the exposure period and be maintained within a range of 2 °C within the temperature ranges specified for the test species (Appendix 2);
 - evidence should be available to demonstrate that the concentrations of the test chemical in solution have been satisfactorily maintained within ± 20 % of the mean measured values.

DESCRIPTION OF THE METHOD**Apparatus**

13. Normal laboratory equipment and especially the following:
 - (a) oxygen and pH meters;
 - (b) equipment for determination of water hardness and alkalinity;
 - (c) adequate apparatus for temperature control and preferably continuous monitoring;
 - (d) tanks made of chemically inert material and of a suitable capacity in relation to the recommended loading and stocking density (see Appendix 2);
 - (e) spawning substrate for fathead minnow and zebrafish, Appendix 4 gives the necessary details;
 - (f) suitably accurate balance (i.e. accurate to $\pm 0,5$ mg).

▼ M6**Water**

14. Any water in which the test species shows suitable long-term survival and growth may be used as test water. It should be of constant quality during the period of the test. The pH of the water should be within the range 6,5 to 8,5, but during a given test it should be within a range of $\pm 0,5$ pH units. In order to ensure that the dilution water will not unduly influence the test result (for example by complexation of test chemical), samples should be taken at intervals for analysis. Measurements of heavy metals (e.g. Cu, Pb, Zn, Hg, Cd, and Ni), major anions and cations (e.g. Ca^{2+} , Mg^{2+} , Na^+ , K^+ , Cl^- , and SO_4^{2-}), pesticides (e.g. total organophosphorus and total organochlorine pesticides), total organic carbon and suspended solids should be made, for example, every three months where dilution water is known to be relatively constant in quality. If water quality has been demonstrated to be constant over at least one year, determinations can be less frequent and intervals extended (e.g. every six months). Some chemical characteristics of acceptable dilution water are listed in Appendix 3.

Test solutions

15. Test solutions of the chosen concentrations are prepared by dilution of a stock solution. The stock solution should preferably be prepared by simply mixing or agitating the test chemical in dilution water by using mechanical means (e.g. stirring or ultrasonication). Saturation columns (solubility columns) can be used for achieving a suitable concentrated stock solution. The use of a solvent carrier is not recommended. However, in case a solvent is necessary, a solvent control should be run in parallel, at the same solvent concentration as the chemical treatments. For difficult test chemicals, a solvent may be technically the best solution; the OECD Guidance Document on aquatic toxicity testing of difficult substances and mixtures should be consulted (22). The choice of solvent will be determined by the chemical properties of the chemical. The OECD Guidance Document recommends a maximum of 100 $\mu\text{l/l}$, which should be observed. However a recent review (23) highlighted additional concerns when using solvents for endocrine activity testing. Therefore it is recommended that the solvent concentration, if necessary, is minimised wherever technically feasible (dependent on the physical-chemical properties of the test chemical).
16. A flow-through test system will be used. Such a system continually dispenses and dilutes a stock solution of the test chemical (e.g. metering pump, proportional diluter, saturator system) in order to deliver a series of concentrations to the test chambers. The flow rates of stock solutions and dilution water should be checked at intervals, preferably daily, during the test and should not vary by more than 10 % throughout the test. Care should be taken to avoid the use of low-grade plastic tubing or other materials that may contain biologically active chemicals. When selecting the material for the flow-through system, possible adsorption of the test chemical to this material should be considered.

Holding of fish

17. Test fish should be selected from a laboratory population, preferably from a single stock, which has been acclimated for at least two weeks prior to the test under conditions of water quality and illumination similar to those used in the test. It is important that the loading rate and stocking density (for definitions, see Appendix 1) be appropriate for the test species used (see Appendix 2).
18. Following a 48-hour settling-in period, mortalities are recorded and the following criteria applied:

▼ M6

- mortalities of greater than 10 % of population in seven days: reject the entire batch;
 - mortalities of between 5 % and 10 % of population: acclimation for seven additional days; if more than 5 % mortality during second seven days, reject the entire batch;
 - mortalities of less than 5 % of population in seven days: accept the batch
19. Fish should not receive treatment for disease during the acclimation period, in the pre-exposure period, or during the exposure period.

Pre-exposure and selection of fish

20. A one-week pre-exposure period is recommended, with animals placed in vessels similar to the actual test. Fish should be fed *ad libitum* throughout the holding period and during the exposure phase. The exposure phase is started with sexually dimorphic adult fish from a laboratory supply of reproductively mature animals (e.g. with clear secondary sexual characteristics visible as far as fathead minnow and medaka are concerned), and actively spawning. For general guidance only (and not to be considered in isolation from observing the actual reproductive status of a given batch of fish), fathead minnows should be approximately 20 (± 2) weeks of age, assuming they have been cultured at 25 ± 2 °C throughout their lifespan. Japanese medaka should be approximately 16 (± 2) weeks of age, assuming they have been cultured at 25 ± 2 °C throughout their lifespan. Zebrafish should be approximately 16 (± 2) weeks of age, assuming they have been cultured at 26 ± 2 °C throughout their lifespan.

TEST DESIGN

21. Three concentrations of the test chemical, one control (water) and, if needed, one solvent control are used. The data may be analysed in order to determine statistically significant differences between treatment and control responses. These analyses will inform whether further longer term testing for adverse effects (namely, survival, development, growth and reproduction) is required for the chemical, rather than for use in risk assessment (24).
22. For zebrafish and medaka, on day 21 of the experiment, males and females from each treatment level (5 males and 5 females in each of the two replicates) and from the control(s) are sampled for the measurement of vitellogenin and secondary sex characteristics, where applicable. For fathead minnow, on day 21 of exposure, males and females (2 males and 4 females in each of the four replicates) and from the control(s) are sampled for the measurement of vitellogenin and secondary sex characteristics.

Selection of test concentrations

23. For the purposes of this test, the highest test concentration should be set by the maximum tolerated concentration (MTC) determined from a range finder or from other toxicity data, or 10 mg/l, or the maximum solubility in water, whichever is lowest. The MTC is defined as the highest test concentration of the chemical which results in less than 10 % mortality. Using this approach assumes that there are existing empirical acute toxicity data or other toxicity data from which the MTC can be estimated. Estimating the MTC can be inexact and typically requires some professional judgment.

▼ M6

24. Three test concentrations, spaced by a constant factor not exceeding 10, and a dilution-water control (and solvent control if necessary) are required. A range of spacing factors between 3,2 and 10 is recommended.

PROCEDURE**Selection and weighing of test fish**

25. It is important to minimise variation in weight of the fish at the beginning of the assay. Suitable size ranges for the different species recommended for use in this test are given in Appendix 2. For the whole batch of fish used in the test, the range in individual weights for male and female fish at the start of the test should be kept, if possible, within $\pm 20\%$ of the arithmetic mean weight of the same sex. It is recommended to weigh a subsample of the fish stock before the test in order to estimate the mean weight.

Conditions of exposure*Duration*

26. The test duration is 21 days, following a pre-exposure period. The recommended pre-exposure period is one week.

Feeding

27. Fish should be fed *ad libitum* with an appropriate food (Appendix 2) at a sufficient rate to maintain body condition. Care should be taken to avoid microbial growth and water turbidity. As a general guidance, the daily ration may be divided into two or three equal portions for multiple feeds per day, separated by at least three hours between each feed. A single larger ration is acceptable particularly for weekends. Food should be withheld from the fish for 12 hours prior to sampling/necropsy.
28. Fish food should be evaluated for the presence of contaminants such as organochlorine pesticides, polycyclic aromatic hydrocarbons (PAHs), polychlorinated biphenyls (PCBs). Food with an elevated level of phytoestrogens that would compromise the response of the assay to known oestrogen agonist (e.g. 17-beta estradiol) should be avoided.
29. Uneaten food and faecal material should be removed from the test vessels at least twice weekly, e.g. by carefully cleaning the bottom of each tank using a siphon.

Light and temperature

30. The photoperiod and water temperature should be appropriate for the test species (see Appendix 2).

Frequency of analytical determinations and measurements

31. Prior to initiation of the exposure period, proper function of the chemical delivery system should be ensured. All analytical methods needed should be established, including sufficient knowledge on the chemical stability in the test system. During the test, the concentrations of the test chemical are determined at regular intervals, as follows: the flow rates of diluent and toxicant stock solution should be checked preferably daily but as a minimum twice per week, and should not vary by more than 10 % throughout the test. It is recommended that the actual test chemical concentrations be measured in all vessels at the start of the test and at weekly intervals thereafter.
32. It is recommended that results be based on measured concentrations. However, if concentration of the test chemical in solution has been satisfactorily maintained within $\pm 20\%$ of the nominal concentration throughout the test, then the results can either be based on nominal or measured values.
33. Samples may need to be filtered (e.g., using a 0,45 μm pore size) or centrifuged. If needed, then centrifugation is the recommended procedure. However, if the test material does not adsorb to filters, filtration may also be acceptable.

▼ M6

34. During the test, dissolved oxygen, temperature, and pH should be measured in all test vessels at least once per week. Total hardness and alkalinity should be measured in the controls and one vessel at the highest concentration at least once per week. Temperature should preferably be monitored continuously in at least one test vessel.

Observations

35. A number of general (e.g. survival) and core biological responses (e.g. vitellogenin levels) are assessed over the course of the assay or at termination of the assay. Measurement and evaluation of these endpoints and their utility are described below.

Survival

36. Fish should be examined daily during the test period and any mortality should be recorded and the dead fish removed as soon as possible. Dead fish should not be replaced in either the control or treatment vessels. Sex of fish that die during the test should be determined by macroscopic evaluation of the gonads.

Behaviour and appearance

37. Any abnormal behaviour (relative to controls) should be noted; this might include signs of general toxicity including hyperventilation, uncoordinated swimming, loss of equilibrium, and atypical quiescence or feeding. Additionally external abnormalities (such as haemorrhage, discoloration) should be noted. Such signs of toxicity should be considered carefully during data interpretation since they may indicate concentrations at which biomarkers of endocrine activity are not reliable. Such behavioural observations may also provide useful qualitative information to inform potential future fish testing requirements. For example, territorial aggressiveness in normal males or masculinised females has been observed in fathead minnows under androgenic exposure; in zebrafish, the characteristic mating and spawning behaviour after the dawn onset of light is reduced or hindered by oestrogenic or anti-androgenic exposure.
38. Because some aspects of appearance (primarily colour) can change quickly with handling, it is important that qualitative observations be made prior to removal of animals from the test system. Experience to date with fathead minnows suggests that some endocrine active chemicals may initially induce changes in the following external characteristics: body colour (light or dark), coloration patterns (presence of vertical bands), and body shape (head and pectoral region). Therefore observations of physical appearance of the fish should be made over the course of the test, and at conclusion of the study

Humane killing of fish

39. At day 21, i.e. at termination of the exposure, the fish should be euthanized with appropriate amounts of Tricaine (Tricaine methane sulfonate, Metacain, MS-222 (CAS 886-86-2), 100-500 mg/l buffered with 300 mg/l NaHCO₃ (sodium bicarbonate, CAS 144-55-8) to reduce mucous membrane irritation; blood or tissue is then sampled for vitellogenin determination, as explained in the Vitellogenin section.

▼ M6*Observation of secondary sex characteristics*

40. Some endocrine active chemicals may induce changes in specialised secondary sex characteristics (number of nuptial tubercles in male fathead minnow, papillary processes in male medaka). Notably, chemicals with certain modes of action may cause abnormal occurrence of secondary sex characteristic in animals of the opposite sex; for example, androgen receptor agonists, such as trenbolone, methyltestosterone and dihydrotestosterone, can cause female fathead minnows to develop pronounced nuptial tubercles or female medaka to develop papillary processes (11, 20, 21). It also has been reported that oestrogen receptor agonists can decrease nuptial tubercle numbers and size of the dorsal nape pad in adult males (25, 26). Such gross morphological observations may provide useful qualitative and quantitative information to inform potential future fish testing requirements. The number and size of nuptial tubercles in fathead minnow and papillary processes in medaka can be quantified directly or more practically in preserved specimens. Recommended procedures for the evaluation of secondary sex characteristics in fathead minnow and medaka are available from Appendix 5A and Appendix 5B, respectively.

Vitellogenin (VTG)

41. Blood is collected from the caudal artery/vein with a heparinised microhaematocrit capillary tubule, or alternatively by cardiac puncture with a syringe. Depending upon the size of the fish, collectable blood volumes generally range from 5 to 60 µl per individual for fathead minnows and 5-15 µl per individual for zebrafish. Plasma is separated from the blood via centrifugation, and stored with protease inhibitors at – 80 °C, until analysed for vitellogenin. Alternatively, in medaka the liver will be used, and in zebrafish the head/tail homogenate can be used as tissue-source for vitellogenin determination (Appendix 6). The measurement of VTG should be based upon a validated homologous ELISA method, using homologous VTG standard and homologous antibodies. It is recommended to use a method capable to detect VTG levels as low as few ng/ml plasma (or ng/mg tissue), which is the background level in unexposed male fish.

42. Quality control of vitellogenin analysis will be accomplished through the use of standards, blanks and at least duplicate analyses. For each ELISA method, a test for matrix effect (effect of sample dilution) should be run to determine the minimum sample dilution factor. Each ELISA plate used for VTG assays should include the following quality control samples: at least 6 calibration standards covering the range of expected vitellogenin concentrations, and at least one non-specific binding assay blank (analysed in duplicate). Absorbance of these blanks should be less than 5 % of the maximum calibration standard absorbance. At least two aliquots (well-duplicates) of each sample dilution will be analysed. Well-duplicates that differ by more than 20 % should be re-analysed.

43. The correlation coefficient (R^2) for calibration curves should be greater than 0,99. However, a high correlation is not sufficient to guarantee adequate prediction of concentration in all ranges. In addition to having a sufficiently high correlation for the calibration curve, the concentration of each standard, as calculated from the calibration curve, should all fall between 70 and 120 % of its nominal concentration. If the nominal concentrations trend away from the calibration regression line (e.g. at lower concentrations), it may be necessary to split the calibration curve into low and

▼ M6

high ranges or to use a nonlinear model to adequately fit the absorbance data. If the curve is split, both line segments should have $R^2 > 0,99$.

44. The limit of detection (LOD) is defined as the concentration of the lowest analytical standard, and limit of quantitation (LOQ) is defined as the concentration of the lowest analytical standard multiplied by the lowest dilution factor.
45. On each day that vitellogenin assays are performed, a fortification sample made using an inter-assay reference standard will be analysed (Appendix 7). The ratio of the expected concentration to the measured concentration will be reported along with the results from each set of assays performed on that day.

DATA AND REPORTING**Evaluation of Biomarker Responses by Analysis of Variance (ANOVA)**

46. To identify potential endocrine activity of a chemical, responses are compared between treatments and control groups using analysis of variance (ANOVA). Where a solvent control is used, an appropriate statistical test should be performed between the dilution water and solvent controls for each endpoint. Guidance on how to handle dilution water and solvent control data in the subsequent statistical analysis can be found in OECD, 2006c (27). All biological response data should be analysed and reported separately by sex. If the required assumptions for parametric methods are not met — non-normal distribution (e.g. Shapiro-Wilk's test) or heterogeneous variance (Bartlett's test or Levene's test), consideration should be given to transforming the data to homogenise variances prior to performing the ANOVA, or to carrying out a weighted ANOVA. Dunnett's test (parametric) on multiple pair-wise comparisons or a Mann-Whitney with Bonferroni adjustment (non-parametric) may be used for non-monotonous dose-response. Other statistical tests may be used (e.g. Jonckheere-Terpstra test or Williams test) if the dose-response is approximately monotone. A statistical flowchart is provided in Appendix 8 to help in the decision on the most appropriate statistical test to be used. Additional information can also be obtained from the OECD Document on Current Approaches to Statistical Analysis of Ecotoxicity Data (27).

Reporting of test results

47. Study data should include:

Testing facility:

- Responsible personnel and their study responsibilities
- Each laboratory should have demonstrated proficiency using a range of representative chemicals

Test chemical:

- Characterisation of test chemical
- Physical nature and relevant physicochemical properties

▼ M6

- Method and frequency of preparation of test concentrations
- Information on stability and biodegradability

Solvent:

- Characterization of solvent (nature, concentration used)
- Justification of choice of solvent (if other than water)

Test animals:

- Species and strain
- Supplier and specific supplier facility
- Age of the fish at the start of the test and reproductive/spawning status
- Details of animal acclimation procedure
- Body weight of the fish at the start of the exposure (from a sub-sample of the fish stock)

Test Conditions:

- Test procedure used (test-type, loading rate, stocking density, etc.);
- Method of preparation of stock solutions and flow-rate;
- The nominal test concentrations, weekly measured concentrations of the test solutions and analytical method used, means of the measured values and standard deviations in the test vessels and evidence that the measurements refer to the concentrations of the test chemical in true solution;
- Dilution water characteristics (including pH, hardness, alkalinity, temperature, dissolved oxygen concentration, residual chlorine levels, total organic carbon, suspended solids and any other measurements made)
- Water quality within test vessels: pH, hardness, temperature and dissolved oxygen concentration;
- Detailed information on feeding (e.g. type of food(s), source, amount given and frequency and analyses for relevant contaminants if available (e.g. PCBs, PAHs and organochlorine pesticides).

Results

- Evidence that the controls met the acceptance criteria of the test;
- Data on mortalities occurring in any of the test concentrations and control;
- Statistical analytical techniques used, treatment of data and justification of techniques used;
- Data on biological observations of gross morphology, including secondary sex characteristics and vitellogenin;

▼ M6

- Results of the data analyses preferably in tabular and graphical form;

- Incidence of any unusual reactions by the fish and any visible effects produced by the test chemical

GUIDANCE FOR THE INTERPRETATION AND ACCEPTANCE OF THE TEST RESULTS

48. This section contains a few considerations to be taken into account in the interpretation of test results for the various endpoints measured. The results should be interpreted with caution where the test chemical appears to cause overt toxicity or to impact on the general condition of the test animal.

49. In setting the range of test concentrations, care should be taken not to exceed the maximum tolerated concentration to allow a meaningful interpretation of the data. It is important to have at least one treatment where there are no signs of toxic effects. Signs of disease and signs of toxic effects should be thoroughly assessed and reported. For example, it is possible that production of VTG in females can also be affected by general toxicity and non-endocrine toxic modes of action, e.g. hepatotoxicity. However, interpretation of effects may be strengthened by other treatment levels that are not confounded by systemic toxicity.

50. There are a few aspects to consider for the acceptance of test results. As a guide, the VTG levels in control groups of males and females should be distinct and separated by about three orders of magnitude in fathead minnow and zebrafish, and about one order of magnitude for medaka. Examples of the range of values encountered in control and treatment groups are available in the validation reports (1, 2, 3, 4). High VTG values in control males could compromise the responsiveness of the assay and its ability to detect weak oestrogen agonists. Low VTG values in control females could compromise the responsiveness of the assay and its ability to detect aromatase inhibitors and oestrogen antagonists. The validation studies were used to build that guidance.

51. If a laboratory has not performed the assay before or substantial changes (e.g. change of fish strain or supplier) have been made it is advisable that a technical proficiency study is conducted. It is recommended that chemicals covering a range of modes of action or impacts on a number of the test endpoints are used. In practice, each laboratory is encouraged to build its own historical control data for males and females and to perform a positive control chemical for estrogenic activity (e.g. 17 β -estradiol at 100 ng/l, or a known weak agonist) resulting in increased VTG in male fish, a positive control chemical for aromatase inhibition (e.g. fadrozole or prochloraz at 300 μ g/l) resulting in decreased VTG in female fish, and a positive control chemical for androgenic activity (e.g. 17 β -trenbolone at 5 μ g/l) resulting in induction of secondary sex characteristics in female fathead minnow and medaka. All these data can be compared to available data from the validation studies (1, 2, 3) to ensure laboratory proficiency.

52. In general, vitellogenin measurements should be considered positive if there is a statistically significant increase in VTG in males ($p < 0,05$), or a statistically significant decrease in females ($p < 0,05$) at least at the highest dose tested compared to the control group, and in the absence of signs of general toxicity. A positive result is further supported by the demonstration of a biologically plausible relationship between the dose and the response curve. As mentioned earlier, the vitellogenin decrease may not entirely be of endocrine origin; however a positive result should generally be interpreted as evidence of endocrine activity *in vivo*, and should normally initiate actions for further clarification.

▼ M6

LITERATURE

- (1) OECD (2006a). Report of the Initial Work Towards the Validation of the 21-Day Fish Screening Assay for the Detection of Endocrine active Substances (Phase 1A). OECD Environmental Health and Safety Publications Series on Testing and Assessment No.60, ENV/JM/MONO(2006)27.
- (2) OECD (2006b). Report of the Initial Work Towards the Validation of the 21-Day Fish Screening Assay for the Detection of Endocrine active Substances (Phase 1B). OECD Environmental Health and Safety Publications Series on Testing and Assessment No.61, ENV/JM/MONO(2006)29.
- (3) OECD (2007). Final report of the Validation of the 21-day Fish Screening Assay for the Detection of Endocrine Active Substances. Phase 2: Testing Negative Substances. OECD Environmental Health and Safety Publications Series on Testing and Assessment No.78, ENV/JM/MONO(2007)25.
- (4) Owens JW (2007). Phase 3 report of the validation of the OECD Fish Screening Assay. CEFIC LRI Project, Endocrine. <http://www.cefic-lri.org/index.php?page=projects> (accessed 18/09/08).
- (5) US EPA 2007. Validation of the Fish Short-Term Reproduction Assay: Integrated Summary Report. Unpublished report dated 15 December 2007. US Environmental Protection Agency, Washington, DC. 104 pp.
- (6) OECD, 2008. Report of the Validation Peer Review for the 21-Day Fish Endocrine Screening Assay and Agreement of the Working Group of the National Coordinators of the Test Guidelines Programme on the Follow-up of this Report. OECD Environmental Health and Safety Publications Series on Testing and Assessment No.94, ENV/JM/MONO(2008)21.
- (7) Sumpter and Jobling (1995). Vitellogenesis as a biomarker for estrogenic contamination of the aquatic environment. *Environmental Health Perspectives*;103 Suppl 7:173-8 Review.
- (8) Pawlowski S, Sauer A, Shears JA, Tyler CR, Braunbeck T (2004). Androgen and estrogenic effects of the synthetic 17alpha-methyltestosterone on sexual development and reproductive performance in the fathead minnow (*Pimephales promelas*) determined using the gonadal recrudescence assay. *Aquatic Toxicology*; 68(3):277-91.
- (9) Andersen L, Goto-Kazato R, Trant JM, Nash JP, Korsgaard B, Bjerregaard P (2006). Short-term exposure to low concentrations of the synthetic androgen methyltestosterone affects vitellogenin and steroid levels in adult male zebrafish (*Danio rerio*). *Aquatic Toxicology*; 76(3-4):343-52.
- (10) Ankley GT, Kahl MD, Jensen KM, Hornung MW, Korte JJ, Makynen EA, Leino RL (2002). Evaluation of the aromatase inhibitor fadrozole in a short-term reproduction assay with the fathead minnow (*Pimephales promelas*). *Toxicological Sciences*;67(1):121-30.
- (11) Panter GH, Hutchinson TH, Hurd KS, Sherren A, Stanley RD, Tyler CR (2004). Successful detection of (anti-)androgenic and aromatase inhibitors in pre-spawning adult fathead minnows (*Pimephales promelas*) using easily measured endpoints of sexual development. *Aquatic Toxicology*; 70(1):11-21.
- (12) Parks LG, Cheek AO, Denslow ND, Heppell SA, McLachlan JA, LeBlanc GA, Sullivan CV (1999). Fathead minnow (*Pimephales promelas*) vitellogenin: purification, characterization and quantitative immunoassay for the detection of estrogenic compounds. *Comparative Biochemistry and Physiology. Part C Pharmacology, toxicology and endocrinology*; 123(2):113-25.

▼ **M6**

- (13) Panter GH, Tyler CR, Maddix S, Campbell PM, Hutchinson TH, Länge R, Lye C, Sumpter JP, 1999. Application of an ELISA to quantify vitellogenin concentrations in fathead minnows (*Pimephales promelas*) exposed to endocrine disrupting chemicals. CEFIC-EMSG research report reference AQ001. CEFIC, Brussels, Belgium.
- (14) Fenske M., van Aerle, R.B., Brack, S.C., Tyler, C.R., Segner, H., (2001). Development and validation of a homologous zebrafish (*Danio rerio* Hamilton- Buchanan) vitellogenin enzyme-linked immunosorbent assay (ELISA) and its application for studies on estrogenic chemicals. *Comp. Biochem. Phys. C* 129 (3): 217-232.
- (15) Holbech H, Andersen L, Petersen GI, Korsgaard B, Pedersen KL, Bjerregaard P. (2001). Development of an ELISA for vitellogenin in whole body homogenate of zebrafish (*Danio rerio*). *Comparative Biochemistry and Physiology. Part C Pharmacology, toxicology and endocrinology*; 130: 119-131
- (16) Rose J, Holbech H, Lindholst C, Noerum U, Povlsen A, Korsgaard B, Bjerregaard P. 2002. Vitellogenin induction by 17 β -estradiol and 17 β -ethinylestradiol in male zebrafish (*Danio rerio*). *Comp. Biochem. Physiol. C*. 131: 531-539.
- (17) Brion F, Nilsen BM, Eidem JK, Goksoyr A, Porcher JM, Development and validation of an enzyme-linked immunosorbent assay to measure vitellogenin in the zebrafish (*Danio rerio*). *Environmental Toxicology and Chemistry*; vol 21: 1699-1708.
- (18) Yokota H, Morita H, Nakano N, Kang JJ, Tadokoro H, Oshima Y, Honjo T, Kobayashi K. 2001. Development of an ELISA for determination of the hepatic vitellogenin in Medaka (*Oryzias latipes*). *Jpn J Environ Toxicol* 4:87-98.
- (19) Tatarazako N, Koshio M, Hori H, Morita M and Iguchi T., 2004. Validation of an enzyme-linked immunosorbent assay method for vitellogenin in the Medaka. *Journal of Health Science* 50:301-308.
- (20) Ankley GT, Jensen KM, Makynen EA, Kahl MD, Korte JJ, Homung MW, Henry TR, Denny JS, Leino RL, Wilson VS, Cardon MC, Hartig PC, Gray LE (2003). Effects of the androgenic growth promoter 17-beta-trenbolone on fecundity and reproductive endocrinology of the fathead minnow. *Environmental Toxicology and Chemistry*; 22(6): 1350-60.
- (21) Seki M, Yokota H, Matsubara H, Maeda M, Tadokoro H, Kobayashi K (2004). Fish full life-cycle testing for androgen methyltestosterone on medaka (*Oryzias latipes*). *Environmental Toxicology and Chemistry*; 23(3):774-81.
- (22) OECD (2000) Guidance Document on Aquatic Toxicity Testing of Difficult Substances and Mixtures. Environmental Health and Safety Publications. Series on Testing and Assessment. No. 23. Paris
- (23) Hutchinson TH, Shillabeer N, Winter MJ, Pickford DB, 2006a. Acute and chronic effects of carrier solvents in aquatic organisms: A critical review. *Review. Aquatic Toxicology*, 76; pp.69-92.
- (24) Hutchinson TH, Ankley GT, Segner H, Tyler CR, 2006b. Screening and testing for endocrine disruption in fish-biomarkers as 'signposts', not 'traffic lights', in risk assessment. *Environmental Health Perspectives*; 114 Suppl 1:106-14.
- (25) Miles-Richardson, SR, Kramer VJ, Fitzgerald SD, Render JA, Yamini B, Barbee SJ, Giesy JP. 1999. Effects of waterborne exposure to 17 β -estradiol on secondary sex characteristics and gonads of the fathead minnow (*Pimephales promelas*). *Aquat. Toxicol.* 47, 129-145.

▼ M6

- (26) Martinovic, D., L.S. Blake, E.J. Durhan, K.J. Greene, M.D. Kahl, K.M., Jensen, E.A. Makynen, D.L. Villeneuve and G.T. Ankley. 2008. Characterization of reproductive toxicity of vinclozolin in the fathead minnow and co-treatment with an androgen to confirm an anti-androgenic mode of action. *Environ. Toxicol. Chem.* 27, 478-488.
- (27) OECD (2006c). *Current Approaches in the Statistical Analysis of Ecotoxicity Data: A Guidance to Application*. OECD environmental Health and Safety Publications Series on Testing and Assessment No.54. ENV/JM/MONO(2006)18
- (28) OECD (2012) *OECD Conceptual Framework for Testing and Assessment of Endocrine Disrupters (revised). Annex I to Draft Guidance Document on Standardised Test Guidelines for Evaluating Chemicals for Endocrine Disruption*. Series on Testing and Assessment No 150. ENV/JM/MONO(2012)22

▼M6*Appendix 1***Abbreviations & definitions**

Chemical: A substance or a mixture

CV: Coefficient of variation.

ELISA: Enzyme-Linked Immunosorbent Assay.

Loading rate: Wet weight of fish per volume of water.

Stocking density: Number of fish per volume of water.

VTG (Vitellogenin): Phospholipoglycoprotein precursor to egg yolk protein that normally occurs in sexually active females of all oviparous species.

HPG axis: Hypothalamic-pituitary-gonadal axis.

MTC: Maximum Tolerated Concentration, representing about 10 % of the LC₅₀.

Test chemical: Any substance or mixture tested using this test method.

▼ **M6**

Appendix 2

Experimental conditions for the fish endocrine screening assay

1. Recommended species	Fathead minnow (<i>Pimephales promelas</i>)	Medaka (<i>Oryzias latipes</i>)	Zebrafish (<i>Danio rerio</i>)
2. Test type	Flow-through	Flow-through	Flow-through
3. Water temperature	25 ± 2 °C	25 ± 2 °C	26 ± 2 °C
4. Illumination quality	Fluorescent bulbs (wide spectrum)	Fluorescent bulbs (wide spectrum)	Fluorescent bulbs (wide spectrum)
5. Light intensity	10-20 µE/m ² /s, 540-1 000 lux, or 50-100 ft-c (ambient laboratory levels)	10-20 µE/m ² /s, 540-1 000 lux, or 50-100 ft-c (ambient laboratory levels)	10-20 µE/m ² /s, 540-1 000 lux, or 50-100 ft-c (ambient laboratory levels)
6. Photoperiod (dawn/dusk transitions are optional, however not considered necessary)	16 h light, 8 h dark	12-16 h light, 12-8 h dark	12-16 h light, 12-8 h dark
7. Loading rate	< 5 g per l	< 5 g per l	< 5 g per l
8. Test chamber size	10 l (minimum)	2 l (minimum)	5 l (minimum)
9. Test solution volume	8 l (minimum)	1.5 l (minimum)	4 l (minimum)
10. Volume exchanges of test solutions	Minimum of 6 daily	Minimum of 5 daily	Minimum of 5 daily
11. Age of test organisms	See paragraph 20	See paragraph 20	See paragraph 20
12. Approximate wet weight of adult fish (g)	Females: 1,5 ± 20 % Males: 2,5 ± 20 %	Females: 0,35 ± 20 % Males: 0,35 ± 20 %	Females: 0,65 ± 20 % Males: 0,4 ± 20 %
13. No. of fish per test vessel	6 (2 males and 4 females)	10 (5 males and 5 females)	10 (5 males and 5 females)
14. No. of treatments	= 3 (plus appropriate controls)	= 3 (plus appropriate controls)	= 3 (plus appropriate controls)
15. No. vessels per treatment	4 minimum	2 minimum	2 minimum
16. No. of fish per test concentration	16 adult females and 8 males (4 females and 2 males in each replicate vessel)	10 adult females and 10 males (5 females and 5 males in each replicate vessel)	10 adult females and 10 males (5 females and 5 males in each replicate vessel)
17. Feeding regime	Live or frozen adult or nauplii brine shrimp two or three times daily (ad libitum), commercially available food or a combination of the above	Brine shrimp nauplii two or three times daily (ad libitum), commercially available food or a combination of the above	Brine shrimp nauplii two or three times daily (ad libitum), commercially available food or a combination of the above

▼ **M6**

18. Aeration	None unless DO concentration falls below 60 % air saturation	None unless DO concentration falls below 60 % air saturation	None unless DO concentration falls below 60 % air saturation
19. Dilution water	Clean surface, well or reconstituted water or dechlorinated tap water	Clean surface, well or reconstituted water or dechlorinated tap water	Clean surface, well or reconstituted water or dechlorinated tap water
20. Pre-exposure period	7 days recommended	7 days recommended	7 days recommended
21. Chemical exposure duration	21 d	21 d	21 d
22. Biological endpoints	survival behaviour 2y sex characteristics VTG	survival behaviour 2y sex characteristics VTG	survival behaviour VTG
23. Test acceptability	Dissolved oxygen > 60 % of saturation; mean temperature of 25 ± 2 °C; 90 % survival of fish in the controls; measured test concentrations within 20 % of mean measured values per treatment level.	Dissolved oxygen > 60 % of saturation; mean temperature of 24 ± 2 °C; 90 % survival of fish in the controls; measured test concentrations within 20 % of mean measured values per treatment level.	Dissolved oxygen > 60 % of saturation; mean temperature of 26 ± 2 °C; 90 % survival of fish in the controls; measured test concentrations within 20 % of mean measured values per treatment level.

▼ M6*Appendix 3***Some chemical characteristics of acceptable dilution water**

Component	Concentrations
Particulate matter	< 20 mg/l
Total organic carbon	< 2 mg/l
Unionised ammonia	< 1 µg/l
Residual chlorine	< 10 µg/l
Total organophosphorus pesticides	< 50 ng/l
Total organochlorine pesticides plus polychlorinated biphenyls	< 50 ng/l
Total organic chlorine	< 25 ng/l

▼ **M6***Appendix 4A***Spawning substrate for zebrafish**

Spawning tray: all glass instrument dish, for example $22 \times 15 \times 5,5$ cm ($l \times w \times d$), covered with a removable stainless steel wire lattice (mesh width 2 mm). The lattice should cover the opening of the instrument dish at a level below the brim.

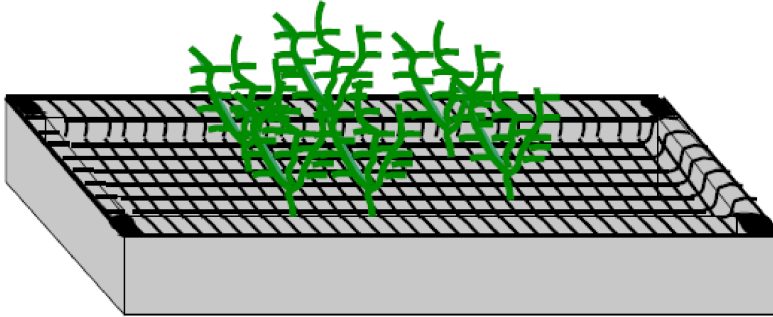

On the lattice, spawning substrate should be fixed. It should provide structure for the fish to move into. For example, artificial aquaria plants made of green plastic material are suitable (NB: possible adsorption of the test chemical to the plastic material should be considered). The plastic material should be leached out in sufficient volume of warm water for sufficient time to ensure that no chemicals may be disposed to the test water. When using glass materials it should be ensured that the fish are neither injured nor cramped during their vigorous actions.

The distance between the tray and the glass panes should be at least 3 cm to ensure that the spawning is not performed outside the tray. The eggs spawned onto the tray fall through the lattice and can be sampled 45-60 min after the start of illumination. The transparent eggs are non-adhesive and can easily be counted by using transversal light. When using five females per vessel, egg numbers up to 20 at a day can be regarded as low, up to 100 as medium and more than 100 as high numbers. The spawning tray should be removed, the eggs collected and the spawning tray re-introduced in the test vessel, either as late as possible in the evening or very early in the morning. The time until re-introduction should not exceed one hour since otherwise the cue of the spawning substrate may induce individual mating and spawning at an unusual time. If a situation needs a later introduction of the spawning tray, this should be done at least 9 hours after start of the illumination. At this late time of the day, spawning is not induced any longer.

▼ M6*Appendix 4B***Spawning substrate for fathead minnow**

Two or three combined plastic/ceramic/glass or stainless steel spawning tiles and trays are placed in each of the test chamber (e.g., 80 mm length of grey semi-circular guttering sitting on a lipped tray of 130mm length) (see picture). Properly seasoned PVC or ceramic tiles have demonstrated to be appropriate for a spawning substrate (Thorpe *et al*, 2007).

It is recommended that the tiles are abraded to improve adhesion. The tray should also be screened to prevent fish from access to the fallen eggs unless the egg adhesion efficiency has been demonstrated for the spawning substrate used.

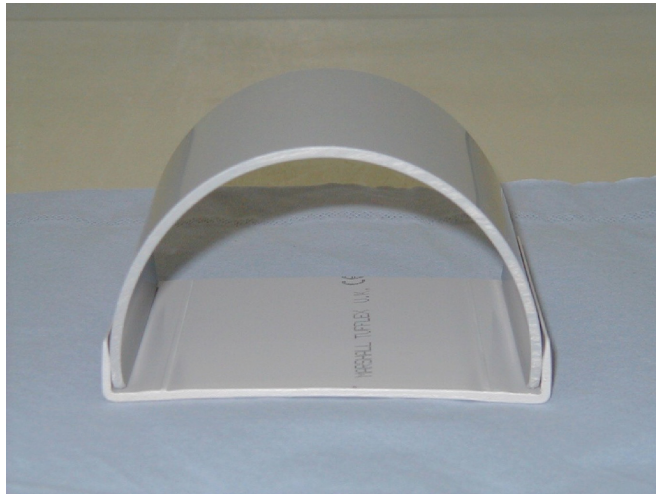

The base is designed to contain any eggs that do not adhere to the tile surface and would therefore fall to the bottom of the tank (or those eggs laid directly onto the flat plastic base). All spawning substrates should be leached for a minimum of 12 hours, in dilution water, before use.

REFERENCES

Thorpe KL, Benstead R, Hutchinson TH, Tyler CR, 2007. An optimised experimental test procedure for measuring chemical effects on reproduction in the fathead minnow, *Pimephales promelas*. *Aquatic Toxicology*, 81, 90–98.

▼ M6*Appendix 5A***Assessment of secondary sex characteristics in fathead minnow for the detection of certain endocrine active chemicals****Overview**

Potentially important characteristics of physical appearance in adult fathead minnows in endocrine disrupter testing include body colour (i.e. light/dark), coloration patterns (i.e. presence or absence of vertical bands), body shape (i.e. shape of head and pectoral region, distension of abdomen), and specialized secondary sex characteristics (i.e. number and size of nuptial tubercles, size of dorsal pad and ovipositor).

Nuptial tubercles are located on the head (dorsal pad) of reproductively-active male fathead minnows, and are usually arranged in a bilaterally-symmetric pattern (Jensen et al. 2001). Control females and juvenile males and females exhibit no tubercle development (Jensen et al. 2001). There can be up to eight individual tubercles around the eyes and between the nares of the males. The greatest numbers and largest tubercles are located in two parallel lines immediately below the nares and above the mouth. In many fish there are groups of tubercles below the lower jaw; those closest to the mouth generally occur as a single pair, while the more ventral set can be comprised of up to four tubercles. The actual numbers of tubercles is seldom more than 30 (range, 18-28; Jensen et al. 2001). The predominant tubercles (in terms of numbers) are present as a single, relatively round structure, with the height approximately equivalent to the radius. Most reproductively-active males also have, at least some, tubercles which are enlarged and pronounced such that they are indistinguishable as individual structures.

Some types of endocrine-disrupting chemicals can cause the abnormal occurrence of certain secondary sex characteristics in the opposite sex; for example, androgen receptor agonists, such as 17 β -methyltestosterone or 17 β -trenbolone, can cause female fathead minnows to develop nuptial tubercles (Smith 1974; Ankley *et al.* 2001; 2003), while oestrogen receptor agonists may decrease number or size of nuptial tubercles in males (Miles-Richardson et al. 1999; Harries et al. 2000).

Below is a description of the characterization of nuptial tubercles in fathead minnows based on procedures used at the U.S. Environmental Protection Agency lab in Duluth, MN. Specific products and/or equipment can be substituted with comparable materials available.

Viewing is best accomplished using an illuminated magnifying glass or 3X illuminated dissection scope. View fish dorsally and anterior forward (head toward viewer).

- a) Place fish in small Petri dish (e.g., 100 mm in diameter), anterior forward, and ventral down. Focus viewfinder to allow identification of tubercles. Gently and slowly roll fish from side to side to identify tubercle areas. Count and score tubercles.
- b) Repeat the observation on the ventral head surface by placing the fish dorsal anterior forward in the Petri dish.
- c) Observations should be completed within 2 min for each fish.

▼ **M6****Tubercle Counting and Rating**

Six specific areas have been identified for assessment of tubercle presence and development in adult fathead minnows. A template was developed to map the location and quantity of tubercles present (see end of this Appendix). The number of tubercles is recorded and their size can be quantitatively ranked as: 0- absence, 1-present, 2-enlarged and 3-pronounced for each organism (Fig. 1).

Rate 0- absence of any tubercle. Rating 1-present, is identified as any tubercle having a single point whose height is nearly equivalent to its radius (diameter). Rating 2- enlarged, is identified by tissue resembling an asterisk in appearance, usually having a large radial base with grooves or furrows emerging from the centre. Tubercle height is often more jagged but can be somewhat rounded at times. Rating 3- pronounced, is usually quite large and rounded with less definition in structure. At times these tubercles will run together forming a single mass along an individual or combination of areas (B, C and D, described below). Coloration and design are similar to rating 2 but at times are fairly indiscriminate. Using this rating system generally will result in overall tubercle scores of < 50 in a normal control male possessing a tubercle count of 18 to 20 (Jensen et al. 2001).

Figure 1

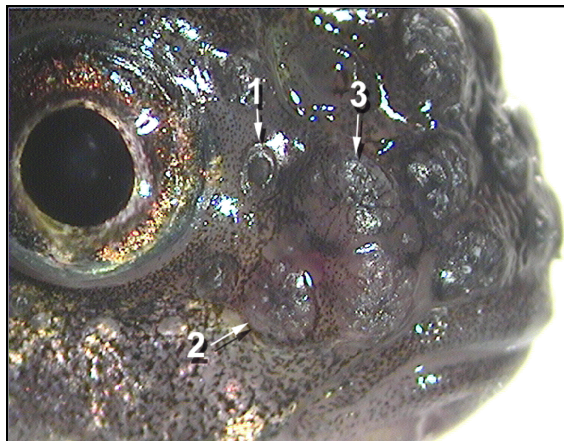

The actual number of tubercles in some fish may be greater than the template boxes (Appendix A) for a particular rating area. If this happens, additional rating numbers may be marked within, to the right or to the left of the box. The template therefore does not need to display symmetry. An additional technique for mapping tubercles which are paired or joined vertically along the horizontal plane of the mouth could be done by double-marking two tubercle rating points in a single box.

Mapping regions:

A — Tubercles located around eye. Mapped dorsal to ventral around anterior rim of eye. Commonly multiple in mature control males, not present in control females, generally paired (one near each eye) or single in females exposed to androgens.

B — Tubercles located between nares, (sensory canal pores). Normally in pairs for control males at more elevated levels (2- enlarged or 3- pronounced) of development. Not present in control females with some occurrence and development in females exposed to androgens.

C — Tubercles located immediately anterior to nares, parallel to mouth. Generally enlarged or pronounced in mature control males. Present or enlarged in less developed males or androgen-treated females.

▼ **M6**

D — Tubercles located parallel along mouth line. Generally rated developed in control males. Absent in control females but present in androgen-exposed females.

E — Tubercles located on lower jaw, close to mouth, usually small and commonly in pairs. Varying in control or treated males, and treated females.

F — Tubercles located ventral to E. Commonly small and paired. Present in control males and androgen-exposed females.

REFERENCES

- (1) Ankley GT, Jensen KM, Kahl MD, Korte JJ, Makynen ME. 2001. Description and evaluation of a short-term reproduction test with the fathead minnow (*Pimephales promelas*). *Environ Toxicol Chem* 20:1276-1290.
- (2) Ankley GT, Jensen KM, Makynen EA, Kahl MD, Korte JJ, Hornung MW, Henry TR, Denny JS, Leino RL, Wilson VS, Cardon MC, Hartig PC, Gray EL. 2003. Effects of the androgenic growth promoter 17- β trenbolone on fecundity and reproductive endocrinology of the fathead minnow. *Environ Toxicol Chem* 22:1350-1360.
- (3) Harries JE, Runnalls T, Hill E, Harris CA, Maddix S, Sumpter JP, Tyler CR. 2000. Development of a reproductive performance test for endocrine disrupting chemicals using pair-breeding fathead minnows (*Pimephales promelas*). *Environ Sci Technol* 34:3003-3011.
- (4) Jensen KM, Korte JJ, Kahl MD, Pasha MS, Ankley GT. 2001. Aspects of basic reproductive biology and endocrinology in the fathead minnow (*Pimephales promelas*). *Comp Biochem Physiol C* 128:127-141.
- (5) Kahl MD, Jensen KM, Korte JJ, Ankley GT. 2001. Effects of handling on endocrinology and reproductive performance of the fathead minnow. *J Fish Biol* 59:515-523.
- (6) Miles-Richardson SR, Kramer VJ, Fitzgerald SD, Render JA, Yamini B, Barbee SJ, Giesy JP. 1999. Effects of waterborne exposure of 17-estradiol on secondary sex characteristics and gonads of fathead minnows (*Pimephales promelas*). *Aquat Toxicol* 47:129-145.
- (7) Smith R.J.F. 1974. Effects of 17-methyltestosterone on the dorsal pad and tubercles of fathead minnows (*Pimephales promelas*). *Can J Zool* 52:1031-1038.

Tubercle Template	Numerical Rating
ID _____	1-present
Date _____	2-enlarged
Total Score _____	3-pronounced

	A	X1	X1	X1	X1
--	----------	-----------	-----------	-----------	-----------

	B	X1	X1	X1	X1
--	----------	-----------	-----------	-----------	-----------

	C	X1	X1	X1	X1	X1	X1	X1	X1	X1	X1
	D	X1	X1	X1	X1	X1	X1	X1	X1	X1	X1

		E	X1	X1	
	F	X1	X1	X1	X1

▼ M6*Appendix 5B***Assessment of secondary sex characteristics in medaka for the detection of certain endocrine active chemicals**

Below is a description of the measurement of papillary processes (*), which are the secondary sex characteristics in medaka (*Oryzias latipes*).

(*) Papillary processes normally appear only in adult males and are found on fin rays from the second to the seventh or eighth counting from the posterior end of the anal fin (Fig.1 and 2). However, processes rarely appear on the first fin ray from the posterior end of the anal fin. This SOP covers the measurement of processes on the first fin ray (the fin ray number refers to the order from the posterior end of the anal fin in this SOP).

- (1) After the excision of the liver (Appendix 6), the carcass is placed into a conical tube containing about 10 ml of 10 % neutral buffered formalin (upside: head, downside: tail). If the gonad is fixed in a solution other than 10 % neutral buffered formalin, make a transverse cut across the carcass between anterior region of anal fin and anus using razor, taking care not to harm the gonopore and gonad itself (Fig. 3). Place the cranial side of the fish body into the fixative solution to preserve the gonad, and the tail side of the fish body into the 10 % neutral buffered formalin as described above.
- (2) After placing the fish body into 10 % neutral buffered formalin, grasp the anterior region of the anal fin with tweezers and fold it for about 30 seconds to keep the anal fin open. When grasping the anal fin with tweezers, grasp a few fin rays in the anterior region with care not to scratch the papillary processes.
- (3) After keeping the anal fin open for about 30 seconds, store the fish body in 10 % neutral buffered formalin at room temperature until the measurement of the papillary processes (measurement should be conducted after fixing for at least 24 hours).

Measurement

- (1) After fixing the fish body in the 10 % neutral buffered formalin for at least 24 hours, pick up the fish carcass from the conical tube and wipe the formalin on the filter paper (or paper towel).
- (2) Place the fish abdomen side up. Then cut the anal fin using small dissection scissors carefully (it is preferable to cut the anal fin with small amount of pterygiophore).
- (3) Grasp the anterior region of the severed anal fin with tweezers and put it on a glass slide with a several drops of water. Then cover the anal fin with a cover glass. Be careful not to scratch the papillary processes when grasping the anal fin with tweezers.
- (4) Count the number of the joint plate with papillary processes using the counter under a biological microscope (upright microscope or inverted microscope). The papillary processes are recognized when a small formation of processes is visible on the posterior margin of joint plate.

▼ **M6**

Write the number of joint plate with papillary processes in each fin ray to the worksheet (e.g. first fin ray: 0, second fin ray: 10, third fin ray: 12, etc.) and enter the sum of this number on the Excel spreadsheet by individual fish. If necessary, take a photograph of the anal fin and count the number of joint plate with papillary processes on the photograph.

- (5) After the measurement, put the anal fin into the conical tube described in (1) and store it.

Fig.1.

Diagram showing sexual difference in shape and size of the anal fin. A, male; B, female. Oka, T. B., 1931. On the processes on the fin rays of the male of *Oryzias latipes* and other sex characters of this fish. J. Fac. Sci., Tokyo Univ., IV, 2: 209-218.

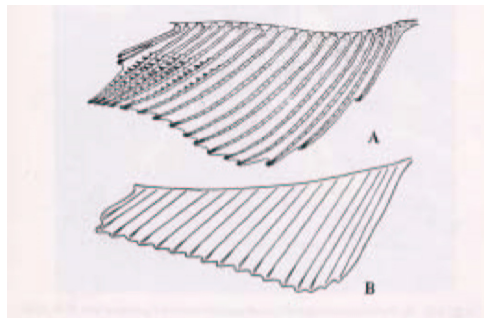
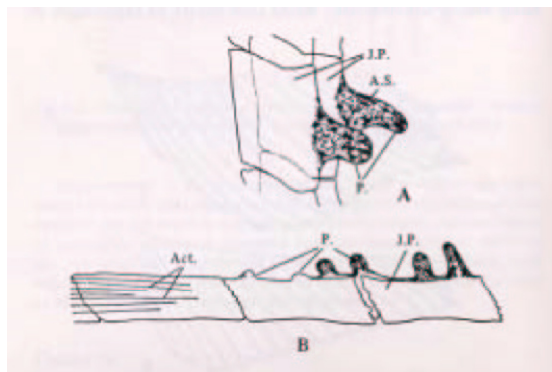

Fig.2.A.

Processes on joint plates of anal fin-ray. J.P., joint plate; A.S., axial space; P., process. B, Distal extremity of fin-ray. Actinotrichia (Act.) are on the tip. Oka, T. B., 1931. On the processes on the fin rays of the male of *Oryzias latipes* and other sex characters of this fish. J. Fac. Sci., Tokyo Univ., IV, 2: 209-218.



▼M6*Fig.3.*

Photograph of fish body showing the cut site when the gonad is fixed in the fixing solution other than 10 % neutral buffered formalin. In that case, the remaining body will be cut off between anterior region of anal fin and anal using razor (red bar), and the head side of fish body will be put into the fixing solution for gonad and the tail side of the fish body will be put into the 10 % neutral buffered formalin.

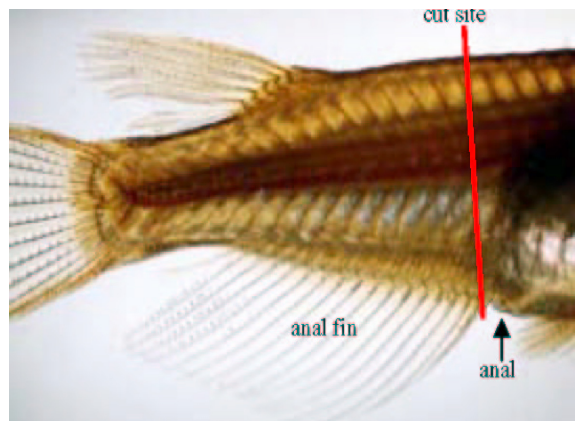

▼M6*Appendix 6***Recommended procedures for sample collection for vitellogenin analysis**

Care should be taken to avoid cross-contamination between VTG samples of males and females.

Procedure 1A: Fathead Minnow, Blood Collection from the Caudal Vein/Artery

After anaesthetisation, the caudal peduncle is partially severed with a scalpel blade and blood is collected from the caudal vein/artery with a heparinised microhematocrit capillary tube. After the blood has been collected, the plasma is quickly isolated by centrifugation for 3 min at 15 000 g (or alternatively for 10 min. at 15 000 g at 4 °C). If desired, percent hematocrit can be determined following centrifugation. The plasma portion is then removed from the microhematocrit tube and stored in a centrifuge tube with 0,13 units of aprotinin (a protease inhibitor) at – 80 °C until determination of vitellogenin can be made. Depending on the size of the fathead minnow (which is sex-dependent), collectable plasma volumes generally range from 5 to 60 microlitres per fish (Jensen *et al.* 2001).

Procedure 1B: Fathead Minnow, Blood Collection from Heart

Alternatively, blood may also be collected by cardiac puncture using a heparinized syringe (1 000 units of heparin per ml). The blood is transferred into Eppendorf tubes (held on ice) and then centrifuged (5 min, 7 000 g, room temperature). The plasma should be transferred into clean Eppendorf tubes (in aliquots if the volume of plasma makes this feasible) and promptly frozen at – 80 °C, until analyzed (Panter *et al.*, 1998).

Procedure 2A: Japanese Medaka, Excision of the Liver in Medaka

Removal of the test fish from the test chamber

- (1) Test fish should be removed from the test chamber using the small spoon-net. Be careful not to drop the test fish into other test chambers.
- (2) In principle, the test fish should be removed in the following order: control, solvent control (where appropriate), lowest concentration, middle concentration, highest concentration and positive control. In addition, all males should be removed from one test chamber before the remaining females are removed.
- (3) The sex of each test fish is identified on the basis of external secondary sex characteristics (e.g. the shape of the anal fin).
- (4) Place the test fish in a container for transport and carry it to the workstation for excision of the liver. Check the labels of the test chamber and the transport container for accuracy and to confirm that the number of fish that have been removed from the test chamber and that the number of fish remaining in the test chamber are consistent with expectation.
- (5) If the sex cannot be identified by the fish's external appearance, remove all fish from the test chamber. In this case, the sex should be identified by observing the gonad or secondary sex characteristics under a stereoscopic microscope.

▼ M6

Excision of the liver

- (1) Transfer the test fish from the container for transport to the anaesthetic solution using the small spoon-net.
- (2) After the test fish is anaesthetised, transfer the test fish on the filter paper (or a paper towel) using tweezers (commodity type). When grasping the test fish, apply the tweezers to the sides of the head to prevent breaking the tail.
- (3) Wipe the water on the surface of the test fish on the filter paper (or the paper towel).
- (4) Place the fish abdomen side up. Then make a small transverse incision partway between the ventral neck region and the mid-abdominal region using dissection scissors.
- (5) Insert the dissection scissors into the small incision, and incise the abdomen from a point caudal to the branchial mantle to the cranial side of the anus along the midline of the abdomen. Be careful not to insert the dissection scissors too deeply so as to avoid damaging the liver and gonad.
- (6) Conduct the following operations under the stereoscopic microscope.
- (7) Place the test fish abdomen side up on the paper towel (glass Petri dish or slide glass are also available).
- (8) Extend the walls of the abdominal cavity with precision tweezers and exteriorise the internal organs. It is also acceptable to exteriorise the internal organs by removing one side of the wall of the abdominal cavity if necessary.
- (9) Expose the connected portion of the liver and gallbladder using another pair of precision tweezers. Then grasp the bile duct and cut off the gallbladder. Be careful not to break the gallbladder.
- (10) Grasp the oesophagus and excise the gastrointestinal tract from the liver in the same way. Be careful not to leak the contents of the gastrointestinal tract. Excise the caudal gastrointestinal tract from the anus and remove the tract from the abdominal cavity.
- (11) Trim the mass of fat and other tissues from the periphery of the liver. Be careful not to scratch the liver.
- (12) Grasp the hepatic portal area using the precision tweezers and remove the liver from the abdominal cavity.
- (13) Place the liver on the slide glass. Using the precision tweezers, remove any additional fat and extraneous tissue (e.g., abdominal lining), if needed, from the surface of the liver.
- (14) Measure the liver weight with 1.5 ml microtube as a tare using an electronic analytical balance. Record the value on the worksheet (read: 0,1 mg). Confirm the identification information on the microtube label.
- (15) Close the cap of the microtube containing the liver. Store it in a cooling rack (or ice rack).
- (16) Following the excision of one liver, clean the dissection instruments or replace them with clean ones.

▼M6

- (17) Remove livers from all of the fish in the transport container as described above.
- (18) After the livers have been excised from all of the fish in the transport container (i.e., all males or females in a test chamber), place all liver specimens in a tube rack with a label for identification and store it in a freezer. When the livers are donated for pre-treatment shortly after the excision, the specimens are carried to the next workstation in a cooling rack (or ice rack).

Following liver excision, the fish carcass is available for measurement of secondary sex characteristics.

Specimen

Store the liver specimens taken from the test fish at ≤ -70 °C if they are not used for the pre-treatment shortly after the excision.

Figure 1

A cut is made just anterior to pectoral fins with scissors.

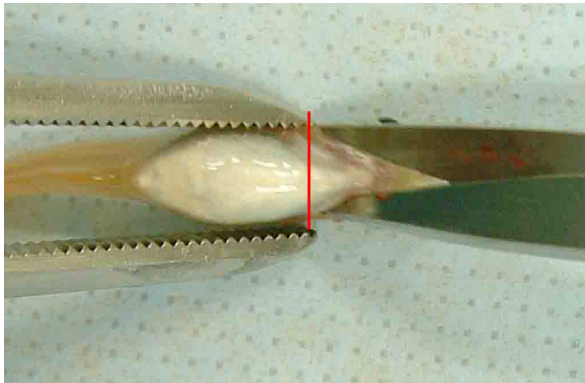
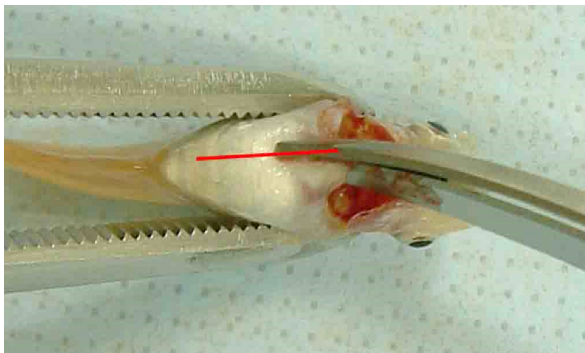

Figure 2

The midline of abdomen is incised with scissors to a point approximately 2 mm cranial to the anus.



▼ **M6**

Figure 3

The abdominal walls are spread with forceps for exposure of the liver and other internal organs. (Alternatively, the abdominal walls may be pinned laterally).

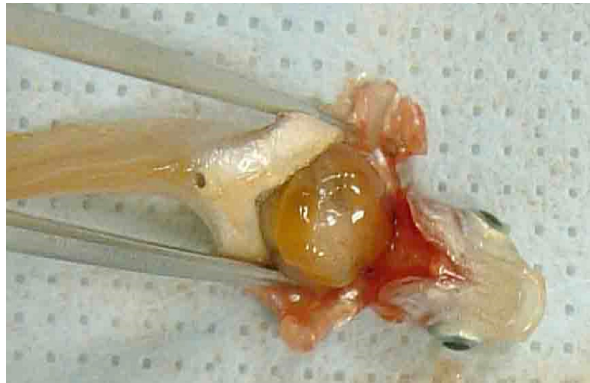

Figure 4

The liver is bluntly dissected and excised using forceps.

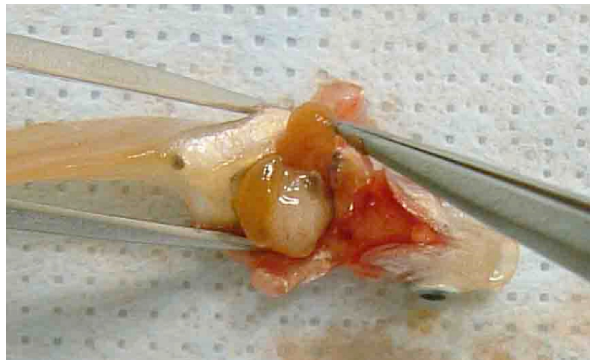

Figure 5

The intestines are gently retracted using forceps.



▼ **M6**

Testis 6

Both ends of the intestines and any mesenteric attachments are severed using scissors.

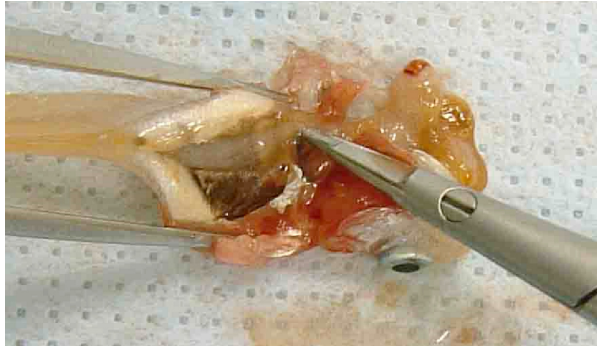

Testis 7 (female)

The procedure is identical for the female.

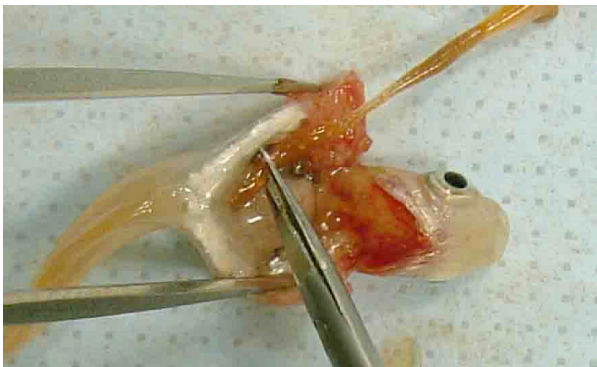

Testis 8

The completed procedure.

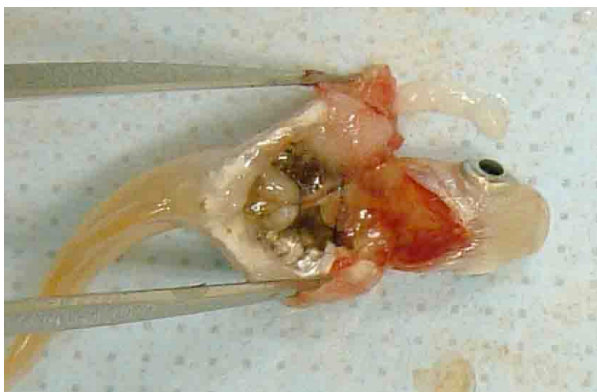

Procedure 2 B: Japanese Medaka (*Oryzias latipes*), Liver Pre-treatment for Vitellogenin Analysis

Take the bottle of homogenate buffer from the ELISA kit and cool it with crushed ice (temperature of the solution: ≤ 4 °C). If homogenate buffer from EnBio ELISA system is used, thaw the solution at room temperature, and then cool the bottle with crushed ice.

▼ M6

Calculate the volume of homogenate buffer for the liver on the basis of its weight (add 50 µl of homogenate buffer per mg liver weight for homogenate). For example, if the weight of the liver is 4,5 mg, the volume of homogenate buffer for the liver is 225 µl. Prepare a list of the volume of homogenate buffer for all livers.

Preparation of the liver for pre-treatment

- (1) Take the 1,5 ml microtube containing the liver from the freezer just before the pre-treatment.
- (2) Pre-treatment of the liver from males should be performed before females to prevent vitellogenin contamination. In addition, the pre-treatment for test groups should be conducted in the following order: control, solvent control (where appropriate), lowest concentration, middle concentration, highest concentration and positive control.
- (3) The number of 1,5 ml microtubes containing liver samples taken from the freezer at a given time should not exceed the number that can be centrifuged at that time.
- (4) Arrange the 1,5 ml microtubes containing liver samples in the order of specimen number on the ice rack (no need to thaw the liver).

Operation of the pre-treatment**1. Addition of the homogenization buffer**

- (1) Check the list for the volume of the homogenate buffer to be used for a particular sample of liver and adjust the micropipette (volume range: 100-1 000 µl) to the appropriate volume. Attach a clean tip to the micropipette.
- (2) Take the homogenate buffer from the reagent bottle and add the buffer to the 1,5 ml microtube containing the liver.
- (3) Add the homogenate buffer to all of 1,5 ml microtubes containing the liver according to the procedure described above. There is no need to change the micropipette tip to a new one. However, if the tip is contaminated or suspected to be contaminated, the tip should be changed.

2. Homogenisation of the liver

- (1) Attach a new pestle for homogenisation to the microtube homogeniser.
- (2) Insert the pestle into the 1,5 ml microtube. Hold the microtube homogeniser to press the liver between the surface of the pestle and the inner wall of the 1,5 ml microtube.
- (3) Operate the microtube homogeniser for 10 to 20 seconds. Cool the 1,5 ml microtube with crushed ice during the operation.
- (4) Lift up the pestle from the 1,5 ml microtube and leave it at rest for about 10 seconds. Then conduct a visual check of the state of the suspension.
- (5) If pieces of liver are observed in the suspension, repeat the operations (3) and (4) to prepare satisfactory liver homogenate.

▼ M6

- (6) Cool the suspended liver homogenate on the ice rack until centrifugation.
 - (7) Change the pestle to the new one for each homogenate.
 - (8) Homogenise all livers with homogenate buffer according to the procedure described above.
3. Centrifugation of the suspended liver homogenate
- (1) Confirm the temperature of the refrigerated centrifuge chamber at ≤ 5 °C.
 - (2) Insert the 1,5 ml microtubes containing the suspended liver homogenate in refrigerated centrifuge (adjust the balance if necessary).
 - (3) Centrifuge the suspended liver homogenate at 13 000 g for 10 min at ≤ 5 °C. However, if the supernatants are adequately separated, centrifugal force and time may be adjusted as needed.
 - (4) Following centrifugation, check that the supernatants are adequately separated (surface: lipid, intermediate: supernatant, bottom layer: liver tissue). If the separation is not adequate, centrifuge the suspension again under the same conditions.
 - (5) Remove all specimens from the refrigerated centrifuge and arrange them in the order of specimen number on the ice rack. Be careful not to resuspend each separated layer after the centrifugation.
4. Collection of the supernatant
- (1) Place four 0,5 ml microtubes for storage of the supernatant into the tube rack.
 - (2) Collect 30 μ l of each supernatant (separated as the intermediate layer) with the micropipette and dispense it to one 0,5 ml microtube. Be careful not to collect the lipid on the surface or the liver tissue in the bottom layer.
 - (3) Collect the supernatant and dispense it to other two 0,5 ml microtubes in the same manner as described above.
 - (4) Collect the rest of the supernatant with the micropipette (if feasible: ≥ 100 μ l). Then dispense the supernatant to the remaining 0,5 ml microtube. Be careful not to collect the lipid on the surface or the liver tissue in the bottom layer.
 - (5) Close the cap of the 0,5 ml microtube and write the volume of the supernatant on the label. Then immediately cool the microtubes on the ice rack.
 - (6) Change the tip of the micropipette to the new one for each supernatant. If a large amount of lipid becomes attached to the tip, change it to the new one immediately to avoid contamination of the liver extract with fat.
 - (7) Dispense all of the centrifuged supernatant to four 0,5 ml microtubes according to the procedure described above.

▼ M6

- (8) After dispensing the supernatant to the 0,5 ml microtubes, place all of them in the tube rack with the identification label, and then freeze them in the freezer immediately. If the VTG concentrations are measured immediately after the pre-treatment, keep one 0,5 ml microtube (containing 30 µl of supernatant) cool in the tube rack and transfer it to the workstation where the ELISA assay is conducted. In such case, place the remaining microtubes in the tube racks and freeze them in the freezer.
- (9) After the collection of the supernatant, discard the residue adequately.

Storage of the specimen

Store the 0,5 ml microtubes containing the supernatant of the liver homogenate at ≤ -70 °C until they are used for the ELISA.

Procedure 3A: Zebrafish, Blood Collection from the Caudal Vein / Artery

Immediately following anaesthesia, the caudal peduncle is severed transversely, and the blood is removed from the caudal artery/vein with a heparinised microhematocrit capillary tube. Blood volumes range from 5 to 15 µl depending on fish size. An equal volume of aprotinin buffer (6 µg/ml in PBS) is added to the microcapillary tube, and plasma is separated from the blood via centrifugation (5 minutes at 600 g). Plasma is collected in the test tubes and stored at -20 °C until analyzed for vitellogenin or other proteins of interest.

Procedure 3B: Zebrafish, Blood Collection by Cardiac Puncture

To avoid coagulation of blood and degradation of protein the samples are collected within Phosphate-buffered saline (PBS) buffer containing heparin (1 000 units/ml) and the protease inhibitor aprotinin (2 TIU/ml). As ingredients for the buffer, heparin ammonium salt and lyophilised aprotinin are recommended. For blood sampling, a syringe (1 ml) with a fixed thin needle (e.g. Braun Omnikan-F) is recommended. The syringe should be prefilled with buffer (approximately 100 µl) to completely elute the small blood volumes from each fish. The blood samples are taken by cardiac puncture. At first the fish should be anesthetized with MS-222 (100 mg/l). The proper plane of anaesthesia allows the user to distinguish the heartbeat of the zebrafish. While puncturing the heart, keep the syringe piston under weak tension. Collectable blood volumes range between 20 - 40 microliters. After cardiac puncture, the blood/buffer-mixture should be filled into the test tube. Plasma is separated from the blood via centrifugation (20 min; 5 000 g) and should be stored at -80 °C until required for analysis.

Procedure 3C: SOP: Zebrafish, homogenisation of head & tail

- (1) The fish are anaesthetised and euthanised in accordance with the test description.
- (2) The head and tail are cut of the fish in accordance with Figure 1.

Important: All dissection instruments, and the cutting board should be rinsed and cleaned properly (e.g. with 96 % ethanol) between handling of each single fish to prevent 'vitellogenin pollution' from females or induced males to uninduced males.

▼ **M6**

Figure 1

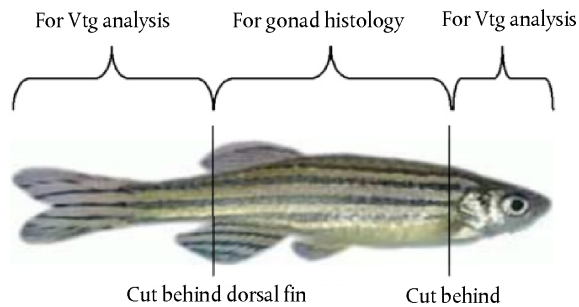

- (3) The weight of the pooled head and tail from each fish is measured to the nearest mg.
- (4) After being weighed, the parts are placed in appropriate tubes (e.g. 1,5 ml eppendorf) and frozen at $-80\text{ }^{\circ}\text{C}$ until homogenisation or directly homogenised on ice with two plastic pistils. (Other methods can be used if they are performed on ice and the result is a homogenous mass). Important: The tubes should be numbered properly so that the head and tail from the fish can be related to their respective body-section used for gonad histology.
- (5) When a homogenous mass is achieved, 4 x the tissue weight of ice-cold homogenisation buffer (*) is added. Keep working with the pistils until the mixture is homogeneous. Important note: New pistils are used for each fish.
- (6) The samples are placed on ice until centrifugation at $4\text{ }^{\circ}\text{C}$ at $50\,000 \times g$ for 30 min.
- (7) Use a pipette to dispense portions of $20\text{ }\mu\text{l}$ supernatant into at least two tubes by dipping the tip of the pipette below the fat layer on the surface and carefully sucking up the supernatant without fat- or pellet fractions.
- (8) The tubes are stored at $-80\text{ }^{\circ}\text{C}$ until use.

(*) **Homogenisation buffer:**

- (50 mM Tris-HCl pH 7,4; 1 % Protease inhibitor cocktail (Sigma)): 12 ml Tris-HCl pH 7,4 + 120 μl Protease inhibitor cocktail.
- TRIS: TRIS-ULTRA PURE (ICN) e.g. from Bie & Berntsen, Denmark.
- Protease inhibitor cocktail: From Sigma (for mammalian tissue) Product number P 8340.
- *Note:* The homogenisation buffer should be used the same day as manufactured. Place on ice during use.

▼ M6*Appendix 7***Vitellogenin fortification samples and inter-assay reference standard**

On each day that vitellogenin assays are performed, a fortification sample made using an inter-assay reference standard will be analysed. The vitellogenin used to make the inter-assay reference standard will be from a batch different from the one used to prepare calibration standards for the assay being performed.

The fortification sample will be made by adding a known quantity of the inter-assay standard to a sample of control male plasma. The sample will be fortified to achieve a vitellogenin concentration between 10 and 100 times the expected vitellogenin concentration of control male fish. The sample of control male plasma that is fortified may be from an individual fish or may be a composite from several fish.

A subsample of the unfortified control male plasma will be analysed in at least two duplicate wells. The fortified sample also will be analysed in at least two duplicate wells. The mean quantity of vitellogenin in the two unfortified control male plasma samples will be added to the calculated quantity of vitellogenin added to fortification the samples to determine an expected concentration. The ratio of this expected concentration to the measured concentration will be reported along with the results from each set of assays performed on that day.

Decision flowchart for the statistical analysis

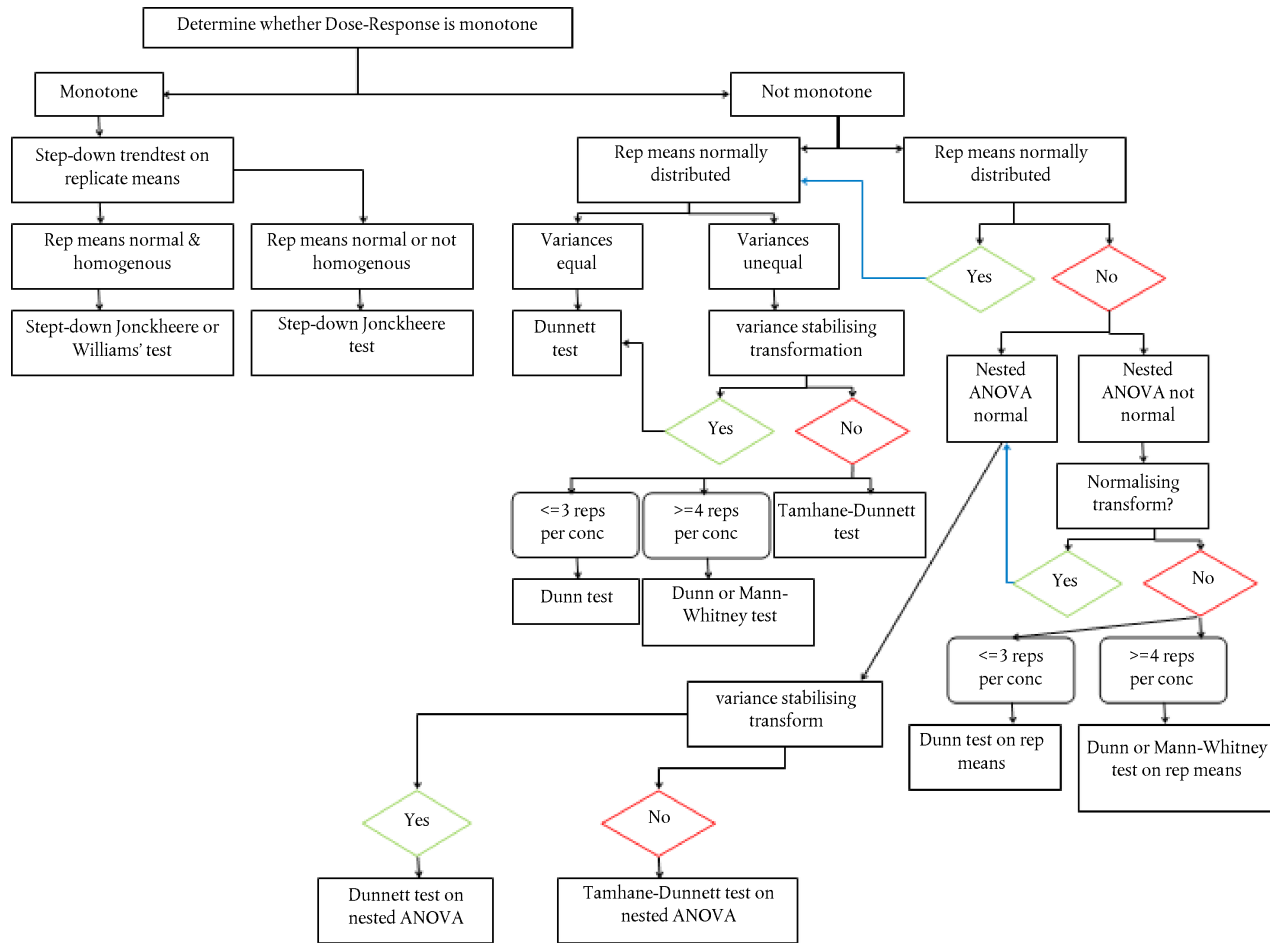

▼ M6**C.38. THE AMPHIBIAN METAMORPHOSIS ASSAY**

INTRODUCTION

1. This test method is equivalent to OECD test guideline (TG) 231 (2009). The need to develop and validate an assay capable of detecting chemicals active in the thyroid system of vertebrate species originates from concerns that environmental levels of chemicals may cause adverse effects in both humans and wildlife. In 1998, the OECD initiated a high-priority activity to revise existing TGs and to develop new TGs for the screening and testing of potential endocrine disruptors. One element of the activity was to develop a TG for the screening of chemicals active on the thyroid system of vertebrate species. Both an enhancement of the Repeated dose 28-day oral toxicity study in rodents (Chapter B.7 of this Annex) and the Amphibian Metamorphosis Assay (AMA) were proposed. The enhanced test method B.7 underwent validation and a revised test method has been issued. The Amphibian Metamorphosis Assay (AMA) underwent an extensive validation programme which included intra- and inter-laboratory studies demonstrating the relevance and reliability of the assay (1, 2). Subsequently, the validation of the assay was subject to peer-review by a panel of independent experts (3). This test method is the outcome of the experience gained during the validation studies for the detection of thyroid active chemicals, and of work conducted elsewhere in OECD member countries.

PRINCIPLE OF THE TEST

2. The Amphibian Metamorphosis Assay (AMA) is a screening assay intended to empirically identify chemicals which may interfere with the normal function of the hypothalamic-pituitary-thyroid (HPT) axis. The AMA represents a generalised vertebrate model to the extent that it is based on the conserved structures and functions of the HPT axis. It is an important assay because amphibian metamorphosis provides a well-studied, thyroid-dependent process which responds to chemicals active within the HPT axis, and it is the only existing assay that detects thyroid activity in an animal undergoing morphological development.
3. The general experimental design entails exposing stage 51 *Xenopus laevis* tadpoles to a minimum of three different concentrations of a test chemical and a dilution water control for 21 days. There are four replicates of each test treatment. Larval density at test initiation is 20 tadpoles per test tank for all treatment groups. The observational endpoints are hind limb length, snout to vent length (SVL), developmental stage, wet weight, thyroid histology, and daily observations of mortality.

DESCRIPTION OF THE METHOD

Test Species

4. *Xenopus laevis* is routinely cultured in laboratories worldwide and is easily obtainable through commercial suppliers. Reproduction can be easily induced in this species throughout the year using human chorionic gonadotropin (hCG) injections and the resultant larvae can be routinely reared to selected developmental stages in large numbers to permit the use of stage-specific test protocols. It is preferred that larvae used in the assay are derived from in-house adults. As an alternative although this is not the

▼M6

preferred procedure, eggs or embryos may be shipped to the laboratory performing the test and allowed to acclimate; the shipping of larval stages for use in the test is unacceptable.

Equipment and Supplies

5. The following equipment and supplies are needed for the conduct of this assay:
 - (a) Exposure system (see description below);
 - (b) Glass or stainless steel aquaria (see description below);
 - (c) Breeding tanks;
 - (d) Temperature controlling apparatus (e.g., heaters or coolers (adjustable to $22^{\circ} \pm 1^{\circ}\text{C}$));
 - (e) Thermometer;
 - (f) Binocular dissection microscope;
 - (g) Digital camera with at least 4 megapixel resolution and micro function;
 - (h) Image digitising software;
 - (i) Petri dish (e.g. 100 × 15 mm) or transparent plastic chamber of comparable size;
 - (j) Analytical balance capable of measuring to 3 decimal places (mg);
 - (k) Dissolved oxygen meter;
 - (l) pH meter;
 - (m) Light intensity meter capable of measuring in lux units;
 - (n) Miscellaneous laboratory glassware and tools;
 - (o) Adjustable pipettes (10 to 5 000 µl) or assorted pipettes of equivalent sizes;
 - (p) Test chemical in sufficient quantities to conduct the study, preferably of one lot;
 - (q) Analytical instrumentation appropriate for the chemical on test or contracted analytical services.

Chemical Testability

6. The AMA is based upon an aqueous exposure protocol whereby test chemical is introduced into the test chambers via a flow-through system. Flow-through methods however, introduce constraints on the types of

▼ M6

chemicals that can be tested, as determined by the physicochemical properties of the chemical. Therefore, prior to using this protocol, baseline information about the chemical should be obtained that is relevant to determining the testability, and the OECD Guidance Document on Aquatic Toxicity Testing of Difficult Substances and Mixtures (4) should be consulted. Characteristics which indicate that the chemical may be difficult to test in aquatic systems include: high octanol water partitioning coefficients ($\log K_{ow}$), high volatility, susceptibility to hydrolysis, and susceptibility to photolysis under ambient laboratory lighting conditions. Other factors may also be relevant to determining testability and should be determined on a case by case basis. If a successful test is not possible for the chemical using a flow-through test system, a static renewal system may be employed. If neither system is capable of accommodating the test chemical, then the default is to not test it using this protocol.

Exposure System

7. A flow-through diluter system is preferred, when possible, over a static renewal system. If physical and/or chemical properties of any of the test chemicals are not amenable to a flow-through diluter system, then an alternative exposure system (e.g., static-renewal) can be employed. The system components should have water-contact components of glass, stainless steel, and/or Polytetrafluoroethylene. However, suitable plastics can be utilised if they do not compromise the study. Exposure tanks should be glass or stainless steel aquaria, equipped with standpipes that result in an approximate tank volume between 4,0 and 10,0 l and minimum water depth of 10 to 15 cm. The system should be capable of supporting all exposure concentrations and a control, with four replicates per treatment. The flow rate to each tank should be constant in consideration of both the maintenance of biological conditions and chemical exposure (e.g. 25 ml/min). The treatment tanks should be randomly assigned to a position in the exposure system in order to reduce potential positional effects, including slight variations in temperature, light intensity, etc. Fluorescent lighting should be used to provide a photoperiod of 12 hr light: 12 hr dark at an intensity that ranges from 600 to 2 000 lux (lumen/m^2) at the water surface. Water temperature should be maintained at $22^\circ \pm 1^\circ \text{C}$, pH maintained between 6,5 to 8,5, and the dissolved oxygen (DO) concentration $> 3,5 \text{ mg/l}$ ($> 40\%$ of the air saturation) in each test tank. As a minimum water temperature, pH and dissolved oxygen should be measured weekly; temperature should preferably be measured continuously in at least one test vessel. Appendix 1 outlines the experimental conditions under which the protocol should be executed. For further information on setting up flow-through exposure systems and/or static renewal systems, please refer to the ASTM Standard Guide for Conducting Acute Toxicity Tests on Test Materials with Fishes, Macroinvertebrates, and Amphibians (5) and general aquatic toxicology tests.

Water quality

8. Any water that is locally available (e.g. springwater or charcoal-filtered tap water) and permits normal growth and development of *X. laevis* tadpoles could be used. Because local water quality can differ substantially from one area to another, analysis of water quality should be undertaken, particularly, if historical data on the utility of the water for raising *Xenopus* is not available. Special attention should be given that the water is free of copper, chlorine and chloramines, all of which are toxic to frogs and tadpoles. It is further recommended to analyse the water concerning background levels of fluoride, perchlorate and chlorate (by-products of drinking water disinfection) as all of these anions are substrates of the iodine transporter of the thyroid gland and elevated

▼M6

levels of each of these anions may confound the study outcome. Analysis should be performed before testing begins and the testing water should normally be free from these anions.

Iodide Concentration in Test Water

9. In order for the thyroid gland to synthesise TH, sufficient iodide needs to be available to the larvae through a combination of aqueous and dietary sources. Currently, there are no empirically derived guidelines for minimal iodide concentrations. However, iodide availability may affect the responsiveness of the thyroid system to thyroid active agents and is known to modulate the basal activity of the thyroid gland, an aspect that deserves attention when interpreting the results from thyroid histopathology. Therefore, measured aqueous iodide concentrations from the test water should be reported. Based on the available data from the validation studies, the protocol has been demonstrated to work well when test water iodide (I⁻) concentrations ranged between 0,5 and 10 µg/l. Ideally, the minimum iodide concentration in the test water should be 0,5 µg/l. If the test water is reconstituted from deionised water, iodine should be added at a minimum concentration of 0,5 µg/l. Any additional supplementation of the test water with iodine or other salts should be noted in the report.

Holding of animals*Adult Care and Breeding*

10. Adult care and breeding is conducted in accordance with standard guidelines and the reader is directed to the standard guide for performing the Frog Embryo Teratogenesis Assay (FETAX) (6) for more detailed information. Such standard guidelines provide an example of appropriate care and breeding methods, but strict adherence is not required. To induce breeding, pairs (3-5) of adult females and males are injected with human chorionic gonadotropin (hCG). Female and male specimens are injected with approximately 800 IU-1 000 IU and 600 IU-800 IU, respectively, of hCG dissolved in 0,6-0,9 % saline solution. Breeding pairs are held in large tanks, undisturbed and under static conditions in order to promote amplexus. The bottom of each breeding tank should have a false bottom of stainless steel or plastic mesh which permits the egg masses to fall to the bottom of the tank. Frogs injected in the late afternoon will usually deposit most of their eggs by mid morning of the next day. After a sufficient quantity of eggs are released and fertilised, adults should be removed from the breeding tanks.

Larval Care and Selection

11. After the adults are removed from the breeding tanks, the eggs are collected and evaluated for viability using a representative sub-set of the embryos from all breeding tanks. The best individual spawn(s) (2-3 recommended to evaluate the quality of the spawns) should be retained based upon embryo viability and the presence of an adequate number (minimum of 1 500) of embryos. All the organisms used in a study should originate from a single spawning event (i.e., the spawns should not be co-mixed). The embryos are transferred into a large flat pan or dish and all obvious dead or abnormal eggs (see definition in (5)) are removed using a pipette or eyedropper. The sound embryos from each of the three spawns are

▼ M6

transferred into three separate hatching tanks. Four days after being placed in the hatching tanks, the best spawn, based on viability and hatching success, is selected and the larvae are transferred into an appropriate number of rearing tanks at $22^{\circ} \pm 1^{\circ}\text{C}$. In addition, some additional larvae are moved into extra tanks for use as replacements in the event that mortalities occur in the rearing tanks during the first week. This procedure maintains consistent organism density and thereby reduces developmental divergence within the cohort of a single spawn. All rearing tanks should be siphoned clean daily. As a precaution, vinyl or nitrile gloves are preferred to latex gloves. Mortalities should be removed daily and replacement larvae should be added back to maintain the organism density during the first week. Feeding should occur at least twice per day.

12. During the pre-exposure phase, tadpoles are acclimated to the conditions of the actual exposure phase, including the type of food, temperature, light-dark cycle and the culture medium. Therefore, it is recommended that the same culture/dilution water be used during the pre-exposure phase and the exposure phase. If a static culture system is used for maintaining tadpoles during the pre-exposure phase, the culture medium should be replaced completely at least twice per week. Crowding, caused by high larval densities during the pre-exposure period, should be avoided because such effects could markedly affect tadpole development during the subsequent testing phase. Therefore, the rearing density should not exceed approximately four tadpoles/l culture medium (static exposure system) or 10 tadpoles/l culture medium (with e.g. 50 ml/min flow rate in the pre-exposure or culturing system). Under these conditions, tadpoles should develop from stages 45/46 to stage 51 within twelve days. Representative tadpoles of this stock population should be inspected daily for developmental stage in order to estimate the appropriate time point for initiation of exposure. Care should be used to minimise stress and trauma to the tadpoles, especially during movement, cleaning of aquaria, and manipulation of larvae. Stressful conditions/activities should be avoided such as loud and/or incessant noise, tapping on aquaria, vibrations in the aquaria, excessive activity in the laboratory, and rapid changes in environmental media (light availability, temperature, pH, DO, water flow rates, etc.) If tadpoles do not develop to stage 51 within 17 days after fertilisation, excessive stress should be considered as a potential culprit.

Larval Culture and Feeding

13. Tadpoles are fed with e.g. the commercial tadpole feed used in the validation studies (see also appendix 1) throughout the pre-exposure period (after Nieuwkoop and Faber (NF) stage 45/46 (8)) and during the entire test period of 21 days, or other diet that has demonstrated to allow equal performance of the Amphibian Metamorphosis Assay. The feeding regime during the pre-exposure period should be carefully adjusted to meet the demands of the developing tadpoles. That is, small portions of food should be provided to the newly hatched tadpoles several times per day (at least twice). Excess food should be avoided in order *i)* to maintain water quality and *ii)* to prevent the clogging of gill filters with food particles and detritus. For the tadpole feed used in the validation studies, the daily food rations should be increased along with tadpole growth to approximately 30 mg/animal/day shortly before test initiation. This commercially available feed has been shown in the validation studies to support proper growth and development of *X. laevis* tadpoles, and is a fine particulate that

▼M6

stays suspended in the water column for a long period of time and is subject to washing out with the flow. Therefore, the total daily amount of food should be divided into smaller portions and fed at least twice daily. For this feed the feeding regime is outlined in Table 1. Feeding rates should be recorded. It can be fed dry or as a stock solution prepared in dilution water. Such a stock solution should be freshly prepared every other day and stored at 4 °C when not in use.

Table 1

Feeding regime with commercial tadpole feed used in the validation studies for *X. laevis* tadpoles during the in-life portion of the AMA in flow-through conditions

Study Day	Food ration (mg feed/animal/day)
0-4	30
5-7	40
8-10	50
11-14	70
15-21	80

Analytical Chemistry

14. Prior to conducting a study, the stability of the test chemical should be evaluated using existing information on its solubility, degradability and volatility. Test solutions from each replicate tank at each concentration should be sampled for analytical chemistry analyses at test initiation (day 0), and weekly during the test for a minimum of four samples. It is also recommended that each test concentration be analysed during system preparation, prior to test initiation, to verify system performance. In addition, it is recommended that stock solutions be analysed when they are changed, especially if the volume of the stock solution does not provide adequate amounts of chemical to span the duration of routine sampling periods. In the case of chemicals which cannot be detected at some or all of the concentrations used in a test, stock solutions should be measured and system flow rates recorded in order to calculate nominal concentrations.

Chemical Delivery

15. The method used to introduce the test chemical to the system can vary depending on its physicochemical properties. Water soluble chemicals can be dissolved in aliquots of test water at a concentration which allows delivery at the target test concentration in a flow-through system. Chemicals which are liquid at room temperature and sparingly soluble in water can be introduced using liquid:liquid saturator methods. Chemicals which are solid at room temperature and are sparingly soluble in water can be introduced using glass wool column saturators (7). The preference is to use a carrier-free test system, however different test chemicals will possess varied physicochemical properties that will likely require different approaches for preparation of chemical exposure water. It is preferred that effort be made to avoid solvents or carriers because: *i*) certain solvents themselves may result in toxicity and/or undesirable or unexpected endocrinological responses, *ii*) testing chemicals above their water solubility (as can frequently occur through the use of

▼ M6

solvents) can result in inaccurate determinations of effective concentrations, and *iii*) the use of solvents in longer-term tests can result in a significant degree of 'biofilming' associated with microbial activity. For difficult to test chemicals, a solvent may be employed as a last resort, and the OECD Guidance Document on aquatic toxicity testing of difficult substances and mixtures should be consulted (4) to determine the best method. The choice of solvent will be determined by the chemical properties of the chemical. Solvents which have been found to be effective for aquatic toxicity testing include acetone, ethanol, methanol, dimethyl formamide and triethylene glycol. In case a solvent carrier is used, solvent concentrations should be below the chronic No Observed Effect Concentration (NOEC); the OECD Guidance Document recommends a maximum of 100 µl/l; a recent review recommends that solvent concentrations as low as 20 µl/l of dilution water be used (12). If solvent carriers are used, appropriate solvent controls should be evaluated in addition to non-solvent controls (clean water). If it is not possible to administer a chemical via the water, either because of physicochemical characteristics (low solubility) or limited chemical availability, introducing it via the diet may be considered. Preliminary work has been conducted on dietary exposures; however, this route of exposure is not commonly used. The choice of method should be documented and analytically verified.

Selection of test concentrations*Establishing the High Test Concentration*

16. For the purposes of this test, the high test concentration should be set by the solubility limit of the test chemical; the maximum tolerated concentration (MTC) for acutely toxic chemicals; or 100 mg/l, whichever is lowest.

17. The MTC is defined as the highest test concentration of the chemical which results in less than 10 % acute mortality. Using this approach assumes that there are existing empirical acute mortality data from which the MTC can be estimated. Estimating the MTC can be inexact and typically requires some professional judgment. Although the use of regression models may be the most technically sound approach to estimating the MTC, a useful approximation of the MTC can be derived from existing acute data by using 1/3 of the acute LC₅₀ value. However, acute toxicity data may be lacking for the species on test. If species specific acute toxicity data are not available, then a 96-hour LC₅₀ test can be completed with tadpoles that are representative (i.e., same stage) of those on test in the AMA. Optionally, if data from other aquatic species are available (e.g. LC₅₀ studies in fish or other amphibian species), then professional judgment may be used to estimate a likely MTC based on inter-species extrapolation.

18. Alternatively, if the chemical is not acutely toxic and is soluble above 100 mg/l, then 100 mg/l should be considered the highest test concentration (HTC), as this concentration is typically considered 'practically non-toxic.'

▼ M6

19. Although not the recommended procedure, static renewal methods may be used where flow-through methods are inadequate to achieve the MTC. If static renewal methods are used, then the stability of the test chemical concentration should be documented and remain within the performance criteria limits. Twenty-four hour renewal periods are recommended. Renewal periods exceeding 72 hours are not acceptable. Additionally, water quality parameters (e.g. DO, temperature, pH, etc.) should be measured at the end of each renewal period, immediately prior to renewal.

Test Concentration Range

20. There is a required *minimum* of three test concentrations and a clean water control (and vehicle control if necessary). The minimum test concentration differential between the highest and lowest should be about one order of magnitude. The maximum dose separation is 0,1 and the minimum is 0,33.

PROCEDURE

Test Initiation and Conduct*Day 0*

21. The exposure should be initiated when a sufficient number of tadpoles in the pre-exposure stock population have reached developmental stage 51, according to Nieuwkoop and Faber (8), and which are less than or equal to 17 days of age post fertilisation. For selection of test animals, healthy and normal looking tadpoles of the stock population should be pooled in a single vessel containing an appropriate volume of dilution water. For developmental stage determination, tadpoles should be individually removed from the pooling tank using a small net or strainer and transferred to a transparent measurement chamber (e.g. 100 mm Petri dish) containing dilution water. For stage determination, it is preferred not to use anaesthesia, however one may individually anaesthetise the tadpoles using 100 mg/l tricaine methanesulfonate (e.g. MS-222), appropriately buffered with sodium bicarbonate (pH 7,0), before handling. If used, methodology for appropriately using e.g. MS-222 for anaesthesia should be obtained from experienced laboratories and reported with the test results. Animals should be carefully handled during this transfer in order to minimise handling stress and to avoid any injury.
22. The developmental stage of the animals is determined using a binocular dissection microscope. To reduce the ultimate variability in developmental stage, it is important that this staging be conducted as accurately as possible. According to Nieuwkoop and Faber (8), the primary developmental landmark for selecting stage 51 organisms is hind limb morphology. The morphological characteristics of the hind limbs should be examined under the microscope. While the complete Nieuwkoop and Faber (8) guide should be consulted for comprehensive information on staging tadpoles, one can reliably determine stage using prominent morphological landmarks. The following table can be used to simplify and standardise the staging process throughout the study by identifying those prominent morphological landmarks associated with different stages, assuming that development is normal.

▼ **M6**

Table 2

Prominent morphological staging landmarks based on Neuwkoop and Faber guidance

Prominent Morphological Landmarks	Developmental Stage															
	51	52	53	54	55	56	57	58	59	60	61	62	63	64	65	66
Hindlimb	X	X	X	X	X	X	X									
Forelimb						X	X	X	X	X						
Craniofacial structure										X	X	X	X			
Olfactory nerve morphology											X	X	X			
Tail length													X	X	X	X

23. For test initiation, all tadpoles should be at stage 51. The most prominent morphological staging landmark for that stage is hind limb morphology, which is demonstrated in Figure 1.

Figure 1

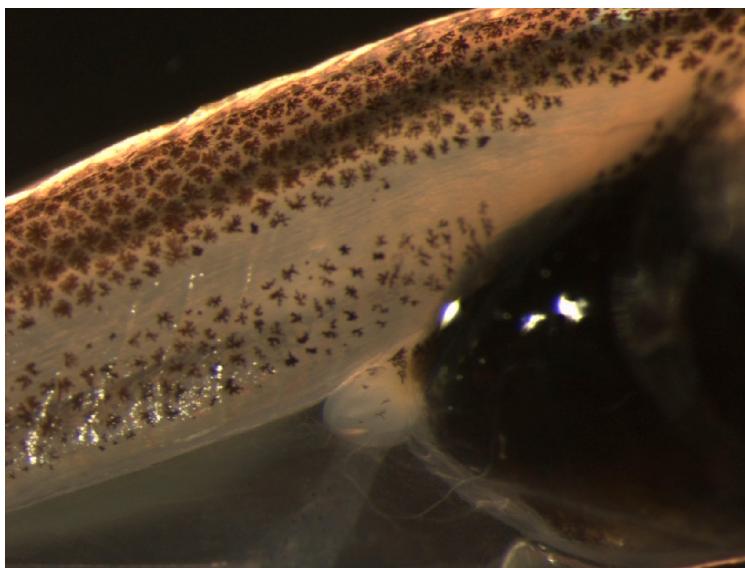
Hind limb morphology of a stage 51 *X. laevis* tadpole

24. In addition to the developmental stage selection, an optional size selection of the experimental animals may be used. For this purpose, the whole body length (not SVL) should be measured at day 0 for a sub-sample of approximately 20 NF stage 51 tadpoles. After calculation of the mean whole body length for this group of animals, minimum and maximum limits for the whole body length of experimental animals can be set by allowing a range of the mean value ± 3 mm (mean values of whole body length range between 24,0 and 28,1 mm for stage 51 tadpoles). However, developmental staging is the primary parameter in determining the readiness of each test animal. Tadpoles exhibiting grossly visible malformations or injuries should be excluded from the assay.

▼ M6

25. Tadpoles that meet the stage criteria described above are held in a tank of clean culture water until the staging process is completed. Once the staging is completed, the larvae are randomly distributed to exposure treatment tanks until each tank contains 20 larvae. Each treatment tank is then inspected for animals with abnormal appearance (e.g., injuries, abnormal swimming behaviour, etc.). Overtly unhealthy looking tadpoles should be removed from the treatment tanks and replaced with larvae newly selected from the pooling tank.

Observations

26. For more in-depth information on test termination procedures and processing of tadpoles, refer to the OECD Guidance Document on Amphibian Thyroid Histology (9).

Day 7 Measurements

27. On day 7, five randomly chosen tadpoles per replicate are removed from each test tank. The random procedure used should give each organism on test equal probability of being selected. This can be achieved by using any randomising method but requires that each tadpole be netted. Tadpoles not selected are returned to the tank of origin and the selected tadpoles are humanely euthanised in 150 to 200 mg/l e.g. MS-222, appropriately buffered with sodium bicarbonate to achieve pH 7.0. The euthanised tadpoles are rinsed in water and blotted dry, followed by body weight determination to the nearest milligram. Hind limb length, snout to vent length, and developmental stage (using a binocular dissection microscope) are determined for each tadpole.

Day 21 Measurements (Test Termination)

28. At test termination (day 21), the remaining tadpoles are removed from the test tanks and humanely euthanised in 150 to 200 mg/l e.g. MS-222, appropriately buffered with sodium bicarbonate, as above. Tadpoles are rinsed in water and blotted dry, followed by body weight determination to the nearest milligram. Developmental stage, SVL, and hind limb lengths are measured for each tadpole.
29. All larvae are placed in Davidson's fixative for 48 to 72 hours either as whole body samples or as trimmed head tissue samples containing the lower jaw for histological assessments. For histopathology, a total of five tadpoles should be sampled from each replicate tank. Since follicular cell height is stage dependent (10), the most appropriate sampling approach for histological analyses is to use stage-matched individuals, whenever possible. In order to select stage-matched individuals, all larvae should first be staged prior to selection and subsequent processing for data collection and preservation. This is necessary because normal divergence in development will result in differential stage distributions within each replicate tank.
30. Animals selected for histopathology (n = 5 from each replicate) should be matched to the median stage of the controls (pooled replicates) whenever possible. If there are replicate tanks with more than five larvae at the appropriate stage, then five larvae are randomly selected.

▼ M6

31. If there are replicate tanks with less than five larvae at the appropriate stage, then randomly selected individuals from the next lower or upper developmental stage should be sampled to reach a total sample size of five larvae per replicate. Preferably, the decision to sample additional larvae from either the next lower or upper developmental stage should be made based on an overall evaluation of the stage distribution in the control and chemical treatments. That is, if the chemical treatment is associated with a retardation of development, then additional larvae should be sampled from the next lower stage. In turn, if the chemical treatment is associated with an acceleration of development, then additional larvae should be sampled from the next upper stage.
32. In cases of severe alterations of tadpole development due to treatment with a test chemical, there might be no overlap of the stage distribution in the chemical treatments with the calculated control median developmental stage. In only these cases, the selection process should be modified by using a stage different from the control median stage to achieve a stage-matched sampling of larvae for thyroid histopathology. Furthermore, if stages are indeterminate (i.e., asynchrony), then 5 tadpoles from each replicate should be randomly chosen for histological analysis. The rationale underlying sampling of any larvae that are not at a stage equivalent to the control median developmental stage should be reported.

Determination of Biological Endpoints

33. During the 21 day exposure phase, measurement of primary endpoints is performed on days 7 and 21, however daily observation of test animals is necessary. Table 3 provides an overview of the measurement endpoints and the corresponding observation time points. More detailed information for technical procedures for measurement of apical endpoints and histological assessments is available in the OECD guidance documents (9).

*Table 3***Observation time points for primary endpoints in the AMA**

Apical Endpoints	Daily	Day 7	Day 21
— Mortality	•		
— Developmental Stage		•	•
— Hind Limb Length		•	•
— Snout-Vent Length		•	•
— Wet Body Weight		•	•
— Thyroid Gland Histology			•

▼ M6**Apical Endpoints**

34. Developmental stage, hind limb length, SVL and wet weight are the apical endpoints of the AMA, and each is briefly discussed below. Further technical information for collecting these data is available in the guidance documents referenced including procedures for computer-assisted analysis which are recommended for use.

Developmental Stage

35. The developmental stage of *X. laevis* tadpoles is determined using the staging criteria of Nieuwkoop and Faber (8). Developmental stage data are used to determine if development is accelerated, asynchronous, delayed or unaffected. Acceleration or delay of development is determined by making a comparison between the median stage achieved by the control and treated groups. Asynchronous development is reported when the tissues examined are not malformed or abnormal, but the relative timing of the morphogenesis or development of different tissues is disrupted within a single tadpole.

Hind Limb Length

36. Differentiation and growth of the hind limbs are under control of thyroid hormones and are major developmental landmarks already used in the determination of developmental stage. Hind limb development is used qualitatively in the determination of developmental stage, but is considered here as a quantitative endpoint. Therefore, hind limb length is measured as an endpoint to detect effects on the thyroid axis (Figure 2). For consistency, hind limb length is measured on the left hind limb. Hind limb length is evaluated both at day 7 and at day 21 of the test. On day 7, measuring hind limb length is straightforward, as illustrated in Figure 2. However, measuring hind limb length on day 21 is more complicated due to bends in the limb. Therefore, measurements of hind limb length at day 21 should originate at the body wall and follow the midline of the limb through any angular deviations. Changes in hind limb length at day 7, even if not evident at day 21, are still considered significant for potential thyroid activity. Length measurements are acquired from digital photographs using image analysis software as described in the OECD Guidance Document on Amphibian Thyroid Histology (9).

Body Length and Wet Weight

37. Determinations of snout to vent length (SVL) (Figure 2) and wet weight are included in the test protocol to assess possible effects of test chemicals on the growth rate of tadpoles in comparison to the control group and are useful in detecting generalised toxicity to the test chemical. Because the removal of adherent water for weight determinations can cause stressful conditions for tadpoles and may cause skin damage, these measurements are performed on the day 7 sub-sampled tadpoles and all remaining tadpoles at test termination (day 21). For consistency, use the cranial aspect of the vent as the caudal limit of the measurement.

38. Snout to vent length (SVL) is used to assess tadpole growth as illustrated in Figure 2.

▼ M6

Figure 2

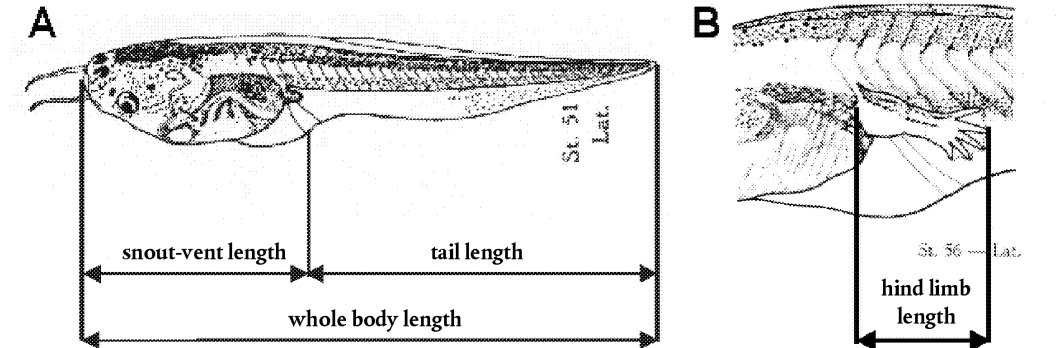
(A) Types of body length measurements and (B) Hind limb length measurements for *X. laevis* tadpoles (1)**Thyroid Gland Histology**

39. While developmental stage and hind limb length are important endpoints to evaluate exposure-related changes in metamorphic development, developmental delay cannot, by itself, be considered a diagnostic indicator of anti-thyroidal activity. Some changes may only be observable by routine histopathological analysis. Diagnostic criteria include thyroid gland hypertrophy/atrophy, follicular cell hypertrophy, follicular cell hyperplasia, and as additional qualitative criteria: follicular lumen area, colloid quality and follicular cell height/shape. Severity grading (4 grades) should be reported. Information on obtaining and processing samples for histological analysis and for performing histologic analyses on tissue samples is available in 'Amphibian Metamorphosis Assay: Part 1 — Technical guidance for morphologic sampling and histological preparation' and 'Amphibian Metamorphosis Assay: Part 2 — Approach to reading studies, diagnostic criteria, severity grading and atlas' (9). Laboratories performing the assay for the first time(s) should seek advice from experienced pathologists for training purpose prior to undertaking histological analysis and evaluation of the thyroid gland. Overt and significant changes in apical endpoints indicating developmental acceleration or asynchrony may preclude the necessity to perform histopathological analysis of the thyroid glands. However, absence of overt morphological changes or evidence of developmental delay warrants histological analyses.

Mortality

40. All test tanks should be checked daily for dead tadpoles and the numbers recorded for each tank. The date, concentration and tank number for any observation of mortality should be recorded. Dead animals should be removed from the test tank as soon as observed. Mortality rates exceeding 10 % may indicate inappropriate test conditions or toxic effects of the test chemical.

Additional Observations

41. Cases of abnormal behaviour and grossly visible malformations and lesions should be recorded. The date, concentration and tank number for any observation of abnormal behaviour, gross malformations or lesions should be recorded. Normal behaviour is characterised by the tadpoles being suspended in the water column with tail elevated above the head, regular rhythmic tail fin beating, periodic surfacing, operculating, and being responsive to stimulus. Abnormal behaviour would include, for example, floating on the surface, lying on the bottom of the tank, inverted or irregular swimming, lack of surfacing activity, and being nonresponsive to stimulus. In addition, gross differences in food consumption between treatments should be recorded. Gross malformations

▼ M6

and lesions could include morphological abnormalities (e.g. limb deformities), hemorrhagic lesions, bacterial or fungal infections, to name a few. These determinations are qualitative and should be considered akin to clinical signs of disease/stress and made in comparison to control animals. If the occurrence or rate of occurrence is greater in exposed tanks than in the controls, then these should be considered as evidence for overt toxicity.

DATA AND REPORTING**Data Collection**

42. All data should be collected using electronic or manual systems which conform to good laboratory practices (GLP). Study data should include:

Test chemical:

- Characterisation of the test chemical: physical-chemical properties; information on stability and biodegradability;
- Chemical information and data: method and frequency of preparation of dilutions. Test chemical information includes actual and nominal concentrations of the test chemical, and in some cases, non-parent chemical, as appropriate. Test chemical measurements may be required for stock solutions as well as for test solutions;
- Solvent (if other than water): justification of the choice of solvent, and characterisation of solvent (nature, concentration used);

Test conditions:

- Operational records: these consist of observations pertaining to the functioning of the test system and the supporting environment and infrastructure. Typical records include: ambient temperature, test temperature, photoperiod, status of critical components of the exposure system (e.g. pumps, cycle counters, pressures), flow rates, water levels, stock bottle changes, and feeding records. General water quality parameters include: pH, DO, conductivity, total iodine, alkalinity, and hardness;
- Deviations from the test method: this information should include any information or narrative descriptions of deviations from the test method;

Results:

- Biological observations and data: these include daily observations of mortality, food consumption, abnormal swimming behaviour, lethargy, loss of equilibrium, malformations, lesions, etc. Observations and data collected at predetermined intervals include: developmental stage, hind limb length, snout vent length, and wet weight;

▼ M6

- Statistical analytical techniques and justification of techniques used; results of the statistical analysis preferably in tabular form;
- Histological data: these include narrative descriptions, as well as graded severity and incidence scores of specific observations, as detailed in the histopathology guidance document;
- Ad hoc observations: these observations should include narrative descriptions of the study that do not fit into the previously described categories.

Data reporting

43. Appendix 2 contains daily data collection spreadsheets that can be used as guidance for raw data entry and for calculations of summary statistics. Additionally, reporting tables are provided that are convenient for communicating summaries of endpoint data. Reporting tables for histological assessments can be found in Appendix 2.

Performance Criteria and Test Acceptability/Validity

44. Generally, gross deviations from the test method will result in unacceptable data for interpretation or reporting. Therefore, the following criteria in Table 4 have been developed as guidance for determining the quality of the test performed, the general performance of the control organisms.

*Table 4***Performance criteria for the AMA**

Criterion	Acceptable limits
Test concentrations	Maintained at ≤ 20 % CV (variability of measured test concentration) over the 21 day test
Mortality in controls	≤ 10 % — mortality in any one replicate in the controls should not exceed 2 tadpoles
Minimum median developmental stage of controls at end of test	57
Spread of development stage in control group	The 10th and the 90th percentile of the development stage distribution should not differ by more than 4 stages
Dissolved Oxygen	≥ 40 % air saturation (*)
pH	pH should be maintained between 6,5-8,5. The inter-replicate/inter-treatment differentials should not exceed 0,5.
Water temperature	$22^{\circ} \pm 1$ °C — the inter-replicate/inter-treatment differentials should not exceed 0,5 °C
Test concentrations without overt toxicity	≥ 2
Replicate performance	≤ 2 replicates across the test can be compromised

▼ **M6**

Criterion	Acceptable limits
Special conditions for use of a solvent	If a carrier solvent is used, both a solvent control and clean water control should be used and results reported
	Statistically significant differences between solvent control and water control groups are treated specially. See below for more information
Special conditions for static renewal system	Representative chemical analyses before and after renewal should be reported
	Ammonia levels should be measured immediately prior to renewal
	All water quality parameters listed in Table 1 of Appendix 1 should be measured immediately prior to renewal
	Renewal period should not exceed 72 hours
	Appropriate feeding schedule (50 % of the daily food ration of commercial tadpole feed)

(*) Aeration of water can be maintained through bubblers. It is recommended to set bubblers at levels that do not create undue stress on the tadpoles.

Test Validity

45. The following requirements should be met to deem a test acceptable/valid:

Valid experiment in a test determined to be negative for thyroid activity:

- (1) For any given treatment (including controls), mortality cannot exceed 10 %. For any given replicate, mortality cannot exceed three tadpoles, otherwise the replicate is considered compromised
- (2) At least two treatment levels, with all four uncompromised replicates, should be available for analysis
- (3) At least two treatment levels without overt toxicity should be available for analysis

Valid experiment in a test determined to be positive for thyroid activity:

- (1) Mortality of no more than two tadpoles/replicate in the control group can occur

Decision logic for the conduct of the AMA

46. Decision logic was developed for the AMA to provide logical assistance in the conduct and interpretation of the results of the bioassay (see flow chart in Figure 3). The decision logic, in essence, weighs the endpoints in that advanced development, asynchronous development and thyroid histopathology are weighed heavily, while delayed development, snout-vent length and wet body weight, parameters that can potentially be affected by general toxicity, are weighed less heavily.

▼ **M6**

Figure 3
Decision logic for the conduct of the AMA

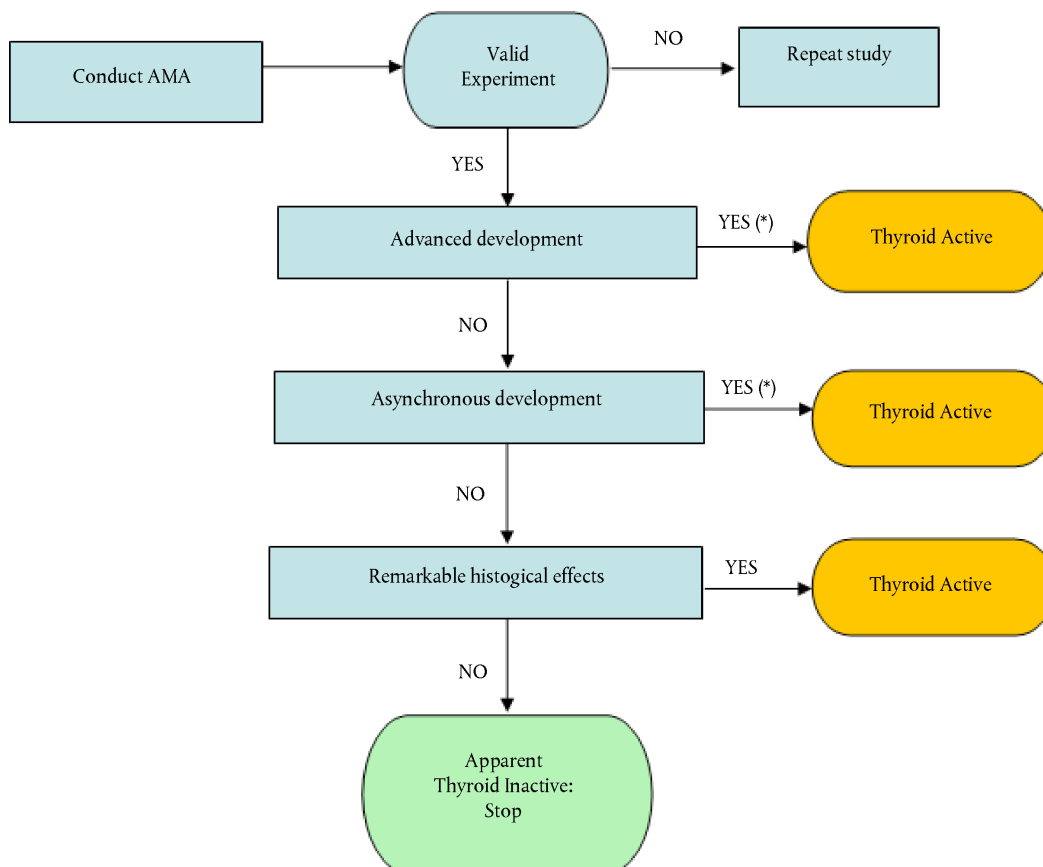

(*) Histology may be required by some regulatory authorities despite significant differences in advanced and asynchronous development. The entity performing this test is encouraged to consult the necessary authorities prior to the performing the test to determine which endpoints are required.

Advanced development (determined using developmental stage, SVL and HLL)

47. Advanced development is only known to occur through effects which are thyroid hormone related. These may be peripheral tissue effects such as direct interaction with the thyroid hormone receptor (such as with T4) or effects which alter circulating thyroid hormone levels. In either case, this is considered sufficient evidence to indicate that the chemical has thyroid activity. Advanced development is evaluated in one of two ways. First, the general developmental stage can be evaluated using the standardised approach detailed in Nieuwkoop and Faber (8). Second, specific morphological features may be quantified, such as hind limb length, at both days 7 and 21, which is positively associated with agonistic effects on the thyroid hormone receptor. If statistically significant advances in development or hind limb length occur, then the test indicates that the chemical is thyroid active.

▼ **M6**

48. The evaluation of test animals for the presence of accelerated development relative to the control population will be based on results of statistical analyses performed for the following four endpoints:

— hind limb length (normalised by SVL) on study day 7

— hind limb length (normalised by SVL) on study day 21

— developmental stage on study day 7

— developmental stage on study day 21.

49. Statistical analyses of hind limb length should be performed based on measurements of the length of the left hind limb. Hind limb length is normalised by taking the ratio hind limb length to snout-to-vent length of an individual. The mean of the normalised values for each treatment level are then compared. Acceleration of development is then indicated by a significant increase of mean hind limb length (normalised) in a chemical treatment group compared to the control group on study day 7 and/or study day 21 (see Appendix 3).

50. Statistical analyses of developmental stage should be performed based on determination of developmental stages according to the morphological criteria described by Nieuwkoop and Faber (8). Acceleration of development is indicated when the multi-quantal analysis detects a significant increase of developmental stage values in a chemical treatment group compared to the control group on study day 7 and/or study day 21.

51. In the AMA test method, a significant effect on any of the four endpoints mentioned above is regarded sufficient for a positive detection of accelerated development. That is, significant effects on hind limb length at a specific time point do not require corroboration by significant effects on hind limb length at the alternative time point nor by significant effects on developmental stage at this specific time point. In turn, significant effects on developmental stage at a specific time point do not require corroboration by significant effects at developmental stage on the alternative time point nor by significant effects on hind limb length at this specific time point. The weight of evidence for accelerated development will nevertheless increase if significant effects are detected for more than one endpoint.

Asynchronous development (determined using developmental stage criteria)

52. Asynchronous development is characterised by disruption of the relative timing of the morphogenesis or development of different tissues within a single tadpole. The inability to clearly establish the developmental stage of an organism using the suite of morphological endpoints considered typical of any given stage indicates that the tissues are developing asynchronously through metamorphosis. Asynchronous development is an indicator of thyroid activity. The only known modes of action causing asynchronous development are through effects of chemicals on peripheral thyroid hormone action and/or thyroid hormone metabolism in developing tissues such as is observed with deiodinase inhibitors.

▼ M6

53. The evaluation of test animals for the presence of asynchronous development relative to the control population will be based on gross morphological assessment of test animals on study day 7 and study day 21.

54. The description of normal development of *Xenopus laevis* by Nieuwkoop and Faber (8) provides the framework for identifying a sequential order of normal tissue remodelling. The term ‘asynchronous development’ refers specifically to those deviations in tadpole gross morphological development that disallow the definitive determination of a developmental stage according to the criteria of Nieuwkoop and Faber (8) because key morphological landmarks show characteristics of different stages.

55. As implicated by the term ‘asynchronous development’, only cases showing deviations in the progress of remodelling of specific tissues relative to the progress of remodelling of other tissues should be considered. Some classical phenotypes include delay or absence of fore limb emergence despite normal or advanced development of hind limbs and tail tissues, or the precocious resorption of gills relative to the stage of hind limb morphogenesis and tail resorption. An animal will be recorded as showing asynchronous development if it cannot be assigned to a stage because it fails to meet a majority of the landmark developmental criteria for a given Nieuwkoop and Faber stage (8), or if there is extreme delay or acceleration of one or more key features (e.g. tail completely resorbed, but forelimbs not emerged). This assessment is performed qualitatively and should examine the full suite of landmark features listed by Nieuwkoop and Faber (8). However it is not necessary to record the developmental state of the various landmark features of animals being observed. Animals recorded as showing asynchronous development are not assigned to a Nieuwkoop and Faber (8) development stage.

56. Thus, a central criterion for designating cases of abnormal morphological development as ‘asynchronous development’ is that the relative timing of tissue remodelling and tissue morphogenesis is disrupted whereas the morphology of affected tissues is not overtly abnormal. One example to illustrate this interpretation of gross morphological abnormalities is that retarded hind limb morphogenesis relative to development of other tissues will fulfil the criterion of ‘asynchronous development’ whereas cases showing missing hind limbs, abnormal digits (e.g. ectrodactyly, polydactyly), or other overt limb malformations should not be considered as ‘asynchronous development’.

57. In this context, the major morphological landmarks that should be evaluated for their coordinated metamorphic progress should include hind limb morphogenesis, fore limb morphogenesis, fore limb emergence, the stage of tail resorption (particularly the resorption of the tail fin), and head morphology (e.g. gill size and stage of gill resorption, lower jaw morphology, protrusion of Meckel's cartilage).

58. Dependent on the mode of chemical action, different gross morphological phenotypes can occur. Some classical phenotypes include delay or absence of fore limb emergence in spite of normal or advanced development of hind limbs and tail tissues, precocious gill resorption relative to hind limb and tail remodelling.

▼ **M6***Histopathology*

59. If the chemical does not cause overt toxicity and does not accelerate development or cause asynchronous development, then histopathology of the thyroid glands is evaluated using the appropriate guidance document (9). Developmental retardation, in the absence of toxicity, is a strong indicator of anti-thyroid activity, but the developmental stage analysis is less sensitive and less diagnostic than the histopathological analysis of the thyroid gland. Therefore, conducting histopathological analyses of the thyroid glands is required in this case. Effects on thyroid gland histology have been demonstrated in the absence of developmental effects. If changes in thyroid histopathology occur, then the chemical is considered to be thyroid active. If no developmental delays or histological lesions are observed in the thyroid glands, then the chemical is considered to be thyroid inactive. The rationale for this decision is that the thyroid gland is under the influence of TSH and any chemical which alters circulating thyroid hormone sufficiently to alter TSH secretion will result in histopathological changes in the thyroid glands. Various modes and mechanisms of action can alter circulating thyroid hormone. So, while thyroid hormone level is indicative of a thyroid related effect, it is insufficient to determine which mode or mechanism of action is related to the response.
60. Because this endpoint is not amenable to basic statistical approaches, the determination of an effect associated with exposure to a chemical shall be made through expert opinion by a pathologist.

Delayed development (determined using developmental stage, HLL, BW, SVL)

61. Delayed development can occur through anti-thyroidal mechanisms and through indirect toxicity. Mild developmental delays coupled with overt signs of toxicity likely indicate a non-specific toxic effect. Evaluation of non-thyroidal toxicity is an essential element of the test to reduce the probability of false positive outcomes. Excessive mortality is an obvious indication that other toxic mechanisms are occurring. Similarly, mild reductions in growth, as determined by wet weight and/or SVL length, also suggest non-thyroidal toxicity. Apparent increases in growth are commonly observed with chemicals that negatively affect normal development. Consequently, the presence of larger animals does not necessarily indicate non-thyroidal toxicity. However, growth should never be solely relied upon to determine thyroid toxicity. Rather, growth, in conjunction with developmental stage and thyroid histopathology, should be used to determine thyroid activity. Other endpoints should also be considered in determining overt toxicity including oedema, haemorrhagic lesions, lethargy, reduced food consumption, erratic/altered swimming behaviour, etc. If all test concentrations exhibit signs of overt toxicity, the test chemical should be re-evaluated at lower test concentrations before determining whether the chemical is potentially thyroid active or thyroid inactive.
62. Statistically significant developmental delays, in absence of other signs of overt toxicity, indicate that the chemical is thyroid active (antagonistic). In the absence of strong statistical responses, this outcome may be augmented with results from thyroid histopathology.

▼ M6**Statistical analyses**

63. Statistical analyses of the data should preferably follow procedures described in the document *Current Approaches in the Statistical Analysis of Ecotoxicity Data: A Guidance to Application* (11). For all continuous quantitative endpoints (HLL, SVL, wet weight) consistent with a monotone dose-response, the Jonckheere-Terpstra test should be applied in step-down manner to establish a significant treatment effect.

64. For continuous endpoints that are not consistent with a monotone dose-response, the data should be assessed for normality (preferably using the Shapiro-Wilk or Anderson-Darling test) and variance homogeneity (preferably using the Levene test). Both tests are performed on the residuals from an ANOVA. Expert judgment can be used in lieu of these formal tests for normality and variance homogeneity, though formal tests are preferred. Where non-normality or variance heterogeneity is found, a normalising, variance stabilising transformation should be sought. If the data (perhaps after a transformation) are normally distributed with homogeneous variance, a significant treatment effect is determined from Dunnett's test. If the data (perhaps after a transformation) are normally distributed with heterogeneous variance, a significant treatment effect is determined from the Tamhane-Dunnett or T3 test or from the Mann-Whitney-Wilcoxon U test. Where no normalising transformation can be found, a significant treatment effect is determined from the Mann-Whitney-Wilcoxon U test using a Bonferroni-Holm adjustment to the p-values. The Dunnett test is applied independently of any ANOVA F-test and the Mann-Whitney test is applied independently of any overall Kruskal-Wallis test.

65. Significant mortality is not expected but should be assessed from the step-down Cochran-Armitage test where the data are consistent with dose-response monotonicity, and otherwise from Fisher's Exact test with a Bonferroni-Holm adjustment.

66. A significant treatment effect for developmental stage is determined from the step-down application of the Jonckheere-Terpstra test applied to the replicate medians. Alternatively, and preferably, the multi-quantal Jonckheere test from the 20th to the 80th percentile should be used for effect determination, as it takes into account changes to the distribution profile.

67. The appropriate unit of analysis is the replicate so the data consist of replicate medians if the Jonckheere-Terpstra or Mann-Whitney U test is used, or the replicate means if Dunnett's test is used. Dose-response monotonicity can be assessed visually from the replicate and treatment means or medians or from formal tests such as previously described (11). With fewer than five replicates per treatment or control, the exact permutation versions of the Jonckheere-Terpstra and Mann-Whitney tests should be used if available. The statistical significance of all tests indicated is judged at the 0,05 significance level.

68. Figure 4 is a flow-chart for performing statistical tests on continuous data.

Figure 4

Flow-chart for statistical approaches for continuous response data

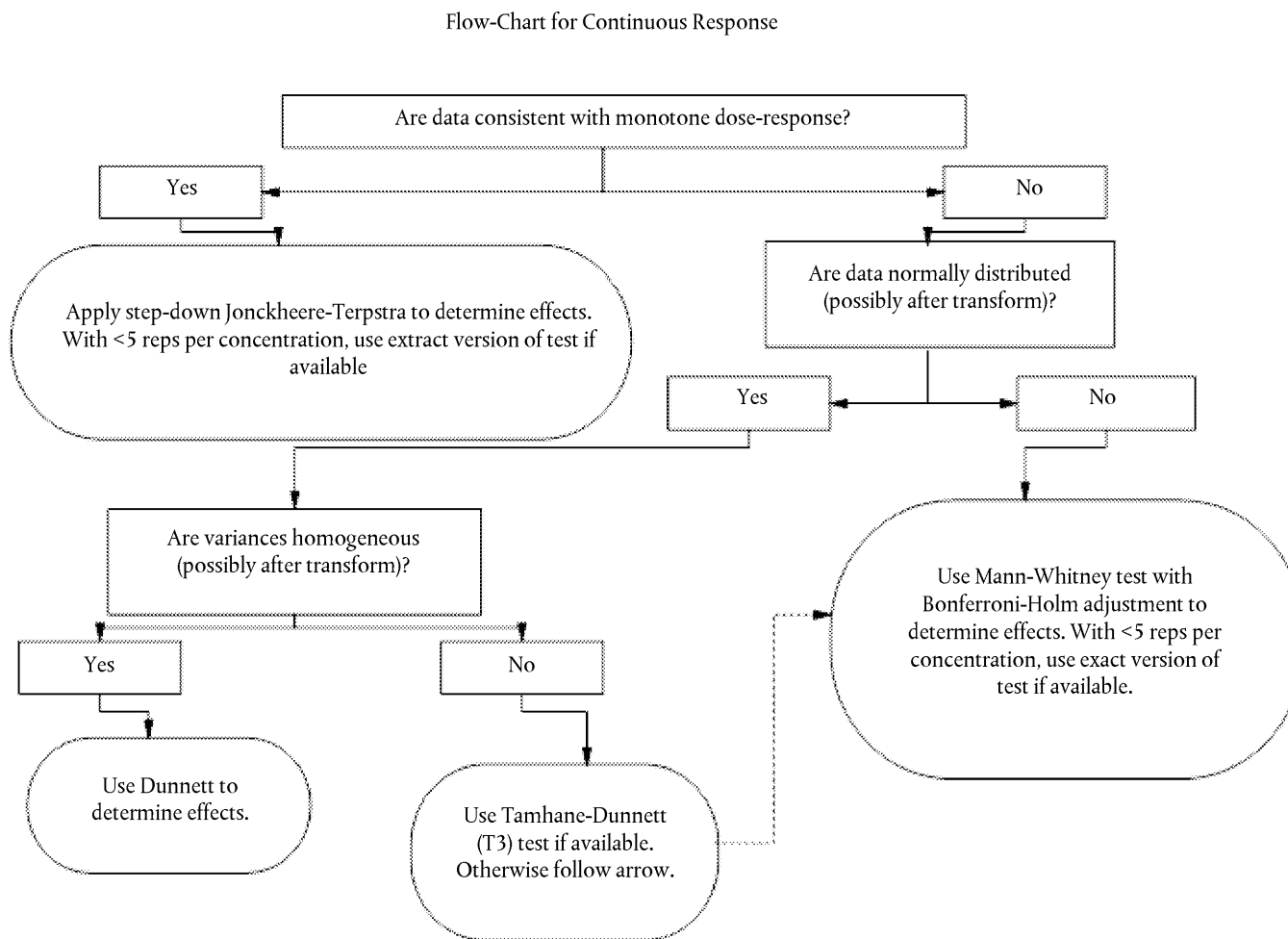

▼ M6**Special data analysis considerations***Use of compromised treatment levels*

69. Several factors are considered when determining whether a replicate or entire treatment demonstrates overt toxicity and should be removed from analysis. Overt toxicity is defined as > 2 mortalities in any replicate that can only be explained by toxicity rather than technical error. Other signs of overt toxicity include haemorrhage, abnormal behaviours, abnormal swimming patterns, anorexia and any other clinical signs of disease. For sub-lethal signs of toxicity, qualitative evaluations may be necessary, and should always be made in reference to the clean water control group.

Solvent controls

70. The use of a solvent should only be considered as a last resort, when all other chemical delivery options have been considered. If a solvent is used, then a clean water control should be run in concert. At the termination of the test, an evaluation of the potential effects of the solvent should be performed. This is done through a statistical comparison of the solvent control group and the clean water control group. The most relevant endpoints for consideration in this analysis are developmental stage, SVL and wet weight, as these can be affected through non-thyroidal toxicities. If statistically significant differences are detected in these endpoints between the clean water control and solvent control groups, determine the study endpoints for the response measures using the clean water control. If there is no statistically significant difference between the clean water control and solvent control for all measured response variables, determine the study endpoints for the response measures using the pooled dilution-water and solvent controls.

Treatment groups achieving developmental stage 60 and above

71. After stage 60, tadpoles show a reduction in size and weight due to tissue resorption and reduction of absolute water content. Thus, measurements of wet weight and SVL cannot appropriately be used in statistical analyses for differences in growth rates. Therefore, wet weight and length data from organisms > NF60 should be censored and cannot be used in analyses of replicate means or replicate medians. Two different approaches could be used to analyse these growth-related parameters.
72. One approach is to consider only tadpoles with developmental stages lower or equal to stage 60 for the statistical analyses of wet weight and/or SVL. This approach is believed to provide sufficiently robust information about the severity of possible growth effects as long as only a small proportion of test animals are removed from the analyses ($\leq 20\%$). If an increased number of tadpoles show development beyond stage 60 ($\geq 20\%$) in one or more nominal concentration(s), then a two-factor ANOVA with a nested variance structure should be undertaken on all tadpoles to assess growth effects due to chemical treatments while taking into account the effect of late stage development on growth. Appendix 3 provides guidance on the two-factor ANOVA analysis of weight and length.

LITERATURE

- (1) OECD (2004) Report of the Validation of the Amphibian Metamorphosis Assay for the detection of thyroid active substances: Phase 1 — Optimisation of the Test Protocol. Environmental Health and Safety Publications. Series on Testing and Assessment. No. 77, Paris.

▼ M6

- (2) OECD (2007) Final Report of the Validation of the Amphibian Metamorphosis Assay: Phase 2 — Multi-chemical Interlaboratory Study. Environmental Health and Safety Publications. Series on Testing and Assessment. No. 76. Paris
- (3) OECD (2008) Report of the Validation Peer Review for the Amphibian Metamorphosis Assay and Agreement of the Working Group of the National Coordinators of the Test Guidelines Programme on the Follow-up of this Report. Environmental Health and Safety Publications. Series on Testing and Assessment. No. 92. Paris
- (4) OECD (2000) Guidance Document on Aquatic Toxicity Testing of Difficult Substances and Mixtures. Environmental Health and Safety Publications. Series on Testing and Assessment. No. 23. Paris
- (5) ASTM (2002) Standard Guide for Conducting Acute Toxicity Tests on Test Materials with Fishes, Macroinvertebrates, and Amphibians. American Society for Testing and Materials, ASTM E729-96(2002), Philadelphia, PA
- (6) ASTM (2004) Standard Guide for Conducting the Frog Embryo Teratogenesis Assay — *Xenopus* (FETAX). E 1439-98
- (7) Kahl,M.D., Russom,C.L., DeFoe,D.L. & Hammermeister,D.E. (1999) Saturation units for use in aquatic bioassays. *Chemosphere* 39, pp. 539-551
- (8) Nieuwkoop,P.D. & Faber,J. (1994) Normal Table of *Xenopus laevis*. Garland Publishing, New York
- (9) OECD (2007) Guidance Document on Amphibian Thyroid Histology. Environmental Health and Safety Publications. Series on Testing and Assessment. No. 82. Paris
- (10) Dodd,M.H.I. & Dodd,J.M. (1976) Physiology of Amphibia. Lofts,B. (ed.), Academic Press, New York, pp. 467-599
- (11) OECD (2006) Current Approaches in the Statistical Analysis of Ecotoxicity Data: A Guidance to Application. Environmental Health and Safety Publications. Series on Testing and Assessment, No. 54. Paris
- (12) Hutchinson TH, Shillabeer N, Winter MJ, Pickford DB, 2006. Acute and chronic effects of carrier solvents in aquatic organisms: A critical review. *Review. Aquatic Toxicology*, 76; pp.69–92.

▼ **M6**

Appendix 1

Table 1

Experimental Conditions for the 21-day Amphibian Metamorphosis Assay

Test Animal	<i>Xenopus laevis</i> larvae	
Initial Larval Stage	Nieuwkoop and Faber stage 51	
Exposure Period	21 days	
Larvae Selection Criteria	Developmental stage and total length (optional)	
Test Concentrations	Minimum of 3 concentrations spanning approximately one order of magnitude	
Exposure Regime	Flow-through (preferred) and/or static-renewal	
Test System Flow-Rate	25 ml/min (complete volume replacement ca. every 2,7 h)	
Primary Endpoints/Determination Days	Mortality	Daily
	Developmental Stage	D 7 and 21
	Hind Limb Length	D 7 and 21
	Snout-Vent Length	D 7 and 21
	Wet Body Weight	D 7 and 21
	Thyroid Histology	D 21
Dilution Water/Laboratory Control	Dechlorinated tap water (charcoal-filtered) or the equivalent laboratory source	
Larval Density	20 larvae/test vessel (5/l)	
Test Solution/Test Vessel	4-10 l (10-15 cm minimum water)/Glass or Stainless Steel test vessel (e.g., 22,5 cm × 14 cm × 16,5 cm)	
Replication	4 replicate test vessels/test concentration and control	
Acceptable Mortality Rate in Controls	≤ 10 % per replicate test vessel	
Thyroid Fixation	Number Fixed	All tadpoles (5/replicate are evaluated initially)
	Region	Head or whole body
	Fixation Fluid	Davidson's fixative
Feeding	Food	Sera Micron® or equivalent
	Amount/Frequency	See Table 1 for feeding regime using Sera Micron®
Lighting	Photoperiod	12 h Light: 12 h dark

▼ M6

	Intensity	600 to 2 000 lux (Measured at Water Surface)
Water Temperature		22° ± 1 °C
pH		6,5 — 8,5
Dissolved Oxygen (DO) Concentration		> 3,5 mg/l (> 40 % Air Saturation)
Analytical Chemistry Sample Schedule		Once/Week (4 Sample Events/Test)

▼ **M6***Appendix 2***Reporting tables for raw data and summary data***Table 1***General test chemical information**

Chemical information			
Enter test chemical, concentration units, and treatments			
Test chemical:			
Concentration units:			
Treatment 1			
Treatment 2			
Treatment 3			
Treatment 4			
Date (day 0):			Enter date (mm/dd/yy)
Date (day 7):			Enter date (mm/dd/yy)
Date (day 21):			Enter date (mm/dd/yy)

*Table 2***Raw data collection sheets for days 7 and 21**

DAY X									
DATE 00/00/00									
	Concentration	Treatment Number	Replicate Number	Individual number	Individual Identifier	Developmental Stage	SVL Length (mm)	Hindlimb Length (mm)	Whole Organism wet weight (mg)
ROW	TRT	TRT#	REP	IND	ID#	STAGE	BL	HLL	WEIGHT
1	0,00	1							
2	0,00	1							
3	0,00	1							
4	0,00	1							
5	0,00	1							
6	0,00	1							
7	0,00	1							
8	0,00	1							

▼ M6

	Concentration	Treatment Number	Replicate Number	Individual number	Individual Identifier	Developmental Stage	SVL Length (mm)	Hindlimb Length (mm)	Whole Organism wet weight (mg)
ROW	TRT	TRT#	REP	IND	ID#	STAGE	BL	HLL	WEIGHT
9	0,00	1							
10	0,00	1							
11	0,00	1							
12	0,00	1							
13	0,00	1							
14	0,00	1							
15	0,00	1							
16	0,00	1							
17	0,00	1							
18	0,00	1							
19	0,00	1							
20	0,00	1							
21	0,00	2							
22	0,00	2							
23	0,00	2							
24	0,00	2							
25	0,00	2							
26	0,00	2							
27	0,00	2							
28	0,00	2							
29	0,00	2							
30	0,00	2							
31	0,00	2							
32	0,00	2							
33	0,00	2							

▼ M6

	Concentration	Treatment Number	Replicate Number	Individual number	Individual Identifier	Developmental Stage	SVL Length (mm)	Hindlimb Length (mm)	Whole Organism wet weight (mg)
ROW	TRT	TRT#	REP	IND	ID#	STAGE	BL	HLL	WEIGHT
34	0,00	2							
35	0,00	2							
36	0,00	2							
37	0,00	2							
38	0,00	2							
39	0,00	2							
40	0,00	2							
41	0,00	3							
42	0,00	3							
43	0,00	3							
44	0,00	3							
45	0,00	3							
46	0,00	3							
47	0,00	3							
48	0,00	3							
49	0,00	3							
50	0,00	3							
51	0,00	3							
52	0,00	3							
53	0,00	3							
54	0,00	3							
55	0,00	3							
56	0,00	3							
57	0,00	3							
58	0,00	3							

▼ M6

	Concentration	Treatment Number	Replicate Number	Individual number	Individual Identifier	Developmental Stage	SVL Length (mm)	Hindlimb Length (mm)	Whole Organism wet weight (mg)
ROW	TRT	TRT#	REP	IND	ID#	STAGE	BL	HLL	WEIGHT
59	0,00	3							
60	0,00	3							
61	0,00	4							
62	0,00	4							
63	0,00	4							
64	0,00	4							
65	0,00	4							
66	0,00	4							
67	0,00	4							
68	0,00	4							
69	0,00	4							
70	0,00	4							
71	0,00	4							
72	0,00	4							
73	0,00	4							
74	0,00	4							
75	0,00	4							
76	0,00	4							
77	0,00	4							
78	0,00	4							
79	0,00	4							
80	0,00	4							

▼ **M6**

Test Day	Date	1	2	3	4	1	2	3	4	1	2	3	4	1	2	3	4
6	#Value!																
7	#Value!																
8	#Value!																
9	#Value!																
10	#Value!																
11	#Value!																
12	#Value!																
13	#Value!																
14	#Value!																
15	#Value!																
16	#Value!																
17	#Value!																
18	#Value!																
19	#Value!																
20	#Value!																
21	#Value!																
Replicate count		0	0	0	0	0	0	0	0	0	0	0	0	0	0	0	0
Treatment Count		0				0				0				0			

Note: Cell calculations are associated with data entries into Table 1.

Table 5

Water Quality Criteria

Exposure System (flow-through/static renewal):

Temperature:

Light intensity:

Light-dark cycle:

Food:

Feeding rate:

water pH:

Iodine concentration in test water:

▼ **M6**

Table 6

Summary chemistry data

Chemical Name:																							
Cas #:																							
Test Day	Date	1	2	3	4	1	2	3	4	1	2	3	4	1	2	3	4	1	2	3	4		
0	00/00/00																						
1	#Value!																						
2	#Value!																						
3	#Value!																						
4	#Value!																						
5	#Value!																						
6	#Value!																						
7	#Value!																						
8	#Value!																						
9	#Value!																						
10	#Value!																						
11	#Value!																						
12	#Value!																						
13	#Value!																						
14	#Value!																						
15	#Value!																						
16	#Value!																						
17	#Value!																						
18	#Value!																						
19	#Value!																						
20	#Value!																						
21	#Value!																						

Note: Cell calculations are associated with data entries into Table 1.

▼ M6

Table 7

Histopathology reporting tables for core criteria

Date:

Chemical:

Pathologist:

Control Animal ID — replicate 2	Control Animal ID — replicate 1	Thyroid gland hypertrophy	Thyroid gland atrophy	Follicular cell hypertrophy	Follicular cell hyperplasia
Total:					

Dose Animal ID — replicate 2	Dose Animal ID — replicate 1	Thyroid gland hypertrophy	Thyroid gland atrophy	Follicular cell hypertrophy	Follicular cell hyperplasia
Total:					

Dose Animal ID — replicate 2	Dose Animal ID — replicate 1	Thyroid gland hypertrophy	Thyroid gland atrophy	Follicular cell hypertrophy	Follicular cell hyperplasia
Total:					

Dose Animal ID — replicate 2	Dose Animal ID — replicate 1	Thyroid gland hypertrophy	Thyroid gland atrophy	Follicular cell hypertrophy	Follicular cell hyperplasia
Total:					

▼ M6

Table 8

Additional histopathology criteria

Date:

Chemical:

Pathologist:

		Follicular lumen area increase	Follicular lumen area decrease
Control Animal ID — replicate 1			
Control Animal ID — replicate 2			
Total:			

		Follicular lumen area increase	Follicular lumen area decrease
Dose Animal ID — replicate 1			
Dose Animal ID — replicate 2			
Total:			

		Follicular lumen area increase	Follicular lumen area decrease
Dose Animal ID — replicate 1			
Dose Animal ID — replicate 2			
Total:			

		Follicular lumen area increase	Follicular lumen area decrease
Dose Animal ID — replicate 1			
Dose Animal ID — replicate 2			
Total:			

▼ M6

Table 9

Narrative descriptions for histopathological findings

Date:

Chemical:

Pathologist:

Narrative description

Control Animal ID — replicate 1		
Control Animal ID — replicate 2		
Dose Animal ID — replicate 1		
Dose Animal ID — replicate 2		

▼ M6

Dose Animal ID — replicate 1		
Dose Animal ID — replicate 2		

Dose Animal ID — replicate 1		
Dose Animal ID — replicate 2		

Table 10

Summary reporting table template for day x (7 or 21) of the AMA

Endpoint	Replicate	Control				Dose 1					Dose 2					Dose 3				
		Mean	SD	CV	N	Mean	SD	CV	N	p-value	Mean	SD	CV	N	p-value	Mean	SD	CV	N	p-value
Hind Limb Length (mm)	1																			
	2																			
	3																			
	4																			
	Mean:																			
SVL (mm)	1																			
	2																			
	3																			
	4																			
	Mean:																			
Wet weight (mg)	1																			
	2																			
	3																			
	4																			
	Mean:																			

Table 11

Summary reporting table template for day x (7 or 21) developmental stage data for the AMA

		Control				Dose 1					Dose 2					Dose 3				
	Replicate	Median	Min	Max	N	Median	Min	Max	N	p-value	Median	Min	Max	N	p-value	Median	Min	Max	Median	p-value
Developmental Stage	1																			
	2																			
	3																			
	4																			
	Mean:																			

▼ M6*Appendix 3***Alternative Analysis of weight and length in the case of late stage development exceeding 20 % of tadpoles in one or more concentration(s)**

If an increased number of tadpoles show development beyond stage 60 ($\geq 20\%$) in one or more nominal concentration(s), then a two-factor ANOVA with a nested variance structure should be undertaken on all tadpoles to assess growth effects due to chemical treatments while taking into account the effect of late stage development on growth.

The proposal is to use all data but take into account the effect of late stage development. This can be done with a two-factor ANOVA with a nested variance structure. Define LateStage = 'Yes' for an animal if its developmental stage is 61 or greater. Otherwise, define LateStage = 'No'. Then a two-factor ANOVA with concentration and LateStage and their interaction can be done, with Rep(Conc) a random factor and Tadpole(Rep) another random effect. This still treats the rep as the unit of analysis and gives essentially the same results as a weighted analysis of rep*latestage means, weighted by the number of animals per mean. If the data violate the normality or variance homogeneity requirements of ANOVA, then a normalised rank-order transform can be done to remove that objection.

In addition to the standard ANOVA F-tests for the effects of Conc, LateStage, and their interactions, the interaction F-test can be 'sliced' into two additional ANOVA F-test, one on the mean responses across concentrations for LateStage = 'No' and another on the mean responses across concentrations for LateStage = 'Yes'. Further comparisons of treatment means against control are done within each level of LateStage. A trend-type analysis can be done using appropriate contrasts or simple pairwise comparisons can be done if there is evidence of non-monotone dose-response within a level of the LateStage variable. A Bonferroni-Holm adjustment to the p-values is made only if the corresponding F-slice is not significant. This can be done in SAS and, presumably, other statistical software packages. Complications can arise when there are no late stage animals in some concentrations, but these situations can be handled in a straight-forward fashion.

▼ **M6**

Appendix 4

Definitions

Chemical: A substance or a mixture

Test chemical: Any substance or mixture tested using this test method.

▼ **M6****C.39. COLLEMBOLAN REPRODUCTION TEST IN SOIL**

INTRODUCTION

1. This test method is equivalent to OECD test guideline (TG) 232 (2009). This test method is designed for assessing the effects of chemicals on the reproductive output of the collembolans in soil. It is based on existing procedures (1) (2). The parthenogenetic *Folsomia candida* and sexually reproducing *Folsomia fimetaria* are two of the most accessible species of Collembola, and they are culturable and commercially available. When specific habitats not covered by the two species need to be assessed the procedure is extensible also to other species of Collembola if they are able to fulfil the validity criteria of the test.
2. Soil-dwelling Collembola are ecologically relevant species for ecotoxicological testing. Collembolans are hexapods with a thin exoskeleton highly permeable to air and water, and represent arthropod species with a different route and a different rate of exposure compared to earthworms and enchytraeids.
3. Population densities of Collembola commonly reach 10^5 m^{-2} in soil and leaf litter layers in many terrestrial ecosystems (3) (4). Adults typically measure 0,5 - 5 mm, their contribution to total soil animal biomass and respiration is low, estimated between 1 % and 5 % (5). Their most important role may therefore be as potential regulators of processes through microbivory and microfauna predation. Springtails are prey animals for a wide variety of endogeic and epigeic invertebrates, such as mites, centipedes, spiders, Carabidae and rove beetles. Collembola contribute to decomposition processes in acidic soils where they may be the most important soil invertebrates besides enchytraeids, since earthworms and diplopods are typically absent.
4. *F. fimetaria* has a worldwide distribution and is common in several soil types ranging from sandy to loamy soils and from mull to mor soils. It is an eyeless, unpigmented collembolan. It has been recorded in agricultural soils all over Europe (6). It has an omnivorous feeding habit, including fungal hyphae, bacteria, protozoa and detritus in its food. It interacts through grazing with infections of plant pathogenic fungi (7) and may influence mycorrhiza, as is known to be the case for *F. candida*. As most collembolan species it reproduces sexually requiring the permanent presence of males for egg fertilisation.
5. *F. candida* is also distributed worldwide. Although it is not common in most natural soils, it often occurs in very high numbers in humus rich sites. It is an eyeless, unpigmented collembolan. It has a well-developed furca (jumping organ) and an active running movement and jumps readily if disturbed. The ecological role of *F. candida* is similar to the role of *F. fimetaria*, but the habitats are more organic rich soils. It reproduces parthenogenetically. Males may occur at less than 1 per thousand.

PRINCIPLE OF THE TEST

6. Synchronous adult (*F. fimetaria*) or juvenile (*F. candida*) Collembola are exposed to a range of concentrations of the test chemical mixed into a modified artificial soil (8) using a 5 % organic matter content (or an alternative soil). The test scenario can be divided into two steps:

— A range-finding test, in case no sufficient information on toxicity is available, in which mortality and reproduction are the main

▼ M6

endpoints assessed after 2 weeks for *F. fimetaria* and 3 weeks for *F. candida*.

- A definitive reproduction test in which the total number of juveniles produced by parent animals and the survival of parent animals are assessed. The duration of this definitive test is 3 weeks for *F. fimetaria* or 4 weeks for *F. candida*.

The toxic effect of the test chemical on adult mortality and reproductive output is expressed as LC_x and EC_x by fitting the data to an appropriate model by non-linear regression to estimate the concentration that would cause x % mortality or reduction in reproductive output, respectively, or alternatively as the NOEC/LOEC value (9).

INFORMATION ON THE TEST CHEMICAL

7. The physical properties, water solubility, the $\log K_{ow}$, the soil water partition coefficient and the vapour pressure of the test chemical should preferably be known. Additional information on the fate of the test chemical in soil, such as the rates of photolysis and hydrolysis and biotic degradation, is desirable. Chemical identification of the test chemical according to IUPAC nomenclature, CAS-number, batch, lot, structural formula and purity should be documented when available.
8. This Test Method can be used for water soluble or insoluble chemicals. However, the mode of application of the test chemical will differ accordingly. The test method is not applicable to volatile chemicals, i.e. chemicals for which the Henry's constant or the air/water partition coefficient is greater than one, or chemicals for which the vapour pressure exceeds 0,0133 Pa at 25 °C.

VALIDITY OF THE TEST

9. The following criteria should be satisfied in the untreated controls for a test result to be considered valid:
 - Mean adult mortality should not exceed 20 % at the end of the test;
 - The mean number of juveniles per vessel should be at least 100 at the end of the test;
 - The coefficient of variation calculated for the number of juveniles should be less than 30 % at the end of the definitive test.

REFERENCE CHEMICAL

10. A reference chemical should be tested at its EC_{50} concentration for the chosen test soil type either at regular intervals or possibly included in each test run to verify that the response of the test organisms in the test system are within the normal level. A suitable reference chemical is boric acid, which should reduce reproduction by 50 % (10) (11) at about 100 mg/kg dry weight soil for both species.

DESCRIPTION OF THE TEST**Test vessels and equipment**

11. Containers capable of holding 30 g of moist soil are suitable test vessels. The material should either be glass or inert plastic (non-toxic). However, using plastic containers should be avoided if the test chemical exposure is decreased due to sorption. The test vessels should have a cross-sectional area allowing the actual soil depth within the test vessel to be 2-4 cm. The vessels should have lids (e.g. glass or polyethylene) that are designed

▼M6

to reduce water evaporation whilst allowing gas exchange between the soil and the atmosphere. The container should be at least partly transparent to allow light transmission.

12. Normal laboratory equipment is required, specifically the following:

- drying cabinet;
- stereo microscope;
- pH-meter and luxmeter;
- suitable accurate balances;
- adequate equipment for temperature control;
- adequate equipment for air humidity control (not essential if exposure vessels are covered by lids);
- temperature-controlled incubator or small room;
- forceps or a low-suction air flow device.

Preparation of the test soil

13. A modified artificial soil (8) is used with an organic matter content of 5 %. Alternatively a natural soil could be used, as the artificial soil does not resemble natural soils. The recommended composition of the artificial soil is as follows (based on dry weights, dried to a constant weight at 105 °C):

- 5 % sphagnum peat, air-dried and finely ground (a particle size of 2 ± 1 mm is acceptable);
- 20 % kaolin clay (kaolinite content preferably above 30 %);
- approximately 74 % air-dried industrial sand (depending on the amount of CaCO_3 needed), predominantly fine sand with more than 50 % of the particles between 50 and 200 microns. The exact amount of sand depends on the amount of CaCO_3 (see below), together they should add up to 75 %.
- 1,0 % calcium carbonate (CaCO_3 , pulverised, analytical grade) to obtain a pH of $6,0 \pm 0,5$; the amount of calcium carbonate to be added may depend principally on the quality/nature of the peat (see Note 1).

Note 1: The amount of CaCO_3 required will depend on the components of the soil substrate and should be determined by measuring the pH of pre-incubated moist soil sub-samples immediately before the test.

Note 2: It is recommended to measure the pH and optionally the C/N ratio, Cation Exchange Capacity (CEC) and organic matter content of the soil in order to enable a normalisation at a later stage and to better interpret the results.

Note 3: If required, e.g. for specific testing purposes, natural soils from unpolluted sites may also serve as test and/or culture substrate. However, if natural soil is used, it should be characterised at least by origin (collection site), pH, texture (particle size distribution), CEC and organic matter content and it should be free from any contamination. For natural soil it is advisable to demonstrate its suitability for a test and for achieving the test validity criteria before using the soil in a definitive test.

▼ M6

14. The dry constituents of the soil are mixed thoroughly (e.g. in a large-scale laboratory mixer). The maximum water holding capacity (WHC) of the artificial soil is determined in accordance with procedures described in Appendix 5. The moisture content of the testing soil should be optimised to attain a loose porous soil structure allowing collembolans to enter into the pores. This is usually between 40-60 % of the maximum WHC.
15. The dry artificial soil is pre-moistened by adding enough de-ionised water to obtain approximately half of the final water content 2-7 days before the test start, in order to equilibrate/stabilise the acidity. For the determination of pH a mixture of soil and 1 M potassium chloride (KCl) or 0,01 M calcium chloride (CaCl₂) solution in a 1:5 ratio is used (according to Appendix 6). If the soil is more acidic than the required range, it can be adjusted by addition of an appropriate amount of CaCO₃. If the soil is too alkaline it can be adjusted by the addition of an inorganic acid harmless to collembolans.
16. The pre-moistened soil is divided into portions corresponding to the number of test concentrations (and reference chemical where appropriate) and controls used for the test. The test chemicals are added and the water content is regulated according to the paragraph 24.

Selection and preparation of test animals

17. The parthenogenetic *F. candida* is the recommended species, as in the ring testing of the test method (11) this species met the validity criteria for survival more often than *F. fimetaria*. If an alternative species is used, it should meet the validity criteria outlined in paragraph 9. At the start of the test the animals should be well fed and the age between 23-26 days for *F. fimetaria* and 9-12 days for *F. candida*. For each replicate, the number of *F. fimetaria* should be 10 males and 10 females, and for *F. candida* 10 females should be used (see Appendix 2 and Appendix 3). The synchronous animals are selected randomly from the dishes and their health and physical condition is checked for each batch added to a replicate. Each group of 10/20 individuals is added to a randomly selected test container and the big females of *F. fimetaria* are selected to ensure a proper distinction from the *F. fimetaria* males.

Preparation of test concentrations

18. Four methods of application of the test chemical can be used: 1) mixing the test chemical into the soil with water as a carrier, 2) mixing the test chemical into the soil with an organic solvent as a carrier, 3) mixing the test chemical into the soil with sand as a carrier, or 4) application of the test chemical onto the soil surface. The selection of the appropriate method depends on the characteristic of the chemical and the purpose of the test. In general, mixing of the test chemical into the soil is recommended. However, application procedures that are consistent with the practical use of the test chemical may be required (e.g. spraying of liquid formulation or use of special pesticide formulations such as granules or seed dressings). The soil is treated before the collembolans are added, except when the test chemical is added to the soil surface collembolans should be allowed to enter the soil.

Test chemical soluble in water

19. A solution of the test chemical is prepared in deionised water in a quantity sufficient for all replicates of one test concentration. Each solution of test chemical is mixed thoroughly with one batch of pre-moistened soil before being introduced into the test vessel.

Test chemical insoluble in water

20. For chemicals insoluble in water, but soluble in organic solvents, the test chemical can be dissolved in the smallest possible volume of a suitable solvent (e.g. acetone) still ensuring proper mixing of the chemical in the soil and mixing it with a portion of the quartz sand required. Only volatile solvents should be used. When an organic solvent is used, all test concentrations and an additional solvent negative control should contain the same

▼ M6

minimum amount of the solvent. Application containers should be left uncovered for a certain period to allow the solvent associated with the application of the test chemical to evaporate, ensuring no dissipation of the toxic chemical during this time.

Test chemical poorly soluble in water and organic solvents

21. For chemicals that are poorly soluble in water and organic solvents, quartz sand, which should be a part of the total sand added to the soil, is mixed with the quantity of test chemical to obtain the desired test concentration. This mixture of quartz sand and test chemical is added to the pre-moistened soil and thoroughly mixed after adding an appropriate amount of deionised water to obtain the required moisture content. The final mixture is divided between the test vessels. The procedure is repeated for each test concentration and an appropriate control is also prepared.

Application of the test chemical onto the soil surface

22. When the test chemical is a pesticide, it may be appropriate to apply it onto the soil surface by spraying. The soil is treated after the collembolans are added. The test containers are first filled with the moistened soil substrate, and the animals added and then the test containers are weighted. In order to avoid any direct exposure of the animals with the test chemical by direct contact, the test chemical is applied at least half an hour after introducing the Collembola. The test chemical should be applied to the surface of the soil as evenly as possible using a suitable laboratory-scale spraying device to simulate spray application in the field. The application should take place at a temperature within ± 2 °C of variation and for aqueous solutions, emulsions or dispersions at a water application rate according to the risk assessment recommendations. The rate should be verified using an appropriate calibration technique. Special formulations like granules or seed dressings could be applied in a manner consistent with agricultural use. Food is added after spraying.

PROCEDURE**Test conditions**

23. The test mean temperature should be 20 ± 1 °C with a temperature range of 20 ± 2 °C. The test is carried out under controlled light-dark cycles (preferably 12 hours light and 12 hours dark) with illumination of 400 to 800 lux in the area of the test vessels.
24. In order to check the soil humidity, the vessels are weighed at the beginning, in the middle and at the end of the test. Weight loss > 2 % is replenished by the addition of de-ionised water. It should be noted that loss of water can be reduced by maintaining a high air-humidity (> 80 %) in the test incubator.
25. The pH should be measured at the beginning and the end of both the range-finding test and the definitive test. Measurements should be made in one extra control sample and one extra sample of the treated (all concentrations) soil samples prepared and maintained in the same way as the test cultures, but without addition of the collembolans.

Test procedure and measurements

26. For each test concentration, an amount of test soil corresponding to 30 g fresh weight is placed into the test vessel. Water controls, without the test chemical, are also prepared. If a vehicle is used for application of the test chemical, one control series containing the vehicle alone should be run in

▼ M6

- addition to the test series. The solvent or dispersant concentration should be the same as that used in the test vessels containing the test chemical.
27. The individual springtails are carefully transferred into each test vessel (allocated randomly to the test vessels) and placed onto the surface of the soil. For efficient transfer of the animals, a low-suction air flow device can be used. The number of replicates for test concentrations and for controls depends on the test design used. The test vessels are positioned randomly in the test incubator and these positions are re-randomised weekly.
 28. For the *F. fimetaria* test twenty adults, 10 males and 10 females, 23-26 days old should be used per test-vessel. On day 21 collembolans are extracted from the soil and counted. For *F. fimetaria* the gender are discriminated by size in the synchronised animal batch used for the test. Females are distinctively larger than the males (See Appendix 3)
 29. For the *F. candida* test, ten 9-12 days old juveniles per test vessel should be used. On day 28, the collembolans are extracted from the soil and counted.
 30. As a suitable food source, a sufficient amount, e.g. 2-10 mg, of granulated dried baker's yeast, commercially available for household use, is added to each container at the beginning of the test and after about 2 weeks.
 31. At the end of the test, mortality and reproduction are assessed. After 3 weeks (*F. fimetaria*) or 4 weeks (*F. candida*), collembolans are extracted from the test soil (see Appendix 4) and counted (12). A collembolan is recorded as dead if not present in the extraction. The extraction and counting method should be validated. The validity includes extraction efficiency of juveniles greater than 95 %, e.g. by adding a known number to soil.
 32. Practical summary and timetable of the test procedure are described in Appendix 2.

Test design*Range-finding test*

33. When necessary, a range-finding test is conducted with, for example, five test chemical concentrations of 0,1, 1,0, 10, 100, and 1 000 mg/kg dry weight of soil and two replicates for each treatment and control. Additional information, from tests with similar chemicals or from literature, on mortality or reproduction of Collembola may also be useful in deciding on the range of concentrations to be used in the range-finding test.
34. The duration of the range-finding test is two weeks for *F. fimetaria* and 3 weeks for *F. candida* to ensure one clutch of juveniles has been produced. At the end of the test, mortality and reproduction of the Collembola are assessed. The number of adults and the occurrence of juveniles should be recorded.

Definitive test

35. For determination of the EC_x (e.g. EC₁₀, EC₅₀), twelve concentrations should be tested. At least two replicates for each test concentration treatment and six control replicates are recommended. The spacing factor may vary depending on the dose-response pattern.

▼ M6

36. For determination of the NOEC/LOEC, at least five concentrations in a geometric series should be tested. Four replicates for each test concentration treatment plus eight controls are recommended. The concentrations should be spaced by a factor not exceeding 1,8.
37. A combined approach allows for determination of both the NOEC/LOEC and EC_x. For this combined approach, eight treatment concentrations in a geometric series should be used. Four replicates for each treatment plus eight controls are recommended. The concentrations should be spaced by a factor not exceeding 1,8.
38. If no effects are observed at the highest concentration in the range-finding test (i.e. 1 000 mg/kg), the reproduction test can be performed as a limit test, using a test concentration of 1 000 mg/kg and the control. A limit test will provide the opportunity to demonstrate that there is no statistically significant effect at the limit concentration. Eight replicates should be used for both the treated soil and the control.

DATA AND REPORTING**Treatment of results**

39. The reproductive output is the main endpoint (e.g. the number of juveniles produced per test vessel). The statistical analysis, e.g. ANOVA procedures, compares treatments by Student t-test, Dunnett's test, or Williams' test. 95 % confidence intervals are calculated for individual treatment means.
40. The number of surviving adults in the untreated controls is a major validity criterion and should be documented. As in the range-finding test, all other harmful signs should be reported in the final report as well.

LC_x and EC_x

41. EC_x-values, including their associated lower and upper 95 % confidence limits for the parameter, are calculated using appropriate statistical methods (e.g. logistic or Weibull function, trimmed Spearman-Kärber method, or simple interpolation). An EC_x is obtained by inserting a value corresponding to x % of the control mean into the equation found. To compute the EC₅₀ or any other EC_x, the complete data set should be subjected to regression analysis. LC₅₀ is usually estimated by probit analysis or similar analysis that takes into account the binomially distributed mortality data.

NOEC/LOEC

42. If a statistical analysis is intended to determine the NOEC/LOEC, per-vessel statistics (individual vessels are considered replicates) are necessary. Appropriate statistical methods should be used according to OECD Document 54 on the Current Approaches in the Statistical Analysis of Ecotoxicity Data: a Guidance to Application (9). In general, adverse effects of the test chemical compared to the control are investigated using one-tailed hypothesis testing at $p \leq 0,05$.
43. Normal distribution and variance homogeneity can be tested using an appropriate statistical test, e.g. the Shapiro-Wilk test and Levene test, respectively ($p \leq 0,05$). One-way Analysis of Variance (ANOVA) and subsequent multi-comparison tests can be performed. Multiple comparisons (e.g. Dunnett's test) or step-down trend tests (e.g. Williams' test) can be used to calculate whether there are significant differences ($p \leq 0,05$) between the controls and the various test chemical concentrations (selection of the recommended test according to OECD Document 54 (9)). Otherwise, non-parametric methods

▼ M6

(e.g. Bonferroni-U-test according to Holm or Jonckheere-Terpstra trend test) could be used to determine the NOEC and the LOEC.

Limit test

44. If a limit test (comparison of control and one treatment only) has been performed and the prerequisites of parametric test procedures (normality, homogeneity) are fulfilled, metric responses can be evaluated by the Student test (t-test). The unequal-variance t-test (Welch t-test) or a non parametric test, such as the Mann-Whitney-U-test may be used, if these requirements are not fulfilled.
45. To determine significant differences between the controls (control and solvent control), the replicates of each control can be tested as described for the limit test. If these tests do not detect significant differences, all control and solvent control replicates may be pooled. Otherwise all treatments should be compared with the solvent control.

Test report

46. The test report should at least include the following information:

Test chemical

- the identity of the test chemical, batch, lot and CAS-number, purity;
- physico-chemical properties of the test chemical (e.g. log Kow, water solubility, vapour pressure, Henry's constant (H) and preferably information on the fate of the test chemical in soil) if available;
- the formulation of the test chemical and the additives should be specified if not the pure chemical is tested;

Test organisms

- identification of species and supplier of the test organisms, description of the breeding conditions and age range of test organisms;

Test conditions

- description of the experimental design and procedure;
- preparation details for the test soil; detailed specification if natural soil is used (origin, history, particle size distribution, pH, organic matter content);
- water holding capacity of the soil;
- description of the technique used to apply the test chemical to the soil;
- test conditions: light intensity, duration of light-dark cycles, temperature;
- a description of the feeding regime, the type and amount of food used in the test, feeding dates;
- pH and water content of the soil at the start and end of the test (control and each treatment);
- detailed description of the extraction method and extraction efficiency;

▼ M6*Test results*

- the number of juveniles determined in each test vessel at the end of the test;
- number of adults and their mortality (%) in each test vessel at the end of the test;
- a description of obvious physiological or pathological symptoms or distinct changes in behaviour;
- the results obtained with the reference test chemical;
- the NOEC/LOEC values, LC_x for mortality and EC_x for reproduction (mostly LC₅₀, LC₁₀, EC₅₀, and EC₁₀) together with 95 % confidence intervals. A graph of the fitted model used for calculation, its function equation and its parameters (See (9));
- all information and observations helpful for the interpretation of the results;
- power of the actual test if hypothesis testing is done (9);
- deviations from procedures described in this Test Method and any unusual occurrences during the test;
- validity of the test;
- for NOEC, when estimated, the minimal detectable difference.

LITERATURE

- (1) Wiles JA and Krogh PH (1998) Testing with the collembolans *I. viridis*, *F. candida* and *F. fimetaria*. In Handbook of soil invertebrate toxicity tests (ed. H Løkke and CAM Van Gestel), pp. 131-156. John Wiley & Sons, Ltd., Chichester
- (2) ISO (1999) Soil Quality — Effects of soil pollutants on Collembola (*Folsomia candida*): Method for determination of effects on reproduction. No. 11267. International Organisation for Standardisation, Geneva
- (3) Burges A and Raw F (Eds) (1967) Soil Biology. Academic Press. London
- (4) Petersen H and Luxton M (1982) A comparative analysis of soil fauna populations and their role in decomposition processes. *Oikos* 39: 287-388
- (5) Petersen H (1994) A review of collembolan ecology in ecosystem context. *Acta Zoologica Fennica* 195: 111-118
- (6) Hopkin SP (1997). *Biology of the Springtails (Insecta: Collembola)*. Oxford University Press. 330pp (ISBN 0-19-854084-1)
- (7) Ulber B (1983) Einfluss von *Onychirurus fimatus* Gisin (Collembola, Onychiuridae) und *Folsomia fimetaria* L. (Collembola, Isotomidae) auf *Pythium ultimum* Trow. einen Erreger des Wurzelbrandes der Zuckerrübe. In New trends in soil Biology (Lebrun Ph, André HM, De Medts A, Grégoire-Wibo, Wauthy G (Eds), Proceedings of the VI. international colloquium on soil zoology, Louvain-la-neuve (Belgium), 30 August-2 September 1982, I Dieu-Brichart, Ottignies-Louvain-la-Neuve, pp. 261-268
- (8) Chapter C.36 of this Annex, *Predatory mite (Hypoaspis (Geolaelaps) aculeifer) reproduction test in soil*.
- (9) OECD (2006), Current approaches in the statistical analysis of ecotoxicity data: a guidance to application. OECD series on testing and assessment Number 54, ENV/JM/MONO(2006)18, OECD Paris
- (10) Scott-Fordsmann JJ and Krogh PH (2005) Background report on prevalidation of an OECD springtail test guideline. Environmental Project Nr. 986. Miljøstyrelsen 61 pp. Danish Ministry for the Environment.

▼M6

- (11) Krogh, P.H., 2009. Toxicity testing with the collembolans *Folsomia fimetaria* and *Folsomia candida* and the results of a ringtest. Danish Environmental Protection Agency, Environmental Project No. 1256, pp. 66.
- (12) Krogh PH, Johansen K and Holmstrup M (1998) Automatic counting of collembolans for laboratory experiments. *Appl. Soil Ecol.* 7, 201-205
- (13) Fjellberg A (1980) Identification keys to Norwegian collembolans. Norsk Entomologisk Forening.
- (14) Edwards C.A. (1955) Simple techniques for rearing Collembola, Symphyla and other small soil inhabiting arthropods. In *Soil Zoology* (Kevan D.K. McE., Ed). Butterworths, London, pp. 412-416
- (15) Goto HE (1960) Simple techniques for the rearing of Collembola and a note on the use of a fungistatic substance in the cultures. *Entomologists' Monthly Magazine* 96:138-140.

▼ M6*Appendix 1***Definitions**

The following definitions are applicable to this test method (in this test all effect concentrations are expressed as a mass of test chemical per dry mass of the test soil):

Chemical is a substance or a mixture.

NOEC (no observed effect concentration) is the test chemical concentration at which no effect is observed. In this test, the concentration corresponding to the NOEC, has no statistically significant effect ($p < 0,05$) within a given exposure period when compared with the control.

LOEC (lowest observed effect concentration) is the lowest test chemical concentration that has a statistically significant effect ($p < 0,05$) within a given exposure period when compared with the control.

EC_x (Effect concentration for x % effect) is the concentration that causes an x % of an effect on test organisms within a given exposure period when compared with a control. For example, an EC₅₀ is a concentration estimated to cause an effect on a test end point in 50 % of an exposed population over a defined exposure period.

Test chemical is any substance or mixture tested using this test method.

▼ **M6***Appendix 2***Main actions and timetable for performing a collembolan test**

The steps of the test can be summarised as follows:

Time (day)	Action
– 23 to – 26	Preparation of synchronous <i>F. fimetaria</i> culture
– 14	Prepare artificial soil (mixing of dry constituents) Check pH of artificial soil and adjust accordingly Measure max WHC of soil
– 9 to – 12	Preparation of synchronous <i>F. candida</i> culture
– 2 to – 7	Pre-moist soil
– 1	Distribute juveniles into batches Prepare stock solutions and apply test chemical if solvent required
0	Prepare stock solutions and apply test chemical if solid chemical, water soluble or surface application is required. Measure soil pH and weigh the containers. Add food. Introduce collembolans.
14	Range-finding test <i>F. fimetaria</i> : Terminate test, extract animals, measure soil pH and loss of water (weight) Definitive tests: Measure moisture content and replenish water and add 2-10 mg yeast
21	Definitive <i>F. fimetaria</i> test: Terminate test, extract animals, measure soil pH and loss of water (weight) Range-finding <i>F. candida</i> : Terminate test, extract animals, measure soil pH and loss of water (weight)
28	Definitive <i>F. candida</i> test: Terminate test, extract animals, measure soil pH and loss of water (weight)

▼ **M6***Appendix 3***Guidance on rearing and synchronisation of *F. fimetaria* and *F. candida***

The time and durations given in this guidance should be checked for each specific collembolan strain to ensure that timing will allow for sufficient synchronised juveniles. Basically, the incidence of oviposition after the adults are transferred to fresh substrate and egg hatching determines the appropriate day for egg collection and collection of synchronous juveniles.

It is recommended to have a permanent stock culture consisting of e.g. 50 containers/Petri dishes. The stock culture should be kept in a good feeding condition by weekly feeding, watering and removal of old food and carcasses. Too few collembolans on the substrate may result in inhibition by more fungal growth. If the stock culture is used for egg production too often, the culture may get fatigue. Signs of fatigue are dead adults and mould on the substrate. The remaining eggs from the production of synchronous animals can be used to rejuvenate the culture.

In a synchronous culture of *F. fimetaria*, males are distinguished from females primarily by size. Males are clearly smaller than females, and the walking speed of the males is faster than for females. Correct selection of the gender requires little practice and can be confirmed by microscopic inspection of the genital area (13).

1. Rearing**1.a. Preparation of culturing substrate**

The culturing substrate is plaster of Paris (calcium sulphate) with activated charcoal. This provides a moist substrate, with the function of the charcoal being to absorb waste gases and excreta (14) (15). Different forms of charcoal may be used to facilitate observations of the Collembola. For example, powdered charcoal is used for *F. candida* and *F. fimetaria* (producing a black/grey plaster of Paris):

Substrate constituents:

— 20 ml of activated charcoal

— 200 ml of distilled water

— 200 ml of plaster of Paris

or

— 50 g of activated pulverized charcoal

— 260-300 ml of distilled water

— 400 g plaster of Paris.

The substrate mixture is allowed to set before use.

1.b. Breeding

Collembolans are held in containers such as Petri dishes (90 mm × 13 mm), with the bottom covered by a 0,5 cm layer of plaster /charcoal substrate. They are cultured at 20 ± 1 °C at a light-dark cycle of 12-12 hours (400-800 Lux). Containers are kept moist at all times ensuring that the relative humidity of the air within the containers is 100 %. This can be guaranteed by presence of free water within the porous plaster, but avoiding generating

▼M6

a water film on the plaster surface. Water loss can be prevented by providing a humid ambient air. Any dead individuals should be removed from the containers, as should any mouldy food. To stimulate production of eggs it is necessary to transfer the adult animals to Petri dishes with newly prepared plaster of Paris/charcoal substrate.

1.c. *Food source*

Granulated dried baker's yeast is used as the sole food supply for both *F. candida* and *F. fimetaria*. Fresh food is provided once or twice a week, to avoid moulding. It is placed directly on the plaster of Paris in a small heap. The mass of baker's yeast added should be adjusted to the size of the collembolan population, but as a general rule 2-15 mg is sufficient.

2. **Synchronisation**

The test should be performed with synchronised animals to obtain homogeneous test animals of the same instar and size. Furthermore, the synchronisation enables discrimination of *F. fimetaria* males and females from the age of 3 weeks and onwards based on sexual dimorphism, i.e. size differences. The procedure below is a suggestion on how to obtain synchronised animals (the practical steps are optional).

2.a. *Synchronisation.*

- Prepare containers with a 0,5 cm layer of plaster of Paris/charcoal substrate.
- For egg laying transfer 150-200 adult *F. fimetaria* and 50-100 *F. candida* from the best 15-20 containers of the stock culture with 4-8 weeks old substrate to the containers and feed them 15 mg baker's yeast. Avoid bringing juveniles together with adults as presence of juveniles may inhibit egg production.
- Keep the culture at 20 ± 1 °C (the mean should be 20 °C) and a light-dark cycle of 12-12 hours (400-800 Lux). Ensure that fresh food is available and the air is water saturated. Lack of food may lead the animals to defecate on the eggs resulting in fungal growth on the eggs or *F. candida* may cannibalise its own eggs. After 10 days the eggs are carefully collected with a needle and spatula and moved to 'egg-paper' (small pieces of filter paper dipped in plaster of Paris/charcoal slurry) which is placed in a container with fresh plaster/charcoal substrate. A few grains of yeast are added to the substrate to attract the juveniles and make them leave the egg-paper. It is important that the egg-paper and substrate are humid, or the eggs will dehydrate. As an alternative, adult animals may be removed from the synchronisation culture boxes after producing eggs for 2 or 3 days.
- After three days most of the eggs on the egg-paper will have hatched, and some juveniles may be found under the egg-paper.
- To have evenly aged juveniles, the egg-paper with un-hatched eggs is removed from the Petri dish with forceps. The juveniles, now 0-3 days, stay in the dish and are fed baker's yeast. Un-hatched eggs are discharged.
- Eggs and hatched juveniles are cultured in the same manner as the adults. In particular for *F. fimetaria* the following measures should be taken: ensuring sufficient fresh food, old moulding food is removed, after 1 week the juveniles are divided into new Petri dishes provided that the density is above 200.

▼M6**2.b. Handling collembolans at test initiation**

- 9-12 days old *F. candida* or the 23-26 days old *F. fimetaria* are collected, e.g. by suction, and released into a small container with moist plaster/charcoal substrate and their physical condition is checked under the binocular (injured and damaged animals are disposed). All steps should be done while keeping the collembolans in a moist atmosphere to avoid drought stress, e.g. by using wetted surfaces etc.
- Turn the container up-side down and knock on it to transfer the collembolans to the soil. Static electricity should be neutralised, otherwise the animals may just fly into the air, or stick to the side of the test container and dry out. An ioniser or a moist cloth below the container may be used for neutralisation.
- The food should be spread all over the soil surface and not just in one lump.
- During transportation and during the testing period it should be avoided to knock or otherwise physically disturb the test containers, as this may increase the compaction of the soil, and hamper the interaction between the collembolans.

3. Alternative Collembolan species

Other collembolan species may be selected for testing according to this test method such as *Proisotoma minuta*, *Isotoma viridis*, *Isotoma anglicana*, *Orchesella cincta*, *Sinella curviseta*, *Paronychiurus kimi*, *Orthonychiurus folsomi*, *Mesaphorura macrochaeta*. A number of prerequisites should be fulfilled in advance before using alternative species:

- They should be unequivocally identified;
- The rationale for the selection of the species should be given;
- It should be ensured that the reproductive biology is included in the testing phase so it will be a potential target during the exposure;
- The life-history should be known: age at maturation, duration of egg development, and instars subject to exposure;
- Optimal conditions for growth and reproduction should be provided by the test substrate and food supply;
- Variability should be sufficiently low for precise and accurate toxicity estimation.

▼M6*Appendix 4***Extraction and counting of animals**

1. **Two methods of extraction can be performed.**
 - 1.a. First method: A controlled temperature gradient extractor based on principles by MacFadyen can be used (1). The heat coming from a heating element at the top of the extraction box (regulated through a thermistor placed on the surface of the soil sample). The temperature in the cooled liquid surrounding the collecting vessel is regulated through a thermistor situated at the surface of the collection box (placed below the soil core). The thermistors are connected to a programmable controlling unit which raises the temperature according to a pre-programmed schedule. Animals are collected in the cooled collecting box (2 °C) with a bottom layer of plaster of Paris/charcoal. Extraction is started at 25 °C and the temperature is increased automatically every 12 h by 5 °C and has a total duration of 48 hours. After 12 h at 40 °C the extraction is finished.
 - 1.b. Second method: After the experimental incubation period the number of juvenile Collembola present is assessed by flotation. For that purpose the test is performed in the vessels of approximately 250 ml volume. At the end of the test approx. 200 ml of distilled water are added. The soil is gently agitated with a fine paintbrush to allow Collembola to float to the water surface. A small amount, approx. 0,5 ml, of black Kentmere photographic dye may be added to the water to aid counting by increasing the contrast between the water and the white Collembola. The dye is not toxic to Collembola.
2. **Counting:**

Counts of numbers may be carried out by eye or under a light microscope using a grid placed over the floatation vessel or by photographing the surface of each vessel and later counting the Collembola on enlarged prints or projected slides. Counts may also be performed using digital image processing techniques (12). All techniques should be validated.

▼ M6*Appendix 5***Determination of the maximum WHC of the soil**

The following method for determining the maximum water holding capacity (WHC) of the soil has been found to be appropriate. It is described in Annex C of ISO DIS 11268-2 (Soil Quality — Effects of pollutants on earthworms (*Eisenia fetida*). Part 2: Determination of effects on reproduction).

Collect a defined quantity (e.g. 5 g) of the test soil substrate using a suitable sampling device (auger tube etc.). Cover the bottom of the tube with a wet piece of filter paper and then place it on a rack in a water bath. The tube should be gradually submerged until the water level is above to the top of the soil. It should then be left in the water for about three hours. Since not all water absorbed by the soil capillaries can be retained, the soil sample should be allowed to drain for a period of two hours by placing the tube onto a bed of very wet finely ground quartz sand contained within a covered vessel (to prevent drying). The sample should then be weighed, dried to constant mass at 105 °C. The water holding capacity (WHC) should be calculated as follows:

$$\text{WHC (in \% of dry mass)} = \frac{S - T - D}{D} \times 100$$

Where:

S = water-saturated substrate + mass of tube + mass of filter paper

T = tare (mass of tube + mass of filter paper)

D = dry mass of substrate

▼M6*Appendix 6***Determination of soil pH**

The following method for determining the pH of a soil is based on the description given in ISO DIS 10390: Soil Quality — Determination of pH.

A defined quantity of soil is dried at room temperature for at least 12 h. A suspension of the soil (containing at least 5 grams of soil) is then made up in five times its volume of either a 1 M solution of analytical grade potassium chloride (KCl) or a 0,01 M solution of analytical grade calcium chloride (CaCl₂). The suspension is then shaken thoroughly for five minutes and then left to settle for at least 2 hours but not for longer than 24 hours. The pH of the liquid phase is then measured using a pH-meter that has been calibrated before each measurement using an appropriate series of buffer solutions (e.g. pH 4,0 and 7,0).

▼ M6**C.40. SEDIMENT-WATER CHIRONOMID LIFE-CYCLE TOXICITY TEST USING SPIKED WATER OR SPIKED SEDIMENT**

INTRODUCTION

1. This test method is equivalent to OECD Testing Guideline (TG) 233 (2010). It is designed to assess the effects of life-long exposure of chemicals on the freshwater dipteran *Chironomus* sp., fully covering the 1st generation (P generation) and the early part of the 2nd generation (F1 generation). It is an extension of the existing test methods C.28 (1) or C.27 (15) using a spiked-water exposure scenario or a spiked sediment scenario, respectively. It takes into account existing toxicity test protocols for *Chironomus riparius* and *Chironomus dilutus* (previously named *C. tentans* (2)) that have been developed in Europe and North America (3) (4) (5) (6) (7) (8) (9) and subsequently ring-tested (1) (7) (10) (11) (12). Other well documented chironomid species may also be used, e.g. *Chironomus yoshimatsui* (13) (14). The complete exposure duration is ca. 44 days for *C. riparius* and *C. yoshimatsui*, and –ca. 100 days for *C. dilutus*.

2. Both water and sediment exposure scenarios are described in this test method. The selection of an appropriate exposure scenario depends on the intended application of the test. The water exposure scenario, spiking of the water column, is intended to simulate a pesticide spray drift event and covers the initial peak concentration in surface waters. Water spiking is also useful for other types of exposure (including chemical spills), but not for accumulation processes within the sediment lasting longer than the test period. In that case, and also when run-off is the main entry route of pesticides into water bodies, a spiked sediment design may be more appropriate. If other exposure scenarios are of interest, the test design may be readily adapted. For example, if the distribution of the test chemical between the water phase and the sediment layer is not of interest and adsorption to the sediment has to be minimised, the use of surrogate artificial sediment (e.g. quartz sand) may be considered.

3. Chemicals that require testing of sediment-dwelling organisms may persist in sediment over long periods. Sediment-dwelling organisms may be exposed via a number of routes. The relative importance of each exposure route, and the time taken for each to contribute to the overall toxic effect, is dependent on the physical-chemical properties of the chemical. For strongly adsorbing chemicals or for chemicals covalently binding to sediment, ingestion of contaminated food may be a significant exposure route. In order not to underestimate the toxicity of highly lipophilic chemicals, the use of food added to the sediment before application of the test chemical may be considered (see paragraph 31). Therefore, it is possible to include all routes of exposure and all life stages.

4. Measured endpoints are the total number of adults emerged (for both 1st and 2nd generations), development rate (for both 1st and 2nd generations), sex ratio of fully emerged and alive adults (for both 1st and 2nd generations), number of egg ropes per female (1st generation only) and fertility of the egg ropes (1st generation only).

5. Formulated sediment is strongly recommended. Formulated sediment has several advantages over natural sediments:

▼ M6

- experimental variability is reduced because it forms a reproducible ‘standardised matrix’ and the need to source uncontaminated clean sediment is eliminated;
 - tests can be initiated at any time without encountering seasonal variability in the test sediment and there is no need to pre-treat the sediment to remove indigenous fauna;
 - reduced cost compared to field collection of sufficient quantities required for routine testing;
 - formulated sediment allows for comparisons of toxicity across studies and ranking chemicals accordingly (3).
6. Definitions used are given in Appendix 1.

PRINCIPLE OF THE TEST

7. First instar chironomid larvae are exposed to a concentration range of the test chemical in a sediment-water system. The test starts by placing first instar larvae (1st generation) into test beakers containing spiked sediment or alternately the test chemical is spiked into the water after addition of the larvae. Chironomid emergence, time to emergence and sex ratio of the fully emerged and alive midges are assessed. Emerged adults are transferred to breeding cages, to facilitate swarming, mating and oviposition. The number of egg ropes produced and their fertility are assessed. From these egg ropes, first instar larvae of the 2nd generation are obtained. These larvae are placed into freshly prepared test beakers (spiking procedure as for the 1st generation) to determine the viability of the 2nd generation through an assessment of their emergence, time to emergence and the sex ratio of the fully emerged and alive midges (a schematic presentation of the life-cycle test is provided in Appendix 5). All data are analysed either by a regression model to estimate the concentration that would cause X % reduction in the relevant endpoint, or by using hypothesis testing to determine a No Observed Effect Concentration (NOEC). The latter requires a comparison of treatment responses with the appropriate control responses using statistical tests. It should be noted that in the spiked water scenario, in case of fast degrading chemicals, the later life stages of each generation (e.g. pupal phase) might be exposed to a considerably lower concentration level in the overlying water than the 1st instar larvae. If this is a concern, and a comparable exposure level for each life stage is needed, the following amendments of the test method might be considered:
- parallel runs with spiking at different life stages, or
 - repeated spiking (or overlying water renewal) of the test system during both test phases (1st and 2nd generation), whereby the spiking (renewal) intervals should be adjusted to the fate characteristics of the test chemical.

Such amendments are only feasible in the spiked water scenario, but not in the sediment spiked scenario.

INFORMATION ON THE TEST CHEMICAL

8. The water solubility of the test chemical, its vapour pressure and $\log K_{ow}$, measured or calculated partitioning into sediment and stability in water and sediment should be known. A reliable analytical method for the quantification of the test chemical in overlying water, pore water and sediment with known and reported accuracy and limit of detection should be available. Useful information includes the structural formula

▼ M6

and purity of the test chemical. Chemical fate of the test chemical (e.g. dissipation, abiotic and biotic degradation, etc.) is also useful. Further guidance for testing chemicals with physical-chemical properties that make them difficult to perform the test is provided in (16).

REFERENCE CHEMICALS

9. Reference chemicals may be tested periodically as a means of assuring that the sensitivity of the laboratory population has not changed. As with daphnids it would be sufficient to perform a 48-h acute test (following 17). However, until a validated acute guideline is available a chronic test according to Chapter C.28 of this Annex may be considered. Examples of reference toxicants used successfully in ring-tests and validation studies are: lindane, trifluralin, pentachlorophenol, cadmium chloride and potassium chloride. (1) (3) (6) (7) (18).

VALIDITY OF THE TEST

10. For the test to be valid the following conditions apply:
- the mean emergence in the control treatment should be at least 70 % at the end of the exposure period for both generations (1) (7);
 - for *C. riparius* and *C. yoshimatsui*, 85 % of the total emerged adult midges from the control treatment in both generations should occur between 12 and 23 days after the insertion of the first instar larvae into the vessels; for *C. dilutus*, a period of 20 to 65 days is acceptable;
 - the mean sex ratio of fully emerged and alive adults (as female or male fraction) in the control treatment of both generations should be at least 0,4, but not exceed 0,6;
 - for each breeding cage the number of egg ropes in the controls of the 1st generation should be at least 0,6 per female added to the breeding cage;
 - the fraction of fertile egg ropes in each breeding cage of the controls of the 1st generation should be at least 0,6;
 - at the end of the exposure period for both generations, pH and the dissolved oxygen concentration should be measured in each vessel. The oxygen concentration should be at least 60 % of the air saturation value (ASV ⁽¹⁾), and the pH of overlying water should be between 6 and 9 in all test vessels;
 - the water temperature should not differ by more than $\pm 1,0$ °C.

DESCRIPTION OF THE METHOD

Test vessels and breeding cages

11. The larvae are exposed in 600 ml glass beakers measuring ca. 8,5 cm in diameter (see Appendix 5). Other vessels are suitable, but they should guarantee a suitable depth of overlying water and sediment. The sediment surface should be sufficient to provide 2 to 3 cm² per larvae. The ratio of the depth of the sediment layer to the depth of the overlying water should be ca. 1:4. Breeding cages (minimum 30 cm in all three dimensions) with a gauze (mesh size ca. 1 mm) on the top and one side of the cage as a

⁽¹⁾ At 20 °C under standard atmospheric pressure the ASV in freshwater equals 9,1 mg/l (60 % equals 5,46 mg/l)

▼ **M6**

minimum should be used (see Appendix 5). In each cage a 2 l crystallising dish, containing test water and sediment, is placed for oviposition. Also for the crystallising dish, the ratio of the depth of the sediment layer to the depth of the overlying water should be around 1:4. After egg ropes are collected from the crystallising dish they are placed into a 12-well microtiter plate (one rope per well containing at least 2,5 ml water from the spiked crystallising dish) after which the plates are covered with a lid to prevent significant evaporation. Other vessels suitable for keeping the egg ropes may also be used. With the exception of the microtiter plates, all test vessels and other apparatus that will come into contact with the test system should be made entirely of glass or other chemically inert material (e.g. Polytetrafluoroethylene).

Selection of species

12. The species to be used in the test is preferably *Chironomus riparius*. *C. yoshimatsui* may also be used. *C. dilutus* is also suitable but more difficult to handle and requires a longer test period. Details of culturing methods are given in Appendix 2 for *C. riparius*. Information on culture conditions are also available for *C. dilutus* (5) and *C. yoshimatsui* (14). Identification of the species should be confirmed before testing but is not required prior to every test if the organisms come from an in-house culture.

Sediment

13. Formulated sediment (also called reconstituted, artificial or synthetic sediment) should preferably be used. However, if natural sediment is used, it should be characterised (at least pH, organic carbon content, determination of other parameters such as C/N ratio and granulometry are also recommended) and should be free from any contamination and other organisms that may compete with, or consume chironomid larvae. It is also recommended, before testing, that sediments are conditioned for seven days under test conditions. The following formulated sediment, as described in (1), is recommended (1) (20) (21):
 - (a) 4-5 % (dry weight) peat: as close to pH 5,5 to 6,0 as possible; it is important to use peat in powder form, finely ground (particle size \leq 1 mm) and only air dried;
 - (b) 20 % (dry weight) kaolin clay (kaolinite content preferably above 30 %);
 - (c) 75-76 % (dry weight) quartz sand (fine sand should predominate with more than 50 per cent of the particles between 50 and 200 μ m);
 - (d) Deionised water is added to obtain moisture of the final mixture in the range of 30–50 %;
 - (e) Calcium carbonate of chemically pure quality (CaCO_3) is added adjust the pH of the final mixture of the sediment to $7,0 \pm 0,5$;
 - (f) Organic carbon content of the final mixture should be 2 % ($\pm 0,5$ %) and is to be adjusted by the use of appropriate amounts of peat and sand, according to (a) and (c).
14. The source of peat, kaolin clay and sand should be known. The sediment components should be checked for the absence of chemical contamination

▼ M6

(e.g. heavy metals, organochlorine compounds, organophosphorous compounds). An example for the preparation of the formulated sediment is described in Appendix 3. Mixing of dry constituents is also acceptable if it is demonstrated that after addition of overlying water a separation of sediment constituents (e.g. floating of peat particles) does not occur, and that the peat or the sediment is sufficiently conditioned.

Water

15. Any water which conforms to the chemical characteristics of acceptable dilution water as listed in Appendices 2 and 4 is suitable as test water. Any suitable water, natural water (surface or ground water), reconstituted water (see Appendix 2) or dechlorinated tap water are acceptable as culturing water and test water, if chironomids will survive in it for the duration of the culturing and testing without showing signs of stress. At the start of the test, the pH of the test water should be between 6 and 9 and the total hardness not higher than 400 mg/l as CaCO₃. However, if there is an interaction suspected between hardness ions and the test chemical, lower hardness water should be used (and thus, Elendt Medium M4 should not be used in this situation). The same type of water should be used throughout the entire study. The water quality characteristics listed in Appendix 4 should be measured at least twice a year or when it is suspected that these characteristics may have changed significantly.

Stock solutions — Spiked water

16. a. Test concentrations are calculated on the basis of water column concentrations, i.e. the water overlying the sediment. Test solutions of the chosen concentrations are usually prepared by dilution of a stock solution. Stock solutions should preferably be prepared by dissolving the test chemical in test water. The use of solvents or dispersants may be required in some cases in order to produce a suitably concentrated stock solution. Examples of suitable solvents are acetone, ethylene glycol monoethyl ether, ethylene glycol dimethylether, dimethylformamide and triethylene glycol. Dispersants which may be used are Cremophor RH40, Tween 80, methylcellulose 0,01 % and HCO-40. The solubilising agent concentration in the final test medium should be minimal (i.e. $\leq 0,1$ ml/l) and should be the same in all treatments. When a solubilising agent is used, it should have no significant effects on survival as revealed by a solvent control in comparison with a negative (water) control. However, every effort should be made to avoid the use of such materials.

Stock solutions — Spiked sediment

16. b. Spiked sediments of the chosen concentration are usually prepared by addition of a solution of the test chemical directly to the sediment. A stock solution of the test chemical dissolved in deionised water is mixed with the formulated sediment by rolling mill, feed mixer or hand mixing. If poorly soluble in water, the test chemical can be dissolved in as small a volume as possible of a suitable organic solvent (e.g. hexane, acetone or chloroform). This solution is then mixed with 10 g of fine quartz sand for each test vessel. The solvent is allowed to evaporate and it should be totally removed from sand; the sand is then mixed with the suitable amount of sediment. Only agents which volatilise readily can be used to solubilise, disperse or emulsify the test chemical. It should be born in mind that the sand provided by the test chemical and sand mixture, should be taken into account when preparing the sediment (i.e. the sediment should thus be prepared with less sand). Care should be taken to ensure that the test chemical added to sediment is thoroughly and

▼ M6

evenly distributed within the sediment. If necessary, subsamples can be analysed to determine degree of homogeneity.

TEST DESIGN

17. The test design relates to the selection of the number and spacing of the test concentrations, the number of vessels at each concentration, the number of larvae per vessel, the number of crystallising dishes and breeding cages. Designs for EC_x, NOEC and a limit test are described below.

Design for analysis by regression

18. The effect concentration (EC_x) and the concentration range over which the effect of the test chemical is of interest, should be spanned by the test, such that the endpoint is not extrapolated outside the bounds of the data generated. Extrapolation much below the lowest or above the highest concentration should be avoided. A preliminary range-finding test according to Test Methods C.27 or C.28 may be helpful for selecting a suitable range of test concentrations.

19. For an EC_x approach, at least five concentrations and eight replicates for each concentration are required. For each concentration two breeding cages should be used (A and B). The eight replicates are divided into two groups of four replicates to serve each breeding cage. This merger of replicates is necessary due to the number of midges needed in the cage for sound reproduction assessments. However, the 2nd generation has eight replicates again, which are initiated from the exposed populations in the breeding cages. The factor between concentrations should not be greater than two (an exception could be made in cases when the dose response curve has a shallow slope). The number of replicates at each treatment can be reduced to six (three for each breeding case) if the number of test concentrations with different responses is increased. Increasing the number of replicates or reducing the size of the test concentration intervals tends to lead to narrower confidence intervals around the EC_x.

Design for estimation of a NOEC

20. For a NOEC approach, five test concentrations with at least eight replicates (4 for each breeding cage, A and B) should be used and the factor between concentrations should not be greater than two. The number of replicates should be sufficient to ensure adequate statistical power to detect a 20 % difference from the control at the 5 % level of significance ($\alpha = 0.05$). For the development rate, fecundity and fertility an analysis of variance (ANOVA) is usually appropriate, followed by Dunnett's test or Williams' test (22-25). For the emergence ratio and sex ratio the Cochran-Armitage, Fisher's exact (with Bonferroni correction), or Mantel-Haentzel tests may be appropriate.

Limit test

21. A limit test may be performed (one test concentration and control(s)) if no effects are observed in the optional preliminary range-finding test up to a maximum concentration. The purpose of the limit test is to indicate that

▼ M6

any toxic effects of the test chemical are found at levels greater than the limit concentration tested. For water, 100 mg/l and for sediment 1 000 mg/kg (dry weight) are suggested. Usually, at least eight replicates for both the treatment and control are necessary. Adequate statistical power to detect a 20 % difference from the control at the 5 % level of significance ($\alpha = 0,05$) should be demonstrated. With metric responses (e.g. development rate), the t-test is a suitable statistical method if data meet the requirements of this test (normality, homogeneous variances). An unequal-variance t-test or a non-parametric test, such as the Wilcoxon-Mann-Whitney test may be used, if these requirements are not fulfilled. With the emergence ratio, Fisher's exact test is appropriate.

PROCEDURE**Conditions of exposure***Preparation of the water-sediment system (water spiking)*

22. a. Formulated sediment (see paragraphs 13-14 and Appendix 3) is added to each test vessel and crystallising dish to form a layer of at least 1,5 cm (for the crystallising dish it may be somewhat lower) but maximally 3 cm. Water (see paragraph 15) is added so that the ratio of the depth of the sediment layer and the depth of the water does not exceed 1:4. After preparation of the test vessels the sediment-water system should be left under gentle aeration for approximately seven days prior to addition of the first instar larvae of the 1st or 2nd generation (see paragraph 14 and Appendix 3). The sediment-water system of the crystallising dishes is not aerated during the test, since they do not need to support larval survival (before hatching the egg ropes are already collected). To avoid separation of sediment ingredients and re-suspension of fine material during addition of test water in the water column, the sediment can be covered with a plastic disc while water is poured onto it. The disc is removed immediately afterwards. Other devices may also be appropriate.

Preparation of the water-sediment system (spiked sediment)

22. b. The spiked sediments prepared according to paragraph 16b are placed in the vessels and crystallising dish and overlying water is added to produce a sediment-water volume ratio of 1:4. The depth of the sediment layer should be in the range of 1,5 to 3 cm (it may be somewhat lower for the crystallising dish). To avoid separation of sediment ingredients and re-suspension of fine material during addition of test water in the water column, the sediment can be covered with a plastic disc while water is poured onto it, and the disc removed immediately afterwards. Other devices may also be appropriate. Once the spiked sediment with overlying water has been prepared, it is desirable to allow partitioning of the test chemical from the sediment to the aqueous phase (4) (5) (7) (18). This should preferably be done under the conditions of temperature and aeration used in the test. Appropriate equilibration time is sediment and chemical specific, and can be in the order of hours to days and in rare cases up to five weeks. As this would leave time for degradation of many chemicals, equilibrium is not awaited but an equilibration period of 48 hours is recommended. However, when the degradation half-life of the chemical in sediment is known to be long (see paragraph 8), the equilibration time may be extended. At the end of this further equilibration period, the concentration of the test chemical should be measured in the overlying water, the pore water and the sediment, at least at the highest concentration and a lower one (see paragraph 38). These analytical determinations of the test chemical allow for calculation of a mass balance and expression of results based on measured concentrations.

23. Test vessels should be covered (e.g. by glass plates). If necessary, during the study the water levels may be topped up to the original volume in

▼ M6

order to compensate for evaporation. This should be performed using distilled or deionised water to prevent any build-up of salts. Crystallising dishes in the breeding cages are not covered and may, but do not need to be adjusted to compensate for water loss during the test period, since the egg ropes are only in contact with the water for about one day and the dishes are only used during a short phase of the test.

Addition of test organisms

24. Four to five days before adding the first instar larvae for the 1st generation, egg masses should be taken from the culture and placed in small vessels in culture medium. Aged medium from the stock culture or freshly prepared medium may be used. In any case, a small amount of food, e.g. a few droplets of filtrate from a finely ground suspension of flaked fish food, should be added to the culture medium (see Appendix 2). Only freshly laid egg masses should be used. Normally, the larvae begin to hatch a couple of days after the eggs are laid (2 to 3 days for *C. riparius* at 20 °C and 1 to 4 days for *C. dilutus* at 23 °C and *C. yoshimatsui* at 25 °C) and larval growth occurs in four instars, each of 4-8 days duration. First instar larvae (maximum 48 h post hatching) should be used in the test. The instar stage of larvae can potentially be checked using head capsule width (7).
25. Twenty first instar larvae for the 1st generation are allocated randomly to each test vessel containing the sediment-water system, using a blunt pipette. Aeration of the water is stopped whilst adding larvae to test vessels and should remain so for 24 hours following addition of larvae (see paragraph 32). According to the test design used (see paragraphs 19 and 20), the number of larvae used per concentration is at least 120 (6 replicates per concentration) for the EC_x approach and 160 for the NOEC approach (8 replicates per concentration). In the spiked sediment design, exposure starts with the addition of the larvae.

Spiking the overlying water

26. Twenty-four hours after adding the first instar larvae for the 1st generation, the test chemical is spiked into the overlying water column, and slight aeration is again supplied (for possible amendments of the test design, see paragraph 7). Small volumes of the test chemical stock solutions are applied below the surface of the water using a pipette. The overlying water should then be mixed with care not to disturb the sediment. In the spiked water design, exposure starts with the spiking of the water (i.e. one day after addition of the larvae).

Collecting emerged adults

27. Emerged midges of the 1st generation are collected at least once, but preferably twice a day (see point 36) from the test vessels using an aspirator, exhaustor or similar device (see Appendix 5). Special care should be taken not to damage the adults. The collected midges from four test vessels within one treatment are released into a breeding cage to which they had been previously assigned. At the day of first (male) emergence, crystallising dishes are spiked by pipetting a small volume of the test chemical stock solution below the water surface (spiked water design). The overlying water should then be mixed with care not to disturb the sediment. The concentration of test chemical in the crystallising dish is nominally the same as in the treatment vessels which are assigned to that specific breeding cage. For the spiked sediment design, the crystallising dishes are prepared at around day 11 after the

▼ M6

start of the exposure (i.e. addition of the 1st generation larvae) so that they can equilibrate for about 48 hours before the first egg ropes are produced.

28. Egg ropes are collected from the crystallising dish in the breeding cage using tweezers or a blunt pipette. Each egg rope is placed into a vessel containing culture medium from the crystallising dish it was collected from (e.g. a well of a 12-well micro-plate together with at least 2,5 ml of medium). The vessels with the egg ropes are covered with a lid to prevent significant evaporation. Egg ropes are kept for observation for at least six days after they have been produced so that they can be classified as fertile or infertile.

For starting the 2nd generation, at least three but preferably six fertile egg ropes are selected from each breeding cage and together with some food allowed to hatch. These egg ropes should have been produced at the peak of oviposition, which normally occurs around test day 19 in the controls. Ideally, the 2nd generation of all treatments is initiated on the same day, but due to chemical related effects on larval development, this may not always be possible. In such a case, the higher concentrations may be initiated later than the lower treatments and the (solvent) control.

29. a. In the spiked water design, the sediment-water system for the 2nd generation is prepared by spiking the test chemical into the overlying water column ca. 1 hour before adding the first instar larvae to the test vessels. Small volumes of the test chemical solutions are applied below the surface of the water using a pipette. The overlying water should then be mixed with care not to disturb the sediment. After spiking, slight aeration is supplied.
29. b. In the spiked sediment design, the exposure vessels containing the sediment-water system for the 2nd generation are prepared in the same way as for the 1st generation.
30. Twenty first instar larvae (maximum 48 h post hatching) of the 2nd generation are allocated randomly to each test vessel containing the spiked sediment-water system, using a blunt pipette. Aeration of the water should be stopped while adding the first instar larvae to the test vessels and remain so for another 24 hours after addition of the larvae. According to the test design used (see paragraphs 19 and 20), the number of larvae used per concentration is at least 120 (6 replicates per concentration) for the EC_x approach and 160 for the NOEC approach (8 replicates per concentration).

Food

31. It is necessary to feed the larvae in the test vessels, preferably daily or at least three times per week. Fish-food (a suspension in water or finely ground food, e.g. Tetra-Min or Tetra-Phyll; see details in Appendix 2) of 0,25 - 0,5 mg (0,35 - 0,5 mg for *C. yoshimatsui*) per larvae per day is an adequate amount of food for young larvae during the first 10 days of their development. Slightly more food may be necessary for older larvae: 0,5 - 1,0 mg per larvae per day should be sufficient for the rest of the test. The food ration should be reduced in all treatments and control if fungal growth is seen or if mortality is observed in controls. If fungal development cannot be stopped the test should be repeated.

The toxicological relevance of exposure via ingestion is generally higher in chemicals with a high affinity for organic carbon or chemicals covalently binding to the sediment. Hence, when testing chemicals with

▼ **M6**

such properties, the amount of food necessary to ensure survival and natural growth of the larvae may be added to the formulated sediment before the stabilisation period, depending on the regulatory demand. To prevent deterioration of the water quality, plant material should be used instead of fish food, e.g. addition of 0,5 % (dry weight) finely ground leaves of stinging nettle (*Urtica dioica*), mulberry (*Morus alba*), white clover (*Trifolium repens*), spinach (*Spinacia oleracea*) or other plant material (*Cerophyl* or α -cellulose). Addition of the complete ration of an organic food source to the sediment before spiking is not trivial with respect to water quality and biological performance (21), nor a standardised method, but recent studies provide indications that this method works (19) (26). Adult midges in the breeding cage need no feeding normally, but fecundity and fertility are enhanced when a cotton wool pad soaked in a saturated sucrose solution is offered as a food source for emerged adults (34).

Incubation conditions

32. Gentle aeration of the overlying water in the test vessels is supplied 24 hours after addition of the first instar larvae of both generations and is continued throughout the test (care should be taken that the dissolved oxygen concentration does not fall below 60 % of ASV). Aeration is provided through a glass Pasteur pipette of which the outlet is fixed 2-3 cm above the sediment layer giving a few bubbles/sec. When testing volatile chemicals, consideration should be given not to aerate the sediment-water system, while at the same time the validity criterion of minimal 60 % ASV (paragraph 10) should be fulfilled. Further guidance is provided in (16).
33. The test with *C. riparius* is conducted at a constant temperature of 20 °C (± 2 °C). For *C. dilutus* and *C. yoshimatsui*, recommended temperatures are 23 °C and 25 °C (± 2 °C), respectively. A 16 hours photoperiod is used and the light intensity should be 500 to 1 000 lux. For the breeding cages an additional one hour dawn and dusk phase may be included.

Exposure duration

34. Spiked water design: The exposure period of the 1st generation starts when the test chemical is spiked into the overlying water of the test vessels (which is one day after insertion of the larvae — for possible amendments of the exposure design, see paragraph 7). Exposure of the 2nd larval generation starts immediately, since they are inserted into a sediment-water system that has been already spiked. The maximum exposure duration for the 1st generation is 27 days and for the 2nd generation 28 days (the 1st generation larvae spend one day in the vessels without exposure) for *C. riparius* and *C. yoshimatsui*. Considering the overlap, the complete test duration is approximately 44 days. For *C. dilutus*, maximum exposure durations are 64 and 65 days, for the 1st and 2nd generation, respectively. The total duration is approximately 100 days.

Spiked sediment design: exposure starts with the addition of the larvae and is maximum 28 days for both generations for *C. riparius* and *C. yoshimatsui* and maximum 65 days for both generations for *C. dilutus*.

Observations*Emergence*

35. Development time and the total number of fully emerged and alive male and female midges are determined for both generations. Males are easily identified by their plumose antennae and thin body posture.

▼ M6

36. Test vessels of both generations should be observed at least three times per week to make visual assessment of any abnormal behaviour of the larvae (e.g. leaving sediment, unusual swimming), compared to the control. During the period of emergence, which starts about 12 days after insertion of the larvae for *C. riparius* and *C. yoshimatsui* (after 20 days for *C. dilutus*), emerged midges are counted and sexed at least once, but preferably twice a day (early morning and late afternoon). After identification, the midges of the 1st generation are carefully removed from the vessels and transferred to a breeding cage. Midges of the 2nd generation are removed and killed after identification. Any egg ropes deposited in the test vessels of the 1st generation should be collected individually and transferred with at least 2,5 ml native water to 12-well microplates (or other suitable vessels) which are covered with a lid to prevent significant evaporation. The number of dead larvae and visible pupae that have failed to emerge should also be recorded. Examples of a breeding cage, test vessel and exhauster are provided in Appendix 5.

Reproduction

37. Effects on reproduction are assessed via the number of egg ropes produced by the 1st generation of midges and the fertility of these egg ropes. Once per day the egg ropes are collected from the crystallising dish that is placed in each breeding container. The egg ropes should be collected and transferred with at least 2,5 ml native water to a 12-wells microplate (one egg rope in each well) or other suitable vessels, which are covered with a lid to prevent significant evaporation. The following characteristics are documented for each egg rope: day of production, size (normal, i.e. $1,0 \pm 0,3$ cm or small; typically $\leq 0,5$ cm), and structure (normal = banana-form with spiralled egg string or abnormal, e.g. unspiralled egg string) and fertility (fertile or infertile). Over the course of six days after it was produced the fertility of an egg rope is assessed. An egg rope is considered fertile when at least one third of the eggs hatch. The total number of females added to the breeding cage is used to calculate the number of egg ropes per female and the number of fertile egg ropes per female. If required, the number of eggs in an egg rope can be estimated non-destructively by using the ring count method (detailed in 32 and 33).

Analytical measurements*Concentration of the test chemical*

38. As a minimum, samples of the overlying water, pore water and the sediment should be analysed at the start of exposure (in case of water spiking preferably one hour after application) and at the end of the test, at the highest concentration and a lower one. This applies to vessels from both generations. From the crystallising dishes in the breeding cage only the overlying water is analysed, since this is what the egg ropes come into contact with (for the spiked sediment design an analytical confirmation of the sediment concentration may be considered). Further measurements of sediment, pore water or overlying water during the test may be conducted if deemed necessary. These determinations of test chemical concentration inform on the behaviour/partitioning of the test chemical in the water-sediment system. Sampling of sediment and pore water at the start and during the test (see paragraph 39) requires additional test vessels to perform analytical determinations. Measurements in sediment in the spiked water design might not be necessary if the partitioning of the test chemical between water and sediment has been clearly determined

▼ M6

in a water/sediment study under comparable conditions (e.g. sediment to water ratio, type of application, organic carbon content of sediment), or if measured concentrations in the overlying water are shown to remain within 80 to 120 % of the nominal or measured initial concentrations.

39. When intermediate measurements are made (e.g. at day 7 and/or 14) and if the analysis needs large samples which cannot be taken from test vessels without influencing the test system, analytical determinations should be performed on samples from additional test vessels treated in the same way (including the presence of test organisms) but not used for biological observations.
40. Centrifugation at e.g. 10 000 g at 4 °C for 30 min is the recommended procedure to isolate interstitial (= pore) water. However, if the test chemical is demonstrated not to adsorb to filters, filtration may also be acceptable. In some cases it might not be possible to analyse concentrations in the pore water as the sample volume may be too small.

Physical-chemical parameters

41. pH, dissolved oxygen in the test water and temperature of the water in the test vessels and crystallising dishes should be measured in an appropriate manner (see paragraph 10). Hardness and ammonia should be measured in the controls and in one test vessel and crystallising dish at the highest concentration at the start and the end of the test.

DATA AND REPORTING

Treatment of results

42. The purpose of this life-cycle test is to determine the effect of the test chemical on the reproduction and, for two generations, the development rate and the total number of fully emerged and alive male and female midges. For the emergence ratio data of males and females should be pooled. If there are no statistically significant differences between the sensitivities in the development rate of the separate sexes, male and female results may be pooled for statistical analysis.
43. Effect concentrations expressed as concentrations in the overlying water (for spiked water) or in the sediment (for spiked sediment), are usually calculated based on measured concentrations at the beginning of the exposure (see paragraph 38). Therefore, for spiked water, the concentrations typically measured at the beginning of the exposure in the overlying water of the vessels for both generations and those of the crystallising dishes are averaged for each treatment. For spiked sediment, the concentrations typically measured at the beginning of the exposure in the vessels for both generations (and optionally those of the crystallising dishes) are averaged for each treatment.
44. To compute a point estimate, i.e. an EC_x , the per-vessel and per-breeding cage statistics may be used as true replicates. In calculating a confidence interval for any EC_x the variability among vessels should be taken into account, or it should be shown that this variability is so small that it can be ignored. When the model is fitted by Least Squares, a transformation should be applied to the per-vessel statistics in order to improve the homogeneity of variance. However, EC_x values should be calculated after the response is transformed back to the original value (31).

▼ **M6**

45. When the statistical analysis aims at determining the NOEC by hypothesis testing, the variability among vessels needs to be taken into account, which is guaranteed by using ANOVA methods (e.g. Williams' and Dunnett's test procedures). Williams' test would be appropriate when a monotonic dose-response is expected in theory and Dunnett's test would be appropriate where the monotonicity hypothesis does not hold. Alternatively, more robust tests (27) can be appropriate in situations where there are violations of the usual ANOVA assumptions (31).

Emergence ratio

46. Emergence ratios are quantal data, and can be analysed by the Cochran-Armitage test applied in a step-down manner where a monotonic dose-response is expected and these data are consistent with this expectation. If not, a Fisher's exact or Mantel-Haentzel test with Bonferroni-Holm adjusted p-values can be used. If there is evidence of greater variability between replicates within the same concentration than a binomial distribution would indicate (often referenced to as 'extra-binomial' variation), then a robust Cochran-Armitage or Fisher exact test such as proposed in (27), should be used.

The sum of live midges (males plus females) emerged per vessel, n_e , is determined and divided by the number of larvae introduced, n_a :

$$ER = \frac{n_e}{n_a}$$

where:

ER = emergence ratio

n_e = number of live midges emerged per vessel

n_a = number of larvae introduced per vessel (normally 20)

When n_e is larger than n_a (i.e. when unintentionally more than the foreseen number of larvae where introduced) n_a should be made equal to n_e .

47. An alternative approach that is most appropriate for large sample sizes, when there is extra binomial variance, is to treat the emergence ratio as a continuous response and use procedures consistent with these *ER* data. A large sample size is defined here as the number emerged and the number not emerging both exceeding five, on a per replicate (vessel) basis.
48. To apply ANOVA methods, values of *ER* should first be transformed by the arcsin-sqrt transformation or Tukey-Freeman transformation to obtain an approximate normal distribution and to equalise variances. The Cochran-Armitage, Fisher's exact (Bonferroni), or Mantel-Haentzel tests can be applied when using the absolute frequencies. The arcsin-sqrt transformation is applied by taking the inverse sine (\sin^{-1}) of the square root of *ER*.
49. For emergence ratios, EC_x -values are calculated using regression analysis (e.g. probit, logit or Weibull models (28)). If regression analysis fails (e.g. when there are less than two partial responses), other non-parametric methods such as moving average or simple interpolation can be used.

Development rate

50. Mean development time represents the mean time span between the introduction of larvae (day 0 of the test) and the emergence of the experimental cohort of midges (for calculation of the true development time, the age of larvae at the time of introduction should be considered). The

▼ **M6**

development rate (unit: 1/day) is the reciprocal of the development time and represents that portion of larval development which takes place per day. Development rate is preferred for the evaluation of these sediment toxicity studies as its variance is lower, and it is more homogeneous and closer to a normal distribution compared to the development time. Hence, more powerful parametric test procedures may be used with development rate unlike development time. For development rate as a continuous response, EC_x-values can be estimated by regression analysis (e.g. (29) (30)). A NOEC for the mean development rate can be determined via ANOVA methods, e.g. Williams or Dunnett's test. Since males emerge earlier than females, i.e. have a higher development rate, it makes sense to calculate the development rate for each gender separately in addition to that for the total midges.

51. For statistical testing, the number of midges observed on inspection day x are assumed to be emerged at the mean of the time interval between day x and day $x - 1$ ($l =$ length of the inspection interval, usually 1 day). The mean development rate per vessel (\bar{x}) is calculated according to:

$$\bar{x} = \frac{\sum_{i=1}^m f_i X_i}{n_e}$$

where:

\bar{x} : mean development rate per vessel

i : index of inspection interval

m : maximum number of inspection intervals

f_i : number of midges emerged in the inspection interval i

n_e : total number of midges emerged at the end of experiment ($= \sum f_i$)

x_i : development rate of the midges emerged in interval i

$$x_i = 1/\text{day}_i - \frac{l_i}{2}$$

where:

day_i : inspection day (days since introduction of the larvae)

l_i : length of inspection interval i (days, usually 1 day)

Sex ratio

52. Sex ratios are quantal data and should therefore be evaluated by means of a Fisher's exact test or other appropriate methods. The natural sex ratio of *C. riparius* is one, i.e. males and females are equally abundant. For both generations the sex ratio data should be treated identically. Since the maximum number of midges per vessel (i.e. 20) is too low for a meaningful statistical analysis, the total number of fully emerged and alive

▼ M6

midges for each gender is summed over all vessels of one treatment. These untransformed data are tested against the (solvent) control or pooled control data in a 2×2 contingency table.

Reproduction

53. Reproduction, as fecundity, is calculated as the number of egg ropes per female. More specific, the total number of egg ropes produced in a breeding cage is divided by the total number of alive and undamaged females added to that cage. A NOEC for fecundity can be determined via ANOVA methods, e.g. Williams or Dunnett's test.
54. Fertility of the egg ropes is used to quantify the number of fertile egg ropes per female. The total number of fertile egg ropes produced in a breeding cage is divided by the total number of alive and undamaged females added to that cage. A NOEC for fertility can be determined via ANOVA methods, e.g. Williams or Dunnett's test.

Test report

55. The test report should provide the following information:

Test chemical:

- physical nature and physical-chemical properties (water solubility, vapour pressure, $\log K_{ow}$, partition coefficient in soil (or in sediment if available), stability in water and sediment etc.);
- chemical identification data (common name, chemical name, structural formula, CAS number, etc.) including purity and analytical method for the quantification of the test chemical.

Test species:

- test organisms used: species, scientific name, source of organisms and breeding conditions;
- information on how the egg masses and larvae were handled;
- information on handling of the emerged adults of the 1st generation with the help of an exhaustor etc (see Appendix 5)
- age of the test organisms at the time of insertion into the test vessels of the 1st and 2nd generation.

Test conditions:

- sediment used, i.e. natural or formulated (artificial) sediment;
- natural sediment: location and description of sediment sampling site, including, if possible, contamination history; sediment characteristics: pH, organic carbon content, C/N ratio and granulometry (if appropriate).
- formulated sediment: preparation, ingredients and characteristics (organic carbon content, pH, moisture, etc. measured at the start of the test);
- preparation of the test water (if reconstituted water is used) and characteristics (oxygen concentration, pH, hardness, etc. measured at the start of the test);

▼ M6

- depth of sediment and overlaying water for the test vessels and crystallising dishes;
- volume of overlying and pore water; weight of wet sediment with and without pore water for the test vessels and the crystallising dishes;
- test vessels (material and size);
- crystallising dishes (material and size);
- breeding cages (material and size)
- method of preparation of stock solutions and test concentrations for the test vessels and crystallising dishes;
- application of the test chemical into the test vessels and crystallising dishes: test concentrations, number of replicates and solvents if needed;
- incubation conditions for the test vessels: temperature, light cycle and intensity, aeration (bubbles per second);
- incubation conditions for the breeding cages and the crystallising dishes: temperature, light cycle and intensity;
- incubation conditions for the egg ropes in the micro plates (or other vessels): temperature, light cycle and intensity;
- detailed information on feeding including type of food, preparation, amount and feeding regime.

Results:

- nominal test concentrations, measured test concentrations and the results of all analyses to determine the concentration of the test chemical in the test vessels and crystallising dishes;
- water quality within the test vessels and crystallising dishes, i.e. pH, temperature, dissolved oxygen, hardness and ammonia;
- replacement of evaporated test water for the test vessels, if any;
- number of emerged male and female midges per vessel and per day for the 1st and 2nd generation;
- sex ratio of fully emerged and alive midges per treatment for the 1st and 2nd generation
- number of larvae which failed to emerge as midges per vessel for the 1st and 2nd generation;
- percentage/fraction of emergence per replicate and test concentration (male and female midges pooled) for the 1st and 2nd generation;
- mean development rate of fully emerged and alive midges per replicate and treatment rate (male and female midges separate and also pooled) for the 1st and 2nd generation;
- number of egg ropes deposited in the crystallising dishes per breeding cage and day;

▼ **M6**

- characteristics of each egg rope (size, shape and fertility);
- fecundity — total number of egg ropes per total number of females added to the breeding cage;
- fertility — total number of fertile egg ropes per total number of females added to the breeding cage;
- estimates of toxic endpoints e.g. EC_x (and associated confidence intervals), NOEC and the statistical methods used for its determination;
- discussion of the results, including any influence on the outcome of the test resulting from deviations from this test method.

LITERATURE

- (1) Chapter C.28 of this Annex, Sediment-water chironomid toxicity test using spiked water.
- (2) Shobanov, N.A., Kiknadze, I.I. and M.G. Butler (1999), Palearctic and Nearctic *Chironomus (Camptochironomus) tentans* Fabricius are different species (Diptera: Chironomidae). *Entomologica Scandinavica*, 30: 311–322.
- (3) Fleming, R. *et al.* (1994), Sediment Toxicity Tests for Poorly Water-Soluble Substances, Final Report to the European Commission, Report No: EC 3738. August 1994. WRc, UK.
- (4) SETAC (1993), Guidance Document on Sediment toxicity Tests and Bioassays for Freshwater and Marine Environments, From the WOSTA Workshop held in the Netherlands.
- (5) ASTM International (2009), E1706-05E01: Test Method for Measuring the Toxicity of Sediment-Associated Contaminants with Freshwater Invertebrates, In: Annual Book of ASTM Standards, Volume 11.06, Biological Effects and Environmental Fate; Biotechnology. ASTM International, West Conshohocken, PA.
- (6) Environment Canada (1997), Test for Growth and Survival in Sediment using Larvae of Freshwater Midges (*Chironomus tentans* or *Chironomus riparius*), Biological Test Method, Report SPE 1/RM/32, December 1997.
- (7) US-EPA (2000), Methods for Measuring the Toxicity and Bioaccumulation of Sediment-associated Contaminants with Freshwater Invertebrates, Second edition, EPA 600/R-99/064, March 2000, Revision to the first edition dated June 1994.
- (8) US-EPA/OPPTS 850.1735 (1996), Whole Sediment Acute Toxicity Invertebrates.
- (9) US-EPA/OPPTS 850.1790 (1996), Chironomid Sediment toxicity Test.
- (10) Milani, D., Day, K.E., McLeay, D.J. and R.S. Kirby (1996), Recent intra- and inter-laboratory studies related to the development and standardisation of Environment Canada's biological test methods for measuring sediment toxicity using freshwater amphipods (*Hyalella azteca*) and midge larvae (*Chironomus riparius*), Technical Report, Environment Canada, National Water Research Institute, Burlington, Ontario, Canada.
- (11) Norberg-King, T.J., Sibley, P.K., Burton, G.A., Ingersoll, C.G., Kemble, N.E., Ireland, S., Mount, D.R. and C.D. Rowland (2006), Interlaboratory evaluation of *Hyalella azteca* and *Chironomus tentans* short-term and long-term sediment toxicity tests, *Environ. Toxicol. Chem.*, 25: 2662-2674.

▼ **M6**

- (12) Taenzler, V., Bruns, E., Dorgerloh, M., Pfeifle, V. and L. Weltje (2007), Chironomids: suitable test organisms for risk assessment investigations on the potential endocrine-disrupting properties of pesticides, *Ecotoxicology*, 16: 221-230.
- (13) Sugaya, Y. (1997), Intra-specific variations of the susceptibility of insecticides in *Chironomus yoshimatsui*, *Jp. J. Sanit. Zool.*, 48: 345-350.
- (14) Kawai, K. (1986), Fundamental studies on chironomid allergy, I. Culture methods of some Japanese chironomids (Chironomidae, Diptera), *Jp. J. Sanit. Zool.*, 37: 47-57.
- (15) Chapter C.27 of this Annex, Sediment-water chironomid toxicity test using spiked sediment.
- (16) OECD (2000), *Guidance Document on Aquatic Toxicity Testing of Difficult Substances and Mixtures*, Environment, Health and Safety Publications, Series on Testing and Assessment No. 23, ENV/JM/MONO(2000)6, OECD, Paris.
- (17) Weltje, L., Ruflin, H., Heimbach, F., Wheeler, J., Vervliet-Scheebaum, M. and M. Hamer (2010), The chironomid acute toxicity test: development of a new test system, *Integr. Environ. Assess. Management*.
- (18) Environment Canada. (1995), *Guidance Document on Measurement of Toxicity Test Precision Using Control Sediments Spiked with a Reference Toxicant*, Report EPS 1/RM/30, September 1995.
- (19) Oetken, M., Nentwig, G., Löffler, D., Ternes, T. and J. Oehlmann (2005), Effects of pharmaceuticals on aquatic invertebrates, Part I, The anti-epileptic drug carbamazepine, *Arch. Environ. Contam. Toxicol.*, 49: 353-361.
- (20) Suedel, B.C. and J.H. Rodgers (1994), Development of formulated reference sediments for freshwater and estuarine sediment testing, *Environ. Toxicol. Chem.*, 13: 1163-1175.
- (21) Naylor, C. and C. Rodrigues (1995), Development of a test method for *Chironomus riparius* using a formulated sediment, *Chemosphere*, 31: 3291-3303.
- (22) Dunnett, C.W. (1964), A multiple comparisons procedure for comparing several treatments with a control. *J. Amer. Statist. Assoc.*, 50: 1096-1121.
- (23) Dunnett, C.W. (1964), New tables for multiple comparisons with a control, *Biometrics*, 20: 482-491.
- (24) Williams, D.A. (1971), A test for differences between treatment means when several dose levels are compared with a zero dose control. *Biometrics*, 27: 103-117.
- (25) Williams, D.A. (1972), The comparison of several dose levels with a zero dose control. *Biometrics*, 28: 510-531.
- (26) Jungmann, D., Bandow, C., Gildemeister, T., Nagel, R., Preuss, T.G., Ratte, H.T., Shinn, C., Weltje, L. and H.M. Maes (2009), Chronic toxicity of fenoxycarb to the midge *Chironomus riparius* after exposure in sediments of different composition. *J Soils Sediments*, 9: 94-102.
- (27) Rao, J.N.K. and A.J. Scott (1992), A simple method for the analysis of clustered binary data. *Biometrics*, 48: 577-585.
- (28) Christensen, E.R. (1984), Dose-response functions in aquatic toxicity testing and the Weibull model, *Water Res.*, 18: 213-221.

▼ M6

- (29) Bruce, R.D. and D.J. Versteeg (1992), A statistical procedure for modelling continuous toxicity data, *Environ. Toxicol. Chem.*, 11: 1485-1494.
- (30) Slob, W. (2002), Dose-response modelling of continuous endpoints. *Toxicol. Sci.*, 66: 298-312.
- (31) OECD (2006), *Current Approaches in the Statistical Analysis of Ecotoxicity Data: a Guidance to Application*, OECD Series on Testing and Assessment No. 54, 146 pp., ENV/JM/MONO(2006)18, OECD, Paris.
- (32) Benoit, D.A., Sibley, P.K., Juenemann, J.L. and G.T. Ankley (1997), *Chironomus tentans* life-cycle test: design and evaluation for use in assessing toxicity of contaminated sediments, *Environ. Toxicol. Chem.*, 16: 1165-1176.
- (33) Vogt, C., Belz, D., Galluba, S., Nowak, C., Oetken, M. and J. Oehlmann (2007), Effects of cadmium and tributyltin on development and reproduction of the non-biting midge *Chironomus riparius* (Diptera) — baseline experiments for future multi-generation studies, *J. Environ. Sci. Health Part A*, 42: 1-9.
- (34) OECD (2010), *Validation report of the Chironomid full life-cycle toxicity test*, Forthcoming publication in the Series on Testing and Assessment, OECD, Paris.

▼ M6*Appendix 1***Definitions**

For the purpose of this test method the following definitions are used:

Chemical is a substance or a mixture.

Formulated sediment or reconstituted, artificial or synthetic sediment is a mixture of materials used to mimic the physical components of natural sediment.

Overlying water is the water placed over sediment in the test vessel.

Interstitial water or pore water is the water occupying space between sediment and soil particles.

Spiked water is the test water to which test chemical has been added.

Test chemical is any substance or mixture tested using this test method.

▼ M6*Appendix 2***Recommendations for culture of *Chironomus riparius***

1. *Chironomus* larvae may be reared in crystallising dishes or larger containers. Fine quartz sand is spread in a thin layer of about 5 to 10 mm deep over the bottom of the container. Kieselgur (e.g. Merck, Art 8117) has also been shown to be a suitable substrate (a thinner layer of up to a very few mm is sufficient). Suitable water is then added to a depth of several cm. Water levels should be topped up as necessary to replace evaporative loss, and prevent desiccation. Water can be replaced if necessary. Gentle aeration should be provided. The larval rearing vessels should be held in a suitable cage which will prevent escape of the emerging adults. The cage should be sufficiently large to allow swarming of emerged adults, otherwise copulation may not occur (minimum is ca. 30 × 30 × 30 cm).
2. Cages should be held at room temperature or in a constant environment room at 20 ± 2 °C with a photo period of 16 hour light (intensity ca. 1 000 lux), 8 hours dark. It has been reported that air humidity of less than 60 % RH can impede reproduction.

Dilution water

3. Any suitable natural or synthetic water may be used. Well water, dechlorinated tap water and artificial media (e.g. Elendt 'M4' or 'M7' medium, see below) are commonly used. The water should be aerated before use. If necessary, the culture water may be renewed by pouring or siphoning the used water from culture vessels carefully without destroying the tubes of larvae.

Feeding larvae

4. *Chironomus* larvae should be fed with a fish flake food (Tetra Min®, Tetra Phyll® or other similar brand of proprietary fish food), at approximately 250 mg per vessel per day. This can be given as a dry ground powder or as a suspension in water: 1,0 g of flake food is added to 20 ml of dilution water and blended to give a homogenous mix. This preparation may be fed at a rate of about 5 ml per vessel per day. (shake before use.) Older larvae may receive more.
5. Feeding is adjusted according to the water quality. If the culture medium becomes 'cloudy', the feeding should be reduced. Food additions should be carefully monitored. Too little food will cause emigration of the larvae towards the water column, and too much food will cause increased microbial activity and reduced oxygen concentrations. Both conditions can result in reduced growth rates.
6. Some green algae (e.g. *Scenedesmus subspicatus*, *Chlorella vulgaris*) cells may also be added when new culture vessels are set up.

Feeding emerged adults

7. Some experimenters have suggested that a cotton wool pad soaked in a saturated sucrose solution may serve as a food for emerged adults.

▼ M6**Emergence**

8. At 20 ± 2 °C adults will begin to emerge from the larval rearing vessels after approximately 13 - 15 days. Males are easily distinguished by having plumose antennae and thin body.

Egg masses

9. Once adults are present within the breeding cage, all larval rearing vessels should be checked three times weekly for deposition of the gelatinous egg masses. If present, the egg masses should be carefully removed. They should be transferred to a small dish containing a sample of the breeding water. Egg masses are used to start a new culture vessel (e.g. 2 - 4 egg masses/vessel) or are used for toxicity tests.
10. First instar larvae should hatch after 2 - 3 days.

Set-up of new culture vessels

11. Once cultures are established it should be possible to set up a fresh larval culture vessel weekly or less frequently depending on testing requirements, removing the older vessels after adult midges have emerged. Using this system a regular supply of adults will be produced with a minimum of management.

Preparation of test solutions 'M4' and 'M7'

12. Elendt (1990) has described the 'M4' medium. The 'M7' medium is prepared as the 'M4' medium except for the substances indicated in Table 1, for which concentrations are four times lower in 'M7' than in 'M4'. The test solution should not be prepared according to Elendt and Bias (1990) for the concentrations of $\text{NaSiO}_3 \cdot 5\text{H}_2\text{O}$, NaNO_3 , KH_2PO_4 and K_2HPO_4 given for the preparation of the stock solutions are not adequate.

Preparation of the 'M7'-medium

13. Each stock solution (I) is prepared individually and a combined stock solution (II) is prepared from these stock solutions (I) (see Table 1). Fifty ml from the combined stock solution (II) and the amounts of each macro nutrient stock solution which are given in Table 2 are made up to 1 litre of deionised water to prepare the 'M7' medium. A vitamin stock solution is prepared by adding three vitamins to deionised water as indicated in Table 3, and 0,1 ml of the combined vitamin stock solution are added to the final 'M7' medium shortly before use. The vitamin stock solution is stored frozen in small aliquots. The medium is aerated and stabilised.

*Table 1***Stock solutions of trace elements for medium M4 and M7**

Stock solutions (I)	Amount (mg) made up to 1 litre of deionised water	To prepare the combined stock solution (II): mix the following amounts (ml) of stock solutions (I) and make up to 1 litre of deionised water		Final concentrations in test solutions (mg/l)	
		M4	M7	M4	M7
H_3BO_3 ⁽¹⁾	57 190	1,0	0,25	2,86	0,715
$\text{MnCl}_2 \cdot 4\text{H}_2\text{O}$ ⁽¹⁾	7 210	1,0	0,25	0,361	0,090
LiCl ⁽¹⁾	6 120	1,0	0,25	0,306	0,077

▼ **M6**

Stock solutions (I)	Amount (mg) made up to 1 litre of deionised water	To prepare the combined stock solution (II): mix the following amounts (ml) of stock solutions (I) and make up to 1 litre of deionised water		Final concentrations in test solutions (mg/l)	
		M4	M7	M4	M7
RbCl ⁽¹⁾	1 420	1,0	0,25	0,071	0,018
SrCl ₂ ·6H ₂ O ⁽¹⁾	3 040	1,0	0,25	0,152	0,038
NaBr ⁽¹⁾	320	1,0	0,25	0,016	0,004
Na ₂ MoO ₄ ·2H ₂ O ⁽¹⁾	1 260	1,0	0,25	0,063	0,016
CuCl ₂ ·2H ₂ O ⁽¹⁾	335	1,0	0,25	0,017	0,004
ZnCl ₂	260	1,0	1,0	0,013	0,013
CaCl ₂ ·6H ₂ O	200	1,0	1,0	0,010	0,010
KI	65	1,0	1,0	0,0033	0,0033
Na ₂ SeO ₃	43,8	1,0	1,0	0,0022	0,0022
NH ₄ VO ₃	11,5	1,0	1,0	0,00058	0,00058
Na ₂ EDTA·2H ₂ O ⁽¹⁾ ⁽²⁾	5 000	20,0	5,0	2,5	0,625
FeSO ₄ ·7H ₂ O ⁽¹⁾ ⁽²⁾	1 991	20,0	5,0	1,0	0,249

⁽¹⁾ These substances differ in M4 and M7, as indicated above.

⁽²⁾ These solutions are prepared individually, then poured together and autoclaved immediately.

Table 2

Macro nutrient stock solutions for medium M4 and M7

	Amount made up to 1 litre of deionised water (mg)	Amount of macro nutrient stock solutions added to prepare medium M4 and M7 (ml/l)	Final concentrations in test solutions M4 and M7 (mg/l)
CaCl ₂ · 2H ₂ O	293 800	1,0	293,8
MgSO ₄ · 7H ₂ O	246 600	0,5	123,3
KCl	58 000	0,1	5,8
NaHCO ₃	64 800	1,0	64,8
NaSiO ₃ · 9H ₂ O	50 000	0,2	10,0
NaNO ₃	2 740	0,1	0,274
KH ₂ PO ₄	1 430	0,1	0,143
K ₂ HPO ₄	1 840	0,1	0,184

▼ **M6**

Table 3

Vitamin stock solution for medium M4 and M7

All three vitamin solutions are combined to make a single vitamin stock solution.

	Amount made up to 1 litre of deionised water (mg)	Amount of vitamin stock solution added to prepare medium M4 and M7 (ml/l)	Final concentrations in test solutions M4 and M7 (mg/l)
Thiamine hydrochloride	750	0,1	0,075
Cyanocobalamin (B12)	10	0,1	0,0010
Biotine	7,5	0,1	0,00075

REFERENCES

BBA (1995), Long-term toxicity test with *Chironomus riparius*: Development and validation of a new test system, Edited by M. Strelke and H. Köpp. Berlin.

Elenkt, B.P. (1990), Selenium deficiency in Crustacea, *Protoplasma*, 154: 25-33.

Elenkt, B.P. and W.-R. Bias (1990), Trace nutrient deficiency in *Daphnia magna* cultured in standard medium for toxicity testing, Effects on the optimisation of culture conditions on life history parameters of *D. magna*, *Water Research*, 24: 1157-1167.

▼ **M6***Appendix 3***Preparation of formulated sediment**

SEDIMENT COMPOSITION

The composition of the formulated sediment should be as follows:

Constituent	Characteristics	% of sediment dry weight
Peat	Sphagnum moss peat, as close to pH 5,5-6,0 as possible, no visible plant remains, finely ground (particle size ≤ 1 mm) and air dried	4 - 5
Quartz sand	Grain size: > 50 % of the particles should be in the range of 50-200 μm	75 - 76
Kaolinite clay	Kaolinite content ≥ 30 %	20
Organic carbon	Adjusted by addition of peat and sand	2 ($\pm 0,5$)
Calcium carbonate	CaCO_3 , pulverised, chemically pure	0,05 - 0,1
Water	Conductivity ≤ 10 $\mu\text{S/cm}$	30 - 50

PREPARATION

The peat is air dried and ground to a fine powder. A suspension of the required amount of peat powder in deionised water is prepared using a high-performance homogenising device. The pH of this suspension is adjusted to $5,5 \pm 0,5$ with CaCO_3 . The suspension is conditioned for at least two days with gentle stirring at 20 ± 2 °C, to stabilise pH and establish a stable microbial component. pH is measured again and should be $6,0 \pm 0,5$. Then the peat suspension is mixed with the other constituents (sand and kaolin clay) and deionised water to obtain an homogeneous sediment with a water content in a range of 30–50 per cent of dry weight of the sediment. The pH of the final mixture is measured once again and is adjusted to 6,5 to 7,5 with CaCO_3 if necessary. Samples of the sediment are taken to determine the dry weight and the organic carbon content. Then, before it is used in the chironomid toxicity test, it is recommended that the formulated sediment be conditioned for seven days under the same conditions which prevail in the subsequent test.

STORAGE

The dry constituents for preparation of the artificial sediment may be stored in a dry and cool place at room temperature. The formulated (wet) sediment should not be stored prior to its use in the test. It should be used immediately after the 7 days conditioning period that ends its preparation.

REFERENCES

OECD (1984), *Earthworm, Acute Toxicity Test*, Test Guideline No. 207, Guidelines for the Testing of Chemicals, OECD, Paris.

Meller, M., Egeler, P., Roembke, J., Schallnass, H., Nagel, R. and B. Streit (1998), Short-term toxicity of lindane, hexachlorobenzene and copper sulfate on tubificid sludgeworms (*Oligochaeta*) in artificial media, *Ecotox. Environ. Safety*, 39: 10-20.

▼ **M6***Appendix 4***Chemical Characteristics of an Acceptable Dilution water**

CONSTITUENT	CONCENTRATIONS
Particulate matter	< 20 mg/l
Total organic carbon	< 2 mg/l
Unionised ammonia	< 1 µg/l
Hardness as CaCO ₃	< 400 mg/l (*)
Residual chlorine	< 10 µg/l
Total organophosphorus pesticides	< 50 ng/l
Total organochlorine pesticides plus polychlorinated biphenyls	< 50 ng/l
Total organic chlorine	< 25 ng/l

(*) However, it should be noted that if there is an interaction suspected between hardness ions and the test chemical, lower hardness water should be used (and thus, Elendt Medium M4 should not be used in this situation).

▼M6*Appendix 5***Guidance for test performance**

Example of a breeding cage:

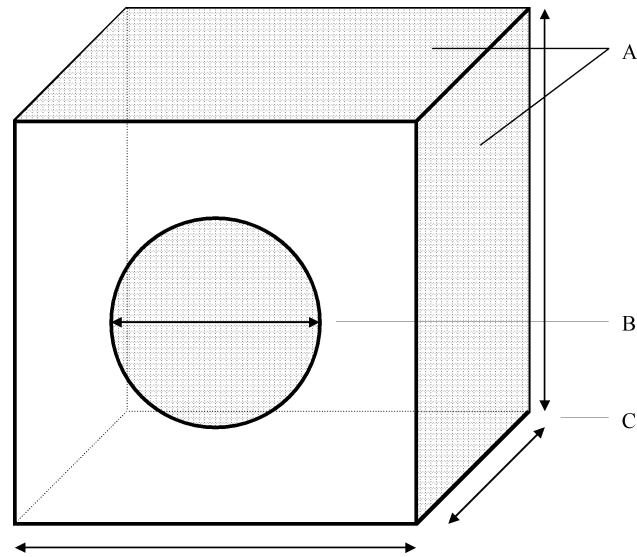

- A: gauze on the top and at least one side of the cage (mesh size ca. 1 mm)
- B: aperture for placing the emerged adults inside the breeding cage and to remove the laid egg ropes from the crystallisation dishes (not shown in this graphic)
- C: breeding cage size minimum 30 cm length, 30 cm height and 30 cm width

▼ M6

Example of a test vessel:

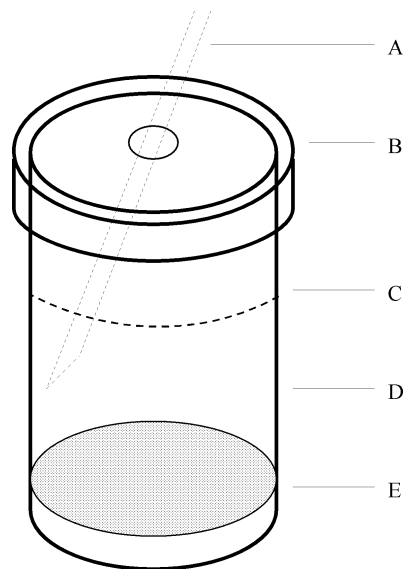

- A: pasteur pipette for air supply of the overlying water
- B: glass lid to prevent emerged midges from escaping
- C: water surface layer
- D: test vessel (glass beaker minimum 600 ml)
- E: sediment layer

▼ M6

Example of an exhauster for capturing adult midges (arrows indicate air flow direction):

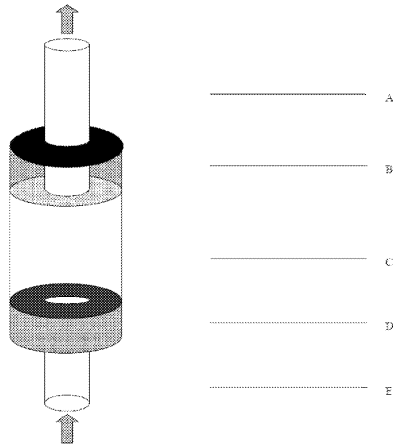

- A: glass tube (inner diameter ca. 5 mm) connected to a self-priming pump
- B: cork of vulcanised rubber, perforated with glass tube (A). On the inside, the opening of glass tube (A) is covered with some cotton and a gauze (mesh size ca. 1 mm) to prevent damaging the midges when they are sucked into the exhauster
- C: transparent container (plastic or glass, length ca. 15 cm) for captured midges
- D: cork of vulcanised rubber, perforated with tube (E). To release midges into the breeding cage, cork D is released from container C
- E: tube (plastic or glass, inner diameter ca. 8 mm) to collect adult midges from vessel

▼ **M6**

Schematic presentation of a life-cycle test:

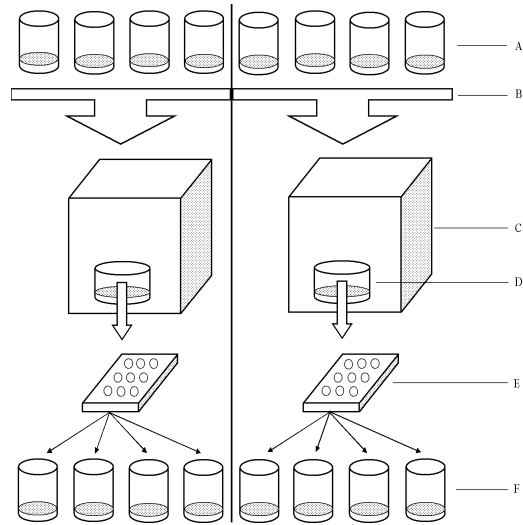

- A: 1st generation — test vessels containing a sediment-water system, eight replicates, 20 first instar larvae per vessel
- B: four test vessels for each breeding cage, A and B
- C: breeding cages (A and B) for swarming, mating and oviposition
- D: crystallising dishes for deposition of egg ropes
- E: micro plates, one well for each egg rope
- F: 2nd generation — test vessels containing a sediment-water system, eight replicates, 20 first instar larvae per vessel.

▼ **M6****C.41. FISH SEXUAL DEVELOPMENT TEST**

INTRODUCTION

1. This test method is equivalent to OECD test guideline (TG) 234 (2011). It is based on a decision from 1998 to develop new or update existing test methods for the screening and testing of potential endocrine disrupters. The Fish Sexual Development Test (FSDT) was identified as a promising test method covering a sensitive fish life stage responsive to both oestrogen and androgen-like chemicals. The test method went through an inter-laboratory validation exercise from 2006 to 2010, where Japanese medaka (*Oryzias latipes*), zebrafish (*Danio rerio*) and three spined stickleback (*Gasterosteus aculeatus*) were validated and fathead minnow (*Pimephales promelas*) was partially validated (41) (42) (43). This protocol includes Japanese medaka, the three-spined stickleback and zebrafish. The protocol is in principle an enhancement of OECD TG 210 Fish, Early Life Stage Toxicity Test (1), where the exposure is continued until the fish are sexually differentiated, i.e. about 60 days post-hatch (dph) for Japanese medaka, the three-spined stickleback and zebrafish (the exposure period can be shorter or longer for other species that are validated in the future), and endocrine-sensitive endpoints are added. The FSDT assesses early life-stage effects and potential adverse consequences of putative endocrine disrupting chemicals (e.g. oestrogens, androgens and steroidogenesis inhibitors) on sexual development. The combination of the two core endocrine endpoints, vitellogenin (VTG) concentration and phenotypic sex ratio enable the test to indicate the mode of action of the test chemical. Due to the population-relevant change in phenotypic sex ratio, the FSDT can be used for hazard and risk assessment. However, if the test is used for hazard or risk assessment, the stickleback should not be used because the validation data available so far showed that in this species the alterations of phenotypic sex ratio by the test chemicals were uncommon.

2. The protocol is based on fish exposed via water to chemicals during the sex labile period in which the fish is expected to be most sensitive to the effects of endocrine disrupting chemicals that interfere with sexual development. Two core endpoints are measured as indicators of endocrine-associated developmental aberrations, the VTG concentrations and sex ratios (proportions of sex) determined via gonad histology. Gonadal histopathology (evaluation and staging of oocytes and spermatogenetic cells) is optional. Additionally, the genetic sex is determined whenever possible (e.g. in Japanese medaka and the three spined stickleback). The presence of a genetic sex marker is a considerable advantage as it increases the power of the sex ratio statistics and enables the detection of individual phenotypic sex reversal. Other apical endpoints that should be measured include hatching rate, survival, length and body weight. The test method might be adaptable to other species than those mentioned above provided that the other species undergo a validation equal to the one accomplished for Japanese medaka, the three-spined stickleback and zebrafish, that the control fish are sexually differentiated at the end of the test, that VTG levels are sufficiently high to detect significant chemical-related variations, and that sensitivity of the test system is established using endocrine active reference chemicals ((anti)-oestrogens, (anti)-androgens, aromatase inhibitors etc). In addition, any validation report(s) referring to FSDT data using other species should be reviewed by the OECD, and the validation outcome should be considered as satisfactory.

▼ M6**Initial considerations and limitations**

3. VTG is normally produced by the liver of female oviparous vertebrates in response to circulating endogenous oestrogen (2). It is a precursor of egg yolk proteins and, once produced in the liver, travels in the bloodstream to the ovary, where it is taken up and modified by developing eggs. The VTG synthesis is very limited, though detectable, in immature fish and adult male fish because they lack sufficient circulating oestrogen. However, the liver is capable of synthesising and secreting VTG in response to exogenous oestrogen stimulation (3) (4) (5).

4. The measurement of VTG serves for the detection of chemicals with oestrogenic, anti-oestrogenic, androgenic modes of action and chemicals that interfere with steroidogenesis as for example aromatase inhibitors. The detection of oestrogenic chemicals is possible via the measurement of VTG induction in male fish, and it has been abundantly documented in the scientific peer-reviewed literature. VTG induction has also been demonstrated following exposure to aromatisable androgens (6) (7). A reduction in the circulating level of oestrogen in females, for instance through the inhibition of the aromatase converting the endogenous androgen to the natural oestrogen 17 β -oestradiol, causes a decrease in the VTG concentration, which is used to detect chemicals having aromatase inhibiting properties or steroidogenesis inhibitors more broadly (33). The biological relevance of the VTG response following oestrogenic/aromatase inhibition is established and has been broadly documented (8) (9). However, it is possible that production of VTG in females can also be affected by general toxicity and non-endocrine toxic modes of action.

5. Several measurement methods have been successfully developed and standardised for routine use to quantify VTG in blood, liver, whole body or head/tail homogenate samples collected from individual fish. This is the case for zebrafish, three-spined stickleback and Japanese medaka and also the partially validated species fathead minnow; species-specific Enzyme-Linked Immunosorbent Assay (ELISA) methods using immunochemistry for the quantification of VTG are available (5) (10) (11) (12) (13) (14) (15) (16). In Japanese medaka and zebrafish, there is a good correlation between VTG measured from blood plasma, liver and homogenate samples although homogenates tend to show slightly lower values than plasma (17) (18) (19). Appendix 5 provides the recommended procedures for sample collection for VTG analysis.

6. Change in the phenotypic sex ratio (proportions of sex) is an endpoint reflecting sex reversal. In principle, oestrogens, anti-oestrogens, androgens, anti-androgens and steroidogenesis inhibiting chemicals can affect the sex ratio of developing fish (20). It has been shown that this sex reversal is partly reversible in zebrafish (21) following oestrogen-like chemical exposure, whereas sex reversal following androgen-like chemical exposure is permanent (30). The sex is defined as female, male, intersex (both oocytes and spermatogenic cells in one gonad) or undifferentiated, determined in individual fish via histological examination of the gonads. Guidance is given in Appendix 7 and in the OECD Guidance Document on the Diagnosis of Endocrine-Related Histopathology of Fish Gonads (22).

7. Genetic sex is examined via genetic markers when they exist in a given fish species. In Japanese medaka the female XX or male XY genes can be detected by Polymerase Chain-Reaction (PCR), or the Y-linked DM domain gene (DMY) can be analysed (DMY negative or positive) as described in (23) (24). In three-spined stickleback, there is an equivalent

▼ **M6**

PCR method for genetic sex determination described in Appendix 10. Where the genetic sex can be individually linked to the phenotypic sex, the power of the test is improved and therefore genetic sex should be determined in species with documented genetic sex markers.

8. The two core endocrine endpoints, VTG and sex ratio, can in combination demonstrate the endocrine mode of action (MOA) of the chemical (Table 1). The sex ratio is a population relevant biomarker (25) (26) and for some well defined modes of action, the FSDT results may be used for hazard and risk assessment purposes when deemed appropriate by the regulatory agency. These modes of action are at present oestrogens, androgens and steroidogenesis inhibitors.

Table 1

Reaction of the endocrine endpoints to different modes of action of chemicals

↑ = increasing, ↓ = decreasing, — = not investigated

MOA	VTG ♂	VTG ♀	Sex ratio	References
Weak oestrogen agonist	↑	↑	↑♀ or ↑Undiff	(27) (40)
Strong oestrogen agonist	↑	↑	↑♀ or ↑Undiff, No ♂	(28) (40)
Oestrogen antagonist	—	—	↓♀, ↑Undiff.	(29)
Androgen agonist	↓ or —	↓ or —	↑♂, No ♀	(28) (30)
Androgen antagonist	—	—	↑♀ ↑Intersex	(31)
Aromatase inhibitor	↓	↓	↓♀	(33)

9. The FSDT does not cover the reproductive life stage of the fish and therefore chemicals that are suspected to affect reproduction at lower concentrations than sexual development should be examined in a test that covers reproduction.
10. Definitions for the purpose of this Test Method are given in Appendix 1.
11. The *in vivo* FSDT is intended to detect chemicals with androgenic and oestrogenic properties as well as anti-androgenic, anti-oestrogenic and steroidogenesis inhibiting properties. The FSDT validation phases (1 and 2) did cover oestrogenic, androgenic and steroidogenesis inhibiting chemicals. The effects in the FSDT of oestrogen- and androgen antagonists can be seen in Table 1 but these MOA are less documented at present time.

PRINCIPLE OF THE TEST

12. In the test, fish are exposed, from newly fertilised egg until the completion of sexual differentiation, to at least three concentrations of the test chemical dissolved in water. The test conditions should be flow-through unless not possible due to the availability or nature (e.g. limited solubility) of the test chemical. The test starts with the placing of newly fertilised eggs (before cleavage of the blastodisc) in the test chambers. The loading of the chambers is described for each species in paragraph 27. For the validated fish species, Japanese medaka, the three-spined stickleback and zebrafish, the test is terminated at 60 dph. At test termination, all fish are euthanised humanely. A biological sample (blood plasma, liver or head/tail homogenate) is collected for VTG analysis from each fish and the remaining part is fixed for histological evaluation of the gonads to determine the

▼ M6

phenotypic sex; optionally, histopathology (e.g. staging of gonads, severity of intersex) can be performed. A biological sample (the anal- or the dorsal fin) for the determination of the genetic sex is taken in species possessing appropriate markers (Appendices 9 and 10).

13. An overview of relevant test conditions specific for validated species: Japanese medaka, the three-spined stickleback and zebrafish is provided in Appendix 2.

INFORMATION ON THE TEST CHEMICAL

14. Results from an acute toxicity test or other short-term toxicity assay [e.g. test method C.14 (34) and OECD TG 210 (1)], preferably performed with the species chosen for this test, should be available. This implies that the water solubility and the vapour pressure of the test chemical are known and a reliable analytical method for the quantification of the chemical in the test chambers, with known and reported accuracy and limit of detection, is available.
15. Other useful information includes the structural formula, purity of the chemical, stability in water and light, pKa, P_{ow} and results of a test for ready biodegradability (Test Method C.4) (35).

Test acceptance criteria

16. For the test results to be acceptable the following conditions apply:
 - The dissolved oxygen concentration should be at least 60 per cent of the air saturation value (ASV) throughout the test;
 - The water temperature should not differ by more than $\pm 1,5$ °C between test chambers at any one time during the exposure period and be maintained within the temperature ranges specified for the test species (Appendix 2);
 - A validated method for analysis of the exposure chemical with a detection limit well below the lowest nominal concentration should be available and evidence should be gathered to demonstrate that the concentrations of the test chemical in solution have been satisfactorily maintained within ± 20 % of the mean measured values;
 - Overall survival of fertilised eggs in the controls and, where relevant, in the solvent controls, should be greater than or equal to the limits defined in Appendix 2;
 - Acceptance criteria related to growth and proportions of sex at termination of the test are based on data from the control groups (pooled solvent and water control unless they are significantly different, then solvent only):

▼ M6

		Japanese medaka	Zebrafish	Three-spined stickleback
Growth	Fish wet weight, blotted dry	> 150 mg	> 75 mg	> 120 mg
	Length (standard length)	> 20 mm	> 14 mm	> 20 mm
Sex ratio (% males or females)		30-70 %	30-70 %	30-70 %

- When a solvent is used it should have no statistical significant effect on survival and should not produce any endocrine disrupting effects or other adverse effects on the early-life stages as revealed by a solvent control.

If a deviation from the test acceptance criteria is observed, the consequences should be considered in relation to the reliability of the test data and these considerations should be included in the reporting.

DESCRIPTION OF THE TEST METHOD**Test chambers**

17. Any glass, stainless steel or other chemically inert chambers can be used. The dimensions of the chambers should be large enough to allow compliance with loading rate criteria given below. It is desirable that test chambers be randomly positioned in the test area. A randomised block design with each concentration being present in each block is preferable to a completely randomised design. The test chambers should be shielded from unwanted disturbance.

Selection of species

18. Recommended fish species are given in Appendix 2. The procedures for inclusion of new species are given in paragraph 2.

Holding of parental fish

19. Details on holding the parental fish under satisfactory conditions may be found in OECD TG 210(1). Parental fish should be fed once or twice a day with appropriate food.

Handling of embryos and larvae

20. Initially, embryos and larvae may be exposed within a main chamber in smaller glass or stainless steel chambers, fitted with mesh sides or ends to permit a flow of test chemical through the chamber. Non-turbulent flow through these small chambers may be induced by suspending them from an arm arranged to move the chamber up and down but always keeping the organisms submerged.
21. Where egg containers, grids or meshes have been used to hold eggs within the main test chamber, these restraints should be removed after the larvae hatch, except that meshes should be retained to prevent the escape of the fish. If there is a need to transfer the larvae, they should not be exposed to the air and nets should not be used to release fish from egg containers. The timing of this transfer varies with the species and transfer may not always be necessary.

▼ M6**Water**

22. Any water in which the test species shows control survival at least as good as in water described in Appendix 3 is suitable as test water. It should be of constant quality during the period of the test. In order to ensure that the dilution water will not unduly influence the test result (for example by reacting with the test chemical) or adversely affect the performance of the brood stock, samples should be taken at intervals for analysis. Total organic carbon, conductivity, pH and suspended solids should be measured, for example every three months where dilution water is known to be relatively constant in quality. Measurements of heavy metals (e.g. Cu, Pb, Zn, Hg, Cd, Ni), major anions and cations (e.g. Ca²⁺, Mg²⁺, Na⁺, K⁺, Cl⁻, SO₄²⁻) and pesticides should be done, if water quality is questionable. Details about chemical analysis and water collection can be found in paragraph 34.

Test solutions

23. Flow-through system should be used if practically possible. For flow-through tests, a system that continually dispenses and dilutes a stock solution of the test chemical (e.g. metering pump, proportional diluter, and saturator system) is necessary to deliver a series of concentrations to the test chambers. The flow rates of stock solutions and dilution water should be checked at intervals during the test and should not vary by more than 10 % throughout the test. A flow rate equivalent to at least five test chamber volumes per 24 hours has been found suitable (1). Care should be taken to avoid the use of plastic tubing or other materials, some of which may contain biologically active chemicals or may adsorb the test chemical.
24. The stock solution should preferably be prepared without the use of solvents by simply mixing or agitating the test chemical in the dilution water by using mechanical means (e.g. stirring or ultrasonication). If the test chemical is difficult to dissolve in water, procedures described in the OECD Guidance Document on aquatic toxicity testing of difficult substances and mixtures should be followed (36). The use of solvents should be avoided but may be necessary in some cases in order to produce a suitably concentrated stock solution. Examples of suitable solvents are given in (36).
25. Semi-static test conditions should be avoided unless justification is provided on compelling reasons associated with the test chemical (e.g. stability, limited availability, high cost or hazard). For the semi-static technique, two different renewal procedures may be followed. Either new test solutions are prepared in clean chambers and surviving eggs and larvae gently transferred into the new chambers, or the test organisms are retained in the test chambers whilst a proportion (at least two thirds) of the test water is changed daily.

PROCEDURE**Conditions of Exposure***Collection of eggs and duration*

26. To avoid genetic bias, eggs are collected from a minimum of three breeding pairs or groups, mixed and randomly selected to initiate the test. For the three-spined stickleback, see the description of artificial fertilisation in Appendix 11. The test should start as soon as possible after the eggs have been fertilised, the embryos preferably being immersed in the test solutions before cleavage of the blastodisc commences, or as close as

▼M6

possible after this stage and no later than 12 h post fertilisation. The test should continue until sexual differentiation in the control group is completed (60 dph for Japanese medaka, the three-spined stickleback and zebrafish).

Loading

27. The number of fertilised eggs at the start of the test should be at least 120 per concentration divided between a minimum of 4 replicates (square root allocation to control is accepted). The eggs should be randomly distributed (by using statistical tables for randomisation) among treatments. The loading rate (for definition, see Appendix 1) should be low enough in order that a dissolved oxygen concentration of at least 60 % of the ASV can be maintained without direct aeration of the chambers. For flow-through tests, a loading rate not exceeding 0,5 g/l per 24 hours, and not exceeding 5 g/l of solution at any time is recommended. No later than 28 days post fertilisation the number of fish per replicate should be redistributed, so that each replicate contains as equal a number of fish as possible. If exposure related mortality occurs, the number of replicates should be reduced appropriately so that fish density between treatment levels is kept as equal as possible.

Light and temperature

28. The photoperiod and water temperature should be appropriate for the test species (see Appendix 2 for experimental conditions for the FSDT).

Feeding

29. Food and feeding are critical, and it is essential that the correct food for each stage is supplied at appropriate time intervals and at a level sufficient to support normal growth. Feeding should be *ad libitum* whilst minimising the surplus. To obtain a sufficient growth rate, fish should be fed at least twice daily (accepting once daily on weekends), separated by at least three hours between each feed. Surplus food and faeces should be removed, as necessary, to avoid accumulation of waste. As experience is gained, food and feeding regimes are continuously being refined to improve survival and optimise growth. Effort should therefore be made to confirm the proposed regime with acknowledged experts. Feeding should be withheld 24 hours before ending the test. Examples of appropriate food items are listed in Appendix 2 (see also the OECD Fish Testing Framework (39)).

Test concentrations

30. Test chemicals should be spaced as described in Appendix 4. A minimum of three test concentrations in at least four replicates should be used. The curve relating LC₅₀ to period of exposure in the acute studies available should be considered when selecting the range of test concentrations. Five test concentrations are recommended if the data are to be used for risk assessment.
31. Concentrations of the chemical higher than 10 % of the acute adult LC₅₀ or 10 mg/l, whichever is the lower, need not be tested. The maximum test concentration should be 10 % of the LC₅₀ on the larval/juvenile life-stage.

▼ M6**Controls**

32. A dilution water control (≥ 4 replicates) and, if relevant, a solvent control (≥ 4 replicates) should be run in addition to the test concentrations. Only solvents that have been investigated not to have any statistical significant influence on the test endpoints should be used in the test.

33. Where a solvent is used, its final concentration should not be greater than 0,1 ml/l (36) and it should be the same concentration in all test chambers, except the dilution water control. However, every effort should be made to avoid the use of such solvent or keep solvent's concentrations to a minimum.

Frequency of Analytical Determinations and Measurements

34. Chemical analysis of the test chemical concentration should be performed before initiation of the test to check compliance with the acceptance criteria. All replicates should be analysed individually at the beginning and termination of the test. One replicate per test concentration should be analysed at least once per week during the test, changing systematically between replicates (1,2,3,4,1,2...). If samples are stored to be analysed at a later time, the storage method of the samples should be previously validated. Samples should be filtered (e.g. using a 0,45 μm pore size) or centrifuged to ensure that the determinations are made on the chemical in true solution.

35. During the test, dissolved oxygen, pH, total hardness, conductivity, salinity (if relevant), and temperature should be measured in all test chambers. As a minimum dissolved oxygen, salinity (if relevant), and temperature should be measured weekly, and pH, conductivity and hardness at the beginning and at the end of the test. Temperature should preferably be monitored continuously in at least one test chamber.

36. Results should be based on measured concentrations. However, if the concentration of the test chemical in solution has been satisfactorily maintained within $\pm 20\%$ of the nominal concentration throughout the test, then the results can either be based on nominal or measured values.

Observations and measurements*Stage of embryonic development*

37. The exposure should begin as soon as possible after fertilisation and before cleavage of the blastodisc commences and no later than 12 h post fertilisation to ensure exposure during early embryonic development.

Hatching and survival

38. Observations on hatching and survival should be made at least once daily and numbers recorded. Dead embryos, larvae and juvenile fish should be removed as soon as observed since they can decompose rapidly and may be broken up by the actions of the other fish. Extreme care should be taken when removing dead individuals not to knock or physically damage adjacent eggs/larvae, these being extremely delicate and sensitive. Criteria for death vary according to life stage:

— for eggs: particularly in the early stages, a marked loss of translucency and change in coloration, caused by coagulation and/or precipitation of protein, leading to a white opaque appearance;

▼ M6

- for larvae and juvenile fish: immobility and/or absence of respiratory movement and/or absence of heart-beat and/or white opaque coloration of central nervous system and/or lack of reaction to mechanical stimulus.

Abnormal appearance

39. The number of larvae or fish showing abnormality of body form should be recorded, and the appearance and the nature of the abnormality described. It should be noted that abnormal embryos and larvae occur naturally and can be of the order of several per cent in the control(s) in some species. Abnormal animals should only be removed from the test chambers on death. However, in accordance with Directive 2010/63/EU of the European Parliament and of the Council of 22 September 2010 on the protection of animals used for scientific purposes, if abnormalities result in pain, suffering and distress or lasting harm, and death can be reliably predicted, animals should be anaesthetised and euthanised according to the description in paragraph 44 and treated as mortality for data analysis..

Abnormal behaviour

40. Abnormalities, e.g. hyperventilation, uncoordinated swimming, atypical quiescence and atypical feeding behaviour should be recorded at appearance.

Weight

41. At the end of the test all surviving fish should be euthanised (anaesthetised if blood samples should be taken), and individual wet weight (blotted dry) should be measured.

Length

42. At the end of the test, individual lengths (standard length) should be measured.

43. These observations will result in some or all of the following data being available for reporting:

- cumulative mortality;
- numbers of healthy fish at end of test;
- time to start of hatching and end of hatching;
- length and weight of surviving animals;
- numbers of deformed larvae;
- numbers of fish exhibiting abnormal behaviour.

Sampling of fish

44. Fish sampling is performed at termination of the test. Sampled fish should be euthanised with e.g. MS-222 (100-500 mg per l buffered with 200 mg NaHCO₃ per l) or FA-100 (4-allyl-2-methoxyphenol: eugenol) and individually measured and weighed as wet weight (blotted dry) or anaesthetised if a blood sample should be taken (see paragraph 49).

Sampling for VTG analysis and sex determination via histological evaluation

45. All fish should be sampled and prepared for analysis of sex and VTG. All fish should be analysed histologically to determine sex. For the VTG measurements, a sub-sampling of at least 16 fish from each replicate is

▼M6

accepted. More fish should be analysed for VTG if the results of the sub-sampling turn out to be unclear.

46. The sampling procedure for VTG and sex determination is dependent on the VTG analysis method:

Head/tail homogenate method for VTG analysis

47. The fish is euthanised. Head and tail of each fish are separated from the body of the fish by cuts made right behind the pectoral fins, and right behind the dorsal fin, using a scalpel (See Figure 1). The head and tail part from each fish are pooled, weighed and individually numbered, frozen in liquid nitrogen and stored at -70° or less for VTG analysis. The body part of the fish is numbered and fixed in an appropriate fixative for histological evaluation (22). By use of this method VTG and histopathology are evaluated on each individual and a possible change in the VTG level can thus be related to the phenotypic sex of the fish or genetic sex (Japanese medaka and the three-spined stickleback) of the fish. For further information see guidance for homogenisation (Appendix 5) and guidance for VTG quantification (Appendix 6).

Liver homogenate method for VTG analysis

48. The fish is euthanised. The liver is dissected out and stored at -70°C or below. Recommended procedures for liver excision and pre-treatment are available in OECD TG 229 (37) or Chapter C.37 of this Annex (38). Livers are then individually homogenised as described in OECD TG 229 or Chapter C.37 of this Annex. The supernatant collected is used for measuring VTG with a homologous ELISA technique (see Appendix 6 for an example of quantification in zebrafish or OECD TG 229 (37) for Japanese medaka). Following this approach, it is also possible to have individual fish data on both VTG and gonad histology.

Blood plasma method for VTG analysis

49. Blood is collected from the anaesthetised fish by cardiac puncture, caudal vein or tail cutting, and centrifuged at 4°C for plasma collection. The plasma is stored at -70°C or below until use. The whole fish is euthanised and fixed for histology. Both plasma samples and fish are numbered individually to relate VTG levels to the sex of the fish.

Figure 1

How to cut a fish for measurement of VTG in head/tail homogenate and histological evaluation of the mid section

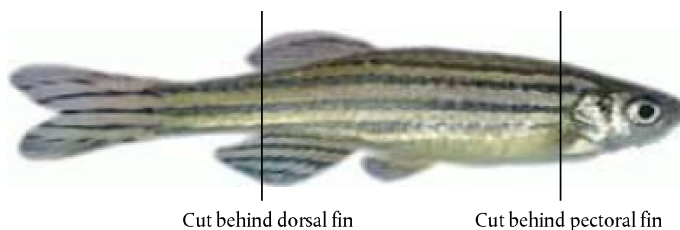

▼ M6*Genetic sex determination*

50. A biological sample for the determination of the genetic sex is taken from individual fish in species possessing appropriate markers. For Japanese medaka, the anal fin or dorsal fin is collected. A detailed description is given in Appendix 9 including tissue sampling and sex determination by a PCR-method. Equally, for the three spined stickleback, a description of tissue sampling and a sex determining PCR-method is given in Appendix 10.

VTG measurement

51. The measurement of VTG should be based upon a quantitative and analytically validated method. Information should be available upon the intra-assay and inter-assay variability of the method used in a given laboratory. The source of inter- and intra-laboratory variability is (most likely) based on the different developing stages of the fish population. Considering the variability of VTG measurement, NOECs based on this endpoint alone should be treated with great care. Different methods are available to assess VTG production in the fish species considered in this assay. A measurement technique that is both relatively sensitive and specific is the determination of protein concentrations via enzyme-linked immunosorbent assay (ELISA). Homologous antibodies (raised against VTG of the same species) and most important homologous standards should be used.

Sex determination

52. Dependent on the VTG sampling procedure, whole fish or the remaining mid-section of each fish is placed in a pre-labelled processing cassette and fixed in an appropriate fixative for histological determination of sex (optionally also for evaluation of gonadal staging). Guidance on fixation and embedding is provided in Appendix 7 as well as in the OECD Guidance Document on the Diagnosis of Endocrine-Related Histopathology of Fish Gonads (22). After processing, the fish are embedded in paraffin blocks. The individuals should be placed longitudinally in the paraffin block. At least six longitudinal sections (3-5 µm in thickness) in a frontal plane including gonadal tissue from both gonads are taken from each individual. The interval between these sections should be approximately 50 µm for males and 250 µm for females. However, since each block will often contain males and females (if more than one individual are embedded in each block), the interval between sections from these blocks should be approximately 50 µm until at least six sections of the gonads from each male are obtained. Thereafter, the interval between sections can be increased to approximately 250 µm for the females. Sections are stained with haematoxylin and eosin and examined by light-microscopy with focus on sex (male, female, intersex or undifferentiated). Intersex is defined as presence of more than one oocyte in testis per six sections analysed or spermatogenic cells (yes/no) in ovaries. Histopathology and staging of ovaries and testis is optional but if investigated, the results should be statistically analyzed and reported. It should be noted that some fish species naturally lack a fully developed pair of gonads and only one gonad may be present (e.g. Japanese medaka and occasionally zebrafish). All such observations should be recorded.

53. Genetic sex determination in individual Japanese medaka is based on the presence or absence of the medaka male-sex determining gene, DMY, which is located on the Y chromosome. The genotypic sex of medaka can be identified by sequencing the DMY gene from DNA extracted from for instance a piece of anal fin or dorsal fin. The presence of DMY indicates a XY (male) individual regardless of phenotype, while the absence of DMY

▼M6

indicates a XX (female) individual regardless of phenotype (23). Guidance for tissue preparation and PCR method is given in Appendix 9. The genetic sex determination in individual three-spined stickleback is also performed via a PCR method, described in Appendix 10.

54. The occurrence of intersex (for definition, see Appendix 1) should be reported.

Secondary sexual characteristics

55. Secondary sexual characteristics are under endocrine control in species like the Japanese medaka; therefore observations of physical appearance of the fish should if possible be made at the end of the exposure. In the Japanese medaka, the papillary formation on the posterior part of the anal fin in females is androgen sensitive. Chapter C.37 of this Annex (38) provides relevant photographs of male secondary sex characteristics and androgenised females.

DATA AND REPORTING**Treatment of results**

56. It is important that the strongest valid statistical test determine the endpoint. The replicate is the experimental unit but intra-replicate variability should be included in the statistical testing. A decision flow-chart is available in Appendix 8 to help with the most appropriate statistical test to use based on the characteristic of the data obtained from the test. Statistical significance level is 0,05 for all endpoints included.

Proportions of sex and genetic sex

57. The proportions of sex should be analysed for significant effect (NOEC/LOEC approach) of exposure by Jonckheere-Terpstra (Trend test) if a monotone dose-response exists. If non-monotonicity is found then a pair wise test should be applied: Use Dunnett's test if normality and homogenous variance can be obtained. Use Tamhane-Dunnett if heterogeneous variance is present. Otherwise use exact Mann-Whitney test with Bonferroni-Holm adjustment. A flow chart describing the statistics of the proportions of sex is placed in Appendix 8. The proportions of sex should be presented in tables as concentration proportions \pm SD of males, females, intersex and undifferentiated. Statistical significance should be highlighted. Examples are presented in the FSDT Phase 2 validation report (42). Genetic sex should be reported as percentage of phenotypic sex reversal of males, females, intersex and undifferentiated.

VTG concentrations

58. VTG concentrations should be analysed for significant effect (NOEC/LOEC approach) of exposure. The Dunnett test is preferable to the t-test with Bonferroni correction. Where a Bonferroni correction is used, the Bonferroni-Holm correction is preferable. Allowance should be made for log-transformation of VTG to achieve normality and variance homogeneity. Next, if the concentration-response is consistent with monotonicity, then the Jonckheere-Terpstra test is preferable to any of the above. If t-tests or Dunnett's test is used, there is no need for a ANOVA significance F-test in order to proceed. For details see the flow chart in Appendix 8. Results

▼ M6

should be reported in tables as concentration means \pm SD for males, females, intersex and undifferentiated separately. Statistical significance for phenotypic females and phenotypic males should be highlighted. Examples are presented in the FSDT Phase 2 validation report (42).

Test chemical actual concentrations

59. The actual chamber concentrations of the test chemical should be analysed in frequencies described in paragraph 34. Results should be reported in tables as mean concentration \pm SD on replicate basis as well as on concentration basis with information on number of samples and with outliers from the mean treatment concentration \pm 20 % highlighted. Examples can be found in the FSDT Phase 2 validation report (42).

Interpretation of results

60. The test results should be interpreted with caution where measured test chemical concentrations in test solutions occur at levels near the detection limit of the analytical method.

Test report

61. The test report should include the following information:

Test chemical

- Relevant physical-chemical properties; chemical identification data including purity and analytical method for quantification of the test chemical.

Test conditions

- Test procedure used (e.g. flow-through semi-static/renewal); test design including test concentrations, method of preparation of stock solutions (in an Annex), frequency of renewal (the solubilising agent and its concentration should be given, when used);
- The nominal test concentrations, the means of the measured values and their standard deviations in the test chambers and the method by which these were attained (the analytical method used should be presented in an Annex); Evidence that the measurements refer to the concentrations of the test chemical in true solution;
- Water quality within test chambers: pH, hardness, temperature and dissolved oxygen concentration;
- Detailed information on feeding (e.g. type of food(s), source, amount given and frequency and analyses for contaminants (e.g. PCBs, PAHs and organochlorine pesticides) if relevant.

Results

- Evidence that controls met the validity criteria: data on hatching rate should be presented in tables as percentage per replicate and per concentration. Outliers from the acceptance criteria (in controls) should be highlighted. Survival should be presented as percentage per replicate and per concentration. Outliers from the validity criteria (in controls) should be highlighted;
- Clear indication of the results obtained on the different endpoints observed: embryo survival and hatching success; external abnormalities; length and weight; VTG measurements (ng/g homogenate, ng/ml plasma or ng/mg liver); gonadal histology, sex ratio, genetic sex data; incidence

▼ **M6**

of any unusual reactions by the fish and any visible effects produced by the test chemical.

62. The results should be presented as mean values \pm standard deviation (SD) or standard error (SE). Statistics should be reported as a minimum as NOEC and LOEC and confidence intervals. The statistical flow chart (Appendix 8) should be followed.

LITERATURE

- (1) OECD (1992), *Fish, Early Life Stage Toxicity Test*, Test Guideline No. 210, Guidelines for the Testing of Chemicals, OECD, Paris.
- (2) Jobling, S., D. Sheahan, J.A. Osborne, P. Matthiessen, and J.P. Sumpter, 1996, 'Inhibition of testicular growth in rainbow trout (*Oncorhynchus mykiss*) exposed to estrogenic alkylphenolic chemicals', *Environmental Toxicology and Chemistry* 15, pp. 194-202.
- (3) Sumpter, J.P. and S. Jobling, 1995, 'Vitellogenesis As A Biomarker for Estrogenic Contamination of the Aquatic Environment', *Environmental Health Perspectives* 103, pp. 173-178.
- (4) Tyler, C.R., R.van Aerle, T.H. Hutchinson, S. Maddix, and H. Trip (1999), 'An in vivo testing system for endocrine disruptors in fish early life stages using induction of vitellogenin', *Environmental Toxicology and Chemistry* 18, pp. 337-347.
- (5) Holbech, H., L. Andersen, G.I. Petersen, B. Korsgaard, K.L. Pedersen, and P. Bjerregaard (2001a), 'Development of an ELISA for vitellogenin in whole body homogenate of zebrafish (*Danio rerio*)', *Comparative Biochemistry and Physiology C-Toxicology & Pharmacology* 130, pp. 119-131.
- (6) Andersen, L., P. Bjerregaard, and B. Korsgaard (2003), 'Vitellogenin induction and brain aromatase activity in adult male and female zebrafish exposed to endocrine disruptors', *Fish Physiology and Biochemistry* 28, pp. 319-321.
- (7) Orn, S., H. Holbech, T.H. Madsen, L. Norrgren, and G.I. Petersen (2003), 'Gonad development and vitellogenin production in zebrafish (*Danio rerio*) exposed to ethinylestradiol and methyltestosterone', *Aquatic Toxicology* 65, pp. 397-411.
- (8) Panter, G.H., T.H. Hutchinson, R. Lange, C.M. Lye, J.P. Sumpter, M. Zerulla, and C.R. Tyler (2002), 'Utility of a juvenile fathead minnow screening assay for detecting (anti-)estrogenic substances', *Environmental Toxicology and Chemistry* 21, pp. 319-326.
- (9) Sun, L.W., J.M. Zha, P.A. Spear, and Z.J. Wang (2007), 'Toxicity of the aromatase inhibitor letrozole to Japanese medaka (*Oryzias latipes*) eggs, larvae and breeding adults', *Comparative Biochemistry and Physiology C-Toxicology & Pharmacology* 145, pp. 533-541.
- (10) Parks, L.G., A.O. Cheek, N.D. Denslow, S.A. Heppell, J.A. McLachlan, G.A. LeBlanc, and C.V. Sullivan (1999), 'Fathead minnow (*Pimephales promelas*) vitellogenin: purification, characterization and quantitative immunoassay for the detection of estrogenic compounds', *Comparative Biochemistry and Physiology C-Toxicology & Pharmacology* 123, pp. 113-125.
- (11) Brion, F., B.M. Nilsen, J.K. Eidem, A. Goksoyr, and J.M. Porcher (2002), 'Development and validation of an enzyme-linked immunosorbent assay to measure vitellogenin in the zebrafish (*Danio rerio*)', *Environmental Toxicology and Chemistry* 21, pp. 1699-1708.
- (12) Nishi, K., M. Chikae, Y. Hatano, H. Mizukami, M. Yamashita, R. Sakakibara, and E. Tamiya (2002), 'Development and application of a monoclonal antibody-based sandwich ELISA for quantification of Japanese medaka (*Oryzias latipes*) vitellogenin', *Comparative Biochemistry and Physiology C-Toxicology & Pharmacology* 132, pp. 161-169.
- (13) Hahlbeck, E., I. Katsiadaki, I. Mayer, M. Adolfsson-Erici, J. James, and B.E. Bengtsson (2004), 'The juvenile three-spined stickleback (*Gasterosteus*

▼ **M6**

- aculeatus L.) as a model organism for endocrine disruption — II — kidney hypertrophy, vitellogenin and spiggin induction', *Aquatic Toxicology* 70, pp. 311-326.
- (14) Tatarazako, N., M. Koshio, H. Hori, M. Morita, and T. Iguchi (2004), 'Validation of an enzyme-linked immunosorbent assay method for vitellogenin in the medaka', *Journal of Health Science* 50, pp. 301-308.
- (15) Eidem, J.K., H. Kleivdal, K. Kroll, N. Denslow, R. van Aerle, C. Tyler, G. Panter, T. Hutchinson, and A. Goksoyr (2006), 'Development and validation of a direct homologous quantitative sandwich ELISA for fathead minnow (*Pimephales promelas*) vitellogenin. *Aquatic Toxicology*', 78, pp. 202-206.
- (16) Jensen, K.M. and G.T. Ankley (2006), 'Evaluation of a commercial kit for measuring vitellogenin in the fathead minnow (*Pimephales promelas*)', *Ecotoxicology and Environmental Safety* 64, pp. 101-105.
- (17) Holbech, H., Petersen, G. I., Norman, A., Örn, S, Norrgren, L., and Bjerregaard, P (2001b), 'Suitability of zebrafish as test organism for detection of endocrine disrupting chemicals. Comparison of vitellogenin in plasma and whole body homogenate from zebrafish (*Danio rerio*) and rainbow trout (*Oncorhynchus mykiss*)', *Nordic Council of Ministers, TemaNord 2001:597*, pp. 48-51.
- (18) Nilsen, B.M., K. Berg, J.K. Eidem, S.I. Kristiansen, F. Brion, J.M. Porcher, and A. Goksoyr (2004), 'Development of quantitative vitellogenin-ELISAs for fish test species used in endocrine disruptor screening', *Analytical and Bioanalytical Chemistry* 378, pp. 621-633.
- (19) Orn, S., S. Yamani, and L. Norrgren (2006), 'Comparison of vitellogenin induction, sex ratio, and gonad morphology between zebrafish and Japanese medaka after exposure to 17 alpha-ethinylestradiol and 17 beta-trenbolone', *Archives of Environmental Contamination and Toxicology* 51, pp. 237-243.
- (20) Scholz, S. and N. Kluver (2009), 'Effects of Endocrine Disrupters on Sexual, Gonadal Development in Fish, *Sexual Development* 3', pp. 136-151.
- (21) Fenske, M., G. Maack, C. Schafers, and H. Segner (2005), 'An environmentally relevant concentration of estrogen induces arrest of male gonad development in zebrafish, *Danio rerio*', *Environmental Toxicology and Chemistry* 24, pp. 1088-1098.
- (22) OECD (2010), *Guidance Document on the Diagnosis of Endocrine-related Histopathology in Fish Gonads*, Series on Testing and Assessment No. 123, ENV/JM/MONO(2010)14, OECD, Paris.
- (23) Kobayashi, T., M. Matsuda, H. Kajiura-Kobayashi, A. Suzuki, N. Saito, M. Nakamoto, N. Shibata, and Y. Nagahama (2004), 'Two DM domain genes, DMY and DMRT1, involved in testicular differentiation and development in the medaka, *Oryzias latipes*', *Developmental Dynamics* 231, pp. 518-526.
- (24) Shinomiya, A., H. Otake, K. Togashi, S. Hamaguchi, and M. Sakaizumi (2004), 'Field survey of sex-reversals in the medaka, *Oryzias latipes*: genotypic sexing of wild populations', *Zoological Science* 21, pp. 613-619.
- (25) Kidd, K.A., P.J. Blanchfield, K.H. Mills, V.P. Palace, R.E. Evans, J.M. Lazorchak, and R.W. Flick (2007), 'Collapse of a fish population after exposure to a synthetic estrogen', *Proceedings of the National Academy of Sciences of the United States of America* 104, pp. 8897-8901.
- (26) Palace, V.P., R.E. Evans, K.G. Wautier, K.H. Mills, P.J. Blanchfield, B.J. Park, C.L. Baron, and K.A. Kidd (2009), 'Interspecies differences in biochemical, histopathological, and population responses in four wild fish species exposed to ethinylestradiol added to a whole lake', *Canadian Journal of Fisheries and Aquatic Sciences* 66, pp. 1920-1935.
- (27) Panter, G.H., T.H. Hutchinson, K.S. Hurd, J. Bamforth, R.D. Stanley, S. Duffell, A. Hargreaves, S. Gimeno, and C.R. Tyler (2006), 'Development of chronic tests for endocrine active chemicals — Part I. An extended fish early-life stage test for oestrogenic active chemicals in the fathead minnow (*Pimephales promelas*)', *Aquatic Toxicology* 77, pp. 279-290.

▼ **M6**

- (28) Holbech, H., K. Kinnberg, G.I. Petersen, P. Jackson, K. Hylland, L. Norrgren, and P. Bjerregaard (2006), 'Detection of endocrine disrupters: Evaluation of a Fish Sexual Development Test (FSDT)', *Comparative Biochemistry and Physiology C-Toxicology & Pharmacology* 144, pp. 57-66.
- (29) Andersen, L., K. Kinnberg, H. Holbech, B. Korsgaard, and P. Bjerregaard (2004), 'Evaluation of a 40 day assay for testing endocrine disrupters: Effects of an anti-estrogen and an aromatase inhibitor on sex ratio and vitellogenin concentrations in juvenile zebrafish (*Danio rerio*)', *Fish Physiology and Biochemistry* 30, pp. 257-266.
- (30) Morthorst, J.E., H. Holbech, and P. Bjerregaard (2010), 'Trenbolone causes irreversible masculinization of zebrafish at environmentally relevant concentrations', *Aquatic Toxicology* 98, pp. 336-343.
- (31) Kiparissis, Y., T.L. Metcalfe, G.C. Balch, and C.D. Metcalf (2003), 'Effects of the antiandrogens, vinclozolin and cyproterone acetate on gonadal development in the Japanese medaka (*Oryzias latipes*)', *Aquatic Toxicology* 63, pp. 391-403.
- (32) Panter, G.H., T.H. Hutchinson, K.S. Hurd, A. Sherren, R.D. Stanley, and C.R. Tyler (2004), 'Successful detection of (anti-) androgenic and aromatase inhibitors in pre-spawning adult fathead minnows (*Pimephales promelas*) using easily measured endpoints of sexual development', *Aquatic Toxicology* 70, pp. 11-21.
- (33) Kinnberg, K., H. Holbech, G.I. Petersen, and P. Bjerregaard (2007), 'Effects of the fungicide prochloraz on the sexual development of zebrafish (*Danio rerio*)', *Comparative Biochemistry and Physiology C-Toxicology & Pharmacology* 145, pp. 165-170.
- (34) Chapter C.14 of this Annex, Fish Juvenile Growth Test.
- (35) Chapter C.4 of this Annex, Ready Biodegradability.
- (36) OECD (2000), *Guidance Document on Aquatic Toxicity Testing of Difficult Substances and Mixtures*, Series on Testing and Assessment No. 23, OECD, Paris.
- (37) OECD (2009), *Fish Short Term Reproduction Assay*, Test Guideline No. 229, Guidelines for the Testing of Chemicals, OECD, Paris.
- (38) Chapter C.37 of this Annex, 21-Day Fish Assay: A Short Term Screening for Oestrogenic and Androgenic Activity, and Aromatase Inhibition.
- (39) OECD (2012), *Fish Toxicity Testing Framework*, Series on Testing and Assessment No. 171, OECD, Paris
- (40) Schäfers, C., Teigeler, M., Wenzel, A., Maack, G., Fenske, M., Segner, H (2007), 'Concentration- and time-dependent effects of the synthetic estrogen, 17 alpha-ethinylestradiol, on reproductive capabilities of the zebrafish, *Danio rerio*' *Journal of Toxicology and Environmental Health-Part A*, 70, 9-10 pp 768-779.
- (41) OECD (2011), *Validation Report (Phase 1) for the Fish Sexual Development Test*, Series on Testing and Assessment No 141, ENV/JM/MONO(2011)22, OECD, Paris.
- (42) OECD (2011), *Validation Report (Phase 2) for the Fish Sexual Development Test*, Series on Testing and Assessment No 142, ENV/JM/MONO(2011)23, OECD, Paris.
- (43) OECD (2011), *Peer Review Report of the validation of the Fish Sexual Development Test*, Series on Testing and Assessment No 143, ENV/JM/MONO(2011)24, OECD, Paris.
- (44) Directive 2010/63/EU of the European Parliament and of the Council of 22 September 2010 on the protection of animals used for scientific purposes. OJ L 276, 20.10.2010, p. 33.

▼ M6*Appendix 1***Abbreviations and definitions**

Apical endpoint: Causing effect at population level

ASV: Air saturation value

Biomarker: Causing effect at individual level

Chemical: A substance or a mixture.

Dph: Days post hatch

DMY: Y-specific DM-domain gene required for male development in the medaka fish

ELISA: Enzyme-Linked Immunosorbent Assay

Fish weight: Fish wet weight (blotted dry)

FSDT: Fish Sexual Development Test

HPG axis: Hypothalamic-pituitary-gonadal axis

Intersex fish: Fish with more than one oocyte in testis per 6 sections analysed or spermatogenic cells in ovaries (yes/no)

Loading rate: Wet weight of fish per volume of water

MOA: Mode of action

RT-PCR: Reverse Transcriptase Polymerase Chain-Reaction

Test chemical: Any substance or mixture tested using this test method.

Undifferentiated fish: Fish with gonads exhibiting no discernible germ cells.

VTG: Vitellogenin

▼M6

Appendix 2

Experimental conditions for the FSDT (freshwater species)

1. Recommended species	Japanese medaka (<i>Oryzias latipes</i>)	Zebrafish (<i>Danio rerio</i>)	Three-spined Stickleback (<i>Gasterosteus aculeatus</i>)
2. Test type	Flow-through or semi-static	Flow-through or semi-static	Flow-through or semi-static
3. Water temperature	25 ± 2 °C	27 ± 2 °C	20 ± 2 °C
4. Illumination quality	Fluorescent bulbs (wide spectrum)	Fluorescent bulbs (wide spectrum)	Fluorescent bulbs (wide spectrum)
5. Light intensity	10-20 µE/m ² /s, 540-1 080 lux, or 50-100 ft-c (ambient laboratory levels)	10-20 µE/m ² /s, 540-1 080 lux, or 50-100 ft-c (ambient laboratory levels)	10-20 µE/m ² /s, 540-1 080 lux, or 50-100 ft-c (ambient laboratory levels)
6. Photoperiod	12-16 h light, 8-12 h dark	12-16 h light, 8-12 h dark	16 h light, 8 h dark
7. Minimum chamber size	Individual chambers should contain a minimum of 7 l water volume	Individual chambers should contain a minimum of 7 l water volume	Individual chambers should contain a minimum of 7 l water volume
8. Volume exchanges of test solutions	Minimum of 5 daily	Minimum of 5 daily	Minimum of 5 daily
9. Age of test organisms at start of exposure	Newly fertilised eggs (Early blastula stage)	Newly fertilised eggs (Early blastula stage)	Newly fertilised eggs
10. No. of eggs per treatment	Minimum 120	Minimum 120	Minimum 120
11. No. of treatments	Minimum 3 (plus appropriate controls)	Minimum 3 (plus appropriate controls)	Minimum 3 (plus appropriate controls)
12. No. replicates per treatment	Minimum 4 (unless square root allocation to controls)	Minimum 4 (unless square root allocation to controls)	Minimum 4 (unless square root allocation to controls)
13. Feeding regime	Live <i>Artemia</i> , frozen adult brine shrimp, flake food, etc. It is recommended to feed twice daily	Special fry food, live <i>Artemia</i> , frozen adult brine shrimp, flake food, etc. It is recommended to feed twice daily	Live <i>Artemia</i> , frozen adult brine shrimp, flake food, etc. It is recommended to feed twice daily
14. Aeration	None unless DO concentration falls below 60 % saturation	None unless DO concentration falls below 60 % saturation	None unless DO concentration falls below 70 % saturation

▼ **M6**

15. Dilution water	Clean surface, well or reconstituted water	Clean surface, well or reconstituted water	Clean surface, well or reconstituted water
16. Test chemical exposure duration	60-dph	60-dph	60-dph
17. Biological endpoints	Hatching success, Survival Gross-morphology, VTG gonadal histology, Genetic sex, Sex ratio	Hatching success, Survival Gross-morphology, VTG gonadal histology, Sex ratio	Hatching success, Survival Gross-morphology, VTG gonadal histology, Sex ratio
18. Test acceptability criteria for pooled replicates of controls	Hatching success > 80 %	Hatching success > 80 %	Hatching success > 80 %
	Post hatch survival \geq 70 %	Post hatch survival \geq 70 %	Post hatch survival \geq 70 %
	growth (Fish wet weight, blotted dry) > 150 mg	growth (Fish wet weight, blotted dry) > 75 mg	growth (Fish wet weight, blotted dry) > 120 mg
	Length (standard length) > 20mm	Length (standard length) > 14 mm	Length (standard length) > 20 mm
	Sex ratio (% males or females) 30 %-70 %	Sex ratio (% males or females) 30 %-70 %	Sex ratio (% males or females) 30 %-70 %

▼ M6*Appendix 3***Chemical characteristics of an acceptable dilution water**

CONSTITUENT	CONCENTRATION
Particular matter	< 20 mg/l
Total organic carbon	< 2 mg/l
Unionised ammonia	< 1 µg/l
Residual chlorine	< 10 µg/l
Total organophosphorus pesticides	< 50 ng/l
Total organochlorine pesticides plus polychlorinated biphenyls	< 50 ng/l
Total organic chlorine	< 25 ng/l

▼ **M6***Appendix 4***From test method C.14/Guidance on test concentrations**

Column (Number of concentrations between 100 and 10, or between 10 and 1) (*)						
1	2	3	4	5	6	7
100	100	100	100	100	100	100
32	46	56	63	68	72	75
10	22	32	40	46	52	56
3,2	10	18	25	32	37	42
1,0	4,6	10	16	22	27	32
	2,2	5,6	10	15	19	24
	1,0	3,2	6,3	10	14	18
		1,8	4,0	6,8	10	13
		1,0	2,5	4,6	7,2	10
			1,6	3,2	5,2	7,5
			1,0	2,2	3,7	5,6
				1,5	2,7	4,2
				1,0	1,9	3,2
					1,4	2,4
					1,0	1,8
						1,3
						1,0

(*) A series of three (or more) successive concentrations may be chosen from a column. Mid-points between concentrations in column (x) are found in column (2x + 1). The values listed can represent concentrations expressed as percentage per volume or weight (mg/l or µg/l). Values can be multiplied or divided by any power of 10 as appropriate. Column 1 might be used if there was considerable uncertainty on the toxicity level.

▼ **M6***Appendix 5***Guidance for homogenisation of head & tail from juvenile zebrafish, fathead minnow, three spined stickleback and Japanese medaka**

The purpose of this section is to describe the procedures that occur prior to the quantification of the VTG concentration. Other procedures that result in comparable VTG quantification can be used. It is an option to determine the VTG concentration in blood plasma or liver instead of head/tail homogenate.

Procedure

1. The fish are anaesthetised and euthanised in accordance with the test description.
2. The head and tail are cut of the fish in accordance with the test description. **Important:** All dissection instruments, and the cutting board should be rinsed and cleaned properly (e.g. with 96 % ethanol) between handling of each single fish to prevent 'VTG pollution' from females or induced males to un-induced males.
3. The weight of the pooled head and tail from each fish is measured to the nearest mg.
4. After being weighed, the parts are placed in appropriate tubes (e.g. 1,5 ml eppendorf) and frozen at $-80\text{ }^{\circ}\text{C}$ until homogenisation or directly homogenised on ice with two plastic pistils. (Other methods can be used if they are performed on ice and the result is a homogenous mass). **Important:** *The tubes should be numbered properly so that the head and tail from the fish can be related to their respective body-section used for gonad histology.*
5. When a homogenous mass is achieved an amount of 4-10 times the tissue weight of ice-cold **homogenisation buffer** (*) is added (note the dilution). Keep working with the pistils until the mixture is homogeneous. **Important note:** *New pistils are used for each fish.*
6. The samples are placed on ice until centrifugation at $4\text{ }^{\circ}\text{C}$ at 50 000 g for 30 min.
7. Use a pipette to dispense portions of 20 to 50 μl (note the amount) supernatant into **at least two** tubes by dipping the tip of the pipette below the fat layer on the surface and carefully sucking up the supernatant without fat- or pellet fractions.
8. The tubes are stored at $-80\text{ }^{\circ}\text{C}$ until use.

(*) *Homogenisation buffer:*

50 mM Tris-HCl pH 7,4; 1 % Protease inhibitor cocktail (Sigma): 12 ml Tris-HCl pH 7,4 + 120 μl Protease inhibitor cocktail (or equivalent protease inhibitor cocktails).

TRIS: TRIS-ULTRA PURE (ICN)

Protease inhibitor cocktail: From Sigma (for mammalian tissue) Product number **P 8340**.

Note: The homogenisation buffer should be used the same day as manufactured. Place on ice during use

▼ **M6***Appendix 6***Guidance for quantification of head & tail homogenate vitellogenin in zebrafish (*Danio rerio*) (modified from Holbech et al., 2001). other procedures using homologous antibodies and standards can be used**

1. Microtiter plates (certified Maxisorp F96, Nunc, Roskilde Denmark) previously coated with 5 µg/ml anti zebrafish lipovitellin-IgG are thawed and washed 3 times with washing buffer (*).
2. Purified zebrafish vitellogenin standard ⁽¹⁾ is serially diluted to 0,2, 0,5, 1, 2, 5, 10 and 20 ng/ml in dilution buffer (**) and samples are diluted at least 200 times (to prevent matrix effect) in dilution buffer and applied to the plates. An assay control is applied in duplicate. 150 µl are applied to each well. Standards are applied in duplicate and samples in triplicate. Incubate over night at 4 °C on a shaker.
3. The plates are washed 5 times with washing buffer (*)
4. HRP coupled to a dextran chain (e.g. AMDEX A/S, Denmark) and conjugated antibodies are diluted in washing buffer; Actual dilution differs by batch and age. 150 µl are applied to each well and the plates are incubated for 1 hour at room temperature on a shaker.
5. The plates are washed 5 times with washing buffer (*) and the bottom of the plates is carefully cleaned with ethanol.
6. 150 µl TMB plus (***) are applied to each well. Protect the plate against light with tinfoil, and watch the colour development on a shaker.
7. When the standard curve is fully developed the enzyme activity is stopped by adding 150 µl 0,2 M H₂SO₄ to each well.
8. The absorbance is measured at 450 nm (e.g. on a Molecular Devices Thermomax plate reader). Data are analysed on the associated software (e.g. Softmax).

(*) Washing buffer:

PBS-stock (****)	500,0	ml
BSA	5,0	g
Tween 20	5,0	ml

Adjust pH to 7,3 and fill to 5 l with millipore H₂O. Store at 4 °C.

(**) Dilution buffer:

PBS-Stock (****)	100,0	ml
BSA	3,0	g
Tween 20	1,0	ml

Adjust pH to 7,3 and fill to 1 l with millipore H₂O. Store at 4 °C.

(***) TMB plus is a 'ready-to-use' substrate produced by KemEnTec (Denmark). It is sensitive to light. Store at 4 °C.

⁽¹⁾ Battelle AP4.6.04 (1,18 mg/ml (AAA)), purified according to: Denslow, N.D., Chow, M.C., Kroll, K.J., Green, L. (1999). Vitellogenin as a biomarker of exposure for estrogen or estrogen mimics. *Ecotoxicology* 8: 385-398.

▼ M6

(****) PBS stock

NaCl	160,0	g
KH ₂ PO ₄	4,0	g
Na ₂ HPO ₄ · 2H ₂ O	26,6	g
KCl	4,0	g

Adjust pH to 6,8 and fill with millipore H₂O to 2 l. Store at room temperature.

▼M6*Appendix 7***Guidance for the preparation of tissue sections for sex determination and staging of gonads**

The purpose of this section is to describe the procedures that occur prior to the evaluation of histological sections. Other procedures that result in similar sex determination and gonadal staging can be used.

With a few exceptions, these procedures are similar for Japanese medaka (JMD) and zebrafish (ZF).

Euthanasia, Necropsy, and Tissue Fixation*Objectives:*

1. Provide for the humane sacrifice of fish.
2. Obtain necessary body weights and measurements.
3. Evaluate secondary sex characteristics.
4. Dissect tissues for VTG analysis.
5. Fixation of the gonads.

Procedures:

1. Fish should be sacrificed immediately prior to necropsy. Therefore, unless multiple prosectors are available, multiple fish should not be sacrificed simultaneously.
2. Using the small dip net, a fish is removed from the experimental chamber and transported to the necropsy area in the transport container.
3. The fish is placed in the euthanasia solution. The fish is removed from the solution when there is cessation of respiration and the fish is unresponsive to external stimuli.
4. The fish is wet weighed.
5. For preparation of tissues for VTG analysis, the fish can be placed on a corkboard on the stage of a dissecting microscope.
 - (a) For zebrafish the head is cut right behind the pectoral fin and tail is cut right behind the dorsal fin.
 - (b) For Japanese medaka the abdomen is opened via a carefully made incision that extends along the ventral midline from the pectoral girdle to a point just cranial to the anus. Using the small forceps and small scissors, the liver is carefully removed.
6. Specimen for VTG analysis are placed in eppendorf tubes and immediately frozen in liquid nitrogen.
7. The carcass including the gonads is placed into a pre-labelled plastic tissue cassette, which is transferred into Davidson's or Bouin's fixative. The volume of fixative should be at least 10 times the approximated volume of the tissues. The fixative container is gently agitated for five seconds to dislodge air bubbles from the cassette.
8. (a) All tissues remain in Davidson's fixative overnight, followed by transfer to individual containers of 10 % neutral buffered formalin the next day. Containers with cassettes are gently agitated for 5 seconds to ensure adequate penetration of formalin into cassettes.

▼ M6

- (b) Tissues remain in Bouins fixative for 24 h, followed by transfer to 70 % ethanol.

Tissue Processing*Objectives:*

1. Dehydrate tissue for adequate penetration of paraffin.
2. Impregnate the tissue with paraffin to maintain tissue integrity and create a firm surface for microtomy.

Procedures:

3. Labelled tissue cassettes are removed from formalin/ethanol storage and the cassettes are placed in the processing basket(s). The processing basket is loaded in the tissue processor.
4. The processing schedule is selected.
5. After the tissue processor has completed the processing cycle, the basket(s) may be transferred to the embedded station.

Embedding*Objective:*

Properly orient the specimen in solidified paraffin for microtomy.

Procedures:

1. The basket(s) of cassettes is/are removed from the processor and immersed in the paraffin-filled front chamber of the embedding station thermal console or the cassettes are moved to a separate paraffin heater.
2. The first cassette to be embedded is removed from the front chamber of the thermal console or the paraffin heater. The cassette lid is removed and discarded, and the cassette label is checked against the animal records to resolve potential discrepancies prior to embedding.
3. An appropriately sized embedding mould is selected.
4. The mould is held under the spout of the dispensing console and filled with molten paraffin.
5. The specimen is removed from the cassette and placed in the molten paraffin in the mould. This is repeated with 4-8 specimens for each paraffin mould. The position of individual fish is marked by putting fish no 1 in 180 degrees to fish 2-4/8.
6. Additional paraffin is added to cover the specimen.
7. The mould with the cassette base is placed on the cooling plate of the cryo console.
8. After the paraffin has solidified, the block (i.e., the hardened paraffin containing the tissues and the cassette base) is removed from the mould.

Microtomy*Objective:*

Cut and mount histological sections for staining.

Procedures:

1. The initial phase of microtomy termed 'facing' is conducted as follows:
 - (a) The paraffin block is placed in the chuck of the microtome.
 - (b) The chuck is advanced by rotating the microtome wheel and thick sections are cut from the paraffin surface of the block until the knife reaches the embedded tissues.

▼ M6

- (c) The section thickness on the microtome is set between 3 - 5 microns. The chuck is advanced and multiple sections are cut from the block to remove any artefacts created on the cut surface of the tissue during rough trimming.
 - (d) The block can be removed from the chuck and placed facedown on ice to soak the tissue.
2. The next phase of microtomy is final sectioning and mounting of tissue sections on slides. These procedures are conducted as follows:
- (a) If the block has been placed on ice, the block is removed from the ice and replaced in the chuck of the microtome.
 - (b) With the section thickness on the microtome set to 3 - 5 microns, the chuck is advanced by rotating the microtome wheel. Sections are cut from the block until a 'ribbon' containing at least one acceptable section including the gonads has been produced. (As necessary during sectioning, the block may be removed from the chuck, placed on ice to soak the tissue, and replaced in the chuck.)
 - (c) The sections are floated flat on the surface of the water in the water bath. An attempt is made to obtain at least one section that contains no wrinkles and has no air bubbles trapped beneath it.
 - (d) A microscope slide is immersed beneath the best section, which is lifted out of the water using the slide. This process is referred to as 'mounting' the section on the slide.
 - (e) Three sections are prepared for a set of fish. The second and third sections are taken at 50 micron intervals following the first section. If the fish are not embedded with their gonads in the same sectioning level, more sections are to be made to ensure that at least six sections including the gonads are obtained from each fish.
 - (f) With a slide-marking pen, the block number from which the slide was produced is recorded on the slide.
 - (g) The slide is placed in a staining rack.
 - (h) The block is removed from the chuck and placed facedown for storage.

Staining, Cover slipping, and Slide Labelling*Objectives:*

- Stain the sections for histopathological examination
- Permanently seal mounted and stained tissues.
- Permanently identify stained sections in a manner that allows complete traceability.

Procedures:

1. Staining

- (a) Slides are air-dried overnight before staining.
- (b) The sections are stained by Hematoxylin-Eosin.

2. Cover slipping

- (a) Cover slips can be applied manually or automatically.
- (b) A slide is dipped in xylene or TissueClear, and the excess xylene/TissueClear is gently knocked off the slide.

▼ **M6**

- (c) Approximately 0,1 ml of mounting medium is applied near the end of the slide opposite to the frosted end or on the cover slip.
- (d) The cover slip is tilted at a shallow angle as it is applied to the slide.

3. Labelling

- (a) Each slide label should contain the following information.
 - (i) Laboratory name
 - (ii) Species
 - (iii) Specimen No./Slide No.
 - (iv) Chemical/Treatment group
 - (v) Date

Statistical Flow Chart for vitellogenin analysis

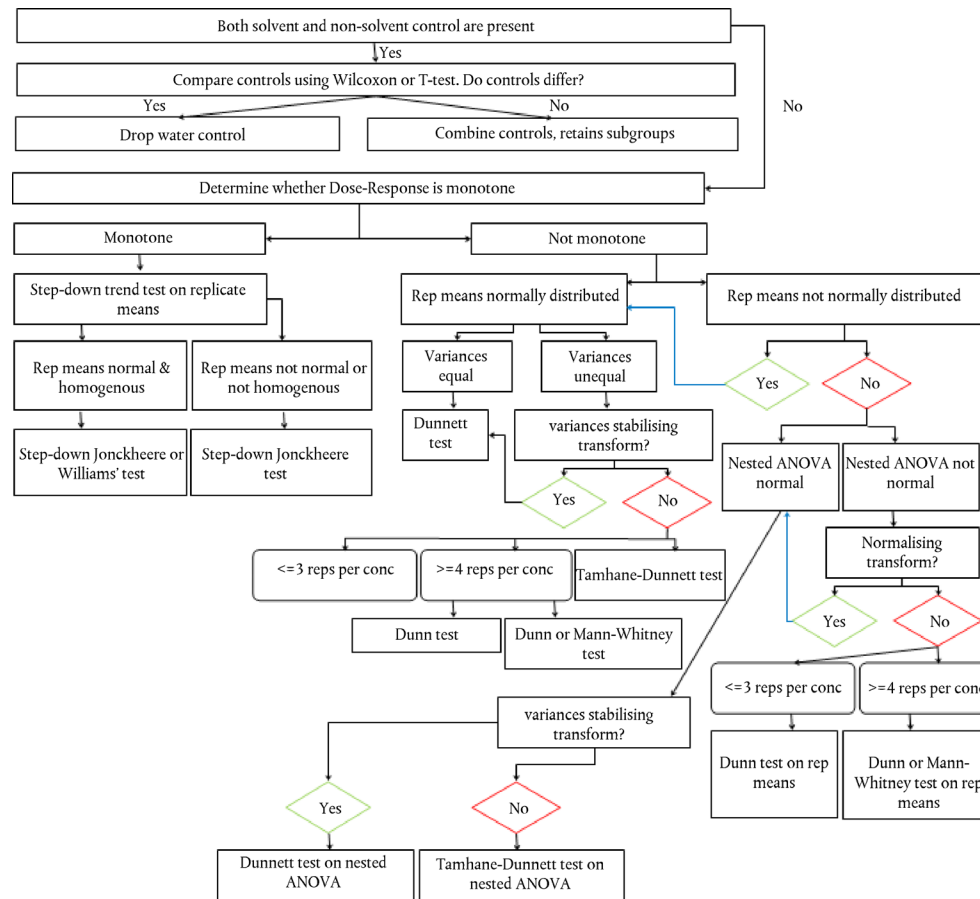

Statistical Flow Chart for sex ratio analysis

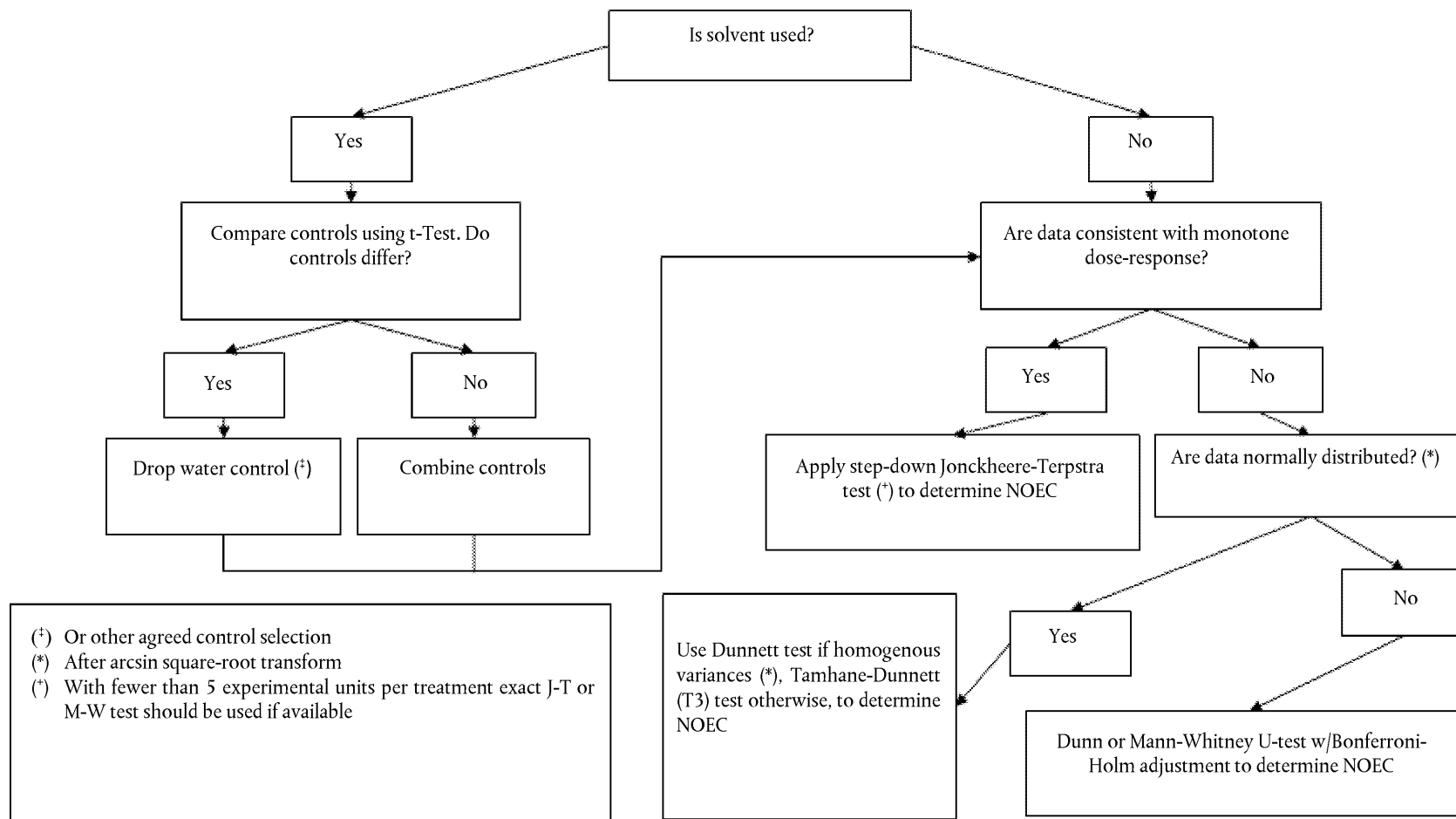

▼M6*Appendix 9***Guidance for tissue sampling for genetic sex determination and for genetic sex determination by PCR-method****Tissue sampling, preparation and storage before determination of genetic sex by PCR-method in medaka (Prepared by the Laboratory for Aquatic Organisms of Bayer CropScience AG)**

1. With fine scissors the anal or the dorsal fin will be cut off in each individual fish and placed into a tube filled with 100 µl of extraction-buffer 1 (details on buffer preparation see below). The scissors will be cleaned after each single fish in a beaker filled up with distilled H₂O and dried with a paper tissue.
2. Now the fin-tissues will be homogenised by a micro tube teflon pistil for the lysis of cells. For each tube a new pistil will be used to prevent any contaminations. The pistils will be placed overnight in 0,5 M NaOH, rinse for 5 minutes in distilled H₂O and stored in ethanol or sterile after autoclave until use.
3. It is also possible to store the fin tissue without any extraction-buffer 1 on dry-ice and then at – 80 °C refrigerator to prevent any degeneration of the DNA. But the extraction runs better, if you extract the DNA at the same time (handling see above; samples should be thawed on ice after storing at – 80 °C before the buffer will be filled in the tubes).
4. After homogenizing all tubes will be placed in a water bath and boiled for 15 minutes at 100 °C.
5. Then 100 µl of the extraction buffer 2 (details on buffer preparation see below) will be pipetted into each tube. The samples will be stored at room temperature for 15 minutes and in the meantime they will be sometimes gently shaken by hand.
6. Afterwards all tubes will be placed in the water bath again and boiled for another 15 minutes at 100 °C.
7. Until further analysis the tubes will be frozen at – 20 °C.

Buffer preparation

PCR-buffer 1:

500 mg N-Lauroylsarcosine (e.g. Merck KGaA, Darmstadt, GE)

2 ml 5M NaCl

ad 100 ml dest. H₂O

→ autoclave

PCR-buffer 2:

20 g Chelex (e.g. Biorad, Munich, GE)

To swell in 100 ml dest. H₂O

→ autoclave

Determination of genetic sex (by PCR-method) in medaka (Prepared by the Laboratory for Aquatic Organisms of Bayer CropScience AG and Universität Würzburg Biozentrum)

The prepared and frozen tubes (described in the above section) will be thawed on ice. After that, they will be centrifuged using an Eppendorf centrifuge (30 sec at max. speed, at room temperature). For the PCR, the clear supernatant separated from the precipitate will be used. It has absolutely to be avoided that any traces of Chelex (localized in the precipitate) are transferred to the PCR reaction, because this will interfere with the 'Taq'-polymerase activity. The supernatant will be used directly or can be stored frozen (at – 20 °C) and rethawed again in several cycles without negative impact on the DNA for later analyses.

▼ M61. *Preparation of the 'Reaction Mix' (25 µl per sample):*

	Volume	Final Concentration
Template DNA	0,5µl-2µl	
10xPCR-buffer with MgCl ₂	2,5µl	1x
Nucleotides (each of dATP, dCTP, dGTP, dTTP)	4µl (5mM)	200µM
Forward Primer (10µM) (see below 3-5)	0,5µl	200nM
Reverse Primer (10µM) (see below 3-5)	0,5µl	200nM
DMSO	1,25µl	5 %
Water (PCR grade)	up to 25µl	
Taq E- Polymerase	0,3µl	1,5U

10xPCR-buffer with MgCl₂: 670mM Tris/HCl (pH8,8 at 25 °C), 160mM (NH₄)₂SO₄, 25mM MgCl₂, 0,1 %Tween 20

For each PCR (see below 3-5) the special primer as a new combination of 'Reaction-Mix' and the adequate needed amount of template DNA for each sample (see above) is needed. The respective volumes will be transferred into new tubes using pipettes. After that all tubes will be closed, stirred (ca. 10 sec) and centrifuged (10 sec, at room temperature). Now the respective PCR-programmes can be started. Additionally a positive control (exemplary DNA sample with known activity and clear results) and a negative control (1 µl dest. H₂O) will be used in each PCR-programme.

2. *Preparation of the agarose gel (1 %) — During running PCR-programmes:*

- Solve 3 g agarose in 300 ml 1 × TAE-buffer (1 % agarose gel)
- This solution should be boiled using an microwave (ca. 2-3 min)
- Transfer the hot solution into a special casting box, which lies on ice
- After ca. 20 min the agarose gel is ready to use
- Storage the agarose gel in 1 × TAE-buffer until the end of the PCR-programmes

3. *Actin-PCR-programme:*

This PCR-reaction is aimed to demonstrate that the DNA in the sample is not harmed.

- Special primer:

'Mact1(upper/forward)' → TTC AAC AGC CCT GCC ATG TA

'Mact2(lower/reverse)' → GCA GCT CAT AGC TCT TCT CCA GGG
AG

- Programme:

5 min 95 °C

Cycle (35-times):

Denaturation → 45 sec at 95 °C

Annealing → 45 sec at 56 °C

Elongation → 1 min at 68 °C

15 min 68 °C

▼ M6**4. X- and Y-Gene-PCR-programme:**

The samples with intact DNA will be used in this PCR-programme to detect the X- and Y-Genes. Male DNA should show one double-band and female DNA should show one single band (after staining and gel-electrophoresis). For this programme-run one positive control for males (XY-sample) and one for females (XX-sample) should be included.

— Special primer:

'PG 17,5' (upper/forward) → CCG GGT GCC CAA GTG CTC CCG CTG

'PG 17,6' (lower/reverse) → GAT CGT CCC TCC ACA GAG AAG AGA

— Programme:

5 min 95 °C

Cycle (40-times):

Denaturation → 45 sec at 95 °C

Annealing → 45 sec at 55 °C

Elongation → 1 min 30 sec at 68 °C

15 min 68 °C

5. Y-Gene-PCR-programme as 'control' for X- and Y-Gene-PCR-programme:

This PCR-programme verifies the results of the 'X- and Y-Gene-PCR-programme'. The 'male-samples' should show one band and the 'female-samples' shouldn't show any band (after staining and gel-electrophoresis).

— Special primer:

'DMTYa (upper/forward)' → GGC CGG GTC CCC GGG TG

'DMTYd (lower/reverse)' → TTT GGG TGA ACT CAC ATG G

— Programme:

5 min 95 °C

Cycle (40-times):

Denaturation → 45 sec at 95 °C

Annealing → 45 sec at 56 °C

Elongation → 1 min at 68 °C

15 min 68 °C

6. Staining of the PCR-samples:

Staining solution:

50 % Glycerol

100 mM EDTA

1 % SDS

0,25 % Bromphenolblue

0,25 % Xylenecyanol

Pipette 1 µl of the staining solution into each single tube

7. Start of the Gel-Electrophoresis:

— The prepared 1 % agarose gel will be transferred into a gel-electrophoresis-chamber filled with 1 × TAE-Buffer

— 10 - 15 µl of each stained PCR-sample will be pipetted into an agarose gel slot

— Also 5 - 15 µl of the 1kb-'Ladder'(Invitrogen) will be pipetted into a separate slot

— Start the electrophoresis by 200 V

— Stop after 30-45 min

▼ **M6**

8. *Determination of the bands:*

- Clean the agarose gel in distilled H₂O
- Now transfer the agarose gel into Ethidium bromide for 15 - 30 min
- After that, a picture of the agarose gel should be taken in an UV-light-box
- Finally the samples are analysed in comparison to the positive control-band (or bands) and the ladder

▼ **M6***Appendix 10***Guidance on tissue sampling for genetic sex determination by PCR method in the three-spined stickleback****Tissue sampling and DNA extraction**

DNA can be extracted using a variety of commercially available reagents and both manual and automated extraction systems. The protocol used at the Cefas Weymouth laboratory is outlined below, and the alternative approaches have been added where appropriate.

1. With fine scissors, a small piece of tissue (10-20 mg) from the dorsolateral area (after removing the head and tail for VTG analysis), is removed from each individual fish. The tissue is added into a tube and either placed directly in liquid nitrogen (for storage at – 80 °C) or filled with 70 % ethanol (for transport and subsequent storage at 4 °C). The scissors are cleaned after each single fish in 70 % ethanol then in distilled water and dried with tissue paper.
2. The ethanol (if present) is removed by aspiration and the tissue is digested overnight with proteinase K in 400 µl of ATL buffer (Qiagen). An aliquot (200 µl) of the digest is transferred to a 96-well S-block (Qiagen) and the DNA extracted in a 96-well format using the Qiagen Universal BioRobot and the QIamp Investigator BioRobot kit. The DNA is eluted in a 50 µl of DNase and RNase free water. If using hard tissues to extract DNA (such as a spine or a pectoral fin) it may be necessary to homogenise the sample in the lysis buffer using a FastPrep® tissue lyser or equivalent tissue disruption system.

Alternatively,

- (a) the tissue is digested overnight with proteinase K in 400 µl of G2 lysis buffer (Qiagen) and DNA is extracted from 200 µl of the digest using either the EZ-1 DNA easy tissue kit and the EZ-1 biorobot or the DNA easy tissue mini kit. The DNA is eluted in a 50 µl volume.
- (b) The tissues are processed using the DNAzol reagent. Briefly, tissue samples are lysed in 1ml of DNAzol for 10 minutes in a 1,5 ml micro centrifuge tube and then centrifuged at 13 000 rpm for 5 minutes to remove any particulate matter. The lysed sample is then transferred to a new 1,5 ml micro centrifuge tube containing 500 µl of 100 % molecular grade ethanol and then centrifuged at 13 000 rpm for 10 minutes to precipitate the DNA. The ethanol is removed and replaced with 400 µl of 70 % molecular grade ethanol, centrifuged at 13 000 rpm for 5 minutes and the DNA pellet is dissolved in 50 µl molecular DNase and RNase free water. Again, when using the hard tissues (pectoral fin) it may be necessary to homogenise the sample in the lysis buffer using a FastPrep® tissue lyser or equivalent tissue disruption system prior to extracting the DNA.
3. The DNA is stored at – 20 °C until required.

Important note: gloves must be worn during the procedures.

Polymerase chain reaction (PCR) analysis

Amplifications were performed using 2,5 µl of the DNA extract in a 50 µl reaction volume using the Idh locus primers (as described by Peichel et al., 2004. Current Biology 1:1416-1424):

Forward primer 5' GGG ACG AGC AAG ATT TAT TGG 3'
 Reverse primer 5' TAT AGT TAG CCA GGA GAT GG 3'

▼M6

There are numerous suppliers of suitable PCR reagents. The method outlined below is that currently used at the Cefas Weymouth laboratory.

1. *Preparation of the 'Reaction Mix' (50 µl per sample):*

A mastermix is prepared as follows. This can be prepared in advance and stored frozen at – 20 °C until required. Make sufficient mastermix for a negative control (molecular biology grade water only).

	Volume (stock conc.)/ sample	Final Concentration
5xGoTaq® Reaction Buffer	10µl	1x
MgCl ₂	5 µl (25 mM)	2,5 mM
Nucleotides (dATP, dCTP, dGTP, dTTP)	0,5 µl (25 mM each)	250 µM each
Forward Primer	0,5µl (0,1 nmol/µl)	2,0 µM
Reverse Primer	0,5µl (0,1 nmol/µl)	2,0µM
Molecular biology grade water	30,75 µl	
GoTaq polymerase	0,25 µl	1,25U

- Dispense 47,5 µl to a labelled 0,5 ml thin walled PCR tube.
- Add 2,5 µl of the purified DNA to the appropriately labelled tube. Repeat for all samples and the negative control.
- Over lay with 2 drops of mineral oil. Alternatively, use a thermal cycler with a heated lid.
- Close the lids.
- Samples were denatured in a Peltier PTC-225 thermal cycler at 94 ± 2 °C for 5 minutes followed by 39 cycles of 94 ± 2 °C for 1 minute, 55 ± 2 °C for 1 minute, 72 ± 2 °C for 1 minute, and a final extension of 72 ± 2 °C for 10 minutes.

2. *Preparation of the agarose gel (2 %):*

Traditionally the PCR products are resolved on a 20 % agarose gel containing ethidium bromide.

Capillary based electrophoresis systems can also be used.

- Weigh 2 g agarose in 100 ml 1 × TAE-buffer
- Heat in a microwave (ca. 2-3 min) to dissolve the agarose.
- Add 2 drops of ethidium bromide final concentration 0,5 µg/ml
- Transfer the hot solution into the gel casting equipment.
- Allow the gel to harden

3. *Gel-Electrophoresis:*

- Transferred the agarose gel to the electrophoresis equipment and submerge in 1 × TAE-buffer
- Load 20 µl of each sample to a separate well, adding a molecular weight marker (100 bp DNA ladder, Promega) to a spare well.
- Electrophoresis is performed at 120 V for 30-45 minutes.

▼M64. *Visualisation of the amplification products*

If the ethidium bromide was incorporated in to the agarose gel as described above, the DNA products are visualised under a UV source. Alternatively the agarose gel is stained by covering the gel in a dilute solution of ethidium bromide (0,5 µg/ml in water) for 30 minutes prior to visualisation.

▼ **M6***Appendix 11***Guidance for artificial fertilisation procedure for the three-spined stickleback**

The purpose of this section is to describe the procedures to obtain fertilised eggs from the three-spined stickleback in view of using them in the FSDT.

Procedures*Obtaining sperm from the males*

1. A well-coloured male of the desired population is euthanised.
2. The testes are dissected from each side of the fish. *The testes are generally heavily pigmented, rod shaped structures that are readily apparent at the lateral midline of the body.* Use either of the following methods:
3. Using a pair of fine scissors, begin at the cloaca and make a 1-1,5 cm incision with a single snip angled at about 45 degrees.
4. Use a scalpel to make a small incision in the side of the fish slightly posterior to the pelvis and just ventral of the lateral plates.
5. The testes are removed using fine forceps and placed into a petri dish.
6. Each testis is covered with 100 µl freshly made **Hank's final solution** ⁽¹⁾.
7. The testes are finely diced by using a razor blade or scalpel. This will release sperm and give the Hank's solution a milky appearance.
8. The fluid containing sperm is added into a tube, while trying not to include any pieces of testes tissue when pipetting.
9. 800 µl of Hank's final solution are added into the tube and mixed well.
10. If required, the male can be preserved by fixing in 100 % ethanol or other desired fixative. This is particularly important if the study is assigning parental origin of offsprings.

Important note: *Although most of the stock solutions required can be made in advance, stock 5 and subsequently the final solution, should be made up fresh on the day of use.*

Stock 1

NaCl	8,00 g
KCl	0,40 g
Distilled water (DW)	100 ml

Stock 2

Na ₂ HPO ₄ (anhydrous)	0,358 g
KH ₂ PO ₄	0,60 g
DW	100 ml

Stock 3

CaCl ₂	0,72 g
DW	50 ml

⁽¹⁾ Hank's Buffered Salt Solution (HBSS):

HBSS is needed to preserve the sperm whilst preparing for fertilisation.

▼ M6**Stock 4**

MgSO ₄ ·7H ₂ O	1,23 g
DW	50 ml

Stock 5 (freshly prepared)

NaHCO ₃	0,35 g
DW	10 ml

Note: If you already have some of the above salts but with different water content (i.e. 2H₂O instead of anhydrous) you can still use it but first adjust weight based on molecular weight).

For Hank's final solution combine in the following order:

stock 1	1,0 ml
stock 2	0,1 ml
stock 3	0,1 ml
DW	8,6 ml
stock 4	0,1 ml
stock 5	0,1 ml

Mix well before use.

Fertilisation

1. Large, gravid females are identified from the desired population; females are ready for squeezing only when you can see eggs protruding from the cloaca. Ready females have the characteristic 'head up' posture.
2. Gently run a finger or thumb down the side of the fish towards the tail to encourage the expulsion of an egg sack into a fresh petri dish. Repeat on the other side and return the fish to its tank.
3. The eggs can be spread out (forming a monolayer) using a fine paintbrush. It is important to try and expose as many eggs as possible to the sperm so maximising the surface area of the eggs is helpful. Important note: Keep the eggs humid by laying damp tissue around them (it is important the eggs do not touch water directly as this can prematurely harden the chorion preventing fertilisation). There is a large variation in the number of eggs each female can produce but as an average, about 150 eggs should be easily obtained from a single gravid female.
4. 25µl of sperm in Hank's mixture is spread evenly over the whole surface of the eggs using the paintbrush. The eggs will quickly harden and change colour (within a minute) once fertilisation has begun. If the estimated number of eggs is more than 150, repeat the procedure. Similarly if the eggs don't harden within a minute add a bit more sperm. Important note: Adding more sperm does not necessarily improve fertilisation rate.
5. The eggs and the sperm solution should be left to 'interact' for at least 15 minutes and the fertilised eggs should be placed into the exposure aquaria within 1,5 hours post fertilisation.
6. The procedure is repeated using another female until the desired number of eggs is collected.
7. Spare few eggs from the last batch and fix them in 10 % acetic acid.

▼M6**Counting and distributing eggs in test aquaria**

1. Eggs should be evenly distributed between each treatment level to avoid genetic bias. Each batch of fertilised eggs should be separated into equal size groups (as many as the treatment levels) by the use of a blunt instrument (i.e. wide-blade entomology forceps or use of an inoculation loop). If you aim for 4 replicates per treatment, with 20 eggs each then you need to distribute 80 eggs per exposure aquaria. Important note: It is advisable to add an extra 20 % (i.e. 96 eggs per treatment level) until you are confident that you obtain 100 % fertilisation rates.
2. Stickleback eggs are very prone to fungal infections outside the father-guarded nest. In this respect, treatment of all eggs with methylene blue during the first 5 days of the test is critically important. A stock solution of methylene blue is prepared at 1 mg/ml and added to the exposure aquaria to give a maximum final concentration of 2,125 mg/l. Important note: Sticklebacks should not be exposed to methylene blue once hatched so the system should be free of methylene blue by day 6.
3. The eggs are inspected daily and any dead or unfertilised eggs are recorded as such. Important note: The eggs should never be outside water until they hatch even for very brief periods.

▼M6**C.42. BIODEGRADABILITY IN SEAWATER**

GENERAL INTRODUCTION

1. This test method is equivalent to OECD Test Guideline (TG) 306 (1992). When the original test methods were developed, it was not known to what extent results from the screening tests for ready biodegradability using freshwater, and sewage effluent or activated sludge as inoculum, could be applied to the marine environment. Variable results on this point have been reported (e.g. (1)).
2. Many industrial waste waters, containing a variety of chemicals, reach the sea either by direct discharge or via estuaries and rivers in which the residence times are low compared with the period necessary for complete biodegradation of many of the chemicals present. Because of the growing awareness of the need to protect the marine environment against increasing loads of chemicals and the need to estimate the probable concentration of chemicals in the sea, test methods for biodegradability in seawater have been developed.
3. The methods described here use natural seawater both as the aqueous phase and as the source of micro-organisms. In an endeavour to conform with the methods for ready biodegradability in freshwater, the use of ultra-filtered and centrifuged seawater was investigated, as was the use of marine sediments as inocula. These investigations were unsuccessful. The test medium therefore is natural seawater pre-treated to remove coarse particles.
4. In order to assess ultimate biodegradability with the Shake Flask Method, relatively high concentrations of the test substance have to be used because of the poor sensitivity of the dissolved organic carbon (DOC) analytical method. This in turn necessitates the addition to the seawater of mineral nutrients (N and P), the low concentrations of which would otherwise limit the removal of DOC. It is also necessary to add the nutrients in the Closed Bottle Method because of the concentration of the added test substance.
5. Hence, the methods are not tests for ready biodegradability since no inoculum is added in addition to the micro-organisms already present in the seawater. Neither do the tests simulate the marine environment since nutrients are added and the concentration of test substance is very much higher than would be present in the sea. For these reasons the methods are proposed under a new subsection 'Biodegradability in Seawater'.

APPLICATION

6. The results of the tests, which would be applied because the pattern of use and disposal of the substance in question indicated a route to the sea, give a first impression of biodegradability in seawater. If the result is positive (> 70 % DOC removal; > 60 % ThOD — theoretical oxygen demand), it may be concluded that there is a potential for biodegradation in the marine environment. However, a negative result does not preclude such a potential but indicates that further study is necessary, for example, using as low a concentration of the test substance as possible.

▼M6

7. In either case, if a more definitive value for the rate or degree of biodegradation in seawater at a particular site is required, other more complex and sophisticated, and hence more costly, methods would have to be applied. For example, a simulation test could be applied using a concentration of test substance nearer to the likely environmental concentration. Also, non-fortified, non-pre-treated seawater taken from the location of interest could be used and primary biodegradation could be followed by specific chemical analysis. For ultimate biodegradability, ^{14}C -labelled substances would be necessary in order that the rates of the disappearance of soluble organic ^{14}C and the production of $^{14}\text{CO}_2$ at environmentally realistic concentrations could be measured.

CHOICE OF METHODS

8. The selection of which method to use depends on a number of factors; the following Table is given to help the selection. While substances of water solubility below the equivalent of about 5 mg C/l cannot be tested in the Shake Flask Method, at least, in principle, poorly soluble substances may be tested in the Closed Bottle Method.

*Table***Advantages and disadvantages of the shake flask and closed bottle test**

METHOD	ADVANTAGES	DISADVANTAGES
SHAKE FLASK	<ul style="list-style-type: none"> — simple apparatus except C analyser — 60 d duration is not a problem — no interference from nitrification — can be adapted for volatile substances 	<ul style="list-style-type: none"> — needs C analyser — uses 5-40 mg DOC/l, could be inhibitory — DOC determination is difficult at low concentrations in seawater (chloride effect) — DOC sometimes high in seawater
CLOSED BOTTLE	<ul style="list-style-type: none"> — simple apparatus — simple end determination — uses low concentration of test substance (2 mg/l) thus less chance of inhibition — easily adapted for volatile substances 	<ul style="list-style-type: none"> — could be difficult to maintain air-tightness of bottles — wall growth of bacteria can lead to false values — blank O_2 uptake values can be high especially after 28 days; could be overcome by ageing the seawater — possible interference from O_2 uptake by nitrification

SHAKE FLASK METHOD**INTRODUCTION**

1. This method is a seawater variant of the Modified OECD Screening Test described in Chapter C.4B of this Annex (2). It was finalised as a result of a ring test organized for the European Commission (EC) by the Danish Water Quality Institute (3).
2. In common with the accompanying marine Closed Bottle Method, the results from this test are not to be taken as indicators of ready biodegradability, but are to be used specifically for obtaining information about the biodegradability of substances in marine environments.

▼M6

PRINCIPLE OF THE METHOD

3. A pre-determined amount of the test substance is dissolved in the test medium to yield a concentration of 5-40 mg dissolved organic carbon (DOC)/l. If the limits of sensitivity of organic carbon analyses are improved, the use of lower concentrations of test substance may be advantageous, particularly for inhibitory substances. The solution of the test substance in the test medium is incubated under agitation in the dark or in diffuse light under aerobic conditions at a fixed temperature (controlled to ± 2 °C) which will normally be within the range 15-20 °C. In cases where the objective of the study is to simulate environmental situations, tests may be carried out beyond this normal temperature range. The recommended maximum test duration is about 60 days. Degradation is followed by DOC measurements (ultimate degradation) and, in some cases, by specific analysis (primary degradation).

INFORMATION ON THE TEST SUBSTANCE

4. In order to know whether the test may be applied to a particular substance, some of its properties must be known. The organic carbon content of the substance must be established, its volatility must be such that significant losses do not occur during the course of the test and its solubility in water should be greater than the equivalent of 25-40 mg C/l. Also, the test substance should not significantly adsorb onto glass surfaces. Information on the purity or the relative proportions of major components of the test substance is required in order that the results obtained can be interpreted, especially when the result lies close to the 'pass' level.
5. Information on the toxicity of the test substance to bacteria, for example as measured in short-term respiration rate tests (4), may be useful when selecting appropriate test concentrations and may be essential for the correct interpretation of low biodegradation values. However, such information is not always sufficient for interpreting results obtained in the biodegradation test and the procedure described in paragraph 18 is more suitable.

REFERENCE SUBSTANCES

6. Suitable reference substances must be used to check the microbial activity of the seawater sample. Sodium benzoate, sodium acetate and aniline are examples of substances which may be used for this purpose. The reference substances must be degraded within a reasonably short time span, otherwise it is recommended that the test be repeated using another seawater sample.
7. In the EC ring test where seawater samples were taken at different locations and at different times of the year (3), the lag phase (t_L) and time to achieve 50 per cent degradation (t_{50}), excluding the lag phase, were 1 to 4 days and 1 to 7 days respectively for sodium benzoate. For aniline the t_L ranged from 0 to 10 days, whilst the t_{50} ranged from 1 to 10 days.

REPRODUCIBILITY AND SENSITIVITY OF THE METHOD

8. The reproducibility of the method was established in the ring test (3). The lowest concentration of test substance, for which this method can be used with DOC analysis, is largely determined by the detection limit of the organic carbon analysis (about 0,5 mg C/l, at present) and the concentration of dissolved organic carbon in the seawater used (usually of the order of 3-5 mg/l for water from the open sea). The background concentration of DOC should not exceed about 20 % of the total DOC concentration after addition of test substance. If this is not feasible, the background concentration of DOC may sometimes be reduced by ageing the seawater prior to testing.

▼ M6

If the method is used with specific chemical analysis only (by which primary degradation is measured), the investigator must document, by supplying additional information, whether ultimate degradability can be expected. This additional information may consist of the results from other tests for ready or inherent biodegradability.

DESCRIPTION OF THE METHOD**Apparatus**

9. Normal laboratory apparatus and:
 - a. Shaking machine accommodating 0,5-2 litre Erlenmeyer flasks, either with automatic temperature control or used in a constant temperature room at 15-20 °C controlled to ± 2 °C;
 - b. Narrow neck, 0,5-2 litre Erlenmeyer flasks;
 - c. Membrane filtration apparatus, or centrifuge;
 - d. Membrane filters, 0,2-0,45 μm ;
 - e. Carbon analyser;
 - f. Equipment for specific analysis (optional).

Seawater

10. Collect a sample of seawater in a thoroughly cleansed container and transport to the laboratory, preferably within one or two days of collection. During transport, do not allow the temperature of the sample to exceed significantly the temperature to be used in the test. Identify the sampling location precisely and describe it in terms of its pollutional and nutrient status. Especially for coastal waters, include in this characterization a heterotrophic microbial colony count and the determination of the concentrations of dissolved nitrate, ammonium and phosphate.
11. Provide the following information for the seawater sample itself:
 - date of collection;
 - depth of collection;
 - appearance of sample — turbid, etc.;
 - temperature at the time of collection;
 - salinity;
 - DOC;
 - delay between collection and use in the test.
12. If the DOC content of the seawater sample is found to be high (paragraph 8), it is recommended that the seawater be aged for about a week prior

▼ M6

to use. Age by storing under aerobic conditions at the test temperature and in the dark or in diffuse light. If necessary, maintain aerobic conditions by gentle aeration. During ageing, the content of easily degradable organic material is reduced. In the ring test (3), no difference was revealed between the degradation potential of aged and freshly collected seawater samples. Prior to use, pre-treat the seawater to remove coarse particles, e.g. by filtration through a nylon filter or coarse paper filter (not membrane or GF-C filters), or by sedimentation and decanting. The procedure used must be reported. Carry out pre-treatment after ageing, if used.

Stock solutions for mineral nutrients

13. Prepare the following stock solutions, using analytical grade reagents:

- | | |
|--|---------|
| (a) Potassium dihydrogen orthophosphate, KH_2PO_4 | 8,50 g |
| Dipotassium hydrogen orthophosphate, K_2HPO_4 | 21,75 g |
| Disodium hydrogen orthophosphate dihydrate,
$\text{Na}_2\text{HPO}_4 \cdot 2\text{H}_2\text{O}$ | 33,30 g |
| Ammonium chloride, NH_4Cl | 0,50 g |
| Dissolve and make up to 1 litre with distilled water. | |
| (b) Calcium chloride, CaCl_2 | 27,50 g |
| Dissolve and make up to 1 litre with distilled water. | |
| (c) Magnesium sulphate heptahydrate, $\text{MgSO}_4 \cdot 7\text{H}_2\text{O}$ | 22,50 g |
| Dissolve and make up to 1 litre with distilled water. | |
| (d) Iron (III) chloride hexahydrate, $\text{FeCl}_3 \cdot 6\text{H}_2\text{O}$ | 0,25 g |
| Dissolve and make up to 1 litre with distilled water. | |

Precipitation in solution (d) may be prevented by adding one drop of concentrated HCl or 0,4 g ethylenediaminetetra-acetic acid (EDTA, disodium salt) per litre. If a precipitate forms in a stock solution, replace it with freshly made solution.

Preparation of test medium

14. Add 1 ml of each of the above stock solutions per litre of pre-treated seawater.

Inoculum

15. Do not add a specific inoculum in addition to the micro-organisms already present in the seawater. Determine (optionally) the number of colony-forming heterotrophs in the seawater test medium (and preferably also in the original seawater samples) e.g. by plate count, using marine agar. This is particularly desirable for samples from coastal or polluted sites. Check the heterotrophic microbial activity in the seawater by performing a test with a reference substance.

▼ M6**Preparation of flasks**

16. Ensure that all glassware is scrupulously clean, not necessarily sterile, (e.g. using alcoholic hydrochloric acid), rinsed and dried before use in order to avoid contamination with residues from previous tests. The flasks must also be cleaned before first use.
17. Evaluate test substances in duplicate flasks simultaneously, together with a single flask for the reference substance. Carry out a blank test, in duplicate, with neither test nor reference substance for the determination of analytical blanks. Dissolve the test substances in the test medium — they may be conveniently added via a concentrated stock solution — to give the desired starting concentrations of normally 5-40 mg DOC/l. Test the reference substance normally at a starting concentration corresponding to 20 mg DOC/l. If stock solutions of test and/or reference substances are used, ensure that the salinity of the seawater medium is not greatly altered.
18. If toxic effects can be expected or cannot be ruled out, it may be advisable to include an inhibition experiment, in duplicate, in the test design. Add the test and reference substances to the same vessel, the concentration of the reference substance being normally the same as in the control test (i.e. 20 mg DOC/l) in order to allow comparison.
19. Dispense adequate amounts of test solutions into the Erlenmeyer flasks (up to about half the flask volume is a convenient amount) and subsequently provide each flask with a loose cover (e.g. aluminium foil) that makes gas exchange between the flask and the surrounding air possible. (Cotton wool plugs are unsuitable if DOC analysis is used). Place the vessels on the shaker and shake continuously at a gentle rate (e.g. 100 rpm) throughout the test. Control the temperature (15-20 °C and within ± 2 °C), and shield the vessels from light in order to avoid growth of algae. Ensure that the air is free of toxic materials.

Physical-chemical control test (optional)

20. If abiotic degradation or loss mechanisms are suspected, such as hydrolysis (a problem with specific analysis only), volatilization, or adsorption, it is advisable to perform a physical-chemical control experiment. This can be done by adding mercury (II) chloride (HgCl_2)⁽¹⁾ (50-100 mg/l) to vessels with test substance in order to stop microbial activity. A significant decrease in DOC or specific substance concentration in the physical-chemical control test indicates abiotic removal mechanisms. (If mercury chloride is used, attention should be paid to interferences or catalyst poisoning in DOC analysis.)

Number of flasks

21. In a typical run, the following flasks are used:

Flasks 1 & 2 — containing test substance (test suspension);

Flasks 3 & 4 — containing seawater only (blank);

Flask 5 — containing reference substance (procedure control);

Flask 6 — containing test and reference substance (toxicity control)
— optional;

Flask 7 — containing test substance and sterilising agent (abiotic sterile control)-optional.

⁽¹⁾ Mercury (II) chloride (HgCl_2) is a very toxic substance which should be handled with suitable precautions. Aqueous wastes containing this chemical should be disposed of appropriately; they should not be discharged into the waste water system.

▼ M6**DOC analysis**

22. In the course of the test, withdraw samples at suitable intervals for DOC analysis (Appendix 1). Always take samples at the start of the test (day 0) and at day 60. A minimum of five samples in total are required to describe the time-course of degradation. No fixed time schedule for sampling can be stated as the rate of biodegradation varies. Carry out the DOC determination in duplicate on each sample.

Sampling

23. The required volume of the samples depends upon the analytical method (specific analysis), on the carbon analyser used, and on the procedure (membrane filtration or centrifugation) selected for sample treatment before carbon determination (paragraphs 25 and 26). Before sampling ensure that the test medium is mixed well and that any material adhering to the wall of the flask is dissolved or suspended.
24. Membrane-filter or centrifuge immediately after sampling. If necessary, store the filtered or centrifuged samples at 2-4 °C for up to 48 hours or below – 18 °C for longer periods (if it is known that the substance will remain unaffected, acidify to pH 2 before storing).
25. Membrane filters (0,2-0,45 µm) are suitable if it is ensured that they neither release carbon nor adsorb the substance in the filtration step e.g. polycarbonate membrane filters. Some membrane filters are impregnated with surfactants for hydrophilization and may release considerable quantities of dissolved carbon. Prepare such filters by boiling in deionised water for three consecutive periods, each of one hour. After boiling, store the filters in deionised water. Discard the first 20 ml of the filtrate.
26. Centrifugation of the samples may be chosen as an alternative to membrane filtration. Centrifuge at $40\,000\text{ m}\cdot\text{s}^{-2}$ (~ 4 000 g) for 15 minutes, preferably in a refrigerated centrifuge.

Note: The differentiation of Total Organic Carbon (TOC) over DOC (TOC/DOC) by centrifugation at very low concentrations does not seem to work, since either not all bacteria are removed, or carbon as part of the bacterial plasma is redissolved. At higher test concentrations (> 10 mg C per litre), the centrifugation error seems to be comparatively small.

Frequency of sampling

27. If analyses are performed immediately after sampling, assess the next sampling time by considering the result of the analytical determination.
28. If samples are preserved (paragraph 24) for analysis at a later time, take more samples than the required minimum number of five. Analyse the last samples first, and by a step-wise 'backwards' selection of appropriate samples for analysis, it is possible to obtain a good description of the biodegradation curve with a relatively small number of analytical determinations. If no degradation has taken place by the end of the test, no further samples need to be analysed, and in this situation, the 'backwards' strategy may save considerable analytical costs.

▼ M6

29. If a plateau on the degradation curve is observed before the 60th day, end the test. If degradation has obviously started by day 60, but has not reached a plateau, extend the experiment for a further period.

DATA AND REPORTING**Treatment of results**

30. Record the analytical results on the attached data sheet (Appendix 2), and calculate the biodegradation values for both test and reference substances from the equation:

$$D_t = \left[1 - \frac{C_t - C_{bl(t)}}{C_0 - C_{bl(0)}} \right] \times 100$$

where:

D_t = degradation in percentage DOC or specific substance removal at time t ,

C_0 = starting concentration of DOC or specific substance in the test medium,

C_t = concentration of DOC or specific substance in the test medium at time t ,

$C_{bl(0)}$ = starting concentration of DOC or specific substance in the blank,

$C_{bl(t)}$ = concentration of DOC or specific substance in the blank at time t .

31. State degradation as the percentage DOC removal (ultimate degradation) or specific substance removal (primary degradation) at time t . Calculate the DOC concentrations to the nearest 0,1 mg per litre, and round up the means of the D_t values to the nearest whole per cent.
32. Illustrate the course of the degradation graphically in a diagram as shown in the figure in 'Validity and interpretation of results'. If there are sufficient data, calculate from the curve the lag phase (t_L) and the time to reach 50 per cent removal from the end of the lag phase (t_{50}).

Test report

33. The test report must contain the following information:

Test substance:

- physical nature and, where relevant, physicochemical properties;
- identification data.

Test conditions:

- location and description of the sampling site; pollutional and nutrient status (colony count, nitrate, ammonium, phosphate if appropriate);
- characteristics of the sample (date of sampling, depth, appearance, temperature, salinity, DOC (optional), delay between collection and use in the test;

▼M6

- method used (if any) for ageing of the seawater;
- method used for pre-treatment (filtration/sedimentation) of the seawater;
- method used for DOC determination;
- method used for specific analysis (optional);
- method used for determining the number of heterotrophs in the seawater (plate count method or alternative procedure) (optional);
- other methods (optional) used to characterise the seawater (ATP measurements, etc.).

Results:

- analytical data reported on a data sheet (Appendix 2);
- the course of the degradation test is represented graphically in a diagram showing the lag phase (t_L), slope, and time (starting from the end of the lag phase) to reach 50 per cent removal (t_{50}). The lag phase may be estimated graphically as shown in the figure in the 'Validity and interpretation of results' section or conveniently taken as the time needed for 10 per cent degradation;
- percentage degradation measured after 60 days, or at end of test.

*Discussion of results.***Validity and interpretation of results**

34. The results obtained with the reference substances e.g. sodium benzoate, sodium acetate or aniline, should be comparable to results obtained in the ring test (3) (refer to section on 'Reference substances', paragraph 7). If results obtained with reference substances are atypical, the test should be repeated using another seawater sample. Although results of inhibition tests may not always be straightforward to interpret because of the contribution of DOC by the test substance, a significant reduction of the total DOC removal rate, compared with that of the control, is a positive sign of toxic effects.
35. Owing to the relatively high test concentrations used as compared with most natural systems (and consequently an unfavourable ratio between the concentrations of test substances and other carbon sources), the method is to be regarded as a preliminary test which can be used to indicate whether or not a substance is easily biodegradable. Accordingly a low result does not necessarily mean that the test substance is not biodegradable in marine environments, but indicates that more work will be necessary in order for this to be established.

An example of a theoretical degradation experiment illustrating a feasible way of estimating the values of t_L (length of 'lag phase') and t_{50} (time interval, starting at t_L), needed to reach 50 per cent removal, is given in the figure below.

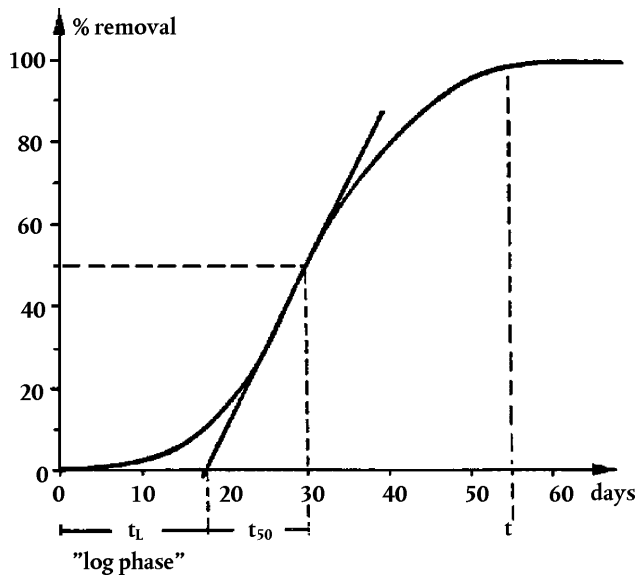
▼ **M6****CLOSED BOTTLE METHOD**

INTRODUCTION

1. This method is a seawater variant of the Closed Bottle Test (5) and was finalised as a result of a ring test organised for the European Commission (EC) by the Danish Water Quality Institute (3).
2. In common with the accompanying marine Shake Flask Method, results of this test are not to be taken as indications of ready biodegradability, but are to be used specifically for obtaining information about the biodegradability of substances in marine environments.

PRINCIPLE OF THE METHOD

3. A pre-determined amount of the test substance is dissolved in the test medium in a concentration of usually 2-10 mg of test substance per litre (one or more concentrations may be used). The solution is kept in a filled closed bottle in the dark in a constant temperature bath or enclosure controlled to ± 1 °C within a range of 15-20 °C. In those cases where the objective of the study is to simulate environmental situations, tests may be carried out beyond this normal temperature range providing suitable adjustments are made for temperature control. The degradation is followed by oxygen analyses over a 28-day period.
4. The ring test showed that if the test was extended beyond 28 days no useful information could be gathered, in most cases, due to severe interferences. The blank biological oxygen demand (BOD) values were excessively high probably due to wall growth, caused by lack of agitation, and to nitrification. Thus, the recommended duration is 28 days, but if the blank BOD value remains within the 30 per cent limit (paragraphs 15 and 40) the test could be prolonged.

INFORMATION ON THE TEST SUBSTANCE

5. In order to know whether the test may be applied to a particular substance, some of its properties must be known. The empirical formula is required so that the theoretical oxygen demand (ThOD) may be calculated (see Appendix 3); otherwise the chemical oxygen demand (COD) of the substance must be determined to serve as the reference value. The use of COD is less satisfactory since some substances are not fully oxidised in the COD test.

▼ M6

6. The solubility of the substance should be at least 2 mg/l, though in principle less soluble substances could be tested (e.g. using ultra sonication) as could volatile substances. Information on the purity or the relative proportions of major components of the test substance is required in order that the results obtained can be interpreted, especially when the result lies close to the 'pass' level.
7. Information on the toxicity of the substance to bacteria e.g. as measured in short-term respiration tests (4) may be very useful when selecting appropriate test concentrations and may be essential for the correct interpretation of low biodegradation values. However, such information is not always sufficient for interpreting results obtained in the biodegradation test and the procedure described in paragraph 27 is more suitable.

REFERENCE SUBSTANCES

8. Suitable reference substances must be used to check the microbial activity of the seawater sample. Aniline, sodium acetate or sodium benzoate (for example) may be used for this purpose. A degradation of these substances of at least 60 per cent (of their ThOD) must occur within a reasonably short time span, otherwise it is recommended that the test be repeated using another seawater sample.
9. In the EC ring-test where seawater samples were taken at different locations and at different times of the year, the lag phase (t_L) and the time to achieve 50 per cent degradation (t_{50}), not including the lag phase, were 0 to 2 days and 1 to 4 days respectively for sodium benzoate. For aniline the t_L and t_{50} values were 0 to 7 and 2 to 12 days respectively.

REPRODUCIBILITY

10. The reproducibility of the methods was established in the EC ring test (3).

DESCRIPTION OF THE METHOD

Apparatus

11. Normal laboratory equipment and:
 - (a) 250-300 ml BOD bottles with glass stoppers or narrow neck 250 ml bottle with glass stoppers may be used;
 - (b) Several 2-, 3- and 4- litre bottles with litre marks for the preparation of the experiment and for the filling of the BOD bottles;
 - (c) Waterbath or constant temperature room for keeping the bottles at constant temperature (± 1 °C) with the exclusion of light.
 - (d) Equipment for analysis of dissolved oxygen;
 - (e) Membrane filters, 0,2-0,45 μm (optional);
 - (f) Equipment for specific analysis (optional).

Seawater

12. Collect a seawater sample in a thoroughly cleansed container and transport to the laboratory, preferably within one or two days of collection. During transport do not allow the temperature of the sample to exceed significantly the temperature to be used in the test.

▼ M6

13. Identify the sampling location precisely and describe it in terms of its pollutional and nutritional status. Especially for coastal or polluted waters, include in this characterisation a heterotrophic microbial colony count and the determination of concentrations of dissolved nitrate, ammonium and phosphate.
14. Provide the following information for the seawater sample itself:
- date of collection;
 - depth of collection;
 - appearance of sample — turbid etc.;
 - temperature at the time of collection;
 - salinity;
 - dissolved organic carbon (DOC);
 - delay between collection and use in the test.
15. If the DOC content of the sample is found to be high or if it is thought that the blank BOD after 28 days would be more than 30 per cent of that of the reference substances, it is recommended that the seawater be aged for about a week prior to use.
16. Age the sample by storing it under aerobic conditions at the test temperature and in the dark or in diffuse light. If necessary, maintain aerobic conditions by gentle aeration. During ageing, the content of easily degradable organic material is reduced. In the ring-test (3), no difference was revealed between the degradation potential of aged and freshly collected seawater samples.
17. Prior to use, pretreat the seawater to remove coarse particles e.g. by filtration through a nylon filter or a coarse paper filter (not membrane or GF-C filters), or by sedimentation and decanting. Report the procedure used. Pretreat after ageing, if used.

Stock solutions for mineral nutrients

18. Prepare the following stock solutions using analytical grade reagents:
- | | |
|--|---------|
| (a) Potassium dihydrogen orthophosphate, KH_2PO_4 | 8,50 g |
| Dipotassium hydrogen orthophosphate, K_2HPO_4 | 21,75 g |
| Disodium hydrogen orthophosphate dihydrate,
$\text{Na}_2\text{HPO}_4 \cdot 2\text{H}_2\text{O}$ | 33,30 g |
| Ammonium chloride, NH_4Cl | 0,50 g |
| Dissolve and make up to 1 litre with distilled water. | |
| (b) Calcium chloride, CaCl_2 | 27,50 g |
| Dissolve and make up to 1 litre with distilled water. | |
| (c) Magnesium sulphate heptahydrate, $\text{MgSO}_4 \cdot 7\text{H}_2\text{O}$ | 22,50 g |
| Dissolve and make up to 1 litre with distilled water. | |
| (d) Iron (III) chloride hexahydrate, $\text{FeCl}_3 \cdot 6\text{H}_2\text{O}$ | 0,25 g |
| Dissolve and make up to 1 litre with distilled water. | |

▼ M6

Precipitation in solution (d) may be prevented by adding one drop of concentrated HCl or 0,4 g ethylenediaminetetra-acetic acid (EDTA, disodium salt) per litre. If a precipitate forms in a stock solution, replace it with freshly made solution.

Preparation of test medium

19. Add per litre of pre-treated seawater 1 ml of each of the above stock solutions. Saturate the test medium with air at the test temperature by aerating with clean compressed air for about 20 minutes. Determine the concentration of dissolved oxygen for control purposes. The saturated concentration of dissolved oxygen as a function of salinity and temperature may be read from the nomogram enclosed with this test method (Appendix 4).

Inoculum

20. Do not add a specific inoculum in addition to the micro-organisms already present in the seawater. Determine (optionally) the number of colony-forming heterotrophs in the seawater test medium (and preferably also in the original seawater sample), e.g. by plate count using a marine agar. This is particularly desirable for samples from coastal or polluted sites. Check the heterotrophic microbial activity in the seawater by performing a test with a reference substance.

Preparation of test bottles

21. Perform all necessary manipulations including ageing and pre-treatment of the seawater at the chosen test temperature between 15 to 20 °C, ensuring cleanliness, but not sterility of all glassware.
22. Prepare groups of BOD bottles for the determination of the BOD of the test and reference substances in simultaneous experimental series. Perform all analyses on duplicate bottles (blanks, reference and test substances), i.e. prepare two bottles for each determination. Perform analyses at least on days 0, 5, 15 and 28 (four determinations). For oxygen analyses, four determinations require a total of $3 \times 2 \times 4 = 24$ bottles (blank, reference and test substance), and thus about 8 litres of test medium (for one concentration of test substance).
23. Prepare separate solutions of test and reference substances in large bottles of sufficient volume (paragraph 11) by first adding test and reference substances either directly or by using a concentrated stock solution to the partly filled large bottles. Add further test medium to give the final desired concentrations. If stock solutions of test and/or reference substances are used, ensure that the salinity of the seawater medium is not significantly altered.
24. Select concentrations of test and reference substances by taking into account:
 - (a) the solubility of dissolved oxygen in seawater at the prevailing test temperature and salinity (see the enclosed nomogram — Appendix 4);
 - (b) the blank BOD of the seawater; and
 - (c) the expected biodegradability of the test substance.

▼ M6

25. At 15 °C and 20 °C and 32 parts per thousand salinity (ocean water), the solubility of dissolved oxygen is about 8,1 and 7,4 mg/l respectively. The oxygen consumption of the seawater itself (blank respiration) may be 2 mg O₂/l or more, if the seawater is not aged. Therefore in order to ensure a significant oxygen concentration remaining after oxidation of the test substance, use a starting concentration of test substance of about 2-3 mg/l (depending on the ThOD) for the substances that are expected to become completely degraded under the conditions of the test (such as reference substances). Test less degradable substances at higher concentrations, up to about 10 mg/l, provided that toxic effects do not occur. It can be advantageous to run parallel tests with a low (about 2 mg/l) and a high (about 10 mg/l) concentration of test substance.
26. An oxygen blank must be determined in parallel in bottles containing neither test or reference substance.
27. If inhibitory effects are to be determined, prepare the following series of solutions in separate large bottles (paragraph 13):
- (a) 2 mg per litre of an easily-degradable substance, e.g. any of the reference substances mentioned;
 - (b) x mg per litre of test substance (x is usually 2);
 - (c) 2 mg per litre of the easily-degradable substance plus x mg per litre of test substance.

Physical-chemical control test (optional)

28. If the option of using specific analyses is used, a physical-chemical experiment may be performed in order to check whether the test substance is removed by abiotic mechanisms, such as hydrolysis or adsorption. A physical-chemical control test may be performed by adding mercury (II) chloride (HgCl₂)⁽¹⁾ (50-100 mg/l) to duplicate flasks with test substance in order to stop microbial activity. A significant decrease in specific substance concentration in the course of the test indicates abiotic removal mechanisms.

Number of BOD bottles in a typical run

29. In a typical run the following bottles are used:
- at least 8 containing test substance;
 - at least 8 containing nutrient-fortified seawater only;
 - at least 8 containing reference substance, and when necessary
 - 6 bottles containing test and reference substances (toxicity control).

PROCEDURE

30. After preparation, immediately siphon each solution, from the lower quarter (not from the bottom) of the appropriate large bottle, to fill the respective group of BOD bottles. Immediately analyse the zero controls (time zero) for dissolved oxygen (paragraph 33) or preserve them for later chemical analysis by precipitation with MnCl₂ (manganese (II) chloride) and NaOH (sodium hydroxide).

⁽¹⁾ Mercury (II) chloride (HgCl₂) is a very toxic substance which should be handled with suitable precautions. Aqueous wastes containing this chemical should be disposed of appropriately; they should not be discharged directly into the waste water system.

▼ M6

31. Incubate the remaining parallel BOD bottles at the test temperature (15-20 °C), keep in the dark, and remove from the incubation area at appropriate time intervals, (e.g. after 5, 15 and 28 days as a minimum) and analyse for dissolved oxygen (paragraph 33).
32. Membrane filter (0,2-0,45 µm) or centrifuge, for 15 minutes, samples for specific analyses (optional). Store for up to 48 hours at 2-4 °C, or for longer periods at – 18 °C, if not analysed immediately (if it is known that the test substance will remain unaffected, acidify to pH 2 before storing).

Dissolved oxygen determination

33. Determine the concentration of dissolved oxygen using a chemical or electrochemical method which is recognised nationally or internationally.

DATA AND REPORTING

Treatment of Results

34. Record analytical results on the attached data sheets (Appendix 5).
35. Calculate the BOD as the difference of the oxygen depletion between a blank and a solution of test substance under the conditions of the test. Divide the net oxygen depletion by the concentration (w/v) of the substance in order to express the BOD as mg BOD/mg test substance. The degradation is defined as the ratio of the biochemical oxygen demand to either, preferably, the theoretical oxygen demand (ThOD) or the chemical oxygen demand (COD) and expressed as a percentage (see paragraph 36).
36. Calculate the biodegradation values for each sampling time for both test and reference substances using one or other of the equations:

$$\% \text{ biodegradation} = \frac{\text{mg } O_2 / \text{mg tested substance}}{\text{mg ThOD} / \text{mg tested substance}} \times 100$$

$$\% \text{ biodegradation} = \frac{\text{mg } O_2 / \text{mg tested substance}}{\text{mg COD} / \text{mg tested substance}} \times 100$$

where:

ThOD = theoretical oxygen demand (calculation, Appendix 3)

COD = chemical oxygen demand, determined experimentally.

Note: Sometimes the two ways of calculation (percentage of the ThOD or percentage of the COD) do not give the same results; it is preferable to use ThOD, since some substances are not fully oxidised in the COD test.

37. Illustrate the course of the degradation test graphically in a diagram (see example in section on 'Validity and interpretation of results'. If there are sufficient data, calculate the lag phase (t_L) and the time (t_{50}) to reach 50 per cent removal from the end of the lag phase from the biodegradation curve.
38. If specific analysis is used (optional), state the percentage of primary degradation as the percentage of specific substance removal within the test period (corrected for analytical blanks).

▼ M6**Test Report**

39. The test report must contain the following information:

Test substance:

- physical nature and, where relevant, physicochemical properties;
- identification data.

Test conditions:

- location and description of the sampling site: pollutional and nutrient status (colony count, nitrate, ammonium, phosphate if appropriate);
- characteristics of the sample (date of sampling, depth, appearance, temperature, salinity, DOC (optional), delay between collection and use in the test);
- method used (if any) for ageing of the seawater;
- method used for pre-treatment (filtration/sedimentation) of the seawater;
- method used for the COD determination (if performed);
- method used for the oxygen measurements;
- dispersion procedure for substances which are poorly soluble under the test conditions;
- method used for determining the number of heterotrophs in the seawater (plate count method or alternative procedure);
- method used for determining DOC in seawater (optional);
- method used for specific analysis (optional);
- other optional methods used to characterise the seawater (ATP measurements, etc.).

Results:

- analytical data reported on a data sheet (as attached, Appendix 5);
- the course of the degradation test represented graphically in a diagram showing the lag phase, (t_L), slope and time (starting from the end of the lag phase) to reach 50 per cent of the final oxygen uptake caused by oxidation of the test substance (t_{50}). The lag phase may be estimated graphically as shown in the attached figure, or conveniently taken as the time needed for 10 per cent degradation;
- per cent degradation measured after 28 days.

*Discussion of results.***Validity and interpretation of results**

40. The blank respiration should not exceed 30 per cent of the oxygen in the test bottle. If it is not possible to meet this criterion using freshly collected seawater, the seawater must be aged (stabilized) before use.
41. The possibility that nitrogen-containing substances may affect the results should be considered.

▼ **M6**

42. Results obtained with the reference substances sodium benzoate and aniline should be comparable to the results obtained in the ring-test (3) (paragraph 9). If results obtained with reference substances are atypical, the test should be repeated using another seawater sample.
43. The test substance can be considered to be inhibitory to bacteria (at the concentration used) if the BOD of the mixture of reference and test substances is less than the sum of the BOD of the separate solutions of the two substances.
44. Owing to the relatively high test concentrations as compared with most natural systems, and consequently an unfavourable ratio between the concentrations of test substance and other carbon sources, the method is to be regarded as a preliminary test which can be used to indicate whether or not a substance is easily biodegradable. Accordingly, a low result does not necessarily mean that the test substance is not biodegradable in marine environments, but indicates that more work will be necessary in order for this to be established.

An example of a theoretical degradation experiment illustrating a feasible way of estimating the values of t_L (length of 'lag phase') and t_{50} , time interval (starting at t_L), needed to reach 50 % of the final oxygen uptake caused by oxidation of the test substance, is given below:

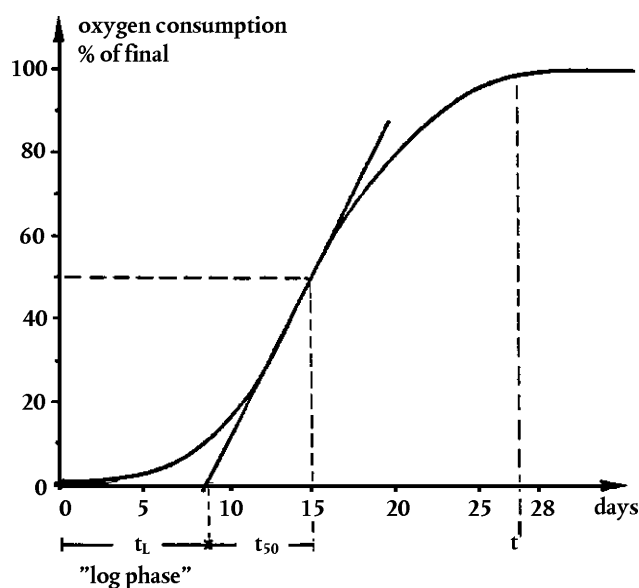

LITERATURE

- (1) de Kreuk J.F. and Hanstveit A.O. (1981). Determination of the biodegradability of the organic fraction of chemical wastes. *Chemosphere*, 10 (6); 561-573.
- (2) Chapter C.4-B of this Annex: Determination of 'Ready' Biodegradability Part III Modified OECD Screening Test
- (3) Nyholm N. and Kristensen P. (1987). Screening Test Methods for Assessment of Biodegradability of Chemical Substances in Seawater. Final Report of the ring test programme 1984-1985, March 1987, Commission of the European Communities.
- (4) Chapter C.11 of this Annex: Biodegradation — Activated Sludge, Respiration Inhibition Test.
- (5) Chapter C.4-E of this Annex: Determination of 'Ready' Biodegradability, Part VI. Closed Bottle Test.

▼ M6*Appendix 1***Determination of organic carbon in seawater****SHAKE FLASK METHOD**

For the determination of organic carbon of a water sample, the organic compounds in the sample are oxidized to carbon dioxide using generally one of the following three techniques:

- wet-oxidation by persulphate/UV-irradiation;
- wet-oxidation by persulfate/elevated temperature (116-130 °C);
- combustion.

Evolved CO₂ is quantified employing infra-red spectrometry or titrimetry. Alternatively, CO₂ is reduced to methane, which is quantified on a flame ionization detector (FID).

The persulfate/UV-method is commonly used for the analysis of 'clean' water with low content of particulate matter. The latter two methods can be applied to most kinds of water samples, the persulfate/elevated temperature-oxidation being most suitable for low-level samples, and the combustion technique being applicable for samples with non-volatile organic carbon (NVOC) content well above 1 mg C/l.

Interferences

All three methods are dependent on eliminating or compensating for inorganic carbon (IC) present in the sample. Purging of CO₂ from the acidified sample is the most frequently used method to eliminate the IC, although this also results in a loss of volatile organic compounds (1). The complete elimination or compensation of IC must be ensured for each sample matrix, and volatile organic carbon (VOC) must be determined in addition to NVOC dependent on the sample type.

High chloride concentrations result in decreased oxidation efficiency using the persulfate/UV-method (2). Application of an oxidation reagent modified by the addition of mercury (II) nitrate may, however, remove this interference. It is recommended that the maximum tolerable sample volume be used to evaluate each type of chloride-containing sample. High salt concentrations in sample analysed using the combustion method can cause salt coating of the catalyst and excessive corrosion of the combustion tube. Precautions should be taken according to the manufacturer's manual.

Highly turbid samples as well as samples containing particulate matter may be incompletely oxidized when employing the persulfate/UV-method.

An example of a suitable method

Non-volatile organic carbon is determined by oxidation with persulfate/UV-irradiation and subsequent quantification of evolved CO₂ employing non-dispersive infra-red spectrometry.

The oxidation reagent is modified in accordance with the suggestions given in (2) as described in the manufacturer's manual:

- a) 8,2 g HgCl₂ and 9,6 g Hg(NO₃)₂·H₂O are dissolved in several hundred millilitres of low carbon concentration reagent water.
- b) 20 g K₂S₂O₈ are dissolved in the mercuric salt solution.

▼M6

- c) 5 ml HNO₃ (conc.) are added to the mixture.
- d) the reagent is diluted to 1 000 ml.

The interference from chloride is removed using a 40 µl sample volume for 10 per cent chloride and 200 µl sample volume for 1,9 per cent chloride. Samples of high chloride concentrations and/or larger sample volumes can be analysed according to this method provided that build-up of chloride in the oxidation vessel is prevented. Determination of volatile organic carbon can subsequently be performed, if relevant, for the sample type in question.

LITERATURE

- (1) ISO, Water quality — determination of total organic carbon. Draft International Standard ISO/DIS 8245, January 16, 1986.
- (2) American Public Health Association, Standard Methods for the Estimation of Water and Wastewater. American Water Works Association & Water Pollution Control Federation, 16th edition, 1985.

Also of interest (gives a description of an autoanalysis system):

- (3) Schreurs W. (1978). An automated colorimetric method for the determination of dissolved organic carbon in seawater by UV destruction. Hydrobiological Bulletin 12, 137-142.

▼ **M6***Appendix 2***Biodegradation in seawater**

SHAKE FLASK METHOD

DATA SHEET

1. **LABORATORY:**2. **DATE AT START OF TEST:**3. **TEST SUBSTANCE:**

Name:

Stock solution concentration: mg/l as substance

Initial concentration in medium, t_0 : mg/l as substance

: mg DOC/l

4. **SEAWATER:**

Source:

Date of collection:

Depth of collection:

Appearance at time of collection (e.g. turbid, etc.):

Salinity at collection: ‰

Temperature at collection: °C

DOC 'x' hours after collection: mg/l

Pretreatment prior to testing (e.g. filtration, sedimentation, ageing, etc.):

Microbial colony count — original sample: colonies/ml

— at start of test: colonies/ml

Other characteristics:

5. **CARBON DETERMINATIONS:**

Carbon analyser:

	Flask no.		DOC after n days (mg/l)				
			0	n_1	n_2	n_3	n_x
Test: nutrient-fortified seawater with test substance	1	a_1					
		a_2					
		mean, $C_{a(t)}$					
	2	b_1					
		b_2					
		mean, $C_{b(t)}$					

▼ **M6**

	Flask no.		DOC after n days (mg/l)				
			0	n ₁	n ₂	n ₃	n _x
Blank: nutrient-fortified seawater without test substance	1	c ₁					
		c ₂					
		mean, C _{c(t)}					
	2	d ₁					
		d ₂					
		mean, C _{d(t)}					
	mean, $C_{bl(t)} = \frac{C_{c(t)} + C_{d(t)}}{2}$						

6. EVALUATION OF RAW DATA:

Flask No.	Calculation of results	% Degradation after n days				
		0	n ₁	n ₂	n ₃	n _x
1	$D_1 = 1 - \frac{C_{a(t)} - C_{bl(t)}}{C_0 - C_{bl(0)}} \times 100$	0				
2	$D_2 = 1 - \frac{C_{b(t)} - C_{bl(t)}}{C_0 - C_{bl(0)}} \times 100$	0				
Mean (*)	$D_t = \frac{D_1 + D_2}{2}$	0				

(*) D₁ and D₂ should not be averaged if there is a considerable difference.

Note: Similar formats may be used when degradation is followed by specific analysis and for the reference substance and toxicity controls.

7. ABIOTIC DEGRADATION (optional)

	Time (days)	
	0	t
DOC conc. (mg/l) in sterile control	C _{s(0)}	C _{s(t)}

$$\% \text{ abiotic degradation} = \frac{C_{s(0)} - C_{s(t)}}{C_{s(0)}} \times 100$$

▼ **M6***Appendix 3***Calculation of the theoretical biochemical oxygen demand**

CLOSED BOTTLE METHOD

The ThOD of the substance $C_cH_hCl_{cl}N_nNa_{na}O_oP_pS_s$ of the molecular weight MW is calculated according to:

$$ThOD_{NH_3} = \frac{16 \left[2c + \frac{1}{2}(h - cl - 3n) + 3s + \frac{5}{2p} + \frac{1}{2na} - o \right]}{MW}$$

This calculation implies that C is mineralised to CO_2 , H to H_2O , P to P_2O_5 and Na to Na_2O . Halogen is eliminated as hydrogen halide and nitrogen as ammonia.

Example:

Glucose $C_6H_{12}O_6$, MW = 180

$$ThOD = \frac{16 \left(2 \times 6 + \frac{1}{2} \times 12 - 6 \right)}{180} = 1,07 \text{ mg } O_2/\text{mgglucose}$$

Molecular weights of salts other than those of the alkali metals are calculated on the assumption that the salts have been hydrolysed.

Sulphur is assumed to be oxidised to the state of + 6.

Example:

Sodium n-dodecylbenzenesulphonate $C_{18}H_{29}SO_3Na$, MW = 348

$$ThOD = \frac{16 \left(36 + \frac{29}{2} + 3 + \frac{1}{2} - 3 \right)}{348} = 2,34 \text{ mg } O_2/\text{mgsubstance}$$

In the case of nitrogen-containing substances the nitrogen may be eliminated as ammonia, nitrite, or nitrate corresponding to different theoretical biochemical oxygen demands.

$$ThOD_{NO_2} = \frac{16 \left[2c + \frac{1}{2}(h - cl) + 3s + \frac{3}{2n} + \frac{5}{2p} + \frac{1}{2na} - o \right]}{MW}$$

$$ThOD_{NO_3} = \frac{16 \left[2c + \frac{1}{2}(h - cl) + 3s + \frac{5}{2n} + \frac{5}{2p} + \frac{1}{2na} - o \right]}{MW}$$

Suppose full nitrate formation had been observed by analysis in the case of a secondary amine:

$(C_{12}H_{25})_2NH$, MW = 353

$$ThOD_{NO_3} = \frac{16 \left(48 + \frac{51}{2} + \frac{5}{2} \right)}{353} = 3,44 \text{ mg } O_2/\text{mgsubstance}$$

▼ M6

Appendix 4

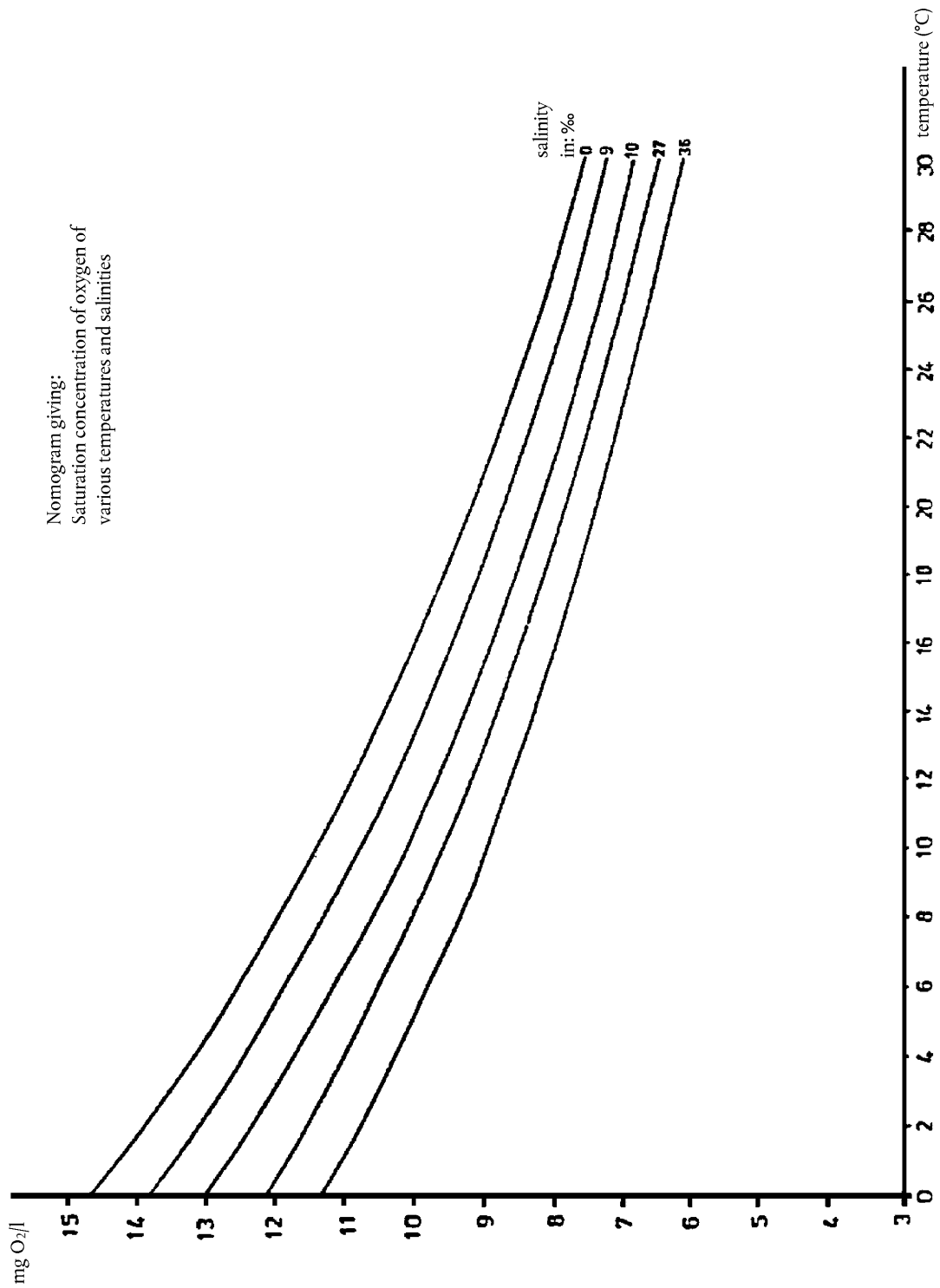

▼ **M6***Appendix 5***Biodegradation in seawater**

CLOSED BOTTLE METHOD

DATA SHEET

1. **LABORATORY:**
2. **DATE AT START OF TEST:**
3. **TEST SUBSTANCE:**

Name:

Stock solution concentration: mg/l
 Initial conc. in seawater medium: mg/l
 ThOD or COD: mg O₂/mg test substance

4. **SEAWATER:**

Source:

Date of collection:

Depth of collection:

Appearance at time of collection (e.g. turbid, etc.):

Salinity at collection: ‰
 Temperature at collection: °C
 DOC 'x' hours after collection: mg/l

Pre-treatment prior to testing (e.g. filtration, sedimentation, ageing, etc.):

Microbial colony count — original sample: colonies/ml
 — at start of test: colonies/ml

Other characteristics:

5. **TEST MEDIUM:**

Temperature after aeration: °C
 O₂ concentration after aeration and standing before start of test: mg O₂/l

6. **DO DETERMINATION:**

Method: Winkler/electrode

	Flask no.		mg O ₂ /l after n days			
			0	5	15	28
Test: nutrient — fortified seawater with test substance	1	a ₁				
	2	a ₂				
	Mean test	$m_t = \frac{a_1 + a_2}{2}$				

▼ **M6**

	Flask no.		mg O ₂ /l after n days			
			0	5	15	28
Blank: nutrient — fortified seawater, but without test substance	1	c ₁				
	2	c ₂				
	Mean blank	$m_b = \frac{c_1 + c_2}{2}$				

Note: Similar format may be used for reference substance and toxicity controls.

7. **DO DEPLETION: % DEGRADATION (%D):**

	DO depletion after n days		
	5	15	28
$(m_b - m_t)$ ⁽¹⁾			
$\%D = \frac{(m_b - m_t)^{(1)}}{\text{test substance}(mg/l) \times ThOD} \times 100$			

- (1) This assumes that $m_{b(0)} = m_{t(0)}$, where
 $m_{b(0)}$ = blank value at day 0,
 $m_{t(0)}$ = test substance value at day 0.
 If $m_{b(0)}$ does not equal $m_{t(0)}$, use $(m_{t(0)} - m_{t(x)}) - (m_{b(0)} - m_{b(x)})$, where
 $m_{b(x)}$ = blank value at day x,
 $m_{t(x)}$ = test substance value at day x.

▼ M6**C.43. ANAEROBIC BIODEGRADABILITY OF ORGANIC SUBSTANCES
IN DIGESTED SLUDGE: BY MEASUREMENT OF GAS
PRODUCTION**

INTRODUCTION

1. This test method is equivalent to OECD Test Guideline (TG) 311 (2006). There are a number of screening tests for assessing aerobic biodegradability of organic substances (Test methods C.4, C.9, C.10, and C.11 (1) and OECD TG 302C (2)) and the results of applying these have been successfully used to predict the fate of substances in the aerobic environment, particularly in the aerobic stages of waste water treatment. Various proportions of water-insoluble substances, as well as of those which adsorb on to sewage solids, are also dealt with aerobically, since they are present in settled sewage. However, the larger fractions of these substances are bound to the primary settled sludge, which is separated from raw sewage in settlement tanks before the settled, or supernatant, sewage is treated aerobically. The sludge, containing some of the soluble substances in the interstitial liquid, is then passed to heated digesters for anaerobic treatment. As yet there are no tests in this series for assessing anaerobic biodegradability in anaerobic digesters and this test is targeted to fill this gap; it is not necessarily applicable to other anoxic environmental compartments.
2. Respirometric techniques that measure the amounts of gas produced, mainly methane (CH₄) and carbon dioxide (CO₂), under anaerobic conditions have been used successfully for assessing anaerobic biodegradability. Birch et al (3) reviewed these procedures and concluded that the work of Shelton and Tiedje (4), based on earlier studies (5)(6)(7), was the most comprehensive. The method (4), which was further developed by others (8) and has become the American standards (9)(10), did not resolve problems related to the differing solubilities of CO₂ and CH₄ in the test medium and to the calculation of the theoretical gas production of a test substance. The ECETOC report (3) recommended the additional measurement of the dissolved inorganic carbon (DIC) content of the supernatant liquid, which made the technique more widely applicable. The ECETOC method was subjected to an international calibration exercise (or ring test) and became the ISO Standard, ISO 11734 (11).
3. This test method, which is based on ISO 11734 (11), describes a screening method for the evaluation of potential anaerobic biodegradability of organic substances under a specific condition (i.e. in an anaerobic digester at a given time and range of concentration of micro-organisms). Because a diluted sludge is used with a relatively high concentration of test substance and the duration of the test typically is longer than the retention time in anaerobic digesters, the conditions of the test do not necessarily correspond to the conditions in anaerobic digesters, nor is it applicable for the assessment of anaerobic biodegradability of organic substances under different environmental conditions. Sludge is exposed to the test substance for up to 60 days, which is longer than the normal sludge retention time (25 to 30 days) in anaerobic digesters, though at industrial sites retention times may be much longer. Predictions from the results of this test cannot be made as convincingly as they can be made in the case of aerobic biodegradation, since the evidence accrued on the behaviour of test substances in 'ready' aerobic tests and in simulation tests and the aerobic environment is sufficient to be confident that there is a connection; little similar evidence exists for the anaerobic environment. Complete anaerobic biodegradation can be assumed to occur if 75 %-80 % of theoretical gas production is achieved. The high ratios of substance to biomass used in these tests mean that a substance which passes is more likely to be degraded in an anaerobic digester. Additionally, substances which fail to be converted to gas in the test may

▼ M6

not necessarily persist at more environmentally realistic substance-to-biomass ratios. Also, other anaerobic reactions occur by which substances may be at least partially degraded, e.g. by dechlorination, but this test does not detect such reactions. However, by applying specific analytical methods for determining the test substance, its disappearance may be monitored (see paragraphs 6, 30, 44 and 53).

PRINCIPLE OF THE TEST

4. Washed digested sludge ⁽¹⁾, containing low (< 10 mg/l) concentrations of inorganic carbon (IC), is diluted about ten-fold to a total solids concentration of 1 g/l to 3 g/l and incubated at 35 °C ± 2 °C in sealed vessels with the test substance at 20 to 100 mg C/l for up to 60 days. Allowance is made for measuring the activity of the sludge by running parallel blank controls with sludge inoculum in the medium but without test substance.

5. The increase in headspace pressure in the vessels resulting from the production of carbon dioxide and methane is measured. Much of the CO₂ produced will be dissolved in the liquid phase or transformed into carbonate or hydrogen carbonate under the conditions of the test. This inorganic carbon is measured at the end of the test.

6. The amount of carbon (inorganic plus methane) resulting from the biodegradation of the test substance is calculated from the net gas production and net IC formation in the liquid phase in excess of blank control values. The extent of biodegradation is calculated from total IC and methane-C produced as a percentage of the measured or calculated amount of carbon added as test substance. The course of biodegradation can be followed by taking intermediate measurements of gas production only. Additionally the primary biodegradation can be determined by specific analyses at the beginning and end of the test.

INFORMATION ON THE TEST SUBSTANCE

7. The purity, water solubility, volatility and adsorption characteristics of the test substance should be known to enable correct interpretation of results to be made. The organic carbon content (% w/w) of the test substance needs to be known either from its chemical structure or by measurement. For volatile test substances, a measured or calculated Henry's law constant is helpful in deciding whether the test is applicable. Information on the toxicity of the test substance for anaerobic bacteria is useful in selecting an appropriate test concentration, and for interpreting results showing poor biodegradability. It is recommended to include the inhibition control unless it is known that the test substance is not inhibitory to anaerobic microbial activities (see paragraph 21 and ISO 13641-1 (12)).

⁽¹⁾ Digested sludge is a mixture of the settled phases of sewage and activated sludge, which have been incubated in an anaerobic digester at about 35 °C to reduce biomass and odour problems and to improve the dewaterability of the sludge. It consists of an association of anaerobic fermentative and methanogenic bacteria producing carbon dioxide and methane (11).

▼M6

APPLICABILITY OF THE TEST METHOD

8. The test method may be applied to water-soluble substances; it may also be applied to poorly soluble and insoluble substances, provided that a method of exact dosing is used e.g. see ISO 10634 (13). In general, a case by case decision is necessary for volatile substances. Special steps may have to be taken, for example, not releasing gas during the test.

REFERENCE SUBSTANCES

9. To check the procedure, a reference substance is tested by setting up appropriate vessels in parallel as part of normal test runs. Phenol, sodium benzoate and polyethylene glycol 400 are examples and would be expected to be degraded by more than 60 % theoretical gas production (i.e. methane and inorganic carbon) within 60 days (3)(14).

REPRODUCIBILITY OF TEST RESULTS

10. In an international ring test (14) there was good reproducibility in gas pressure measurements between triplicate vessels. The relative standard deviation (coefficient of variation, COV) was mainly below 20 %, although this value often increased to > 20 % in the presence of toxic substances or towards the end of the 60-d incubation period. Higher deviations were also found in vessels of volume < 150 ml. Final pH values of the test media were in the range 6,5-7,0.
11. The following results were obtained in the ring test.

Test substance	Total data n ₁	Mean degradation (of total data) (%)	Relative Standard deviation (of total data) (%)	Valid data n ₂	Mean degradation (of valid data) (%)	Relative Standard deviation (of valid data) (%)	Data > 60 % degradation in valid tests n ₃
Palmitic acid	36	68,7 ± 30,7	45	27	72,2 ± 18,8	26	19 = 70 % (*)
Poly-ethylene Glycol 400	38	79,8 ± 28,0	35	29	77,7 ± 17,8	23	24 = 83 % (*)

(*) Proportion of n₂

12. The coefficients of variation of the mean for all values obtained with palmitic acid and polyethylene glycol 400 were as high as 45 % (n = 36) and 35 % (n = 38) respectively. When values of < 40 % and > 100 % were omitted (the former being assumed to be due to sub-optimal conditions, the latter due to unknown reasons), the COVs were reduced to 26 % and 23 %, respectively. The proportions of 'valid' values attaining at least 60 % degradation were 70 % for palmitic acid and 83 % for polyethylene glycol 400. The proportions of the percentage biodegradation derived from DIC measurements were relatively low but variable. For palmitic acid the range was 0-35 %, mean 12 %, with COV of 92 % and for polyethyleneglycol 400 0-40 %, mean 24 %, with COV of 54 %.

DESCRIPTION OF THE TEST METHOD

Apparatus

13. Usual laboratory equipment and the following are required:

(a) Incubator — spark-proof and controlled at 35 °C ± 2 °C;

▼ M6

- (b) Pressure-resistant glass test vessels of an appropriate nominal size⁽¹⁾, each fitted with a gas-tight septum, capable of withstanding about 2 bar. The headspace volume should be about 10 % to 30 % of the total volume. If biogas is released regularly, about 10 % headspace volume is appropriate, but if the gas release is made only at the end of the test 30 % is appropriate. Glass serum bottles, of nominal volume 125 ml, total volume around 160 ml, sealed with serum septa⁽²⁾ and crimped aluminium rings are recommended when the pressure is released at each sampling time;
- (c) Pressure-measuring device⁽³⁾ adapted to enable measurement and venting of the gas produced, for example, a hand-held precision pressure meter connected to a suitable syringe needle; a 3-way gas-tight valve facilitates the release of excess pressure (Appendix 1). It is necessary to keep the internal volume of the pressure transducer tubing and valve as low as possible, so that errors introduced by neglecting the volume of the equipment are insignificant;

Note — The pressure readings are used directly to calculate the amount of carbon produced in the headspace (paragraphs 42 to 44). Alternatively, the pressure readings may be converted to volumes (at 35 °C, atmospheric pressure) of gas produced using a conversion graph. This graph is constructed from data obtained by injecting known volumes of nitrogen gas into a series of test vessels (e.g. serum bottles) at 35° +/- 2 °C and recording the resulting stabilised pressure readings (See Appendix 2). The calculation is shown in the Note in paragraph 44.

Warning — Take care to avoid needle-stick injuries when using micro-syringes.

- (d) Carbon analyser, suitable for the direct determination of inorganic carbon in the range of 1 mg/l to 200 mg/l;
- (e) Syringes of high precision for gaseous and liquid samples;
- (f) Magnetic stirrers and followers (optional);
- (g) Glove box (recommended).

Reagents

14. Use analytical grade reagents throughout.

⁽¹⁾ The recommended size is 0,1 litre to 1 litre.

⁽²⁾ The use of gas-tight silicone septa is recommended. It is further recommended that the gas-tightness of caps, especially butyl rubber septa, be tested because several commercially available septa are not sufficiently gas-tight against methane and some septa do not stay tight when they are pierced with a needle under the conditions of the test.

⁽³⁾ The device should be used and calibrated at regular intervals, according to the manufacturer's instructions. If a pressure-meter of the prescribed quality is used e.g. capsulated with a steel membrane, no calibration is necessary in the laboratory. The accuracy of the calibration can be checked at the laboratory with a one-point measurement at 1×10^5 Pa against a pressure-meter with a mechanical display. When this point is measured correctly, the linearity will also be unaltered. If other measurement devices are used (without certified calibration by the manufacturer), calibration is recommended over the total range at regular intervals.

▼ M6**Water**

15. Distilled or deionised water (de-oxygenated by sparging with nitrogen gas containing less than 5 µl/l oxygen), containing less than 2 mg/l dissolved organic carbon (DOC).

Test medium

16. Prepare the dilution medium to contain the following constituents at the stated amounts;

Anhydrous potassium dihydrogen phosphate (KH_2PO_4)	0,27 g
Disodium hydrogen phosphate dodecahydrate ($\text{Na}_2\text{HPO}_4 \cdot 12\text{H}_2\text{O}$)	1,12 g
Ammonium chloride (NH_4Cl)	0,53 g
Calcium chloride dihydrate ($\text{CaCl}_2 \cdot 2\text{H}_2\text{O}$)	0,075 g
Magnesium chloride hexahydrate ($\text{MgCl}_2 \cdot 6\text{H}_2\text{O}$)	0,10 g
Iron (II) chloride tetrahydrate ($\text{FeCl}_2 \cdot 4\text{H}_2\text{O}$)	0,02 g
Resazurin (oxygen indicator)	0,001 g
Sodium sulphide nonahydrate ($\text{Na}_2\text{S} \cdot 9\text{H}_2\text{O}$)	0,10 g
Stock solution of trace elements (optional, paragraph 18)	10 ml
Add de-oxygenated water (paragraph 15)	to 1 litre

Note: Freshly supplied sodium sulphide should be used or it should be washed and dried before use, to ensure sufficient reductive capacity. The test may be performed without using a glove box (see paragraph 26). In this case, the final concentration of sodium sulphide in the medium should be increased to 0,20 g of $\text{Na}_2\text{S} \cdot 9\text{H}_2\text{O}$ per litre. Sodium sulphide may also be added from an appropriate anaerobic stock solution through the septum of the closed test vessels as this procedure will decrease the risk of oxidation. Sodium sulphide may be replaced by titanium (III) citrate, which is added through the septum of closed test vessels at a final concentration of 0,8 to 1,0 mmol/l. Titanium (III) citrate is a highly effective and low-toxicity reducing agent, which is prepared as follows: Dissolve 2,94 g of trisodium citrate dihydrate in 50 ml of de-oxygenated water (to result in a solution of 200 mmol/l) and add 5 ml of a 15 % (w/v) titanium (III) chloride solution. Neutralise to pH $7 \pm 0,2$ with mineral alkali and dispense to an appropriate vessel under a stream of nitrogen. The concentration of titanium (III) citrate in this stock solution is 164 mmol/l.

17. Mix the components of the test medium except the reducing agent (sodium sulphide titanium citrate) and sparge the solution with nitrogen gas for about 20 min immediately before use to remove oxygen. Then add the appropriate volume of freshly prepared solution of the reducing agent (prepared in de-oxygenated water) just before use of the medium. Adjust the pH of the medium, if necessary, with dilute mineral acid or alkali to $7 \pm 0,2$.

▼ M6**Stock solution of trace elements (optional)**

18. It is recommended that the test medium should contain the following trace elements to improve anaerobic degradation processes, especially if low concentrations (e.g. 1g/l) of inoculum are used (11).

Manganese chloride tetrahydrate ($\text{MnCl}_2 \cdot 4\text{H}_2\text{O}$)	50 mg
Boric acid (H_3BO_3)	5 mg
Zinc chloride (ZnCl_2)	5 mg
Copper (II) chloride (CuCl_2)	3 mg
Disodium molybdate dihydrate ($\text{Na}_2\text{MoO}_4 \cdot 2\text{H}_2\text{O}$)	1 mg
Cobalt chloride hexahydrate ($\text{CoCl}_2 \cdot 6\text{H}_2\text{O}$)	100 mg
Nickel chloride hexahydrate ($\text{NiCl}_2 \cdot 6\text{H}_2\text{O}$)	10 mg
Disodium selenite (Na_2SeO_3)	5 mg
Add de-oxygenated water (paragraph 15)	to 1 litre

Test substance

19. Add the test substance as a stock solution, suspension, emulsion, or directly as solid or liquid, or as absorbed on to glass-fibre filter to give a concentration of no more than 100 mg/l organic carbon. If stock solutions are used, prepare a suitable solution with water (paragraph 15) (previously de-oxygenated by sparging with nitrogen gas) of such a strength that the volume added is less than 5 % of the total volume of reaction mixture. Adjust the pH of the stock solution to $\text{pH } 7 \pm 0,2$ if necessary. For test substances which are insufficiently soluble in water, consult ISO 10634 (13). If a solvent is used, prepare an additional control, with the solvent only added to the inoculated medium. Organic solvents which are known to inhibit methane production, such as chloroform and carbon tetrachloride, should be avoided.

Warning — Handle with care toxic test substances, and those whose properties are not known.

Reference substances

20. Reference substances such as sodium benzoate, phenol and polyethylene glycol 400 have been used successfully to check the procedure, being biodegraded by more than 60 % within 60 days. Prepare a stock solution (in de-oxygenated water) of the chosen reference substance in the same way as for the test substance and adjust to $\text{pH } 7 \pm 0,2$ if necessary.

Inhibition control (conditional)

21. In order to obtain information on the toxicity of the test substance to anaerobic micro-organisms to find the most appropriate test concentration, add the test substance and reference substance to a vessel containing the test medium (see paragraph 16), each at the same concentrations as added, respectively (see paragraphs 19 and 20 and see also ISO 13641-1 (12)).

▼ M6**Digested sludge**

22. Collect digested sludge from a digester at a waste water treatment plant which treats predominantly domestic sewage. The sludge should be fully characterised and its background information should be reported (see paragraph 54). If use of adapted inoculum is intended, digested sludge from an industrial sewage treatment plant may be considered. Use wide-necked bottles constructed from high-density polyethylene or a similar material, which can expand, for the collection of the digested sludge. Add sludge to within about 1 cm of the top of the bottles and seal tightly, preferably with a safety valve. After transport to the laboratory, the collected sludge may be used directly or placed in a laboratory-scale digester. Release excess biogas by opening bottles of sludge carefully. Alternatively, laboratory-grown anaerobic sludge may be used as a source of inoculum but its spectrum of activity may have been impaired.

Warning — Digested sludge produces flammable gases which present fire and explosion risks: it also contains potentially pathogenic organisms, so take appropriate precautions when handling sludge. For safety reasons, do not use glass vessels for collecting sludge.

23. In order to reduce background gas production and to decrease the influence of the blank controls, pre-digestion of the sludge may be considered. If pre-digestion is required, the sludge should be allowed to digest without the addition of any nutrients or substrates at $35\text{ °C} \pm 2\text{ °C}$ for up to 7 days. It has been found that pre-digestion for about 5 days usually gives an optimal decrease in gas production of the blank without unacceptable increases in either lag or incubation periods during the test phase or loss of activity towards a small number of substances tested.
24. For test substances which are, or are expected to be, poorly biodegradable, consider pre-exposure of the sludge to the test substance to obtain an inoculum which is better adapted. In such a case, add the test substance at an organic carbon concentration of 5 mg/l to 20 mg/l to the digested sludge and incubated for up to 2 weeks. Wash the pre-exposed sludge carefully before use (see paragraph 25) and indicate in the test report the conditions of the pre-exposure.

Inoculum

25. Wash the sludge (see paragraphs 22 to 24) just prior to use, to reduce the IC concentration to less than 10 mg/l in the final test suspension. Centrifuge the sludge in sealed tubes (e.g. 3 000 g during 5 min) and discharge the supernatant. Suspend the resulting pellet in de-oxygenated medium (paragraphs 16 and 17), re-centrifuge the suspension and discharge the supernatant liquid. If the IC has not been sufficiently lowered, the washing procedure of the sludge could be repeated twice as a maximum. This does not appear to affect the micro-organisms adversely. Finally, suspend the pellet in the requisite volume of test medium and determine the concentration of total solids [e.g. ISO 11923 (15)]. The final concentration of total solids in the test vessels should be in the range of 1 g/l to 3 g/l (or about 10 % of that in undiluted digested sludge). Conduct the above operations in such a way that the sludge has minimal contact with oxygen (e.g. use a nitrogen atmosphere).

▼ M6

TEST PROCEDURE

26. Perform the following initial procedures using techniques to keep the contact between digested sludge and oxygen as low as practicable, for example, it may be necessary to work within a glove box in an atmosphere of nitrogen and/or purge the bottles with nitrogen (4).

Preparation of test and control assays

27. Prepare at least triplicate test vessels (see paragraph 13-b) for the test substance, blank controls, reference substance, inhibition controls (conditional) and pressure control chambers (optional procedure) (see paragraphs 7, 19 to 21). Additional vessels for the purpose of evaluating primary biodegradation using test substance specific analyses may also be prepared. The same set of blank controls may be used for several test substances in the same test as long as the headspace volumes are consistent.

28. Prepare the diluted inoculum before adding it to the vessels e.g. by the means of a wide-mouthed pipette. Add aliquots of well-mixed inoculum (paragraph 25) so that the concentration of total solids is the same in all vessels (between 1 g/l and 3 g/l). Add stock solutions of the test and reference substance after adjustment to $\text{pH } 7 \pm 0,2$, if necessary. The test substance and the reference substance should be added using the most appropriate route of administration (paragraph 19).

29. The test concentration of organic carbon should normally be between 20 and 100 mg/l (paragraph 4). If the test substance is toxic, the test concentration should be reduced to 20 mg C/l, or even less if only primary biodegradation with specific analyses is to be measured. It should be noted that the variability of the test results increases at lower test concentrations.

30. For blank vessels, add an equivalent amount of the carrier used to dose the test substance instead of a stock solution, suspension or emulsion. If the test substance was administered using glass fibre filters or organic solvents, add to the blanks a filter or an equivalent volume solvent that has been evaporated. Prepare an extra replicate with test substance for the measurement of the pH value. Adjust the pH to $7 \pm 0,2$, if necessary, with small amounts of dilute mineral acid or alkali. The same amounts of neutralising agents should be added to all the test vessels. These additions should not have to be made since the pH value of the stock solutions of the test substance and reference substance have already been adjusted (see paragraphs 19 and 20). If primary biodegradation is to be measured, an appropriate sample should be taken from the pH-control vessel, or from an additional test vessel, and the test substance concentration should be measured using specific analyses. Covered magnets may be added to all the vessels if the reaction mixtures are to be stirred (optional).

31. Ensure that the total volume of liquid V_1 and the volume of headspace V_h are the same in all vessels; note and record the values of V_1 and V_h . Each vessel should be sealed with a gas septum and transferred from the glove box (see paragraph 26) into the incubator (see paragraph 13-a).

▼ M6**Insoluble test substances**

32. Add weighed amounts of substances, which are poorly soluble in water, directly to the prepared vessels. When the use of a solvent is necessary (see paragraph 19), transfer the test substance solution or suspension into the empty vessels. Where possible, evaporate the solvent by passing nitrogen gas through the vessels and then add the other ingredients, namely, diluted sludge (paragraph 25), and de-oxygenated water as required. An additional solvent control should also be prepared (see paragraph 19). For other methods of adding insoluble substances, ISO 10634 (13) can be consulted. Liquid test substances may be dosed with a syringe into the completely prepared sealed vessels, if it is expected that the initial pH will not exceed 7 ± 1 , otherwise dose as described above (see paragraph 19).

Incubation and gas pressure measurements

33. Incubate the prepared vessels at $35\text{ °C} \pm 2\text{ °C}$ for about 1h to allow equilibration and release excess gas to the atmosphere, for example, by shaking each vessel in turn, inserting the needle of the pressure meter (paragraph 13-c) through the seal and opening the valve until the pressure meter reads zero. If at this stage, or when making intermediate measurements, the headspace pressure is less than atmospheric, nitrogen gas should be introduced to re-establish atmospheric pressure. Close the valve (see paragraph 13-c) and continue to incubate in the dark, ensuring that all parts of the vessels are maintained at the digestion temperature. Observe the vessels after incubation for 24 to 48 h. Reject vessels if the contents of the vessels show a distinct pink coloration in the supernatant liquid, i.e. if Resazurin (see paragraph 16) has changed colour indicating the presence of oxygen (see paragraph 50). While small amounts of oxygen may be tolerated by the system, higher concentrations can seriously inhibit the course of anaerobic biodegradation. The rejection of the occasional single vessel of a set of triplicates may be accepted, but the incidence of more failures than this must lead to an investigation of the experimental procedures as well as the repeating of the test.
34. Carefully mix the contents of each vessel by stirring or by shaking for a few minutes at least 2 or 3 times per week and soon before each pressure measurement. Shaking re-suspends the inoculum and ensures gaseous equilibrium. All pressure measurements should be taken quickly, since the test vessels could be subject to lowering of temperature, leading to false readings. While measuring pressure the whole test vessel including the headspace should be maintained at the digestion temperature. Measure the gas pressure, for example, by inserting through the septum the syringe needle (paragraph 13-c) connected to the pressure-monitoring meter. Care should be taken to prevent entry of water into the syringe needle; if this occurs the wet parts should be dried and a new needle fitted. The pressure should be measured in millibars (see paragraph 42). The gas pressure in the vessels may be measured periodically e.g. weekly, and optionally the excess gas is released to the atmosphere. Alternatively the pressure is measured only at the end of the test to determine the amount of biogas produced.
35. It is recommended that intermediate readings of gas pressure be made, since pressure increase provides guidance as to when the test may be terminated and allows the kinetics to be followed (see paragraph 6).

▼ M6

36. Normally end the test after an incubation period of 60 days unless the biodegradation curve obtained from the pressure measurements has reached the plateau phase before then; that is the phase in which the maximal degradation has been reached and the biodegradation curve has levelled out. If the plateau value is less than 60 % interpretation is problematic because it indicates that only part of the molecule has been mineralised or that an error has been made. If at the end of the normal incubation period, gas is being produced but a plateau phase is obviously not reached, then it should be considered to prolong the test to check whether the plateau (> 60 %) will be reached.

Measurement of inorganic carbon

37. At the end of the test after the last measurement of gas pressure, allow the sludge to settle. Open each vessel in turn and immediately take a sample for the determination of the concentration (mg/l) of inorganic carbon (IC) in the supernatant liquor. Neither centrifugation nor filtration should be applied to the supernatant liquor, since there would be an unacceptable loss of dissolved carbon dioxide. If the liquor cannot be analysed on being sampled, store it in a sealed vial, without headspace and cooled to about 4 °C for up to 2 days. After the IC measurement, measure and record the pH value.
38. Alternatively, the IC in the supernatant may be determined indirectly by release of the dissolved IC as carbon dioxide that can be measured in the headspace. Following the last measurement of gas pressure, adjust the pressure in each of the test vessels to atmospheric pressure. Acidify the contents of each vessel to approximately pH 1 by adding of concentrated mineral acid (e.g. H₂SO₄) through the septum of the sealed vessels. Incubate the shaken vessels at 35 °C ± 2 °C for approximately 24 hours and measure the gas pressure resulting from the evolved carbon dioxide by using the pressure meter.
39. Make similar readings for the corresponding blank, reference substance and, if included, inhibition control vessels (see paragraph 21).
40. In some cases, especially if the same control vessels are used for several test substances, measurements of intermediate IC concentrations in test and control vessels should be considered, as appropriate. In this case, a sufficient number of vessels should be prepared for all the intermediate measurements. This proceeding is preferred to taking all samples from one vessel only. The latter can only be done if the required volume for DIC analysis is not deemed to be too high. The DIC measurement should be made after measuring the gas pressure without release of excess gas as described below:
- take as small a volume as possible of supernatant samples with a syringe through the septum without opening the vessels and IC in the sample is determined;
 - after having taken the sample the excess gas is released, or not;
 - it should be taken into account that even a small decrease in the supernatant volume (e.g. about 1 %) can yield a significant increase in the headspace gas volume (V_h);
 - the equations (see paragraph 44) are corrected by increasing V_h in equation 3, as necessary.

▼ M6**Specific analyses**

41. If primary anaerobic degradation (see paragraph 30) is to be determined, take an appropriate volume of sample for specific analyses at the beginning and at the end of the test from the vessels containing the test substance. If this is done, note the volumes of headspace (V_h) and of the liquid (V_l) will be changed and take this into account when calculating the results of gas production. Alternatively samples may be taken for specific analyses from additional mixtures previously set up for the purpose (paragraph 30).

DATA AND REPORTING**Treatment of results**

42. For practical reasons, the pressure of the gas is measured in millibars (1 mbar = 1h Pa = 10^2 Pa; 1 Pa = 1 N/m²), the volume in litres and temperature in degrees Celsius.

Carbon in the headspace

43. Since 1 mol of methane and 1 mol carbon dioxide each contain 12 g of carbon, the mass of carbon in a given volume of evolved gas may be expressed as:

$$m = 12 \times 10^3 \times n \quad \text{Equation [1]}$$

where:

m = mass of carbon (mg) in a given volume of evolved gas;

12 = relative atomic mass of carbon;

n = number of moles of gas in the given volume.

If a gas other than methane or carbon dioxide (e.g. N₂O) is generated in considerable amounts, the formula [1] should be amended in order to describe the possibility of effects by gases generated.

44. From the gas laws n may be expressed as:

$$n = \frac{pV}{RT} \quad \text{Equation [2]}$$

where:

p = pressure of the gas (Pascals);

V = volume of the gas (m³);

R = molar gas constant [8,314 J/(mol K)];

T = incubation temperature (Kelvins).

By combination of equations [1] and [2] and rationalising to allow for blank control production of gas:

$$m_h = \frac{12\,000 \times 0,1(\Delta p \cdot V_h)}{RT} \quad \text{Equation [3]}$$

where:

m_h = mass of net carbon produced as gas in the headspace (mg);

Δp = mean of the difference between initial and final pressures in the test vessels minus the corresponding mean in the blank vessels (millibars);

▼ M6

V_h = volume of headspace in the vessel (l);

0,1 = conversion for both newtons/m² to millibars and m³ to litres.

Equation [4] should be used for the normal incubation temperature of 35 °C (308 K):

$$m_h = 0,468(\Delta p \cdot V_h) \quad \text{Equation [4]}$$

Note: Alternative volume calculation. Pressure meter readings are converted to ml of gas produced using the standard curve generated by plotting volume (ml) injected versus meter reading (Appendix 2). The number of moles (n) of gas in the headspace of each vessel is calculated by dividing the cumulative gas production (ml) by 25 286 ml/mole, which is the volume occupied by one mole of gas at 35 °C and standard atmospheric pressure. Since 1 mole of CH₄ and 1 mole of CO₂ each contain 12 g of carbon, the amount of carbon (mg) in the headspace (m_h) is given by Equation [5]:

$$m_h = 12 \times 10^3 \times n \quad \text{Equation [5]}$$

Rationalising to allow for blank control production of gas:

$$m_h = \frac{12\,000 \times \Delta V}{25\,286} = 0,475\Delta V \quad \text{Equation [6]}$$

where:

m_h = mass of net carbon produced as gas in the headspace (mg);

ΔV = mean of the difference between volume of gas produced in headspace in the test vessels and blank control vessels;

25286 = volume occupied by 1 mole gas at 35 °C, 1 atmosphere.

45. The course of biodegradation can be followed by plotting the cumulated pressure increase Δp (millibars) against time, if appropriate. From this curve, identify and record the lag phase (days). The lag phase is the time from the start of the test until significant degradation starts (for example see Appendix 3). If intermediate samples of supernatant were taken and analysed (see paragraphs 40, 46 and 47), then the total C produced (in gas plus that in liquid) may be plotted instead of only the cumulative pressure.

Carbon in the liquid

46. The amount of methane in the liquid is ignored since its solubility in water is known to be very low. Calculate the mass of inorganic carbon in the liquid of the test vessels using equation [7]:

$$m_l = C_{net} \times V_l \quad \text{Equation [7]}$$

where:

m_l = mass of inorganic carbon in the liquid (mg);

C_{net} = concentration of inorganic carbon in the test vessels minus that in the control vessels at the end of the test (mg/l);

V_l = volume of liquid in the vessel (l).

▼ M6**Total gasified carbon**

47. Calculate the total mass of gasified carbon in the vessel using equation [8]:

$$m_t = m_h + m_l \quad \text{Equation [8]}$$

where:

m_t = total mass of gasified carbon (mg);

m_h and m_l are as defined above.

Carbon of test substance

48. Calculate the mass of carbon in the test vessels derived from the added test substance using equation [9]:

$$m_v = C_c \times V_l \quad \text{Equation [9]}$$

where:

m_v = mass of test substance carbon (mg);

C_c = concentration of test substance carbon in the test vessel (mg/l)

V_l = volume of liquid in the test vessel (l).

Extent of biodegradation

49. Calculate the percentage biodegradation from headspace gas using equation [10] and the total percentage biodegradation using equation [11]:

$$D_h = (m_h/m_v) \times 100 \quad \text{Equation [10]}$$

$$D_t = (m_t/m_v) \times 100 \quad \text{Equation [11]}$$

where:

D_h = biodegradation from headspace gas (%);

D_t = total biodegradation (%);

m_h , m_v and m_t are as defined above.

The degree of primary biodegradation is calculated from the (optional) measurements of the concentration of the test substance at the beginning and end of incubation, using equation [12]:

$$D_p = (1 - S_e/S_i) \times 100 \quad \text{Equation [12]}$$

where:

D_p = primary degradation of test substance (%);

S_i = initial concentration of test substance (mg/l);

S_e = concentration of test substance at end (mg/l).

If the method of analysis indicates significant concentrations of the test substance in the unamended anaerobic sludge inoculum, use equation [13]:

▼ M6

$$D_p^1 = [1 - (S_e - S_{eb}) / (S_i - S_{ib})] \times 100 \quad \text{Equation [13]}$$

where:

D_p^1 = corrected primary degradation of test substance (%);

S_{ib} = initial 'apparent' concentration of test substance in blank controls (mg/l);

S_{eb} = 'apparent' concentration of test substance in blank controls at end (mg/l).

Validity of results

50. Pressure readings should be used only from vessels that do not show pink coloration (see paragraph 33). Contamination by oxygen is minimised by the use of proper anaerobic handling techniques.
51. It should be considered that the test is valid if the reference substance reaches a plateau that represents more than 60 % biodegradation (¹).
52. If the pH at the end of the test has exceeded the range 7 ± 1 and insufficient biodegradation has taken place, repeat the test with increased buffer capacity of the medium.

Inhibition of degradation

53. Gas production in vessels containing both the test substance and reference substance should be at least equal to that in the vessels containing only reference substance; otherwise, inhibition of gas production is indicated. In some cases gas production in vessels containing test substance without reference substance will be lower than that in the blank controls, indicating that the test substance is inhibitory.

Test report

54. The test report must include the following information:

Test substance:

- common name, chemical name, CAS number, structural formula and relevant physical-chemical properties;
- purity (impurities) of test substance.

Test conditions:

- volumes of diluted digester liquor (V_i) and of the headspace (V_h) in the vessel;
- description of the test vessels, the main characteristics of biogas measurement (e.g. type of pressure meter) and of the IC analyser;
- application of test substance and reference substance to test system: test concentration used and any use of solvents;
- details of the inoculum used: name of sewage treatment plant, description of the source of waste water treated (e.g. operating temperature, sludge retention time, predominantly domestic, etc.), concentration, any information necessary to substantiate this and information on any pre-treatment of the inoculum (e.g. pre-digestion, pre-exposure);
- incubation temperature;
- number of replicates.

⁽¹⁾ This should be re-evaluated if adsorptive and insoluble reference chemicals are included.

▼ M6*Results:*

- pH and IC values at the end of the test;
- concentration of test substance at the beginning and end of the test, if a specific measurement has been performed;
- all the measured data collected in the test, blank, reference substance and inhibition control vessels, as appropriate (e.g. pressure in millibars, concentration of inorganic carbon (mg/l)) in tabular form (measured data for headspace and liquid should be reported separately);
- statistical treatment of data, test duration and a diagram of the biodegradation of test substance, reference substance and inhibition control;
- percentage biodegradation of test substance and reference substance;
- reasons for any rejection of the test results;
- discussion of results.

LITERATURE

- (1) The following chapters of this Annex:
 - C.4, Determination of Ready Biodegradability;
 - C.9, Biodegradation — Zahn-Wellens Test;
 - C.10, Simulation Test — Aerobic Sewage Treatment:
 - A: Activated Sludge Units, B: Biofilms
 - C.11, Biodegradation — Activated sludge respiration inhibition
- (2) OECD (2009) Inherent Biodegradability: Modified MITI Test (II), OECD Guideline for Testing of Chemicals, No. 302C, OECD, Paris
- (3) Birch, R. R., Biver, C., Campagna, R., Gledhill, W.E., Pagga, U., Steber, J., Reust, H. and Bontinck, W.J. (1989) Screening of chemicals for anaerobic biodegradation. *Chemosphere* 19, 1527-1550. (Also published as ECETOC Technical Report No. 28, June 1988).
- (4) Shelton D.R. and Tiedje, J.M. (1984) General method for determining anaerobic biodegradation potential. *Appl. Environ. Microbiology*, 47, 850-857.
- (5) Owen, W.F., Stuckey, DC., Healy J.B., Jr, Young L.Y. and McCarty, P.L. (1979) Bioassay for monitoring biochemical methane potential and anaerobic toxicity. *Water Res.* 13, 485-492.
- (6) Healy, J.B.Jr. and Young, L.Y. (1979) Anaerobic biodegradation of eleven aromatic compounds to methane. *Appl. Environ. Microbiol.* 38, 84-89.
- (7) Gledhill, W.E. (1979) Proposed standard practice for the determination of the anaerobic biodegradation of organic chemicals. Working document. Draft 2 no.35.24. American Society for Testing Materials, Philadelphia.
- (8) Battersby, N.S. and Wilson, V. (1988) Evaluation of a serum bottle technique for assessing the anaerobic biodegradability of organic chemicals under methanogenic conditions. *Chemosphere*, 17, 2441-2460.
- (9) E1192-92. Standard Test Method for Determining the Anaerobic Biodegradation Potential of Organic Chemicals. ASTM, Philadelphia.

▼ M6

- (10) US-EPA (1998) Fate, Transport and Transformation Test Guidelines OPPTS 835.3400 Anaerobic Biodegradability of Organic Chemicals.
- (11) International Organization for Standardization (1995) ISO 11 734 Water Quality — Evaluation of the ultimate anaerobic biodegradation of organic compounds in digested sludge — Method by measurement of the biogas production.
- (12) International Organization for Standardization (2003) ISO 13 641-1 Water Quality — Determination of inhibition of gas production of anaerobic bacteria — Part 1 General Test.
- (13) International Organization for Standardization (1995) ISO 10 634 Water Quality — Guidance for the preparation and treatment of poorly water-soluble organic compounds for the subsequent evaluation of their biodegradability in an aqueous medium.
- (14) Pagga, U. and Beimborn, D.B., (1993) Anaerobic biodegradation test for organic compounds. *Chemosphere*, 27, 1499-1509.
- (15) International Organization for Standardization (1997) ISO 11 923 Water Quality — Determination of suspended solids by filtration through glass-fibre filters.

▼ **M6**

Appendix 1

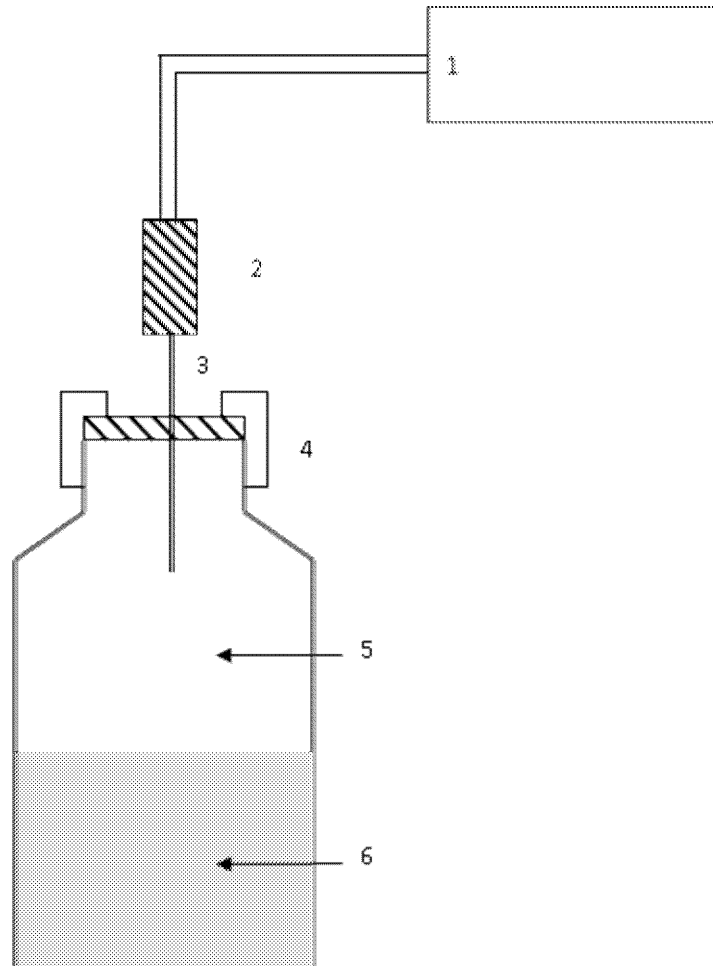
Example of an apparatus to measure biogas production by gas pressure*Key:*

- 1 — Pressure meter
- 2 — 3-way gas-tight valve
- 3 — Syringe needle
- 4 — Gastight seal (crimp cap and septum)
- 5 — Head space (V_h)
- 6 — Digested sludge inoculum (V_l)

Test vessels in an environment of $35\text{ °C} \pm 2\text{ °C}$

▼ M6*Appendix 2***Conversion of the pressure-meter**

The pressure-meter readings may be related to gas volumes by means of a standard curve produced by injecting known volumes of air at $35\text{ °C} \pm 2\text{ °C}$ into serum bottles containing a volume of water equal to that of the reaction mixture, V_R :

- Dispense V_R ml aliquots of water, kept at $35\text{ °C} \pm 2\text{ °C}$ into five serum bottles. Seal the bottles and place in a water bath at 35 °C for 1 hour to equilibrate;
- Switch on the pressure-meter, allow to stabilise, and adjust to zero;
- Insert the syringe needle through the seal of one of the bottles, open the valve until the pressure meter reads zero and close the valve;
- Repeat the procedure with the remaining bottles;
- Inject 1 ml of air at $35\text{ °C} \pm 2\text{ °C}$ into each bottle. Insert the needle (on the meter) through the seal of one of the bottles and allow the pressure reading to stabilise. Record the pressure, open the valve until the pressure reads zero and then close the valve;
- Repeat the procedure for the remaining bottles;
- Repeat the total procedure above using 2 ml, 3 ml, 4 ml, 5 ml, 6 ml, 8 ml, 10 ml, 12 ml, 16 ml, 20 ml and 50 ml of air;
- Plot a conversion curve of pressure (Pa) against gas volume injected V_b (ml). The response of the instrument is linear over the range 0 Pa to 70 000 Pa, and 0 ml to 50 ml of gas production.

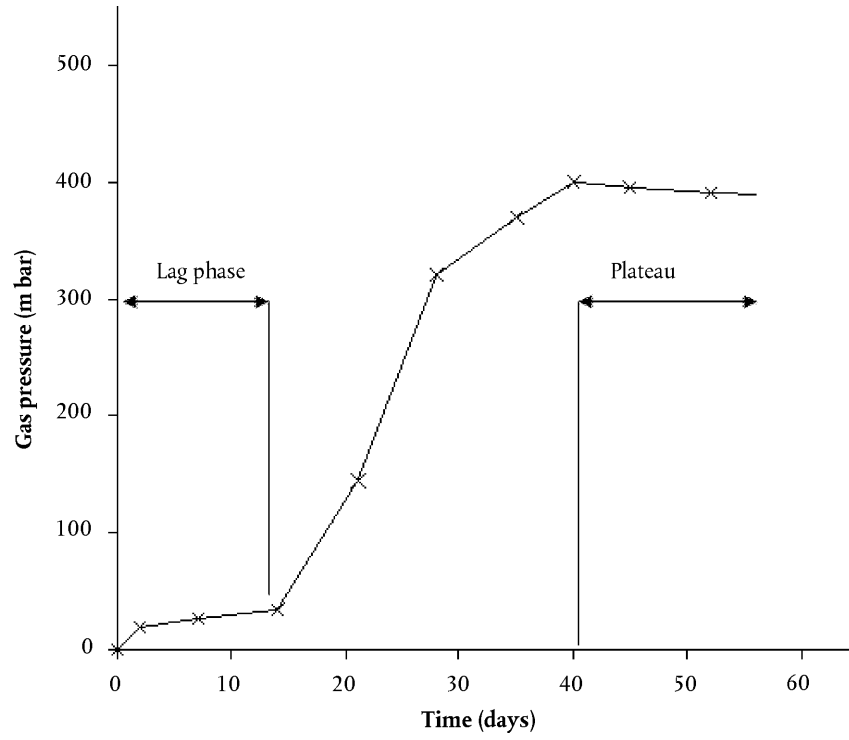
▼ **M6***Appendix 3***Example of a degradation curve (cumulative net pressure increase)**

Example of data sheets for the anaerobic biodegradation test — Data sheet for the test substance

Laboratory: Test substance: Test No.:
 Test temperature: (°C): Volume of headspace (V_h):(l) Volume of liquid (V_l):(l)
 Carbon in test substance $C_{c,v}$:(mg/l) m_v ⁽¹⁾:(mg)

Day	p_1 (test) (mbar)	p_2 (test) (mbar)	p_3 (test) (mbar)	p (test) mean (mbar)	p_4 (blank) (mbar)	p_5 (blank) (mbar)	p_6 (blank) (mbar)	p (blank) mean (mbar)	p (net) test — blank mean (mbar)	Δp (net) Cumulative (mbar)	m_h headspace C ⁽²⁾ (mg)	D_h Biodegrada- tion ⁽³⁾ (%)
	$C_{IC, 1}$ test (mg)	$C_{IC, 2}$ test (mg)	$C_{IC, 3}$ test (mg)	C_{IC} test mean (mg)	$C_{IC, 4}$ blank (mg)	$C_{IC, 5}$ blank (mg)	$C_{IC, 6}$ blank (mg)	C_{IC} blank mean (mg)	$C_{IC, net}$ test -blank mean (mg)	m_l liquid C ⁽⁴⁾ (mg)	m_t total C ⁽⁵⁾ (mg)	D_t Biodegrada- tion ⁽⁶⁾ (%)
IC (end)												
pH (end)												

⁽¹⁾ Carbon in test vessel, m_v (mg): $m_v = C_{c,v} \times V_l$
⁽²⁾ Carbon in headspace, m_h (mg) at normal incubation temperature (35 °C): $m_h = 0,468 \Delta p \times V_h$
⁽³⁾ Biodegradation calculated from headspace gas, D_h (%): $D_h = (m_h \times 100) / m_v$
⁽⁴⁾ Carbon in liquid, m_l (mg): $m_l = C_{IC, net} \times V_l$
⁽⁵⁾ Total gasified carbon, m_t (mg): $m_t = m_h + m_l$
⁽⁶⁾ Total biodegradation, D_t (%): $D_t = (m_t \times 100) / m_v$

▼ **M6**

Laboratory: Reference substance: Test No.:

Test temperature: (°C): Volume of headspace (V_h):(l) Volume of liquid (V_l) (litres):

Carbon in reference substance $C_{c,v}$ (mg/l): m_v (l) (mg):

Day	p_1 (ref.) (mbar)	p_2 (ref.) (mbar)	p_3 (ref.) (mbar)	p (ref.) mean (mbar)	p_4 (inhib.) (mbar)	p_5 (inhib.) (mbar)	p_6 (inhib.) (mbar)	p (inhib.) mean (mbar)	p (ref.) ref. — blank (mbar)	Δp (ref.) cumulative (mbar)	m_h headspace C (2) (mg)	D_h Biodegrada- tion (3) (%)
	$C_{IC, 1}$ ref. (mg)	$C_{IC, 2}$ ref. (mg)	$C_{IC, 3}$ ref. (mg)	C_{IC} ref. mean (mg)	$C_{IC, 4}$ inhib. (mg)	$C_{IC, 5}$ inhib. (mg)	$C_{IC, 6}$ inhib. (mg)	C_{IC} inhib. mean (mg)	$C_{IC, net}$ ref. — inhib. (mg)	m_l liquid C (4) (mg)	m_t total C (5) (mg)	D_t Biodegrada- tion (6) (%)
IC (end)												
pH (end)												

(1) Carbon in test vessel, m_v (mg): $m_v = C_{c,v} \times V_l$
 (2) Carbon in headspace, m_h (mg) at normal incubation temperature (35 °C): $m_h = 0,468 \Delta p \times V_h$
 (3) Biodegradation calculated from headspace gas, D_h (%): $D_h = (m_h \times 100)/m_v$
 (4) Carbon in liquid, m_l (mg): $m_l = C_{IC, net} \times V_l$
 (5) Total gasified carbon, m_t (mg): $m_t = m_h + m_l$
 (6) Total biodegradation, D_t (%): $D_t = (m_t \times 100)/m_v$

▼ M6**C.44. LEACHING IN SOIL COLUMNS****INTRODUCTION**

1. This test method is equivalent to OECD Test Guideline (TG) 312 (2004). Man-made chemicals may reach soil directly via deliberate application (e.g. agrochemicals) or via indirect routes (e.g. via waste water → sewage sludge → soil or air → wet/dry deposition). For risk assessment of these chemicals, it is important to estimate their potential for transformation in soil and for movement (leaching) into deeper soil layers and eventually into groundwater.
2. Several methods are available to measure the leaching potential of chemicals in soil under controlled laboratory conditions, i.e. soil thin-layer chromatography, soil thick-layer chromatography, soil column chromatography, and adsorption — desorption measurements (1)(2). For non-ionised chemicals, the n-octanol-water partition coefficient (P_{ow}) allows an early estimation of their adsorption and leaching potential (3)(4)(5).
3. The method described in this test method is based on soil column chromatography in disturbed soil (see Appendix 1 for definition). Two types of experiments are performed to determine (i) the leaching potential of the test chemical, and (ii) the leaching potential of transformation products (study with aged residues) in soils under controlled laboratory conditions (1). The test method is based on existing methods (6)(7)(8)(9)(10)(11).
4. An OECD Workshop on soil/sediment selection, held at Belgirate, Italy in 1995 (12) agreed on the number and type of soils for use in this test method. It also made recommendations with regard to collection, handling and storage of soil samples for leaching experiments.

PRINCIPLE OF THE TEST METHOD

5. Columns made of suitably inert material (e.g. glass, stainless steel, aluminium, teflon, PVC, etc.) are packed with soil and afterwards saturated and equilibrated with an 'artificial rain' solution (for definition see Appendix 1) and allowed to drain. Then the surface of each soil column is treated with the test chemical and/or with aged residues of the test chemical. Artificial rain is then applied to the soil columns and the leachate is collected. After the leaching process the soil is removed from the columns and is sectioned into an appropriate number of segments depending on the information required from the study. Each soil segment and the leachate are then analysed for the test chemical and, if appropriate, for transformation products or other chemicals of interest.

APPLICABILITY OF THE TEST METHOD

6. The test method is applicable to test chemicals (unlabelled or radio-labelled: e.g. ^{14}C) for which an analytical method with sufficient accuracy and sensitivity is available. The test method should not be applied to chemicals which are volatile from soil and water and thus do not remain in soil and/or leachate under the experimental conditions of this test method.

INFORMATION ON THE TEST CHEMICAL

7. Unlabelled or radio-labelled test chemicals can be used to measure the leaching behaviour in soil columns. Radio-labelled material is required for studying the leaching of transformation products (aged residues of the test

(1) Column leaching studies with crop protection products may provide mobility information on a test chemical and its transformation products and may supplement batch sorption studies.

▼M6

chemical) and for mass balance determinations. ^{14}C -labelling is recommended but other isotopes, such as ^{13}C , ^{15}N , ^3H , ^{32}P , may also be useful. As far as possible, the label should be positioned in the most stable part(s) of the molecule. The purity of the test chemical should be at least 95 %.

8. Most chemicals should be applied as single substance. However, for active substances in plant protection products, formulated products may be used to study the leaching of the parent test substance but their testing is particularly required when the mixture is likely to affect the release rate (e.g. granular or controlled release formulations). Regarding mixture specific requirements for test design, it may be useful to consult with the regulatory authority prior to conducting the test. For aged residue leaching studies, the pure parent test substance should be used.
9. Before carrying out leaching tests in soil columns, the following information on the test chemical should preferably be available:

- (1) solubility in water [test method A.6] (13);
- (2) solubility in organic solvents;
- (3) vapour pressure [test method A.4] (13) and Henry's Law constant;
- (4) n-octanol/water partition coefficient [test methods A.8 and A.24] (13);
- (5) adsorption coefficient (K_d , K_f or K_{OC}) [test methods C.18 and/or C.19] (13);
- (6) hydrolysis [test method C.7] (13);
- (7) dissociation constant ($\text{p}K_a$) [OECD TG 112] (25);
- (8) aerobic and anaerobic transformation in soil [test method C.23] (13)

Note: The temperature at which these measurements were made should be reported in the respective test reports.

10. The amount of test chemical applied to the soil columns should be sufficient to allow for detection of at least 0,5 % of the applied dose in any single segment. For active chemicals in plant protection products, the amount of test chemical applied may correspond to the maximum recommended use rate (single application).
11. An appropriate analytical method of known accuracy, precision and sensitivity for the quantification of the test chemical and, if relevant, of its transformation products in soil and leachate must be available. The analytical detection limit for the test chemical and its significant transformation products (normally at least all transformation products ≥ 10 % of applied dose observed in transformation pathway studies, but preferably any relevant transformation products of concern) should also be known (see paragraph 17).

▼ M6

REFERENCE CHEMICALS

12. Reference chemicals with known leaching behaviour such as atrazine or monuron which can be considered moderate leachers in the field should be used for evaluating the relative mobility of the test chemical in soil (1)(8)(11). A nonsorbing and non degradable polar reference chemical (e.g. tritium, bromide, fluorescein, eosin) to trace the movement of water in the column may also be useful to confirm the hydrodynamic properties of the soil column.

13. Analytical standard chemicals may also be useful for the characterisation and/or identification of transformation products found in the soil segments and in the leachates by chromatographic, spectroscopic or other relevant methods.

DEFINITIONS AND UNITS

14. See Appendix 1.

QUALITY CRITERIA

Recovery

15. The sum of the percentages of the test chemical found in the soil segments and the column leachate after leaching gives the recovery for a leaching experiment. Recoveries should range from 90 % to 110 % for radio-labelled chemicals (11) and from 70 % to 110 % for non-labelled chemicals (8).

Repeatability and sensitivity of analytical method

16. Repeatability of the analytical method to quantify test chemical and transformation products can be checked by duplicate analysis of the same extract of a soil segment or of a leachate (see paragraph 11).

17. The limit of detection (LOD) of the analytical method for the test chemical and for the transformation products should be at least $0,01 \text{ mg} \cdot \text{kg}^{-1}$ in each soil segment or leachate (as test chemical) or 0,5 % of applied dose in any single segment whichever is lower. The limit of quantification (LOQ) should also be specified.

DESCRIPTION OF THE TEST METHOD

Test system

18. Leaching columns (sectionable or non-sectionable) made of suitably inert material (e.g. glass, stainless steel, aluminium, teflon, PVC, etc.) with an inner diameter of at least 4 cm and a minimum height of 35 cm are used for the test. Column materials should be tested for potential interactions with the test chemical and/or its transformation products. Examples of suitable sectionable and non-sectionable columns are shown in Appendix 2.

19. Spoon, plunger and vibration apparatus are used for filling and packing the soil columns.

20. For application of artificial rain to the soil columns, piston or peristaltic pumps, showering heads, Mariotte bottles or simple dropping funnels can be used.

▼M6**Laboratory equipment and chemicals**

21. Standard laboratory equipment is required, in particular the following:
- (1) analytical instruments such as GLC, HPLC and TLC equipment, including the appropriate detection systems for analysing labelled or unlabelled chemicals or inverse isotope dilution method;
 - (2) instruments for identification purposes (e.g. MS, GC-MS, HPLC-MS, NMR, etc.);
 - (3) liquid scintillation counter for radio-labelled test chemical;
 - (4) oxidiser for combustion of labelled material;
 - (5) extraction apparatus (for example, centrifuge tubes for cold extraction and Soxhlet apparatus for continuous extraction under reflux);
 - (6) instrumentation for concentrating solutions and extracts (e.g. rotating evaporator).
22. Chemicals used include: organic solvents, analytical grade, such as acetone, methanol, etc.; scintillation liquid; 0,01 M CaCl₂ solution in distilled or deionised water (= artificial rain).

Test chemical

23. To apply the test chemical to the soil column it should be dissolved in water (deionised or distilled). If the test chemical is poorly soluble in water, it can be applied either as formulated product (if necessary after suspending or emulsifying in water) or in any organic solvent. In case an organic solvent is used, it should be kept to a minimum and should be evaporated from the surface of the soil column prior to start of leaching procedure. Solid formulations, such as granules, should be applied in the solid form without water; to allow a better distribution over the surface of the soil column, the formulated product may be mixed with a small amount of quartz sand (e.g. 1 g) before application.
24. The amount of test chemical applied to the soil columns should be sufficient to allow for detection of at least 0,5 % of the applied dose in any single segment. For active chemicals in plant protection products, this may be based on the maximum recommended use rate (single application rate) and, for both parent and aged leaching, should be related to the surface area of the soil column used ⁽¹⁾.

Reference chemical

25. A reference chemical should be used in the leaching experiments (see paragraph 12). It should be applied to the soil column surface in a similar way as the test chemical and at an appropriate rate that enables adequate

⁽¹⁾ The amount to be applied to cylindrical soil columns can be calculated by the following formula:

$$M [\mu\text{g}] = \frac{A [\text{kg}/\text{ha}] \cdot 10^9 [\mu\text{g}/\text{kg}] \cdot d^2 [\text{cm}^2] \cdot \pi}{10^8 [\text{cm}^2/\text{ha}] \cdot 4}$$

where:

- M = amount applied per column [μg]
 A = rate of application [$\text{kg} \cdot \text{ha}^{-1}$]
 d = diameter of soil column [cm]
 π = 3,14

▼ **M6**

detection either as an internal standard together with the test chemical on the same soil column or alone on a separate soil column. It is preferred that both chemicals be run on the same column, except when both chemicals are similarly labelled.

Soils*Soil selection*

26. For leaching studies with the parent test chemical 3 to 4 soils with varying pH, organic carbon content and texture should be used (12). Guidance for selection of soils for leaching experiments is given in Table 1 below. For ionisable test chemicals the selected soils should cover a wide range of pH, in order to evaluate the mobility of the chemical in its ionised and unionised forms; at least 3 soils should have a pH at which the test chemical is in its mobile form.

Table 1

Guidance for selection of soils for leaching studies

Soil No.	pH value	Organic carbon %	Clay content %	Texture (*)
1	> 7,5	3,5 - 5,0	20 - 40	clay loam
2	5,5 - 7,0	1,5 - 3,0	15 - 25	silt loam
3	4,0 - 5,5	3,0 - 4,0	15 - 30	loam
4	< 4,0 - 6,0 §	< 0,5 - 1,5 § ‡	< 10 - 15 §	loamy sand
5	< 4,5	> 10 #	< 10	loamy sand/sand

(*) According to FAO and USDA systems (14).

§ The respective variables should preferably show values within the range given. If, however, difficulties in finding appropriate soil material occur, values below the indicated minimum are accepted.

‡ Soils with less than 0,3 % organic carbon may disturb correlation between organic content and adsorption. Thus, it is recommended to use soils with a minimum organic carbon content of 0,3 %.

Soils with very high carbon content (e.g. > 10 %) may not be acceptable legally e.g. for pesticide registration purposes.

27. Other soil types may sometimes be necessary to represent cooler, temperate and tropical regions. Therefore, if other soil types are preferred, they should be characterised by the same parameters and should have similar variations in properties as those described in the guidance for selection of soils for leaching studies (see Table 1 above), even if they do not match the criteria exactly.
28. For leaching studies with 'aged residues', one soil should be used (12). It should have a sand content > 70 % and an organic carbon content between 0,5 - 1,5 % (e.g. soil No. 4 in Table 1). Use of more soil types may be necessary if data on the transformation products are important.
29. All soils should be characterised at least for texture [% sand, % silt, % clay according to FAO and USDA classification systems (14)], pH, cation exchange capacity, organic carbon content, bulk density (for disturbed soil) and water holding capacity. Measurement of microbial biomass is only required for the soil which is used in the ageing/incubation period carried

▼M6

out before the aged leaching experiment. Information on additional soil properties (e.g. soil classification, clay mineralogy, specific surface area) may be helpful for interpreting the results of this study. For determination of soil characteristics the methods recommended in references (15)(16)(17)(18)(19) can be used.

Collection and storage of soils

30. The soils should be taken from the top layer (A-horizon) to a maximum depth of 20 cm. Remains of vegetation, macro-fauna and stones should be removed. The soils (except those used for ageing the test chemical) are air-dried at room temperature (preferably between 20-25 °C). Disaggregation should be performed with minimal force, so that the original texture of the soil will be changed as little as possible. The soils are sieved through a ≤ 2 mm sieve. Careful homogenisation is recommended, as this enhances the reproducibility of the results. Before use the soils can be stored at ambient temperature and kept air dried (12). No limit on storage time is recommended but soils stored for more than 3 years should be re-analysed prior to use with respect to their organic carbon content and pH.

31. Detailed information on the history of the field sites from where the test soils are collected should be available. Details include exact location [exactly defined by UTM (Universal Transversal Mercator-Projection/European Horizontal Datum) or geographical co-ordinates], vegetation cover, treatments with crop protection chemicals, treatments with organic and inorganic fertilisers, additions of biological materials or accidental contamination (12). If soil has been treated with the test chemical or its structural analogues within the previous four years, these soils should not be used for leaching studies.

Test conditions

32. During the test period, the soil leaching columns should be kept in the dark at ambient temperature as long as this temperature is maintained within a range of ± 2 °C. Recommended temperatures are between 18 and 25 °C.

33. Artificial rain (0,01 M CaCl₂) should be applied continuously to the surface of the soil columns at a rate of 200 mm over a period of 48 hours⁽¹⁾; this rate is equivalent to an application of 251 ml for a column with an inner diameter of 4 cm. If needed for the purpose of the test, other rates of artificial rainfall and longer duration may additionally be used.

*Performance of the test**Leaching with parent test chemical*

34. At least duplicate leaching columns are packed with untreated, air-dried and sieved soil (< 2 mm) up to a height of approximately 30 cm. To obtain uniform packing, the soil is added to the columns in small portions with a spoon and pressed with a plunger under simultaneous gentle column vibration until the top of the soil column does not sink in further. Uniform packing is required for obtaining reproducible results from

⁽¹⁾ This simulates an extremely high rainfall. The average yearly rainfall, for example, in Central Europe is of the order of 800-1 000 mm.

▼ **M6**

leaching columns. For details on column packing techniques, see references (20) (21) and (22). To control the reproducibility of the packing procedure, the total weight of the soil packed in the columns is determined ⁽¹⁾; the weights of the duplicate columns should be similar.

35. After packing, the soil columns are pre-wetted with artificial rain (0,01 M CaCl₂) from bottom to top in order to displace the air in the soil pores by water. Thereafter the soil columns are allowed to equilibrate and the excess water is drained off by gravity. Methods for column saturation are reviewed in reference (23).

36. Then the test chemical and/or the reference chemical are applied to the soil columns (see also paragraphs 23-25). To obtain a homogeneous distribution the solutions, suspensions or emulsions of the test and/or reference chemical should be applied evenly over the surface of the soil columns. If incorporation into soil is recommended for the application of a test chemical, it should be mixed in a small amount (e.g. 20 g) of soil and added to the surface of the soil column.

37. The surfaces of the soil columns are then covered by a glass sinter disk, glass pearls, glass fibre filters or a round filter paper to distribute the artificial rain evenly over the entire surface and to avoid disturbance of the soil surface by the rain drops. The larger the column diameter the more care is needed for the application of the artificial rain to the soil columns to ensure an even distribution of the artificial rain over the soil surface. Then the artificial rainfall is added to the soil columns drop-wise with the aid of a piston or a peristaltic pump or a dropping funnel. Preferably, the leachates should be collected in fractions and their respective volumes are recorded ⁽²⁾.

38. After leaching and allowing the columns to drain, the soil columns are sectioned in an appropriate number of segments depending on the information required from the study, the segments are extracted with appropriate solvents or solvent mixtures and analysed for the test chemical and, when appropriate, for transformation products, for total radioactivity and for the reference chemical. The leachates or leachate fractions are analysed directly or after extraction for the same products. When radio-labelled test chemical is used, all fractions containing $\geq 10\%$ of the applied radioactivity should be identified.

Leaching with aged residues

39. Fresh soil (not previously air-dried) is treated at a rate corresponding to the surface area of the soil columns (see paragraph 24) with the radio-labelled test chemical and incubated under aerobic conditions according to Test Method C.23 (13). The incubation (ageing) period should be long enough

⁽¹⁾ Examples of bulk densities for disturbed soils are as follows: for a sand soil $1,66 \text{ g} \cdot \text{ml}^{-1}$
for a loam soil $1,17 \text{ g} \cdot \text{ml}^{-1}$
for a loamy sand soil $1,58 \text{ g} \cdot \text{ml}^{-1}$
for a silt soil $1,11 \text{ g} \cdot \text{ml}^{-1}$

⁽²⁾ Typical leachate volumes range from 230-260 ml corresponding to approx. 92-104 % of total artificial rain applied (251 ml) when using soil columns of 4 cm diameter and 30 cm length.

▼ M6

to produce significant amounts of transformation products; an ageing period of one half-life of the test chemical is recommended⁽¹⁾, but should not exceed 120 days. Prior to leaching, the aged soil is analysed for the test chemical and its transformation products.

40. The leaching columns are packed up to a height of 28 cm with the same soil (but air-dried) as used in the ageing experiment as described in paragraph 34 and the total weight of the packed soil columns is also determined. The soil columns are then pre-wetted as described in paragraph 35.
41. Then the test chemical and its transformation products are applied to the surface of the soil columns in the form of aged soil residues (see paragraph 39) as a 2 cm soil segment. The total height of the soil columns (untreated soil + aged soil) should preferably not exceed 30 cm (see paragraph 34).
42. The leaching is carried out as described in paragraph 37.
43. After leaching, soil segments and leachates are analysed as indicated in paragraph 38 for the test chemical, its transformation products and not-extracted radioactivity. To determine how much of the aged residue is retained in the top 2-cm layer after leaching, this segment should be analysed separately.

DATA AND REPORTING**Treatment of results**

44. The amounts of test chemical, transformation products, non-extractables and, if included, of the reference chemical should be given in % of applied initial dose for each soil segment and leachate fraction. A graphical presentation should be given for each column plotting the percentages found as a function of the soil depths.
45. When a reference chemical is included in these column leaching studies, the leaching of a chemical can be evaluated on a relative scale using relative mobility factors (RMF; for definition see Appendix 3) (1)(11) which allows the comparison of leaching data of various chemicals obtained with different soil types. Examples of RMF-values for a variety of crop protection chemicals are given in Appendix 3.
46. Estimates of K_{oc} (organic carbon normalised adsorption coefficient) and K_{om} (organic matter normalised distribution coefficient) can also be obtained from column leaching results by using average leaching distance or established correlations between RMF and K_{om} respectively K_{oc} (4) or by applying simple chromatographic theory (24). However, the latter method should be used with caution especially when considering that the leaching process does not solely involve saturated flow conditions, but rather unsaturated systems.

⁽¹⁾ More than one major transformation product may be formed in soil which also may appear at different time points during a transformation study. In such cases, it may be necessary to conduct leaching studies with aged residues of different age.

▼ M6**Interpretation of results**

47. The column leaching studies described in this method allow determining the leaching or mobility potential in soil of the test chemical (in the parent leaching study) and/or its transformation products (in the aged residue leaching study). These tests do not quantitatively predict leaching behaviour under field conditions, but they can be used to compare the 'leachability' of one chemical with others whose leaching behaviour may be known (24). Likewise, they do not quantitatively measure the percentage of applied chemical that might reach ground water (11). However, the results of column leaching studies may assist in deciding whether additional semi-field or field testing has to be carried out for chemicals showing a high mobility potential in laboratory tests.

Test report

48. The report must include:

Test chemical and reference chemical (when used):

- common name, chemical name (IUPAC and CAS nomenclature), CAS number, chemical structure (indicating position of label when radio-labelled material is used) and relevant physical-chemical properties;
- purities (impurities) of test chemical;
- radiochemical purity of labelled chemical and specific activity (where appropriate).

Test soils:

- details of collection site;
- properties of soils, such as pH, organic carbon and clay content, texture and bulk density (for disturbed soil);
- soil microbial activity (only for soil used for ageing of test chemical);
- length of soil storage and storage conditions.

Test conditions:

- dates of the performance of the studies;
- length and diameter of leaching columns;
- total soil weight of soil columns;
- amount of test chemical and, if appropriate, reference chemical applied;
- amount, frequency and duration of application of artificial rain;
- temperature of experimental set-up;
- number of replications (at least two);
- methods for analysis of test chemical, transformation products and, where appropriate, of reference chemical in the various soil segments and leachates;
- methods for the characterisation and identification of transformation products in the soil segments and leachates.

▼ M6*Test results:*

- tables of results expressed as concentrations and as % of applied dose for soil segments and leachates;
- mass balance, if appropriate;
- leachate volumes;
- leaching distances and, where appropriate, relative mobility factors;
- graphical plot of % found in the soil segments versus depth of soil segment;
- discussion and interpretation of results.

LITERATURE

- (1) Guth, J.A., Burkhard, N. and Eberle, D.O. (1976). Experimental Models for Studying the Persistence of Pesticides in Soil. Proc. BCPC Symposium: Persistence of Insecticides and Herbicides.
- (2) Russel, M.H. (1995). Recommended approaches to assess pesticide mobility in soil. In progress in Pesticide Biochemistry and Toxicology, Vol. 9 (Environmental Behaviour of Agrochemicals — T.R. Roberts and P.C. Kearney, Eds.). J. Wiley & Sons.
- (3) Briggs, G.G. (1981). Theoretical and experimental relationships between soil adsorption, octanol-water partition coefficient, water solubilities, bioconcentration factors, and the parachor. J.Agric. Food Chem. 29, 1050-1059.
- (4) Chiou, C.T., Porter, P.E. and Schmedding, D.W. (1983). Partition equilibria of non-ionic organic compounds between soil organic matter and water. Environ. Sci. Technol. 17, 227-231.
- (5) Guth, J.A. (1983). Untersuchungen zum Verhalten von Pflanzenschutzmitteln im Boden. Bull. Bodenkundliche Gesellschaft Schweiz 7, 26-33.
- (6) US-Environmental Protection Agency (1982). Pesticide Assessment Guidelines, Subdivision N. Chemistry: Environmental Fate.
- (7) Agriculture Canada (1987). Environmental Chemistry and Fate Guidelines for registration of pesticides in Canada.
- (8) Annex I to Commission Directive 95/36/EC of 14 July 1995 amending Council Directive 91/414/EEC concerning the placing of plant protection products on the market, OJ L 172, 22.7.1995, p. 8.
- (9) Dutch Commission for Registration of Pesticides (1991). Application for registration of a pesticide. Section G: Behaviour of the product and its metabolites in soil, water and air.
- (10) BBA (1986). Richtlinie für die amtliche Prüfung von Pflanzenschutzmitteln, Teil IV, 4-2. Versickerungsverhalten von Pflanzenschutzmitteln.
- (11) SETAC (1995). Procedures for Assessing the Environmental Fate and Ecotoxicity of Pesticides. Mark R. Lynch, Ed.
- (12) OECD (1995). Final Report of the OECD Workshop on Selection of Soils/ Sediments. Belgirate, Italy, 18-20 January 1995.
- (13) The following chapters of this Annex:
 - Chapter A.4, vapour pressure
 - Chapter A.6, Water solubility

▼ **M6**

Chapter A.8, Partition coefficient, shake flask method

Chapter A.24, Partition coefficient, HPLC method

Chapter C.7, degradation — abiotic degradation: hydrolysis as a function of pH

Chapter C.18, Adsorption/desorption using a batch equilibrium method

Chapter C.23, Aerobic and anaerobic transformation in soil

- (14) Soil Texture Classification (US and FAO systems). *Weed Science*, 33, Suppl. 1 (1985) and *Soil Sci. Soc. Amer. Proc.* 26, 305 (1962).
- (15) *Methods of Soil Analysis* (1986). Part 1, Physical and Mineralogical Methods (A. Klute, Ed.). Agronomy Series No. 9, 2nd Edition.
- (16) *Methods of Soil Analysis* (1982). Part 2, Chemical and Microbiological Properties (A.L. Page, R.H. Miller and D.R. Keelney, Eds.). Agronomy Series No. 9, 2nd Edition.
- (17) ISO Standard Compendium Environment (1994). *Soil Quality — General aspects; chemical and physical methods of analysis; biological methods of analysis*. First Edition.
- (18) Mückenhausen, E. (1975). *Die Bodenkunde und ihre geologischen, geomorphologischen, mineralogischen und petrologischen Grundlagen*. DLG-Verlag, Frankfurt/Main.
- (19) Scheffer, F. and Schachtschabel, P. (1998). *Lehrbuch der Bodenkunde*. F. Enke Verlag, Stuttgart.
- (20) Weber, J.B. and Peeper, T.F. (1977). In *Research Methods in Weed Science*, 2nd Edition (B. Truelove, Ed.). *Soc. Weed Sci.*, Auburn, Alabama, 73-78.
- (21) Weber, J.B., Swain, L.R., Streck, H.J. and Sartori, J.L. (1986). In *Research Methods in Weed Science*, 3rd Edition (N.D. Camper, Ed.). *Soc. Weed Sci.*, Champaign, IL, 190-200.
- (22) Oliveira, et al. (1996). Packing of sands for the production of homogeneous porous media. *Soil Sci. Soc. Amer. J.* 60(1): 49-53.
- (23) Shackelford, C. D. (1991). Laboratory diffusion testing for waste disposal. — A review. *J. Contam. Hydrol.* 7, 177-217.
- (24) Hamaker, J.W. (1975). Interpretation of soil leaching experiments. In *Environmental Dynamics of Pesticides* (R. Haque, V.H. Freed, Eds), 115-133. Plenum Press, New York.
- (25) OECD (1981). Dissociation constants in water. OECD Guideline for Testing of Chemicals, No. 4112, OECD, Paris

▼M6*Appendix 1***Definitions and units**

Aged soil residue: Test chemical and transformation products present in soil after application and following a period long enough to allow transport, adsorption, metabolism, and dissipation processes to alter the distribution and chemical nature of some of the applied chemical (1).

Artificial rain: 0,01 M CaCl₂ solution in distilled or deionised water.

Average Leaching Distance: Bottom of soil section where cumulative recovered chemical = 50 % of total recovered test chemical [normal leaching experiment], or; (bottom of soil section where cumulative recovered chemical = 50 % of total recovered test chemical) — ((thickness of aged residue layer)/2) [aged residue leaching study]

Chemical: a substance or a mixture.

Leachate: Aqueous phase percolated through a soil profile or a soil column (1).

Leaching: Process by which a chemical moves downward through the soil profile or a soil column (1).

Leaching distance: Deepest soil segment in which $\geq 0,5$ % of the applied test chemical or aged residue was found after the leaching process (equivalent to penetration depth).

Limit of detection (LOD) and limit of quantification (LOQ): The limit of detection (LOD) is the concentration of a chemical below which the identity of the chemical cannot be distinguished from analytical artefacts. The limit of quantification (LOQ) is the concentration of a chemical below which the concentration cannot be determined with an acceptable accuracy.

RMF Relative Mobility Factor: (leaching distance of test chemical (cm))/ (leaching distance of reference chemical (cm))

Test chemical: Any substance or mixture tested using this test method.

Transformation product: All chemicals resulting from biotic or abiotic transformation reactions of the test chemical including CO₂ and products that are bound in residues.

Soil: A mixture of mineral and organic chemical constituents, the latter containing compounds of high carbon and nitrogen content and of high molecular weights, populated by small (mostly micro-) organisms. Soil may be handled in two states:

— undisturbed, as it has developed with time, in characteristic layers of a variety of soil types;

— disturbed, as it is usually found in arable fields or as occurs when samples are taken by digging and used in this test method (2).

(1) Holland, P.T. (1996). Glossary of Terms Relating to Pesticides. IUPAC Reports on Pesticide (36). Pure & Appl. Chem. 68, 1167-1193.

(2) OECD Test Guideline 304 A: Inherent Biodegradability in Soil (adopted 12 May 1981).

▼ M6

Appendix 2

Figure 1

Example of non- sectionable leaching columns made of glass

With a length of 35 cm and an inner diameter of 5 cm (1)

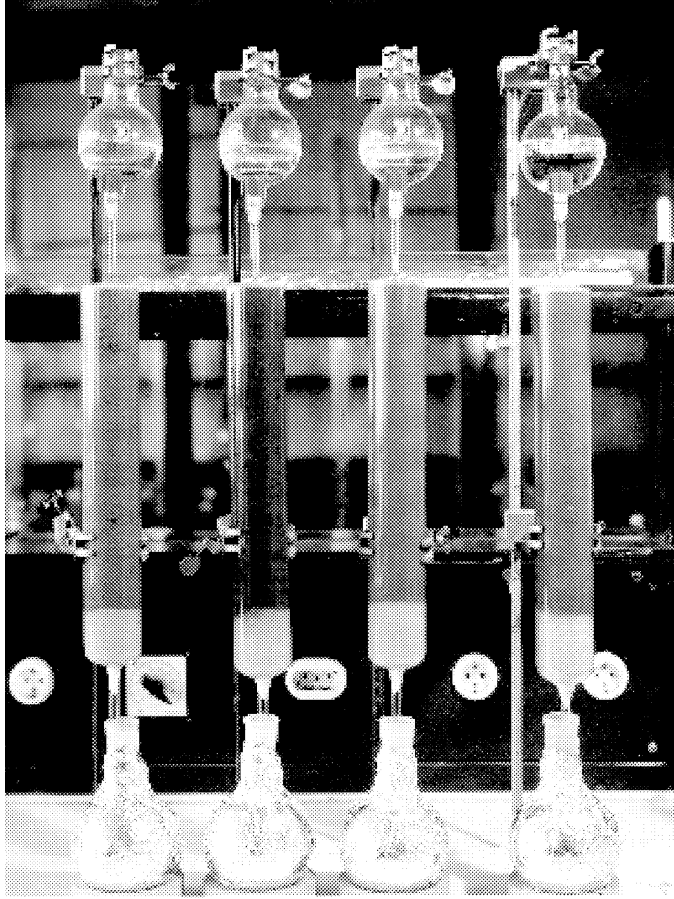

← Dropping funnels for application of artificial rain

← Glass sinter disc to avoid disturbance of the soil surface and to evenly distribute the artificial rain

← Glass column filled with test soil (when testing photolabile products columns should be wrapped in aluminium foil)

← Layer of quartz sand surface

← Glass wool plug to keep the soil in the column

← Round-bottom flask for collection of leachate; wrapped in aluminium foil to exclude photolysis

- (1) Drescher, N. (1985). Moderner Acker- und Pflanzenbau aus Sicht der Pflanzenschutzmittelindustrie. In Unser Boden — 70 Jahre Agrarforschung der BASF AG, 225-236. Verlag Wissenschaft und Politik, Köln.

▼ M6

Figure 2

Example of a sectionable metal column with 4 cm inner diameter (1)

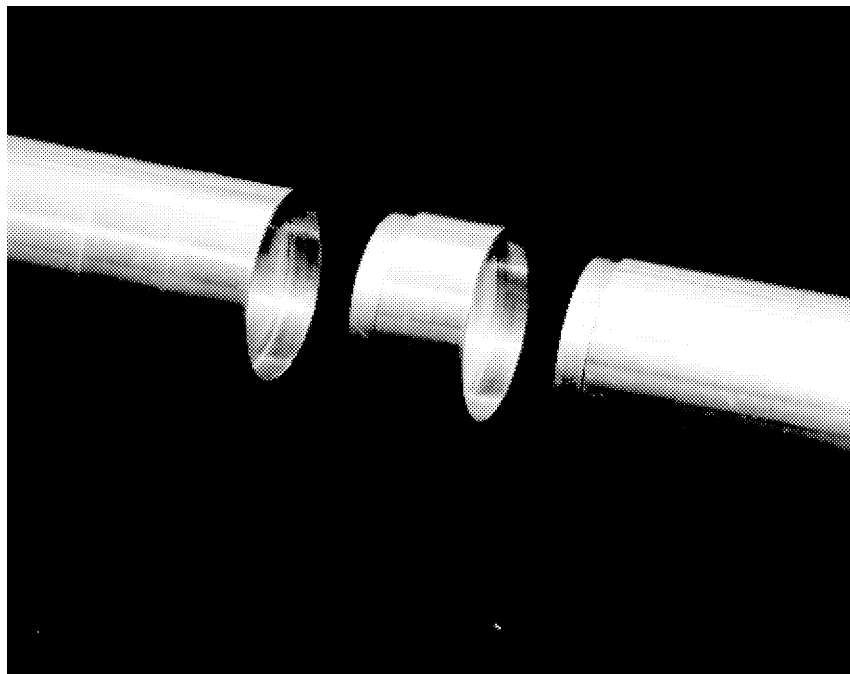

- (1) Burkhard, N., Eberle D.O. and Guth, J.A. (1975). Model systems for studying the environmental behaviour of pesticides. *Environmental Quality and Safety, Suppl. Vol. III*, 203-213.

▼ **M6**

Appendix 3

Examples of Relative Mobility Factors (*) (RMF) for a variety of Crop protection chemicals (1)(2) and corresponding mobility classes (+)

RMF-Range	Chemical (RMF)	Mobility Class
≤ 0,15	Parathion (< 0,15), Flurodifen (0,15)	I immobile
0,15 - 0,8	Profenophos (0,18), Propiconazole (0,23), Diazinon (0,28), Diuron (0,38), Terbutylazine (0,52), Methidathion (0,56), Prometryn (0,59), Propazine (0,64), Alachlor (0,66), Metolachlor (0,68)	II slightly mobile
0,8 - 1,3	Monuron (**) (1,00), Atrazine (1,03), Simazine (1,04), Fluometuron (1,18)	III moderately mobile
1,3 - 2,5	Prometon (1,67), Cyanazine (1,85), Bromacil (1,91), Karbutilate (1,98)	IV fairly mobile
2,5 - 5,0	Carbofuran (3,00), Dioxacarb (4,33)	V mobile
> 5,0	Monocrotophos (> 5,0), Dicrotophos (> 5,0)	VI very mobile

(*) The Relative Mobility Factor is derived as follows (3):

$$RMF = \frac{\text{leaching distance of test chemical(cm)}}{\text{leaching distance of reference chemical(cm)}}$$

(**) Reference chemical

+ Other systems to classify a chemical's mobility in soil are based on R_f values from soil thin-layer chromatography (4) and on K_{oc} values (5)(6).

- (1) Guth, J.A. (1985). Adsorption/desorption. In Joint International Symposium 'Physicochemical Properties and their Role in Environmental Hazard Assessment'. Canterbury, UK, 1-3 July 1985.
- (2) Guth, J.A. and Hörmann, W.D. (1987). Problematik und Relevanz von Pflanzenschutzmittel-Spuren im Grund (Trink-) Wasser. Schr.Reihe Verein WaBoLu, 68, 91-106.
- (3) Harris, C.I. (1967). Movement of herbicides in soil. Weeds 15, 214-216.
- (4) Helling, C.S. (1971). Pesticide mobility in soils. Soil Sci. Soc. Am. Proc. 35, 743-748.
- (5) McCall, P.J., Laskowski, D.A., Swann, R.L. and Dishburger, H.J. (1981). Measurements of sorption coefficients of organic chemicals and their use in environmental fate analysis. In Test Protocols for Environmental Fate and Movement of Toxicants. Proceedings of AOAC Symposium, AOAC, Washington D.C.
- (6) Hollis, J.M. (1991). Mapping the vulnerability of aquifers and surface waters to pesticide contamination at the national/regional scale. BCPC Monograph No. 47 Pesticides in Soil and Water, 165-174.

▼M6**C.45. ESTIMATION OF EMISSIONS FROM PRESERVATIVE — TREATED WOOD TO THE ENVIRONMENT: LABORATORY METHOD FOR WOODEN COMMODITIES THAT ARE NOT COVERED AND ARE IN CONTACT WITH FRESH WATER OR SEAWATER**

INTRODUCTION

1. This test method is equivalent to OECD test guideline (TG) 313 (2007). The emissions from preservative-treated wood to the environment need to be quantified to enable an environmental risk assessment of the treated wood. This test method describes a laboratory method for the estimation of emissions from preservative-treated wood in two situations where emissions could enter the environment:
 - Emissions from treated wood in contact with fresh water. Emissions from the surface of the treated wood could enter the water.
 - Emissions from treated wood in contact with seawater. Emissions from the surface of the treated wood could enter the seawater.
2. This test method is intended for testing the emissions from wood and wooden commodities that are not covered and are in contact with fresh water or seawater. Use Classes are used internationally and categorise the biological hazard to which the treated commodity will be subjected. Use Classes also define the situation in which the treated commodity is used and determine the environmental compartments (air, water, soil) which are potentially at risk from the preservative treated wood.
3. The test method is a laboratory procedure for obtaining samples (emissate) from water used to immerse treated wood, at increasing time intervals after exposure. The quantity of emissions in the emissate is related to the surface area of the wood and the length of exposure, to estimate a flux in mg/m²/day. The flux (leaching rate) after increasing periods of exposure can thus be estimated.
4. The quantity of emissions can be used in an environmental risk assessment of the treated wood.

INITIAL CONSIDERATIONS

5. The mechanism of leaching at the wood surface by fresh water is not assumed to be identical in nature and severity to leaching from a wood surface by seawater. Thus, for wood preservative products or mixtures used to treat wood used in seawater environs, a wood leaching study for seawater is necessary.
6. The wood, in the case of wood treated with a wood preservative, should be representative of commercially used wood. It should be treated in accordance with the preservative manufacturer's instructions and in compliance with appropriate standards and specifications. The parameters for the post treatment conditioning of the wood prior to the commencement of the test should be stated.
7. The wood samples used should be representative of the commodities used (e.g., with regard to species, density and other characteristics).

▼ M6

8. The test can be applied to wood using a penetrating process or superficial application or to treated wood which has an additional mandatory surface treatment (e.g., paint that is applied as a requirement for commercial use).
9. The composition, amount, pH and the physical form of water is important in determining the quantity, content and nature of emissions from wood.

PRINCIPLE OF THE TEST METHOD

10. Preservative-treated wood test specimens are immersed in water. The water (emissate) is collected and chemically analysed multiple times over the exposure period sufficient to perform statistical calculations. Emission rates in mg/m²/day are calculated from analytical results. The sampling periods should be recorded. Tests with untreated samples can be discontinued if there is no background detected in the first three data points.
11. The inclusion of untreated wood specimens allows for the determination of background levels for emissates from wood other than the preservative used.

QUALITY CRITERIA**Accuracy**

12. The accuracy of the test method to estimate emission depends upon the test specimens being representative of commercially treated wood, how representative the water is of real water and how the exposure regime is representative of natural conditions.
13. The accuracy, precision and repeatability of the analytical method should be determined before conducting the test.

Reproducibility

14. Three water samples are collected and analysed and the mean value is taken as the emission value. The reproducibility of the results within one laboratory and between different laboratories depends upon the immersion regime and the wood used as test specimens.

Acceptable Range of Results

15. A range of results from this test where the upper and lower values differ by less than one order of magnitude is acceptable.

TEST CONDITIONS**Water**

16. Freshwater leaching scenarios: Deionised water (e.g., ASTM D 1193 Type II) is recommended for use in the leaching test when wood exposed to freshwater is to be evaluated. The water temperature shall be 20 °C +/- 2 °C and the measured pH and water temperature included in the test report. Analysis of samples of the water used taken before immersion of the treated specimens allows the estimation of the analysed chemicals in the water. This is a control to determine background levels of chemicals which are then chemically analysed.

▼ M6

17. Seawater leaching scenarios: Synthetic seawater (e.g., ASTM D 1141 Substitute Ocean Water, without Heavy Metals) is recommended for use in the leaching test when wood exposed to seawater is to be evaluated. The water temperature shall be 20 °C +/- 2 °C and the measured pH and water temperature included in the test report. Analysis of samples of the water used taken before immersion of the treated specimens allows the estimation of the analysed chemicals in the water. This is a control for the analysis of background levels for chemicals of importance.

Wood Test Specimens

18. The wood species should be typical of the wood species used for the efficacy testing of wood preservatives. The recommended species are *Pinus sylvestris* L. (Scots pine), *Pinus resinosa* Ait. (red pine) or *Pinus spp* (Southern pine). Additional tests may be made using other species.
19. Straight grained wood without knots should be used. Material of a resinous appearance should be avoided. The wood should be typical of wood which is available commercially. The source, density and number of annual rings per 10 mm should be recorded.
20. Wood test specimens are recommended to be sets of five according to EN 113 size blocks (25 mm × 50 mm × 15 mm dimensions) with the longitudinal faces parallel to the grain of the wood, although other dimensions such as 50 mm, by 150 mm, by 10 mm may be used. The test specimen should be completely immersed into the water. Test specimens shall consist of 100 % sapwood. Each specimen is uniquely marked so that it can be identified throughout the test.
21. All test specimens should be planed or plane sawn and the surfaces should not be sanded.
22. The number of sets of wood test specimens used for analysing is at least five: three sets of specimens are treated with preservative, one set of specimens is untreated and one set of specimens for the estimation of the oven dry moisture content of the test specimens before treatment. Sufficient test specimens are prepared to allow selection of three sets of specimens which are within 5 % of the mean value of the preservative retentions of the pool of test specimens.
23. All test specimens are end-sealed with a chemical which prevents penetration of preservative into the end grain of the specimens or prevents leaching from the specimens via the end grain. It is necessary to distinguish between specimens used for superficial application and penetration processes for the application of the end-sealant. The application of the end-sealant has to be applied prior to treatment only in case of superficial application.
24. The end-grain has to be open for treatments by penetration processes. Therefore, the specimens have to be end-sealed at the end of the conditioning period. The emission has to be estimated for the longitudinal surface area only. Sealants should be inspected and reapplied if necessary prior to initiating leaching and should not be reapplied after leaching has been initiated.

▼ M6**Immersion Container**

25. The container is made of an inert material and is large enough to contain 5 EN113 wood specimens in 500 ml of water resulting in a surface area to water volume ratio of 0,4 cm²/ml.

Specimen Test Assembly

26. The test specimens are supported on an assembly which allows all exposed surfaces of the specimen to be in contact with water.

PROCEDURE FOR PRESERVATIVE TREATMENT**Preparation of the Treated Test Specimens**

27. The wood test specimen to be treated with the preservative under test is treated by the method specified for the preservative, which may be by a penetrating treatment process or a superficial application process, which may be with a dip, spray or brush.

Preservatives to be applied by penetrating treatment process

28. A solution of the preservative should be prepared that will achieve the specified uptake or retention when applied using the penetrating treatment process. The wood test specimen is weighed and its dimensions are measured. The penetrating treatment process should be as specified for the application of the preservative to wood for use in Use Class 4 or 5. The specimen is again weighed after treatment and the retention of the preservative (kg/m³) is calculated from the equation:

$$\frac{\text{Mass after treatment(kg)} - \text{Mass before treatment(kg)}}{\text{Test specimen volume(m}^3\text{)}} \times \frac{\text{Solution Concentration(\% mass/mass)}}{100}$$

29. Note that timber treated in an industrial treatment plant (e.g. by vacuum pressure impregnation) may be used in this test. The procedures used should be recorded and the retention of material treated in this way must be analysed and recorded.

Preservatives to be applied by superficial application processes

30. The superficial application process includes dipping, spraying or brushing of the wood test specimens. The process and application rate (e.g. litres/m²) should be as specified for the superficial application of the preservative.
31. Also note in this case, timber treated in an industrial treatment plant may be used in this test. The procedures used should be recorded and the retention of material treated in this way must be analysed and recorded.

Conditioning of the Test Specimens after Treatment

32. After treatment, the treated test specimens should be conditioned in accordance with the recommendations made by the supplier of the test preservative according to the preservative label requirements or as in accordance with commercial treatment practices or in accordance with EN 252 Standard.

▼ M6**Preparation and Selection of Test Specimens**

33. After post treatment conditioning, the mean retention of the group of test specimens is calculated and three representative sets of specimens with a retention within 5 % of the mean for the group are randomly selected for leaching measurements.

PROCEDURE FOR PRESERVATIVE EMISSION MEASUREMENTS

Immersion Method

34. The test specimens are weighed and subsequently totally immersed in the water and the date and time recorded. The container is covered to reduce evaporation.
35. The water is replaced at the following intervals: 6 hours, 1 day, 2 days, 4 days, 8 days, 15 days, 22 days, 29 days (note: these are total times not interval times). The time and date of the water change and the mass of water recovered from the container should be recorded.
36. After each water exchange, a sample of water in which the set of test specimens has been immersed is retained for subsequent chemical analysis.
37. The sampling procedure allows the calculation of the profile of the quantity of emissions against time. Samples should be stored under conditions that preserve the analyte e.g., in a refrigerator in the dark to reduce microbial growth in the sample before analysis.

EMISSION MEASUREMENTS

Treated Samples

38. Collected water is chemically analysed for the active substance and/or relevant degradation/transformation products, if appropriate.

Untreated Samples

39. Collection of the water (emissate) in this system and subsequent analysis of chemicals that had leached from the untreated wood samples allow the estimation of the possible emission rate of the preservative from untreated wood. Collection and analysis of the emissate after increasing time periods of exposure allow the rate of change of the emission rate with time to be estimated. This analysis is a control procedure to determine background levels of the test chemical in untreated wood to confirm that the wood used as a source of samples had not been previously treated with the preservative.

DATA AND REPORTING

Chemical Analyses

40. The collected water is chemically analysed and the water analysis result is expressed in appropriate units, e.g., µg/l.

Reporting of Data

41. All results are recorded. The Appendix shows an example of a suggested recording form for one set of treated test specimens, and the summary table for calculating the mean emission values over each sampling interval.
42. The daily emission flux in mg/m²/day is calculated by taking the mean of the three measurements from the three replicates and dividing by the number of days of immersion.

▼ M6**Test Report**

43. At least the following information shall be provided in the test report:
- The name of the supplier of the preservative under test;
 - The specific and unique name or code of the preservative tested;
 - The trade or common name of the active ingredient(s) with a generic description of the co-formulants (e.g. co-solvent, resin), and the composition in % m/m of the ingredients;
 - The relevant retention or loading (in kg/m^3 or l/m^2 , respectively) specified for wood used in contact with water;
 - The species of wood used, with its density, and growth rate in rings per 10 mm;
 - The loading or retention of the preservative tested and the formula used to calculate the retention, expressed as l/m^2 or kg/m^3 ;
 - The method of application of the preservative, specifying the treatment schedule used for a penetrating process, and the method of application if a superficial treatment was used;
 - The date of application of the preservative, and an estimate of the moisture content of the test specimens, expressed as a percentage;
 - Conditioning procedures used, specifying the type, conditions and duration;
 - Specification of the end sealant used and the number of times applied;
 - Specification of any subsequent treatment of the wood, e.g. specification of the supplier, type, characteristics and loading of a paint;
 - The time and date of each immersion event, the amount of water used for the immersion of the test specimens at each event, and the amount of water absorbed by the wood during immersion;
 - Any variation from the described method and any factors that may have influenced the results.

LITERATURE

- (1) European Standard, EN 84 — 1997. Wood preservatives. Accelerated ageing of treated wood prior to biological testing. Leaching procedure.
- (2) European Standard, EN 113/A1 — 2004. Wood preservatives. Test method for determining the protective effectiveness against wood destroying basidiomycetes. Determination of the toxic values.
- (3) European Standard, EN 252 — 1989. Field test method for testing the relative protective effectiveness of a wood preservative in ground contact.
- (4) European Standard, EN 335 — Part 1: 2006. Durability of wood and wood-based products — Definition of use classes — Part1: General.
- (5) American Society for Testing and Materials Standards, ASTM D 1141 — 1998. Standard Practice for the Preparation of Substitute Ocean Water, Without Heavy Metals. *Annual Book of ASTM Standards*, Volume 11.02.
- (6) American Society for Testing and Materials Standards, ASTM D 1193-77 Type II — 1983. Specifications for Reagent Water. *Annual Book of ASTM Standards*, Volume 11.01.

▼ **M6***Appendix 1***Recording form for test method****Estimation of Emissions from Preservative-Treated Wood to the Environment: Laboratory Method for Wooden Commodities that are not Covered and are in Contact with Fresh Water or Seawater**

Test house	
Wood preservative	
Supplier of the preservative	
Specific and unique name or code of the preservative	
Trade or common name of the preservative	
Co-formulants	
Relevant retention for wood used in contact with water	
Application	
Application method	
Date of application	
Formula used to calculate the retention:	
Conditioning procedure	
Duration of conditioning	
End sealant/number of times applied	
Subsequent treatment	if relevant
Test specimens	
Wood species	
Density of the wood	(minimum ... mean value ... maximum)
Growth rate (rings per 10 mm)	(minimum ... mean value ... maximum)
Moisture content	

▼ M6

Test assemblies (*)	Retention (e.g. kg/m³)
Treated 'x'	Mean value and standard deviation or range for 5 specimens
Treated 'y'	Mean value and standard deviation or range for 5 specimens
Treated 'z'	Mean value and standard deviation or range for 5 specimens
Untreated	
Variation of test method parameters	e.g. water quality, dimension of test specimens etc.

(*) x, y, z represent the three replicate samples

▼ **M6**

Time	Water exchange	Specimen mass		Water uptake		Water sample				
		Treated (mean)	Untreated	Treated (mean)	Untreated		Test water	x	y	z
	Date	g	g	g	g	no.	pH	pH	pH	pH
start										
6h						1				
24h						2				
2 d						3				
4 d						4				
8 d						5				
15 d						6				
22 d						7				
29 d						8				

▼ **M6**

Please prepare separate tables for each active ingredient

Time	Water exchange	Analytical Results														
		Untreated specimens			Treated specimens											
		Concentration a.i. in water mg/l	Quantity emitted mg/m ²	Emission rate mg/m ² /d	Concentration a.i. in water				Quantity emitted				Emission rate			
					x	y	z	Mean	x	y	z	Mean	x	y	z	Mean
Date				mg/l	mg/l	mg/l	mg/l	mg/m ²	mg/m ²	mg/m ²	mg/m ²	mg/m ² /d	mg/m ² /d	mg/m ² /d	mg/m ² /d	
6h																
24h																
2 d																
4 d																
8 d																
15 d																
22 d																
29 d																

Note: Since results from untreated may have to be used to correct emission rates from treated samples, the untreated results should come first and all values for treated samples would be ‘corrected values’. There may also be a correction for the initial water analysis.

▼ **M6**

Appendix 2

Definitions

Chemical: A substance or a mixture.

Test chemical: Any substance or mixture tested using this test method.

▼M6**C.46. BIOACCUMULATION IN SEDIMENT-DWELLING BENTHIC OLIGOCHAETES**

INTRODUCTION

1. This test method is equivalent to OECD test guideline (TG) 315 (2008) Sediment-ingesting endobenthic animals may be exposed to sediment bound substances (1). Among these sediment-ingesters, aquatic oligochaetes play an important role in the bottoms of the aquatic systems. They live in the sediment and often represent the most abundant species especially in habitats with environmental conditions adverse to other animals. By bioturbation of the sediment and by serving as prey these animals can have a strong influence on the bioavailability of such substances to other organisms, e.g. benthivorous fish. In contrast to epibenthic organisms, endobenthic aquatic oligochaetes burrow in the sediment, and ingest sediment particles below the sediment surface. Because of that, these organisms are exposed to substances via many uptake routes including direct contact, ingestion of contaminated sediment particles, porewater and overlying water. Some species of benthic oligochaetes that are currently used in ecotoxicological testing are described in Appendix 6.
2. The parameters which characterise the bioaccumulation of a substance include first of all the bioaccumulation factor (BAF), the sediment uptake rate constant (k_s) and the elimination rate constant (k_e). Detailed definitions of these parameters are provided in Appendix 1.
3. To assess the bioaccumulation potential of substances in general, and to investigate the bioaccumulation of substances which tend to partition into or onto the sediments, a compartment-specific test method is needed (1)(2)(3)(4).
4. This test method is designed to assess bioaccumulation of sediment-associated substances in endobenthic oligochaete worms. The test substance is spiked into the sediment. Using spiked sediment is intended to simulate a contaminated sediment.
5. This method is based on existing sediment toxicity and bioaccumulation test methods (1)(4)(5)(6)(7)(8)(9). Other useful documents are: the discussions and results of an international workshop (11), and the outcome of an international ring test (12).
6. This test applies to stable, neutral organic substances, which tend to associate with sediments. Bioaccumulation of sediment-associated, stable metallo-organic compounds can also be measured with this method (12). It is not applicable to metals and other trace elements (11) without modification of the test design with respect to substrate and water volumes, and possibly tissue sample size.

PREREQUISITE AND INFORMATION ON TEST SUBSTANCE

7. There are only a few well established Quantitative Structure-Activity Relationships (QSAR) concerning bioaccumulation processes presently available (14). The most widely used relationship is the correlation between the bioaccumulation and bioconcentration of stable organic substances and their lipophilicity (expressed as the logarithm of the octanol-water partition coefficient ($\log K_{ow}$); see Appendix 1 for definition), respectively, which has been developed for the description of a substance partitioning between water

▼ M6

and fish. Correlations for the sediment compartment have also been established using this relationship (15)(16)(17)(18). The log K_{ow} -log BCF correlation as a major QSAR may be helpful for a first preliminary estimation of the bioaccumulation potential of sediment-associated substances. However, the BAF may be influenced by lipid content of the test organism and the organic carbon content of the sediment. Therefore the organic carbon-water partition coefficient (K_{oc}) may also be used as a major determinant of the bioaccumulation of sediment-associated organic substances.

8. This test is applicable to:
 - stable, organic substances having log K_{ow} values between 3,0 and 6,0 (5)(19) and superlipophilic substances that show a log K_{ow} of more than 6,0 (5);
 - substances which belong to a class of organic substances known for their bioaccumulation potential in living organisms, e.g. surfactants or highly adsorptive substances (e.g. high K_{oc}).

9. Information on the test substance such as safety precautions, proper storage conditions and stability, and analytical methods should be obtained before beginning the study. Guidance for testing substances with physical-chemical properties that make them difficult to test is provided in (20) and (21). Before carrying out a test for bioaccumulation with aquatic oligochaetes, the following information about the test substance should be known:
 - common name, chemical name (preferably IUPAC name), structural formula, CAS registry number, purity;
 - solubility in water [test method A.6 (22)];
 - octanol-water partition coefficient, K_{ow} [test methods A.8, A.24 (22)];
 - sediment-water partition coefficient, expressed as K_d or K_{oc} [test method C.19 (22)];
 - hydrolysis [test method C.7 (22)];
 - phototransformation in water (23);
 - vapour pressure [test method A.4 (22)];
 - ready biodegradability [test methods C.4 and C.29 (22)];
 - surface tension [test method A.5 (22)];
 - critical micelles concentration (24).

In addition the following information — when available- would be relevant:

- biodegradation in the aquatic environment [test methods C.24 and C.25 (22)];
 - Henry's law constant.
10. Radiolabelled test substances can facilitate the analysis of water, sediment and biological samples, and may be used to determine whether identification and quantification of degradation products should be made. The method described here was validated in an international ring test (12) for ^{14}C -labelled substances. If total radioactive residues are measured, the bioaccumulation factor (BAF) is based on the parent substance including any retained degradation products. It is also possible to combine a metabolism study with a bioaccumulation study by analysis and quantification of the percentage of parent substance and its degradation products in samples taken

▼ M6

at the end of the uptake phase or at the peak level of bioaccumulation. In any case, it is recommended that BAF calculation be based on the concentration of the parent substance in the organisms and not only on total radioactive residues.

11. In addition to the properties of the test substance, other information required is the toxicity to the oligochaete species to be used in the test, such as a median lethal concentration (LC₅₀) for the time necessary for the uptake phase, to ensure that selected exposure concentrations are much lower than toxic levels. If available, preference should be given to toxicity values derived from long-term studies on sublethal endpoints (EC₅₀). If such data are not available, an acute toxicity test under conditions identical with the bioaccumulation test conditions, or toxicity data on other surrogate species data may provide useful information.
12. An appropriate analytical method of known accuracy, precision, and sensitivity for the quantification of the substance in the test solutions, in the sediment, and in the biological material must be available, together with details of sample preparation and storage as well as material safety data sheets. Analytical detection limits of the test substance in water, sediment, and worm tissue should also be known. If a radiolabelled test substance is used, the specific radioactivity (i.e. Bq mol⁻¹), the position of the radiolabelled atom, and the percentage of radioactivity associated with impurities must also be known. The specific radioactivity of the test substance should be as high as possible in order to detect test concentrations as low as possible (11).
13. Information on characteristics of the sediment to be used (e.g. origin of sediment or its constituents, pH and ammonia concentration of the pore water (field sediments), organic carbon content (TOC), particle size distribution (per cent sand, silt, and clay), and per cent dry weight) should be available (6).

PRINCIPLE OF THE TEST

14. The test consists of two phases; the uptake (exposure) phase and the elimination (post-exposure) phase. During the uptake phase, worms are exposed to sediment spiked with the test substance, topped with reconstituted water and equilibrated as appropriate (11). Groups of control worms are held under identical conditions without the test substance.
15. For the elimination phase the worms are transferred to a sediment-water-system free of test substance. An elimination phase is necessary to gain information on the rate at which the test substance is excreted by the test organisms (19)(25). An elimination phase is always required unless uptake of the test substance during the exposure phase has been insignificant (e.g. there is no statistical difference between the concentration of the test substance in test and control worms). If a steady state has not been reached during the uptake phase, determination of the kinetics — BAF_k, uptake and elimination rate constant(s) — may be done using the results of the elimination phase. Change of the concentration of the test substance in/on the worms is monitored throughout both phases of the test.
16. During the uptake phase, measurements are made until BAF has reached a plateau or steady state. By default, the duration of the uptake phase should be 28 days. Practical experience has shown that a 12 to 14-day uptake phase is sufficient for several stable, neutral organic substances to reach steady-state (6)(8)(9).

▼ **M6**

17. However, if the steady state is not reached within 28 d, the elimination phase is started by transferring exposed oligochaetes to vessels containing the same medium without the test substance. The elimination phase is terminated when either the 10 % level of the concentration measured in the worms on day 28 of the uptake phase is reached, or after a maximum duration of 10 d. The residue level in the worms at the end of the elimination phase is reported as an additional endpoint, e.g. as Non-eliminated residues (NER). The bioaccumulation factor (BAF_{ss}) is calculated preferably both as the ratio of concentration in worms (C_a) and in the sediment (C_s) at apparent steady state, and as a kinetic bioaccumulation factor, BAF_K as the ratio of the rate constant of uptake from sediment (k_s) and the elimination rate constant (k_e) assuming first-order kinetics. If a steady state is not reached within 28 days, calculate BAF_K from the uptake rate and elimination rate constant(s). For calculation see Appendix 2. If first-order kinetics are not applicable, more complex models should be employed (Appendix 2 and reference (25)).
18. If a steady state is not achieved within 28 days, the uptake phase may optionally be extended subjecting groups of exposed worms — if available — to further measurements until steady state is reached; in parallel, the elimination phase should nevertheless be started on day 28 of the uptake phase.
19. The uptake rate constant, the elimination rate constant (or constants, where more complex models are involved), the kinetic bioaccumulation factor (BAF_K), and where possible, the confidence limits of each of these parameters are calculated from computerised model equations (see Appendix 2 for models). The goodness of fit of any model can be determined from the correlation coefficient or the coefficient of determination (coefficients close to 1 indicate a good fit).
20. To reduce variability in test results for organic substances with high lipophilicity, bioaccumulation factors should be expressed additionally in relation to the lipid content of the test organisms and to the organic carbon content (TOC) in the sediment (biota-sediment accumulation factor or BSAF in $\text{kg sediment TOC kg}^{-1}$ worm lipid content). This approach is based on experiences and theoretical correlations for the aquatic compartment, where — for some chemical classes — there is a clear relationship between the potential of a substance to bioaccumulate and its lipophilicity, which has been well established for fish as model organisms (14)(25)(27). There is also a relationship between the lipid content of the test fish and the observed bioaccumulation of such substances. For benthic organisms, similar correlations have been found (15)(16)(17)(18). If sufficient worm tissue is available, the lipid content of the test animals may be determined on the same biological material as the one used to determine the concentration of the test substance. However, it is practical to use acclimatised control animals at least at start or — preferably — at the end of the uptake phase to measure the lipid content, which can then be used to normalise the BAF values.

VALIDITY OF THE TEST

21. For a test to be valid the following conditions apply:
- The cumulative mortality of the worms (controls and treatments) until the end of the test should not exceed 20 % of the initial number.
 - In addition, it should be demonstrated that the worms burrow in the sediment to allow for maximum exposure. For details see paragraph 28.

▼ M6

DESCRIPTION OF THE METHOD

Test species

22. Several species of aquatic oligochaetes can be used for the test. The most commonly used species are listed in Appendix 6.

23. Toxicity tests (96 h, in water only) should be conducted at regular intervals (e.g. every month) with a reference toxicant such as potassium chloride (KCl) or copper sulfate (CuSO_4) (1) to demonstrate the health conditions of the test animals (1)(6). If reference toxicity tests are not conducted at regular intervals, the batch of organisms to be used in a sediment bioaccumulation test should be checked using a reference toxicant. Measurement of the lipid content might also provide useful information on the condition of the animals.

Culture of the test organisms

24. In order to have a sufficient number of worms for conducting bioaccumulation tests the worms may have to be kept in permanent single-species laboratory culture. Laboratory culture methods for the selected test species are summarised in Appendix 6. For details see references (8)(9)(10)(18)(28)(29)(30)(31)(32).

Apparatus

25. Care should be taken to avoid the use of materials for all parts of the equipment that can dissolve, absorb test substances or leach other substances and have an adverse effect on the test animals. Standard rectangular or cylindrical chambers, made of chemically inert material and of suitable capacity in compliance with the loading rate, i.e. the number of test worms can be used. The use of soft plastic tubing for administering water or air should be avoided. Polytetrafluoroethylene, stainless steel and/or glass should be used for any equipment having contact with the test media. For substances with high adsorption coefficients, such as synthetic pyrethroids, silanised glass may be required. In these situations the equipment will have to be discarded after use (5). For radiolabelled test substances, and for volatile substances, care should be taken to avoid stripping and the escape of stripped test substance. Traps (e.g. glass gas washing bottles) containing suitable absorbents to retain any residues evaporating from the test chambers should be employed (11).

Water

26. The overlying water must be of a quality that will allow the survival of the test species for the duration of the acclimation and test periods without them showing any abnormal appearance or behaviour. Reconstituted water according to test method C.1 (25) is recommended for use as overlying water in the tests as well as in the laboratory cultures of the worms. It has been demonstrated that several test species can survive, grow, and reproduce in this water (8), and maximum standardisation of test and culture conditions is provided. The water should be characterised at least by pH, conductivity and hardness. Analysis of the water for micro-pollutants prior to use might provide useful information (Appendix 4).

27. The water should be of constant quality during the period of a test. The pH of the overlying water should be between 6 and 9. The total hardness should be between 90 and 400 mg CaCO_3 per litre at the start of the test (7). Ranges for pH and hardness in the mentioned reconstituted water are given in test method C.1 (25). If there is an interaction suspected between

▼ M6

hardness ions and the test substance, lower hardness water should be used. Appendix 4 summarises additional criteria of an acceptable dilution water according to OECD TG 210 (34).

Sediment

28. The sediment must be of a quality that will allow the survival and preferably the reproduction of the test organisms for the duration of the acclimation and test periods without them showing any abnormal appearance or behaviour. The worms should burrow into the sediment. Burrowing behaviour can have an influence on the exposure, and consequently on the BAF. Therefore, sediment avoidance or burrowing behaviour of the test organisms should be recorded, where turbidity of the overlying water allows such observations. The worms (control and treatments) should burrow in the sediment within a period of 24 h after addition to the test vessels. If permanent burrowing failure or sediment avoidance are observed (e.g. more than 20 % over more than half of the uptake phase), this indicates that either the test conditions are not appropriate, or the test organisms are not healthy, or that the concentration of the test substance elicits this behaviour. In such a case the test should be stopped and repeated at improved conditions. Additional information on sediment ingestion can be obtained by using methods described in (35)(36), which specify sediment ingestion or particle selection in the test organisms. If observable, at least the presence or absence of fecal pellets on the sediment surface, which indicate sediment ingestion by the worms, should be recorded and considered for the interpretation of the test results with respect to exposure pathways.

29. An artificial sediment based on the artificial soil described in test method C.8 (40) is recommended for use in both the tests and the laboratory cultures of the worms (Appendix 5), since natural sediments of appropriate quality may not be available throughout the year. In addition, indigenous organisms as well as the possible presence of micropollutants in natural sediments might influence the test. Several test species can survive, grow, and reproduce in the artificial sediment (8).

30. The artificial sediment should be characterised at least by origin of the constituents, grain size distribution (percent sand, silt, and clay), organic carbon content (TOC), water content, and pH. Measurement of redox potential is optional. However, natural sediments from unpolluted sites may serve as test and/or culture sediment (1). Natural sediments should be characterised at least by origin (collection site), pH and ammonia of the pore water, organic carbon content (TOC), particle size distribution (percent sand, silt, and clay), and percent water content (6). It is recommended that, before it is spiked with the test substance, the natural sediment be conditioned for seven days under the same conditions which prevail in the subsequent test, if ammonia development is expected. At the end of this conditioning period, the overlying water should be removed and discarded. Analysis of the sediment or its constituents for micro-pollutants prior to use might provide useful information.

Preparation

31. Handling of natural sediments prior to their use in the laboratory is described in (1)(6)(44). The preparation of the artificial sediment is described in Appendix 5.

▼ M6*Storage*

32. The storage of natural sediments in the laboratory should be as short as possible. U.S. EPA (6) recommends a maximum storage period of 8 weeks at 4 ± 2 °C in the dark. There should be no headspace above the sediment in the storage containers. Recommendations for the storage of artificial sediment are given in Appendix 5.

Application of the test substance

33. The sediment is spiked with the test substance. The spiking procedure involves coating of one or more of the sediment constituents with the test substance. For example, the quartz sand, or a portion thereof (e.g. 10 g of quartz sand per test vessel), can be soaked with a solution of the test substance in a suitable solvent, which is then slowly evaporated to dryness. The coated fraction can then be mixed into the wet sediment. The amount of sand provided by the test-substance-and-sand mixture has to be taken into account when preparing the sediment, i.e. the sediment should thus be prepared with less sand (6).

34. With a natural sediment, the test substance may be added by spiking a dried portion of the sediment as described above for the artificial sediment, or by stirring the test substance into the wet sediment, with subsequent evaporating of any solubilising agent used. Suitable solvents for spiking wet sediment are ethanol, methanol, ethylene glycol monomethyl ether, ethylene glycol dimethyl ether, dimethylformamide and triethylene glycol (5)(34). Toxicity and volatility of the solvent and the solubility of the test substance in the chosen solvent should be the main criteria for the selection of a suitable solubilising agent. Additional guidance on spiking procedures is given in Environment Canada (1995)(41). Care should be taken to ensure that the test substance added to sediment is thoroughly and evenly distributed within the sediment. Replicated sub-samples of the spiked sediment should be analysed to check the concentrations of the test substance in the sediment, and to determine the degree of homogeneity of test substance distribution.

35. Once the spiked sediment with overlying water has been prepared, it is desirable to allow partitioning of the test substance between the sediment and the aqueous phase. This should preferably be done under the conditions of temperature and aeration used in the test. Appropriate equilibration time is sediment and substance specific, and can be in the order of hours to days and in rare cases up to several weeks (4-5 weeks) (28)(42). In this test, equilibrium is not awaited but an equilibration period of 48 hours to 7 days is recommended. Depending on the purpose of the study, e.g., when environmental conditions are to be mimicked, the spiked sediment may be equilibrated or aged for a longer period (11).

PERFORMANCE OF THE TEST**Preliminary test**

36. It may be useful to conduct a preliminary experiment in order to optimise the test conditions of the definitive test, e.g. selection of test substance concentration(s) and duration of the uptake and elimination phases. The behaviour of worms, for example sediment avoidance, i.e. the worms escape from the sediment which may be caused by the test substance and/or by the sediment itself, should be observed and recorded during a

▼M6

preliminary test. Sediment avoidance may also be used as a sub-lethal parameter in a preliminary test for estimating the test substance concentration(s) to be used in a bioaccumulation test.

Exposure conditions*Duration of the uptake phase*

37. The test organisms are exposed to the test substance during the uptake phase. The first sample should be taken between 4 and 24 h after start of uptake phase. The uptake phase should be run for up to 28 days (1)(6)(11) unless it can be demonstrated that equilibrium has been reached earlier. The steady state occurs when: (i) a plot of the bioaccumulation factors at each sampling period against time is parallel to the time axis; (ii) three successive analyses of BAF made on samples taken at intervals of at least two days vary no more than $\pm 20\%$ of each other; and (iii) there are no significant differences between the three sampling periods (based on statistical comparisons e.g. analysis of variance and regression analysis). If the steady state has not been reached by 28 days, the uptake phase may be ended by starting the elimination phase, and the BAF_K can be calculated from the uptake and elimination rate constants (see also paragraphs 16 to 18).

Duration of the elimination phase

38. The first sample should be taken between 4 and 24 h after start of elimination phase, since during the initial period, rapid changes in tissue residue may occur. It is recommended to terminate the elimination phase either when the concentration of test substance is less than 10 % of steady-state concentration, or after a maximum duration of 10 days. The residue level in the worms at the end of the elimination phase is reported as a secondary endpoint. The period may, however, be governed by the period over which the concentration of the test substance in the worms remains above the analytical detection limit.

Test organisms*Numbers of test worms*

39. The number of worms per sample must provide a mass of worm tissue such that the mass of test substance per sample at the beginning of the uptake phase and at the end of the elimination phase, respectively, is significantly higher than the detection limit for the test substance in biological material. In the mentioned stages of uptake and elimination phases the concentration in the test animals is usually relatively low (6)(8)(18). Since the individual weight in many species of aquatic oligochaetes is very low (5-10 mg wet weight per individual for *Lumbriculus variegatus* and *Tubifex tubifex*), the worms of a given replicate test chamber may be pooled for weighing and test chemical analysis. For test species with higher individual weight (e.g. *Branchiura sowerbyi*) replicates containing one individual may be used, but in such cases the number of replicates should be increased to five per sampling point (11). It should however be noted that *B. sowerbyi* was not included in the ring test (12), and is therefore not recommended as a preferable species in the method.
40. Worms of similar size should be used (for *L. variegatus* see Appendix 6). They should come from the same source, and should be adult or large animals of the same age class (see Appendix 6). The weight and age of an animal may have a significant effect on the BAF-values (e.g. due to different lipid content and/or presence of eggs); these parameters should be recorded accurately. To measure the mean wet and dry weight a subsample of worms should be weighed before starting the test.

▼ M6

41. With *Tubifex tubifex* and *Lumbriculus variegatus*, reproduction is expected during the test period. A lack of reproduction in a bioaccumulation test should be recorded, and considered when interpreting the test results.

Loading

42. High sediment-to-worm and water-to-worm ratios should be used in order to minimise the reduction of test substance concentration in the sediment during the uptake phase, and to avoid decreases in dissolved oxygen concentration. The chosen loading rate should also correspond to naturally occurring population densities of the chosen species (43). For example, for *Tubifex tubifex*, a loading rate of 1-4 mg of worm tissue (wet weight) per gram of wet sediment is recommended (8)(11). References (1) and (6) recommend a loading rate of ≤ 1 g dry weight of worm tissue per 50 g sediment organic carbon for *L. variegatus*.
43. The worms to be used in a test are removed from the culture by sieving the culture sediment. The animals (adult or large worms without signs of recent fragmentation) are transferred to glass dishes (e.g. petri dishes) containing clean water. If the test conditions differ from the culture conditions, an acclimation phase of 24 h should be sufficient. Prior to weighing, excess water should be removed from the worms. This can be done by gently placing the worms on a pre-moistened paper tissue. It is not recommended to use absorbing paper to dry the worms as this may cause stress or damage to the worms. Brunson et al. (1998) recommend using non-blotted worms of approximately 1,33 times the target biomass. These additional 33 % correspond to the difference between blotted and non-blotted worms (28).
44. At the start of the uptake phase (day 0 of the test), the test organisms are removed from the acclimatisation chamber and distributed randomly to vessels (e.g. petri dishes) containing reconstituted water by adding groups of two worms to each vessel, until each vessel contains ten worms. Each of these groups of worms are then randomly transferred to separate test vessels, e.g. using soft steel forceps. The test vessels are subsequently incubated under test conditions.

Feeding

45. In view of the low nutrient content of the artificial sediment, the sediment should be amended with a food source. In order not to underestimate the exposure of the test organisms, e.g. by selectively feeding uncontaminated food, the food necessary for reproduction and growth of the test organisms should be added to the sediment once before or during application of the test substance (see Appendix 5).

Sediment-water ratio

46. The recommended sediment-water ratio is 1:4 (45). This ratio is considered suitable to maintain oxygen concentrations at appropriate levels, and to avoid the build-up of ammonia in the overlying water. The oxygen content in the overlying water should be maintained at ≥ 40 % saturation. The overlying water of the test vessels should be gently aerated (e.g. 2 - 4 bubbles per second) via a pasteur pipette positioned approximately 2 cm above the sediment surface so as to minimise perturbation of the sediment.

▼ M6**Light and temperature**

47. The photoperiod in the culture and the test is 16 hours (1)(6). Light intensity in the test area should be kept at about 500-1 000 lx. The temperature should be 20 ± 2 °C throughout the test.

Test concentrations

48. One test concentration (as low as possible) is used for determination of the uptake kinetics, but a second (higher) concentration may be used (e.g. (46)). In that case, samples are taken and analysed at steady state or after 28 d to confirm the BAF measured at the lower concentration (11). The higher concentration should be selected so that adverse effects can be excluded (e.g. by choosing approximately 1 % of the lowest known chronic effect concentration EC_x as derived from relevant chronic toxicity studies). The lower test concentration should be significantly higher than the detection limit in sediment and biological samples by the analytical method used. If the effect concentration of the test substance is close to the analytical detection limit, the use of radiolabelled test substance with high specific radioactivity is recommended.

Treated and Control Replicates

49. The minimum number of treated replicates for kinetic measurements should be three per sampling point (11) throughout uptake and elimination phase. Additional replicates should be employed e.g. for optional additional sampling dates. For the elimination phase, a matching number of replicates is prepared with non-spiked sediment and overlying water, so that the treated worms can be transferred from designated treated vessels to non-treated vessels at the end of the uptake phase. The total number of treated replicates should be sufficient for both uptake and elimination phase.
50. Alternatively, the worms designated for sampling during the elimination phase may be exposed in one large container containing spiked sediment of the same batch as used for uptake kinetics. It should be demonstrated that the test conditions (e.g. sediment depth, sediment water ratio, loading, temperature, water quality) are comparable to the replicates designated for the uptake phase. At the end of the uptake phase, water, sediment and worm samples should be taken from this container for analysis, and a sufficient number of large worms that show no sign of recent fragmentation, should be removed carefully and transferred to the replicates prepared for the elimination phase (e.g. ten organisms per replicate vessel).
51. If no solvent other than water is used, at least 9 replicates of a negative control (at least 3 sampled at start, 3 at end of uptake and 3 at end of elimination) should be provided for biological and background analysis. If any solubilising agent is used for application of the test substance, a solvent control should be run (at least 3 replicates should be sampled at start, 3 at the end of the uptake phase, and 3 at the end of the elimination phase). In this case, at least 4 replicates of a negative control (no solvent) should be provided for sampling at the end of the uptake phase. These replicates can be compared biologically with the solvent control in order to gain information on possible influence of the solvent on the test organisms. Details are given in Appendix 3.

▼ M6**Frequency of water quality measurements**

52. As a minimum, the following water quality parameters should be measured in the overlying water during uptake and elimination phase:

Temperature	in one vessel of each treatment level per sampling date, and in one control vessel once per week and at the start and the end of the uptake and elimination period; temperature in the surrounding medium (ambient air or water bath) or in one representative test vessel may also be recorded e.g. in continuous or hourly intervals;
Dissolved oxygen content	in one vessel of each treatment level, and in one control vessel per sampling date; expressed as mg/L and % ASV (air saturation value);
Air supply	controlled at least once per day (workdays) and adjusted if needed;
pH	in one treated vessel of each treatment level per sampling date, and in one control vessel once per week and at the start and the end of the uptake and elimination period;
Total water hardness	at least in one treated vessel and one control test vessel at the start and the end of the uptake and elimination period, expressed as mg/l CaCO ₃ ;
Total ammonia content	at least in one treated vessel and one control test vessel at the start and the end of the uptake and elimination period; expressed as mg/l NH ₄ ⁺ or NH ₃ or total ammonia-N.

Sampling and analysis of worms, sediment, and water*Sampling Schedule*

53. Examples of sampling schedules for a 28-day uptake phase and a 10-day elimination phase are given in Appendix 3.
54. Sample the water and sediment from the test chambers for determination of test substance concentration before adding the worms, and during both uptake and elimination phases. During the test the concentrations of test substance are determined in the worms, sediment, and water in order to monitor the distribution of the test substance in the compartments of the test system.
55. Sample the worms, sediment, and water on at least six occasions during the uptake as well as the elimination phase.
56. Continue sampling until a plateau (steady state) has been established (see Appendix 1) or for 28 days. If the plateau has not been reached within 28 days, begin the elimination phase. When beginning the elimination phase, transfer the designated worms to replicate chambers containing untreated sediment and water (see also paragraphs 17 and 18).

Sampling and sample preparation

57. Obtain water samples by decanting, siphoning or pipetting a volume sufficient for measuring the quantity of the test substance in the sample.
58. The remaining overlying water is carefully decanted or siphoned from the test chamber(s). Sediment samples should be taken carefully, causing minimal disturbance of the worms.

▼ M6

59. Remove all worms from the test replicate at the sampling time, e.g. by suspending the sediment with overlying water and spreading the contents of each replicate on a shallow tray and picking the worms using soft steel forceps. Rinse them quickly with water in a shallow glass or steel tray. Remove the excess water. Transfer the worms carefully to a pre-weighed vessel and weigh them. Sacrifice the worms by freezing (e.g. ≤ -18 °C). The presence and number of cocoons and/or juveniles should be recorded.
60. In general, the worms should be weighed and sacrificed immediately after sampling without a gut purging phase to obtain a conservative BAF which includes contaminated gut content, and to avoid losses of body residues during any gut-purging period in water only (8). Substances with log K_{ow} above 5 are not expected to be eliminated significantly during any gut-purging period in water only, while substances with log K_{ow} lower than 4 may be lost in notable amounts (47).
61. During the elimination phase, the worms purge their gut in clean sediment. This means, measurements immediately before the elimination phase include contaminated gut sediment, while after the initial 4-24 h of the elimination phase, most of the contaminated gut content is assumed to be replaced by clean sediment (11)(47). The concentration in the worms of this sample may then be considered as the tissue concentration after gut purge. To account for dilution of the test substance concentration by uncontaminated sediment during the elimination phase, the weight of the gut content may be estimated from worm wet weight/worm ash weight or worm dry weight/worm ash weight ratios.
62. If the purpose of a specific study is to measure the bioavailability and true tissue residues in the test organisms, then at least a sub-sample of treated animals (e.g. from three additional replicate vessels), preferably sampled during steady state, should be weighed, purged in clean water for a period of 6 hours (47), and weighed again before analysis. Data on worm weight and body concentration of this sub-sample can then be compared to values obtained from un-purged worms. The worms designated for measurement of elimination should not be purged before the transfer to clean sediment to minimise additional stress for the animals.
63. Preferably analyse the water, sediment, and worm samples immediately (i.e. within 1-2 d) after removal in order to prevent degradation or other losses and to calculate the approximate uptake and elimination rates as the test proceeds. Immediate analysis also avoids delay in determining when a plateau has been reached.
64. Failing immediate analysis, the samples should be stored under appropriate conditions. Obtain information on the stability and proper storage conditions for the particular test substance before beginning the study, (e.g. duration and temperature of storage, extraction procedures, etc.). If such information is not available and it is judged to be necessary, spiked control tissues can be run concurrently to determine storage stability.

Quality of analytical method

65. Since the whole procedure is governed essentially by the accuracy, precision and sensitivity of the analytical method used for the test substance, check experimentally that the precision and reproducibility of the chemical analysis, as well as the recovery of the test substance from water, sediment and worm samples are satisfactory for the particular method. Also, check that the test substance is not detectable in the control chambers in concentrations higher than background. If necessary, correct the values of C_w , C_s and C_a for the recoveries and background values of

▼ M6

controls. Handle all samples throughout the test in such a manner so that contamination and loss are minimised (e.g. resulting from adsorption of the test substance on the sampling device).

66. The overall recovery and the recovery of test substance in worms, sediment, water, and, if employed, in traps containing absorbents to retain evaporated test substance, should be recorded and reported.

67. Since the use of radiolabelled substances is recommended, it is possible to analyse for total radioactivity (i.e. parent and degradation products). However, if analytically feasible, quantification of parent substance and degradation products at steady state or at the end of the uptake phase can provide important information. If it is intended to perform such measurements, the samples should then be subjected to appropriate extraction procedures so that the parent substance can be quantified separately. Where a detected degradation product represents a significant percentage (e.g. > 10 %) of the radioactivity measured in the test organisms at steady state or at the end of the uptake phase, it is recommended to identify such degradation products (5).

68. Due to low individual biomass, it is often not possible to determine the concentration of test substance in each individual worm, unless *Branchiura sowerbyi* (40-50 mg wet weight per worm) is used as test species (11). Therefore, pooling of the individuals sampled from a given test vessel is acceptable, but it does restrict the statistical procedures which can be applied to the data. If a specific statistical procedure and power are important considerations, then an adequate number of test animals and/or replicate test chambers to accommodate the desired pooling, procedure and power, should be included in the test.

69. It is recommended that the BAF is expressed both as a function of total wet weight, total dry weight, and, when required (e.g. for highly lipophilic substances) as a function of the lipid content and the TOC of the sediment. Suitable methods should be used for determination of lipid content (48)(49). The chloroform/methanol extraction technique (50) may be recommended as standard method (48). However, to avoid the use of chlorinated solvents, a ring-tested modification of the Bligh & Dyer method (50) as described in (51) might be used. Since the various methods do not give identical values (48), it is important to detail the method used. When possible, i.e. if sufficient worm tissue is available, the lipid content is measured in the same sample or extract as that produced for analysis for the test substance, since the lipids often have to be removed from the extract before it is analysed by chromatography (5). However, it is practical to use acclimatised control animals at least at start or — preferably — at the end of the uptake phase to measure the lipid content, e.g. in three samples.

DATA AND REPORTING**Treatment of results**

70. The uptake curve of the test substance is obtained by plotting in arithmetic scale the concentration of test substance in/on the worms during the uptake

▼ M6

phase against time. If the curve has reached a plateau, calculate the steady state BAF_{ss}:

$$\frac{C_a \text{ at steady state or at day 28 (mean)}}{C_s \text{ at steady state or at day 28 (mean)}}$$

71. Determine the kinetic bioaccumulation factor (BAFK) as the ratio k_s/k_e . The elimination constant (k_e) is usually determined from the elimination curve (i.e. a plot of the concentration of the test substance in the worms during the elimination phase). The uptake rate constant k_s is then calculated from the uptake curve kinetics. The preferred method for obtaining BAF_K and the rate constants, k_{ss} , and k_e , is to use non-linear parameter estimation methods on a computer (see Appendix 2). If the elimination is obviously not first-order, then more complex models should be employed (25)(27)(52).
72. The biota-sediment accumulation factor (BSAF) is determined by normalising the BAFK for the worm lipid content and the sediment total organic carbon content.

Interpretation of results

73. The results should be interpreted with caution where measured concentrations of test concentrations occur at levels close to the detection limit of the analytical method used.
74. Clearly defined uptake and elimination curves are an indication of good quality bioaccumulation data. Generally the confidence limits for the BAF values from well-designed studies should not exceed 25 % (5).

Test report

75. The test report must include the following information.

Test substance

- physical nature and, physicochemical properties e.g. log K_{ow} , water solubility;
- chemical identification data; source of the test substance, identity and concentration of any solvent used;
- if radiolabelled, the precise position of the labelled atoms, the specific radioactivity, and the percentage of radioactivity associated with impurities.

Test species

- scientific name, strain, source, any pre-treatment, acclimation, age, size-range, etc..

Test conditions

- test procedure used (e.g. static, semi-static or flow-through);
- type and characteristics of illumination used and photoperiod(s);
- test design (e.g. number, material and size of test chambers, water volume, sediment mass and volume, water volume replacement rate (for flow-through or semi-static procedures), any aeration used before and during the test, number of replicates, number of worms per replicate, number of test concentrations, length of uptake and elimination phases, sampling frequency);

▼ M6

- method of test substance preparation and application as well as reasons for choosing a specific method;
- the nominal test concentrations;
- source of the constituents of the artificial water and sediment or — if natural media are used — origin of the water and the sediment, description of any pre-treatment, results of any demonstration of the ability of the test animals to live and/or reproduce in the media used, sediment characteristics (pH and ammonia of the pore water (natural sediments), organic carbon content (TOC), particle size distribution (percent sand, silt, and clay), percent water content, and any other measurements made) and water characteristics (pH, hardness, conductivity, temperature, dissolved oxygen concentration, residual chlorine levels (if measured), and any other measurements made);
- the nominal and measured dry weight in % of wet weight (or dry weight-to-wet weight ratio) of the artificial sediment; the measured dry weight in % of wet weight (or dry weight-to-wet weight ratio) for field sediments;
- water quality within the test chambers as characterised by temperature, pH, ammonium, total hardness, and dissolved oxygen concentration;
- detailed information on the treatment of water, sediment, and worm samples, including details of preparation, storage, spiking procedures, extraction, and analytical procedures (and precision) for the test substance and lipid content, and recoveries of the test substance.

Results

- mortality of the control worms and the worms in each test chamber and any observed sublethal effects including abnormal behaviour (e.g., sediment avoidance, presence or absence of fecal pellets, lack of reproduction);
- the measured dry weight in % of wet weight (or dry weight-to-wet weight ratio) of the sediment and the test organisms (useful for normalisation);
- the lipid content of the worms;
- curves showing the uptake and elimination kinetics of the test substance in the worms, and the time to steady state;
- C_a , C_s and C_w (with standard deviation and range, if appropriate) for all sampling times (C_a expressed in g kg^{-1} wet and dry weight of whole body, C_s expressed in g kg^{-1} wet and dry weight of sediment, and C_w in mg l^{-1}). If a biota-sediment accumulation factor (BSAF; see Appendix 1 for definition) is required (e.g. for comparison of results from two or more tests performed with animals of differing lipid content), C_a should additionally be expressed as g kg^{-1} lipid content of the organism, and C_s should be expressed as g kg^{-1} organic carbon (OC) of the sediment;
- BAF (expressed in $\text{kg wet sediment kg}^{-1}$ wet worm), sediment uptake rate constant k_s (expressed in $\text{g wet sediment kg}^{-1}$ of wet worm d^{-1}), and elimination rate constant k_e (expressed in d^{-1}); BSAF (expressed in $\text{kg sediment OC kg}^{-1}$ worm lipid content) may be reported additionally;

▼ **M6**

- Non-eliminated residues (NER) at end of elimination phase;
- if measured: percentages of parent substance, degradation products, and bound residues (i.e. the percentage of test substance that cannot be extracted with common extraction methods) detected in the test animals;
- methods used for statistical analyses of the data.

Evaluation of results

- compliance of the results with the validity criteria as listed in paragraph 21;
- unexpected or unusual results, e.g. incomplete elimination of the test substance from the test animals; in such cases results from any preliminary study may provide useful information.

▼ **M6***Appendix 1***Definitions and units**

Artificial sediment, or formulated, reconstituted or synthetic sediment, is a mixture of materials used to mimic the physical components of a natural sediment.

Bioaccumulation is the increase in concentration of the test substance in or on an organism relative to the concentration of the test substance in the surrounding medium. Bioaccumulation results from both bioconcentration and biomagnification processes (see below).

The **bioaccumulation factor** (BAF) at any time during the uptake phase of this bioaccumulation test is the concentration of test substance in/on the test organism (C_a in g kg^{-1} wet or dry weight) divided by the concentration of the substance in the surrounding medium (C_s as g kg^{-1} of wet or dry weight of sediment). In order to refer to the units of C_a and C_s , the BAF has the units of $\text{kg sediment kg}^{-1}$ worm (15).

Bioaccumulation factors calculated directly from the ratio of the sediment uptake rate constant divided by the elimination rate constants (k_s and k_e , respectively — see below) are termed kinetic bioaccumulation factor (BAF_k).

Bioconcentration is the increase in concentration of the test substance in or on an organism, resulting exclusively from uptake via the body surface, relative to the concentration of the test substance in the surrounding medium.

Biomagnification is the increase in concentration of the test substance in or on an organism, resulting mainly from uptake from contaminated food or prey, relative to the concentration of the test substance in the food or prey. Biomagnification can lead to a transfer or accumulation of the test substance within food webs.

The **biota-sediment accumulation factor** (BSAF) is the lipid-normalised steady state concentration of test substance in/on the test organism divided by the organic carbon-normalised concentration of the substance in the sediment at steady state. C_a is then expressed as g kg^{-1} lipid content of the organism, and C_s as g kg^{-1} organic content of the sediment.

The **conditioning period** is used to stabilise the microbial component of the sediment and to remove e.g. ammonia originating from sediment components; it takes place prior to spiking of the sediment with the test substance. Usually, the overlying water is discarded after conditioning.

The **elimination** of a test substance is the loss of this substance from the test organism tissue by active or passive processes that occurs independently of presence or absence of the test substance in the surrounding medium.

The **elimination phase** is the time, following the transfer of the test organisms from a contaminated medium to a medium free of the test substance, during which the elimination (or the net loss) of the substance from the test organisms is studied.

The **elimination rate constant** (k_e) is the numerical value defining the rate of reduction in the concentration of the test substance in/on the test organism, following the transfer of the test organisms from a medium containing the test substance to a chemical-free medium; k_e is expressed in d^{-1} .

▼ M6

The **equilibration period** is used to allow for distribution of the test substance between the solid phase, the pore water and the overlying water; it takes place after spiking of the sediment with the test substance and prior to addition of the test organisms.

The **octanol-water partitioning coefficient** (K_{ow}) is the ratio of substance's solubility in n-octanol and in water at equilibrium, also sometimes expressed as P_{ow} . The logarithm of K_{ow} ($\log K_{ow}$) is used as an indication of a substance's potential for bioaccumulation by aquatic organisms.

The **organic carbon-water partitioning coefficient** (K_{oc}) is the ratio of a substance's concentration in/on the organic carbon fraction of a sediment and the substance's concentration in water at equilibrium.

Overlying water is the water lying on top of the sediment in the test vessel.

A **plateau** or **steady state** is defined as the equilibrium between the uptake and elimination processes that occur simultaneously during the exposure phase. The steady state is reached in the plot of the BAF at each sampling period against time when the curve becomes parallel to the time axis and three successive analyses of BAF made on samples taken at intervals of at least two days are within 20 % of each other, and there are no statistically significant differences among the three sampling periods. For test substances which are taken up slowly, more appropriate intervals would be seven days (5).

Pore water or interstitial water is the water occupying space between sediment or soil particles.

The **sediment uptake rate constant** (k_s) is the numerical value defining the rate of increase in the concentration of the test substance in/on the test organism resulting from uptake from the sediment phase. k_s is expressed in $\text{g sediment kg}^{-1}$ of worm d^{-1} .

Spiked sediment is sediment to which test substance has been added.

The **steady state bioaccumulation factor** (BAF_{ss}) is the BAF at steady state and does not change significantly over a prolonged period of time, the concentration of the test substance in the surrounding medium (C_s as g kg^{-1} of wet or dry weight of sediment) being constant during this period of time.

The **uptake or exposure phase** is the time during which the test organisms are exposed to the test substance.

▼ **M6***Appendix 2***Calculation of uptake and elimination parameters**

The main endpoint of a bioaccumulation test is the bioaccumulation factor, BAF. The measured BAF can be calculated by dividing the concentration of the test substance in the test organism, C_a , by the concentration of the test substance in the sediment, C_s , at steady state. If the steady state is not reached during the uptake phase, the BAF is calculated in the same manner for day 28. However, it should be noted whether the BAF is based on steady state concentrations or not.

The preferred means for obtaining the kinetic bioaccumulation factor (BAF_K), the sediment uptake rate constant (k_s) and the elimination rate constant (k_e) is to use non-linear parameter estimation methods on a computer. Given the time series of average accumulation factors (C_a , mean values of each sampling date/ C_s , mean values of each sampling date = AF) of the uptake phase based on worm and sediment wet weight, and the model equation

$$AF(t) = BAF \times (1 - e^{k_e \times t}) \quad \text{[equation 1]}$$

where AF(t) is the ratio of concentration of the test substance in worms and its concentration in the sediment at any given time point (t) of the uptake phase, these computer programs calculate values for BAF_K , k_s and k_e .

When steady state is reached during the uptake phase (i.e. $t = \infty$), equation 1 may be reduced to:

$$BAF_K = \frac{k_s}{k_e} \quad \text{[equation 2]}$$

where

k_s = uptake rate constant in tissue [g sediment kg^{-1} of worm d^{-1}]

k_e = elimination rate constant [d^{-1}]

Then $k_s/k_e \times C_s$ is an approach to the concentration of the test substance in the worm tissue at steady state ($C_{a,ss}$).

The Biota-Sediment Accumulation Factor (BSAF) should be calculated as follows:

$$BSAF = BAF_K \times \frac{f_{oc}}{f_{lip}}$$

where f_{oc} is the fraction of sediment organic carbon, and f_{lip} is the fraction of worm lipid, both based either on dry weight, or on wet weight.

Given a time series of concentration values, the elimination kinetics can be modelled using the following model equations and a computer calculation based non-linear parameter estimation method.

The mean measured body residue at the end of the uptake phase is recommended as the default starting point. The value modeled/estimated from the uptake phase should only be used, e.g. if the measured value deviates significantly from the modelled body residue. See also paragraph 50 for alternative pre-exposure of worms designated for elimination; with this approach, samples of these pre-exposed worms on day 0 of the elimination phase are thought to provide a realistic body residue to start the elimination kinetics with.

▼ M6

If the data points plotted against time indicate a constant exponential decline of the test substance concentration in the animals, a one-compartment model (equation 4) can be used to describe the time course of elimination.

$$C_a(t) = C_{a,ss} \times e^{-k_e t} \quad [\text{equation 3}]$$

Elimination processes sometimes appear to be biphasic, showing a rapid decline of C_a during the early phases, that changes to a slower loss of test substances in the later phases of the elimination (8)(19)(25)). The two phases can be interpreted by the assumption, that there are two different compartments in the organism, from which the test substance is lost with different velocity. In these cases specific literature should be studied (15)(16)(17)(25).

A two-compartment elimination is described e.g. by the following equation (25):

$$C_a = A \times e^{-k_a \times t} + B \times e^{-k_b \times t} \quad [\text{equation 4}]$$

A and B represent the size of the compartments (in percent of overall tissue residue), where A is the compartment with rapid loss of substance, and B the compartment with slow loss of test substance. The sum of A and B equals 100 % of the whole animal compartment volume at steady state. k_a and k_b represent the corresponding elimination constants [d^{-1}]. If the two compartment model is fitted to the depuration data, the uptake rate constant k_s may be determined as follows (53)(54):

$$k_s = \frac{(A \times k_a + B \times k_b) \times \text{BAF}}{A + B} \quad [\text{equation 5}]$$

Nevertheless, these model equations should be used with caution, especially when changes in the test substance's bioavailability occur during the test (42).

As an alternative to the model equations described above, the kinetics (k_s and k_e) may also be calculated in one run by applying the first order kinetics model to all data from both the uptake and elimination phase together. For a description of a method that may allow for such a combined calculation of uptake and elimination rate constants, references (55), (56) and (57) may be consulted.

The Non-Eliminated Residues (NER) should be calculated as a secondary endpoint by multiplying the ratio of the average concentration in the worms (C_a) on day 10 of the elimination phase and the average concentration in the worms (C_a) at steady state (day 28 of uptake phase) by 100:

$$NER_{10d}[\%] = \frac{C_a \text{ at the end of elimination(average)} \times 100}{C_a \text{ at steady state(average)}}$$

▼ **M6***Appendix 3***Example of a Sampling Schedule for a 28-day Bioaccumulation Test****a) Uptake phase (including a 4 d- equilibration phase)**

Day	Activities
- 6	Preparation of peat suspension for sediment; conditioning of the suspension for 48 h;
- 4	Spiking of the sediment or sediment fraction; mixing of all sediment constituents; removing sediment samples of treated and solvent control sediment for determination of test substance concentration; addition of overlying water; incubation at test conditions (equilibration phase);
- 3/- 2	Separation of the test organisms from the culture for acclimatisation;
0	Measurement of water quality (see paragraph 52); removing replicates for taking samples of water and sediment for determination of test substance concentration; randomised distribution of the worms to the test chambers; retaining of sufficient sub-samples of worms for determination of analytical background values; controlling air supply, if closed test system is used;
1	Remove replicates for sampling; controlling air supply, worm behaviour, water quality (see paragraph 56); taking water, sediment and worm samples for determination of test substance concentration;
2	Controlling air supply, worm behaviour and temperature;
3	Same as day 1;
4 - 6	Same as day 2;
7	Same as day 1; compensate evaporated water if necessary;
8 - 13	Same as day 2;
14	Same as day 1; compensate evaporated water if necessary;
15 - 20	Same as day 2;
21	Same as day 1; compensate evaporated water if necessary;
22 - 27	Same as day 2;
28	Same as day 1; measurement of water quality (see paragraph 52); end of uptake phase; retaining of sufficient subsamples of worms for determination of analytical background values, wet and dry weight, and lipid content; transfer worms from remaining exposed replicates to vessels containing clean sediment for elimination phase (no gut-purging); sampling of water, sediment and worms from solvent controls; sampling of trapping solutions, if installed.
	Pre-exposure activities (equilibration phase) should be scheduled taking into account the properties of the test substance. If required, conditioning of the prepared sediment under overlying water at 20 ± 2 °C for 7 days; in this case, earlier preparation of the sediment!
	Activities described for day 2 should be performed daily (at least on workdays).

▼ **M6****b) Elimination phase**

Day	Activities
- 6	Preparation of peat suspension for sediment; conditioning of the suspension for 48 h;
- 4	Mixing of all sediment constituents; removing sediment samples of treated and solvent control sediment for determination of test substance concentration; addition of overlying water; incubation at test conditions;
0 (day 28 of uptake phase)	Measurement of water quality (see paragraph 52); transfer worms from remaining exposed replicates to vessels containing clean sediment; after 4 - 6 h removing replicates for taking samples of water, sediment and worms for determination of test substance concentration; randomised distribution of the worms to the test chambers;
1	Remove replicates for sampling; controlling air supply, worm behaviour, water quality (see paragraph 52); taking water, sediment and worm samples for determination of test substance concentration;
2	Controlling air supply, worm behaviour and temperature;
3	Same as day 1;
4	Same as day 2;
5	Same as day 1;
6	Same as day 2;
7	Same as day 1; compensate evaporated water if necessary;
8 - 9	Same as day 2;
10	Same as day 1; end of elimination phase; measurement of water quality (see paragraph 52); sampling of water, sediment and worms from solvent controls; sampling of trapping solutions, if installed.
	Preparation of the sediment prior to start of elimination phase should be done in the same manner as before the uptake phase.
	Activities described for day 2 should be performed daily (at least on workdays).

▼ **M6***Appendix 4***Some physical-chemical characteristics of an acceptable dilution water**

CONSTITUENT	CONCENTRATIONS
Particular matter	< 20 mg/l
Total organic carbon	< 2µg/l
Unionised ammonia	< 1 µg/l
Residual chlorine	< 10 µg/l
Total organophosphorous pesticides	< 50 ng/l
Total organochlorine pesticides plus polychlorinated biphenyls	< 50 ng/l
Total organic chlorine	< 25 ng/l

COMPOSITION OF THE RECOMMENDED RECONSTITUTED WATER

(a) Calcium chloride solution

Dissolve 11,76 g $\text{CaCl}_2 \cdot 2\text{H}_2\text{O}$ in deionised water; make up to 1 l with deionised water

(b) Magnesium sulphate solution

Dissolve 4,93 g $\text{MgSO}_4 \cdot 7\text{H}_2\text{O}$ in deionised water; make up to 1 l with deionised water

(c) Sodium bicarbonate solution

Dissolve 2,59 g NaHCO_3 in deionised water; make up to 1 l with deionised water

(d) Potassium chloride solution

Dissolve 0,23 g KCl in deionised water; make up to 1 l with deionised water

All chemicals must be of analytical grade.

The conductivity of the distilled or deionised water should not exceed $10 \mu\text{Scm}^{-1}$.

25 ml each of solutions (a) to (d) are mixed and the total volume made up to 1 l with deionised water. The sum of the calcium and magnesium ions in this solution is 2,5 mmol/l.

The proportion Ca:Mg ions is 4:1 and Na:K ions 10:1. The acid capacity $K_{\text{S}4.3}$ of this solution is 0,8 mmol/l.

Aerate the dilution water until oxygen saturation is achieved, then store it for approximately two days without further aeration before use.

The pH of an acceptable dilution water should be in the range of 6 - 9.

▼ **M6***Appendix 5***Artificial sediment — preparation and storage recommendations**

In contrast to the requirements in test method C.8 (40) the peat content of the artificial sediment is recommended to be 2 % instead of 10 % of dry weight, in order to correspond to a low to moderate organic content of natural sediments (58).

Percentage of dry constituents of the artificial sediment:

Constituent	Characteristics	% of dry sediment
Peat	Sphagnum moss peat, degree of decomposition: 'medium', air dried, no visible plant remains, finely ground (particle size $\leq 0,5$ mm)	$2 \pm 0,5$
Quartz sand	Grain size: ≤ 2 mm, but > 50 % of the particles should be in the range of 50-200 μm	76
Kaolinite clay	Kaolinite content ≥ 30 %	22 ± 1
Food source	<i>Folia urticae</i> , powdered leaves of <i>Urtica sp.</i> (stinging nettle), finely ground (particle size $\leq 0,5$ mm), or a mixture of powdered leaves of <i>Urtica sp.</i> with alpha-cellulose (1:1); in accordance with pharmacy standards, for human consumption; in addition to dry sediment	0,4 - 0,5 %
Calcium carbonate	CaCO_3 , pulverised, chemically pure, in addition to dry sediment	0,05 - 1
Deionised Water	Conductivity ≤ 10 $\mu\text{S/cm}$, in addition to dry sediment	30 - 50

If elevated ammonia concentrations are expected, e.g. if the test substance is known to inhibit the nitrification, it may be useful to replace 50 % of the nitrogen-rich urtica powder by cellulose (e.g., α -Cellulose powder, chemically pure, particle size $\leq 0,5$ mm).

Preparation

The peat is air-dried and ground to a fine powder (grain size $\leq 0,5$ mm, no visible plant remains). A suspension of the required amount of peat powder is prepared using a portion of the deionised water to be added to the dry sediment (a water volume of $11,5 \times$ dry weight of peat has been found useful to produce a stirrable peat slurry (8)) using a high-performance homogenising device.

The pH of this suspension is adjusted to $5,5 \pm 0,5$ with CaCO_3 . The suspension is conditioned for at least two days with gentle stirring at 20 ± 2 °C, to stabilise pH and establish a stable microbial component. The pH is measured again and is adjusted to $6,0 \pm 0,5$ with CaCO_3 if necessary. Then all of the suspension is mixed with the other dry constituents, taking into account any portion used for spiking. The remaining deionised water is added to obtain a homogeneous sediment. The pH is measured again and is adjusted to 6,5 to 7,5 with CaCO_3 if necessary. However, if ammonia development is expected, it may be useful to keep the pH of the sediment below 7,0 (e.g. between 6,0 and 6,5). Samples of the sediment are taken to determine the dry weight and the organic carbon content. If ammonia development is expected, the artificial sediment may be conditioned for seven days under the same conditions which prevail in the subsequent test (e.g. sediment-water ratio 1: 4, height of sediment layer as in test vessels) before it is spiked with the test substance, i.e. it should be topped with water, which should be aerated. At the end of the conditioning period, the overlying water should be removed and discarded. Samples of the sediment are taken to determine dry weight and total organic carbon content (e.g. 3 samples).

▼ M6

Thereafter, the spiked quartz sand is mixed with the sediment for each treatment level, the sediment is distributed to the replicate test vessels, and topped with the test water (e.g. sediment-water ratio 1 : 4, height of sediment layer as in test vessels). The vessels are then incubated at the same conditions which prevail in the subsequent test. This is where the equilibration period starts. The overlying water should be aerated.

The chosen food source should be added prior to or during spiking the sediment with the test substance. It can be mixed initially with the peat suspension (see above). However, excessive degradation of the food source prior to addition of the test organisms — e.g. in case of long equilibration period — can be avoided by keeping the time period between food addition and start of exposure as short as possible. In order to ensure that the food is in sufficient contact with the test substance, the food source should be mixed with the sediment not later than on the day the test substance is spiked to the sediment. Exceptions may be made where the length of the equilibration period leads to excessive microbial degradation of the food before the test organisms are added. Samples of the sediment are taken to determine dry weight and total organic carbon (e.g. 3 samples of spiked or control sediment).

The dry weight of the components (peat, sand, kaolin) should be reported in g and in per cent of total dry weight.

The volume of water to be added to the dry components during preparation of the sediment should also be reported in per cent of total dry weight (e.g. 100 % dry weight + 46 % water means 1 000 g d.w. receive a total of 460 ml water, which results in 1 460 g wet sediment).

Storage

The dry constituents of the artificial sediment may be stored in a dry, cool place at room temperature. The prepared, wet sediment may be stored (for further use in the culture only) at 4 ± 2 °C in the dark for a period of 2 to 4 weeks from the day of preparation (8).

Sediment spiked with the test substance should be used immediately unless there is information indicating that the particular sediment can be stored without affecting the toxicity and bioavailability of the test substance. Samples of spiked sediment may be stored under the conditions recommended for the particular test substance until analysis.

▼ **M6***Appendix 6***Oligochaetes species recommended for bioaccumulation testing*****Tubifex tubifex* (MÜLLER), Tubificidae, Oligochaeta**

The tubificid oligochaete (Tubificidae, Oligochaeta) *Tubifex tubifex* (Müller) lives in freshwater sediments in tubes which are lined with mucus. In these tubes the worms dwell head down, ingesting sediment particles utilising the associated microorganisms and organic debris. The posterior portion usually undulates in the overlying water for respiration purposes. Although this species inhabits a wide range of sediment types all over the northern hemisphere, *Tubifex tubifex* prefers relatively fine grain sizes (59). The suitability of this species for ecotoxicological testing is described for example in (8)(29)(31)(39)(60)(62)(63).

Culture methods

In order to have a sufficient number of *Tubifex tubifex* for conducting bioaccumulation tests the worms have to be kept in permanent laboratory culture. A system consisting of artificial sediment based on the artificial soil according to Test Method C.8 (40) and reconstituted water according to test method C.1 is recommended for *T. tubifex* culture (8).

Glass or stainless steel containers with a height of 12 to 20 cm can be used as culture vessels. Each culture container is loaded with a layer of wet artificial sediment prepared as described in Appendix 5. The depth of the sediment layer should allow for natural burrowing behaviour of the worms (2 cm minimum depth for *T. tubifex*). Reconstituted water is added to the system. Care should be taken to minimise disturbing the sediment. The water body is gently aerated (e.g. 2 bubbles per second with 0,45 µm-filtered air) via a pasteur pipette positioned 2 cm above the sediment surface. The recommended culture temperature is 20 ± 2 °C.

The worms are added to the culture system with a maximum loading of 20 000 individuals/m² sediment surface. A higher loading may cause a reduction in growth and reproduction rates (43).

In artificial sediment cultures, the worms have to be fed. A diet consisting of finely ground fish food, e.g. TetraMin® can serve as additional nutrition (8); Klerks 1994, personal communication. The feeding rates should allow for sufficient growth and reproduction and should keep build-up of ammonia and fungal growth in the culture at a minimum. Food may be administered twice a week (e.g. 0,6 - 0,8 mg per cm² of sediment surface). Practical experience has shown that application of food suspended and homogenised in deionised water may facilitate homogeneous food distribution on the sediment surface in the culture containers.

To avoid accumulation of ammonia, the overlying water should be exchanged using a flow-through system, or, at least once a week, manually. Sediment should be changed every three months in the stock cultures.

Sampling of worms from the culture can be done by sieving the culture sediment through a 1 mm sieve if only adults are required. For retaining cocoons a 0,5 mm mesh, and for juvenile worms a 0,25 mm sieve is suitable. The sieves can be placed into reconstituted water after the sediment has passed through. The worms leave the mesh and can then be picked from the water using a soft steel forceps or a pipette with fire-polished edges.

▼ M6

Only intact and clearly identified specimens of *Tubifex tubifex* (e.g. (64)) are used to start a test or new cultures. Diseased or injured worms as well as cocoons infested with fungal hyphae have to be discarded.

A synchronised culture can provide worms of a specified age in suitable intervals when desired. New culture vessels are set up in the chosen intervals (e.g. every two weeks), starting with animals of a certain age (e.g. cocoons). At the culture conditions described here the worms are adult after 8 - 10 weeks. The cultures can be harvested, when the worms have laid new cocoons, e.g. after ten weeks. The sampled adults can be used for tests, and new cultures can be started with the cocoons.

***Lumbriculus variegatus* (MÜLLER), Lumbriculidae, Oligochaeta**

Lumbriculus variegatus (Lumbriculidae, Oligochaeta) is also an inhabitant of freshwater sediments worldwide and is widely used in ecotoxicological testing. Information on the biology, culture conditions, and sensitivity of the species can be obtained from (1)(6)(9)(36). *Lumbriculus variegatus* can also be cultured in the artificial sediment recommended for *T. tubifex* according to (8) within certain limitations. Since, in nature *L. variegatus* prefers more coarse sediments than *T. tubifex* (59), laboratory cultures with the artificial sediment used for *T. tubifex* may cease after 4 to 6 months. Practical experience has shown that *L. variegatus* can be held in a sandy substratum (e.g. quartz sand, fine gravel) in a flow-through system using fish food as nutritional source over several years without renewing the substratum. A major advantage of *L. variegatus* over other aquatic oligochaete species is its quick reproduction, resulting in rapidly increasing biomass in laboratory-cultured populations (1)(6)(9)(10).

Culture methods

Culture conditions for *Lumbriculus variegatus* are outlined in detail in Phipps et al. (1993) (10), Brunson et al. (1998) (28), ASTM (2000) (1), U.S. EPA (2000) (6). A short summary of these conditions is given below.

The worms can be cultured in large aquaria (57 - 80 l) at 23 °C with a 16L:8D photoperiod (100 - 1 000 lux) using daily renewed natural water (45 - 50 l per aquarium). The substrate is prepared by cutting unbleached brown paper towels into strips, which may then be blended with culture water for a few seconds to result in small pieces of paper substrate. This substrate can then directly be used in the *Lumbriculus* culture aquaria by covering the bottom area of the tank, or be stored frozen in deionised water for later use. New substrate in the tank will generally last for about two months.

Each worm culture is started with 500 - 1 000 worms, and fed a 10 ml suspension containing 6 g of trout starter food 3 times per week under renewal or flow-through conditions. Static or semi-static cultures should receive lower feeding rates to prevent bacterial and fungal growth. Food and paper substrate should be analysed for the substances to be used in bioaccumulation tests.

Under these conditions the number of individuals in the culture generally doubles in about 10 to 14 d.

Lumbriculus variegatus can be removed from the cultures e.g. by transferring substrate with a fine mesh net, or organisms using a fire polished wide mouth (about 5 mm diameter) glass pipette, to a separate beaker. If substrate is co-transferred to this beaker, the beaker containing worms and substrate is left overnight under flow-through conditions, which will remove the substrate from

▼ **M6**

the beaker, while the worms remain at the bottom of the vessel. They can then be introduced to newly prepared culture tanks, or processed further for the test as outlined in (1) and (6). Injuries or autotomy in the worms should be prevented, e.g. by using pipettes with fire polished edges, or stainless steel picks for handling these worms.

An issue to be regarded critically when using *L. variegatus* in sediment bioaccumulation tests is its reproduction mode (architomy followed by morphallaxis). This asexual reproduction results in two fragments, which do not feed for a certain period until the head or tail part is regenerated (e.g. (36)(37)). This means that in *L. variegatus* sediment and contaminant uptake via ingestion may not take place continuously as in tubificids, which do not reproduce by fragmentation.

Therefore, a synchronisation should be performed to minimise uncontrolled reproduction and regeneration, and subsequent high variation in test results. Such variation can occur, when some individuals, which have fragmented and therefore do not feed for a certain time period, are less exposed to the test substance than other individuals, which do not fragment during the test, e.g. (38). 10 to 14 days before the start of exposure, the worms should be artificially fragmented (synchronisation) (65). Large worms should be used, which preferably do not show signs of recent fragmentation. These worms can be placed onto a glass slide in a drop of culture water, and dissected in the median body region with a scalpel. Care should be taken that the posterior ends are of similar size. The posterior ends should then be left to regenerate new heads in a culture vessel containing the same substrate as used in the culture and reconstituted water until the start of exposure. Regeneration of new heads is indicated when the synchronised worms are burrowing in the substrate (presence of regenerated heads may be confirmed by inspecting a representative subsample under a binocular microscope). The test organisms are thereafter expected to be in a similar physiological state. This means, that when regeneration by morphallaxis occurs in synchronised worms during the test, virtually all animals are expected to be equally exposed to the spiked sediment. Feeding of the synchronised worms should be done as soon as the worms are starting to burrow in the substrate, or 7 d after dissection. The feeding regimen should be comparable to the regular cultures, but it may be advisable to feed the synchronised worms with the same food source as is to be used in the test. The worms should be held at test temperature, at 20 ± 2 °C. After regenerating, intact complete worms of similar size, which are actively swimming or crawling upon a gentle mechanical stimulus, should be used for the test. Injuries or autotomy in the worms should be prevented, e.g. by using pipettes with fire polished edges, or stainless steel picks for handling these worms.

When using *Lumbriculus variegatus* in the test, due to the specific reproduction mode of this species, an increase of the number of worms should occur during the test, if conditions are appropriate (6). A lack of reproduction in a bioaccumulation test with *L. variegatus* should be recorded, and considered when interpreting the test results.

***Branchiura sowerbyi* (BEDDARD), Tubificidae, Oligochaeta (not validated in ring test)**

Branchiura sowerbyi inhabits a variety of sediment types of reservoirs, lakes, ponds and rivers, originally in tropical areas. They can be also found in warm water bodies of the northern hemisphere. However, they are more abundant in mud-clay sediments with high organic matter content. Furthermore, the worms are living in the sediment layer. Even the posterior end of the worms is usually burrowed. This species is easily identified from the gill filaments on their posterior part. The adults can reach a length of 9 - 11 cm and a wet weight

▼ M6

of 40-50 mg. The worms have a high rate of reproduction, show population doubling times of less than 2 weeks and under the conditions of temperature and feeding described below (Aston et al., 1982, (65)). *B. sowerbyi* has been used both in toxicity and bioaccumulation studies (Marchese & Brinkhurst 1996, (31) Roghair et al. 1996, (67) respectively).

Culture methods

A summary of culture conditions for *Branchiura sowerbyi* is given below (provided by Mercedes R. Marchese, INALI, Argentina, and Carla J. Roghair, RIVM, The Netherlands).

No single technique for culturing the test organisms is required. The organisms can be cultured using uncontaminated, natural sediment (31). Practical experience showed that a medium consisting of natural sediment and sand improves the condition of the worms compared to pure natural sediment (32)(67). 3 L-beakers containing 1 500 ml sediment/water medium, consisting of 375 ml of natural uncontaminated sediment (about 10 % Total Organic Carbon; about 17 % of the particles $\leq 63 \mu\text{m}$), 375 ml of clean sand (M32), and 750 ml of reconstituted or dechlorinated tap water can be used for the culture (31)(32)(67). Paper towels also can be used as a substrate for culturing, but population growth is lower than in natural sediment. In semi-static systems the water layer in the beaker is slowly aerated, and the overlying water should be renewed weekly.

Each beaker contains 25 young worms to start with. After two months the large worms are picked out of the sediment with a pair of tweezers and are put in a new beaker with freshly made sediment/water medium. The old beaker also contains cocoons and young worms. Up to 400 young worms per beaker can be harvested in this way. Adults worms can be used for reproduction for at least one year.

The cultures should be maintained at a temperature of 21 to 25 °C. Variation of temperature should be kept below ± 2 °C. The time required for embryonic development from an egg being laid until the young leaves the cocoon is approximately three weeks at 25 °C. The egg production obtained per surviving worm in *B. sowerbyi* was found to range from 6,36 (31) to 11,2 (30) in mud at 25 °C. The number of eggs per cocoon ranges from 1,8 to 2,8 (66)(69) or up to 8 (68).

Dissolved oxygen, water hardness, temperature, and pH should be measured weekly. Fish food (e.g. TetraMin®) can be added as suspension two or three times per week ad libitum. The worms can also be fed with thawed lettuce *ad libitum*.

A major advantage of this species is the high individual biomass (up to 40 - 50 mg wet weight per individual). Therefore this species may be used for testing bioaccumulation of non-radiolabelled test substances. It can be exposed in the systems used for *T. tubifex* or *L. variegatus* with a single individual per replicate (11). Replication, however, should then be increased, unless larger test chambers are used (11). Also, the validity criterion related to burrowing behaviour needs to be adjusted for this species.

▼ **M6**

LITERATURE

- (1) ASTM International (2000). Standard guide for the determination of the bioaccumulation of sediment-associated contaminants by benthic invertebrates, E 1688-00a. In ASTM International 2004 Annual Book of Standards. Volume 11.05. Biological Effects and Environmental Fate; Biotechnology; Pesticides. ASTM International, West Conshohocken, PA.
- (2) European Commission (EC) (2003). Technical Guidance Document on Risk Assessment in support of Commission Directive 93/67/EEC on Risk Assessment for new notified substances, Commission Regulation (EC) No 1488/94 on Risk Assessment for existing substances and Directive 98/8/EC of the European Parliament and of the Council concerning the placing of biocidal products on the market; Part I - IV. Office for Official Publications of the European Communities, Luxembourg.
- (3) OECD (1992a). Report of the OECD workshop on effects assessment of chemicals in sediment. OECD Monographs No. 60. Organisation for Economic Co-operation and Development (OECD), Paris.
- (4) Ingersoll, C.G., Ankley, G.T., Benoit D.A., Brunson, E.L., Burton, G.A., Dwyer, F.J., Hoke, R.A., Landrum, P. F., Norberg-King, T. J. and Winger, P.V. (1995). Toxicity and bioaccumulation of sediment-associated contaminants using freshwater invertebrates: A review of methods and applications. Environ. Toxicol. Chem. 14, 1885-1894.
- (5) Chapter C.13 of this Annex, Bioconcentration Flow Thorough Fish test.
- (6) U.S. EPA (2000). Methods for measuring the toxicity and bioaccumulation of sediment-associated contaminants with freshwater invertebrates. Second Edition. EPA 600/R-99/064, U.S. Environmental Protection Agency, Duluth, MN, March 2000.
- (7) Chapter C.27 of this Annex, Sediment water Chironomid toxicity test using spiked sediment
- (8) Egeler, Ph., Römbke, J., Meller, M., Knacker, Th., Franke, C., Studinger, G. & Nagel, R. (1997). Bioaccumulation of lindane and hexachlorobenzene by tubificid sludgeworms (*Oligochaeta*) under standardised laboratory conditions. Chemosphere 35, 835-852.
- (9) Ingersoll, C.G., Brunson, E.L., Wang N., Dwyer, F.J., Ankley, G.T., Mount D.R., Huckins J., Petty. J. and Landrum, P. F. (2003). Uptake and depuration of nonionic organic contaminants from sediment by the oligochaete, *Lumbriculus variegatus*. Environmental Toxicology and Chemistry 22, 872-885.
- (10) Phipps, G.L., Ankley, G.T., Benoit, D.A. and Mattson, V.R. (1993). Use of the aquatic Oligochaete *Lumbriculus variegatus* for assessing the toxicity and bioaccumulation of sediment-associated contaminants. Environ.Toxicol. Chem. 12, 269-279.
- (11) Egeler, Ph., Römbke, J., Knacker, Th., Franke, C. & Studinger, G. (1999). Workshop on 'Bioaccumulation: Sediment test using benthic oligochaetes', 26.-27.04.1999, Hochheim/Main, Germany. Report on the R+D-project No. 298 67 419, Umweltbundesamt, Berlin.
- (12) Egeler, Ph., Meller, M., Schallnaß, H.J. & Gilberg, D. (2006). Validation of a sediment bioaccumulation test with endobenthic aquatic oligochaetes by an international ring test. Report to the Federal Environmental Agency (Umweltbundesamt Dessau), R&D No.: 202 67 437.
- (13) Kelly, J.R., Levine, S.N., Buttel, L.A., Kelly, A.C., Rudnick, D.T. & Morton, R.D. (1990). Effects of tributyltin within a *Thalassia* seagrass ecosystem. Estuaries 13, 301-310.

▼ M6

- (14) Nendza, M. (1991). QSARs of bioaccumulation: Validity assessment of log Kow/log BCF correlations. In: R. Nagel and R. Loskill (eds.): Bioaccumulation in aquatic systems. Contributions to the assessment. Proceedings of an international workshop, Berlin 1990. VCH, Weinheim
- (15) Landrum, P.F., Lee II, H., & Lydy, M.J. (1992). Toxicokinetics in aquatic systems: Model comparisons and use in hazard assessment. *Environ. Toxicol. Chem.* 11, 1709-1725.
- (16) Markwell, R.D., Connell, D.W. & Gabric, A.J. (1989). Bioaccumulation of lipophilic compounds from sediments by oligochaetes. *Wat. Res.* 23, 1443-1450.
- (17) Gabric, A.J., Connell, D.W. & Bell, P.R.F. (1990). A kinetic model for bioconcentration of lipophilic compounds by oligochaetes. *Wat. Res.* 24, 1225-1231.
- (18) Kukkonen, J. and Landrum, P.F. (1994). Toxicokinetics and toxicity of sediment-associated Pyrene to *Lumbriculus variegatus* (Oligochaeta). *Environ. Toxicol. Chem.* 13, 1457-1468.
- (19) Franke, C., Studinger, G., Berger, G., Böhling, S., Bruckmann, U., Cohors-Fresenborg, D. and Jöhncke, U. (1994). The assessment of bioaccumulation. *Chemosphere* 29, 1501-1514.
- (20) OECD (2000). Guidance Document on Aquatic Toxicity Testing of Difficult Substances and Mixtures. OECD Environment, Health and Safety Publications, Series on Testing and Assessment No. 23.
- (21) U.S. EPA (1996). Special Considerations for Conducting Aquatic Laboratory Studies. Ecological Effects Test Guidelines. OPPTS 850.1000. Public Draft. EPA 712-C-96-113. U.S. Environmental Protection Agency.
- (22) The following chapters of this Annex:
 - Chapter A.4, vapour pressure
 - Chapter A.5, Surface tension
 - Chapter A.6, Water solubility
 - Chapter A.8, Partition coefficient, shake flask method
 - Chapter A.24, Partition coefficient, HPLC method
 - Chapter C.7, degradation — abiotic degradation: hydrolysis as a function of pH
 - Chapter C.4 A-F Determination of ready biodegradability
 - Chapter C.19, Estimation of the adsorption coefficient (K_{oc}) on soil and on sewage sludge using high performance liquid chromatography (HPLC)
 - Chapter C.29, Ready biodegradability CO₂ in sealed vessels
- (23) OECD (1996). Direct phototransformation of chemicals in water. Environmental Health and Safety Guidance Document Series on Testing and Assessment of Chemicals No. 3. OECD, Paris.
- (24) Antoine, M.D., Dewanathan, S. & Patonay, G. (1991). Determination of critical micelles concentration of surfactants using a near-infrared hydrophobicity probe. *Microchem. J.* 43, 165-172.

▼ **M6**

- (25) Beek, B., S. Boehling, U. Bruckmann, C. Franke, U. Joehncke & G. Studinger (2000). The assessment of bioaccumulation. In Hutzinger, O. (editor), *The Handbook of Environmental Chemistry, Vol. 2 Part J* (Vol. editor: B. Beek): Bioaccumulation — New Aspects and Developments. Springer-Verlag Berlin Heidelberg: 235-276.
- (26) Spacie, A. & Hamelink, J.L. (1982). Alternative models for describing the bioconcentration of organics in fish. *Environ. Toxicol. Chem.* 1, 309-320.
- (27) Hawker, D.W. & Connell, D.W. (1988). Influence of partition coefficient of lipophilic compounds on bioconcentration kinetics with fish. *Wat. Res.* 22, 701-707.
- (28) Brunson, E.L., Canfield, T.J., Ingersoll, C.J. & Kemble, N.E. (1998). Assessing the bioaccumulation of contaminants from sediments of the Upper Mississippi river using field-collected oligochaetes and laboratory-exposed *Lumbriculus variegatus*. *Arch. Environ. Contam. Toxicol.* 35, 191-201.
- (29) Reynoldson, T.B., Thompson, S.P. and Bamsey, J.L. (1991). A sediment bioassay using the tubificid oligochaete worm *Tubifex tubifex*. *Environ. Toxicol. Chem.* 10, 1061-1072.
- (30) Aston, R.J. & Milner, A.G.P. (1981). Conditions for the culture of *Branchiura sowerbyi* (Oligochaeta: Tubificidae) in activated sludge. *Aquaculture* 26, 155-160.
- (31) Marchese, M.R. & Brinkhurst, R.O. (1996). A comparison of two tubificid species as candidates for sublethal bioassay tests relevant to subtropical and tropical regions. *Hydrobiologia* 334, 163-168.
- (32) Roghair, C.J. & Buijze, A. (1994). Development of sediment toxicity tests. IV. A bioassay to determine the toxicity of field sediments to the oligochaete worm *Branchiura sowerbyi*. RIVM Report 719102027.
- (33) Chapter C.1 of this Annex, Fish, Acute Toxicity Test.
- (34) OECD (1992c). *Guidelines for Testing of Chemicals No. 210. Fish, Early-life Stage Toxicity Test*. OECD, Paris.
- (35) Kaster, J.L., Klump, J.V., Meyer, J., Krezoski, J. & Smith, M.E. (1984). Comparison of defecation rates of *Limnodrilus hoffmeisteri* using two different methods. *Hydrobiologia* 11, 181-184.
- (36) Leppänen, M.T. & Kukkonen, J.V.K. 1998: Factors affecting feeding rate, reproduction and growth of an oligochaete *Lumbriculus variegatus* (Müller). *Hydrobiologia* 377: 183-194.
- (37) Leppänen, M.T. & Kukkonen, J.V.K. 1998: Relationship between reproduction, sediment type and feeding activity of *Lumbriculus variegatus* (Müller): Implications for sediment toxicity testing. *Environ. Toxicol. Chem.* 17: 2196-2202.
- (38) Leppänen M.T. & Kukkonen J.V.K. (1998). Relative importance of ingested sediment and porewater as bioaccumulation routes for pyrene to oligochaete (*Lumbriculus variegatus*, Müller). *Environ. Sci. Toxicol.* 32, 1503-1508.
- (39) Martinez-Madrid, M., Rodriguez, P., Perez-Iglesias, J.I. & Navarro, E. (1999). Sediment toxicity bioassays for assessment of contaminated sites in the Nervion river (Northern Spain). 2. *Tubifex tubifex* (Müller) reproduction sediment bioassay. *Ecotoxicology* 8, 111-124.

▼M6

- (40) Chapter C.8 of this Annex, Toxicity for Earthworms.
- (41) Environment Canada (1995). Guidance document on measurement of toxicity test precision using control sediments spiked with a reference toxicant. Environmental Protection Series Report EPS 1/RM/30.
- (42) Landrum, P.F. (1989). Bioavailability and toxicokinetics of polycyclic aromatic hydrocarbons sorbed to sediments for the amphipod *Pontoporeia hoyi*. *Environ. Sci. Toxicol.* 23, 588-595.
- (43) Poddubnaya, T.L. (1980). Life cycles of mass species of Tubificidae (Oligochaeta). In: R.O. Brinkhurst and D.G. Cook (eds.): *Aquatic Oligochaeta Biology*, 175-184. Plenum Press, New York.
- (44) ASTM (1998). Standard guide for collection, storage, characterisation, and manipulation of sediment for toxicological testing. American Society for Testing and Materials, E 1391-94.
- (45) Hooftman, R.N., van de Guchte, K. & Roghair, C.J. (1993). Development of ecotoxicological test systems to assess contaminated sediments. Joint report no. 1: Acute and (sub)chronic tests with the model compound chlorpyrifos. RIVM-719102022.
- (46) Franke, C. (1996). How meaningful is the bioconcentration factor for risk assessment?. *Chemosphere* 32, 1897-1905.
- (47) Mount, D.R., Dawson, T.D. & Burkhard, L.P. (1999). Implications of gut purging for tissue residues determined in bioaccumulation testing of sediment with *Lumbriculus variegatus*. *Environ. Toxicol. Chem.* 18, 1244-1249.
- (48) Randall, R.C., Lee II, H., Ozretich, R.J., Lake, J.L. & Pruell, R.J. (1991). Evaluation of selected lipid methods for normalising pollutant bioaccumulation. *Environ. Toxicol. Chem.* 10, 1431-1436.
- (49) Gardner, W.S., Frez, W.A., Cichocki, E.A. & Parrish, C.C. (1985). Micromethods for lipids in aquatic invertebrates. *Limnology and Oceanography*, 30, 1099-1105.
- (50) Bligh, E.G. & Dyer, W.J. (1959). A rapid method of total lipid extraction and purification. *Can. J. Biochem. Physiol.* 37, 911-917.
- (51) De Boer, J., Smedes, F., Wells, D. & Allan, A. (1999). Report on the QUASH interlaboratory study on the determination of total-lipid in fish and shellfish. Round 1 SBT-2. Exercise 1000. EU, Standards, Measurement and Testing Programme.
- (52) Kristensen, P. (1991). Bioconcentration in fish: comparison of bioconcentration factors derived from OECD and ASTM testing methods; influence of particulate matter to the bioavailability of chemicals. Water Quality Institute, Denmark.
- (53) Zok, S., Gorge, G., Kalsch, W. & Nagel, R. (1991). Bioconcentration, metabolism and toxicity of substituted anilines in the zebrafish (*Brachydanio rerio*). *Sci. Total Environment* 109/110, 411-421
- (54) Nagel, R. (1988). *Umweltchemikalien und Fische — Beiträge zu einer Bewertung*. Habilitationsschrift, Johannes Gutenberg-Universität Mainz, Germany.
- (55) Janssen, M.P.M., A Bruins, T.H. De Vries & Van Straalen, N.M. (1991). Comparison of cadmium kinetics in four soil arthropod species. *Arch. Environ. Contam. Toxicol.* 20: 305-312.
- (56) Van Brummelen, T.C. & Van Straalen, N.M. (1996). Uptake and elimination of benzo(a)pyrene in the terrestrial isopod *Porcellio scaber*. *Arch. Environ. Contam. Toxicol.* 31: 277-285.

▼ **M6**

- (57) Sterenberg, I., Vork, N.A., Verkade, S.K., Van Gestel, C.A.M. & Van Straalen, N.M. (2003). Dietary zinc reduces uptake but not metallothionein binding and elimination of cadmium in the springtail *Orchesella cincta*. *Environ. Toxicol. Chemistry* 22: 1167-1171.
- (58) Suedel, B.C. and Rodgers, J.H. (1993). Development of formulated reference sediments for freshwater and estuarine sediment testing. *Environ. Toxicol. Chem.* 13, 1163-1175.
- (59) Wachs, B. (1967). Die Oligochaeten-Fauna der Fließgewässer unter besonderer Berücksichtigung der Beziehung zwischen der Tubificiden-Besiedlung und dem Substrat. *Arch. Hydr.* 63, 310-386.
- (60) Oliver, B. G. (1987). Biouptake of chlorinated hydrocarbons from laboratory-spiked and field sediments by oligochaete worms. *Environ. Sci. Technol.* 21, 785-790.
- (61) Chapman, P.M., Farrell, M.A. & Brinkhurst, R.O. (1982a). Relative tolerances of selected aquatic oligochaetes to individual pollutants and environmental factors. *Aquatic Toxicology* 2, 47-67.
- (62) Chapman, P.M., Farrell, M.A. & Brinkhurst, R.O. (1982b). Relative tolerances of selected aquatic oligochaetes to combinations of pollutants and environmental factors. *Aquatic Toxicology* 2, 69-78.
- (63) Rodriguez, P. & Reynoldson, T.B. (1999). Laboratory methods and criteria for sediment bioassessment. In: A. Mudroch, J.M. Azcue & P. Mudroch (eds.): *Manual of Bioassessment of aquatic sediment quality*. Lewis Publishers, Boca Raton, CRC Press LLC.
- (64) Brinkhurst, R.O. (1971). A guide for the identification of British aquatic oligochaeta. *Freshw. Biol. Assoc., Sci. Publ. No.* 22.
- (65) Egeler, Ph., Meller, M., Schallnaß, H.J. & Gilberg, D. (2005). Validation of a sediment toxicity test with the endobenthic aquatic oligochaete *Lumbriculus variegatus* by an international ring test. In co-operation with R. Nagel and B. Karaoglan. Report to the Federal Environmental Agency (Umweltbundesamt Berlin), R&D No.: 202 67 429.
- (66) Aston, R.J., Sadler, K. & Milner, A.G.P. (1982). The effect of temperature on the culture of *Branchiura sowerbyi* (Oligochaeta: Tubificidae) on activated sludge. *Aquaculture* 29, 137-145.
- (67) Roghair, C.J., Buijze, A., Huys, M.P.A., Wolters-Balk, M.A.H., Yedema, E.S.E. & Hermens, J.L.M. (1996). Toxicity and toxicokinetics for benthic organisms; II: QSAR for base-line toxicity to the midge *Chironomus riparius* and the tubificid oligochaete worm *Branchiura sowerbyi*. RIVM Report 719101026.
- (68) Aston, R.J. (1984). The culture of *Branchiura sowerbyi* (Tubificidae, Oligochaeta) using cellulose substrate. *Aquaculture* 40, 89-94.
- (69) Bonacina, C., Pasteris, A., Bonomi, G. & Marzuoli, D. (1994). Quantitative observations on the population ecology of *Branchiura sowerbyi* (Oligochaeta, Tubificidae). *Hydrobiologia*, 278, 267-274.

▼M7**C.47. FISH, EARLY-LIFE STAGE TOXICITY TEST****INTRODUCTION**

1. This test method is equivalent to OECD test guideline (TG) 210 (2013). Tests with the early-life stages of fish are intended to define the lethal and sub-lethal effects of chemicals on the stages and species tested. They yield information of value for the estimation of the chronic lethal and sub-lethal effects of the chemical on other fish species.
2. Test guideline 210 is based on a proposal from the United Kingdom which was discussed at a meeting of OECD experts convened at Medmenham (United Kingdom) in November 1988 and further updated in 2013 to reflect experience in using the test and recommendations from an OECD workshop on fish toxicity testing, held in September 2010 (1).

PRINCIPLE OF THE TEST

3. The early-life stages of fish are exposed to a range of concentrations of the test chemical dissolved in water. Flow-through conditions are preferred; however, if it is not possible semi-static conditions are acceptable. For details the OECD guidance document on aquatic toxicity testing of difficult substances and mixtures should be consulted (2). The test is initiated by placing fertilised eggs in test chambers and is continued for a species-specific time period that is necessary for the control fish to reach a juvenile life-stage. Lethal and sub-lethal effects are assessed and compared with control values to determine the lowest observed effect concentration (LOEC) in order to determine the (i) no observed effect concentration (NOEC) and/or (ii) EC_x (e.g. EC₁₀, EC₂₀) by using a regression model to estimate the concentration that would cause a x % change in the effect measured. Reporting of relevant effect concentrations and parameters may depend upon the regulatory framework. The test concentrations should bracket the EC_x so that the EC_x comes from interpolation rather than extrapolation (see Appendix 1 for definitions).

INFORMATION ON THE TEST CHEMICAL

4. Test chemical refers to what is being tested. The water solubility (see chapter A.6 of this Annex) and the vapour pressure (see chapter A.4 of this Annex) of the test chemical should be known and a reliable analytical method for the quantification of the chemical in the test solutions with known and reported accuracy and limit of quantification should be available. Although not necessary to conduct the test, results from an acute toxicity test (see chapters C.1 or C.49 of this Annex), preferably performed with the species chosen for this test, may provide useful information.
5. If the test method is used for the testing of a mixture, its composition should as far as possible be characterised, e.g. by the chemical identity of its constituents, their quantitative occurrence and their substance-specific properties (like those mentioned above). Before use of the test method for regulatory testing of a mixture, it should be considered whether it will provide acceptable results for the intended regulatory purpose.
6. Useful information includes the structural formula, purity of the substance, water solubility, stability in water and light, pK_a, P_{ow} and results of a test for ready biodegradability (e.g. chapters C.4 or C.29 of this Annex).

▼M7

VALIDITY OF THE TEST

7. For a test to be valid the following conditions apply:
 - the dissolved oxygen concentration should be > 60 % of the air saturation value throughout the test;
 - the water temperature should not differ by more than $\pm 1,5$ °C between test chambers or between successive days at any time during the test, and should be within the temperature ranges specified for the test species (Appendix 2);
 - the analytical measure of the test concentrations is compulsory.
 - overall survival of fertilised eggs and post-hatch success in the controls and, where relevant, in the solvent controls should be greater than or equal to the limits defined in Appendix 2.
8. If a minor deviation from the validity criteria is observed, the consequences should be considered in relation to the reliability of the test data and these considerations should be included in the report. Effects on survival, hatch or growth occurring in the solvent control, when compared to the negative control, should be reported and discussed in the context of the reliability of the test data.

DESCRIPTION OF THE METHOD

Test chambers

9. Any glass, stainless steel or other chemically inert vessels can be used. As silicone is known to have a strong capacity to absorb lipophilic substances, the use of silicone tubing in flow-through studies and use of silicone seals in contact with water should be minimised by the use of e.g. monoblock glass aquaria. The dimensions of the vessels should be large enough to allow proper growth in the control, maintenance of dissolved oxygen concentration (e.g. for small fish species, a 7 L tank volume will achieve this) and compliance with the loading rate criteria given in paragraph 19. It is desirable that test chambers be randomly positioned in the test area. A randomised block design with each treatment being present in each block is preferable to a completely randomised design. The test chambers should be shielded from unwanted disturbance. The test system should preferably be conditioned with concentrations of the test chemical for a sufficient duration to demonstrate stable exposure concentrations prior to the introduction of test organisms.

Selection of species

10. Recommended fish species are given in Table 1. This does not preclude the use of other species, but the test procedure may have to be adapted to provide suitable test conditions. The rationale for the selection of the species and the experimental method should be reported in this case.

Holding of the brood fish

11. Details on holding the brood stock under satisfactory conditions may be found in Appendix 3 and the references cited (3)(4)(5).

Handling of fertilised eggs, embryos and larvae

12. Initially, fertilised eggs, embryos and larvae may be exposed within the main vessel in smaller glass or stainless steel vessels, fitted with mesh sides or

▼ M7

ends to permit a flow of test solution through the vessel. Non-turbulent flow-through in these small vessels may be induced by suspending them from an arm arranged to move the vessel up and down but always keeping the organisms submerged. Fertilised eggs of salmonid fishes can be supported on racks or meshes with apertures sufficiently large to allow larvae to drop through after hatching.

13. Where egg containers, grids or meshes have been used to hold eggs within the main test vessel, these restraints should be removed after the larvae hatch, according to the guidance in Appendix 3, except that meshes should be retained to prevent the escape of the larvae. If there is a need to transfer the larvae, they should not be exposed to the air and nets should not be used to release larvae from egg containers. The timing of this transfer varies with the species and should be documented in the report. However, a transfer may not always be necessary.

Water

14. Any water in which the test species shows suitable long-term survival and growth may be used as test water (see Appendix 4). It should be of constant quality during the period of the test. In order to ensure that the dilution water will not unduly influence the test result (for example by complexation of test chemical), or adversely affect the performance of the brood stock, samples should be taken at intervals for analysis. Measurements of heavy metals (e.g. Cu, Pb, Zn, Hg, Cd, Ni), major anions and cations (e.g. Ca^{2+} , Mg^{2+} , Na^+ , K^+ , Cl^- , SO_4^{2-}), ammonia, total residual chlorine pesticides, total organic carbon and suspended solids should be made, for example, on a bi-annual basis where a dilution water is known to be relatively constant in quality. If the water is known to be of variable quality the measurements have to be conducted more often; the frequency is dependent of how variable the quality is. Some chemical characteristics of an acceptable dilution water are listed in Appendix 4.

Test solutions

15. For flow-through tests, a system which continually dispenses and dilutes a stock solution of the test chemical (e.g. metering pump, proportional diluter, saturator system) is required to deliver a series of concentrations to the test chambers. The flow rates of stock solutions and dilution water should be checked at intervals during the test and should not vary by more than 10 % throughout the test. A flow rate equivalent to at least five test chamber volumes per 24 hours has been found suitable (3). However, if the loading rate specified in paragraph 19 is respected, a lower flow rate of e.g. 2-3 test chamber volumes is possible to prevent quick removal of food.
16. Test solutions of the chosen concentrations are prepared by dilution of a stock solution. The stock solution should preferably be prepared by simply mixing or agitating the test chemical in dilution water by using mechanical means (e.g. stirring and/or ultrasonication). Saturation columns (solubility columns) or passive dosing methods (6) can be used for achieving a suitable concentrated stock solution. The use of a solvent carrier is not recommended. However, in case a solvent is necessary, a solvent control should be run in parallel, at the same solvent concentration as the chemical treatments; *i.e.* the solvent level should preferably be equal across all concentrations as well as the solvent control. For some diluter systems this might be technically difficult; here the solvent concentration in the solvent control should be equal to the highest solvent concentration in the treatment group. For difficult to test substances, the OECD Guidance Document No. 23 on aquatic toxicity testing of difficult substances and mixtures should be consulted (2). If a solvent is used, the choice of solvent will be determined by the chemical properties of the substance. The OECD Guidance Document No. 23 recommends a maximum concentration of 100 µl/l. To avoid potential effect of the solvent on endpoints

▼M7

measured (7), it is recommended to keep solvent concentration as low as possible.

17. For a semi-static test, two different renewal procedures may be followed. Either new test solutions are prepared in clean vessels and surviving eggs and larvae gently transferred into the new vessels, or the test organisms are retained in the test vessels whilst a proportion (at least two thirds) of the test solution / control volume is changed.

PROCEDURE**Conditions of Exposure***Duration*

18. The test should start as soon as possible after the eggs have been fertilised and preferably being immersed in the test solutions before cleavage of the blastodisc commences, or as close as possible after this stage. The test duration will depend upon the species used. Some recommended durations are given in Appendix 2.

Loading

19. The number of fertilised eggs at the start of the test should be sufficient to meet statistical requirements. They should be randomly distributed among treatments, and at least 80 eggs, divided equally between at least four replicate test chambers, should be used per concentration. The loading rate (biomass per volume of test solution) should be low enough in order that a dissolved oxygen concentration of at least 60 % of the air saturation value can be maintained without aeration during the egg and larval stage. For flow-through tests, a loading rate not exceeding 0,5 g/l wet weight per 24 hours and not exceeding 5 g/l of solution at any time has been recommended (3).

Light and temperature

20. The photoperiod and water temperature should be appropriate for the test species (see Appendix 2).

Feeding

21. Food and feeding are critical, and it is essential that the correct food for each life-stage is supplied from an appropriate time and at a level sufficient to support normal growth. Feeding should be approximately equal across replicates unless adjusted to account for mortality. Surplus food and faeces should be removed as necessary, to avoid accumulation of waste. Detailed feeding regimes are given in Appendix 3 but, as experience is gained, food and feeding regimes are continually being refined to improve survival and optimise growth. Live food provides a source of environmental enrichment and therefore should be used in place of or in addition to dry or frozen food whenever appropriate to the species and life stage.

Test concentrations

22. Normally five concentrations of the test chemical, with a minimum of four replicates per concentration, spaced by a constant factor not exceeding 3,2 are required. If available, information on the acute testing, preferable with the same species and/or a range finding test should be considered (1) when selecting the range of test concentrations. However, all sources of information should be considered when selecting the range of test concentrations, including sources like e.g. read across, fish embryo acute toxicity

▼ M7

test data. A limit test, or an extended limit test, with fewer than five concentrations as the definitive test may be acceptable where empirical NOECs only are to be established. Justification should be provided if fewer than five concentrations are used. Concentrations of the test chemical higher than the 96 hour LC₅₀ or 10 mg/l, whichever is the lower, need not be tested.

Controls

23. A dilution-water control and, if needed, a solvent control containing the solvent carrier only should be run in addition to the test chemical concentration series (see paragraph 16).

Frequency of Analytical Determinations and Measurements

24. Prior to initiation of the exposure period, proper function of the chemical delivery system across all replicates should be ensured (for example, by measuring test concentrations). Analytical methods required should be established, including an appropriate limit of quantification (LOQ) and sufficient knowledge on the substance stability in the test system. During the test, the concentrations of the test chemical are determined at regular intervals to characterise exposure. A minimum of five determinations is necessary. In flow-through systems, analytical measurements of the test chemical in one replicate per concentration should be made at least once a week changing systematically amongst replicates. Additional analytical determinations will often improve the quality of the test outcome. Samples may need to be filtered to remove any particulate matter (e.g. using a 0,45 µm pore size) or centrifuged to ensure that the determinations are made on the chemical in true solution. In order to reduce adsorption of the test chemical, the filters should be saturated before the use. When the measured concentrations do not remain within 80-120 % of the nominal concentration, the effect concentrations should be determined and expressed relative to the arithmetic mean concentration for flow-through tests (see Appendix 6 of the test method C.20 for the calculation of the arithmetic mean (8)), and expressed relative to the geometric mean of the measured concentrations for semi-static tests (see Chapter 5 in the OECD Guidance Document on aquatic toxicity testing of difficult substances and mixtures (2)).
25. During the test, dissolved oxygen, pH, and temperature should be measured in all test vessels, at least weekly, and salinity and hardness, if warranted, at the beginning and end of the test. Temperature should preferably be monitored continuously in at least one test vessel.

Observations

26. **Stage of embryonic development:** the embryonic stage at the beginning of exposure to the test chemical should be verified as precisely as possible. This can be done using a representative sample of eggs suitably preserved and cleaned.
27. **Hatching and survival:** observations on hatching and survival should be made at least once daily and numbers recorded. If fungus on eggs is observed early in embryonic development (e.g. at day one or two of test), those eggs should be counted and removed. Dead embryos, larvae and juvenile fish should be removed as soon as observed since they can decompose rapidly and may be broken up by the actions of the other fish. Extreme care should be taken when removing dead individuals not to physically damage adjacent eggs/larvae. Signs of death vary according to species and life stage. For example:

▼ M7

- for fertilised eggs: particularly in the early stages, a marked loss of translucency and change in colouration, caused by coagulation and/or precipitation of protein, leading to a white opaque appearance;
 - for embryos, larvae and juvenile fish: immobility and/or absence of respiratory movement and/or absence of heartbeat and/or lack of reaction to mechanical stimulus.
28. **Abnormal appearance:** the number of larvae or juvenile fish showing abnormality of body form should be recorded at adequate intervals depending on the duration of the test and the nature of the abnormality described. It should be noted that abnormal larvae and juvenile fish occur naturally and can be of the order of several percent in the control(s) in some species. Where deformities and associated abnormal behaviour are considered so severe that there is considerable suffering to the organism, and it has reached a point beyond which it will not recover, it may be removed from the test. Such animals should be euthanised and treated as mortalities for subsequent data analysis. Normal embryonic development has been documented for most species recommended in this test method (9) (10) (11) (12).
29. **Abnormal behaviour:** abnormalities, e.g. hyperventilation, uncoordinated swimming, atypical quiescence and atypical feeding behaviour should be recorded at adequate intervals depending on the duration of the test (e.g. once daily for warm water species). These effects, although difficult to quantify, can, when observed, aid in the interpretation of mortality data.
30. **Weight:** at the end of the test, all surviving fish are weighed at least on a replicate basis (reporting the number of animals in the replicate and the mean weight per animal): wet weight — (blotted dry) is preferred, however, dry weight data may also be reported (13).
31. **Length:** at the end of the test, individual lengths are measured. Total length is recommended, if however, caudal fin rot or fin erosion occurs, standard length can be used. The same method should be used for all fish in a given test. Individual length can be measured either by e.g. callipers, digital camera, or calibrated ocular micrometer. Typical minimum lengths are defined in Appendix 2.

DATA AND REPORTING

Treatment of results

32. It is recommended that the design of the experiment and selection of statistical test permit adequate power (80 % or higher) to detect changes of biological importance in endpoints where a NOEC is to be reported. Reporting of relevant effect concentrations and parameters may depend upon the regulatory framework. If an EC_x is to be reported, the design of the experiment and selection of regression model should permit estimation of EC_x so that (i) the 95 % confidence interval reported for EC_x does not contain zero and is not overly wide, (ii) the 95 % confidence interval for the predicted mean at EC_x does not contain the control mean (iii) there is no significant lack-of-fit of regression model to the data. Either approach requires the identification of the percent change in each endpoint that is important to detect or estimate. The experimental design should be tailored to allow that. When the above conditions for determining the EC_x are not satisfied, the NOEC approach should be used. It is not likely that the same percent change applies to all endpoints, nor is it likely that a feasible experiment can be designed that will meet these criteria for all endpoints, so it is important to focus on the endpoints, which are important for the respective experiment in designing the experiment appropriately. Statistical

▼ **M7**

flow diagrams and guidance for each approach are available in Appendixes 5 and 6 to guide in the treatment of data and in the choice of the most appropriate statistical test or model to use. Other statistical approaches may be used, provided they are scientifically justified.

33. It will be necessary for variations to be analysed within each set of replicates using analysis of variance or contingency table procedures and appropriate statistical analysis methods be used based on this analysis. In order to make a multiple comparison between the results at the individual concentrations and those for the controls, the step-down Jonckheere-Terpstra or Williams' test is recommended for continuous responses and a step-down Cochran-Armitage test for quantal responses that are consistent with a monotone concentration-response and with no evidence of extra-binomial variance (14). When there is evidence of extra-binomial variance, the Rao-Scott modification of the Cochran-Armitage test is recommended (15) (16) or Williams or Dunnett's (after an arcsin-square-root transform) or Jonckheere-Terpstra test applied to replicate proportions. Where the data are not consistent with a monotone concentration-response, Dunnett's or Dunn's or the Mann-Whitney method may be found useful for continuous responses and Fisher's Exact test for quantal responses (14) (17) (18). Care should be taken where applying any statistical method or model to ensure that the requirements of the method or model are satisfied (e.g. chamber to chamber variability is estimated and accounted for in the experimental design and test or model used). Data are to be evaluated for normality and Appendix 5 indicates what should be done on the residuals from an ANOVA. Appendix 6 discusses additional considerations for the regression approach. Transformations to meet the requirements of a statistical test should be considered. However, transformations to enable the fitting of a regression model require great care, as, for example, a 25 % change in the untransformed response does not correspond to a 25 % change in a transformed response. In all analyses, the test chamber, not the individual fish, is the unit of analysis and the experimental unit and both hypothesis tests and regression should reflect that (3) (14) (19) (20).

Test report

34. The test report should include the following information:

Test chemical:

Mono-constituent substance

- physical appearance, water solubility, and additional relevant physico-chemical properties;
- chemical identification, such as IUPAC or CAS name, CAS number, SMILES or InChI code, structural formula, purity, chemical identity of impurities as appropriate and practically feasible, etc. (including the organic carbon content, if appropriate).

Multi-constituent substance, UVCBs and mixtures:

- characterised as far as possible, *e.g.*, by chemical identity (see above), quantitative occurrence and relevant physicochemical properties of the constituents

Test species:

- scientific name, strain, source and method of collection of the fertilised eggs and subsequent handling.

▼ M7*Test conditions:*

- test procedure used (e.g. semi-static or flow-through, loading);
- photoperiod(s);
- test design (e.g. number of test chambers and replicates, number of eggs per replicate, material and size of the test chamber (height, width, volume), water volume per test chamber);
- method of preparation of stock solutions and frequency of renewal (the solubilising agent and its concentration should be given, when used);
- method of dosing the test chemical (e.g. pumps, diluting systems)
- the recovery efficiency of the method and the nominal test concentrations, the limit of quantification, the means of the measured values and their standard deviations in the test vessels and the method by which these were attained and evidence that the measurements refer to the concentrations of the test chemical in true solution;
- dilution water characteristics: pH, hardness, temperature, dissolved oxygen concentration, residual chlorine levels (if measured), total organic carbon (if measured), suspended solids (if measured), salinity of the test medium (if measured) and any other measurements made;
- water quality within test vessels, pH, hardness, temperature and dissolved oxygen concentration;
- detailed information on feeding (e.g. type of food(s), source, amount given and frequency).

Results reported individually (or on a replicate basis) and as mean and coefficient of variation, as appropriate, for the following endpoints:

- evidence that controls met the overall survival acceptability standard of the test species (Appendix 2);
- data on mortality at each stage (embryo, larval and juvenile) and cumulative mortality;
- days to hatch, numbers of larvae hatched each day, and end of hatching;
- number of healthy fish at end of test;
- data for length (specify either standard or total) and weight of surviving animals;
- incidence, description and number of morphological abnormalities, if any;
- incidence, description and number of behavioural effects, if any;
- approach for the statistical analysis (regression analysis or analysis of the variance) and treatment of data (statistical test or model used);
- no observed effect concentration for each response assessed (NOEC);

▼ **M7**

- lowest observed effect concentration (at $p = 0,05$) for each response assessed (LOEC);
- EC_x for each response assessed, if applicable, and confidence intervals (e.g. 90 % or 95 %) and a graph of the fitted model used for its calculation, the slope of the concentration-response curve, the formula of the regression model, the estimated model parameters and their standard errors.

Any deviation from the test method.

Discussion of the results, including any influence of deviations from the test method on the outcome of the test.

Table 1

Fish species recommended for testing

FRESHWATER	ESTUARINE and MARINE
<i>Oncorhynchus mykiss</i> Rainbow trout	<i>Cyprinodon variegatus</i> Sheepshead minnow
<i>Pimephales promelas</i> Fathead minnow	<i>Menidia</i> sp. Silverside
<i>Danio rerio</i> Zebrafish	
<i>Oryzias latipes</i> Japanese ricefish or Medaka	

LITERATURE:

- (1) OECD (2012), Fish Toxicity Testing Framework, Environmental Health and Safety Publications Series on Testing and Assessment No.171, OECD, Paris.
- (2) OECD (2000), Guidance Document on Aquatic Toxicity Testing of Difficult Substances and Mixtures, Environmental Health and Safety Publications, Series on Testing and Assessment. No. 23, OECD Paris.
- (3) ASTM (1988), Standard Guide for Conducting Early Life-Stage Toxicity Tests with Fishes. American Society for Testing and Materials, E 1241-88. 26 pp.
- (4) Brauhn, J.L. and R.A. Schoettger (1975), Acquisition and Culture of Research Fish: Rainbow trout, Fathead minnows, Channel catfish and Bluegills, Ecological Research Series, EPA-660/3-75-011, Duluth, Minnesota.
- (5) Brungs, W.A. and B.R. Jones (1977), Temperature Criteria for Freshwater Fish: Protocol and Procedures, Ecological Research Series EPA-600/3-77-061, Duluth, Minnesota.
- (6) Adolfsson-Erici, *et al.* (2012), A flow-through passive dosing system for continuously supplying aqueous solutions of hydrophobic chemicals to bioconcentration and aquatic toxicity tests, Chemosphere 86, 593-599.
- (7) Hutchinson, T.H. *et al.* (2006), Acute and chronic effects of carrier solvents in aquatic organisms: A critical review, Aquatic Toxicology, 76, 69-92.
- (8) Chapter C.20 of this Annex, *Daphnia magna* Reproduction Test.
- (9) Hansen, D.J. and P.R. Parrish (1977), Suitability of sheepshead minnows (*Cyprinodon variegatus*) for life-cycle toxicity tests, In Aquatic Toxicology and Hazard Evaluation (edited by F.L. Mayer and J.L. Hamelink), ASTM STP 634.
- (10) Kimmel, H. B. *et al.* (1995), Stages of embryonic development of the zebrafish. Developmental Dynamics, 203:253–310.

▼ M7

- (11) Gonzalez-Doncel, M. *et al* (2005), A quick reference guide to the normal development of *Oryzias latipes* (Teleostei, Adrinichthyidae) *Journal of Applied Ichthyology*, 20:1–14.
- (12) Devlin, E.W. *et al.* (1996), Prehatching Development of the Fathead Minnow, *Pimephales promelas* Rafinesque. EPA/600/R-96/079. USEPA, Office of Research and Development, Washington, D.C..
- (13) Oris, J.T., S.C. Belanger, and A.J. Bailer, (2012), Baseline characteristics and statistical implications for the OECD 210 Fish Early Life Stage Chronic Toxicity Test, *Environmental Toxicology and Chemistry* 31; 2, 370 - 376.
- (14) OECD (2006). *Current Approaches in the Statistical Analysis of Ecotoxicity Data: A Guidance to Application*, Environmental Health and Safety Publications Series on Testing and Assessment No.54, OECD, Paris.
- (15) Rao, J.N.K. and A.J. Scott (1992), A simple method for the analysis of clustered binary data, *Biometrics* 48, 577-585.
- (16) Rao, J.N.K. and A.J. Scott (1999), A simple method for analyzing over-dispersion in clustered Poisson data, *Statistics in Medicine* 18, 1373-1385.
- (17) Dunnett C.W. (1955), A multiple comparisons procedure for comparing several treatments with a control, *Journal of American Statistical Association*, 50, 1096-1121.
- (18) Dunnett C.W. (1964), New tables for multiple comparisons with a control. *Biometrics*, 20, 482-491.
- (19) Rand, G.M. and S.R. Petrocelli (1985), *Fundamentals of Aquatic Toxicology*. Hemisphere Publication Corporation, New York.
- (20) McClave, J.T., J.H. Sullivan and J.G. Pearson (1980). *Statistical Analysis of Fish Chronic Toxicity Test Data*, Proceedings of 4th Aquatic Toxicology Symposium, ASTM, Philadelphia.

▼ **M7***Appendix 1*

DEFINITIONS:

Fork length (FL): refers to the length from the tip of the snout to the end of the middle caudal fin rays and is used in fishes in which it is difficult to tell where the vertebral column ends (www.fishbase.org)

Standard length (SL): refers to the length of a fish measured from the tip of the snout to the posterior end of the last vertebra or to the posterior end of the midlateral portion of the hypural plate. Simply put, this measurement excludes the length of the caudal fin. (www.fishbase.org)

Total length (TL): refers to the length from the tip of the snout to the tip of the longer lobe of the caudal fin, usually measured with the lobes compressed along the midline. It is a straight-line measure, not measured over the curve of the body (www.fishbase.org)

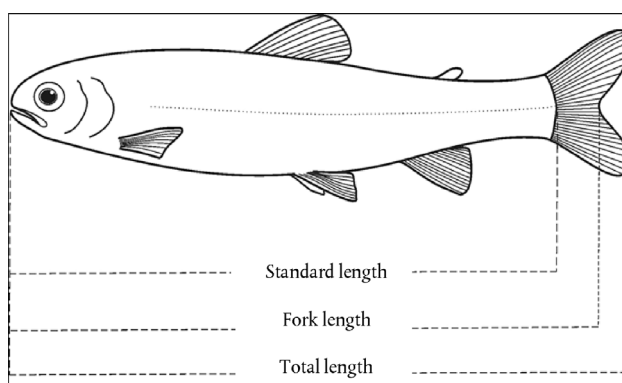
*Figure 1***Description of the different lengths used**

Chemical: a substance or a mixture

EC_x: (Effect concentration for x % effect) is the concentration that causes an x % of an effect on test organisms within a given exposure period when compared with a control. For example, an EC₅₀ is a concentration estimated to cause an effect on a test end point in 50 % of an exposed population over a defined exposure period.

Lowest observed effect concentration (LOEC) is the lowest tested concentration of a test chemical at which the chemical is observed to have a statistically significant effect (at $p < 0,05$) when compared with the control. However, all test concentrations above the LOEC should have a harmful effect equal to or greater than those observed at the LOEC. When these two conditions cannot be satisfied, a full explanation should be given for how the LOEC (and hence the NOEC) has been selected. Appendixes 5 and 6 provide guidance.

No observed effect concentration (NOEC) is the test concentration immediately below the LOEC, which when compared with the control, has no statistically significant effect ($p < 0,05$), within a stated exposure period.

Test chemical: Any substance or mixture tested using this test method

UVCB: substances of unknown or variable composition, complex reaction products or biological materials.

IUPAC: International Union of Pure and Applied Chemistry.

SMILES: Simplified Molecular Input Line Entry Specification.

TEST CONDITIONS, DURATION AND SURVIVAL CRITERIA FOR RECOMMENDED SPECIES

SPECIES	TEST CONDITIONS			RECOMMENDED DURATION OF TEST	Typical minimum mean total length of control fish at the end of the study (mm) ⁽¹⁾	SURVIVAL OF CONTROLS (minimum)	
	Temperature (°C)	Salinity (‰)	Photoperiod (hrs)			Hatching success	Post-hatch success
Freshwater:							
<i>Oncorhynchus mykiss</i> Rainbow trout	10 ± 1,5 ⁽²⁾		12 - 16 ⁽³⁾	2 weeks after controls are free-feeding (or 60 days post-hatch)	40	75 %	75 %
<i>Pimephales promelas</i> Fathead minnow	25 ± 1,5		16	32 days from start of test (or 28 days post-hatch)	18	70 %	75 %
<i>Danio rerio</i> Zebrafish	26 ± 1,5		12 - 16 ⁽⁴⁾	30 days post-hatch	11	70 %	75 %
<i>Oryzias latipes</i> Japanese Ricefish or Medaka	25 ± 2		12 - 16 ⁽⁴⁾	30 days post-hatch	17	80 %	80 %
Estuarine and Marine:							
<i>Cyprinodon variegatus</i> Sheepshead minnow	25 ± 1,5	15-35 ⁽⁵⁾	12 - 16 ⁽⁴⁾	32 days from start of test (or 28 days post-hatch)	17	75 %	80 %
<i>Menidia sp.</i> Silverside	22 - 25	15-35 ⁽⁵⁾	13	28 days	20	80 %	60 %

Key:

- (1) Typical minimum mean total length is not a validity criterion but deviations below the figure indicated should be carefully examined in relation to the sensitivity of the test. The minimum mean total length is derived from a selection of data available at the current time.
- (2) The particular strain of rainbow trout tested may necessitate the use of other temperatures. Brood stock must be held at the same temperature as that to be used for the eggs. After receipt of eggs from a commercial breeder, a short adaptation (e.g. 1-2 h) to test temperature after arrival is necessary.
- (3) Darkness for larvae until one week after hatching except when they are being inspected, then subdued lighting throughout test (12-16 hour photoperiod) ⁽⁴⁾.
- (4) For any given test conditions, light regime should be constant.
- (5) For any given test this shall be performed to ± 2 ‰.

FEEDING AND HANDLING GUIDANCE FOR BROOD AND TEST ANIMALS OF RECOMMENDED SPECIES

SPECIES	FOOD (*)				POST-HATCH TRANSFER TIME	TIME TO FIRST FEEDING
	Brood fish	Newly-hatched larvae	Juveniles			
			Type	Frequency		
Freshwater:						
<i>Oncorhynchus mykiss</i> Rainbow trout	trout food	None ^(a)	trout starter BSN	2-4 feeds per day	14-16 days post-hatch or at swim-up (not essential)	19 days post hatch or at swim-up
<i>Pimephales promelas</i> Fathead minnow	BSN, flake food, FBS	BSN	BSN48, flake food	2-3 times a day	once hatching is 90 %	2 day post hatch
<i>Danio rerio</i> Zebrafish	BSN, flake food	Commercial larvae food, protozoa ^(b) , protein ^(c)	BSN48, flake food,	BSN once daily; flake food twice daily	once hatching is 90 %	2 days post hatch
<i>Oryzias latipes</i> Japanese Ricefish or Medaka	flake food	BSN, flake food (or protozoa or rotifers)	BSN48, flake food (or rotifers)	BSN once daily; flake food twice daily <u>or</u> flake food and rotifers once daily	not applicable	6-7 days post spawn
Estuarine and Marine:						
<i>Cyprinodon variegatus</i> Sheepshead minnow	BSN, flake food, FBS	BSN	BSN48	2-3 feeds per day	not applicable	1 day post hatch/swim-up
<i>Menidia sp.</i> Silverside	BSN48, flake food	BSN	BSN48	2-3 feeds per day	not applicable	1 day post hatch/swim-up

Key:

(*) Food should be given to satiation. Surplus food and faeces should be removed, as necessary to avoid accumulation of waste

FBS frozen brine shrimps; adults *Artemia* sp

BSN brine shrimp nauplii; newly hatched

BSN48 brine shrimp nauplii; 48 hours old

^(a) yolk-sac larvae require no food

^(b) filtered from mixed culture

^(c) granules from fermentation process.

▼ **M7***Appendix 4***SOME CHEMICAL CHARACTERISTICS OF AN ACCEPTABLE DILUTION WATER**

Component	Limit concentration
Particulate matter	5 mg/l
Total organic carbon	2 mg/l
Un-ionised ammonia	1 µg/l
Residual chlorine	10 µg/l
Total organophosphorous pesticides	50 ng/l
Total organochlorine pesticides plus polychlorinated biphenyls	50 ng/l
Total organic chlorine	25 ng/l
Aluminium	1 µg/l
Arsenic	1 µg/l
Chromium	1 µg/l
Cobalt	1 µg/l
Copper	1 µg/l
Iron	1 µg/l
Lead	1 µg/l
Nickel	1 µg/l
Zinc	1 µg/l
Cadmium	100 ng/l
Mercury	100 ng/l
Silver	100 ng/l

▼ **M7***Appendix 5***STATISTICAL GUIDANCE FOR NOEC DETERMINATION****General**

The replicate tank is the unit of analysis. Thus, for continuous measurements, such as size, the replicate mean or median should be calculated and these replicate values are the data for analysis. The power of the tests used should be demonstrated, preferably based on an adequate historical database for each lab. The size effect that can be detected with 75-80 % power should be provided for each endpoint with the statistical test to be used.

The databases available at the time of development of this test method establish the power possible under the recommended statistical procedures. An individual lab should demonstrate its ability to meet this power requirement either by conducting its own power analysis or by demonstrating that the Coefficient of Variation (CV) for each response does not exceed the 90th percentile of CVs used in developing the TG. Table 1 provides these CVs. If only replicate means or medians are available, then the within-replicate CV can be ignored.

*Table 1***90th Percentile CVs for selected Freshwater Species**

Species	Response	CV_Between Replicates	CV_Within Replicates
Rainbow Trout	Length	17,4	9,8
	Weight	10,1	28
Fathead Minnow	Length	16,9	13,5
	Weight	11,7	38,7
Zebrafish	Length	43,7	11,7
	Weight	11,9	32,8

For almost all statistical tests used to evaluate laboratory toxicology studies, the comparisons of interest are of treatment groups to control. For that reason, it is not appropriate to require a significant ANOVA F-test before using Dunnett's or Williams' test or a significant Kruskal-Wallis test before using the Jonckheere-Terpstra, Mann-Whitney, or Dunn test (Hochberg and Tamhane 1987, Hsu 1996, Dunnett 1955, 1964, Williams 1971, 1972, 1975, 1977, Robertson *et al.* 1988, Jonckheere 1954, Dunn 1964).

Dunnett's test has a built-in multiplicity adjustment and its false positive and false negative rates are adversely affected by using the F-test as a gatekeeper. Similarly, the step-down Williams and Jonckheere-Terpstra tests using a 0,05 significance level at every step preserve an overall 5 % false positive rate and that rate and the power of the tests are adversely affected by using the F- or Kruskal-Wallis test as a gatekeeper. Mann-Whitney and Dunn's test have to be adjusted for multiplicity and the Bonferroni-Holm adjustment is advised.

A thorough discussion of most of the recommendations on hypothesis testing and verification of assumptions underlying these tests is given in OECD (2006), which also contains an extensive bibliography.

▼ M7**Treatment of Controls when a Solvent is Used**

If a solvent is used, then both a dilution water control and a solvent control should be included. The two controls should be compared for each response and combined for statistical analysis if no significant difference is found between the controls. Otherwise, the solvent control should be used for NOEC determination or EC_x estimation and the water control is not used. See restriction in the validity criteria (Paragraph 7)

For length, weight, proportion of egg hatch or larval mortality or abnormal larvae, and first or last day of hatch or swim-up, a T-test or Mann-Whitney test should be used to compare the dilution water- control and the solvent control at the 0,05 significance level, ignoring all treatment groups. The results of these tests should be reported.

Size Measurements (length and weight)

Individual fish length and weight values can be normally or log-normally distributed. In either case, the replicate mean values tend to be normally distributed by virtue of the Central Limit Theorem and confirmed from data from well over 100 ELS studies of three freshwater species. Alternatively, where the data or historical databases suggest a log-normal distribution for individual fish size values, the replicate mean logarithm of the individual fish values can be calculated and the data for analysis can then be the anti-logs of these replicate mean logarithms.

Data should be evaluated for consistency with a normal distribution and variance homogeneity. For this purpose, the residuals from an ANOVA model with concentration as the single explanatory class variable should be used. Visual determination from scatterplots and histograms or stem-and-leaf plots can be used. Alternatively, a formal test such as the Shapiro-Wilk or Anderson-Darling can be used. Consistency with variance homogeneity can be assessed from a visual examination of the same scatter plot or formally from Levene's test. Only parametric tests (e.g. Williams, Dunnett) need be evaluated for normality or variance homogeneity.

Attention should be paid to possible outliers and their effect on analysis. Tukey's outlier test and visual inspection of the same plots of residuals described above can be used. It should be recalled that observations are entire replicates, so omitting an outlier from analysis should be done only after careful consideration.

The statistical tests that make use of the characteristics of the experimental design and biological expectation are step-down trend tests, such as Williams and Jonckheere-Terpstra. These tests assume a monotone concentration-response and the data should be assessed for consistency with that assumption. This can be done visually from a scatter plot of the replicate means against test concentration. It will be helpful to overlay that scatter plot with a piecewise linear plot connecting the concentration means weighted by replicate sample size. Great deviation of this piecewise linear plot from monotonicity would indicate a possible need to use non-trend tests. Alternatively, formal tests can be used. A simple formal test is to compute linear and quadratic contrasts of the concentration means. If the quadratic contrast is significant and the linear contrast is not significant that is an indication of a possible problem with monotonicity which should be further evaluated from plots. Where normality or variance homogeneity may be an issue, these contrasts can be constructed from rank-order transformed data. Alternative procedures, such as Bartholomew's test for monotonicity can be used, but add complexity.

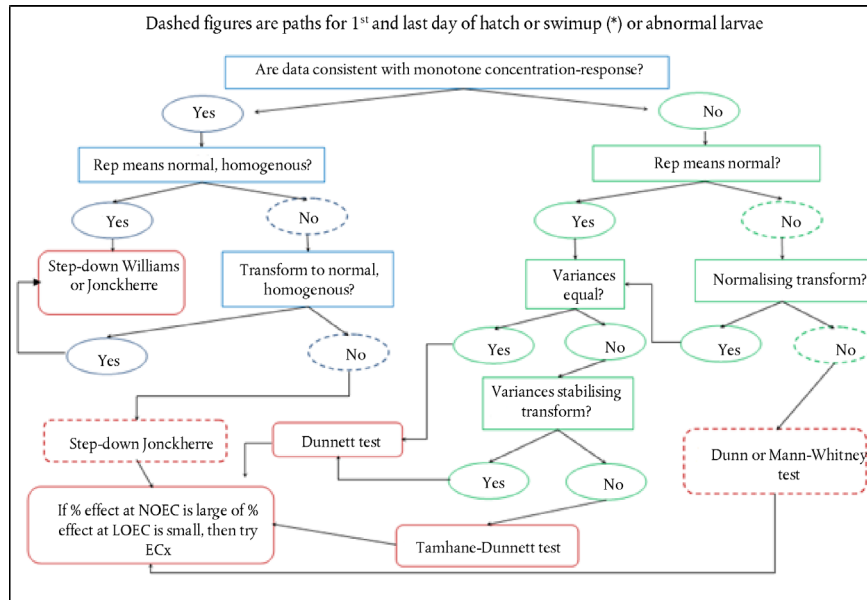
▼ **M7****Figure 2***NOEC Flow-Chart Size Measurements (length and weight)*

(*) These responses never satisfy assumptions for parametric analysis or models.

Unless the data are not consistent with the requirements for these tests, the NOEC is determined by a step-down application of Williams' or the Jonckheere-Terpstra test. OECD (2006) provides details on these procedures. For data not consistent with the requirements for a step-down trend test, Dunnett's test or the Tamhane-Dunnett (T3) test can be used, both of which have built-in adjustments for multiplicity. These tests assume normality and, in the case of Dunnett, variance homogeneity. Where those conditions are not satisfied, Dunn's non-parametric test can be used. OECD (2006) contains details for all of these tests. Figure 2 is giving an overview, how to find the test of choice.

Egg Hatch and Larval Survival

The data are proportions of eggs that hatch or larvae that survive in individual replicates. These proportions should be assessed for extra-binomial variance, which is common but not universal for such measurements. The flowchart in figure 3 is guidance for the test of choice; see text for detailed descriptions.

Two tests are commonly used. These are Tarone's $C(\alpha)$ test (Tarone, 1979) and chi-squared tests, each applied separately to every test concentration. If extra-binomial variance is found in even one test concentration, then methods that accommodate that should be used.

Formula 1

Tarone's $C(\alpha)$ test (Tarone 1979)

$$Z = \frac{\sum_{j=1}^m \frac{(x_j - n_j \hat{p})^2}{\hat{p}(1-\hat{p})} - \sum_{j=1}^m n_j}{\left\{ 2 \sum_{j=1}^m n_j(n_j - 1) \right\}^{1/2}}$$

Where \hat{p} is the mean proportion for a given concentration, m is the number of replicate tanks, n_j is the number of subjects in replicate j , and x_j is the number of

▼ **M7**

subjects in that replicate responding, e.g. not hatched or dead. This test is applied to each concentration separately. This test can be seen as an adjusted chi-squared test, but limited power simulations done by Tarone have shown it to be more powerful than a chi-squared test.

Figure 3

NOEC Flow Chart for Egg Hatch and Larval Mortality

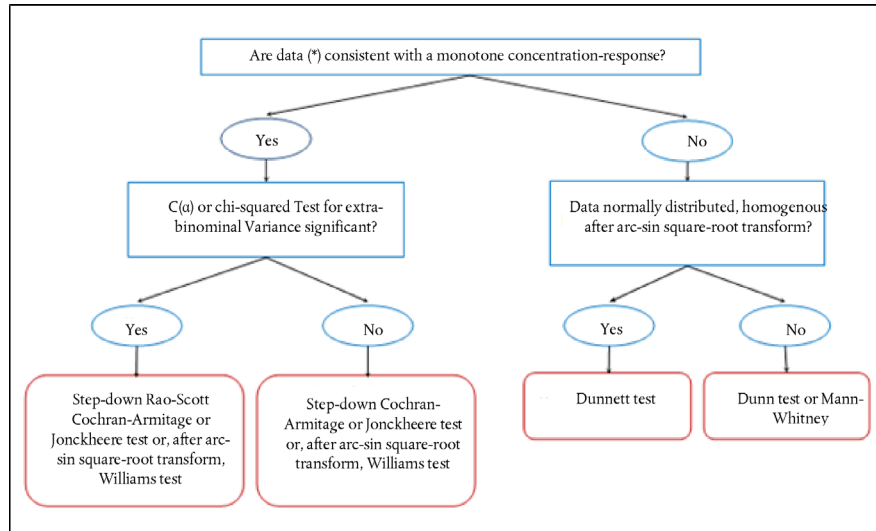

(*) Data are replicate proportion.

Where there is no significant evidence of extra-binomial variance, the step-down Cochran-Armitage test can be used. This test ignores replicates, so where there is such evidence, the Rao-Scott adjustment to the Cochran-Armitage test (RSCA) takes replicates, replicate sizes, and extra-binomial variance into account and is recommended. Alternative tests include the step-down Williams and Jonckheere-Terpstra tests and Dunnett's test as described for size measurements. These tests apply whether or not there is extra-binomial variance, but have somewhat lower power (Agresti 2002, Morgan 1992, Rao and Scott 1992, 1999, Fung *et al.* 1994, 1996).

First or Last Day of Hatch or Swim-up

The response is an integer, giving the test day on which the indicated observation is observed for a given replicate tank. The range of values is generally very limited and there are often high proportions of tied values, e.g. the same first day of hatch is observed in all control replicates and, perhaps in one or two low test concentrations. Parametric tests such as Williams and Dunnett are not appropriate for such data. Unless there is evidence on serious non-monotonicity, the step-down Jonckheere-Terpstra test is very powerful for detecting effects of the test chemical. Otherwise, Dunn's test can be used.

Larval Abnormalities

The response is the count of larvae found to be abnormal in some way. This response is frequently of low incidence and has some of the same problems as first day of hatch, as well as sometimes exhibiting erratic in concentration-response. If the data at least roughly follow a monotone concentration shape, the step-down Jonckheere-Terpstra test is powerful for detecting effects. Otherwise, Dunn's test can be used.

▼ **M7**

REFERENCES:

- Agresti, A. (2002); *Categorical Data Analysis*, second edition, Wiley, Hoboken.
- Dunnnett C. W. (1955); A multiple comparison procedure for comparing several treatments with a control, *J. American Statistical Association* 50, 1096-1121.
- Dunn O. J. (1964); Multiple Comparisons Using Rank Sums, *Technometrics* 6, 241-252.
- Dunnnett C. W. (1964); New tables for multiple comparisons with a control, *Biometrics* 20, 482-491.
- Fung, K.Y., D. Krewski, J.N.K. Rao, A.J. Scott (1994); Tests for Trend in Developmental Toxicity Experiments with Correlated Binary Data, *Risk Analysis* 14, 639-648.
- Fung, K.Y, D. Krewski, R.T. Smythe (1996); A comparison of tests for trend with historical controls in carcinogen bioassay, *Canadian Journal of Statistics* 24, 431-454.
- Hochberg, Y. and A. C. Tamhane (1987); *Multiple Comparison Procedures*, Wiley, New York.
- Hsu, J.C. (1996); *Multiple Comparisons: Theory and Methods*; Chapman and Hall/CRC Press, Boca Raton.
- Jonckheere A. R. (1954); A distribution-free k-sample test against ordered alternatives, *Biometrika* 41, 133.
- Morgan, B.J.T. (1992); *Analysis of Quantal Response Data*, Chapman and Hall, London.
- OECD (2006). *Current approaches in the statistical analysis of ecotoxicity data: A guidance to application. Series on Testing and Assessment, No. 54.* Organisation for Economic Co-operation and Development, OECD, Paris..
- Rao J.N.K. and Scott A.J. (1992) — A simple method for the analysis of clustered binary data, *Biometrics* 48, 577-585.
- Rao J.N.K. and Scott A.J. (1999) — A simple method for analyzing overdispersion in clustered Poisson data, *Statistics in Medicine* 18, 1373-1385.
- Robertson, T., Wright F.T. and Dykstra R.L. (1988); *Order restricted statistical inference*, Wiley.
- Tarone, R.E. (1979); Testing the goodness of fit of the Binomial distribution, *Biometrika* 66, 585-590.
- Williams D.A. (1971); A test for differences between treatment means when several dose levels are compared with a zero dose control, *Biometrics* 27, 103-117.
- Williams D.A. (1972); The comparison of several dose levels with a zero dose control, *Biometrics* 28, 519-531.
- Williams D. A. (1975); The Analysis of Binary Responses from Toxicological Experiments Involving Reproduction and Teratology, *Biometrics* 31, 949-952.
- Williams D.A. (1977); Some inference procedures for monotonically ordered normal means, *Biometrika* 64, 9-14.

▼ **M7**

Appendix 6

STATISTICAL GUIDANCE FOR REGRESSION ESTIMATES**General**

The observations used to fit a model are replicate means (length and weight) or replicate proportions (egg hatch and larval mortality) (OECD 2006).

Weighted regression using replicate sample size as weight is generally advised. Other weighting schemes are possible, such as weighting by predicted mean response or a combination of this and replicate sample size. Weighting by reciprocal of within-concentration sample variance is not recommended (Bunke *et al.* 1999, Seber and Wild, 2003, Motulsky and Christopoulos 2004, Huet *et al.* 2003).

Any transformation of responses prior to analysis should preserve the independence of the observations and EC_x and its confidence bounds should be expressed in the original units of measurement, rather than in transformed units. For example, a 20 % change in the logarithm of length is not equivalent to a 20 % change in length (Lyles *et al.* 2008, Draper and Smith 1999).

The flowchart in figure 4 gives an overview for EC_x estimations. The details are described in the text below.

Figure 4

Flow chart for EC_x Estimation of Replicate Mean Length, Weight, or Proportion of Egg Hatch or Larval Mortality, see text for more details

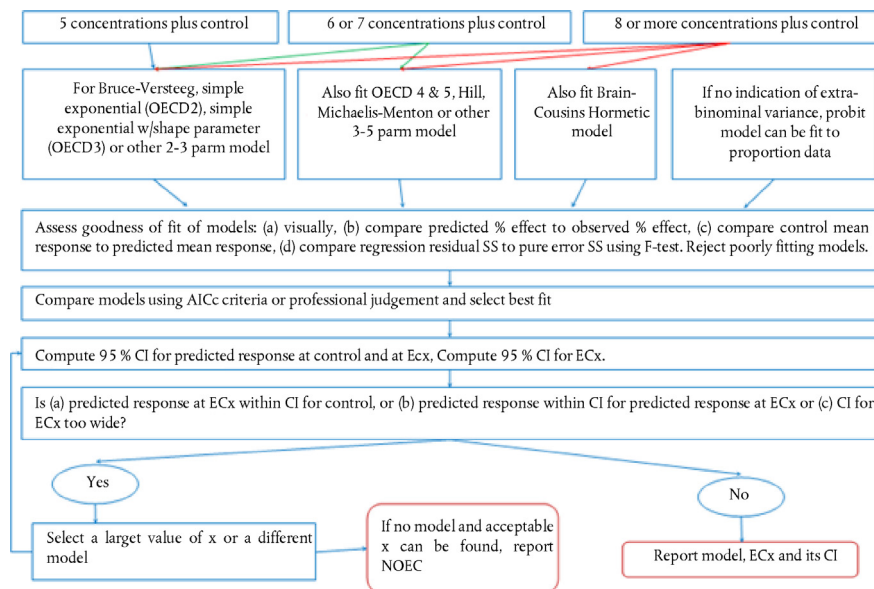
**Considerations for Egg Hatch and Larval Mortality**

For egg hatch and larval mortality, it is generally best to fit a decreasing model unless one is fitting a probit model as described below. That is, one should model the proportion of eggs that do not hatch or larvae that die. The reason for this is that EC_x refers to a concentration at which there is a change equal to x % of the control mean response. If there are 5 % control eggs that fail to hatch and one models failure to hatch, then EC₂₀ refers to a concentration at which there is a change equal to 20 % of the 5 % control failure to hatch, and that is a change of $0,2 \times 0,05 = 0,01$ or 1 percentage point to 6 % failure to hatch. Such a small change cannot be estimated in any meaningful way from the data available and is not biologically important. Whereas if one models the proportion of eggs that hatch, the control proportion would be 95 % in this example and a 20 % reduction from the control mean would be a change of $0,95 \times 0,2 = 0,18$, so

▼ M7

from 95 % hatch success to 77 % (= 95 – 18) hatching success and that effects concentration can be estimated and is presumably of greater interest. This is not an issue with size measurements, though adverse effects on size generally mean a decrease in size.

Models for Size (length or weight) and Egg Hatch Success or Larval Survival.

Except for the Brain-Cousens hormetic model, all of these models are described and recommended in OECD (2006). What are called OECD 2-5, are also discussed for ecotoxicity experiments in Slob (2002). There are, of course, many other models that might be useful. Bunke, *et al.* (1999) lists numerous models not included here and references to other models are plentiful. Those listed below are suggested as particularly appropriate in ecotoxicity experiments and widely used.

With 5 test concentrations plus control

- Bruce-Versteeg
- Simple Exponential (OECD 2)
- Exponential with shape parameter (OECD 3)
- Simple Exponential with Lower Bound (OECD 4)

With 6 or more test concentrations plus control

- Exponential with shape parameter and lower bound (OECD 5)
- Michaelis-Menten
- Hill

Where there is visual evidence of hormesis (unlikely with egg hatch success or larval survival, but sometimes observed in size observations)

- Brain-Cousens Hormetic; Brain and Cousens (1989)

Alternative models for egg hatch failure and larval mortality

- Increasing models for these responses can be fit by probit (or logistic) models if there is no evidence of extra-binomial variance and control incidence is estimated in the model fit. This is not the preferred method, as it treats the individual, not the replicate, as the unit of analysis (Morgan 1992, O'Hara Hines and Lawless 1993, Collett 2002, 2003).

Goodness of fit of a single model

- Visually compare observed and predicted percent decrease at each test concentration (Motulsky and Christopoulos 2004, Draper and Smith 1999).
- Compare regression error mean square against the pure error mean square using an F-test (Draper and Smith 1999).
- Check that every term in the model is significantly different from zero (i.e., determine whether all model terms are important), (Motulsky and Christopoulos 2004).

▼M7

- Plots of residuals from regression vs. test concentration, possibly on a log(conc) scale. There should be no pattern to this plot; the points should be randomly scattered about a horizontal line at zero height.
- The data should be evaluated for normality and variance homogeneity in the same way as indicated in Appendix 5.
- In addition, normality of the residuals about the regression model should be assessed using the same methods indicated in Appendix 5 for the residuals from ANOVA

Compare models

- Use Akaike's AICc criteria. Smaller AICc values denote better fits and if $AICc(B) - AICc(A) \geq 10$, the model A is almost certainly better than model B (Motulsky and Christopoulos (2004).
- Compare the two models visually by how well they meet the single model criteria above.
- The parsimony principal is advised, whereby the simplest model that fits the data reasonably well is used (Ratkowsky 1993, Lyles et.al 2008).

Quality of EC_x estimate

The confidence interval (CI) for EC_x should not be too wide. Statistical judgment is needed in deciding how wide the confidence interval can be and EC_x still be useful. Simulations for regression models fit to egg hatching and size data show that about 75 % of confidence intervals for EC_x (x = 10, 20 or 30) span no more than two test concentrations. This provides a general guide for what is acceptable and a practical guide for what is achievable. Numerous authors assert the need to report confidence intervals for all model parameters and that wide confidence intervals for model parameters indicate unacceptable models (Ott and Longnecker 2008, Alvord and Rossio 1993, Motulsky and Christopoulos 2004, Lyles *et al.* 2008, Seber and Wild 2003, Bunke *et al.* 1999, Environment Canada 2005).

The CI for EC_x (or any other model parameter) should not contain zero (Motulsky and Christopoulos 2004). This is the regression equivalent the minimum significant difference that is often cited in hypothesis testing approaches (e.g. Wang *et al* 2000). It also corresponds to the confidence interval for the mean responses at the LOEC not contain the control mean. One should wonder whether the parameter estimates are scientifically plausible. E.g. if the confidence interval for y₀ is $\pm 20\%$, no EC₁₀ estimate is plausible. If the model predicts a 20 % effect at a concentration C and the maximum observed effect at C and lower concentrations is 10 %, then the EC₂₀ is not plausible (Motulsky and Christopoulos 2004, Wang *et al.* 2000, Environment Canada 2005).

EC_x should not require extrapolation outside the range of positive concentrations (Draper and Smith 1999, OECD 2006). For example, a general guide might be for EC_x to be no more than about 25 % below the lowest tested concentration or above the highest tested concentration.

REFERENCES:

Alvord, W.G., Rossio, J.L. (1993); Determining confidence limits for drug potency in immunoassay, *Journal of Immunological Methods* 157, 155-163.

Brain P. and Cousens R. (1989); An equation to describe dose responses where there is stimulation of growth at low doses. *Weed res.* 29: 93-96.

▼ M7

- Bunke, O., Droge, B. and Polzehl, J. (1999). Model selection, transformations and variance estimation in nonlinear regression. *Statistics* 33, 197-240.
- Collett, D. (2002); *Modelling Binary Data*, second edition, Chapman and Hall, London.
- Collett, D. (2003); *Modelling Survival Data in Medical Research*, second edition, Chapman and Hall, London.
- Draper, N.R. and Smith, H. (1999); *Applied Regression Analysis*, third edition. New York: John Wiley & Sons.
- Environment Canada (2005); *Guidance Document on Statistical Methods for Environmental Toxicity Tests*, Report EPS 1/RM/46
- Huet, S., A. Bouvier, M.-A. Poursat, E. Jolivet (2003); *Statistical Tools for Nonlinear Regression: A Practical Guide with S-PLUS and R Examples*, Springer Series in Statistics, New York.
- Lyles, R. H., C. Poindexter, A. Evans, M. Brown, and C.R. Cooper (2008); Nonlinear Model-Based Estimates of IC50 for Studies Involving Continuous Therapeutic Dose-Response Data, *Contemp Clin Trials*. 2008 November; 29(6): 878–886.
- Morgan, B.J.T. (1992); *Analysis of Quantal Response Data*, Chapman and Hall, London.
- Motulsky, H., A. Christopoulos (2004); *Fitting Models to Biological Data Using Linear and Nonlinear Regression: A Practical Guide to Curve Fitting*, Oxford University Press, USA.
- O'Hara Hines, R. J. and J. F. Lawless (1993); Modelling Overdispersion in Toxicological Mortality Data Grouped over Time, *Biometrics* Vol. 49, pp. 107-121
- OECD (2006); *Current approaches in the statistical analysis of ecotoxicity data: A guidance to application*. Series Testing and Assessment, No. 54, Organisation for Economic Co-operation and Development, OECD, Paris.
- Ott, R.L., M.T. Longnecker, *An Introduction to Statistical Methods and Data Analysis*, sixth edition, 2008, Brooks-Cole, Belmont, CA
- Ratkowsky, D.A. (1993); Principles of nonlinear regression, *Journal of Industrial Microbiology* 12, 195-199.
- Seber, G.A.F., C.J. Wild, *Nonlinear Regression*, Wiley, 2003
- Slob W. (2002); Dose-response modelling of continuous endpoints. *Toxicol. Sci.*, 66, 298-312
- Wang, Q., D.L. Denton, and R. Shukla (2000); Applications and Statistical Properties Of Minimum Significant Difference-Based Criterion Testing In a Toxicity Testing Program, *Environmental Toxicology and Chemistry*, Vol. 19, pp. 113–117, 2000.

▼ M7

C.48. FISH SHORT TERM REPRODUCTION ASSAY

INTRODUCTION

1. This test method is equivalent to OECD test guideline (TG) 229 (2012). The need to develop and validate a fish assay capable of detecting endocrine active chemicals originates from the concerns that environmental levels of chemicals may cause adverse effects in both humans and wildlife due to the interaction of these chemicals with the endocrine system. In 1998, the OECD initiated a high-priority activity to revise existing guidelines and to develop new guidelines for the screening and testing of potential endocrine disruptors. One element of the activity was to develop a test guideline for the screening of chemicals active on the endocrine system of fish species. The Fish Short Term Reproduction Assay underwent an extensive validation programme consisting of inter-laboratory studies with selected chemicals to demonstrate the relevance and reliability of the assay for the detection of chemicals that impact reproduction in fish by various mechanisms including endocrine modalities (1, 2, 3, 4, 5). All endpoints of the OECD test guideline have been validated on the fathead minnow, and a subset of endpoints has been validated in the Japanese medaka (i.e. vitellogenin and secondary sex characteristics) and the zebrafish (i.e. vitellogenin). The validation work has been peer-reviewed by a panel of experts nominated by the National Coordinators of the OECD Test Guideline Programme (6) in part, and by an independent panel of experts commissioned by the United States Environmental Protection Agency (29). The assay is not designed to identify specific mechanisms of hormonal disruption because the test animals possess an intact hypothalamic-pituitary-gonadal (HPG) axis, which may respond to chemicals that impact on the HPG axis at different levels.
2. This test method describes an *in vivo* screening assay where sexually mature male and spawning female fish are held together and exposed to a chemical during a limited part of their life-cycle (21 days). At termination of the 21-day exposure period, two biomarker endpoints are measured in males and females as indicators of endocrine activity of the test chemical; these endpoints are vitellogenin and secondary sexual characteristics. Vitellogenin is measured in fathead minnow, Japanese medaka and zebrafish, whereas secondary sex characteristics are measured in fathead minnow and Japanese medaka. Additionally, quantitative fecundity is monitored daily throughout the test. Gonads are also preserved and histopathology may be evaluated to assess the reproductive fitness of the test animals and to add to the weight of evidence of other endpoints.
3. This bioassay serves as an *in vivo* reproductive screening assay and its application should be seen in the context of the ‘OECD Conceptual Framework for the Testing and Assessment of Endocrine Disrupting Chemicals’ (30). In this Conceptual Framework the Fish Short Term Reproduction Assay is proposed at Level 3 as an *in vivo* assay providing data about selected endocrine mechanism(s)/pathway(s).

INITIAL CONSIDERATIONS AND LIMITATIONS

4. Vitellogenin (VTG) is normally produced by the liver of female oviparous vertebrates in response to circulating endogenous oestrogen. It is a precursor of egg yolk proteins and, once produced in the liver, travels in the bloodstream to the ovary, where it is taken up and modified by developing eggs. Vitellogenin is almost undetectable in the plasma of immature female and male fish because they lack sufficient circulating oestrogen; however, the liver is capable of synthesising and secreting vitellogenin in response to exogenous oestrogen stimulation.

▼ M7

5. The measurement of vitellogenin serves for the detection of chemicals with various oestrogenic modes of action. The detection of oestrogenic chemicals is possible via the measurement of vitellogenin induction in male fish, and it has been abundantly documented in the scientific peer-reviewed literature (e.g. (7)). Vitellogenin induction has also been demonstrated following exposure to aromatisable androgens (8, 9). A reduction in the circulating level of oestrogen in females, for instance through the inhibition of the aromatase converting the endogenous androgen to the natural oestrogen 17 β -estradiol, causes a decrease in the VTG level which is used to detect chemicals having aromatase inhibiting properties (10, 11). The biological relevance of the vitellogenin response following oestrogenic/aromatase inhibition is established and has been broadly documented. However, it is possible that production of VTG in females can also be affected by general toxicity and non-endocrine toxic modes of action, e.g. hepatotoxicity.
6. Several measurement methods have been successfully developed and standardised for routine use. This is the case of species-specific Enzyme-Linked Immunosorbent Assay (ELISA) methods using immunochemistry for the quantification of VTG produced in small blood or liver samples collected from individual fish (12, 13, 14, 15, 16, 17, 18). Fathead minnow blood, zebrafish blood or head/tail homogenate, and medaka liver are sampled for VTG measurement. In medaka, there is a good correlation between VTG measured from blood and from liver (19). Appendix 6 provides the recommended procedures for sample collection for VTG analysis. Kits for the measurement of VTG are widely available; such kits should be based on a validated species-specific ELISA method.
7. Secondary sex characteristics in male fish of certain species are externally visible, quantifiable and responsive to circulating levels of endogenous androgens; this is the case for the fathead minnow and the medaka — but not for zebrafish which does not possess quantifiable secondary sex characteristics. Females maintain the capacity to develop male secondary sex characteristics, when they are exposed to androgenic chemicals in water. Several studies are available in the scientific literature to document this type of response in fathead minnow (20) and medaka (21). A decrease in secondary sex characteristics in males should be interpreted with caution because of low statistical power, and should be based on expert judgement and weight of evidence. There are limitations to the use of zebrafish in this assay, due to the absence of quantifiable secondary sex characteristics responsive to androgenic acting chemicals.
8. In the fathead minnow, the main indicator of exogenous androgenic exposure is the number of nuptial tubercles located on the snout of the female fish. In the medaka, the number of papillary processes constitutes the main marker of exogenous exposure to androgenic chemicals in female fish. Appendix 5A and Appendix 5B indicate the recommended procedures to follow for the evaluation of sex characteristics in fathead minnow and in medaka, respectively.
9. The 21-day fish assay includes the evaluation of quantitative egg production and preservation of gonads for optional histopathology examination. Some regulatory authorities may require this additional endpoint for a more complete evaluation of the reproductive fitness of the test animals, or in cases where vitellogenin and secondary sex characteristics did not respond to the chemical exposure. Although some endpoints may be highly diagnostic (e.g. VTG induction in males and tubercle formation in females), not all endpoints (e.g. fecundity and gonad histopathology) in the assay are intended to unequivocally identify specific cellular mechanisms of action. Rather, the suite of endpoints, collectively, allows inferences to be made with regard to possible endocrine disturbances and thus provide guidance for further testing. Although not endocrine specific, fecundity, due to its demonstrated sensitivity across known endocrine active chemicals (5), is an important endpoint to include because when it and other endpoints are

▼M7

unaffected one is more confident that a compound is not likely endocrine active. However, when fecundity is affected it will contribute heavily in weight of evidence inferences. Guidance on data interpretation and acceptance of test results is provided further in this test method.

10. Definitions used in this test method are given in Appendix 1.

PRINCIPLE OF THE TEST

11. In the assay, male and female fish in a reproductive status are exposed together in test vessels. Their adult and reproductive status enables a clear differentiation of each sex, and thus a sex-related analysis of each endpoint, and ensures their sensitivity towards exogenous chemicals. At test termination, sex is confirmed by macroscopic examination of the gonads following ventral opening of the abdomen with scissors. An overview of the relevant bioassay conditions are provided in Appendix 2. The assay is normally initiated with fish sampled from a population that is in spawning condition; senescent animals should not be used. Guidance on the age of fish and on the reproductive status is provided in the section on Selection of fish. The assay is conducted using three chemical exposure concentrations as well as a water control, and a solvent control if necessary. Two vessels or replicates per treatment are used for zebrafish (each vessel containing 5 males and 5 females). Four vessels or replicates per treatment are used for fathead minnow (each vessel containing 2 males and 4 females). This is to accommodate the territorial behaviour of male fathead minnow while maintaining sufficient power of the assay. Four vessels or replicates per treatment are used for medaka (each vessel containing 3 males and 3 females). The exposure is conducted for 21-days and sampling of fish is performed at day 21 of exposure. Quantitative fecundity is monitored daily.
12. On sampling at day 21, all animals are killed humanely. Secondary sex characteristics are measured in fathead minnow and medaka (see Appendix 5A and Appendix 5B); blood samples are collected for determination of VTG in zebrafish and fathead minnow, alternatively head/tail can be collected for the determination of VTG in zebrafish (Appendix 6); liver is collected for VTG analysis in medaka (Appendix 6); gonads are fixed either in whole or dissected for potential histopathological evaluation (22).

TEST ACCEPTANCE CRITERIA

13. For the test results to be acceptable the following conditions apply:
 - the mortality in the water (or solvent) controls should not exceed 10 per cent at the end of the exposure period;
 - the dissolved oxygen concentration should be at least 60 per cent of the air saturation value (ASV) throughout the exposure period;
 - the water temperature should not differ by more than $\pm 1,5$ °C between test vessels at any one time during the exposure period and be maintained within a range of 2 °C within the temperature ranges specified for the test species (Appendix 2);
 - evidence should be available to demonstrate that the concentrations of the test chemical in solution have been satisfactorily maintained within ± 20 % of the mean measured values;

▼ M7

- evidence that fish are actively spawning in all replicates prior to initiating chemical exposure and in control replicates during the test.

DESCRIPTION OF THE METHOD**Apparatus**

14. Normal laboratory equipment and especially the following:
 - (a) oxygen and pH meters;
 - (b) equipment for determination of water hardness and alkalinity;
 - (c) adequate apparatus for temperature control and preferably continuous monitoring;
 - (d) tanks made of chemically inert material and of a suitable capacity in relation to the recommended loading and stocking density (see Appendix 2);
 - (e) spawning substrate for fathead minnow and zebrafish, Appendix 4 gives the necessary details.
 - (f) suitably accurate balance (i.e. accurate to $\pm 0,5$ mg).

Water

15. Any water in which the test species shows suitable long-term survival and growth may be used as test water. It should be of constant quality during the period of the test. The pH of the water should be within the range 6,5 to 8,5, but during a given test it should be within a range of $\pm 0,5$ pH units. In order to ensure that the dilution water will not unduly influence the test result (for example by complexation of test chemical); samples should be taken at intervals for analysis. Measurements of heavy metals (e.g. Cu, Pb, Zn, Hg, Cd, and Ni), major anions and cations (e.g. Ca^{2+} , Mg^{2+} , Na^+ , K^+ , Cl^- , and SO_4^{2-}), pesticides (e.g. total organophosphorus and total organochlorine pesticides), total organic carbon and suspended solids should be made, for example, every three months where dilution water is known to be relatively constant in quality. If water quality has been demonstrated to be constant over at least one year, determinations can be less frequent and intervals extended (e.g. every six months). Some chemical characteristics of acceptable dilution water are listed in Appendix 3.

Test solutions

16. Test solutions of the chosen concentrations are prepared by dilution of a stock solution. The stock solution should preferably be prepared by simply mixing or agitating the test chemical in dilution water by using mechanical means (e.g. stirring or ultrasonication). Saturation columns (solubility columns) can be used for achieving a suitable concentrated stock solution. The use of a solvent carrier is not recommended. However, in case a solvent is necessary, a solvent control should be run in parallel, at the same solvent concentration as the chemical treatments. For difficult to test chemicals, a solvent may be technically the best solution; the OECD guidance document on aquatic toxicity testing of difficult substances and mixtures should be consulted (23). The choice of solvent will be determined by the chemical properties of the substance or mixture. The OECD guidance document recommends a maximum of 100 $\mu\text{l/l}$, which should be observed. However a recent review (24) highlighted additional concerns when using solvents for endocrine activity testing. Therefore it is recommended that the solvent concentration, if necessary, is minimised wherever technically feasible (dependent on the physical-chemical properties of the test chemical).

▼M7

17. A flow-through test system will be used. Such a system continually dispenses and dilutes a stock solution of the test chemical (e.g. metering pump, proportional diluter, saturator system) in order to deliver a series of concentrations to the test chambers. The flow rates of stock solutions and dilution water should be checked at intervals, preferably daily, during the test and should not vary by more than 10 % throughout the test. Care should be taken to avoid the use of low-grade plastic tubing or other materials that may contain biologically active chemicals. When selecting the material for the flow-through system, possible adsorption of the test chemical to this material should be considered.

Holding of fish

18. Test fish should be selected from a laboratory population, preferably from a single stock, which has been acclimated for at least two weeks prior to the test under conditions of water quality and illumination similar to those used in the test. It is important that the loading rate and stocking density (for definitions, see Appendix 1) be appropriate for the test species used (see Appendix 2).
19. Following a 48-hour settling-in period, mortalities are recorded and the following criteria applied:
 - mortalities of greater than 10 % of population in seven days: reject the entire batch;
 - mortalities of between 5 % and 10 % of population: acclimation for seven additional days; if more than 5 % mortality during second seven days, reject the entire batch;
 - mortalities of less than 5 % of population in seven days: accept the batch.
20. Fish should not receive treatment for disease during the acclimation period, in the pre-exposure period, or during the exposure period.

Pre-exposure and selection of fish

21. The one to two-week pre-exposure period is recommended with animals placed in vessels similar to the actual test. Fish should be fed *ad libitum* throughout the holding period and during the exposure phase. The exposure phase is started with sexually dimorphic adult fish from a laboratory supply of reproductively mature animals (e.g. with clear secondary sexual characteristics visible as far as fathead minnow and medaka are concerned), and actively spawning. For general guidance only (and not to be considered in isolation from observing the actual reproductive status of a given batch of fish), fathead minnows should be approximately 20 (\pm 2) weeks of age, assuming they have been cultured at 25 ± 2 °C throughout their lifespan. Japanese medaka should be approximately 16 (\pm 2) weeks of age, assuming they have been cultured at 25 ± 2 °C throughout their lifespan. Zebrafish should be approximately 16 (\pm 2) weeks of age, assuming they have been cultured at 26 ± 2 °C throughout their lifespan. Egg production should be assessed daily during the pre-exposure phase. It is recommended that spawning be observed in all replicate tanks prior to inclusion in the exposure phase of the assay. Quantitative guidance on desirable daily egg production cannot be provided at this stage, but it is relatively common to observe average spawns of > 10 eggs/female/day for each species. A randomised block design according to egg production output should be used to allocate replicates to the various experimental levels to ensure balanced distribution of replicates.

▼M7**TEST DESIGN**

22. Three concentrations of the test chemical, one control (water) and, if needed, one solvent control are used. The data may be analysed in order to determine statistically significant differences between treatment and control responses. These analyses will inform whether further longer term testing for adverse effects (namely, survival, development, growth and reproduction) is required for the chemical, rather than for use in risk assessment (25).

23. For zebrafish, on day 21 of the experiment, males and females from each treatment level (5 males and 5 females in each of the two replicates) and from the control(s) are sampled for the measurement of vitellogenin. For medaka, on day 21 of the experiment, males and females from each treatment level (3 males and 3 females in each of the four replicates) and from the control(s) are sampled for the measurement of vitellogenin and secondary sex characteristics. For fathead minnow, on day 21 of exposure, males and females (2 males and 4 females in each of the four replicates) and from the control(s) are sampled for the measurement of vitellogenin and secondary sex characteristics. Quantitative assessment of fecundity is required, and gonadal tissues should be fixed in whole or dissected for potential histopathological evaluation, if required.

Selection of test concentrations

24. For the purposes of this test, the highest test concentration should be set by the maximum tolerated concentration (MTC) determined from a range finder or from other toxicity data, or 10 mg/l, or the maximum solubility in water, whichever is lowest. The MTC is defined as the highest test concentration of the chemical which results in less than 10 % mortality. Using this approach assumes that there are existing empirical acute toxicity data or other toxicity data from which the MTC can be estimated. Estimating the MTC can be inexact and typically requires some professional judgment.

25. Three test concentrations, spaced by a constant factor not exceeding 10, and a dilution-water control (and solvent control if necessary) are required. A range of spacing factors between 3,2 and 10 is recommended.

PROCEDURE**Selection and weighing of test fish**

26. It is important to minimise variation in weight of the fish at the beginning of the assay. Suitable size ranges for the different species recommended for use in this test are given in Appendix 2. For the whole batch of fish used in the test, the range in individual weights for male and female fish at the start of the test should be kept, if possible, within $\pm 20\%$ of the arithmetic mean weight of the same sex. It is recommended to weigh a subsample of the fish stock before the test in order to estimate the mean weight.

Conditions of exposure*Duration*

27. The test duration is 21 days, following a pre-exposure period. The recommended pre-exposure period is one to two weeks.

Feeding

28. Fish should be fed *ad libitum* with an appropriate food (Appendix 2) at a sufficient rate to maintain body condition. Care should be taken to avoid microbial growth and water turbidity. As a general guidance, the daily ration may be divided into two or three equal portions for multiple feeds per day, separated by at least three hours between each feed. A single larger ration is

▼ M7

acceptable particularly for weekends. Food should be withheld from the fish for 12 hours prior to sampling/necropsy.

29. Fish food should be evaluated for the presence of contaminants such as organochlorine pesticides, polycyclic aromatic hydrocarbons (PAHs), polychlorinated biphenyls (PCBs). Food with an elevated level of phytoestrogens that would compromise the response of the assay to known oestrogen agonist (e.g. 17 β - estradiol) should be avoided.
30. Uneaten food and faecal material should be removed from the test vessels at least twice weekly, e.g. by carefully cleaning the bottom of each tank using a siphon.

Light and temperature

31. The photoperiod and water temperature should be appropriate for the test species (see Appendix 2).

Frequency of analytical determinations and measurements

32. Prior to initiation of the exposure period, proper function of the chemical delivery system should be ensured. All analytical methods needed should be established, including sufficient knowledge on the chemical stability in the test system. During the test, the concentrations of the test chemical are determined at regular intervals, as follows: the flow rates of diluent and toxicant stock solution should be checked preferably daily but as a minimum twice per week, and should not vary by more than 10 % throughout the test. It is recommended that the actual test chemical concentrations be measured in all vessels at the start of the test and at weekly intervals thereafter.
33. It is recommended that results be based on measured concentrations. However, if concentration of the test chemical in solution has been satisfactorily maintained within ± 20 % of the nominal concentration throughout the test, then the results can either be based on nominal or measured values.
34. Samples may need to be filtered (e.g. using a 0,45 μm pore size) or centrifuged. If needed, then centrifugation is the recommended procedure. However, if the test material does not adsorb to filters, filtration may also be acceptable.
35. During the test, dissolved oxygen, temperature, and pH should be measured in all test vessels at least once per week. Total hardness and alkalinity should be measured in the controls and one vessel at the highest concentration at least once per week. Temperature should preferably be monitored continuously in at least one test vessel.

Observations

36. A number of general (e.g. survival) and biological responses (e.g. VTG levels) are assessed over the course of the assay or at termination of the assay. The daily quantitative monitoring of fecundity is required. Measurement and evaluation of these endpoints and their utility are described below.

Survival

37. Fish should be examined daily during the test period and any mortality should be recorded and the dead fish removed as soon as possible. Dead fish should not be replaced in either the control or treatment vessels. Sex of fish that die during the test should be determined by macroscopic evaluation of the gonads.

▼ M7*Behaviour and appearance*

38. Any abnormal behaviour (relative to controls) should be noted; this might include signs of general toxicity including hyperventilation, uncoordinated swimming, loss of equilibrium, and atypical quiescence or feeding. Additionally external abnormalities (such as haemorrhage, discoloration) should be noted. Such signs of toxicity should be considered carefully during data interpretation since they may indicate concentrations at which biomarkers of endocrine activity are not reliable. Such behavioural observations may also provide useful qualitative information to inform potential future fish testing requirements. For example, territorial aggressiveness in normal males or masculinised females has been observed in fathead minnows under androgenic exposure; in zebrafish, the characteristic mating and spawning behaviour after the dawn onset of light is reduced or hindered by oestrogenic or anti-androgenic exposure.
39. Because some aspects of appearance (primarily colour) can change quickly with handling, it is important that qualitative observations be made prior to removal of animals from the test system. Experience to date with fathead minnows suggests that some endocrine active chemicals may initially induce changes in the following external characteristics: body colour (light or dark), coloration patterns (presence of vertical bands), and body shape (head and pectoral region). Therefore observations of physical appearance of the fish should be made over the course of the test, and at conclusion of the study

Fecundity

40. Daily quantitative observations of spawning should be recorded on a replicate basis. Egg production should be recorded as the number of eggs/surviving female/day on a replicate basis. Eggs will be removed daily from the test chambers. Spawning substrates should be placed in the test chamber for the fathead minnow and zebrafish to enable fish to spawn in normal conditions. Appendix 4 gives further details of recommended spawning substrates for zebrafish (Appendix 4A) and fathead minnow (Appendix 4B). It is not considered necessary to provide spawning substrate for medaka.

Humane killing of fish

41. At day 21, i.e. at termination of the exposure, the fish should be euthanised with appropriate amounts of Tricaine (Tricaine methane sulfonate, Metacain, MS-222 (CAS.886-86-2), 100-500 mg/l buffered with 300 mg/l NaHCO₃ (sodium bicarbonate, CAS.144-55-8) to reduce mucous membrane irritation; blood or tissue is then sampled for VTG determination, as explained in the vitellogenin section.

Observation of secondary sex characteristics

42. Some endocrine active chemicals may induce changes in specialised secondary sex characteristics (number of nuptial tubercles in male fathead minnow, papillary processes in male medaka). Notably, chemicals with certain modes of action may cause abnormal occurrence of secondary sex characteristic in animals of the opposite sex; for example, androgen receptor agonists, such as trenbolone, methyltestosterone and dihydrotestosterone, can cause female fathead minnows to develop pronounced nuptial tubercles or female medaka to develop papillary processes (11, 20, 21). It also has been reported that oestrogen receptor agonists can decrease nuptial tubercle numbers and size of the dorsal nape pad in adult males of fathead minnow (26, 27). Such gross morphological observations may provide useful qualitative and quantitative information to inform potential future fish testing requirements. The number and size of nuptial tubercles in fathead minnow and papillary processes in medaka can be quantified directly or more practically in preserved specimens. Recommended procedures for the evaluation of secondary sex characteristics in fathead

▼ M7

minnow and medaka are available from Appendix 5A and Appendix 5B, respectively.

Vitellogenin (VTG)

43. Blood is collected from the caudal artery/vein with a heparinised microhematocrit capillary tubule, or alternatively by cardiac puncture with a syringe. Depending upon the size of the fish, collectable blood volumes generally range from 5 to 60 µl per individual for fathead minnows and 5-15 µl per individual for zebrafish. Plasma is separated from the blood via centrifugation, and stored with protease inhibitors at – 80 °C, until analysed for VTG. Alternatively, in medaka the liver will be used, and in zebrafish the head/tail homogenate can be used as tissue-source for VTG determination (Appendix 6). The measurement of VTG should be based upon a validated homologous ELISA method, using homologous VTG standard and homologous antibodies. It is recommended to use a method capable to detect VTG levels as low as few ng/ml plasma (or ng/mg tissue), which is the background level in unexposed male fish.

44. Quality control of VTG analysis will be accomplished through the use of standards, blanks and at least duplicate analyses. For each ELISA method, a test for matrix effect (effect of sample dilution) should be run to determine the minimum sample dilution factor. Each ELISA plate used for VTG assays should include the following quality control samples: at least 6 calibration standards covering the range of expected VTG concentrations, and at least one non-specific binding assay blank (analysed in duplicate). Absorbance of these blanks should be less than 5 % of the maximum calibration standard absorbance. At least two aliquots (well-duplicates) of each sample dilution will be analysed. Well-duplicates that differ by more than 20 % should be re-analysed.

45. The correlation coefficient (R^2) for calibration curves should be greater than 0,99. However, a high correlation is not sufficient to guarantee adequate prediction of concentration in all ranges. In addition to having a sufficiently high correlation for the calibration curve, the concentration of each standard, as calculated from the calibration curve, should all fall between 70 and 120 % of its nominal concentration. If the nominal concentrations trend away from the calibration regression line (e.g. at lower concentrations), it may be necessary to split the calibration curve into low and high ranges or to use a nonlinear model to adequately fit the absorbance data. If the curve is split, both line segments should have $R^2 > 0,99$.

46. The limit of detection (LOD) is defined as the concentration of the lowest analytical standard, and limit of quantitation (LOQ) is defined as the concentration of the lowest analytical standard multiplied by the lowest dilution factor.

47. On each day that VTG assays are performed, a fortification sample made using an inter-assay reference standard will be analysed (Appendix 7). The ratio of the expected concentration to the measured concentration will be reported along with the results from each set of assays performed on that day.

Evaluation of gonadal histopathology

48. Performance of gonadal histopathology may be required by regulatory authorities to study the target organ on the HPG axis following chemical exposure. In this respect, gonads are fixed either whole body or dissected. When histopathology is required, specific endocrine-related responses on the gonads will be looked for in the assessment of the endocrine activity of the test chemical. These diagnostic responses essentially include the presence of

▼ M7

testicular oocytes, Leydig cell hyperplasia, decreased yolk formation, increased spermatogonia and perfollicular hyperplasia. Other gonadal lesions like oocyte atresia, testicular degeneration, and stage changes, may have various causes. The Guidance document on fish gonadal histopathology specifies procedures that will be used in the dissection, fixation, sectioning and histopathological evaluation of the gonads (22).

DATA AND REPORTING**Evaluation of Biomarker Responses by Analysis of Variance (ANOVA)**

49. To identify potential activity of a chemical, responses are compared between treatments and control groups using analysis of variance (ANOVA). Where a solvent control is used, an appropriate statistical test should be performed between the dilution water and solvent controls for each endpoint. Guidance on how to handle dilution water and solvent control data in the subsequent statistical analysis can be found in OECD, 2006c (28). All biological response data should be analysed and reported separately by sex. If the required assumptions for parametric methods are not met — non-normal distribution (e.g. Shapiro-Wilk's test) or heterogeneous variance (Bartlett's test or Levene's test), consideration should be given to transforming the data to homogenise variances prior to performing the ANOVA, or to carrying out a weighted ANOVA. Dunnett's test (parametric) on multiple pair-wise comparisons or a Mann-Whitney with Bonferroni adjustment (non-parametric) may be used for non-monotonous dose-response. Other statistical tests may be used (e.g. Jonckheere-Terpstra test or Williams test) if the dose-response is approximately monotone. A statistical flowchart is provided in Appendix 8 to help in the decision on the most appropriate statistical test to be used. Additional information can also be obtained from the OECD Document on Current Approaches to Statistical Analysis of Ecotoxicity Data (28).

Reporting of test results

50. Study data should include:

Testing facility:

- Responsible personnel and their study responsibilities
- Each laboratory should have demonstrated proficiency using a range of representative chemicals

Test Chemical:

- Characterisation of test chemical
- Physical nature and relevant physicochemical properties
- Method and frequency of preparation of test concentrations
- Information on stability and biodegradability

Solvent:

- Characterisation of solvent (nature, concentration used)
- Justification of choice of solvent (if other than water)

▼ M7*Test animals:*

- Species and strain
- Supplier and specific supplier facility
- Age of the fish at the start of the test and reproductive/spawning status
- Details of animal acclimation procedure
- Body weight of the fish at the start of the exposure (from a sub-sample of the fish stock)

Test Conditions:

- Test procedure used (test-type, loading rate, stocking density, etc.);
- Method of preparation of stock solutions and flow-rate;
- The nominal test concentrations, weekly measured concentrations of the test solutions and analytical method used, means of the measured values and standard deviations in the test vessels and evidence that the measurements refer to the concentrations of the test chemical in true solution;
- Dilution water characteristics (including pH, hardness, alkalinity, temperature, dissolved oxygen concentration, residual chlorine levels, total organic carbon, suspended solids and any other measurements made)
- Water quality within test vessels: pH, hardness, temperature and dissolved oxygen concentration;
- Detailed information on feeding (e.g. type of food(s), source, amount given and frequency and analyses for relevant contaminants if available (e.g. PCBs, PAHs and organochlorine pesticides).

Results

- Evidence that the controls met the acceptance criteria of the test;
- Data on mortalities occurring in any of the test concentrations and control;
- Statistical analytical techniques used, treatment of data and justification of techniques used;
- Data on biological observations of gross morphology, including secondary sex characteristics, egg production and VTG;
- Results of the data analyses preferably in tabular and graphical form;
- Incidence of any unusual reactions by the fish and any visible effects produced by the test chemical

▼M7

GUIDANCE FOR THE INTERPRETATION AND ACCEPTANCE OF THE TEST RESULTS

51. This section contains a few considerations to be taken into account in the interpretation of test results for the various endpoints measured. The results should be interpreted with caution where the test chemical appears to cause overt toxicity or to impact on the general condition of the test animal.
52. In setting the range of test concentrations, care should be taken not to exceed the maximum tolerated concentration to allow a meaningful interpretation of the data. It is important to have at least one treatment where there are no signs of toxic effects. Signs of disease and signs of toxic effects should be thoroughly assessed and reported. For example, it is possible that production of VTG in females can also be affected by general toxicity and non-endocrine toxic modes of action, e.g. hepatotoxicity. However, interpretation of effects may be strengthened by other treatment levels that are not confounded by systemic toxicity.
53. There are a few aspects to consider for the acceptance of test results. As a guide, the VTG levels in control groups of males and females should be distinct and separated by about three orders of magnitude in fathead minnow and zebrafish, and about one order of magnitude for medaka. Examples of the range of values encountered in control and treatment groups are available in the validation reports (1, 2, 3, 4). High VTG values in control males could compromise the responsiveness of the assay and its ability to detect weak oestrogen agonists. Low VTG values in control females could compromise the responsiveness of the assay and its ability to detect aromatase inhibitors and oestrogen antagonists. The validation studies were used to build that guidance.
54. Concerning the quantification of egg production, this is subject to important variations [the coefficient of variation (CV) may range from 20 to 60 %] that impinge the ability of the assay to detect a significant decrease in egg production smaller than 70 % as the CV approaches 50 % or more. When the CV is confined to lower values (around 20-30 %), then the assay will have acceptable power (80 %) to detect 40-50 % decrease in egg production. The test design used for the fathead minnow, including four replicates per treatment level, should allow more power to the fecundity endpoint, compared to a test design with 2 replicates only.
55. If a laboratory has not performed the assay before or substantial changes (e.g. change of fish strain or supplier) have been made it is advisable that a technical proficiency study is conducted. It is recommended that chemicals covering a range of modes of action or impacts on a number of the test endpoints are used. In practice, each laboratory is encouraged to build its own historical control data for males and females and to perform a positive control chemical for estrogenic activity (e.g. 17 β -estradiol at 100 ng/l, or a known weak agonist) resulting in increased VTG in male fish, a positive control chemical for aromatase inhibition (e.g. fadrozole or prochloraz at 300 μ g/l) resulting in decreased VTG in female fish, and a positive control chemical for androgenic activity (e.g. 17 β -trenbolone at 5 μ g/l) resulting in induction of secondary sex characteristics in female fathead minnow and medaka. All these data can be compared to available data from the validation studies (1, 2, 3) to ensure laboratory proficiency.
56. In general, VTG measurements should be considered positive if there is a statistically significant increase in VTG in males ($p < 0,05$), or a statistically significant decrease in females ($p < 0,05$) at least at the highest dose tested compared to the control group, and in the absence of signs of general toxicity. A positive result is further supported by the demonstration of a biologically plausible relationship between the dose and the response curve. As mentioned earlier, the VTG decrease may not entirely be of

▼ M7

endocrine origin; however a positive result should generally be interpreted as evidence of endocrine activity *in vivo*, and should normally initiate actions for further clarification.

57. Gonadal histopathology evaluation may be required by regulatory authorities to determine the reproductive fitness of the test animals and to allow a weight of evidence assessment of the test results. Performance of gonadal histopathology may not be necessary in cases where either, VTG or secondary sex characteristics is positive (i.e. VTG increase or decrease, or induction of secondary sex characteristics).

LITERATURE:

- (1) OECD (2006a). Report of the Initial Work Towards the Validation of the 21-Day Fish Screening Assay for the Detection of Endocrine active Substances (Phase 1A). OECD Environmental Health and Safety Publications Series on Testing and Assessment No.60, Paris.
- (2) OECD (2006b). Report of the Initial Work Towards the Validation of the 21-Day Fish Screening Assay for the Detection of Endocrine active Substances (Phase 1B). OECD Environmental Health and Safety Publications Series on Testing and Assessment No.61, Paris.
- (3) OECD (2007). Final report of the Validation of the 21-day Fish Screening Assay for the Detection of Endocrine Active Substances. Phase 2: Testing Negative Substances. OECD Environmental Health and Safety Publications Series on Testing and Assessment No.78, Paris.
- (4) Owens JW (2007). Phase 3 report of the validation of the OECD Fish Screening Assay. CEFIC LRI Project, Endocrine. <http://www.cefic-lri.org/index.php?page=projects> (accessed 18/09/08).
- (5) US EPA (2007). Validation of the Fish Short-Term Reproduction Assay: Integrated Summary Report. 15 December 2007. US Environmental Protection Agency, Washington, DC. 104 pp.
- (6) OECD (2008). Report of the Validation Peer Review for the 21-Day Fish Endocrine Screening Assay and Agreement of the Working Group of the National Coordinators of the Test Guidelines Programme on the Follow-up of this Report. OECD Environmental Health and Safety Publications Series on Testing and Assessment No.94, Paris.
- (7) Sumpter J.P. and S. Jobling (1995). Vitellogenesis as a biomarker for estrogenic contamination of the aquatic environment. *Environmental Health Perspectives*; 103 Suppl 7:173-8 Review.
- (8) Pawlowski S., *et al.* (2004). Androgenic and estrogenic effects of the synthetic androgen 17alpha-methyltestosterone on sexual development and reproductive performance in the fathead minnow (*Pimephales promelas*) determined using the gonadal recrudescence assay. *Aquatic Toxicology*; 68(3):277-91.
- (9) Andersen L., *et al.* (2006). Short-term exposure to low concentrations of the synthetic androgen methyltestosterone affects vitellogenin and steroid levels in adult male zebrafish (*Danio rerio*). *Aquatic Toxicology*; 76(3-4):343-52.
- (10) Ankley G.T., *et al.* (2002). Evaluation of the aromatase inhibitor fadrozole in a short-term reproduction assay with the fathead minnow (*Pimephales promelas*). *Toxicological Sciences*; 67(1):121-30.

▼ M7

- (11) Panter G.H., *et al.* (2004). Successful detection of (anti-)androgenic and aromatase inhibitors in pre-spawning adult fathead minnows (*Pimephales promelas*) using easily measured endpoints of sexual development. *Aquatic Toxicology*; 70(1):11-21.
- (12) Parks L.G., *et al.* (1999). Fathead minnow (*Pimephales promelas*) vitellogenin: purification, characterization and quantitative immunoassay for the detection of estrogenic compounds. *Comparative Biochemistry and Physiology. Part C Pharmacology, toxicology and endocrinology*; 123(2):113-25.
- (13) Panter G.H., *et al.* (1999). Application of an ELISA to quantify vitellogenin concentrations in fathead minnows (*Pimephales promelas*) exposed to endocrine disrupting chemicals. CEFIC-EMSG research report reference AQ001. CEFIC, Brussels, Belgium.
- (14) Fenske M., *et al.* (2001). Development and validation of a homologous zebrafish (*Danio rerio* Hamilton- Buchanan) vitellogenin enzyme-linked immunosorbent assay (ELISA) and its application for studies on estrogenic chemicals. *Comp. Biochem. Phys. C* 129 (3): 217-232.
- (15) Holbech H., *et al.* (2001). Development of an ELISA for vitellogenin in whole body homogenate of zebrafish (*Danio rerio*). *Comparative Biochemistry and Physiology. Part C Pharmacology, toxicology and endocrinology*; 130: 119-131
- (16) Rose J., *et al.* (2002). Vitellogenin induction by 17 β -estradiol and 17 α -ethinylestradiol in male zebrafish (*Danio rerio*). *Comp. Biochem. Physiol. C* 131: 531-539.
- (17) Brion F., *et al.* (2002). Development and validation of an enzyme-linked immunosorbent assay to measure vitellogenin in the zebrafish (*Danio rerio*). *Environmental Toxicology and Chemistry*; vol 21: 1699-1708.
- (18) Yokota H., *et al.* (2001). Development of an ELISA for determination of the hepatic vitellogenin in Medaka (*Oryzias latipes*). *Jpn J Environ Toxicol* 4:87-98.
- (19) Tatarazako N., *et al.* (2004). Validation of an enzyme-linked immunosorbent assay method for vitellogenin in the Medaka. *Journal of Health Science* 50:301-308.
- (20) Ankley G.T., *et al.* (2003). Effects of the androgenic growth promoter 17-beta-trenbolone on fecundity and reproductive endocrinology of the fathead minnow. *Environmental Toxicology and Chemistry*; 22(6): 1350-60.
- (21) Seki M, *et al.* (2004). Fish full life-cycle testing for androgen methyltestosterone on medaka (*Oryzias latipes*). *Environmental Toxicology and Chemistry*; 23(3):774-81.
- (22) OECD (2010). Guidance Document on Fish Gonadal Histopathology. OECD Environmental Health and Safety Publications Series on Testing and Assessment No. 123, Paris.
- (23) OECD (2000) Guidance Document on Aquatic Toxicity Testing of Difficult Substances and Mixtures. Environmental Health and Safety Publications. Series on Testing and Assessment. No. 23. Paris
- (24) Hutchinson T.H., *et al.* (2006a). Acute and chronic effects of carrier solvents in aquatic organisms: A critical review. Review. *Aquatic Toxicology*, 76; pp.69-92.
- (25) Hutchinson T.H., *et al.* (2006b). Screening and testing for endocrine disruption in fish-biomarkers as 'signposts', not 'traffic lights,' in risk assessment. *Environmental Health Perspectives*; 114 Suppl 1:106-14.

▼ M7

- (26) Miles-Richardson S.R., *et al.* (1999). Effects of waterborne exposure to 17 β -estradiol on secondary sex characteristics and gonads of the fathead minnow (*Pimephales promelas*). *Aquat. Toxicol.* 47, 129-145.
- (27) Martinovic D., *et al.* (2008). Characterization of reproductive toxicity of vinclozolin in the fathead minnow and co-treatment with an androgen to confirm an anti-androgenic mode of action. *Environ. Toxicol. Chem.* 27, 478-488.
- (28) OECD (2006c), *Current Approaches in the Statistical Analysis of Ecotoxicity Data: A Guidance to Application*, OECD Environmental Health and Safety Publications, Series on Testing and Assessment No.54, OECD, Paris.
- (29) US EPA (2008), *Peer-Review Results for the Fish Short-Term Reproduction Assay*, dated 30 January 2008, US Environmental Protection Agency, Washington DC. 110 pp.
- (30) OECD (2012), *OECD Conceptual Framework for Testing and Assessment of Endocrine Disruptors*, OECD Environmental Health and Safety Publications, Series on Testing and Assessment No. 150, OECD, Paris.

▼ M7*Appendix 1*

ABBREVIATIONS & DEFINITIONS:

Chemical: a substance or a mixture

CV: coefficient of variation

ELISA: Enzyme-Linked Immunosorbent Assay

HPG axis: hypothalamic-pituitary-gonadal axis

Loading rate: the wet weight of fish per volume of water.

MTC: Maximum Tolerated Concentration, representing about 10 % of the LC₅₀

Stocking density: is the number of fish per volume of water.

Test chemical: Any substance or mixture tested using this test method.

VTG: vitellogenin is a phospholipoglycoprotein precursor to egg yolk protein that normally occurs in sexually active females of all oviparous species.

▼M7

Appendix 2

EXPERIMENTAL CONDITIONS FOR THE FISH ENDOCRINE SCREENING ASSAY

1. Recommended species	Fathead minnow (<i>Pimephales promelas</i>)	Medaka (<i>Oryzias latipes</i>)	Zebrafish (<i>Danio rerio</i>)
2. Test type	Flow-through	Flow-through	Flow-through
3. Water temperature	25 ± 2 °C	25 ± 2 °C	26 ± 2 °C
4. Illumination quality	Fluorescent bulbs (wide spectrum)	Fluorescent bulbs (wide spectrum)	Fluorescent bulbs (wide spectrum)
5. Light intensity	10-20 µE/m ² /s, 540-1 000 lux, or 50-100 ft-c (ambient laboratory levels)	10-20 µE/m ² /s, 540-1 000 lux, or 50-100 ft-c (ambient laboratory levels)	10-20 µE/m ² /s, 540-1 000 lux, or 50-100 ft-c (ambient laboratory levels)
6. Photoperiod (dawn / dusk transitions are optional, however not considered necessary)	16 h light, 8 h dark	12-16 h light, 12-8 h dark	12-16 h light, 12-8 h dark
7. Loading rate	< 5 g per l	< 5 g per l	< 5 g per l
8. Test chamber size	10 l (minimum)	2 l (minimum)	5 l (minimum)
9. Test solution volume	8 l (minimum)	1,5 l (minimum)	4 l (minimum)
10. Volume exchanges of test solutions	Minimum of 6 daily	Minimum of 5 daily	Minimum of 5 daily
11. Age of test organisms	See paragraph 21	See paragraph 21	See paragraph 21
12. Approximate wet weight of adult fish (g)	Females: 1,5 ± 20 % Males: 2,5 ± 20 %	Females: 0,35 ± 20 % Males: 0,35 ± 20 %	Females: 0,65 ± 20 % Males: 0,4 ± 20 %
13. No. of fish per test vessel	6 (2 males and 4 females)	6 (3 males and 3 females)	10 (5 males and 5 females)
14. No. of treatments	= 3 (plus appropriate controls)	= 3 (plus appropriate controls)	= 3 (plus appropriate controls)
15. No. vessels per treatment	4 minimum	4 minimum	2 minimum
16. No. of fish per test concentration	16 adult females and 8 males (4 females and 2 males in each replicate vessel)	12 adult females and 12 males (3 females and 3 males in each replicate vessel)	10 adult females and 10 males (5 females and 5 males in each replicate vessel)
17. Feeding regime	Live or frozen adult or nauplii brine shrimp two or three times daily (<i>ad libitum</i>), commercially available food or a combination of the above	Brine shrimp nauplii two or three times daily (<i>ad libitum</i>), commercially available food or a combination of the above	Brine shrimp nauplii two or three times daily (<i>ad libitum</i>), commercially available food or a combination of the above

▼M7

18. Aeration	None unless DO concentration falls below 60 % air saturation	None unless DO concentration falls below 60 % air saturation	None unless DO concentration falls below 60 % air saturation
19. Dilution water	Clean surface, well or reconstituted water or dechlorinated tap water	Clean surface, well or reconstituted water or dechlorinated tap water	Clean surface, well or reconstituted water or dechlorinated tap water
20. Pre-exposure period	7-14 days recommended	7-14 days recommended	7-14 days recommended
21. Chemical exposure duration	21-d	21-d	21-d
22. Biological endpoints	<ul style="list-style-type: none"> — survival — behaviour — fecundity — 2y sex characteristics — VTG — optionally gonadal histopathology 	<ul style="list-style-type: none"> — survival — behaviour — fecundity — 2y sex characteristics — VTG — optionally gonadal histopathology 	<ul style="list-style-type: none"> — survival — behaviour — fecundity — VTG — optionally gonadal histopathology
23. Test acceptability	Dissolved oxygen \geq 60 % of saturation; mean temperature of 25 ± 2 °C; 90 % survival of fish in the controls; measured test concentrations within 20 % of mean measured values per treatment level.	Dissolved oxygen \geq 60 % of saturation; mean temperature of 25 ± 2 °C; 90 % survival of fish in the controls; measured test concentrations within 20 % of mean measured values per treatment level.	Dissolved oxygen \geq 60 % of saturation; mean temperature of 26 ± 2 °C; 90 % survival of fish in the controls; measured test concentrations within 20 % of mean measured values per treatment level.

▼ M7*Appendix 3***SOME CHEMICAL CHARACTERISTICS OF ACCEPTABLE DILUTION WATER**

COMPONENT	CONCENTRATIONS
Particulate matter	< 20 mg/l
Total organic carbon	< 2 mg/l
Unionised ammonia	< 1 µg/l
Residual chlorine	< 10 µg/l
Total organophosphorus pesticides	< 50 ng/l
Total organochlorine pesticides plus polychlorinated biphenyls	< 50 ng/l
Total organic chlorine	< 25 ng/l

▼ M7*Appendix 4A***SPAWNING SUBSTRATE FOR ZEBRAFISH**

Spawning tray: all glass instrument dish, for example $22 \times 15 \times 5,5$ cm ($l \times w \times d$), covered with a removable stainless steel wire lattice (mesh width 2mm). The lattice should cover the opening of the instrument dish at a level below the brim.

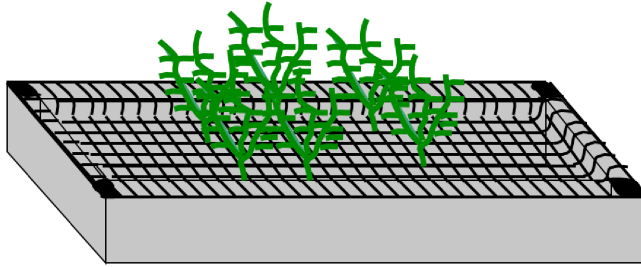

On the lattice, spawning substrate should be fixed. It should provide structure for the fish to move into. For example, artificial aquaria plants made of green plastic material are suitable (NB: possible adsorption of the test chemical to the plastic material should be considered). The plastic material should be leached out in sufficient volume of warm water for sufficient time to ensure that no chemicals may be disposed to the test water. When using glass materials it should be ensured that the fish are neither injured nor cramped during their vigorous actions.

The distance between the tray and the glass panes should be at least 3 cm to ensure that the spawning is not performed outside the tray. The eggs spawned onto the tray fall through the lattice and can be sampled 45-60 min after the start of illumination. The transparent eggs are non-adhesive and can easily be counted by using transversal light. When using five females per vessel, egg numbers up to 20 at a day can be regarded as low, up to 100 as medium and more than 100 as high numbers. The spawning tray should be removed, the eggs collected and the spawning tray re-introduced in the test vessel, either as late as possible in the evening or very early in the morning. The time until re-introduction should not exceed one hour since otherwise the cue of the spawning substrate may induce individual mating and spawning at an unusual time. If a situation needs a later introduction of the spawning tray, this should be done at least 9 hours after start of the illumination. At this late time of the day, spawning is not induced any longer.

▼M7*Appendix 4B***SPAWNING SUBSTRATE FOR FATHEAD MINNOW**

Two or three combined plastic/ceramic/glass or stainless steel spawning tiles and trays are placed in each of the test chamber (e.g. 80 mm length of grey semi-circular guttering sitting on a lipped tray of 130mm length) (see picture). Properly seasoned PVC or ceramic tiles have demonstrated to be appropriate for a spawning substrate (Thorpe *et al*, 2007).

It is recommended that the tiles are abraded to improve adhesion. The tray should also be screened to prevent fish from access to the fallen eggs unless the egg adhesion efficiency has been demonstrated for the spawning substrate used.

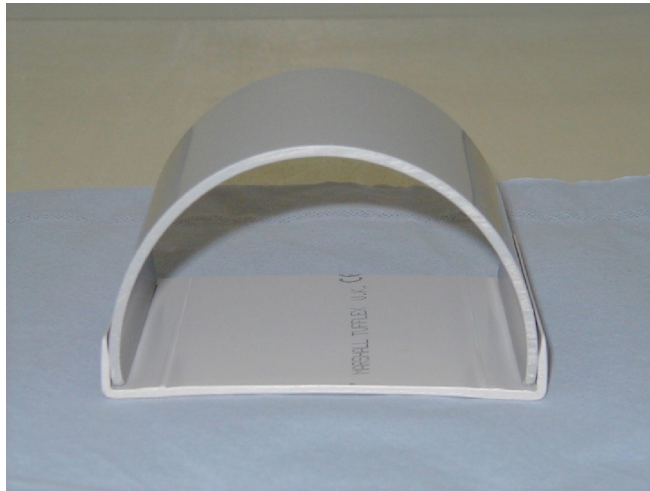

The base is designed to contain any eggs that do not adhere to the tile surface and would therefore fall to the bottom of the tank (or those eggs laid directly onto the flat plastic base). All spawning substrates should be leached for a minimum of 12 hours, in dilution water, before use.

Thorpe KL, Benstead R, Hutchinson TH, Tyler CR, 2007. An optimised experimental test procedure for measuring chemical effects on reproduction in the fathead minnow, *Pimephales promelas*. *Aquatic Toxicology*, 81, 90–98.

▼ **M7***Appendix 5A***ASSESSMENT OF SECONDARY SEX CHARACTERISTICS IN FATHEAD MINNOW FOR THE DETECTION OF CERTAIN ENDOCRINE ACTIVE CHEMICALS****Overview**

Potentially important characteristics of physical appearance in adult fathead minnows in endocrine disrupter testing include body colour (i.e., light/dark), coloration patterns (i.e., presence or absence of vertical bands), body shape (i.e., shape of head and pectoral region, distension of abdomen), and specialised secondary sex characteristics (i.e., number and size of nuptial tubercles, size of dorsal pad and ovipositor).

Nuptial tubercles are located on the head (dorsal pad) of reproductively-active male fathead minnows, and are usually arranged in a bilaterally-symmetric pattern (Jensen *et al.* 2001). Control females and juvenile males and females exhibit no tubercle development (Jensen *et al.* 2001). There can be up to eight individual tubercles around the eyes and between the nares of the males. The greatest numbers and largest tubercles are located in two parallel lines immediately below the nares and above the mouth. In many fish there are groups of tubercles below the lower jaw; those closest to the mouth generally occur as a single pair, while the more ventral set can be comprised of up to four tubercles. The actual numbers of tubercles is seldom more than 30 (range, 18-28; Jensen *et al.* 2001). The predominant tubercles (in terms of numbers) are present as a single, relatively round structure, with the height approximately equivalent to the radius. Most reproductively-active males also have, at least some, tubercles which are enlarged and pronounced such that they are indistinguishable as individual structures.

Some types of endocrine-disrupting chemicals can cause the abnormal occurrence of certain secondary sex characteristics in the opposite sex; for example, androgen receptor agonists, such as 17 α -methyltestosterone or 17 β -trenbolone, can cause female fathead minnows to develop nuptial tubercles (Smith 1974; Ankley *et al.* 2001; 2003), while oestrogen receptor agonists may decrease number or size of nuptial tubercles in males (Miles-Richardson *et al.* 1999; Harries *et al.* 2000).

Below is a description of the characterisation of nuptial tubercles in fathead minnows based on procedures used at the U.S. Environmental Protection Agency lab in Duluth, MN. Specific products and/or equipment can be substituted with comparable materials available.

Viewing is best accomplished using an illuminated magnifying glass or 3X illuminated dissection scope. View fish dorsally and anterior forward (head toward viewer).

— Place fish in small Petri dish (e.g. 100 mm in diameter), anterior forward, and ventral down. Focus viewfinder to allow identification of tubercles. Gently and slowly roll fish from side to side to identify tubercle areas. Count and score tubercles.

— Repeat the observation on the ventral head surface by placing the fish dorsal anterior forward in the Petri dish.

— Observations should be completed within 2 min for each fish.

▼ **M7****Tubercle Counting and Rating**

Six specific areas have been identified for assessment of tubercle presence and development in adult fathead minnows. A template was developed to map the location and quantity of tubercles present (see end of this appendix). The number of tubercles is recorded and their size can be quantitatively ranked as: 0- absence, 1-present, 2-enlarged and 3-pronounced for each organism (Fig. 1).

Rate 0 — absence of any tubercle. Rating 1 — present, is identified as any tubercle having a single point whose height is nearly equivalent to its radius. Rating 2 — enlarged, is identified by tissue resembling an asterisk in appearance, usually having a large radial base with grooves or furrows emerging from the centre. Tubercle height is often more jagged but can be somewhat rounded at times. Rating 3 — pronounced, is usually quite large and rounded with less definition in structure. At times these tubercles will run together forming a single mass along an individual or combination of areas (B, C and D, described below). Coloration and design are similar to rating 2 but at times are fairly indiscriminate. Using this rating system generally will result in overall tubercle scores of < 50 in a normal control male possessing a tubercle count of 18 to 20 (Jensen *et al.* 2001).

Figure 1

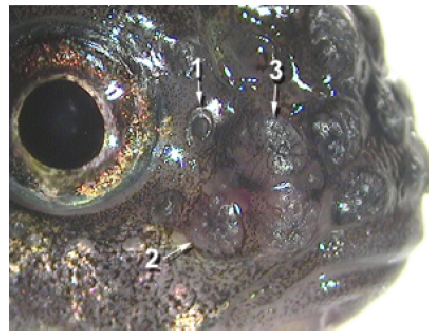

The actual number of tubercles in some fish may be greater than the template boxes for a particular rating area. If this happens, additional rating numbers may be marked within, to the right or to the left of the box. The template therefore does not need to display symmetry. An additional technique for mapping tubercles which are paired or joined vertically along the horizontal plane of the mouth could be done by double-marking two tubercle rating points in a single box.

Mapping regions:

A — Tubercles located around eye. Mapped dorsal to ventral around anterior rim of eye. Commonly multiple in mature control males, not present in control females, generally paired (one near each eye) or single in females exposed to androgens.

B — Tubercles located between nares, (sensory canal pores). Normally in pairs for control males at more elevated levels (2- enlarged or 3- pronounced) of development. Not present in control females with some occurrence and development in females exposed to androgens.

C — Tubercles located immediately anterior to nares, parallel to mouth. Generally enlarged or pronounced in mature control males. Present or enlarged in less developed males or androgen-treated females.

▼ **M7**

D — Tubercles located parallel along mouth line. Generally rated developed in control males. Absent in control females but present in androgen-exposed females.

E — Tubercles located on lower jaw, close to mouth, usually small and commonly in pairs. Varying in control or treated males, and treated females.

F — Tubercles located ventral to E. Commonly small and paired. Present in control males and androgen-exposed females.

REFERENCES:

- (1) Ankley GT, Jensen KM, Kahl MD, Korte JJ, Makynen ME. 2001. Description and evaluation of a short-term reproduction test with the fathead minnow (*Pimephales promelas*). *Environ Toxicol Chem* 20:1276-1290.
- (2) Ankley GT, Jensen KM, Makynen EA, Kahl MD, Korte JJ, Hornung MW, Henry TR, Denny JS, Leino RL, Wilson VS, Cardon MC, Hartig PC, Gray EL. 2003. Effects of the androgenic growth promoter 17- β trenbolone on fecundity and reproductive endocrinology of the fathead minnow. *Environ Toxicol Chem* 22:1350-1360.
- (3) Harries JE, Runnalls T, Hill E, Harris CA, Maddix S, Sumpter JP, Tyler CR. 2000. Development of a reproductive performance test for endocrine disrupting chemicals using pair-breeding fathead minnows (*Pimephales promelas*). *Environ Sci Technol* 34:3003-3011.
- (4) Jensen KM, Korte JJ, Kahl MD, Pasha MS, Ankley GT. 2001. Aspects of basic reproductive biology and endocrinology in the fathead minnow (*Pimephales promelas*). *Comp Biochem Physiol C* 128:127-141.
- (5) Kahl MD, Jensen KM, Korte JJ, Ankley GT. 2001. Effects of handling on endocrinology and reproductive performance of the fathead minnow. *J Fish Biol* 59:515-523.
- (6) Miles-Richardson SR, Kramer VJ, Fitzgerald SD, Render JA, Yamini B, Barbee SJ, Giesy JP. 1999. Effects of waterborne exposure of 17-estradiol on secondary sex characteristics and gonads of fathead minnows (*Pimephales promelas*). *Aquat Toxicol* 47:129-145.
- (7) Smith RJF. 1974. Effects of 17 α -methyltestosterone on the dorsal pad and tubercles of fathead minnows (*Pimephales promelas*). *Can J Zool* 52:1031-1038.

Tubercle Template:

ID _____

Date _____

Total Score _____

Numerical Rating

1-present

2-enlarged

3-pronounced

	A	X1	X1	X1	X1
--	---	----	----	----	----

	B	X1	X1	X1	X1
--	---	----	----	----	----

	C	X1	X1	X1	X1	X1	X1	X1	X1	X1	X1
	D	X1	X1	X1	X1	X1	X1	X1	X1	X1	X1

	E	X1	X1		
	F	X1	X1	X1	X1

▼ M7

Appendix 5B

ASSESSMENT OF SECONDARY SEX CHARACTERISTICS IN MEDAKA FOR THE DETECTION OF CERTAIN ENDOCRINE ACTIVE CHEMICALS

Below is a description of the measurement of papillary processes⁽¹⁾, which are the secondary sex characteristics in medaka (*Oryzias latipes*).

- (1) After the excision of the liver (Appendix 6), the carcass is placed into a conical tube containing about 10 ml of 10 % neutral buffered formalin (upside: head, downside: tail). If the gonad is fixed in a solution other than 10 % neutral buffered formalin, make a transverse cut across the carcass between anterior region of anal fin and anus using razor, taking care not to harm the gonopore and gonad itself (Fig.3). Place the cranial side of the fish body into the fixative solution to preserve the gonad, and the tail side of the fish body into the 10 % neutral buffered formalin as described above.
- (2) After placing the fish body into 10 % neutral buffered formalin, grasp the anterior region of the anal fin with tweezers and fold it for about 30 seconds to keep the anal fin open. When grasping the anal fin with tweezers, grasp a few fin rays in the anterior region with care not to scratch the papillary processes.
- (3) After keeping the anal fin open for about 30 seconds, store the fish body in 10 % neutral buffered formalin at room temperature until the measurement of the papillary processes (measurement should be conducted after fixing for at least 24 hours).

Measurement

- (1) After fixing the fish body in the 10 % neutral buffered formalin for at least 24 hours, pick up the fish carcass from the conical tube and wipe the formalin on the filter paper (or paper towel).
- (2) Place the fish abdomen side up. Then cut the anal fin using small dissection scissors carefully (it is preferable to cut the anal fin with small amount of pterygiophore).
- (3) Grasp the anterior region of the severed anal fin with tweezers and put it on a glass slide with a several drops of water. Then cover the anal fin with a cover glass. Be careful not to scratch the papillary processes when grasping the anal fin with tweezers.
- (4) Count the number of the joint plate with papillary processes using the counter under a biological microscope (upright microscope or inverted microscope). The papillary processes are recognised when a small formation of processes is visible on the posterior margin of joint plate. Write the number of joint plate with papillary processes in each fin ray to the worksheet (e.g. first fin ray: 0, second fin ray: 10, third fin ray: 12, etc.) and enter the sum of

⁽¹⁾ Papillary processes normally appear only in adult males and are found on fin rays from the second to the seventh or eighth counting from the posterior end of the anal fin (Fig.1 and 2). However, processes rarely appear on the first fin ray from the posterior end of the anal fin. This SOP covers the measurement of processes on the first fin ray (the fin ray number refers to the order from the posterior end of the anal fin in this SOP).

▼ M7

this number on the Excel spreadsheet by individual fish. If necessary, take a photograph of the anal fin and count the number of joint plate with papillary processes on the photograph.

- (5) After the measurement, put the anal fin into the conical tube described in (1) and store it.

Fig.1.

Diagram showing sexual difference in shape and size of the anal fin. A, male; B, female. Oka, T. B., 1931. On the processes on the fin rays of the male of *Oryzias latipes* and other sex characters of this fish. J. Fac. Sci., Tokyo Univ., IV, 2: 209-218.

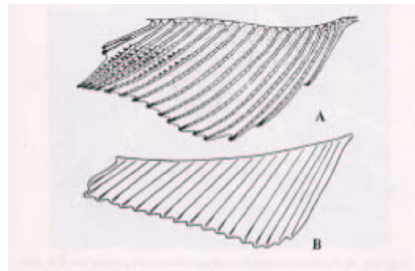

Fig.2.

A, Processes on joint plates of anal fin-ray. J.P., joint plate; A.S., axial space; P., process. B, Distal extremity of fin-ray. Actinotrichia (Act.) are on the tip. Oka, T. B., 1931. On the processes on the fin rays of the male of *Oryzias latipes* and other sex characters of this fish. J. Fac. Sci., Tokyo Univ., IV, 2: 209-218.

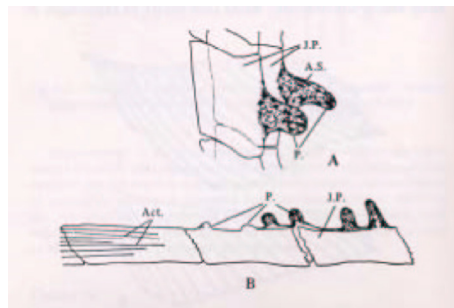
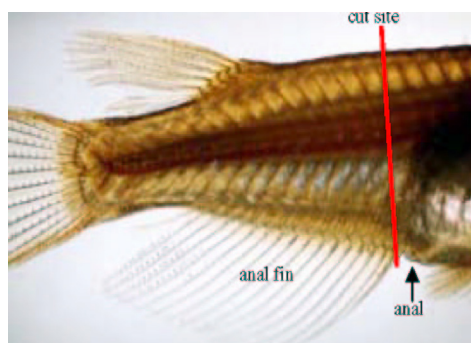

Fig.3.

Photograph of fish body showing the cut site when the gonad is fixed in the fixing solution other than 10 % neutral buffered formalin. In that case, the remaining body will be cut off between anterior region of anal fin and anal using razor (red bar), and the head side of fish body will be put into the fixing solution for gonad and the tail side of the fish body will be put into the 10 % neutral buffered formalin.



▼ M7*Appendix 6***RECOMMENDED PROCEDURES FOR SAMPLE COLLECTION FOR VITELLOGENIN ANALYSIS**

Care should be taken to avoid cross-contamination between VTG samples of males and females.

Procedure 1A: Fathead Minnow, Blood Collection from the Caudal Vein/Artery

After anaesthetisation, the caudal peduncle is partially severed with a scalpel blade and blood is collected from the caudal vein/artery with a heparinised microhematocrit capillary tube. After the blood has been collected, the plasma is quickly isolated by centrifugation for 3 min at 15 000 g (or alternatively for 10 min. at 15 000 g at 4 °C). If desired, percent haematocrit can be determined following centrifugation. The plasma portion is then removed from the microhematocrit tube and stored in a centrifuge tube with 0,13 units of aprotinin (a protease inhibitor) at – 80 °C until determination of VTG can be made. Depending on the size of the fathead minnow (which is sex-dependent), collectable plasma volumes generally range from 5 to 60 microliters per fish (Jensen *et al.* 2001).

Procedure 1B: Fathead Minnow, Blood Collection from Heart

Alternatively, blood may also be collected by cardiac puncture using a heparinised syringe (1 000 units of heparin per ml). The blood is transferred into Eppendorf tubes (held on ice) and then centrifuged (5 min, 7 000 g, room temperature). The plasma should be transferred into clean Eppendorf tubes (in aliquots if the volume of plasma makes this feasible) and promptly frozen at – 80 °C, until analysed (Panter *et al.*, 1998).

Procedure 2A: Japanese Medaka, Excision of the Liver in Medaka*Removal of the test fish from the test chamber*

- (1) Test fish should be removed from the test chamber using the small spoon-net. Be careful not to drop the test fish into other test chambers.
- (2) In principle, the test fish should be removed in the following order: control, solvent control (where appropriate), lowest concentration, middle concentration, highest concentration and positive control. In addition, all males should be removed from one test chamber before the remaining females are removed.
- (3) The sex of each test fish is identified on the basis of external secondary sex characteristics (e.g. the shape of the anal fin).
- (4) Place the test fish in a container for transport and carry it to the workstation for excision of the liver. Check the labels of the test chamber and the transport container for accuracy and to confirm that the number of fish that have been removed from the test chamber and that the number of fish remaining in the test chamber are consistent with expectation.
- (5) If the sex cannot be identified by the fish's external appearance, remove all fish from the test chamber. In this case, the sex should be identified by observing the gonad or secondary sex characteristics under a stereoscopic microscope.

Excision of the liver

- (1) Transfer the test fish from the container for transport to the anaesthetic solution using the small spoon-net.

▼ M7

- (2) After the test fish is anaesthetised, transfer the test fish on the filter paper (or a paper towel) using tweezers (commodity type). When grasping the test fish, apply the tweezers to the sides of the head to prevent breaking the tail.
- (3) Wipe the water on the surface of the test fish on the filter paper (or the paper towel).
- (4) Place the fish abdomen side up. Then make a small transverse incision partway between the ventral neck region and the mid-abdominal region using dissection scissors.
- (5) Insert the dissection scissors into the small incision, and incise the abdomen from a point caudal to the branchial mantle to the cranial side of the anus along the midline of the abdomen. Be careful not to insert the dissection scissors too deeply so as to avoid damaging the liver and gonad.
- (6) Conduct the following operations under the stereoscopic microscope.
- (7) Place the test fish abdomen side up on the paper towel (glass Petri dish or slide glass are also available).
- (8) Extend the walls of the abdominal cavity with precision tweezers and exteriorise the internal organs. It is also acceptable to exteriorise the internal organs by removing one side of the wall of the abdominal cavity if necessary.
- (9) Expose the connected portion of the liver and gallbladder using another pair of precision tweezers. Then grasp the bile duct and cut off the gallbladder. Be careful not to break the gallbladder.
- (10) Grasp the oesophagus and excise the gastrointestinal tract from the liver in the same way. Be careful not to leak the contents of the gastrointestinal tract. Excise the caudal gastrointestinal tract from the anus and remove the tract from the abdominal cavity.
- (11) Trim the mass of fat and other tissues from the periphery of the liver. Be careful not to scratch the liver.
- (12) Grasp the hepatic portal area using the precision tweezers and remove the liver from the abdominal cavity.
- (13) Place the liver on the slide glass. Using the precision tweezers, remove any additional fat and extraneous tissue (e.g. abdominal lining), if needed, from the surface of the liver.
- (14) Measure the liver weight with 1,5 ml microtube as a tare using an electronic analytical balance. Record the value on the worksheet (read: 0,1 mg). Confirm the identification information on the microtube label.
- (15) Close the cap of the microtube containing the liver. Store it in a cooling rack (or ice rack).
- (16) Following the excision of one liver, clean the dissection instruments or replace them with clean ones.

▼M7

- (17) Remove livers from all of the fish in the transport container as described above.
- (18) After the livers have been excised from all of the fish in the transport container (i.e., all males or females in a test chamber), place all liver specimens in a tube rack with a label for identification and store it in a freezer. When the livers are donated for pre-treatment shortly after the excision, the specimens are carried to the next workstation in a cooling rack (or ice rack).

Following liver excision, the fish carcass is available for gonad histology and measurement of secondary sex characteristics.

Specimen

Store the liver specimens taken from the test fish at ≤ -70 °C if they are not used for the pre-treatment shortly after the excision.

Figure 1

A cut is made just anterior to pectoral fins with scissors

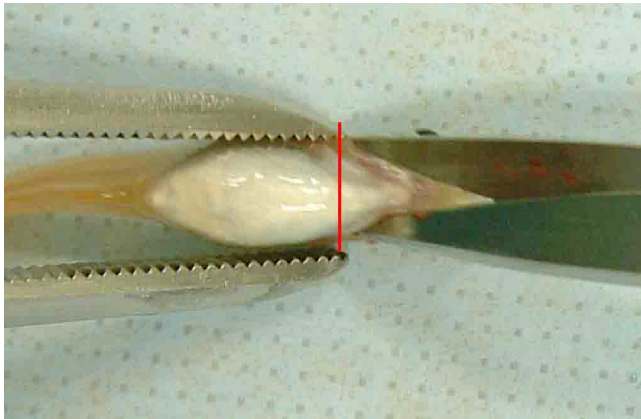
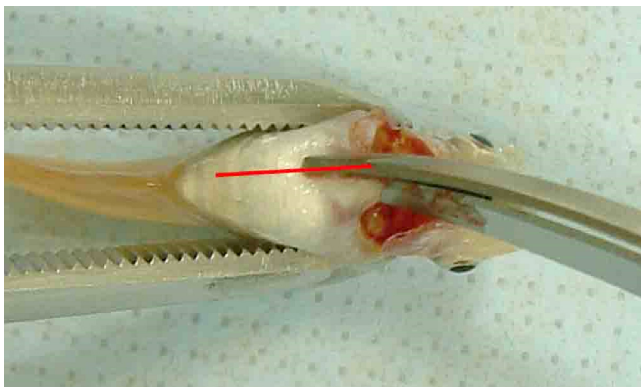

Figure 2

The midline of abdomen is incised with scissors to a point approximately 2 mm cranial to the anus



▼ M7

Figure 3

The abdominal walls are spread with forceps for exposure of the liver and other internal organs

(Alternatively, the abdominal walls may be pinned laterally).

Arrow shows liver

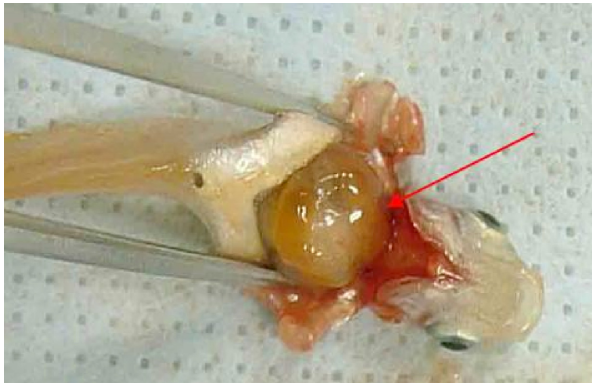

Figure 4

The liver is bluntly dissected and excised using forceps

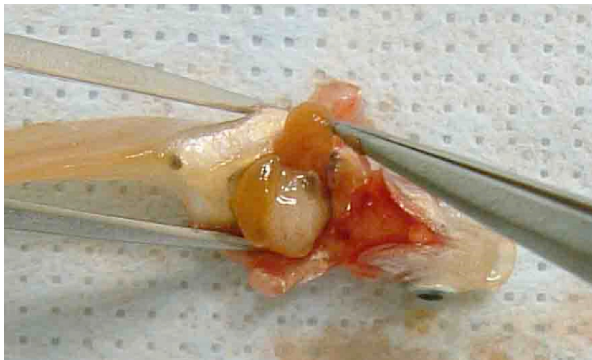
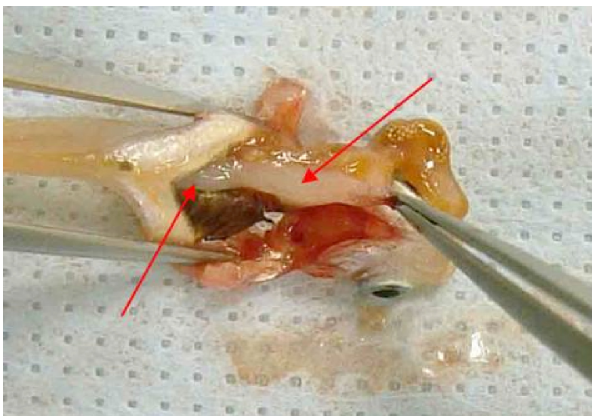

Figure 5

The intestines are gently retracted using forceps



▼ M7

Figure 6

Both ends of the intestines and any mesenteric attachments are severed using scissors

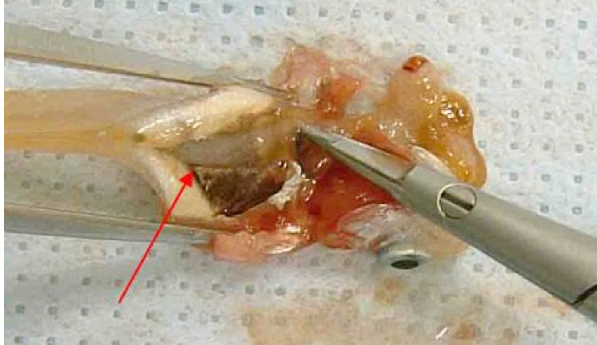

Figure 7 (female)

The procedure is identical for the female

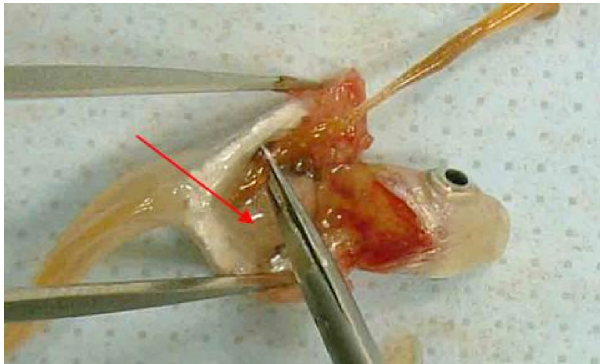
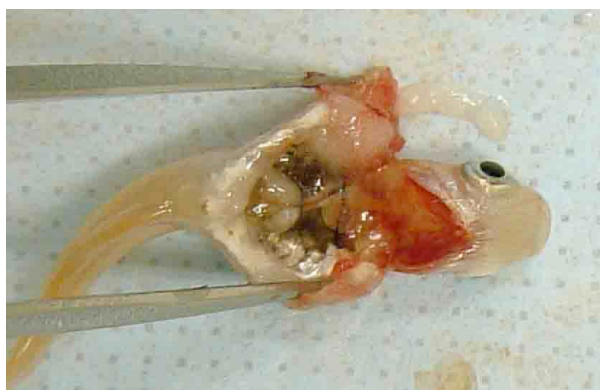

Figure 8

The completed procedure



▼ M7**Procedure 2 B: Japanese Medaka (*Oryzias latipes*), Liver Pre-treatment for Vitellogenin Analysis**

Take the bottle of homogenate buffer from the ELISA kit and cool it with crushed ice (temperature of the solution: $\leq 4^{\circ}\text{C}$). If homogenate buffer from EnBio ELISA system is used, thaw the solution at room temperature, and then cool the bottle with crushed ice.

Calculate the volume of homogenate buffer for the liver on the basis of its weight (add 50 μl of homogenate buffer per mg liver weight). For example, if the weight of the liver is 4,5 mg, the volume of homogenate buffer for the liver is 225 μl . Prepare a list of the volume of homogenate buffer for all livers.

Preparation of the liver for pre-treatment

- (1) Take the 1,5 ml microtube containing the liver from the freezer just before the pre-treatment.
- (2) Pre-treatment of the liver from males should be performed before females to prevent vitellogenin contamination. In addition, the pre-treatment for test groups should be conducted in the following order: control, solvent control (where appropriate), lowest concentration, middle concentration, highest concentration and positive control.
- (3) The number of 1,5 ml microtubes containing liver samples taken from the freezer at a given time should not exceed the number that can be centrifuged at that time.
- (4) Arrange the 1,5 ml microtubes containing liver samples in the order of specimen number on the ice rack (no need to thaw the liver).

Operation of the pre-treatment

- (1) Addition of the homogenate buffer

Check the list for the volume of the homogenate buffer to be used for a particular sample of liver and adjust the micropipette (volume range: 100-1 000 μl) to the appropriate volume. Attach a clean tip to the micropipette.

Take the homogenate buffer from the reagent bottle and add the buffer to the 1,5 ml microtube containing the liver.

Add the homogenate buffer to all of 1,5 ml microtubes containing the liver according to the procedure described above. There is no need to change the micropipette tip to a new one. However, if the tip is contaminated or suspected to be contaminated, the tip should be changed.

- (2) Homogenisation of the liver

- Attach a new pestle for homogenisation to the microtube homogeniser.
- Insert the pestle into the 1,5 ml microtube. Hold the microtube homogeniser to press the liver between the surface of the pestle and the inner wall of the 1,5 ml microtube.
- Operate the microtube homogeniser for 10 to 20 seconds. Cool the 1,5 ml microtube with crushed ice during the operation.

▼ M7

- Lift up the pestle from the 1,5 ml microtube and leave it at rest for about 10 seconds. Then conduct a visual check of the state of the suspension.
 - If pieces of liver are observed in the suspension, repeat the operations (3) and (4) to prepare satisfactory liver homogenate.
 - Cool the suspended liver homogenate on the ice rack until centrifugation.
 - Change the pestle to the new one for each homogenate.
 - Homogenise all livers with homogenate buffer according to the procedure described above.
- (3) Centrifugation of the suspended liver homogenate
- Confirm the temperature of the refrigerated centrifuge chamber at ≤ 5 °C.
 - Insert the 1,5 ml microtubes containing the suspended liver homogenate in refrigerated centrifuge (adjust the balance if necessary).
 - Centrifuge the suspended liver homogenate at 13 000 *g* for 10 min at ≤ 5 °C. However, if the supernatants are adequately separated, centrifugal force and time may be adjusted as needed.
 - Following centrifugation, check that the supernatants are adequately separated (surface: lipid, intermediate: supernatant, bottom layer: liver tissue). If the separation is not adequate, centrifuge the suspension again under the same conditions.
 - Remove all specimens from the refrigerated centrifuge and arrange them in the order of specimen number on the ice rack. Be careful not to resuspend each separated layer after the centrifugation.
- (4) Collection of the supernatant
- Place four 0,5 ml microtubes for storage of the supernatant into the tube rack.
 - Collect 30 μ l of each supernatant (separated as the intermediate layer) with the micropipette and dispense it to one 0,5 ml microtube. Be careful not to collect the lipid on the surface or the liver tissue in the bottom layer.
 - Collect the supernatant and dispense it to other two 0,5 ml microtubes in the same manner as described above.
 - Collect the rest of the supernatant with the micropipette (if feasible: ≥ 100 μ l). Then dispense the supernatant to the remaining 0,5 ml microtube. Be careful not to collect the lipid on the surface or the liver tissue in the bottom layer.
 - Close the cap of the 0,5 ml microtube and write the volume of the supernatant on the label. Then immediately cool the microtubes on the ice rack.
 - Change the tip of the micropipette to the new one for each supernatant. If a large amount of lipid becomes attached to the tip, change it to the new one immediately to avoid contamination of the liver extract with fat.

▼ M7

- Dispense all of the centrifuged supernatant to four 0,5 ml microtubes according to the procedure described above.

- After dispensing the supernatant to the 0,5 ml microtubes, place all of them in the tube rack with the identification label, and then freeze them in the freezer immediately. If the VTG concentrations are measured immediately after the pre-treatment, keep one 0,5 ml microtube (containing 30 µl of supernatant) cool in the tube rack and transfer it to the workstation where the ELISA assay is conducted. In such case, place the remaining microtubes in the tube racks and freeze them in the freezer.

- After the collection of the supernatant, discard the residue adequately.

Storage of the specimen

Store the 0,5 ml microtubes containing the supernatant of the liver homogenate at ≤ -70 °C until they are used for the ELISA.

Procedure 3A: Zebrafish, Blood Collection from the Caudal Vein / Artery

Immediately following anaesthesia, the caudal peduncle is severed transversely, and the blood is removed from the caudal artery/vein with a heparinised microhematocrit capillary tube. Blood volumes range from 5 to 15 microliters depending on fish size. An equal volume of aprotinin buffer (6 micrograms/ml in PBS) is added to the microcapillary tube, and plasma is separated from the blood via centrifugation (5 minutes at 600 g). Plasma is collected in the test tubes and stored at -20 °C until analysed for VTG or other proteins of interest.

Procedure 3B: Zebrafish, Blood Collection by Cardiac Puncture

To avoid coagulation of blood and degradation of protein the samples are collected within Phosphate-buffered saline (PBS) buffer containing heparin (1 000 units/ml) and the protease inhibitor aprotinin (2 TIU/ml). As ingredients for the buffer, heparin, ammonium-salt and lyophilised aprotinin are recommended. For blood sampling, a syringe (1ml) with a fixed thin needle (e.g. Braun Omnikan-F) is recommended. The syringe should be pre-filled with buffer (approximately 100 microliter) to completely elute the small blood volumes from each fish. The blood samples are taken by cardiac puncture. At first the fish should be anesthetized with MS-222 (100 mg/l). The proper plane of anaesthesia allows the user to distinguish the heartbeat of the zebrafish. While puncturing the heart, keep the syringe piston under weak tension. Collectable blood volumes range between 20 - 40 microliters. After cardiac puncture, the blood/buffer-mixture should be filled into the test tube. Plasma is separated from the blood via centrifugation (20 min; 5 000 g) and should be stored at -80 °C until required for analysis.

Procedure 3C: SOP: Zebrafish, homogenisation of head & tail

1. The fish are anaesthetised and euthanised in accordance with the test description.

2. The head and tail are cut of the fish in accordance with Figure 1.

Important: All dissection instruments, and the cutting board should be rinsed and cleaned properly (e.g. with 96 % ethanol) between handling of each single fish to prevent 'vitellogenin pollution' from females or induced males to uninduced males.

▼ M7

Figure 1

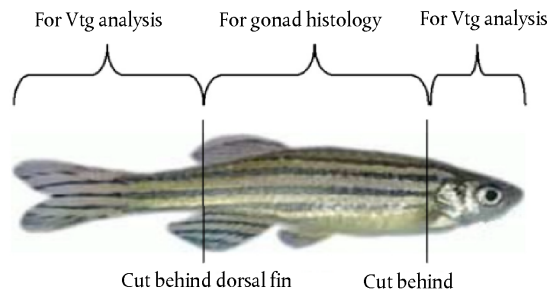

3. The weight of the pooled head and tail from each fish is measured to the nearest mg.
4. After being weighed, the parts are placed in appropriate tubes (e.g. 1,5 ml eppendorf) and frozen at $-80\text{ }^{\circ}\text{C}$ until homogenisation or directly homogenised on ice with two plastic pistils. (Other methods can be used if they are performed on ice and the result is a homogenous mass). Important: *The tubes should be numbered properly so that the head and tail from the fish can be related to their respective body-section used for gonad histology.*
5. When a homogenous mass is achieved, 4 x the tissue weight of ice-cold **homogenisation buffer** ⁽¹⁾ is added. Keep working with the pistils until the mixture is homogeneous. Important note: *New pistils are used for each fish.*
6. The samples are placed on ice until centrifugation at $4\text{ }^{\circ}\text{C}$ at 50 000 g for 30 min.
7. Use a pipette to dispense portions of 20 μl supernatant into **at least two** tubes by dipping the tip of the pipette below the fat layer on the surface and carefully sucking up the supernatant without fat- or pellet fractions.
8. The tubes are stored at $-80\text{ }^{\circ}\text{C}$ until use.

⁽¹⁾ Homogenisation buffer:

- (50 mM Tris-HCl pH 7,4; 1 % Protease inhibitor cocktail (Sigma)): 12 ml Tris-HCl pH 7,4 + 120 μl Protease inhibitor cocktail.
- TRIS: TRIS-ULTRA PURE (ICN) e.g. from Bie & Berntsen, Denmark.
- Protease inhibitor cocktail: From Sigma (for mammalian tissue) Product number P 8340.

NOTE: The homogenisation buffer should be used the same day as manufactured. Place on ice during use.

▼ M7*Appendix 7***VITELLOGENIN FORTIFICATION SAMPLES AND INTER-ASSAY REFERENCE STANDARD**

On each day that VTG assays are performed, a fortification sample made using an inter-assay reference standard will be analysed. The VTG used to make the inter-assay reference standard will be from a batch different from the one used to prepare calibration standards for the assay being performed.

The fortification sample will be made by adding a known quantity of the inter-assay standard to a sample of control male plasma. The sample will be fortified to achieve a VTG concentration between 10 and 100 times the expected vitellogenin concentration of control male fish. The sample of control male plasma that is fortified may be from an individual fish or may be a composite from several fish.

A subsample of the unfortified control male plasma will be analysed in at least two duplicate wells. The fortified sample also will be analysed in at least two duplicate wells. The mean quantity of vitellogenin in the two unfortified control male plasma samples will be added to the calculated quantity of VTG added to fortification the samples to determine an expected concentration. The ratio of this expected concentration to the measured concentration will be reported along with the results from each set of assays performed on that day.

DECISION FLOWCHART FOR THE STATISTICAL ANALYSIS

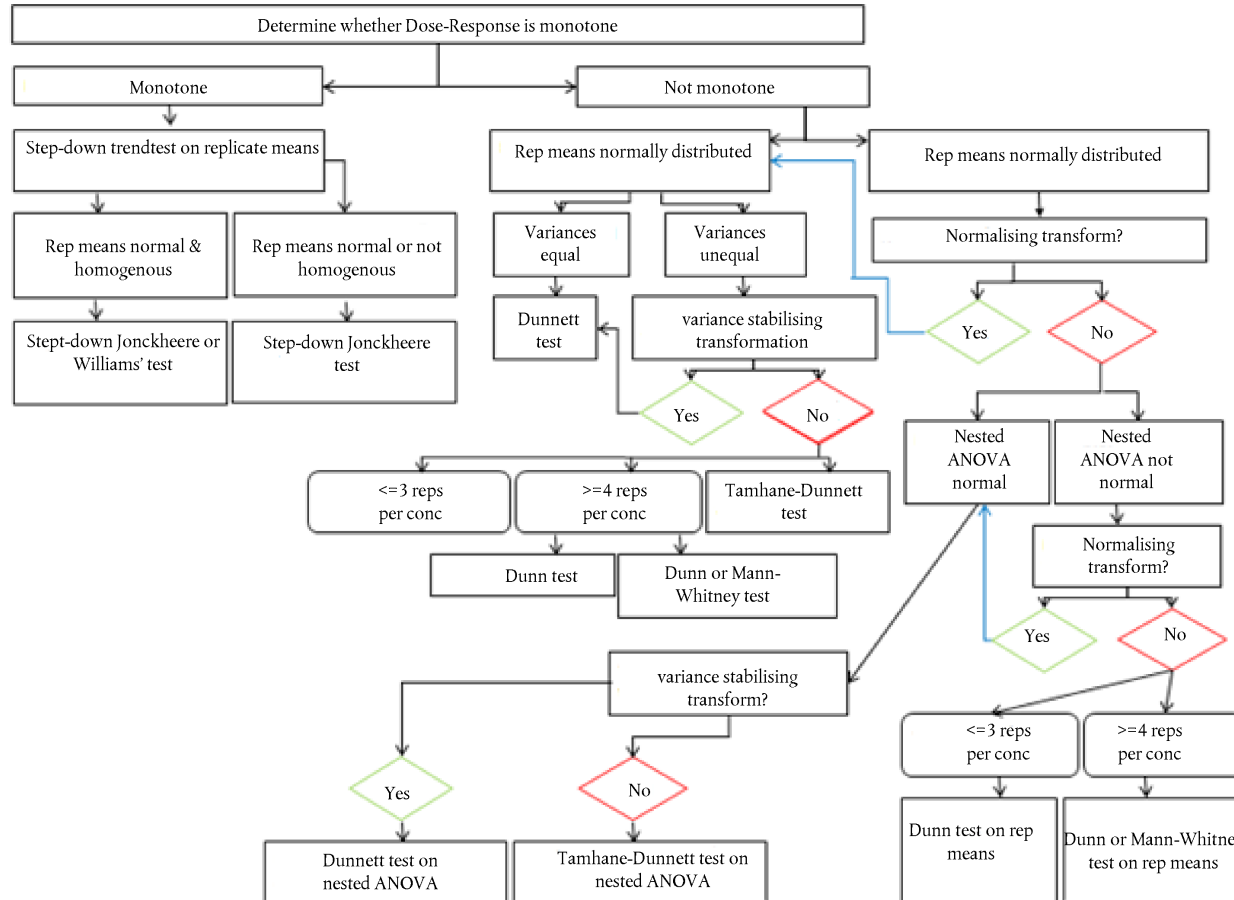

▼M7**C.49. FISH EMBRYO ACUTE TOXICITY (FET) TEST**

INTRODUCTION

1. This test method (TM) is equivalent to OECD test guideline (TG) 236 (2013). It describes a Fish Embryo Acute Toxicity (FET) test with the zebrafish (*Danio rerio*). This test is designed to determine acute toxicity of chemicals on embryonic stages of fish. The FET-test is based on studies and validation activities performed on zebrafish (1)(2)(3)(4)(5)(6)(7)(8)(9)(10)(11)(12)(13)(14). The FET-test has been successfully applied to a wide range of chemicals exhibiting diverse modes of action, solubilities, volatilities, and hydrophobicities (reviewed in 15 and 16).
2. Definitions used in this test method are given in Appendix 1.

PRINCIPLE OF THE TEST

3. Newly fertilised zebrafish eggs are exposed to the test chemical for a period of 96 hrs. Every 24 hrs, up to four apical observations are recorded as indicators of lethality (6): (i) coagulation of fertilised eggs, (ii) lack of somite formation, (iii) lack of detachment of the tail-bud from the yolk sac, and (iv) lack of heartbeat. At the end of the exposure period, acute toxicity is determined based on a positive outcome in any of the four apical observations recorded, and the LC₅₀ is calculated.

INITIAL CONSIDERATIONS

4. Useful information about substance-specific properties include the structural formula, molecular weight, purity, stability in water and light, pK_a and K_{ow}, water solubility and vapour pressure as well as results of a test for ready biodegradability (TM C.4 (17) or TM C.29 (18)). Solubility and vapour pressure can be used to calculate Henry's law constant, which will indicate whether losses due to evaporation of the test chemical may occur. A reliable analytical method for the quantification of the substance in the test solutions with known and reported accuracy and limit of detection should be available.
5. If the test method is used for the testing of a mixture, its composition should, as far as possible, be characterised, e.g. by the chemical identity of its constituents, their quantitative occurrence and their substance-specific properties (see paragraph 4). Before use of the test method for regulatory testing of a mixture, it should be considered whether it will provide acceptable results for the intended regulatory purpose.
6. Concerning substances that may be activated via metabolism, there is evidence that zebrafish embryos do have biotransformation capacities (19)(20)(21)(22). However, the metabolic capacity of embryonic fish is not always similar to that of juvenile or adult fish. For instance, the protoxicant allyl alcohol (9) has been missed in the FET. Therefore, if there are any indications that metabolites or other transformation products of relevance may be more toxic than the parent compound, it is also recommended to perform the test with these metabolites/transformation products and to also use these results when concluding on the toxicity of the test chemical, or alternatively perform another test which takes metabolism into further account.
7. For substances with a molecular weight $\geq 3\text{kDa}$, a very bulky molecular structure, and substances causing delayed hatch which might preclude or reduce the post-hatch exposure, embryos are not expected to be sensitive because of limited bioavailability of the substance, and other toxicity tests might be more appropriate.

▼M7

VALIDITY OF THE TEST

8. For the test results to be valid, the following criteria apply:
 - (a) The overall fertilisation rate of all eggs collected should be $\geq 70\%$ in the batch tested.
 - (b) The water temperature should be maintained at $26 \pm 1\text{ }^{\circ}\text{C}$ in test chambers at any time during the test.
 - (c) Overall survival of embryos in the negative (dilution-water) control, and, where relevant, in the solvent control should be $\geq 90\%$ until the end of the 96 hrs exposure.
 - (d) Exposure to the positive control (e.g. 4,0 mg/l 3,4-dichloroaniline for zebrafish) should result in a minimum mortality of 30 % at the end of the 96 hrs exposure.
 - (e) Hatching rate in the negative control (and solvent control if appropriate) should be $\geq 80\%$ at the end of 96 hrs exposure.
 - (f) At the end of the 96 hrs exposure, the dissolved oxygen concentration in the negative control and highest test concentration should be $\geq 80\%$ of saturation.

DESCRIPTION OF THE METHOD

9. An overview of recommended maintenance and test conditions is available in Appendix 2.

Apparatus

10. The following equipment is needed:
 - (a) Fish tanks made of chemically inert material (e.g. glass) and of a suitable capacity in relation to the recommended loading (see 'Maintenance of brood fish', paragraph 14);
 - (b) Inverted microscope and/or binocular with a capacity of at least 80-fold magnification. If the room used for recording observations cannot be adjusted to $26 \pm 1\text{ }^{\circ}\text{C}$, a temperature-controlled cross movement stage or other methods to maintain temperature are necessary;
 - (c) Test chambers; e.g., standard 24-well plates with a depth of approx. 20 mm. (see 'Test chambers', paragraph 11);
 - (d) e.g., self-adhesive foil to cover the 24-well plates;
 - (e) Incubator or air-conditioned room with controlled temperature, allowing to maintain $26 \pm 1\text{ }^{\circ}\text{C}$ in wells (or test chambers);
 - (f) pH-meter;
 - (g) Oxygen meter;
 - (h) Equipment for determination of hardness of water and conductivity;
 - (i) Spawn trap: instrument trays of glass, stainless steel or other inert materials; wire mesh (grid size $2 \pm 0,5\text{ mm}$) of stainless steel or other inert material to protect the eggs once laid; spawning substrate (e.g. plant imitates of inert material) (TM C.48, Appendix 4a (23));
 - (j) Pipettes with widened openings to collect eggs;

▼M7

- (k) Glass vessels to prepare different test concentrations and dilution water (beakers, graduated flasks, graduated cylinders and graduated pipettes) or to collect zebrafish eggs (e.g. beakers, crystallisation dishes);
- (l) If alternative exposure systems, such as flow-through (24) or passive dosing (25) are used for the conduct of the test, appropriate facilities and equipment are needed.

Test chambers

11. Glass or polystyrene test chambers should be used (e.g. 24-well plates with a 2,5-5 ml filling capacity per well). In case adsorption to polystyrene is suspected (e.g., for non-polar, planar substances with high K_{OW}), inert materials (glass) should be used to reduce losses due to adsorption (26). Test chambers should be randomly positioned in the incubator.

Water and test conditions

12. Dilution of the maintenance water is recommended to achieve hardness levels typical of a wide variety of surface waters. Dilution water should be prepared from reconstituted water (27). The resulting degree of hardness should be equivalent to 100-300 mg/l $CaCO_3$ in order to prevent excessive precipitation of calcium carbonate. Other well-characterised surface or well water may be used. The reconstituted water may be adapted to maintenance water of low hardness by dilution with deionised water up to a ratio of 1:5 to a minimum hardness of 30-35 mg/l $CaCO_3$. The water is aerated to oxygen saturation prior to addition of the test chemical. Temperature should be kept at 26 ± 1 °C, in the wells, throughout the test. The pH should be in a range between pH 6,5 and 8,5, and not vary within this range by more than 1,5 units during the course of the test. If the pH is not expected to remain in this range, then pH adjustment should be done prior to initiating the test. The pH adjustment should be made in such a way that the stock solution concentration is not changed to any significant extent and that no chemical reaction or precipitation of the test chemical is caused. Use of hydrogen chloride (HCl) and sodium hydroxide (NaOH) to correct pH in the solutions containing the test chemical is recommended.

Test solutions

13. Test solutions of the selected concentrations can be prepared, e.g. by dilution of a stock solution. The stock solutions should preferably be prepared by simply mixing or agitating the test chemical in the dilution water by mechanical means (e.g. stirring and/or ultra-sonification). If the test chemical is difficult to dissolve in water, procedures described in the OECD Guidance Document No. 23 for handling difficult substances and mixtures should be followed (28). The use of solvents should be avoided, but may be required in some cases in order to produce a suitably concentrated stock solution. Where a solvent is used to assist in stock solution preparation, its final concentration should not exceed 100 µl/l and should be the same in all test vessels. When a solvent is used, an additional solvent control is required.

Maintenance of brood fish

14. A breeding stock of unexposed, wild-type zebrafish with well-documented fertilisation rate of eggs is used for egg production. Fish should be free of macroscopically discernible symptoms of infection and disease and should not have undergone any pharmaceutical (acute or prophylactic) treatment for 2 months before spawning. Breeding fish are maintained in aquaria with a recommended loading capacity of 1 l water per fish and a fixed 12 - 16 hour photoperiod (29)(30)(31)(32)(33). Optimal filtering rates should be adjusted; excess filtering rates causing heavy perturbation of the water should be

▼ M7

avoided. For feeding conditions, see Appendix 2. Surplus feeding should be avoided, and water quality and cleanness of the aquaria should be monitored regularly and be reset to the initial state, if necessary.

Proficiency Testing

15. As a reference chemical, 3,4-dichloroaniline (used in the validation studies (1)(2)), should be tested in a full concentration-response range to check the sensitivity of the fish strain used, preferably twice a year. For any laboratory initially establishing this assay, the reference chemical should be used. A laboratory can use this chemical to demonstrate their technical competence in performing the assay prior to submitting data for regulatory purposes.

Egg production

16. Zebrafish eggs may be produced via spawning groups (in individual spawning tanks) or via mass spawning (in the maintenance tanks). In the case of spawning groups, males and females (e.g., at a ratio of 2:1) in a breeding group are placed in spawning tanks a few hours before the onset of darkness on the day prior to the test. Since spawning groups of zebrafish may occasionally fail to spawn, the parallel use of at least three spawning tanks is recommended. To avoid genetic bias, eggs are collected from a minimum of three breeding groups, mixed and randomly selected.
17. For the collection of eggs, spawn traps are placed into the spawning tanks or maintenance tanks before the onset of darkness on the day prior to the test or before the onset of light on the day of the test. To prevent predation of eggs by adult zebrafish, the spawn traps are covered with inert wire mesh of appropriate mesh size (approx. $2 \pm 0,5$ mm). If considered necessary, artificial plants made of inert material (e.g., plastic or glass) can be fixed to the mesh as spawning stimulus (3)(4)(5)(23)(35). Weathered plastic materials which do not leach (e.g., phthalates) should be used. Mating, spawning and fertilisation take place within 30 min after the onset of light and the spawn traps with the collected eggs can be carefully removed. Rinsing eggs with reconstituted water after collection from spawning traps is recommended.

Egg differentiation

18. At 26 °C, fertilised eggs undergo the first cleavage after about 15 min and the consecutive synchronous cleavages form 4, 8, 16 and 32 cell blastomers (see Appendix 3)(35). At these stages, fertilised eggs can be clearly identified by the development of a blastula.

PROCEDURE**Conditions of exposure**

19. Twenty embryos per concentration (one embryo per well) are exposed to the test chemical. Exposure should be such that ± 20 % of the nominal chemical concentration are maintained throughout the test. If this is not possible in a static system, a manageable semi-static renewal interval should be applied (e.g. renewal every 24 hrs). In these cases exposure concentrations need to be verified as a minimum in the highest and lowest test concentrations at the beginning and the end of each exposure interval (see paragraph 36). If an exposure concentration of ± 20 % of the nominal concentrations cannot be maintained, all concentrations need to be measured at the beginning and the end of each exposure interval (see paragraph 36). Upon renewal, care should be taken that embryos remain covered by a small amount of old test solutions to avoid drying. The test design can be adapted to meet the testing requirements of specific substances (e.g., flow-through (24) or passive dosing systems (25) for easily degradable or highly adsorptive substances (29), or others for volatile substances (36)(37)). In any case,

▼M7

care should be taken to minimise any stress to the embryos. Test chambers should be conditioned at least for 24 hrs with the test solutions prior to test initiation. Test conditions are summarised in Appendix 2.

Test concentrations

20. Normally, five concentrations of the test chemical spaced by a constant factor not exceeding 2,2 are required to meet statistical requirements. Justification should be provided, if fewer than five concentrations are used. The highest concentration tested should preferably result in 100 % lethality, and the lowest concentration tested should preferably give no observable effect, as defined in paragraph 28. A range-finding test before the definitive test allows selection of the appropriate concentration range. The range-finding is typically performed using ten embryos per concentration. The following instructions refer to performing the test in 24-well plates. If different test chambers (e.g. small Petri dishes) are used or more concentrations are tested, instructions have to be adjusted accordingly.
21. Details and visual instructions for allocation of concentrations across 24-well plates are available in paragraph 27 and Appendix 4, Figure 1.

Controls

22. Dilution water controls are required both as negative control and as internal plate controls. If more than 1 dead embryo is observed in the internal plate control, the plate is rejected, thus reducing the number of concentrations used to derive the LC₅₀. If an entire plate is rejected the ability to evaluate and discern observed effects may become more difficult, especially if the rejected plate is the solvent control plate or a plate in which treated embryos are also affected. In the first case the test must be repeated. In the second one the loss of an entire treatment group(s) due to internal control mortality may limit the ability to evaluate effects and determine LC₅₀ values.
23. A positive control at a fixed concentration of 4 mg/l 3,4-dichloroaniline is performed with each egg batch used for testing.
24. In case a solvent is used, an additional group of 20 embryos is exposed to the solvent on a separate 24-well plate, thus serving as a solvent control. To consider the test acceptable, the solvent should be demonstrated to have no significant effects on time to hatch, survival, nor produce any other adverse effects on the embryos (cf. paragraph 8c).

Start of exposure and duration of test

25. The test is initiated as soon as possible after fertilisation of the eggs and terminated after 96 hrs of exposure. The embryos should be immersed in the test solutions before cleavage of the blastodisc commences, or, at latest, by the 16 cell-stage. To start exposure with minimum delay, at least twice the number of eggs needed per treatment group are randomly selected and transferred into the respective concentrations and controls (e.g. in 100 ml crystallisation dishes; eggs should be fully covered) not later than 90 minutes post fertilisation.
26. Viable fertilised eggs should be separated from unfertilised eggs and be transferred to 24-well plates pre-conditioned for 24 hrs and refilled with 2 ml/well freshly prepared test solutions within 180 minutes post fertilisation. By means of stereomicroscopy (preferably ≥ 30 -fold magnification), fertilised eggs undergoing cleavage and showing no obvious irregularities

▼ **M7**

during cleavage (e.g. asymmetry, vesicle formation) or injuries of the chorion are selected. For egg collection and separation, see Appendix 3, Fig. 1 and 3 and Appendix 4, Fig. 2.

Distribution of eggs over the 24-well plates

27. Eggs are distributed to well plates in the following numbers (see also Appendix 4, Fig. 1)
- 20 eggs on one plate for each test concentration;
 - 20 eggs as solvent control on one plate (if necessary);
 - 20 eggs as positive control on one plate;
 - 4 eggs in dilution water as internal plate control on each of the above plates;
 - 24 eggs in dilution water as negative control on one plate.

Observations

28. Apical observations performed on each tested embryo include: coagulation of embryos, lack of somite formation, non-detachment of the tail, and lack of heartbeat (Table 1). These observations are used for the determination of lethality: Any positive outcome in one of these observations means that the zebrafish embryo is dead. Additionally, hatching is recorded in treatment and control groups on a daily basis starting from 48 hrs. Observations are recorded every 24 hrs, until the end of the test.

Table 1

Apical observations of acute toxicity in zebrafish embryos 24-96 hrs post fertilisation

	Exposure times			
	24 hrs	48 hrs	72 hrs	96 hrs
Coagulated embryos	+	+	+	+
Lack of somite formation	+	+	+	+
Non-detachment of the tail	+	+	+	+
Lack of heartbeat		+	+	+

29. *Coagulation of the embryo*: Coagulated embryos are milky white and appear dark under the microscope (see Appendix 5, Fig. 1). The number of coagulated embryos is determined after 24, 48, 72 and 96 hrs.
30. *Lack of somite formation*: At 26 ± 1 °C, about 20 somites have formed after 24 hrs (see Appendix 5, Figure 2) in a normally developing zebrafish embryo. A normally developed embryo shows spontaneous movements (side-to-side contractions). Spontaneous movements indicate the formation of somites. The absence of somites is recorded after 24, 48, 72 and 96 hrs. Non-formation of somites after 24 hrs might be due to a general retardation of development. At latest after 48 hrs, the formation of somites should be developed. If not, the embryos are considered dead.
31. *Non-detachment of the tail*: In a normally developing zebrafish embryo, detachment of the tail (see Appendix 5, Figure 3) from the yolk is observed

▼M7

following posterior elongation of the embryonic body. Absence of tail detachment is recorded after 24, 48, 72 and 96 hrs.

32. *Lack of heartbeat*: In a normally developing zebrafish embryo at 26 ± 1 °C, the heartbeat is visible after 48 hrs (see Appendix 5, Figure 4). Particular care should be taken when recording this endpoint, since irregular (erratic) heartbeat should *not* be recorded as lethal. Moreover, visible heartbeat without circulation in aorta abdominalis is considered non-lethal. To record this endpoint, embryos showing no heartbeat should be observed under a minimum magnification of 80x for at least one minute. Absence of heartbeat is recorded after 48, 72 and 96 hrs.
33. Hatching rates of all treatment and control groups should be recorded from 48 hrs onwards and reported. Although hatching is not an endpoint used for the calculation of the LC₅₀, hatching ensures exposure of the embryo without a potential barrier function of the chorion, and as such may help data interpretation.
34. Detailed descriptions of the normal (35) and examples of abnormal development of zebrafish embryos are illustrated in Appendixes 3 and 5.

Analytical measurements

35. At the beginning and at the end of the test, pH, total hardness and conductivity in the control(s) and in the highest test chemical concentration are measured. In semi-static renewal systems the pH should be measured prior to and after water renewal. The dissolved oxygen concentration is measured at the end of the test in the negative controls and highest test concentration with viable embryos, where it should be in compliance with the test validity criteria (see paragraph 8f). If there is concern that the temperature varies across the 24-well plates, temperature is measured in three randomly selected vessels. Temperature should be recorded preferably continuously during the test or, as a minimum, daily.
36. In a static system, the concentration of the test chemical should be measured, as a minimum, in the highest and lowest test concentrations, but preferably in all treatments, at the beginning and end of the test. In semi-static (renewal) tests where the concentration of the test chemical is expected to remain within ± 20 % of the nominal values, it is recommended that, as a minimum, the highest and lowest test concentrations be analysed when freshly prepared and immediately prior to renewal. For tests where the concentration of the test chemical is not expected to remain within ± 20 % of nominal, all test concentrations must be analysed when freshly prepared and immediately prior to renewal. In case of insufficient volume for analysis, merging of test solutions, or use of surrogate chambers being of the same material and having the same volume to surface area ratios as 24-well plates, may be useful. It is strongly recommended that results be based on measured concentrations. When the concentrations do not remain within 80-120 % of the nominal concentration, the effect concentrations should be expressed relative to the geometric mean of the measured concentrations; see Chapter 5 in the OECD Guidance Document on Aquatic Toxicity Testing of Difficult Substances and Mixtures for more details (28).

LIMIT TEST

37. Using the procedures described in this test method, a limit test may be performed at 100 mg/l of test chemical or at its limit of solubility in the test medium (whichever is the lower) in order to demonstrate that the LC₅₀ is greater than this concentration. The limit test should be performed using 20 embryos in the treatment, the positive control and –if necessary- in the solvent control and 24 embryos in the negative control. If the percentage of lethality at the concentration tested exceeds the mortality in the negative control (or solvent control) by 10 %, a full study should be conducted. Any observed effects should be recorded. If mortality exceeds 10 % in the

▼M7

negative control (or solvent control), the test becomes invalid and should be repeated.

DATA AND REPORTING**Treatment of results**

38. In this test, the individual wells are considered independent replicates for statistical analysis. The percentages of embryos for which at least one of the apical observations is positive at 48 and/or 96 hrs are plotted against test concentrations. For calculation of the slopes of the curve, LC₅₀ values and the confidence limits (95 %), appropriate statistical methods should be applied (38) and the OECD Guidance Document on Current Approaches in the Statistical Analysis of Ecotoxicity Data should be consulted (39).

Test report

39. The test report should include the following information:

Test chemical:

Mono-constituent substance

- physical appearance, water solubility, and additional relevant physico-chemical properties;
- chemical identification, such as IUPAC or CAS name, CAS number, SMILES or InChI code, structural formula, purity, chemical identity of impurities as appropriate and practically feasible, etc. (including the organic carbon content, if appropriate).

Multi-constituent substance, UVCBs and mixtures:

- characterised as far as possible by chemical identity (see above), quantitative occurrence and relevant physicochemical properties of the constituents.

Test organisms:

- scientific name, strain, source and method of collection of the fertilised eggs and subsequent handling.

Test conditions:

- test procedure used (e.g., semi-static renewal);
- photoperiod;
- test design (e.g., number of test chambers, types of controls);
- water quality characteristics in fish maintenance (e.g. pH, hardness, temperature, conductivity, dissolved oxygen);
- dissolved oxygen concentration, pH, total hardness, temperature and conductivity of the test solutions at the start and after 96 hrs;
- method of preparation of stock solutions and test solutions as well as frequency of renewal;

▼ M7

- justification for use of solvent and justification for choice of solvent, if other than water;
- the nominal test concentrations and the result of all analyses to determine the concentration of the test chemical in the test vessels; the recovery efficiency of the method and the limit of quantification (LoQ) should also be reported;
- evidence that controls met the overall survival validity criteria;
- fertilisation rate of the eggs;
- hatching rate in treatment and control groups.

Results:

- maximum concentration causing no mortality within the duration of the test;
- minimum concentration causing 100 % mortality within the duration of the test;
- cumulative mortality for each concentration at the recommended observation times;
- the LC₅₀ values at 96 hrs (and optionally at 48 hrs) for mortality with 95 % confidence limits, if possible;
- graph of the concentration-mortality curve at the end of the test;
- mortality in the controls (negative controls, internal plate controls, as well as positive control and any solvent control used);
- data on the outcome of each of the four apical observations;
- incidence and description of morphological and physiological abnormalities, if any (see examples provided in Appendix 5, Figure 2);
- incidents in the course of the test which might have influenced the results;
- statistical analysis and treatment of data (probit analysis, logistic regression model and geometric mean for LC₅₀);
- slope and confidence limits of the regression of the (transformed) concentration-response curve.

Any deviation from the test method and relevant explanations.

Discussion and interpretation of results.

LITERATURE

- (1) OECD (2011) Validation Report (Phase 1) for the Zebrafish Embryo Toxicity Test: Part I and Part II. Series on Testing and Assessment No. 157, OECD, Paris.
- (2) OECD (2012) Validation Report (Phase 2) for the Zebrafish Embryo Toxicity Test: Part I and Part II (Annexes). Series on Testing and Assessment No. 179, OECD, Paris.
- (3) Braunbeck, T., Böttcher, M., Hollert, H., Kosmehl, T., Lammer, E., Leist, E., Rudolf, M. and Seitz, N. (2005) Towards an alternative for the acute

▼ M7

fish LC₅₀ test in chemical assessment: The fish embryo toxicity test goes multi-species-an update. ALTEX 22: 87-102.

- (4) ISO (2007) International Standard Water quality — Determination of the acute toxicity of waste water to zebrafish eggs (*Danio rerio*). ISO 15088:2007(E) International Organization for Standardization.
- (5) Nagel, R. (2002) DarT: The embryo test with the zebrafish (*Danio rerio*) — a general model in ecotoxicology and toxicology. ALTEX 19: 38-48.
- (6) Schulte, C. and Nagel, R. (1994) Testing acute toxicity in embryo of zebrafish, *Brachydanio rerio* as alternative to the acute fish test — preliminary results. ATLA 22, 12-19.
- (7) Bachmann, J. (2002) Development and validation of a teratogenicity screening test with embryos of the zebrafish (*Danio rerio*). PhD-thesis, Technical University of Dresden, Germany.
- (8) Lange, M., Gebauer, W., Markl, J. and Nagel, R. (1995) Comparison of testing acute toxicity on embryo of zebrafish (*Brachydanio rerio*), and RTG-2 cytotoxicity as possible alternatives to the acute fish test. Chemosphere 30/11: 2087-2102.
- (9) Knöbel, M., Busser, F.J.M., Rico-Rico, A., Kramer, N.I., Hermens, J.L.M., Hafner, C., Tanneberger, K., Schirmer, K., Scholz, S. (2012). Predicting adult fish acute lethality with the zebrafish embryo: relevance of test duration, endpoints, compound properties, and exposure concentration analysis. Environ. Sci. Technol. 46, 9690-9700.
- (10) Kammann, U., Vobach, M. and Wosniok, W. (2006) Toxic effects of brominated indoles and phenols on zebrafish embryos. Arch. Environ. Contam. Toxicol., 51: 97-102.
- (11) Groth, G., Kronauer, K. and Freundt, K.J. (1994) Effects of *N,N*-dimethylformamide and its degradation products in zebrafish embryos. *In Vitro* 8: 401-406.
- (12) Groth, G., Schreeb, K., Herdt, V. and Freundt, K.J. (1993) Toxicity studies in fertilized zebrafish fish eggs treated with *N*-methylamine, *N,N*-dimethylamine, 2-aminoethanol, isopropylamine, aniline, *N*-methylaniline, *N,N*-dimethylaniline, quinone, chloroacetaldehyde, or cyclohexanol. Bull. Environ. Contam. Toxicol. 50: 878-882.
- (13) Nguyen, L.T. and Janssen, C.R. (2001) Comparative sensitivity of embryo-larval toxicity assays with African catfish (*Clarias gariepinus*) and zebra fish (*Danio rerio*). Environ. Toxicol. 16: 566-571.
- (14) Cheng, S.H., Wai, A.W.K., So, C.H. and Wu, R.S.S. (2000) Cellular and molecular basis of cadmium-induced deformities in zebrafish embryos. Environ. Toxicol. Chem. 19: 3024-3031.
- (15) Belanger, S. E., Rawlings J. M. and Carr G. J. (2013). Use of Fish Embryo Toxicity Tests for the Prediction of Acute Fish Toxicity to Chemicals. Environmental Toxicology and Chemistry 32: 1768-1783. .
- (16) Lammer, E., Carr, G. J., Wendler, K., Rawlings, J. M., Belanger, S. E., Braunbeck, T. (2009) Is the fish embryo toxicity test (FET) with the zebrafish (*Danio rerio*) a potential alternative for the fish acute toxicity test? Comp. Biochem. Physiol. C Toxicol. Pharmacol.: 149 (2), 196-209
- (17) Chapter C.4 of this Annex: Ready Biodegradability.
- (18) Chapter C.29 of this Annex: Ready Biodegradability, CO₂ in sealed vessels.
- (19) Weigt, S., Huebler, N., Strecker, R., Braunbeck, T., Broschard, T.H. (2011) Zebrafish (*Danio rerio*) embryos as a model for testing proteratogens. Toxicology 281: 25-36.

▼ **M7**

- (20) Weigt, S., Huebler, N., Strecker, R., Braunbeck, T., Broschard, T.H. (2012) Developmental effects of coumarin and the anticoagulant coumarin derivative warfarin on zebrafish (*Danio rerio*) embryos. *Reprod. Toxicol.* 33: 133-141.
- (21) Incardona, J.P., Linbo, T.L., Scholz, N.L. (2011) Cardiac toxicity of 5-ring polycyclic aromatic hydrocarbons is differentially dependent on the aryl hydrocarbon receptor 2 isoform during zebrafish development. *Toxicol. Appl. Pharmacol.* 257: 242-249.
- (22) Kubota, A., Stegeman, J.J., Woodin, B.R., Iwanaga, T., Harano, R., Peterson, R.E., Hiraga, T., Teraoka, H. (2011) Role of zebrafish cytochrome P450 CYP1C genes in the reduced mesencephalic vein blood flow caused by activation of AHR2. *Toxicol. Appl. Pharmacol.* 253: 244-252.
- (23) Chapter C.48 of this Annex: Fish Short Term Reproduction Assay.. See Appendix 4a.
- (24) Lammer, E., Kamp, H.G., Hisgen, V., Koch, M., Reinhard, D., Salinas, E.R., Wendlar, K., Zok, S., Braunbeck, T. (2009) Development of a flow-through system for the fish embryo toxicity test (FET) with zebrafish (*Danio rerio*). *Toxicol. in vitro* 23: 1436-1442.
- (25) Brown, R.S., Akhtar, P., Åkerman, J., Hampel, L., Kozin, I.S., Villerius, L.A., Klamer, H.J.C., (2001) Partition controlled delivery of hydrophobic substances in toxicity tests using poly(dimethylsiloxane) (PDMS) films. *Environ. Sci. Technol.* 35, 4097-4102.
- (26) Schreiber, R., Altenburger, R., Paschke, A., Küster, E. (2008) How to deal with lipophilic and volatile organic substances in microtiter plate assays. *Environ. Toxicol. Chem.* 27, 1676-1682.
- (27) ISO (1996) International Standards. Water quality — Determination of the acute lethal toxicity of substances to a freshwater fish [*Brachydanio rerio* Hamilton-Buchanan (Teleostei, Cyprinidae)]. ISO 7346-3: Flow-through method. Available: [<http://www.iso.org>].
- (28) OECD (2000) Guidance Document on Aquatic Toxicity Testing of Difficult Substances and Mixtures. Series on Testing and Assessment No. 23, OECD, Paris.
- (29) Laale, H.W. (1977) The biology and use of zebrafish, *Brachydanio rerio*, in fisheries research. A literature review. *J. Fish Biol.* 10: 121-173.
- (30) Westerfield, M. (2007) The zebrafish book: A guide for the laboratory use of zebrafish (*Brachydanio rerio*). 5th edition. Eugene, University of Oregon Press, Institute of Neuroscience, USA.
- (31) Canadian Council on Animal Care (2005) Guidelines on: the Care and Use of Fish in Research, Teaching and Testing, ISBN: 0-919087-43-4 <http://www.ccac.ca/Documents/Standards/Guidelines/Fish.pdf>
- (32) European Commission (2007) Commission recommendation 2007/526/EC of 18 June 2007 on guidelines for the accommodation and care of animals used for experimental and other scientific purposes (notified under document number C(2007) 2525) [<http://eur-lex.europa.eu/LexUriServ/LexUriServ.do?uri=OJ:L:2007:197:0001:0089:EN:PDF>]
- (33) European Union (2010) Directive 2010/63/EU of the European Parliament and Council of 22 September 2010 on the protection of animals used for scientific purposes (OJ L 276, 20.10.2010, p. 33).
<http://eur-lex.europa.eu/LexUriServ/LexUriServ.do?uri=OJ:L:2010:276:0033:0079:EN:PDF>
- (34) Nagel, R. (1986) Untersuchungen zur Eiproduktion beim Zebrabärbling (*Brachydanio rerio*, Ham.-Buch.). *J. Appl. Ichthyol.* 2: 173-181.

▼ M7

- (35) Kimmel, C.B., Ballard, W.W., Kimmel, S.R., Ullmann, B. and Schilling, T.F. (1995) Stages of embryonic development of the zebrafish. *Dev. Dyn.* 203: 253-310.
- (36) Chapter C.2 of this Annex: *Daphnia* sp., Acute Immobilisation Test.
- (37) Weil, M., Scholz, S., Zimmer, M., Sacher, F., Duis, K. (2009) Gene expression analysis in zebrafish embryos: a potential approach to predict effect concentrations in the fish early life stage test. *Environ. Toxicol. Chem.* 28: 1970-1978
- (38) ISO (2006) International Standard. Water quality — Guidance on statistical interpretation of ecotoxicity data ISO TS 20281. Available: [<http://www.iso.org>].
- (39) OECD (2006) Guidance Document on Current Approaches in the Statistical Analysis of Ecotoxicity Data: a Guidance to Application. Series on Testing and Assessment No. 54. OECD, Paris.
- (40) Braunbeck, T., Lammer, E., 2006. Detailed review paper 'Fish embryo toxicity assays'. UBA report under contract no. 20385422 German Federal Environment Agency, Berlin. 298 pp.

▼ M7*Appendix 1*

DEFINITIONS

Apical endpoint: Causing effect at population level.

Blastula: A cellular formation around the animal pole that covers a certain part of the yolk.

Chemical: A substance or a mixture

Epiboly: is a massive proliferation of predominantly epidermal cells in the gastrulation phase of the embryo and their movement from the dorsal to the ventral side, by which entodermal cell layers are internalised in an invagination-like process and the yolk is incorporated into the embryo.

Flow-through test: A test with continued flow of test solutions through the test system during the duration of exposure.

Internal Plate Control: Internal control consisting of 4 wells filled with dilution water per 24-well plate to identify potential contamination of the plates by the manufacturer or by the researcher during the procedure, and any plate effect possibly influencing the outcome of the test (e.g. temperature gradient).

IUPAC: International Union of Pure and Applied Chemistry

Maintenance water: Water in which the husbandry of the adult fish is performed.

Median Lethal Concentration (LC₅₀): The concentration of a test chemical that is estimated to be lethal to 50 % of the test organisms within the test duration.

Semi-static renewal test: A test with regular renewal of the test solutions after defined periods (e.g., every 24 hrs).

SMILES: Simplified Molecular Input Line Entry Specification

Somite: In the developing vertebrate embryo, somites are masses of mesoderm distributed laterally to the neural tube, which will eventually develop dermis (dermatome), skeletal muscle (myotome), and vertebrae (sclerotome).

Static test: A test in which test solutions remain unchanged throughout the duration of the test.

Test chemical: Any substance or mixture tested using this test method

UVCB: Substances of unknown or variable composition, complex reaction products or biological materials

▼M7

Appendix 2

**MAINTENANCE, BREEDING AND TYPICAL CONDITIONS FOR ZEBRAFISH
EMBRYO ACUTE TOXICITY TESTS**

<i>Zebrafish (Danio rerio)</i>		
Origin of species	India, Burma, Malakka, Sumatra	
Sexual dimorphism	Females: protruding belly, when carrying eggs Males: more slender, orange tint between blue longitudinal stripes (particularly evident at the anal fin)	
Feeding regime	Dry flake food (max. 3 % fish weight per day) 3 - 5 times daily; additionally brine shrimp (<i>Artemia spec.</i>) nauplii and/or small daphnids of appropriate size obtained from an uncontaminated source. Feeding live food provides a source of environmental enrichment and therefore live food should be given wherever possible. To guarantee for optimal water quality, excess food and faeces should be removed approx. one hour after feeding.	
Approximate weight of adult fish	Females: 0,65 ± 0,13 g Males: 0,5 ± 0,1 g	
Maintenance of parental fish	Illumination	Fluorescent bulbs (wide spectrum); 10-20 µE/m ² /s, 540-1 080 lux, or 50-100 ft-c (ambient laboratory levels); 12-16 hrs photoperiod
	Water temperature	26 ± 1 °C
	Water quality	O ₂ ≥ 80 % saturation, hardness: e.g. ~30-300 mg/l CaCO ₃ , NO ₃ ⁻ : ≤ 48mg/l, NH ₄ ⁺ and NO ₂ ⁻ : < 0,001 mg/l, residual chlorine < 10 µg/l, total organic chlorine < 25 ng/l, pH = 6,5 – 8,5
	Further water quality criteria	Particulate matter < 20 mg/l, total organic carbon < 2 mg/l, total organophosphorus pesticides < 50 ng/l, total organochlorine pesticides plus polychlorinated biphenyls < 50 ng/l
	Tank size for maintenance	e.g. 180 l, 1 fish/l
	Water purification	Permanent (charcoal filtered); other possibilities include combinations with semi-static renewal maintenance or flow-through system with continuous water renewal
	Recommended male to female ratio for breeding	2:1 (or mass spawning)
Spawning tanks	e.g. 4 l tanks equipped with steel grid bottom and plant dummy as spawning stimulant; external heating mats, or mass spawning within the maintenance tanks	
Egg structure and appearance	Stable chorion (<i>i.e.</i> highly transparent, non-sticky, diameter ~ 0,8–1,5 mm)	
Spawning rate	A single mature female spawns at least 50-80 eggs per day. Depending on the strain, spawning rates may be considerably higher. The fertilisation rate should be ≥ 70 %. For first time spawning fish, fertilisation rates of the eggs may be lower in the first few spawns.	
Test type	Static, semi-static renewal, flow-through, 26 ± 1 °C, 24 hrs conditioned test chambers (e.g. 24-well plates 2,5-5 ml per cavity)	

▼ M7

Appendix 3

NORMAL ZEBRAFISH DEVELOPMENT AT 26 °C

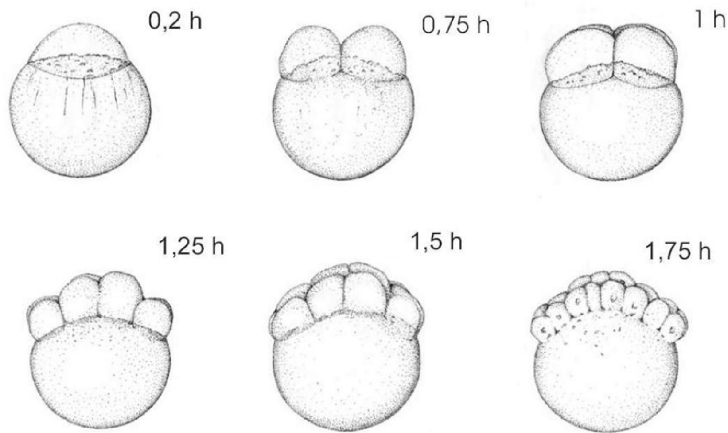

Fig. 1: Selected stages of early zebrafish (*Danio rerio*) development: 0,2 – 1,75 hrs post-fertilisation (from Kimmel *et al.*, 1995 (35)). The time sequence of normal development may be taken to diagnose both fertilisation and viability of eggs (see paragraph 26: Selection of fertilised eggs).

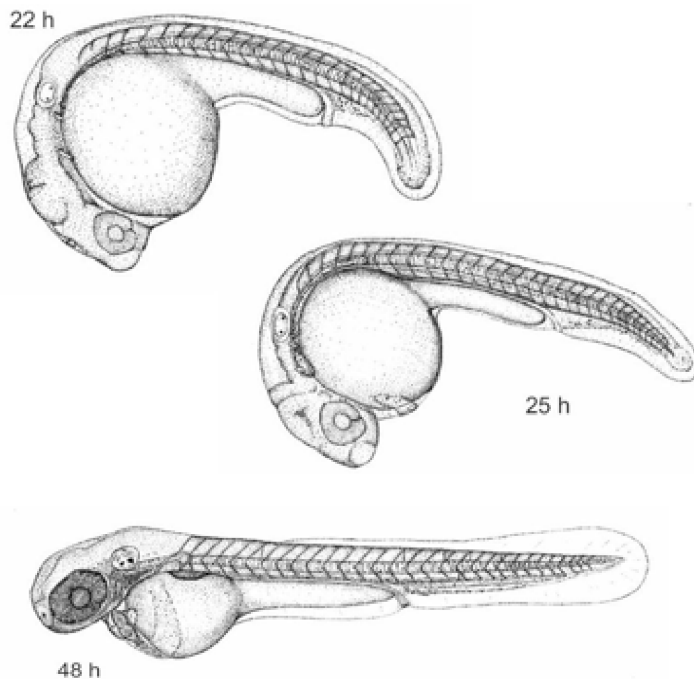

Fig. 2: Selected stages of late zebrafish (*Danio rerio*) development (de-chorionated embryo to optimise visibility): 22 – 48 hrs after fertilisation (from Kimmel *et al.*, 1995 (35)).

▼ M7

Fig. 3: Normal development of zebrafish (*Danio rerio*) embryos: (1) 0,75 hrs, 2-cell stage; (2) 1 hr, 4-cell stage; (3) 1,2 hrs, 8-cell stage; (4) 1,5 hrs, 16-cell stage; (5) 4,7 hrs, beginning epiboly; (6) 5,3 hrs, approx. 50 % epiboly (from Braunbeck & Lammer 2006 (40)).

▼ M7

Appendix 4

Figure 1

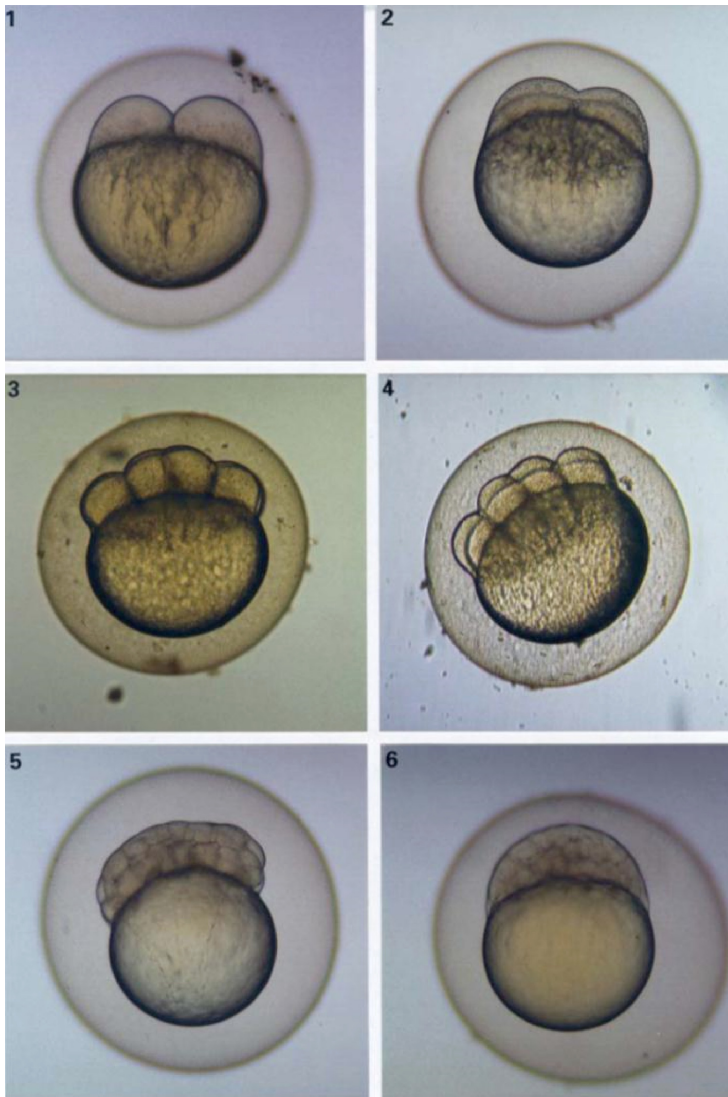
Layout of 24-well plates

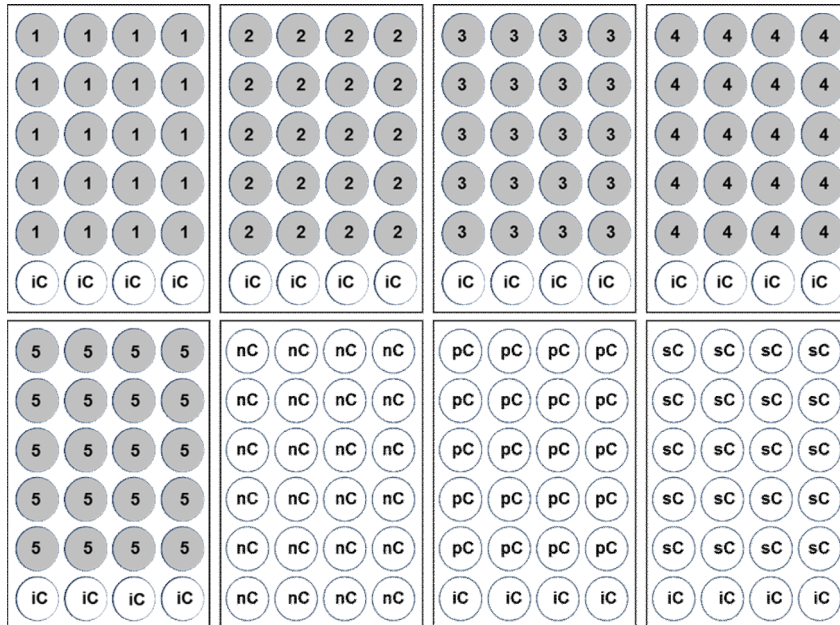

1-5 = five test concentrations/chemical;

nC = negative control (dilution water);

iC = internal plate control (dilution water);

pC = positive control (3,4-DCA 4 mg/l);

sC = solvent control.

▼ M7

Figure 2

Scheme of the zebrafish embryo acute toxicity test procedure (from left to right): production of eggs, collection of the eggs, pre-exposure immediately after fertilisation in glass vessels, selection of fertilised eggs with an inverted microscope or binocular and distribution of fertilised eggs into 24-well plates prepared with the respective test concentrations/controls, n = number of eggs required per test concentration/control (here 20), hpf = hours post-fertilisation.

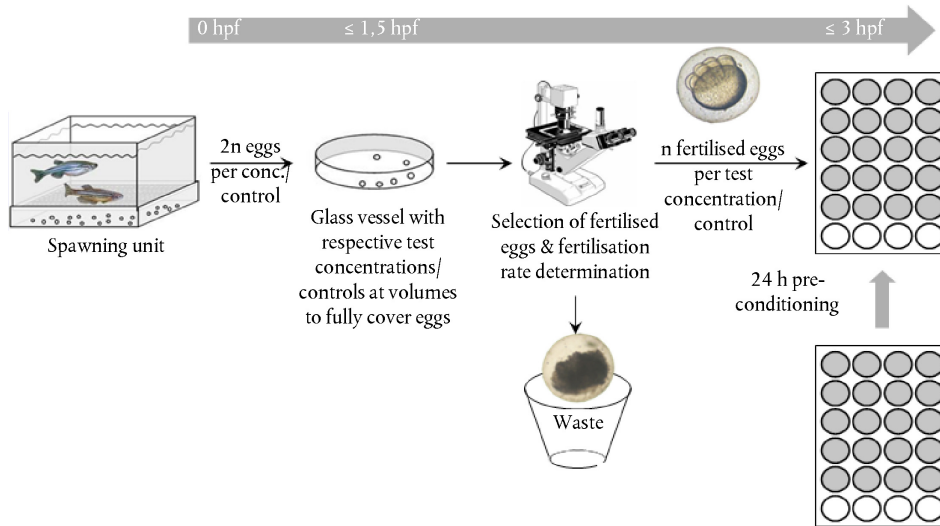

▼ M7

Appendix 5

**ATLAS OF LETHAL ENDPOINTS FOR THE ZEBRAFISH EMBRYO
ACUTE TOXICITY TEST**

The following apical endpoints indicate acute toxicity and, consequently, death of the embryos: *coagulation of the embryo*, *non-detachment of the tail*, *lack of somite formation* and *lack of heartbeat*. The following micrographs have been selected to illustrate these endpoints.

Figure 1

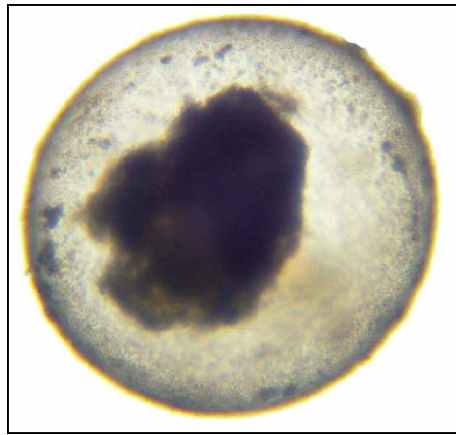
Coagulation of the embryo:

Under bright field illumination, coagulated zebrafish embryos show a variety of intransparent inclusions.

Figure 2

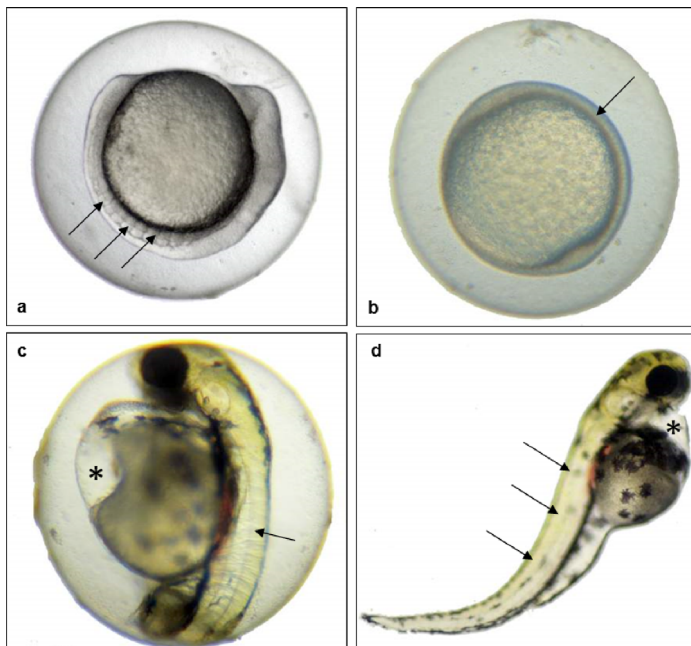
Lack of somite formation:

▼ **M7**

Although retarded in development by approx. 10 hrs, the 24 hrs old zebrafish embryo in (a) shows well-developed somites (→), whereas the embryo in (b) does not show any sign of somite formation (→). Although showing a pronounced yolk sac oedema (*), the 48 hrs old zebrafish embryo in (c) shows distinct formation of somites (→), whereas the 96 hrs old zebrafish embryo depicted in (d) does not show any sign of somite formation (→). Note also the spinal curvature (scoliosis) and the pericardial oedema (*) in the embryo shown in (d).

Figure 3

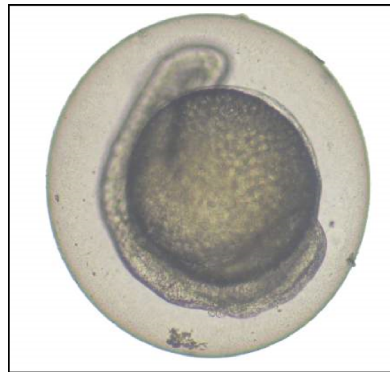
Non-detachment of the tail

Bud in lateral view (a: →; 96 hrs old zebrafish embryo). Note also the lack of the eye bud (*).

Figure 4

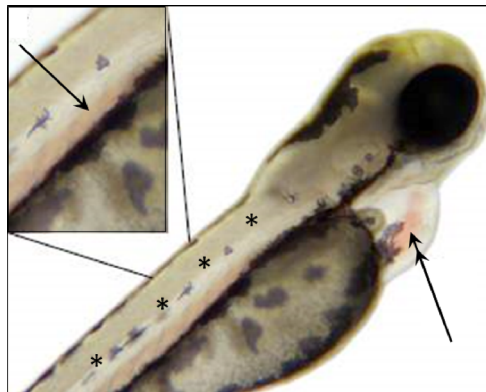
Lack of heartbeat

Lack of heartbeat is, by definition, difficult to illustrate in a micrograph. Lack of heartbeat is indicated by non-convulsion of the heart (double arrow). Immobility of blood cells in, e.g. the aorta abdominalis (→ in insert) is not an indicator for lack of heartbeat. Note also the lack of somite formation in this embryo (*, homogenous rather than segmental appearance of muscular tissues). The observation time to record an absence of heartbeat should be at least of one minute with a minimum magnification of 80×.

▼ M7C.50. **SEDIMENT-FREE *MYRIOPHYLLUM SPICATUM* TOXICITY TEST**

INTRODUCTION

1. This test method is equivalent to OECD test guideline 238 (2014). It is designed to assess the toxicity of chemicals to *Myriophyllum spicatum*, a submersed aquatic dicotyledon, a species of the water milfoils family. It is based on an ASTM existing test method (1) modified as a sediment-free test system (2) to estimate the intrinsic ecotoxicity of test chemicals (independent of the distribution-behaviour of the test chemical between water and sediment). A test system without sediment has a low analytical complexity (only in the water phase) and the results can be analysed in parallel and/or comparison with those obtained in *Lemna sp.* test (3); in addition, the required sterile conditions allow to keep the effects of microorganisms and algae (chemical uptake/ degradation, etc.) as low as possible. This test does not replace other aquatic toxicity tests; it should rather complement them so that a more complete aquatic plant hazard and risk assessment is possible. The test method has been validated by a ring-test (4).
2. Details of testing with renewal (semi-static) and without renewal (static) of the test solution are described. Depending on the objectives of the test and the regulatory requirements, the use of semi-static method is recommended, e.g. for substances that are rapidly lost from solution as a result of volatilisation, adsorption, photodegradation, hydrolysis, precipitation or biodegradation. Further guidance is given in (5). This test method applies to substances, for which the test method has been validated, (see details in the ring-test report (4)) or to formulations, or known mixtures; if a mixture is tested, its constituents should be as far as possible identified and quantified. The sediment-free *Myriophyllum spicatum* test method complements the water-sediment *Myriophyllum spicatum* Toxicity Test (6). Before use of the test method for the testing of a mixture intended for a regulatory purpose, it should be considered whether, and if so why, it may provide adequate results for that purpose. Such considerations are not needed, when there is a regulatory requirement for testing of the mixture.

PRINCIPLE OF THE TEST

3. Continuously growing plant cultures of *Myriophyllum spicatum* (only in modified Andrews' medium, see Appendix 2) are allowed to grow as monocultures in different concentrations of the test chemical over a period of 14 days in a sediment-free test system. The objective of the test is to quantify chemical-related effects on vegetative growth over this period based on assessments of selected measurement variables. Growth of shoot length, of lateral branches and roots as well as development of fresh and dry weight and increase of whorls are the measurement variables. In addition, account is taken of distinctive qualitative changes in test organisms, such as disfigurement or chlorosis and necrosis indicated by yellowing or white and brown colouring. To quantify chemical-related effects, growth in the test solutions is compared with that of the controls and the concentration bringing about a specified x % inhibition of growth is determined and expressed as the EC_x; 'x' can be any value depending on the regulatory requirements, e.g. EC₁₀, EC₂₀, EC₅₀. It should be noted that estimates of EC₁₀ and EC₂₀ values are only reliable and appropriate in tests where coefficients of variation in control plants fall below the effect level being estimated, i.e. coefficients of variation should be < 20 % for robust estimation of an EC₂₀.
4. Both average specific growth rate (estimated from assessments of main shoot length and three additional measurement variables) and yield (estimated from the increase in main shoot length and three additional measurement variables) of untreated and treated plants should be determined. Specific growth

▼ M7

rate (r) and yield (y) are subsequently used to determine the E_rC_x (e.g. E_rC_{10} , E_rC_{20} , E_rC_{50}) and E_yC_x (e.g. E_yC_{10} , E_yC_{20} , E_yC_{50}), respectively.

5. In addition, the lowest observed effect concentration (LOEC) and the no observed effect concentration (NOEC) may be statistically determined.

INFORMATION ON THE TEST CHEMICAL

6. An analytical method, with adequate sensitivity for quantification of the test chemical in the test medium, should be available. Information on the test chemical which may be useful in establishing the test conditions includes the structural formula, purity and impurities, water solubility, stability in water and light, acid dissociation constant (pK_a), partition coefficient octanol-water (K_{ow}), vapour pressure and biodegradability. Water solubility and vapour pressure can be used to calculate Henry's Law constant, which will indicate if significant losses of the test chemical during the test period are likely. This will help indicate whether particular steps to control such losses should be taken. Where information on the solubility and stability of the test chemical are uncertain, it is recommended that these be assessed under the conditions of the test, *i.e.* growth medium, temperature, lighting regime to be used in the test.
7. The pH control of the test medium is particularly important, e.g. when testing metals or substances which are hydrolytically unstable. Further guidance for testing chemicals with physical-chemical properties that make them difficult to test is provided in a OECD Guidance Document (5).

VALIDITY OF THE TEST

8. For the test to be valid, the doubling time of main shoot length in the control must be less than 14 days. Using the media and test conditions described in this test method, this criterion can be attained using a static or semi-static test regime.
9. The mean coefficient of variation for yield based on measurements of shoot fresh weight (*i.e.* from test initiation to test termination) and the additional measurement variables (see paragraph 37) in the control cultures do not exceed 35 % between replicates.
10. More than 50 % of the replicates of the control group are kept sterile over the exposure period of 14 days, which means visibly free of contamination by other organisms such as algae, fungi and bacteria (clear solution). *Note:* Guidance on how to assess sterility is provided in the ring-test report (4).

REFERENCE CHEMICAL

11. Reference chemical(s), such as 3,5-dichlorophenol used in the ring test (4), may be tested as a mean of checking the test procedure; from the ring test data, the mean EC_{50} -values of 3,5-DCP for the different response variables (see paragraphs 37-41 of this test method) are between 3,2 mg/l and 6,9 mg/l (see ring test report for details about confidence interval for these values). It is advisable to test a reference chemical at least twice a year or, where testing is carried out at a lower frequency, in parallel to the determination of the toxicity of a test chemical.

▼ **M7****DESCRIPTION OF THE METHOD****Apparatus**

12. All equipment in contact with the test media should be made of glass or other chemically inert material. Glassware used for culturing and testing purposes should be cleaned of chemical contaminants that might leach into the test medium and should be sterile. The test vessels should be long enough for the shoot in the control vessels to grow in the water phase without reaching the surface of the test medium at the end of the test. Thick-walled borosilicate glass test tubes without lip, inner diameter approximately 20 mm, length approximately 250 mm, with aluminium caps are recommended.
13. Since the modified Andrews' medium contains sucrose (which stimulates the growth of fungi and bacteria), the test solutions have to be prepared under sterile conditions. All liquids as well as equipment are sterilised before use. Sterilisation is carried out via heated air treatment (210 °C) for 4 hours or autoclaving for 20 minutes at 121 °C. In addition, all flasks, dishes, bowls etc. and other equipment undergo flame treatment at a sterile workbench just prior to use.
14. The cultures and test vessels should not be kept together. This is best achieved using separate environmental growth chambers, incubators, or rooms. Illumination and temperature should be controllable and maintained at a constant level.

Test organism

15. *Myriophyllum spicatum* — a submersed aquatic dicotyledon — is a species of the water milfoils family. Between June and August, inconspicuous pink-white flowers protrude above the water surface. The plants are rooted in the ground by a system of robust rhizomes and can be found in the entire northern hemisphere in eutrophic, however non-polluted and more calciferous still waters with muddy substrate. *Myriophyllum spicatum* prefers fresh water, but is found in brackish water as well.
16. For the sediment-free toxicity test, sterile plants are required. If the testing laboratory does not have regular cultures of *Myriophyllum spicatum*, sterile plant material may be obtained from another laboratory or (unsterile) plant material might be taken from the field or provided by a commercial supplier; if plants come from the field a taxonomic verification of the species should be envisaged. If collected from the field or provided by a commercial supplier, plants should be sterilised (1) and maintained in culture in the same medium as used for testing for a minimum of eight weeks prior to use. Field sites used for collecting starting cultures have to be free of obvious sources of contamination. Great care should be taken to ensure that the correct species is obtained when collecting *Myriophyllum spicatum* from the field, especially in regions where it can hybridise with other *Myriophyllum* species. If obtained from another laboratory they should be similarly maintained for a minimum of three weeks. The source of plant material and the species used for testing should always be reported.
17. The quality and uniformity of the plants used for the test will have a significant influence on the outcome of the test and should therefore be selected with care. Young, rapidly growing plants without visible lesions or discoloration (chlorosis) should be used. Details about preparation of the test organism are given in Appendix 4.

Cultivation

18. To reduce the frequency of culture maintenance (e.g. when no *Myriophyllum* tests are planned for a period), cultures can be held under reduced illumination and temperature ($50 \mu\text{E m}^{-2} \text{s}^{-1}$, $20 \pm 2 \text{ }^\circ\text{C}$). Details of culturing are given in Appendix 3.

▼ M7

19. At least 14 to 21 days before testing, sufficient test organisms are transferred aseptically into fresh sterile medium and cultured for 14 to 21 days under the conditions of the test as a pre culture. Details for preparation of a pre-culture are given in Appendix 4.

Test medium

20. Only one nutrient medium is recommended for *Myriophyllum spicatum* in a sediment-free test system, as described in Appendix 2. A modification of the Andrews' medium is recommended for culturing and testing with *Myriophyllum spicatum* as described in (1). From five separately prepared nutrient stock solutions with addition of 3 % sucrose the modified Andrews' medium will be arranged. Details about preparation of the medium are given in Appendix 2.
21. A tenfold concentrated, modified Andrews' medium is needed for obtaining the test solutions (by dilution as appropriate). The composition of this medium is given in Appendix 2.

Test solutions

22. Test solutions are usually prepared by dilution of a stock solution. Stock solutions of the test chemical are normally prepared by dissolving the chemical in demineralised (*i.e.* distilled or deionised) water. The addition of the nutrients will be achieved by using the tenfold concentrated, modified Andrews' medium.
23. The stock solutions of the test chemical can be sterilised by autoclave at 121 °C for 20 minutes or by sterile filtration, provided that the sterilisation technique used does not denaturise the test chemical. Test solutions can also be prepared in sterile demineralised water or medium, under sterile conditions. The thermo-stability and the adsorption on different surfaces should be taken into account in the selection of the sterilisation procedure of the stock solutions of the test chemical. Because of that, it is recommended that the stock solutions be prepared under sterile conditions, *i.e.* using sterile material for dissolving the test chemical under sterile conditions (e.g. flame sterilisation, laminar-flow hoods, etc.) into sterile water. This technique of preparation of sterile stock solutions is valid for both substances and mixtures.
24. The highest tested concentration of the test chemical should normally not exceed its water solubility under the test conditions. For test chemicals of low water solubility it may be necessary to prepare a concentrated stock solution or dispersion of the chemical using an organic solvent or dispersant in order to facilitate the addition of accurate quantities of the test chemical to the test medium and aid in its dispersion and dissolution. Every effort should be made to avoid the use of such materials. There should be no phytotoxicity resulting from the use of auxiliary solvents or dispersants. For example, commonly used solvents which do not cause phytotoxicity at concentrations up to 100 µl/l, include acetone and dimethylformamide. If a solvent or dispersant is used, its final concentration should be reported and kept to a minimum (≤ 100 µl/l), and all treatments and controls should contain the same concentration of solvent or dispersant. Further guidance on the use of dispersants is given in (5).

Test and control groups

25. Prior knowledge of the toxicity of the test chemical to *Myriophyllum spicatum* from a range-finding test will help in selecting suitable test concentrations. In the

▼ **M7**

definitive toxicity test, there should normally be five (like in the *Lemna* growth inhibition test, Chapter C.26 of this Annex) to seven test concentrations arranged in a geometric series; they should be chosen in order that the NOEC and EC₅₀ values are bracketed by the concentration range (see below). Preferably the separation factor between test concentrations should not exceed 3,2; however, a larger value may be used where the concentration-response curve is flat. Justification should be provided when fewer than five concentrations are used. At least five replicates should be used at each test concentration.

26. In setting the range of test concentrations (for range-finding and/or for the definitive toxicity test), the following should be considered:

To determine an EC_x, test concentrations should bracket the EC_x value to ensure an appropriate level of confidence. For example, if estimating the EC₅₀, the highest test concentration should be greater than the EC₅₀ value. If the EC₅₀ value lies outside of the range of test concentrations, associated confidence intervals will be large and a proper assessment of the statistical fit of the model may not be possible.

If the aim is to estimate the LOEC/NOEC, the lowest test concentration should be low enough so that growth is not significantly less than that of the control. In addition, the highest test concentration should be high enough so that growth is significantly lower than that in the control. If this is not the case, the test will have to be repeated using a different concentration range (unless the highest concentration is at the limit of solubility or the maximum required limit concentration, e.g. 100 mg/l).

27. Every test should include controls consisting of the same nutrient medium, test organism (choosing plant material as homogeneous as possible, fresh lateral branches from pre-cultures, shortened to 2,5 cm from base), environmental conditions and procedures as the test vessels but without the test chemical. If an auxiliary solvent or dispersant is used, an additional control treatment with the solvent/dispersant present at the same concentration as that in the vessels with the test chemical should be included. The number of replicate control vessels (and solvent vessels, if applicable) should be at least ten.
28. If determination of NOEC is not required, the test design may be altered to increase the number of concentrations and reduce the number of replicates per concentration. However, in any case the number of control replicates should be at least ten.

Exposure

29. Fresh lateral branches from pre-culture shortened to 2,5 cm from base are assigned randomly to the test vessels under aseptic conditions; each test vessel should contain one 2,5 cm lateral branch that should have an apical meristem on one end. The chosen plant material should be the same quality in each test vessel.
30. A randomised design for location of the test vessels in the incubator is required to minimise the influence of spatial differences in light intensity or temperature. A blocked design or random repositioning of the vessels (or repositioning more frequently) when observations are made is also required.
31. If a preliminary stability test shows that the test chemical concentration cannot be maintained (*i.e.* the measured concentration falls below 80 % of the measured initial concentration) over the test duration (14 days), a semi-static test regime is recommended. In this case, the plants should be exposed to freshly prepared test and control solutions on at least one occasion during

▼ M7

the test (e.g. day 7). The frequency of exposure to fresh medium will depend on the stability of the test chemical; a higher frequency may be needed to maintain near-constant concentrations of highly unstable or volatile chemicals.

32. The exposure scenario through a foliar application (spray) is not covered in this test method.

Test conditions

33. Warm and/or cool white fluorescent lighting should be used to provide light irradiance in the range of about of $100\text{--}150 \mu\text{E m}^{-2} \text{s}^{-1}$ when measured as a photosynthetically active radiation (400-700 nm) at points the same distance from the light source as the bottom of the test vessels (equivalent ca. 6 000 to 9 000 lux) and using a light-dark cycle of 16:8 h. The method of light detection and measurement, in particular the type of sensor, will affect the measured value. Spherical sensors (which respond to light from all angles above and below the plane of measurement) and 'cosine' sensors (which respond to light from all angles above the plane of measurement) are preferred to unidirectional sensors, and will give higher readings for a multi-point light source of the type described here.
34. The temperature in the test vessels should be $23 \pm 2 \text{ }^\circ\text{C}$. Additional care is needed on pH drift in special cases such as when testing unstable chemicals or metals; the pH should remain in a range of 6-9. See (5) for further guidance.

Duration

35. The test is terminated 14 days after the plants are transferred into the test vessels.

Measurements and analytical determinations

36. At the start of the test, the main shoot length of test organism is 2,5 cm (see paragraph 29); it is measured with a ruler (see Appendix 4) or by photography and image analysis. The main shoot length of test organism appearing normal or abnormal needs to be determined at the beginning of the test, at least once during the 14-day exposure period and at test termination. Note: As an alternative for those who do not have image analysis, if the workbench is sterilised prior to addition of plants to test vessels, a sterile ruler can also be used to measure the length of the main shoot at test initiation and during the test. Changes in plant development, e.g. in deformation in the shoots, appearance, indication of necrosis, chlorosis, break-up or loss of buoyancy and in root length and appearance, should be noted. Significant features of the test medium (e.g. presence of undissolved material, growth of algae, fungi and bacteria in the test vessel) should also be noted.
37. In addition to determinations of main shoot length during the test, effects of the test chemical on three (or more) of the following measurement variables should be also assessed:
- (i) Total lateral branches length
 - (ii) Total shoot length
 - (iii) Total root length
 - (iv) Fresh weight
 - (v) Dry weight
 - (vi) Number of whorls

▼ M7

- Note 1:* The observations made during the range-finding test could help in selecting relevant additional measurements among the six variables listed above.
- Note 2:* The determination of the fresh and dry weights (parameters iv and v) is highly desirable.
- Note 3:* Due to the fact that sucrose and light (exposure of roots to light during the test) may have an influence on auxin (plant growth hormone) transport carriers, and that some chemicals may have an auxin-type mode of action, the inclusion of root endpoints (parameter iii) is questionable.
- Note 4:* The ring test results show high coefficients of variation (> 60 %) for the total lateral branch length (parameter i). Total lateral branch length is in any case encompassed within the total shoot length measurement (parameter ii) which shows more acceptable coefficients of variation of < 30 %.
- Note 5:* Resulting from the above considerations, the recommended main measurement endpoints are: total shoot length, fresh weight and dry weight (parameters ii, iv and v); parameter vi — number of whorls — is left to the experimenter's judgment.
38. Main shoot length and number of whorls have an advantage, in that they can be determined for each test and control vessel at the start, during, and at the end of the test by photography and image analysis, although a (sterile) ruler can also be used.
39. Total lateral branches length, total root length (as a sum of all lateral branches or roots) and total shoot length (as a sum of main shoot length and total lateral branches length) can be measured with a ruler at the end of exposure.
40. The fresh and/or dry weight should be determined at the start of the test from a sample of the pre-culture representative of what is used to begin the test, and at the end of the test with the plant material from each test and control vessel.
41. Total lateral branches length, total shoot length, total root length, fresh weight, dry weight and number of whorls may be determined as follows:
- (i) Total lateral branches length: The lateral branch length may be determined by measuring all lateral branches with a ruler at the end of exposure. The total lateral branches length is the sum of all lateral branches of each test and control vessel.
 - (ii) Total shoot length: The main shoot length may be determined by image analysis or using a ruler. The total shoot length is the sum of the total lateral branches length and the main shoot length of each test and control vessel at the end of exposure.
 - (iii) Total root length: The root length may be determined by measuring all roots with a ruler at the end of exposure. The total root length is the sum of all roots of each test and control vessel.
 - (iv) Fresh weight: The fresh weight may be determined by weighing the test organisms at the end of exposure. All plant material of each test and

▼ M7

control vessel will be rinsed with distilled water, dabbed dry with cellulose paper. After this preparation the fresh weight will be determined by weighing. The starting biomass (fresh weight) is determined on the basis of a sample of test organisms taken from the same batch used to inoculate the test vessels.

(v) Dry weight: After the preparations for the determination of the fresh weight the test organisms will be dried at 60 °C to a constant weight. This mass is the dry weight. The starting biomass (dry weight) is determined on the basis of a sample of test organisms taken from the same batch used to inoculate the test vessels.

(vi) Number of whorls: All whorls will be counted out along the main shoot.

Frequency of measurement and analytical determinations

42. If a static test design is used, the pH of each treatment should be measured at the beginning and at the end of the test. If a semi-static test design is used, the pH should be measured in each batch of 'fresh' test solution prior to each renewal and also in the corresponding 'spent' solutions.
43. Light intensity should be measured in the growth chamber, incubator or room at points in the same distance from the light source as the test organisms. Measurements should be made at least once during the test. The temperature of the medium in a surrogate vessel held under the same conditions in the growth chamber, incubator or room should be recorded at least daily (or continuously with a data logger).
44. During the test, the concentrations of the test chemical(s) are determined at appropriate intervals. In static tests, the minimum requirement is to determine the concentrations at the beginning and at the end of the test.
45. In semi-static tests where the concentrations of the test chemical(s) are not expected to remain within $\pm 20\%$ of the nominal concentration, it is necessary to analyse all freshly prepared test solutions and the same solutions at each renewal. However, for those tests where the measured initial concentrations of the test chemical(s) are not within $\pm 20\%$ of nominal but where sufficient evidence can be provided to show that the initial concentrations are repeatable and stable (*i.e.* within the range 80 - 120 % of the initial concentration), chemical determinations may be carried out on only the highest and lowest test concentrations. In all cases, determination of test concentrations prior to renewal need only be performed on one replicate vessel at each test concentration (or the contents of the vessels pooled by replicate).
46. If there is evidence that the test concentration has been satisfactorily maintained within $\pm 20\%$ of the nominal or measured initial concentration throughout the test, analysis of the results can be based on nominal or measured initial values. If the deviation from the nominal or measured initial concentration is not within $\pm 20\%$, analysis of the results should be based on the geometric mean concentration during exposure or models describing the decline of the concentration of the test chemical (5).

Limit test

47. Under some circumstances, e.g. when a preliminary test indicates that the test chemical has no toxic effects at concentrations up to 100 mg/l or up to its limit of solubility in the test medium or in case of a formulation up to its limit of dispersibility, a limit test involving a comparison of responses in a control group and one treatment group (100 mg/l or a concentration equal to the limit of solubility), may be undertaken. It is strongly recommended that

▼ M7

this is supported by analysis of the exposure concentration. All previously described test conditions and validity criteria apply to a limit test, with the exception that the number of treatment replicates should be doubled. Growth in the control and treatment group may be analysed using a statistical test to compare means, e.g. a Student's t-test.

DATA AND REPORTING

Response variables

48. The purpose of the test is to determine the effects of a test chemical on the vegetative growth of *Myriophyllum spicatum*. This test method describes two response variables.
- (a) **Average specific growth rate:** This response variable is calculated on the basis of changes in the logarithms of main shoot length, and in addition, on the basis of changes in the logarithms of other measurement parameters, *i.e.* total shoot length, fresh weight, dry weight or number of whorls over time (expressed per day) in the controls and each treatment group. **Note:** For the measurement parameter total lateral branches length and total root length a calculation of the average specific growth rate is not possible. At the beginning of the test, the test organism has no lateral branches and no roots (based on the preparation from the pre-culture); starting from the value zero, the calculation of the average specific growth rate is not defined.
- (b) **Yield:** This response variable is calculated on the basis of changes in main shoot length, and in addition, on the basis of changes in other measurement parameters — *i.e.* preferably total shoot length, fresh weight, dry weight or number of whorls, and other parameters if deemed useful — in the controls and in each treatment group until the end of the test.
49. Toxicity estimates should be based on main shoot length and three additional measurement variables (*i.e.* preferably total shoot length, fresh weight, dry weight or number of whorls, see paragraph 37 and Notes 2, 4 and 5 to this paragraph), because some chemicals may affect other measurement variables much more than the main shoot length. This effect would not be detected by calculating main shoot length only.

Average specific growth rate

50. The average specific growth rate for a specific period is calculated as the logarithmic increase in the growth variables — main shoot length and three additional measurement variables (*i.e.* total shoot length, fresh weight, dry weight or number of whorls) — using the formula below for each replicate of control and treatments:

$$\mu_{i-j} = \frac{\ln(N_j) - \ln(N_i)}{t}$$

where:

μ_{i-j} : average specific growth rate from time i to j

N_i : measurement variable in the test or control vessel at time i

N_j : measurement variable in the test or control vessel at time j

t: time period from i to j

▼ M7

For each treatment group and control group, calculate a mean value for growth rate along with variance estimates.

51. The average specific growth rate should be calculated for the entire test period (time 'i' in the above formula is the beginning of the test and time 'j' is the end of the test). For each test concentration and control, calculate a mean value for average specific growth rate along with the variance estimates. In addition, the section-by-section growth rate should be assessed in order to evaluate effects of the test chemical occurring during the exposure period (e.g. by inspecting log-transformed growth curves).
52. Percent inhibition of growth rate (I_r) may then be calculated for each test concentration (treatment group) according to the following formula:

$$\%I_r = \frac{(\mu_C - \mu_T)}{\mu_C} \times 100$$

where:

% I_r : percent inhibition in average specific growth rate

μ_C : mean value for μ in the control

μ_T : mean value for μ in the treatment group

Yield

53. Effects on yield are determined on the basis of the measurement variable main shoot length and three additional measurement variables (*i.e.* preferably total shoot length, fresh weight, dry weight or number of whorls) present in each test vessel at the start and at the end of the test. For fresh weight or dry weight, the starting biomass is determined on the basis of a sample of test organisms taken from the same batch used to inoculate the test vessels. For each test concentration and control, calculate a mean value for yield along with variance estimates. The mean percent inhibition in yield (% I_y) may be calculated for each treatment group as follows:

$$\%I_y = \frac{(b_c - b_T)}{b_c}$$

where:

% I_y : percent reduction in yield

b_C : final biomass minus starting biomass for the control group

b_T : final biomass minus starting biomass in the treatment group

Doubling time

54. To determine the doubling time (T_d) of main shoot length and adherence to this validity criterion (see paragraph 8), the following formula is used with data obtained from the control vessels:

$$T_d = \ln 2/\mu$$

Where μ is the average specific growth rate determined as described in paragraphs 50-52.

▼ **M7****Plotting concentration-response curves**

55. Concentration-response curves relating mean percentage inhibition of the response variable (I_r , or I_y calculated as shown in paragraph 53) and the log concentration of the test chemical should be plotted.

EC_x estimation

56. Estimates of the EC_x should be based upon both average specific growth rate (E_rC_x) and yield (E_yC_x), each of which should in turn be based upon main shoot length, and possibly additional measurement variables (*i.e.* preferably total shoot length, fresh weight, dry weight or number of whorls). This is because there are chemicals that impact main shoot length and other measurement variables differently. The desired toxicity parameters are therefore four EC_x values for each inhibition level x calculated: E_rC_x (main shoot length); E_rC_x (*i.e.* preferably total shoot length, fresh weight, dry weight, or number of whorls); E_yC_x (main shoot length); and E_yC_x (*i.e.* preferably total shoot length, fresh weight, dry weight or number of whorls).
57. It should be noted that EC_x values calculated using these two response variables are not comparable and this difference is recognised when using the results of the test. EC_x values based upon average specific growth rate (E_rC_x) will in most cases be higher than results based upon yield (E_yC_x) — if the test conditions of this test method are adhered to — due to the mathematical basis of the respective approaches. This difference should not be interpreted as a difference in sensitivity between the two response variables, simply the values are different mathematically.

Statistical procedures

58. The aim is to obtain a quantitative concentration-response relationship by regression analysis. It is possible to use a weighted linear regression after having performed a linearising transformation of the response data, for instance with probit or logit or Weibull models (7), but non-linear regression procedures are preferred techniques that better handle unavoidable data irregularities and deviations from smooth distributions. Approaching either zero or total inhibition such irregularities may be magnified by the transformation, interfering with the analysis (7). It should be noted that standard methods of analysis using probit, logit, or Weibull transforms are intended for use on quantal (*e.g.* mortality or survival) data, and should be modified to accommodate growth rate or yield data. Specific procedures for determination of EC_x values from continuous data can be found in (8) (9) (10).
59. For each response variable to be analysed, use the concentration-response relationship to calculate point estimates of EC_x values. When possible, the 95 % confidence limits for each estimate should be determined. Goodness of fit of the response data to the regression model should be assessed either graphically or statistically. Regression analysis should be performed using individual replicate responses, not treatment group means.
60. EC₅₀ estimates and confidence limits may also be obtained using linear interpolation with bootstrapping (10), if available regression models/methods are unsuitable for the data.
61. For estimation of the LOEC and hence the NOEC, it is necessary to compare treatment means using analysis of variance (ANOVA) techniques. The mean for each concentration is then compared with the control mean using an appropriate multiple comparison or trend test method. Dunnett's or Williams' test may be useful (12) (13) (14) (15) (16). It is necessary to assess whether the ANOVA assumption of homogeneity of variance holds. This assessment may be performed graphically or by a formal test (15). Suitable tests are Levene's or Bartlett's. Failure to meet the assumption of homogeneity of variances can sometimes be corrected by logarithmic transformation of the data. If heterogeneity of variance is extreme and cannot be corrected by

▼ M7

transformation, analysis by methods such as step-down Jonkheere trend tests should be considered. Additional guidance on determining the NOEC can be found in (10).

62. Recent scientific developments have led to a recommendation of abandoning the concept of NOEC and replacing it with regression based point estimates EC_x . An appropriate value for x has not been established for this *Myriophyllum* test. However, a range of 10 to 20 % appears to be appropriate (depending on the response variable chosen), and preferably both the EC_{10} and EC_{20} and their confidence limits should be reported.

Reporting

63. The test report includes the following:

Test chemical

Mono-constituent substance:

- physical appearance, water solubility, and additional relevant physico-chemical properties;
- chemical identification, such as IUPAC or CAS name, CAS number, SMILES or InChI code, structural formula, purity, chemical identity of impurities as appropriate and practically feasible, etc. (including the organic carbon content, if appropriate).

Multi-constituent substance, UVCBs or mixture:

- characterised as far as possible by chemical identity (see above), quantitative occurrence and relevant physicochemical properties of the constituents.

Test species

- Scientific name and source.

Test conditions

- Test procedure used (static or semi-static).
- Date of start of the test and its duration.
- Test medium.
- Description of the experimental design: test vessels and covers, solution volumes, main shoot length per test vessel at the beginning of the test.
- Test concentrations (nominal and measured as appropriate) and number of replicates per concentration.
- Methods of preparation of stock and test solutions including the use of any solvents or dispersants.
- Temperature during the test.
- Light source, light intensity and homogeneity.
- pH values of the test and control media.
- The method of analysis of test chemical with appropriate quality assessment data (validation studies, standard deviations or confidence limits of analyses).

▼ M7

- Methods for determination of main shoot length and other measurement variables, e.g. total lateral branches length, total shoot length, total root length, fresh weight, dry weight or number of whorls.
- State of the culture (sterile or non-sterile) of each test and control vessel at each observation.
- All deviations from this test method.

Results

- Raw data: main shoot length and other measurement variables in each test and control vessel at each observation and occasion of analysis.
- Means and standard deviations for each measurement variable.
- Growth curves for each measurement variable.
- Calculated response variables for each treatment replicate, with mean values and coefficient of variation for replicates.
- Graphical representation of the concentration/effect relationship.
- Estimates of toxic endpoints for response variables e.g. EC₅₀, EC₁₀, EC₂₀, and associated confidence intervals. If calculated, LOEC and/or NOEC and the statistical methods used for their determination.
- If ANOVA has been used, the size of the effect which can be detected (e.g. the least significant difference).
- Any stimulation of growth found in any treatment.
- Any visual signs of phytotoxicity as well as observations of test solutions.
- Discussion of the results, including any influence on the outcome of the test resulting from deviations from this test method.

LITERATURE:

- (1) ASTM Designation E 1913-04, Standard Guide for Conducting Static, Axenic, 14-Day Phytotoxicity Tests in Test Tubes with the Submersed Aquatic Macrophyte, *Myriophyllum sibiricum* Komarov.
- (2) Maletzki, D. et al. (2010), *Myriophyllum spicatum* als ökotoxikologischer Testorganismus: Methodenentwicklung eines sedimentfreien Testsystems und erste Ergebnisse mit 3,5-Dichlorphenol, *Umweltwiss Schadst Forsch*, No. 22, pp. 702–710.
- (3) Chapter C.26 of this Annex: *Lemna* sp. Growth Inhibition Test,
- (4) OECD (2014), '*Myriophyllum spicatum* Toxicity Test: Results of an inter-laboratory ring test using a sediment-free test system', OECD Environment, Health and Safety Publications (EHS), Series Testing and Assessment, No. 205, OECD Publishing, Paris.
- (5) OECD (2000), 'Guidance Document on Aquatic Toxicity Testing of Difficult Substances and Mixtures', OECD Environment, Health and Safety Publications (EHS), Series on Testing and Assessment, No. 23, OECD Publishing, Paris.
- (6) Chapter C.51 of this Annex: Water-Sediment *Myriophyllum spicatum* Toxicity Test

▼ **M7**

- (7) Christensen, E.R., N. Nyholm (1984), Ecotoxicological Assays with Algae: Weibull Dose-Response Curves, *Environmental Science & Technology*, Vol. 18/9, 713-718.
- (8) Nyholm, N. *et al.* (1992), Statistical treatment of data from microbial toxicity tests, *Environmental Toxicology and Chemistry*, Vol. 11/2, pp. 157-167.
- (9) Bruce, R.D., D.J. Versteeg (1992), A statistical procedure for modelling continuous toxicity data, *Environmental Toxicology and Chemistry*, Vol. 11/10, pp. 1485-1494.
- (10) OECD (2006), 'Current Approaches in the Statistical Analysis of Ecotoxicity Data: A Guidance to Application', OECD Environment, Health and Safety Publications (EHS), Series on Testing and Assessment, No. 54, OECD Publishing, Paris.
- (11) Norberg-King, T.J. (1988), An interpolation estimate for chronic toxicity: The ICp approach, National Effluent Toxicity Assessment Center Technical Report 05-88, US EPA, Duluth, MN.
- (12) Dunnett, C.W. (1955), A multiple comparisons procedure for comparing several treatments with a control, *Journal of the American Statistical Association*, Vol. 50/272, pp. 1096-1121.
- (13) Dunnett, C.W. (1964), New tables for multiple comparisons with a control, *Biometrics*, Vol. 20/3, pp. 482-491.
- (14) Williams, D.A. (1971), A test for differences between treatment means when several dose levels are compared with a zero dose control, *Biometrics*, Vol. 27/1, pp. 103-117.
- (15) Williams, D.A. (1972), The comparison of several dose levels with a zero dose control, *Biometrics*, Vol. 28/2, pp. 519-531.
- (16) Brain, P., R. Cousens (1989), An equation to describe dose-responses where there is stimulation of growth at low doses, *Weed Research*, Vol. 29/2, pp. 93-96.

▼ **M7***Appendix 1*

DEFINITIONS

Biomass is the fresh and/or dry weight of living matter present in a population. In this test the biomass is the sum of main shoot, all lateral branches and all roots.

Chemical is a substance or a mixture.

Chlorosis is the change of the color from green to yellowing of test organism especially of the whorls.

EC_x is the concentration of the test chemical dissolved in test medium that results in a x % (e.g. 50 %) reduction in growth of *Myriophyllum spicatum* within a stated exposure period (to be mentioned explicitly if deviating from full or normal test duration). To unambiguously denote an EC value deriving from growth rate or yield the symbol 'E_rC' is used for growth rate and 'E_yC' is used for yield, followed by the measurement variable used, e.g. E_rC (main shoot length).

Growth is an increase in the measurement variable, e.g. main shoot length, total lateral branches length, total shoot length, total root length, fresh weight, dry weight or number of whorls, over the test period.

Growth rate (average specific growth rate) is the logarithmic increase in the measurement variable during the exposure period. *Note:* Growth rate related response variables are independent of the duration of the test as long as the growth pattern of unexposed control organisms is exponential.

Lowest Observed Effect Concentration (LOEC) is the lowest tested concentration at which the chemical is observed to have a statistically significant reducing effect on growth (at $p < 0,05$) when compared with the control, within a given exposure time. However, all test concentrations above the LOEC should have a harmful effect equal to or greater than those observed at the LOEC. When these two conditions cannot be satisfied, a full explanation should be given for how the LOEC (and hence the NOEC) has been selected.

Measurement variables are any type of variables which are measured to express the test endpoint using one or more different response variables. In this test method main shoot length, total lateral branches length; total shoot length, total root length, fresh weight, dry weight and number of whorls are measurement variables.

Monoculture is a culture with one plant species.

Necrosis is dead (i.e. white or dark brown) tissue of the test organism.

No Observed Effect Concentration (NOEC) is the test concentration immediately below the LOEC.

Response variable is a variable for the estimation of toxicity derived from any measured variable describing biomass by different methods of calculation. For this test method growth rate and yield are response variables derived from measurement variables like main shoot length, total shoot length, fresh weight, dry weight, or number of whorls.

Semi-static (renewal) test is a test in which the test solution is periodically replaced at specific intervals during the test.

▼ M7

Static test is a test method without renewal of the test solution during the test.

Test chemical is any substance or mixture tested using this test method.

Test endpoint describes the general factor that will be changed relative to control by the test chemical as aim of the test. In this test method the test endpoint is inhibition of growth which may be expressed by different response variables which are based on one or more measurement variables.

Test medium is the complete synthetic growth medium on which test plants grow when exposed to the test chemical. The test chemical will normally be dissolved in the test medium.

UVCB is a substance of unknown or variable composition, complex reaction product or biological material

Yield is value of a measurement variable to express biomass at the end of the exposure period minus the measurement variable at the start of the exposure period. Note: When the growth pattern of unexposed organisms is exponential, yield-based response variables will decrease with the test duration.

▼ **M7***Appendix 2***MODIFIED ANDREWS' MEDIUM FOR STOCK CULTURE AND PRE-CULTURE**

From five separately prepared nutrient stock solutions the modified Andrews' medium required for stock culture and pre culture will be prepared, with addition of 3 % sucrose.

*Table 1***Composition of Andrews' nutrient solution: (ASTM Designation E 1913-04)**

Production of nutrient stock solutions			Production of nutrient solution
Stock solution	Chemical	Initial weight per 1 000 ml	ml per 5 l nutrient solution
1	KCl	74,6 mg	50
	KNO ₃	8,08 g	
	Ca(NO ₃) ₂ × 4 H ₂ O	18,88 g	
2	MgSO ₄ × 7 H ₂ O	9,86 g	50
3	See below stock solution 3.1		50
4	KH ₂ PO ₄	2,72 g	50
5	FeSO ₄ × 7 H ₂ O	0,278 g	50
	Na ₂ EDTA × 2 H ₂ O	0,372 g	

Stock solutions can be kept in a refrigerator for 6 months (at 5-10 °C). Only stock solution No. 5 has a reduced shelf life (two months).

*Table 2***Production of stock solution 3.1 for preparing stock solution 3**

Chemical	Initial weight g/100 ml
MnSO ₄ × 4 H ₂ O	0,223
ZnSO ₄ × 7 H ₂ O	0,115
H ₃ BO ₃	0,155
CuSO ₄ × 5 H ₂ O	0,0125
(NH ₄) ₆ Mo ₇ O ₂₄ × 4 H ₂ O	0,0037

After having produced stock solution 3.1 (Table 2), deep-freeze this solution in approximately 11 ml-aliquots (at – 18 °C at least). The deep-frozen portions have a shelf life of five years.

To produce stock solution 3, defrost stock solution 3.1, fill 10 ml of it into a 1 l volumetric flask and add ultra-pure water up to the flask's mark.

To obtain modified Andrews' medium, fill approximately 2 500 ml ultra-pure water into a 5 l volumetric flask. After adding 50 ml of each stock solution, fill 90 % of the volumetric flask with ultra-pure water and set pH to 5,8.

▼M7

After this, add 150 g dissolved sucrose (3 % per 5 l); then, fill the volumetric flask with ultra-pure water up to the mark. Finally, the nutrient solution is filled into 1 l Schott flasks and autoclaved at 121 °C for 20 minutes.

The nutrient solution thus yielded can be kept sterile in a refrigerator (at 5-10 °C) for three months.

Modified Andrews' medium for Sediment-free toxicity test

From the five nutrient stock solutions already mentioned in Tables 1 and 2, a tenfold concentrated, modified Andrews' medium required for obtaining the test solutions will be prepared, with addition of 30 % sucrose. To do so, fill approximately 100 ml ultra-pure water into a 1 l volumetric flask. After adding 100 ml of each of the stock solutions, set pH to 5,8. After this, add 30 % dissolved sucrose (300 g per 1 000 ml); then, fill the volumetric flask with ultra-pure water up to the mark.

Finally, the nutrient solution is filled into 0,5 l Schott flasks and autoclaved at 121 °C for 20 minutes.

The tenfold concentrated modified nutrient solution thus yielded can be kept sterile in a refrigerator (at 5-10 °C) for three months.

▼ M7

Appendix 3

MAINTENANCE OF STOCK CULTURE

In this Appendix 3 the stock culture of *Myriophyllum spicatum* L⁽¹⁾, a submersed aquatic dicotyledon, a species of the water milfoils family is described. Between June and August, inconspicuous pink-white flowers protrude above the water surface. The plants are rooted in the ground by a system of robust rhizomes and can be found in the entire northern hemisphere in eutrophic, however non-polluted and more calciferous still waters with muddy substrate. *Myriophyllum spicatum* prefers fresh water, but is found in brackish water as well.

For sediment-free stock culture under laboratory conditions, sterile plants are required. Sterile plants are available from the ecotoxicology laboratory of the German Umweltbundesamt (Federal Environment Agency of Germany).

Alternatively, test organisms can be prepared from non-sterile plants in accordance with ASTM designation E 1913-04. See below — extracted from the ASTM Standard Guide — the procedure for culturing *Myriophyllum sibiricum* collected from field:

‘If starting from field collected, non-sterile plants, collect *M. sibiricum* turions in the autumn. Place the turions into a 20-l aquarium containing 5 cm of sterile sediment that is covered with silica sand or for example by Turface® and 18 l of reagent water. Aerate the aquarium and maintain at a temperature of 15 °C and a fluence rate of 200 to 300 $\mu\text{mol m}^{-2} \text{s}^{-1}$ for 16 h per day. The plant culture in the aquarium may be maintained as a backup source of plants in case the sterile plant cultures are destroyed by mechanical malfunction in the growth cabinet, contamination, or other reason. The plants grown in the aquarium are not sterile and sterile cultures cannot be maintained in a batch culturing system. To sterilize the culture, plants are removed from the aquarium and rinsed under flowing deionized water for about 0,5 h. Under aseptic conditions in a laminar airflow cabinet, the plants are disinfected for less than 20 min (until most of the plant tissue is bleached and just the growing apex is still green) in a 3 % (w/v) sodium hypochlorite solution containing 0,01 % of a suitable surfactant. Agitate the disinfectant and plant material. Segments with several nodes are transferred into sterile culture tubes containing 45 ml of sterilized modified Andrews' medium and capped with plain culture tube closures. Only one plant segment is placed into each test chamber. Laboratory sealant film is used to secure the closure to the culture vessel. Once a sterile culture has been established, plant segments containing several nodes should be transferred to new test chambers containing fresh liquid nutrient media every ten to twelve days. As demonstrated by culturing on agar plates, the plants must be sterile and remain sterile for eight weeks before testing can be initiated.’

Since the modified Andrews' medium contains sucrose (which stimulates the growth of fungi and bacteria), all material, solutions and culturing be conducted under sterile conditions. All liquids as well as equipment are sterilised before use. Sterilisation is carried out via heated air treatment (210 °C) for 4 hours or autoclaving for 20 minutes at 121 °C. In addition, all flasks, dishes, bowls etc and other equipment undergo flame treatment at the sterile workbench just prior to use.

Stock cultures can be maintained under reduced illumination and temperature ($50 \mu\text{E m}^{-2} \text{s}^{-1}$, 20 ± 2 °C) for longer times without needing to be re-established.

⁽¹⁾ Carl von Linné (* May, 23th, 1707 in Råshult/Älmhult; † January, 10th, 1778 in Uppsala).

▼ **M7**

The *Myriophyllum* growth medium should be the same as that used for testing but other nutrient rich media can be used for stock cultures.

The plant segments are distributed axenically over several 500 ml Erlenmeyer or/and 2 000 ml Fernbach flasks, each filled with approximately 450 respectively 1 000 ml modified Andrews' medium. Then, the flasks are axenically cellulose plug stoppered.

In addition, thorough flame treatment of equipment at the sterile workbench just prior to use is absolutely necessary. Dependent on number and size, the plants are to be transferred into fresh nutrient solution approximately every three weeks.

Apices as well as segments of the stem middle part for this renewed culture can be used. Number and size of transferred plants (or segments of plants) are dependent on how many plants are needed. For example, you can transfer five shoot segments into one Fernbach flask and three shoot segments into one Erlenmeyer flask, each with a length of 5 cm. Discard any rooted, flowering, dead or otherwise conspicuous parts.

Figure 1

Cutting of plants for the stock and pre culture after 3 weeks of cultivation



Culturing of plants is to be performed in 500 ml Erlenmeyer and 2 000 ml Fernbach flasks in a cooling incubator at 20 ± 2 °C with continuously light at approximately $100\text{--}150 \mu\text{E m}^{-2} \text{s}^{-1}$ or 6 000-9 000 Lux (emitted by chamber illumination with colour temperature 'warm white light').

Figure 2

Culturing of plants in a cooling incubator with chamber illumination



Chemically clean (acid-washed) and sterile glass culture vessels should be used and aseptic handling techniques employed. In the event of contamination of the stock culture e.g. by algae, fungi and/or bacteria a new culture should be prepared or a stock culture from another laboratory should be used to renewal of the one culture.

▼ M7

Appendix 4

MAINTENANCE OF PRE-CULTURE AND PREPARATION OF TEST ORGANISM FOR TESTING

To obtain pre-culture, cut shoots of stock culture into segments with two whorls each; put segments into Fernbach flasks filled with modified Andrews' medium (with 3 % sucrose). Each flask can contain up to 50 shoot segments. However, care is to be taken that the segments are vital and do not have any roots and lateral branches or their buds (see figure 1 in Appendix 3).

The pre-culture organisms are cultured for 14 to 21 days under sterile conditions in an environmental chamber with alternating 16/8 hour light/dark phases. Light intensity selected from the range of $100\text{-}150 \mu\text{E m}^{-2} \text{s}^{-1}$. The temperature in the test vessels should be $23 \pm 2 \text{ }^\circ\text{C}$.

Since the modified Andrews' medium contains sucrose (which stimulates the growth of algae, fungi and bacteria), test chemical solutions should be prepared and culturing be conducted under sterile conditions. All liquids as well as equipment are sterilised before use. Sterilisation is carried out via heated air treatment ($210 \text{ }^\circ\text{C}$) for 4 hours or autoclaving for 20 minutes at $121 \text{ }^\circ\text{C}$. In addition, all flasks, dishes, bowls etc. and other equipment undergo flame treatment at the sterile workbench just prior to use.

Shoots are axenically removed from the pre-culture flasks, choosing material that is as homogeneous as possible. Each testing requires at least 60 test organisms (testing with eight test chemical concentrations). For testing, take fresh lateral branches from pre-cultures, shorten them to 2,5 cm from base (measured with ruler) and transfer them into a beaker containing sterile modified Andrews' medium. These fresh lateral branches can be used for the sediment-free *Myriophyllum spicatum* toxicity test.

Figure 2

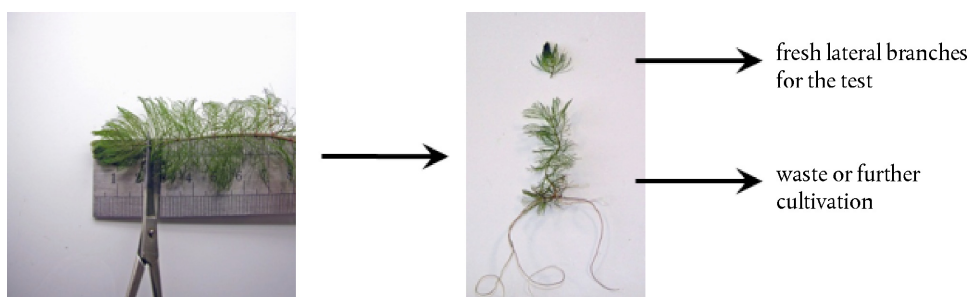
Cutting of plants from the pre culture for the sediment-free *Myriophyllum spicatum* toxicity test

▼ M7C.51. WATER-SEDIMENT *MYRIOPHYLLUM SPICATUM* TOXICITY TEST

INTRODUCTION

1. This test method is equivalent to the OECD test guideline 239 (2014). Test methods are available for the floating, monocotyledonous aquatic plant, *Lemna* species (1) and for algal species (2). These methods are routinely used to generate data to address the risk of test chemicals, in particular chemicals with herbicidal activity, to non-target aquatic plant species. However, in some cases, data for additional macrophyte species may be required. Recent guidance published from the Society of Environmental Toxicology and Chemistry (SETAC) workshop on Aquatic Macrophyte Risk Assessment for Pesticides (AMRAP) proposed that data for a rooted macrophyte species may be required for test chemicals where *Lemna* and algae are known not to be sensitive to the mode of action or if partitioning to sediment is a concern, leading to exposure via root uptake (3). Based on current understanding and experience, *Myriophyllum* spp were selected as the preferred species in cases where data are required for a submerged, rooted dicotyledonous species (4) (5) (6). This test does not replace other aquatic toxicity tests; it should rather complement them so that a more complete aquatic plant hazard and risk assessment is possible. The water-sediment *Myriophyllum spicatum* test method complements the sediment-free *Myriophyllum spicatum* Toxicity Test (7).
2. This document describes a test method, which allows assessment of the effects of a test chemical on the rooted, aquatic plant species *Myriophyllum spicatum*, growing in a water-sediment system. The test method is based partly on existing methods (1) (2) (8) and takes account of recent research related to the risk assessment of aquatic plants (3). The water-sediment method has been validated by an international ring-test conducted with *Myriophyllum* species grown under static conditions, which were exposed to the test chemical through applications made via the water column (9). However, the test system is readily adapted to allow for exposure via spiked sediment or exposure via the water phase in semi-static or pulsed-dose scenarios, although these scenarios have not been formally ring tested. Furthermore, the general method can be used for other rooted, submerged and emergent species including other *Myriophyllum* species (e.g. *Myriophyllum aquaticum*) and *Glyceria maxima* (10). Modifications of test conditions, design and duration may be required for alternative species. In particular, more work is needed to define appropriate procedures for *Myriophyllum aquaticum*. These options are not presented in detail in this test method, which describes the standard approach for exposure of *Myriophyllum spicatum* in a static system via the water phase.
3. This test method applies to substances, for which the test method has been validated, (see details in the ring test report (9)) or to formulations or known mixtures. A *Myriophyllum* test may be conducted to fulfil a Tier 1 data requirement triggered by potential test chemical partitioning to sediment or mode of action/selectivity issues. Equally, a laboratory-based *Myriophyllum* test may be required as part of a higher-tier strategy to address concerns over the risk to aquatic plants. The specific reason for conducting a test will determine the route of exposure (i.e. via water or sediment). Before use of this test method for the testing of a mixture intended for a regulatory purpose, it should be considered whether, and if so why, it may provide adequate results for that purpose. Such considerations are not needed, when there is a regulatory requirement for testing of the mixture.

▼M7

PRINCIPLE OF THE TEST

4. The test is designed to assess chemical-related effects on the vegetative growth of *Myriophyllum* plants growing in standardised media (water, sediment and nutrients). For this purpose, shoot apices of healthy, non-flowering plants are potted in standardised, artificial sediment, which is supplemented with additional nutrients to ensure adequate plant growth, and then maintained in Smart and Barko medium (Appendix 1). After an establishment period to allow for root formation, plants are exposed to a series of test concentrations added to the water column. Alternatively, exposure via the sediment may be simulated by spiking the artificial sediment with the test chemical and transplanting plants into this spiked sediment. In both cases, plants are subsequently maintained under controlled environmental conditions for 14 days. Effects on growth are determined from quantitative assessments of shoot length, fresh weight and dry weight, as well as qualitative observations of symptoms such as chlorosis, necrosis or growth deformities.
5. To quantify chemical-related effects, growth in the test solutions is compared with the growth of the control plants, and the concentration causing a specified x % inhibition of growth is determined and expressed as the EC_x; 'x' can be any value depending on the regulatory requirements, e.g. EC₁₀, EC₂₀ and EC₅₀. It should be noted that estimates of EC₁₀ and EC₂₀ values are only reliable and appropriate in tests where coefficients of variation in control plants fall below the effect level being estimated, i.e. coefficients of variation should be < 20 % for robust estimation of an EC₂₀.
6. Both average specific growth rate (estimated from assessments of shoot length, shoot fresh weight and shoot dry weight) and yield (estimated from the increase in shoot length, shoot fresh weight and shoot dry weight) of untreated and treated plants should be determined. Specific growth rate (r) and yield (y) are subsequently used to determine the E_rC_x (e.g. E_rC₁₀, E_rC₂₀, E_rC₅₀) and E_yC_x (e.g. E_yC₁₀, E_yC₂₀, E_yC₅₀), respectively.
7. If required, the lowest observed effect concentration (LOEC) and the no observed effect concentration (NOEC) may be statistically determined from estimates of average specific growth rates and yield.

INFORMATION ON THE TEST CHEMICAL

8. An analytical method with adequate sensitivity for quantification of the chemicals in the test medium should be available.
9. Information on the test chemical which may be useful in establishing the test conditions includes the structural formula, composition in the case of multi-constituent substances, UVCBs, mixtures or formulations, purity, water solubility, stability in water and light, acid dissociation constant (pK_a), partition coefficient octanol-water (K_{ow}), if available K_d to sediments, vapour pressure and biodegradability. Water solubility and vapour pressure can be used to calculate Henry's Law constant, which will indicate whether significant losses of the test chemical during the test period are likely. If losses of the test chemicals are likely, the losses should be quantified and the subsequent steps to control such losses should be documented. Where information on the solubility and stability of the test chemical(s) is uncertain, it is recommended that these properties are assessed under the conditions of the test, i.e. growth medium, temperature, lighting regime to be used in the test. *Note*: when light dependent peroxidising herbicides are tested, the laboratory lighting used should contain the equivalent presence of solar ultraviolet light found in natural sunlight.

▼ M7

10. The pH should be measured and adjusted in the test medium as appropriate. The pH control of the test medium is particularly important, e.g. when testing metals or chemicals which are hydrolytically unstable. Further guidance for testing chemicals with physical-chemical properties that make them difficult to test is provided in a OECD Guidance Document (11).

VALIDITY OF THE TEST

11. For the test results to be valid, the mean total shoot length and mean total shoot fresh weight in control plants at least double during the exposure phase of the test. In addition, control plants must not show any visual symptoms of chlorosis and should be visibly free from contamination by other organisms such as algae and/or bacterial films on the plants, at the surface of the sediment and in the test medium.
12. The mean coefficient of variation for yield based on measurements of shoot fresh weight (i.e. from test initiation to test termination) in the control cultures does not exceed 35 % between replicates.

REFERENCE CHEMICAL

13. A reference chemical(s), such as 3,5-dichlorophenol used in the ring test (9), should be periodically tested in order to check the performance of the test procedure over time. The ring test data indicate that the mean EC50 values of 3,5-DCP for the different response variables were between 4,7 and 6,1 mg/l (see the ring-test report for details of anticipated confidence interval around these values). It is advisable to test a reference chemical at least twice a year or, where testing is carried out infrequently, in parallel with the definitive toxicity tests. A guide to expected EC50 values for 3,5-DCP is provided in the Statistical Report of the International Ring-test (9).

DESCRIPTION OF THE METHOD

Test apparatus

14. The test should be conducted under controlled environmental conditions, i.e. in a growth chamber, growth room or laboratory, with controllable day length, lighting and temperature (see section 'Test conditions', paragraphs 56-58). Stock cultures should be maintained separately from test vessels.
15. The study should be conducted using glass test vessels such as aquaria or beakers; 2-l glass beakers (approximately 24 cm high and 11 cm in diameter) are commonly used. However, other (i.e. larger) vessels may be suitable provided that there is sufficient depth of water to allow unlimited growth and keep the plants submerged throughout the test duration.
16. Plastic or glass plant pots (approximately 9 cm diameter and 8 cm high and 500 ml volume) may be used as containers for potting the plants into the sediment. Alternatively, glass beakers may be used and are preferred in some cases (e.g. testing hydrophobic chemicals or chemicals with high K_{ow}).
17. The choice of pot/beaker size needs to be considered alongside the choice of test vessels and the preferred test design (see below). If using Test Design A (one shoot per pot with three pots per vessel) then smaller pots or larger vessels may be needed. If using Test Design B (three shoots per pot and one pot per vessel) then the stated pot and vessel sizes should be adequate. In all cases, the minimum overlaying water depth should be 12 cm above the top of the sediment and the ratio of sediment surface area/volume to water surface area/volume should be recorded.

▼ **M7****Test organism**

18. The general approaches described in this test method can be used to test a range of aquatic plant species. However, the conditions outlined in this test method have been tailored for testing the water milfoil species, *Myriophyllum spicatum*. This species belongs to the dicotyledonous family, Haloragaceae.
19. *Myriophyllum spicatum* (Eurasian water milfoil) is a submerged, rooted species which tolerates a wide range of conditions and is found in both static and flowing water bodies. *M. spicatum* is a perennial which dies back to the roots over winter. Plants usually flower and set seed freely although vegetative propagation from axillary buds or stem fragments that detach naturally or after disturbance, is often the primary method of colonisation.

Cultivation of the test organism

20. Plants may be obtained from natural populations or via aquatic plant suppliers. In both cases, the source of the plants should be documented and species identity should be verified. Great care should be taken to ensure that the correct species is obtained when collecting *Myriophyllum spicatum* from the field, especially in regions where it can hybridise with other *Myriophyllum* species. If in doubt, use of verified laboratory cultures from known sources is recommended. Plants that have been exposed to any chemical contaminants, or collected from sites known to be contaminated, should not be used in this test.
21. In regions where *M. spicatum* is not readily available during the winter months, long-term maintenance of stock cultures may be necessary under glasshouse or laboratory conditions. Stock cultures should be maintained under conditions similar to the test conditions although irradiance and temperature may be reduced in order to reduce the frequency of culture maintenance (e.g. when *Myriophyllum* tests are not planned for a period). Use of larger aquaria and plant pots, than would be used in tests, is recommended in order to allow space for proliferation. Sediment and water-media composition should be the same as would be used for tests although alternative methods of sediment fertilisation may be adopted (e.g. use of commercial slow-release fertiliser formulations)
22. Stock plants should be visibly free of contamination with any other organisms, including snails, filamentous algae, fungi and insects, e.g. eggs or larvae of the moth *Paraponyx stratiotata* and larvae or adults of the curculionidae *Eubrychius velutus*. Rinsing plant material in fresh water may be necessary to eliminate visible contamination. In addition, efforts should be made to minimise the development of unicellular algae and bacterial contamination although complete sterility of the plant material is not necessary. Stock cultures should be monitored and transplanted as necessary to avoid development of algal and bacterial contamination. Aeration of stock cultures may be beneficial should algal or bacterial contamination become problematic.
23. In all cases, plants are cultured/ acclimatised under conditions that are similar, but not necessarily identical, to those used in the test for an adequate period (i.e. > 2 weeks) before their use in a test.
24. Flowering stock cultures should not be used in a test as vegetative growth rates generally decline during and after flowering.

▼ M7**Sediment**

25. The following formulated sediment, based on the artificial sediment used in Chapter C.28 of this Annex (8), is recommended for use in this test. The sediment is prepared as described in TM C.28, except for the addition of nutrients as described below:
- (a) 4-5 % peat (dry weight, according to $2 \pm 0,5$ % organic carbon) as close to pH 5,5 to 6,0 as possible; it is important to use peat in powder form, finely ground (preferably particle size < 1 mm) and only air dried.
 - (b) 20 % (dry weight) kaolin clay (kaolinite content preferably above 30 %).
 - (c) 75-76 % (dry weight) quartz sand (fine sand should predominate with more than 50 % of the particles between 50 and 200 μm).
 - (d) An aqueous nutrient medium is added such that the final sediment batch contains 200 mg/Kg dry sediment of both ammonium chloride and sodium phosphate and the moisture content of the final mixture is in a range of 30-50 %.
 - (e) Calcium carbonate of chemically pure quality (CaCO_3) is added to adjust the pH of the final mixture of the sediment to $7,0 \pm 0,5$.
26. The source of peat, kaolin clay and sand should be known and documented. If the origin is unknown or gives some level of concern, then the respective components should be checked for the absence of chemical contamination (e.g. heavy metals, organochlorine compounds, organophosphorous compounds).
27. The dry constituents of the sediment should be mixed homogenously prior to mixing the aqueous nutrient solution thoroughly into the sediment. The moist sediment should be prepared at least two days before use to allow thorough soaking of the peat and to prevent hydrophobic peat particles floating to the surface when the sediment is overlaid with media; before use, the moist sediment may be stored in the dark.
28. For the test, the sediment is transferred into a suitable size containers, such as plant pots of a diameter which fit into the glass vessels (the sediment surface area should cover approximately 70 % or more of the vessel surface area). In cases where the container has holes at the bottom, a piece of filter paper in the bottom of the container will help to keep the sediment within the container. The pots are filled with the sediment such that the sediment surface is level, prior to covering with a thin layer (~ 2 to 3 mm) of an inert material such as sand, fine horticultural grit (or crushed coral) to keep the sediment in place.

Test medium

29. Smart and Barko medium (12) is recommended for culturing and testing *Myriophyllum spicatum*. Preparation of this media is described in the Appendix 1. The pH of the media (water phase) at test initiation should be between 7,5 and 8,0 for optimum plant growth.

Experimental design

30. The test should incorporate a minimum of six replicate test vessels for the untreated control and a minimum of four replicate test vessels for each of a minimum of five concentration levels.
31. If determination of NOEC is not required, the test design may be altered to increase the number of concentrations and reduce the number of replicates per concentration.

▼ M7

32. Each test vessel represents a replicate containing three shoots. There are two options for growing three shoots in each test vessel:
- Test Design A: one shoot per pot and three pots per vessel.
 - Test Design B: three shoots per pot and one pot per vessel.
 - Alternative test designs of one shoot per pot per test vessel are acceptable provided that replication is adjusted as required to achieve the required validity criteria.
33. The individual test vessels should be randomly assigned to the treatment groups. A randomised design for the location of the test vessels in the test area is required to minimise the influence of spatial differences in light intensity or temperature.

Test chemical concentrations and control groups

34. Concentrations should typically follow a geometric series; the separation factor between test concentrations should not exceed 3,2. Prior knowledge of the toxicity of the test chemical from a range-finding test will help to select suitable test concentrations.
35. To determine an EC_x , test concentrations should bracket the EC_x to ensure an appropriate level of confidence. For example, if estimating the EC_{50} , the highest test concentration should be greater than the EC_{50} value. If the EC_{50} value lies outside of the range of test concentrations, associated confidence intervals will be large and a proper assessment of the statistical fit of the model may not be possible. The use of more test concentrations will improve the confidence interval around the resulting EC_x value.
36. To determine the LOEC/NOEC (optional endpoint), the lowest test concentration should be sufficiently low such that growth is not significantly different from growth in control plants. In addition, the highest test concentration should be sufficiently high such that growth is significantly lower than that in the control. The use of more replicates will enhance the statistical power of the no effect-concentration/ ANOVA design.

Limit test

37. In cases where a range-finding test indicates that the test chemical does not have an adverse effect at concentrations up to 100 mg/l or up to its limit of solubility in the test medium, or in the case of a formulation up to the limit of dispersibility, a limit test may be undertaken to facilitate comparison of responses in a control group and one treatment group — 100 mg/l or a concentration equal to the limit of solubility, or 1 000 mg/kg dry sediment. This test should follow the general principles of a standard dose-response test, with the exception that an increase in the minimum number of replicates to six test vessels per control and concentration is advised. Growth in the control and treatment group may be analysed using a statistical test to compare means, e.g. a Student's t-test.

Test solutions

38. Test solutions are usually prepared by dilution of a stock solution, prepared by dissolving or dispersing the test chemical in Smart and Barko media, using demineralised (i.e. distilled or deionised) water (see Appendix 1).

▼ M7

39. The highest test concentration should normally not exceed the water solubility of the test chemical or, in the case of formulations, the dispersibility under the test conditions.

40. For test chemicals of low water solubility, it may be necessary to prepare a concentrated stock solution or dispersion of the chemical using an organic solvent or dispersant in order to facilitate the addition of accurate quantities of the test chemical to the test medium and aid in its dispersion and dissolution. Every effort should be made to avoid the use of such solvents or dispersants. There should be no phytotoxicity resulting from the use of auxiliary solvents or dispersants. For example, commonly used solvents, which do not cause phytotoxicity at concentrations up to 100 µl/l, include acetone and dimethylformamide. If a solvent or dispersant is used, its final concentration should be reported and kept to a minimum (≤ 100 µl/l). Under these circumstances all treatments and (solvent) controls should contain the same concentration of solvent or dispersant. Untreated control replicates that do not contain a solvent or dispersant are also incorporated into the test design. Further guidance on the use of dispersants is given in an OECD Guidance Document (11).

TEST PROCEDURE

41. The test procedure varies according to the application route of the test chemical (i.e. via the water or sediment phase). The likely behaviour of the test chemical in a water-sediment system should be considered to inform the choice of exposure regime used in the test (i.e. static or static renewal, spiked water or spiked sediment). Spiked sediment tests may be preferred in some cases for chemicals that are predicted to significantly partition to sediment.

Establishment phase

42. Healthy shoot apices/tips, *i.e.* without side shoots, are cut from the culture plants to give a shoot length of 6 cm (± 1 cm). For Test Design A (one shoot per pot and three pots per vessel) single shoot tips are planted into each pot. For Test Design B (three shoots per pot and one pot per vessel) four to five shoot apices are planted into each pot containing the sediment.

43. In both cases surplus pots should be planted to allow for selection of uniform plants at test initiation, as well as to provide spare plants to be used for inspection of root growth immediately prior to treatment and spare plants to be harvested for shoot biomass and length measurements on Day 0.

44. Shoots are inserted such that approximately three cm, covering at least two nodes, are beneath the sediment surface.

45. Pots are then transferred to test vessels under the same environmental conditions as for the exposure phase and maintained for seven days in Smart and Barko medium to induce root development.

46. After this time, several plants in spare pots should be removed for inspection of root growth. If root growth is not visible (i.e. root tips are not visible), then the establishment phase should be extended until root growth is visible. This step is recommended to ensure that plants are actively growing at the time of test initiation.

▼ M7**Selection of uniform plant material**

47. For Test Design A (one shoot per pot and three pots per vessel) pots are selected for uniformity prior to test initiation. For Test Design B (three shoots per pot and one pot per vessel), surplus plants are removed to leave three plants that are uniform in size and appearance.

Exposure via the water phase

48. Pots, selected for uniformity, are placed into the test vessels as required for the experimental design. Smart and Barko medium is then added to the test vessels. Care should be taken to avoid disturbance of the sediment. For this purpose, media may be added using a funnel or a plastic disc to cover the sediment while the medium is poured into the test vessels provided that the disc is removed immediately afterwards. Alternatively, plant pots may be placed in the test vessels after the addition of the media. In both cases, fresh media may be used at the beginning of the exposure phase, if necessary to minimise the potential build-up of algae and bacteria or to allow preparation of single batches of test solution across replicates.
49. The shoot length above sediment is measured, either prior to or after the addition of the medium.
50. The relevant amounts of the test chemical may be added to the test medium before it is added to the test vessels. Alternatively, the test chemical may be introduced into the medium after it has been added to the test vessels. In this case, care should be taken to ensure that the test chemical is homogeneously distributed throughout the test system without disturbing the sediment.
51. In all cases, the appearance (e.g. clear, cloudy, etc.) of the test media is recorded at test initiation.

Exposure via sediment

52. Spiked sediments of the chosen concentration are prepared by addition of a solution of the test chemical directly to fresh sediment. A stock solution of the test chemical dissolved in deionised water is mixed with the formulated sediment by rolling mill, feed mixer or hand mixing. If poorly soluble in water, the test chemical can be dissolved in as small a volume as possible of a suitable organic solvent (e.g. hexane, acetone or chloroform). This solution is then mixed with ca. 10 g of fine quartz sand for one test vessel. The solvent is allowed to evaporate and the sand is then mixed with the suitable amount of sediment per test beaker. Only agents that volatilise readily can be used to solubilise, disperse or emulsify the test chemical. It should be borne in mind that the volume/weight of sand spiked with the test chemical has to be taken into account in the final preparation of the sediment (i.e. the sediment should thus be prepared with less sand). Care should be taken to ensure that the test chemical added to sediment is thoroughly and evenly distributed within the sediment.
53. The spiked sediment is filled into the pots (as described above). Plants, selected for uniformity and an adequate root system, are removed from the pots used during the establishment phase and transplanted into the spiked sediment as described above.
54. Pots are placed into the test vessels as required for the experimental design. Smart and Barko medium is then added carefully (i.e. using a funnel) in order to avoid disturbance of the sediment. The shoot length above sediment is measured, either prior to or after the addition of the media.

▼ M7**Maintenance of water levels over the test duration**

55. The final water volume must be recorded and the water level marked on each test vessel. If water evaporates during the test by more than 10 %, the water level should be adjusted with distilled water. If necessary, beakers may be loosely covered by a transparent cover such as transparent plastic lids to minimise evaporation and contamination with algal spores.

Test conditions

56. Warm and/or cool white fluorescent lighting are used to provide light irradiance in the range of about $140 (\pm 20) \mu\text{E}\cdot\text{m}^{-2} \text{ s}^{-1}$ when measured as a photosynthetically active radiation (400-700 nm) at the water surface and using a light:dark ratio of 16:8 h. Any differences from the selected light irradiance over the test area should not exceed the range of $\pm 15 \%$.
57. The temperature in the test vessels is $20 \pm 2 \text{ }^\circ\text{C}$.
58. The pH of the control medium should not increase by more than 1,5 units during the test. However, deviation of more than 1,5 units would not invalidate the test when it can be shown that the validity criteria specified previously are met.

Test duration

59. The exposure period is 14 days.

Measurements and analytical determinations

60. After the establishment phase and immediately prior to treatment (i.e. on Day 0), spare plants from five randomly selected pots for the three plants per pot design or 15 pots for the one plant per pot design, are harvested for assessment of shoot length and fresh and dry weight as described below.
61. For plants transferred into the exposure phase, the following assessments are made as shown in Table 1:
- Assessments of main shoot length, side shoot number and side shoot length are recorded at least at the end of the exposure period (e.g. on day 14).
 - Visual assessments of plant health are recorded at least three times during the exposure period (e.g. on days 0, 7 and 14).
 - Assessments of shoot fresh weight and dry weight are made at the end of the test (i.e. on Day 14).
62. Shoot length is determined using a ruler. If side shoots are present, their numbers and length should also be measured.
63. Visual assessments of plant health are made by recording the appearance of plants and the general condition of the test medium. Observations to be noted include:
- Necrosis, chlorosis or other discoloration such as excessive reddening relative to control plants.
 - Development of bacterial or algal contamination;
 - Growth abnormalities such as stunting, altered internodal length, distorted shoots/leaves, the proliferation of side shoots, leaf loss, loss of turgor and stem fragmentation.

▼ **M7**

- Visual assessments of root health are made at test termination, by carefully washing sediment from roots to enable observation of the root system. A proposed scale for assessment, relative to control plants, is shown below:
- (1) roots absent
 - (2) few roots
 - (3) moderate root development
 - (4) very good root development, similar to controls.
64. Assessments of fresh weight are made at the beginning and end of the test by cutting the shoot at sediment level and then blotting dry prior to weighing. Care should be taken to remove sediment particles that may adhere to the base of the shoot. Shoot material is then placed in a drying oven at ca. 60 °C and dried to a constant weight, prior to re-weighing and recording the dry weight.
65. A summary of the minimum biological assessments required over the test duration is provided in Table 1.

Table 1
Assessment schedule

Day after treatment (DAT)	<i>Myriophyllum spicatum</i>			
	Shoot length, side shoot length and number	Visual assessment of shoots	Shoot fresh and dry weight, Visual assessment of roots	pH O ₂
0	A	A	A	A
4	—	—	—	—
7	—	A	—	A
14	A	A	A	A

A: indicates that assessments are required on these occasions
—: indicates that measurements are not required.

Frequency of measurements and analytical determinations

66. The temperature of the medium in a supplementary vessel held under the same conditions in the growth chamber, incubator or room should be recorded at least daily (or continuously with a data logger).
67. The pH and dissolved oxygen concentration of the test medium should be checked at test initiation, at least once during the study and at the end of the study in all replicate vessels. On each occasion, measurements should be taken at the same time of the day. If bulk solutions are used to prepare all replicates at each test concentration, then a single measurement of each bulk solution is acceptable on Day 0.
68. Irradiance should be measured in the growth chamber, incubator or room at points equivalent to level of the water surface. Measurements should be made at least once at test initiation or during the test. The method of light

▼ M7

detection and measurement, in particular the type of sensor, will affect the measured value. Spherical sensors (which respond to light from all angles above and below the plane of measurement) and 'cosine' sensors (which respond to light from all angles above the plane of measurement) are preferred to unidirectional sensors, and will give higher readings for a multi-point light source of the type described here.

Analytical measurements of test chemical

69. The correct application of the test chemical should be supported by analytical measurements of test chemical concentrations.
70. Water samples should be collected for test chemical analysis shortly after test initiation (i.e. on the day of application for stable test chemicals or one hour after application for chemicals that are not stable) and at test termination for all test concentrations.
71. Concentrations in sediment and sediment pore-water should be determined at test initiation and test termination, at least in the highest test concentration, unless the test chemicals are known to be stable in water (> 80 % of nominal). Measurements in sediment and pore-water might not be necessary if the partitioning of the test chemical between water and sediment has been clearly determined in a water/sediment study under comparable conditions (e.g. sediment to water ratio, application method, sediment type).
72. Sampling of sediment at test initiation is likely to disrupt the test system. Hence, additional treated test vessels may be required to facilitate analytical determinations at test initiation and test termination. Similarly, where intermediate assessments are considered necessary, i.e. on day 7, and analyses require large samples of sediment that cannot be easily removed from the test system, analytical determinations should be performed using additional test vessels treated in the same way as those used for biological assessments.
73. Centrifugation at, for example, 10 000 g and 4 °C for 30 minutes is recommended to isolate interstitial water. However, if the test chemical is demonstrated not to absorb to filters, filtration may also be acceptable. In some cases, it might not be possible to analyse concentrations in the pore water if the sample size is too small.
74. In semi-static tests (i.e. exposure via the water phase) where the concentration of the relevant test chemical(s) is not expected to remain within 20 % of the nominal concentration over the test duration without renewal of test solutions, used and freshly prepared test solutions should be sampled for analyses of test chemical concentration at each renewal.
75. In cases where the measured initial concentration of the test chemical is not within 20 % of nominal but where sufficient evidence can be provided to show that the initial concentrations are repeatable and stable (i.e. within the range of 80-120 % of the initial concentration), chemical determinations may be carried out on only the highest and lowest test concentrations.
76. In all cases, determination of test chemical concentrations need only be performed on one replicate vessel at each test concentration. Alternatively, the test solutions of all replicates for each concentration may be pooled for analyses.
77. If there is evidence that the test chemical concentration has been maintained within 20 % of the nominal or measured initial concentration throughout the test, then analysis of the results and subsequent derivation of endpoints can be based on nominal or measured initial values.

▼M7

78. In these cases, effect concentrations should be based on nominal or measured water concentrations at the beginning of the test.
79. However, if there is evidence that the concentration has declined (i.e. is not maintained within 20 % of the nominal or measured initial concentration in the treated compartment) throughout the test, then analysis of the results should be based on the geometric mean concentration during exposure or models describing the decline of the concentration of the test chemical in the treated compartment (11).

DATA EVALUATION

80. In cases where use of a solvent / dispersant is required, data from solvent and untreated controls may be pooled for the purposes of statistical analyses provided that the responses of the solvent and untreated controls are not statistically significantly different.

Response variables

81. The purpose of the test is to determine the effects of the test chemical on the vegetative growth of the test species, using two response variables, average specific growth rate and yield, as follows:

Average specific growth rate

82. This response variable is based on changes in the logarithms of total shoot length, total shoot fresh weight and total shoot dry weight, over time in the controls and each treatment group. This variable is calculated for each replicate of each control and treatment group. The mean length and weight of the three plants per test vessel (replicate) and, subsequently, the growth rate for each replicate, should be calculated using the following formula:

$$\mu_{i-j} = \frac{\ln(N_j) - \ln(N_i)}{t}$$

where:

μ_{i-j} : average specific growth rate from time i to j

N_i : measurement variable in the test or control vessel at time i

N_j : measurement variable in the test or control vessel at time j

t: time period from i to j

83. From the replicate responses, a mean value for growth rate along with variance estimates should be calculated for each treatment and control group.
84. The average specific growth rate should be calculated for the entire test period (time 'i' in the above formula is the beginning of the test and time 'j' is the end of the test). For each test concentration and control, calculate a mean value for average specific growth rate along with the variance estimates.

▼ M7

85. Percent inhibition of growth rate (I_r) may then be calculated for each test concentration (treatment group) according to the following formula:

$$\%I_r = \frac{(\mu_C - \mu_T)}{\mu_C} \times 100$$

where:

% I_r : percent inhibition in average specific growth rate

μ_C : mean value for μ in the control

μ_T : mean value for μ in the treatment group

Yield

86. This response variable is based on changes in total shoot length, total shoot fresh weight and total shoot dry weight, over time in the controls and each treatment group. The mean percent inhibition in yield (% I_y) may be calculated for each treatment group as follows:

$$\%I_y = \frac{(b_C - b_T)}{b_C}$$

where:

% I_y : percent reduction in yield

b_C : final biomass minus starting biomass for the control group

b_T : final biomass minus starting biomass in the treatment group

Plotting concentration-response curves

87. Concentration-response curves relating mean percentage inhibition of the response variable (I_r , or I_y), calculated as shown above and the log concentration of the test chemical should be plotted.

EC_x estimation

88. Estimates of the EC_x (e.g. EC₅₀) should be based upon both average specific growth rate (E_rC_x) and yield (E_yC_x), each of which should in turn be based upon total shoot fresh weight, total shoot dry weight and total shoot length.
89. It should be noted that EC_x values calculated using these two response variables are not comparable and this difference is recognised when using the results of the test. EC_x values based upon average specific growth rate (E_rC_x) will in most cases be higher than results based upon yield (E_yC_x) — if the test conditions of this test method are adhered to — due to the mathematical basis of the respective approaches. This difference should not be interpreted as a difference in sensitivity between the two response variables, simply the values are different mathematically.

Statistical procedures

90. The aim is to obtain a quantitative concentration-response relationship by regression analysis. It is possible to use a weighted linear regression after having performed a linearising transformation of the response data, for instance into probit or logit or Weibull units (13), but non-linear regression procedures are preferred techniques that better handle unavoidable data irregularities and deviations from smooth distributions. Approaching either zero or total inhibition such irregularities may be magnified by the transformation, interfering with the analysis (13). It should be noted that standard methods of analysis using probit, logit, or Weibull transforms are intended for use on quantal (e.g. mortality or survival) data, and should be modified to

▼ M7

accommodate growth rate or yield data. Specific procedures for determination of EC_x values from continuous data can be found in (14) (15) (16) (17).

91. For each response variable to be analysed, use the concentration-response relationship to calculate point estimates of EC_x values. The 95 % confidence limits for each estimate are determined and goodness of fit of the response data to the regression model should be assessed either graphically or statistically. Regression analysis should be performed using individual replicate responses, not treatment group means.
92. EC_{50} estimates and confidence limits may also be obtained using linear interpolation with bootstrapping (18), if available regression models/methods are unsuitable for the data.
93. For estimation of the LOEC and hence the NOEC, it is necessary to compare treatment means using analysis of variance (ANOVA) techniques. The mean for each concentration is then compared with the control mean using an appropriate test method (e.g. Dunnett's, Williams' tests) (19) (20) (21) (22). It is necessary to assess whether the ANOVA assumption of normal distribution (ND) and variance homogeneity (VH) of variance holds. This assessment should be performed by Shapiro-Wilks-test (ND) or Levene's test (VH). Failure to meet the assumption of ND and homogeneity of variances can sometimes be corrected by logarithmic transformation of the data. If heterogeneity of variance and/or deviation from ND is extreme and cannot be corrected by transformation, analysis by methods such as Bonferroni-Welch-t-test, step-down Jonkheere Terpstra test and Bonferroni-Median-Test should be considered. Additional guidance on determining the NOEC can be found in (16).

REPORTING

94. The test report includes the following details:

Test chemical

Mono-constituent substance:

- physical appearance, water solubility, and additional relevant physico-chemical properties;
- chemical identification, such as IUPAC or CAS name, CAS number, SMILES or InChI code, structural formula, purity, chemical identity of impurities as appropriate and practically feasible, etc.

Multi-constituent substance, UVCBs and mixtures:

- characterised as far as possible by chemical identity (see above), quantitative occurrence and relevant physicochemical properties of the constituents.

Test species

- scientific name and source.

Test conditions

- duration and conditions of establishment phase;
- test procedure used (static, semi-static, pulsed);

▼ M7

- date of start of the test and its duration;
- test medium, *i.e.* sediment and liquid nutrient medium;
- description of the experimental design: growth chamber/room or laboratory, test vessels and covers, solution volumes, length and weight of test plants per test vessel at the beginning of the test, ratio of sediment surface to water surface, sediment and water volume ratio;
- test concentrations (nominal and measured as appropriate) and number of replicates per concentration;
- methods of preparation of stock and test solutions including the use of any solvents or dispersants;
- temperature during the test;
- light source, irradiance ($\mu\text{E}\cdot\text{m}^{-2}\text{ s}^{-1}$)
- pH values of the test and control media as well as appearance of test media at test initiation and end;
- oxygen concentrations;
- the method of analysis with appropriate quality assessment data (validation studies, standard deviations or confidence limits of analyses);
- methods for determination of measurement variables, e.g., length, dry weight, fresh weight;
- all deviations from this test method.

Results

- raw data: shoot length and shoot weight of plants/pot and other measurement variables in each test and control vessel at each observation and occasion of analysis according to the assessment schedule provided in Table 1;
- means and standard deviations for each measurement variable;
- growth curves for each concentration;
- doubling time/growth rate in the control based on shoot length and fresh weight including the coefficient of variation for yield of fresh weight;
- calculated response variables for each treatment replicate, with mean values and coefficient of variation for replicates;
- graphical representation of the concentration/effect relationship;
- estimates of toxic endpoints for response variables e.g. EC_{50} , and associated confidence intervals. If calculated, LOEC and/or NOEC and the statistical methods used for their determination;
- if ANOVA has been used, the size of the effect which can be detected (e.g. the minimum significant difference);
- any stimulation of growth found in any treatment;

▼ M7

- any visual signs of phytotoxicity as well as observations of test solutions;
- discussion of the results, including any influence on the outcome of the test resulting from deviations from this test method.

LITERATURE:

- (1) Chapter C.26 of this Annex: Lemna sp. Growth Inhibition Test.
- (2) Chapter C.3 of this Annex: Freshwater Alga and Cyanobacteria, Growth Inhibition Test.
- (3) Maltby, L. et al. (2010), Aquatic Macrophyte Risk Assessment for Pesticides, Guidance from the AMRAP Workshop in Wageningen (NL), 14-16 January 2008.
- (4) Arts, G.H.P. et al. (2008), Sensitivity of submersed freshwater macrophytes and endpoints in laboratory toxicity tests, Environmental Pollution, Vol. 153, pp. 199-206.
- (5) ISO 16191:2013 Water quality — Determination of the toxic effect of sediment on the growth behaviour of *Myriophyllum aquaticum*.
- (6) Knauer, K. et al. (2006), Methods for assessing the toxicity of herbicides to submersed aquatic plants, Pest Management Science, Vol. 62/8, pp. 715-722.
- (7) Chapter C.50 of this Annex: Sediment-free *Myriophyllum spicatum* Toxicity Test.
- (8) Chapter C.28 of this Annex: Sediment-Water Chironomid Toxicity Using Spiked Water.
- (9) Ratte, M., H. Ratte (2014), 'Myriophyllum Toxicity Test: Result of a ring test using *M. aquaticum* and *M. spicatum* grown in a water-sediment system', OECD Environment, Health and Safety Publications (EHS), Series on Testing and Assessment, No. 206, OECD Publishing, Paris.
- (10) Davies, J. et al. (2003), Herbicide risk assessment for non-target aquatic plants: sulfosulfuron — a case study, Pest Management Science, Vol. 59/2, pp. 231 - 237.
- (11) OECD (2000), 'Guidance Document on Aquatic Toxicity Testing of Difficult Substances and Mixtures', OECD Environment, Health and Safety Publications (EHS), Series on Testing and Assessment, No. 23, OECD Publishing, Paris.
- (12) Smart, R.M., J.W. Barko (1985), Laboratory culture of submersed freshwater macrophytes on natural sediments, Aquatic Botany, Vol. 21/3, pp. 251-263.
- (13) Christensen, E.R., N. Nyholm (1984), Ecotoxicological Assays with Algae: Weibull Dose-Response Curves, Environmental Science Technology, Vol. 18/9, pp. 713-718.
- (14) Nyholm, N. et al. (1992), Statistical treatment of data from microbial toxicity tests, Environmental Toxicology and Chemistry, Vol. 11/2, pp. 157-167.
- (15) Bruce, R.D., D.J. Versteeg (1992), A statistical procedure for modelling continuous toxicity data, Environmental Toxicology and Chemistry, Vol. 11/10, 1485-1494.
- (16) OECD (2006), 'Current Approaches in the Statistical Analysis of Ecotoxicity Data: A Guidance to Application', OECD Environment, Health and Safety Publications (EHS), Series on Testing and Assessment, No. 54, OECD Publishing, Paris.
- (17) Brain, P., R. Cousens (1989), An equation to describe dose-responses where there is stimulation of growth at low doses, Weed Research, Vol. 29/2, pp/ 93-96.

▼M7

- (18) Norberg-King, T.J. (1988), An interpolation estimate for chronic toxicity: The ICp approach, National Effluent Toxicity Assessment Center Technical Report 05-88. US EPA, Duluth, MN.
- (19) Dunnett, C.W. (1955), A multiple comparisons procedure for comparing several treatments with a control, *Journal of the American Statistical Association*, Vol. 50/272, pp. 1096-1121.
- (20) Dunnett, C.W. (1964), New tables for multiple comparisons with a control, *Biometrics*, Vol. 20/3, pp. 482-491.
- (21) Williams, D.A. (1971), A test for differences between treatment means when several dose levels are compared with a zero dose control, *Biometrics*, Vol. 27/1, pp. 103-117.
- (22) Williams, D.A. (1972), The comparison of several dose levels with a zero dose control, *Biometrics*, Vol. 28/2, pp. 519-531.

▼ M7*Appendix 1***SMART AND BARKO MEDIUM COMPOSITION**

Component	Amount of reagent added to water (*) (mg/l)
CaCl ₂ · 2 H ₂ O	91,7
MgSO ₄ · 7 H ₂ O	69,0
NaHCO ₃	58,4
KHCO ₃	15,4
pH (air equilibrium)	7,9

(*) Demineralised (i.e. distilled or deionised) water.

▼ M7

Appendix 2

DEFINITIONS

Biomass is the fresh and/or dry weight of living matter present in a population. In this test the biomass is the sum of main shoot, all lateral branches and all roots.

Chemical is a substance or a mixture.

Chlorosis is the change of the color from green to yellowing of test organism especially of the whorls.

EC_x is the concentration of the test chemical dissolved in test medium that results in a x % (e.g. 50 %) reduction in growth of *Myriophyllum spicatum* within a stated exposure period (to be mentioned explicitly if deviating from full or normal test duration). To unambiguously denote an EC value deriving from growth rate or yield the symbol 'E_rC' is used for growth rate and 'E_yC' is used for yield, followed by the measurement variable used, e.g. E_rC (main shoot length).

Growth is an increase in the measurement variable, e.g. main shoot length, total lateral branches length, total shoot length, total root length, fresh weight, dry weight or number of whorls, over the test period.

Growth rate (average specific growth rate) is the logarithmic increase in the measurement variable during the exposure period. *Note:* Growth rate related response variables are independent of the duration of the test as long as the growth pattern of unexposed control organisms is exponential.

Lowest Observed Effect Concentration (LOEC) is the lowest tested concentration at which the chemical is observed to have a statistically significant reducing effect on growth (at $p < 0,05$) when compared with the control, within a given exposure time. However, all test concentrations above the LOEC should have a harmful effect equal to or greater than those observed at the LOEC. When these two conditions cannot be satisfied, a full explanation should be given for how the LOEC (and hence the NOEC) has been selected.

Measurement variables are any type of variables which are measured to express the test endpoint using one or more different response variables. In this test method main shoot length, total lateral branches length, total shoot length, total root length, fresh weight, dry weight and number of whorls are measurement variables.

Monoculture is a culture with one plant species.

Necrosis is dead (i.e. white or dark brown) tissue of the test organism.

No Observed Effect Concentration (NOEC) is the test concentration immediately below the LOEC.

Response variable is a variable for the estimation of toxicity derived from any measured variable describing biomass by different methods of calculation. For this test method growth rate and yield are response variables derived from measurement variables like main shoot length, total shoot length, fresh weight, dry weight, or number of whorls.

Semi-static (renewal) test is a test in which the test solution is periodically replaced at specific intervals during the test.

Static test is a test method without renewal of the test solution during the test.

▼ M7

Test chemical is any substance or mixture tested using this test method.

Test endpoint describes the general factor that will be changed relative to control by the test chemical as aim of the test. In this test method the test endpoint is inhibition of growth which may be expressed by different response variables which are based on one or more measurement variables.

Test medium is the complete synthetic growth medium on which test plants grow when exposed to the test chemical. The test chemical will normally be dissolved in the test medium.

UVCB is a substance of unknown or variable composition, complex reaction product or biological material

Yield is value of a measurement variable to express biomass at the end of the exposure period minus the measurement variable at the start of the exposure period. *Note:* When the growth pattern of unexposed organisms is exponential, yield-based response variables will decrease with the test duration.

▼ M8**C.52. MEDAKA EXTENDED ONE GENERATION REPRODUCTION TEST (MEOGRT)**

INTRODUCTION

1. This test method is equivalent to OECD test guideline (TG) 240 (2015). The Medaka Extended One Generation Test (MEOGRT) describes a comprehensive test method based on fish exposed over multiple generations to give data relevant to ecological hazard and risk assessment of chemicals, including suspected endocrine disrupting chemicals (EDCs). Exposure in the MEOGRT continues until hatching (until two weeks post fertilisation, wpf) in the second (F2) generation. Additional investigations would be needed to justify the utility of extending the F2 generation beyond hatching; at this time, there is insufficient information to provide relevant conditions or criteria for warranting the extension of the F2 generation. However, this test method may be updated as new information and data are considered. For example, guidance on extending the F2 generation through reproduction may be potentially useful under certain circumstances (e.g., chemicals with high bioconcentration potential or indications of trans-generational effects in other taxa). This test method can be used to evaluate the potential chronic effects of chemicals, including potential endocrine disrupting chemicals, on fish. The method gives primary emphasis to potential population relevant effects (namely, adverse impacts on survival, development, growth and reproduction) for the calculation of a No Observed Effect Concentration (NOEC) or an Effect Concentration (EC_x), although it should be noted that EC_x approaches are rarely suitable for large studies of this type where increasing the number of test concentrations to allow for determination of the desired EC_x may be impractical which may also cause significant animal welfare concerns due to the large number of animals used. For chemicals not requiring assessment over ‘multi-generations’ or chemicals that are not potential endocrine disrupting chemicals, other test methods may be more appropriate (1). The Japanese medaka is the appropriate species for use in this test method, given its short life-cycle and the possibility to determine its genetic sex (2), which is considered a critical component in this test method. The specific methods and observational endpoints detailed in this method are applicable to Japanese medaka alone. Other small fish species (e.g., zebrafish) may be adapted to a similar test protocol.

2. This test method measures several biological endpoints. Primary emphasis is given to potential adverse effects on population relevant parameters including survival, gross development, growth and reproduction. Secondly, in order to provide mechanistic information and provide linkage between results from other kinds of field and laboratory studies, where there is *a posteriori* evidence for a chemical having potential endocrine disrupter activity (e.g. androgenic or oestrogenic activity in other tests and assays) then other useful information is obtained by measuring *vitellogenin* (*vtg*) mRNA (or vitellogenin protein, VTG), phenotypic secondary sex characteristics (SSC) as related to genetic sex, and evaluating histopathology. It should be noted that if a test chemical or its metabolites are not suspected of being EDCs, it may not be necessary to measure these secondary endpoints and less resource and animal intensive studies may be more appropriate (1). Definitions used in this test method are given in Appendix 1.

▼M8

INITIAL CONSIDERATIONS AND LIMITATIONS

3. Due to the limited number of chemicals tested and laboratories involved in the validation of this rather complex assay, it is anticipated that when a sufficient number of studies is available to ascertain the impact of this new study design, the test method will be reviewed and if necessary revised in light of experience gained. The data can be used at Level 5 of the OECD Conceptual Framework for Testing and Assessment of Endocrine Disrupters (3). The test method begins by exposing adult fish (the F0 generation) to the test chemical during the reproduction phase. The exposure continues through development and reproduction in the F1 and hatch in the F2 generation; thus the assay allows evaluation of both structural and activational endocrine pathways. A weight of evidence approach may be undertaken when interpreting the endocrine related endpoints.
4. The test should include an adequate number of individuals to ensure sufficient power for the evaluation of reproduction-relevant endpoints (see Appendix 3) whilst ensuring that the number of animals used is the minimum required for animal welfare reasons. In view of the large numbers of test animals used, it is important to carefully consider the need for the test in relation to existing data which may already contain relevant information on many of the endpoints in the MEOGRT. Some assistance in this regard can be obtained from the OECD Fish Toxicity Testing Framework (1).
5. The test method has been designed primarily to distinguish the effects of a single substance. However, if a test on a mixture is required, then it should be considered whether it will provide acceptable results for the intended regulatory purpose.
6. Before beginning the test, it is important to have information about the physicochemical properties of the test chemical, particularly to allow the production of stable chemical solutions. It is also necessary to have an adequately sensitive analytical method for verifying test chemical concentrations.

PRINCIPLE OF THE TEST

7. The test is started by exposing sexually mature males and females (at least 12 wpf) in breeding pairs for 3 weeks, during which the test chemical is distributed in the organism of the parental generation (F0) according to its toxicokinetic behaviour. As near as possible to the first day of the fourth week, eggs are collected to start the F1 generation. During rearing of the F1 generation (a total of 15 weeks), hatchability and survival are assessed. In addition, fish are sampled at 9-10 wpf for developmental endpoints and spawning is assessed for three weeks from 12 through 14 wpf. An F2 generation is started after the third week of the reproduction assessment and reared until completion of hatching.

TEST VALIDITY CRITERIA

8. The following criteria for test validity apply:
 - The dissolved oxygen concentration should be ≥ 60 % of air saturation value throughout the test;
 - The mean water temperature over the entire duration of the study should be between 24 and 26°C. Brief excursions from the mean by individual aquaria should not be more than 2°C;

▼M8

- The mean fecundity of controls in each of the generations (F0 and F1) should be greater than 20 eggs per pair per day. Fertility of all the eggs produced during the assessment should be greater than 80 %. In addition, 16 of the recommended 24 control breeding pairs (> 65 %) should produce greater than 20 eggs per pair per day;
- Hatchability of eggs should be ≥ 80 % (average) in the controls (in each of the F1 and F2 generations);
- Survival after hatching until 3 wpf and from 3 wpf through termination for the generation F1 (i.e. 15 wpf) should be ≥ 80 % (average) and ≥ 90 % (average), respectively in the controls (F1);
- Evidence should be available to demonstrate that the concentrations of the test chemical in solution have been satisfactorily maintained within ± 20 % of the mean measured values.

Regarding water temperature, while not a validity criterion, replicates within a treatment should not be statistically different from each other, and treatment groups within the test should not be statistically different from each other (based on daily temperature measurements, and excluding brief excursions).

9. Although decreased reproduction may be observed in the higher exposure groups there should be sufficient reproduction in at least the third highest group and all lower groups of F0 to fill the hatching incubators. Furthermore, there should be adequate embryo survival in the third highest and lower exposure groups in F1 to allow endpoint evaluation at the sub-adult sampling (see paragraphs 36 and 38 and Appendix 9). Additionally, there should be at least minimal post-hatch survival (~20 %) in the second highest exposure group of F1. These are not validity criteria, as such, but recommendations to permit robust NOECs to be calculated.
10. If a deviation from the test validity criteria is observed, the consequences should be considered in relation to the reliability of the test results and these deviations and considerations should be included in the test report.

DESCRIPTION OF THE METHOD**Apparatus**

11. Normal laboratory equipment and especially the following:
 - (a) oxygen and pH meters;
 - (b) equipment for determination of water hardness and alkalinity;
 - (c) adequate apparatus for temperature control and preferably continuous monitoring;
 - (d) tanks made of chemically inert material and of a suitable capacity in relation to the recommended loading and stocking density (see Appendix 3);
 - (e) suitably accurate balance (i.e. accurate to ± 0.5 mg).

▼ M8**Water**

12. Any water in which the test species shows suitable long-term survival and growth may be used as test water. It should be of constant quality during the period of the test. In order to ensure that the dilution water will not unduly influence the test result (for example by complexation of test chemical) or adversely affect the performance of the brood stock, samples should be taken at intervals for analysis. Measurements of heavy metals (e.g. Cu, Pb, Zn, Hg, Cd, Ni), major anions and cations (e.g. Ca^{2+} , Mg^{2+} , Na^+ , K^+ , Cl^- , SO_4^{2-}), pesticides, total organic carbon and suspended solids should be made, for example, every six months where a dilution water is known to be relatively constant in quality. Some chemical characteristics of acceptable dilution water are listed in Appendix 2. The pH of the water should be within the range 6.5 to 8.5, but during a given test it should be within a range of ± 0.5 pH units.

Exposure system

13. The design and materials used for the exposure system are not specified. Glass, stainless steel, or other chemically inert material should be used for construction of the test system that has not been contaminated during previous tests. For the purpose of this test, a well-suited exposure system may consist of a continuous flow-through system (4)(5)(6)(7)(8)(9)(10)(11)(12)(13).

Test solutions

14. Stock solution of the test chemical should be delivered into the exposure system by an appropriate pump. The flow rate of the stock solution should be calibrated in accordance with analytical confirmation of the test solutions before the initiation of exposure, and checked volumetrically periodically during the test. The test solution in each chamber is renewed adequately (e.g., minimum of 5 volume renewals/day to up to 16 volume renewals/day or up to 20 ml/min flow) depending on the test chemical stability and water quality.
15. Test solutions of the chosen concentrations are prepared by dilution of a stock solution. The stock solution should preferably be prepared by simply mixing or agitating the test chemical in dilution water by mechanical means (e.g. stirring and/or ultra-sonication). Saturation columns/systems or passive dosing methods (14) can be used for achieving a suitably concentrated stock solution. All efforts should be made to avoid solvents or carriers because: (1) certain solvents themselves may result in toxicity and/or undesirable or unexpected responses, (2) testing chemicals above their water solubility (as can frequently occur through the use of solvents) can result in inaccurate determinations of effective concentrations, (3) the use of solvents in longer-term tests can result in a significant degree of 'bio-filming' associated with microbial activity which may impact environmental conditions as well as the ability to maintain exposure concentrations and (4) in the absence of historical data that demonstrates that the solvent does not influence the outcome of the study, use of solvents requires a solvent control treatment which has animal welfare implications as additional animals are required to conduct the test. For difficult to test chemicals, a solvent may be employed as a last resort, and the OECD Guidance Document 23 on Aquatic Toxicity Testing of Difficult Substances and Mixtures (15) should be consulted to determine the best method. The choice of solvent will be determined by the chemical properties of the test chemical and the availability of historical data on use of the solvent. If solvent carriers are used, appropriate solvent controls should be evaluated in addition to non-solvent (negative) controls (dilution water only). In the event that use of a solvent is unavoidable, and

▼ M8

microbial activity (bio-filming) occurs, recommend recording/reporting of the bio-filming per tank (at least weekly) throughout the test. Ideally, the solvent concentration should be kept constant in the solvent control and all test treatments. If the concentration of solvent is not kept constant, the highest concentration of solvent in the test treatment should be used in the solvent control. In cases where solvent carrier is used, maximum solvent concentrations should not exceed 100 µl/l or 100 mg/l (15), and it is recommended to keep solvent concentration as low as possible (e.g. < 20 µl/l) to avoid potential effect of the solvent on endpoints measured (16).

Test animals*Selection and holding of fish*

16. The test species is Japanese medaka *Oryzias latipes* because of its short life-cycle and the possibility to determine genetic sex. Although other small fish species may be adapted to a similar test protocol, the specific methods and observational endpoints detailed in this test method are applicable to Japanese medaka alone (see paragraph 1). The medaka is readily induced to breed in captivity; published methods exist for its culture (17) (18) (19), and data are available from short-term lethality, early life-stage and full life-cycle tests (5) (6) (8) (9) (20). All fish are maintained on a 16 h light:8 h dark photoperiod. The fish will be fed live brine shrimp, *Artemia* spp., nauplii which may be supplemented with a commercially available flake food if necessary. Commercially available flake food should be regularly analysed for contaminants.

17. As long as appropriate husbandry practices are followed, no specific culturing protocol is required. For example, medaka can be reared in 2 l tanks with 240 larval fish per tank until 4 wpf, then they can be reared in 2 l tanks with 10 fish per tank until 8 wpf, at which time, they transition to breeding pairs in 2 l tanks.

Acclimation and selection of fish

18. Test fish should be selected from a single laboratory stock which has been acclimated for at least two weeks prior to the test under conditions of water quality and illumination similar to those used in the test (Note: This acclimation period is not an *in situ* pre-exposure period). It is recommended that test fish be obtained from an in-house culture, as shipping of adult fish is stressful and may interfere with reliable spawning. Fish should be fed brine shrimp nauplii twice per day throughout the holding period and during the exposure phase, supplemented with a commercially available flake food if necessary. A minimum of 42 breeding pairs (54 breeding pairs if a solvent control is required due, in part, to lack of historical data to support the use of only the non-solvent control) are considered necessary to initiate this test to ensure adequate replication. In addition, each breeding pair of F0 should be verified to be XX-XY (i.e. normal complement of sex chromosomes in each sex) to avoid the possible inclusion of spontaneous XX males (see paragraph 39).

▼M8

19. During the acclimation phase, mortalities in the culture fish should be recorded and the following criteria applied following a 48 h settling-down period:
- Mortalities of greater than 10 % of the culture population in seven days preceding transfer to the test system: reject the entire batch;

 - Mortalities of between 5 % and 10 % of the population in the seven days preceding transfer to the test system: acclimation for seven additional days to the 2-week acclimation period; if more than 5 % mortality during the second seven days, reject the entire batch;

 - Mortalities of less than 5 % of the population in the seven days preceding transfer to the test system: accept the batch.
20. Fish should not receive treatment for disease in the two-week acclimation period preceding the test and during the exposure period, and disease treatment should be completely avoided if possible. Fish with clinical signs of disease should not be used in the study. A record of observations and any prophylactic and therapeutic disease treatments during the culture period preceding the test should be maintained.
21. The exposure phase should be started with sexually dimorphic, genetically sexed adult fish from a laboratory supply of reproductively mature animals cultured at 25 ± 2 °C. The fish should be identified as proven breeders (i.e. having produced viable offspring) during the week preceding exposure. For the whole group of fish used in the test, the range in individual weights by sex at the start of the test should be kept within ± 20 % of the arithmetic mean weight of the same sex. A subsample of fish should be weighed before the test to estimate the mean weight. The fish selected should be at least 12 wpf, being a weight ≥ 300 mg for females and ≥ 250 mg for males.

TEST DESIGN**Test concentrations**

22. It is recommended to use five chemical concentrations plus control(s). All sources of information should be considered when selecting the range of test concentrations, including quantitative structure activity relationships (QSARs), read-across from analogues, results of fish tests such as acute toxicity assays (Chapter C.1 of this Annex), fish short-term reproduction assay (Chapter C.48 of this Annex) and other test methods e.g. Chapters C.15, C.37, C.41, C.47 or C.49 of this Annex (21) (22) (23) (24) (25) (26) if available, or if necessary, from a range-finding test possibly including a reproduction phase. If needed, the range-finding test may be conducted under conditions (water quality, test system, animal loading) similar to those used for the definitive test. If use of a solvent is necessary and no historical data are available, the range-finding test can be used to identify suitability of the solvent. The highest test concentration should not exceed the water solubility, 10 mg/l or 1/10th of the 96h-LC50 (27). The lowest concentration should be a factor of 10- to 100-times lower than the highest

▼M8

concentration. The use of five concentrations in this test enables not only dose-response relationships to be measured, but also provides the Lowest Observed Effect Concentration (LOEC) and NOEC which are necessary for risk assessment in some regulatory programmes or jurisdictions. Generally, the spacing factor between nominal concentrations of the test chemical between adjacent treatment levels is ≤ 3.2 .

Replicates within treatment groups and controls

23. A minimum of six replicate test chambers per test concentration should be used (see Appendix 7). During the reproductive phase (except F0 generation), replication structure is doubled for fecundity assessment and each replicate has only one breeding pair (see paragraph 42).
24. A dilution water control and, if needed, a solvent control should be run in addition to the test concentrations. A doubled number of replicate chambers for the controls should be used to ensure adequate statistical power (i.e., at least twelve replicates should be used for controls). During the reproductive phase, the number of replicates in the controls are doubled (i.e. 24 replicates as a minimum and each replicate has only one mating pair). Following reproduction, control replicates should contain no more than 20 embryos (fish).

PROCEDURE**Initiation of test**

25. The reproductively active adult fish used to start the F0 generation of the test are selected based on two criteria: age (typically more than 12 wpf but recommended not to exceed 16 wpf) and weight (should be ≥ 300 mg for females and ≥ 250 mg for males).
26. Female-male pairs that meet the above specifications are moved as individual pairs into each tank replicate, i.e. twelve replicates in controls and six replicates in chemical treatments at the initiation of the test. These tanks are randomly assigned a treatment (e.g., T1-T5 and control) and a replicate (e.g., A-L in controls and A-F in treatment), and then placed in the exposure system with the appropriate flow to each tank.

Conditions of exposure

27. A complete summary of test parameters and conditions can be found in Appendix 3. Adherence to these specifications should result in control fish with endpoint values similar to those listed in Appendix 4.
28. During the test, dissolved oxygen, pH, and temperature should be measured in at least one test vessel of each treatment group and the control. As a minimum, these measurements, except temperature, should be made once a week through the exposure period. The mean water temperature over the entire duration of the study should be between 24 and 26°C throughout the test. Temperature should be measured every day throughout the exposure period. The pH of the water should be within the range 6.5 to 8.5, but during a given test it should be within a range of ± 0.5 pH units. Replicates within a treatment should not be statistically different from each other, and treatment groups within the test should not be statistically different from each other (based on daily temperature measurements, and excluding brief excursions).

▼ M8**Duration of exposure**

29. The test exposes sexually reproductive fish from F0 for three weeks. In week 4 on approximately test day 24, F1 is established and the F0 breeding pairs are humanely killed and weight and length are recorded (see Paragraph 34). This is followed by exposure of the F1 generation for 14 more weeks (total of 15 weeks for F1) and the F2 generation for two weeks until hatching. The total duration of the test is primarily 19 weeks (i.e., until F2 hatching). Timelines for the test are shown in Table 2 and further explained in detail in Appendix 9.

Feeding regime

30. Fish can be fed brine shrimp *Artemia* spp. (24-hours old nauplii) *ad libitum*, supplemented with a commercially available flake food if necessary. Commercially available flake food should be regularly analysed for contaminants such as organochlorine pesticides, polycyclic aromatic hydrocarbons (PAHs), polychlorinated biphenyls (PCBs). Food with an elevated level of endocrine active substances (i.e., phytoestrogens) that could compromise the response of the test should be avoided. Uneaten food and faecal material should be removed from the test vessels as required, e.g. by carefully cleaning the bottom of each tank using a siphon. The sides and bottom of each tank should also be cleaned once or twice per week (e.g., by scraping with a spatula). An example of a feeding schedule can be found in Appendix 5. Feeding rate is based upon number of fish per replicate. Therefore, feeding rate is reduced if there are mortalities in a replicate.

Analytical determination and measurements

31. Prior to initiation of the exposure period, proper function of the chemical delivery system should be ensured. All analytical methods needed should be established, including sufficient knowledge of the chemical's stability in the test system. During the test, the concentrations of the test chemical are determined at appropriate intervals, preferably at least every week in one replicate for each treatment group, rotating between replicates of the same treatment group every week.
32. During the test, the flow rates of diluent and stock solution should be checked at intervals accordingly (e.g. at minimum three times a week). It is recommended that results be based on measured concentrations. However, if concentration of the test chemical in solution has been satisfactorily maintained within $\pm 20\%$ of the mean measured values throughout the test, then the results can either be based on nominal or measured values. In case of chemicals that markedly accumulate in fish, the test concentrations may decrease as the fish grow. In such cases, it is recommended that the renewal rate of the test solution in each chamber be adapted to maintain test concentrations as constant as possible.

Observations and measured endpoints

33. Endpoints measured include fecundity, fertility, hatching, growth and survival for evaluation of possible population-level effects. Observations of behaviour should also be made daily, and any unusual behaviour noted. Other mechanistic endpoints include hepatic *vtg* mRNA or VTG protein levels by an immunoassay (28), sexual phenotypic markers such as characteristic male anal fin papillae, histological evaluation of gonadal sex, and histopathological evaluation of kidney, liver and gonad (see endpoint list in Table 1). All of these specific endpoints are evaluated in the context of a determination of the genetic sex of the individual, based on the presence or absence of the medaka male-sex determining gene *dmy* (see paragraph 41). Additionally, time to spawn is also evaluated. In addition, simple phenotypic sex ratios can be derived using the information from counts of anal fin papillae

▼ M8

to define individual medaka as either phenotypically male or female. This test method would not be expected to detect modest deviations from the expected sex ratio because the relatively small numbers of fish per replicate will not provide sufficient statistical power. Also, during the course of the histopathological assessment, the gonad is evaluated and much more powerful analyses for assessing the gonad phenotype in the context of the genetic sex are conducted.

34. The primary purpose of this test method is to assess the potential population relevant effects of a test chemical. Mechanistic endpoints (VTG, SSCs and certain gonadal histopathology effects) can also assist in determining whether any effect is mediated via endocrine activity. However, these mechanistic endpoints can also be influenced by systemic and other toxicities. Consequently, liver and kidney histopathology may also be assessed in detail to help better understand any responses in mechanistic endpoints. However, if these detailed evaluations are not performed, gross abnormalities observed incidentally during the histopathological evaluation should still be noted and reported.

Humane killing of fish

35. At termination of F0 and F1 generation exposure, and when sub-adult fish are subsampled, the fish should be euthanised with appropriate amounts of anaesthetic solution (e.g. Tricaine methane sulfonate, MS-222 (CAS.886-86-2), 100-500 mg/l) buffered with 300 mg/l NaHCO₃ (sodium bicarbonate, CAS.144-55-8) to reduce mucous membrane irritation. If fish are showing signs of considerable suffering (very severe and death can be reliably predicted) and considered moribund, animals should be anaesthetised and euthanised and treated as mortality for data analysis. When a fish is euthanised due to morbidity, this should be noted and reported. Depending on when the fish is euthanised during the study, retaining the fish for histopathology analysis may be conducted (fixing the fish for possible histopathology).

Handling of eggs and larval fish***Collection of eggs from breeding pairs to propagate the next generation***

36. Egg collection is done on the first day (or first two days, if needed) of Test Week 4 to go from F0 to F1 and Test Week 18 to go from F1 to F2. Test Week 18 corresponds to F1, 15 wpf (weeks post fertilisation) adult fish. It is important that all eggs are removed from each tank the day before the egg collection starts to ensure all eggs collected from a breeding pair are from a single spawn. Following spawning, female medaka sometimes carry their eggs near the vent until the eggs can be deposited onto a substrate. With no substrate present in the tank, the eggs can be found either attached to the female or at the bottom of the tank. Depending on their location, eggs are either carefully removed from the female or siphoned from the bottom in Test Week 4 of F0 and Test Week 18 of F1. All eggs collected within a treatment are pooled prior to distribution to incubation chambers.

▼M8

37. Egg filaments, which hold spawned eggs together, should be removed. Fertilised eggs (up to 20) are collected from each breeding pair (1 pair per replicate), are pooled by treatment, and systematically distributed to suitable incubation chambers (Appendix 6, 7). Using a good quality dissecting microscope, one can see hallmarks of early fertilisation/development such as raising of the fertilisation membrane (chorion), ongoing cell division, or formation of the blastula. The incubator chambers may be placed in separate ‘incubator aquaria’ set up for each treatment (in which case water quality parameters and test chemical concentrations need to be measured in these), or in the replicate aquarium in which hatched larvae (*e.g.*, eleutheroembryo) will be contained. If a second day of collection (Test Day 23) is needed, all eggs from both days should be pooled and then systematically redistributed to each of the treatment replicates.

Rearing of eggs to hatching

38. Fertilised eggs are continually agitated *e.g.*, within the egg incubator by air bubbles or by vertically swinging the egg incubator. The mortalities of fertilised eggs (embryos) are checked and recorded daily. Dead eggs are removed from the incubators (Appendix 9). On the 7th day post fertilisation (dpf), the agitation is stopped or reduced so the fertilised eggs settle to the bottom of the incubator. This promotes hatching, typically over the next one or two days. For each treatment and control, hatchlings (young larvae; eleutheroembryo) are counted (pooled replicate basis). Fertilised eggs that have not hatched by twice the median day of hatch in the control (typically 16 or 18 dpf) are considered non-viable and discarded.
39. Twelve hatchlings are transferred into each replicate tank. The hatchlings from the incubation chambers are pooled and systematically distributed to replicate tanks (Appendix 7). This can be done by randomly selecting a hatchling from the treatment pool and sequentially adding a hatchling in an indiscriminate draw to a replicate aquarium. Each of the tanks should contain an equal number ($n=12$) of the hatched larvae (maximum 20 larvae each). If there are not enough hatchlings to fill all treatment replicates, then it is recommended to ensure as many replicates as possible have 12 hatchlings. Hatchlings can be handled safely with large-bore glass pipettes. Any additional hatchlings are humanely killed with anaesthetic. During the few weeks prior to the setup of breeding pairs, the day that the first spawning event is observed in each replicate should be recorded.

Setup of breeding pairs*Fin clipping and determination of genotypic sex*

40. Determination of genotypic sex via fin clips is done at 9-10 wpf (*i.e.*, Test Week 12-13 for F1 generation). All fish within a tank are anaesthetised (using approved methods, *e.g.*, IACUC) and a small tissue sample is taken from either the dorsal or the ventral tip of the caudal fin of each fish to determine the genotypic sex of the individual (29). The fish from a replicate can be housed in small cages, if possible one per cage, in the replicate tank. Alternatively, two fish can be held in each cage if they are distinguishable from each other. One method is to differentially cut the caudal fin (*e.g.*, dorsal vs ventral tip) when taking the tissue sample.

▼M8

41. The genotypic sex of medaka is determined by an identified and sequenced gene (*dmy*) which is located on the Y chromosome. The presence of *dmy* indicates a XY individual, regardless of phenotype, while the absence of *dmy* indicates a XX individual, regardless of phenotype (30); (31). Deoxyribose nucleic acid (DNA) from each fin clip is extracted and the presence or absence of *dmy* can be determined by polymerase chain reaction (PCR) methods (refer to Appendix 9 in Chapter C.41 of this Annex, or Appendix 3 and 4 in (29)).

Establishment of breeding pairs

42. The information on genotypic sex is used to establish XX-XY breeding pairs regardless of external phenotype which may be altered by exposure to a test chemical. On the day after the genotypic sex of each fish is determined, two XX fish and two XY fish from each replicate are randomly selected and two XX-XY breeding pairs are established. If a replicate does not have either two XX or two XY fish, appropriate fish should be obtained from other replicates within the treatment. The priority is to have the recommended number of replicate breeding pairs (12) in each treatment and in the controls (24). Fish with obvious abnormalities (swim bladder problems, spinal deformities, extreme size variations, etc.) would be precluded when establishing breeding pairs. During the reproductive phase for F1 each replicate tank should contain only one breeding pair.

Sampling of sub-adults and endpoint assessment*Sampling of non-breeding pair fish*

43. After the setup of breeding pairs, the fish not selected for further breeding are humanely killed for measurement of sub-adult endpoints in Test Week 12-13 (F1). It is extremely important that the fish are handled in such a way so that the genotypic sex determined for breeding pair selection can still be traced to an individual fish. All the data collected are analysed in the context of the genotypic sex of the specific fish. Each fish is used for a variety of endpoint measurements including: determination of survival rates of juvenile/sub-adult fish (Test Weeks 7-12/13(F1)), growth in length (standard length may be measured if the caudal fin has been shortened due to sampling for genetic sex analysis. Total length can be measured if only a portion of the caudal fin, dorsal or ventral, is sampled for *dmy*) and body mass (i.e., wet weight, blotted dry), liver *vtg* mRNA (or VTG) and anal fin papillae (see Tables 1 and 2). Note that weights and lengths of the breeding pairs are also required for calculating mean growth in a treatment group.

Tissue sampling and vitellogenin measurement

44. The liver is dissected, and should be stored at ≤ -70 °C until the *vtg* mRNA (or VTG) measurements. The tail of the fish, including the anal fin, is preserved in an appropriate fixative (e.g. Davidson's) or photographed so that anal fin papillae can be counted at a later date. If desired, other tissues (i.e., gonad) may be sampled and preserved at this time). Liver VTG concentration should be quantified with a homologous ELISA technique (see the recommended procedures for medaka in Appendix 6 in Chapter C.48 of this Annex). Alternatively, the methods for *vtg* mRNA quantification, i.e., *vtg I* gene mRNA extraction from a liver sample and quantification of the number

▼M8

of copies of the *vtg I* gene (per ng of total mRNA) by quantitative PCR, have been established by the U.S EPA (29). Instead of determining the number of copies of the *vtg* gene in the control and treatment groups, a more resource friendly and less technically difficult method is to determine the relative (fold) change in *vtg I* expression from control and treatment groups.

Secondary sex characteristics

45. Under normal circumstances, only sexually mature male medaka have papillae, which develop on the joint plates of certain anal fin rays as a secondary sexual characteristic, providing a potential biomarker for endocrine disrupting effects. The method of counting anal fin papillae (the number of joint plates with papillae) is given in Appendix 8. Also the number of anal fin papillae per individual is used to categorise that individual as externally phenotypic male or female for the purpose of calculating a simple sex ratio per replicate. A medaka with any number greater than 0 is defined as a male; a medaka with 0 anal fin papillae is defined as a female.

Fecundity and fertility assessment

46. Fecundity and fertility are assessed in Test Weeks 1 through 3 in the F0 generation and Test Weeks 15 through 17 in the F1 generation. Eggs are collected daily from each breeding pair for 21 consecutive days. Eggs are gently removed from netted females and/or siphoned from the bottom of the aquarium each morning. Both fecundity and fertility are recorded daily for each replicate breeding pair. Fecundity is defined as the number of eggs spawned, and fertility is functionally defined as the number of fertilised and viable eggs at the time of counting. Counting should be done as soon as possible after egg collection.
47. Replicate fecundity is recorded daily as the number of eggs per breeding pair which is analysed by the recommended statistical procedures using the replicate means. Replicate fertility is the sum of the number of fertile eggs produced by a breeding pair divided by the sum of the number of eggs produced by that pair. Statistically fertility is analysed as a ratio per replicate. Replicate hatchability is the number of hatchlings divided by the number of embryos loaded (typically 20). Statistically hatchability is analysed as a ratio per replicate.

Sampling of adults and endpoint assessment*Sampling of breeding pair fish*

48. Following Test Week 17 (i.e., after the F2 generation has successfully commenced), the F1 adults are humanely killed and various endpoints are assessed (see Tables 1 and 2). The anal fin is imaged for assessing anal fin papillae (see Appendix 8), and/or the tail, just posterior to the vent, is removed and fixed for counting papillae later. A portion of the caudal fin may be sampled and archived at this time for verification of genetic sex (*dmy*) if desired. If needed, a tissue sample can be taken to repeat the *dmy* analysis to verify genetic sex of specific fish. The body cavity is opened to allow perfusion with appropriate fixatives (e.g., Davidson's) prior to submersing the entire body in the fixative. However, if an appropriate permeabilisation step is performed prior to fixation, the body cavity does not need to be opened.

▼ **M8***Histopathology*

49. Each fish is evaluated histologically for pathology in the gonadal tissue (30); (29). As referenced in paragraph 33, other mechanistic endpoints evaluated in this assay (i.e., VTG, SSCs and certain gonadal histopathology effects) may be influenced by systemic or other toxicities. Consequently, liver and kidney histopathology may also be assessed in detail to help better understand any responses in mechanistic endpoints. However, if these detailed evaluations are not performed, gross abnormalities observed incidentally during the histopathological evaluation should still be noted and reported. ‘Reading down’ from the highest treatment group (compared to the control) to a treatment with no effect could be considered, however, it is recommended to consult the histopathology guidance (29). Typically all samples are processed/sectioned after which are read by the pathologist. If using a ‘read-down’ approach, it is noted that the Rao-Scott Cochran-Armitage by Slices (RSCABS) procedure uses the expectation that as dose levels increase the biological impact (the pathology) will increase as well. Therefore, one will lose power if only looking at a single high dose without any intermediate doses. If statistical analysis is not necessary to determine that the high dose has no effect, then this approach may be acceptable. The gonad phenotype is also derived from this evaluation

Other observations

50. The MEOGRT provides data that can be used (e.g., in a weight of evidence approach) to simultaneously evaluate at least two general types of adverse outcome pathways (AOPs) ending in reproductive impairment: (a) endocrine-mediated pathways involving disruption of the hypothalamus-pituitary-gonadal (HPG) endocrine axis; and, (b) pathways that cause reductions in survival, growth (length and weight), and reproduction through non-endocrine mediated toxicity. Endpoints typically measured in chronic toxicity tests such as the full life-cycle test and the early life-stage test are also included in this test and can be used to evaluate the hazards posed by both non-endocrine mediated toxic modes of action and endocrine-mediated toxicity pathways. During the test, observations of behaviour should be made daily, and any unusual behaviour should be noted. In addition, any mortality should be recorded and survival to the culling of fish (test week 6/7), survival after the culling to the sub-adult sampling (in 9-10 wpf), and survival from the pairing to the sampling of adult fish should be calculated.

*Table 1***Endpoint overview of the MEOGRT (*)**

Life-stage	Endpoint	Generation
Embryo(2 wpf)	Hatch (% and time to hatch)	F1, F2
Juvenile(4 wpf)	Survival	F1
Subadult(9 or 10 wpf)	Survival	F1
	Growth(length and weight)	

▼ M8

Life-stage	Endpoint	Generation
	Vitellogenin(mRNA or protein)	
	Secondary sex characteristics(anal fin papillae)	
	External sex ratio	
	Time to 1 st spawn	
Adult(12-14 wpf)	Reproduction(fecundity and fertility)	F0, F1
Adult(15 wpf)	Survival	F1
	Growth(length and weight)	
	Secondary sex characteristics(anal fin papillae)	
	Histopathology(gonad, liver, kidney)	

(*) These endpoints are to be statistically analysed

TIMELINE

51. A timeline for the MEOGRT illustrated in Table 2 shows the test. The MEOGRT includes 4 weeks of exposure to F0 adults and 15 weeks of exposure to the F1 generation, and exposure period for the second generation (F2), until hatching (2 wpf). Activity through the course of the MEOGRT is summarised in Appendix 9.

Table 2

Exposure and measurement endpoint timelines for the MEOGRT

MEOGRT Exposure and Endpoint Timeline																			
F0	1	2	3	4															
F1				1	2	3	4	5	6	7	8	9	10	11	12	13	14	15	
F2																	1	2	
Test Week	1	2	3	4	5	6	7	8	9	10	11	12	13	14	15	16	17	18	19
Lifestage Key					Embryo			Larvae			Juvenile			Subadult		Adult			
Endpoints																			
Fecundity	F ₀																	F ₁	
Fertility	F ₀																		F ₁
Hatch					F ₁														F ₂
Survival					F ₁						F ₁								F ₁
Growth				F ₀							F ₁								F ₁
Vitellogenin											F ₁								
Secondary sex											F ₁								F ₁
Histopathology																			F ₁
Test Week	1	2	3	4	5	6	7	8	9	10	11	12	13	14	15	16	17	18	19
<ul style="list-style-type: none"> Experimental design has 7 groups of replicates <ul style="list-style-type: none"> 5 for test chemical treatments 2 for control treatments (4 if solvent is used) Within-group design <ul style="list-style-type: none"> 12 replicates for reproduction, adult pathology and SSC (Wks 10 through to 18) 6 replicates for hatch, survival, Vtg; and - subadult SSC and growth (Wks 1 through to 9) SSC: secondary sex characters; Wks: weeks; Vtg: vitellogenin																			

▼ M8**DATA AND REPORTING****Statistical analysis**

52. Since genotypic sex is determined for all test fish, the data should be analysed for each genotypic sex separately (i.e., XY males and XX females). Failure to do this will greatly reduce the statistical power of any analysis. Statistical analyses of the data should preferably follow procedures described in the OECD document on Current Approaches in the Statistical Analysis of Ecotoxicity Data: A Guidance to Application (32). Appendix 10 provides further guidance to the Statistical Analysis.

53. The test design and selection of statistical tests should permit adequate power to detect changes of biological importance in endpoints where a NOEC is to be reported (32). Reporting of relevant effect concentrations and parameters may depend upon the regulatory framework. The percent change in each endpoint that it is important to detect or estimate should be identified. The experimental design should be tailored to allow that. It is not likely that the same percent change applies to all endpoints, nor is it likely that a feasible experiment can be designed that will meet these criteria for all endpoints, so it is important to focus on the endpoints which are important for the respective experiment in designing the experiment appropriately. A statistical flow diagram and guidance is available in Appendix 10 to help with the treatment of data and in the choice of the most appropriate statistical test or model to use. Other statistical approaches may be used, provided they are scientifically justified.

54. It will be necessary for variations to be analysed within each set of replicates using analysis of variance or contingency table procedures and sufficient appropriate statistical analysis methods used based on this analysis. In order to make a multiple comparison between the results at the individual concentrations and those for the controls, the step-down procedure (e.g., Jonckheere-Terpstra test) is recommended for continuous responses. Where the data are not consistent with a monotone concentration-response, Dunnett's test or Dunn's test should be used (after an adequate data transform, if necessary).

55. For fecundity, egg counts taken daily, but may be analysed as total egg counts or as a repeated measure. Appendix 10 provides the details of how this endpoint is analysed. For histopathology data which are in the form of severity scores, a new statistical test, Rao-Scott Cochran-Armitage by Slices (RSCABS), has been developed (33).

56. Any endpoints observed in chemical treatments that are significantly different from appropriate controls should be reported.

Data analysis considerations*Use of compromised treatment levels*

57. Several factors are considered when determining whether a replicate or entire treatment demonstrates overt toxicity and should be removed from analysis. Overt toxicity is defined as >4 mortalities in any replicate between 3 wpf and 9 wpf that cannot be explained by technical error. Other signs of overt toxicity include haemorrhage, abnormal behaviours, abnormal swimming

▼M8

patterns, anorexia, and any other clinical signs of disease. For sub-lethal signs of toxicity, qualitative evaluations may be necessary, and should always be made in reference to the dilution water control group (clean water only). If overt toxicity is evident in the highest treatment(s), it is recommended that those treatments be censored from the analysis.

Solvent controls

58. The use of a solvent should only be considered as a last resort, when all other chemical delivery options have been considered. If a solvent is used, then a dilution water control should be run in concert. At the termination of the test, an evaluation of the potential effects of the solvent should be performed. This is done through a statistical comparison of the solvent control group and the dilution water control group. The most relevant endpoints for consideration in this analysis are growth determinants (weight), as these can be affected through generalised toxicities. If statistically significant differences are detected in these endpoints between the dilution water control and solvent control groups, best professional judgment should be used to determine if the validity of the test is compromised. If the two controls differ, the treatments exposed to the chemical should be compared to the solvent control unless it is known that comparison to the dilution water control is preferred. If there is no statistically significant difference between the two control groups it is recommended that the treatments exposed to the test chemical are compared with the pooled (solvent and dilution-water control groups), unless it is known that comparison to either the dilution-water or solvent control group only is preferred.

Test report

59. The test report should include the following:

Test chemical: physical nature and, where relevant, physicochemical properties;

— Chemical identification data.

Mono-constituent substance:

— physical appearance, water solubility, and additional relevant physicochemical properties;

— chemical identification, such as IUPAC or CAS name, CAS number, SMILES or InChI code, structural formula, purity, chemical identity of impurities as appropriate and practically feasible, etc. (including the organic carbon content, if appropriate).

Multi-constituent substance, UVCBs and mixtures:

— characterised as far as possible by chemical identity (see above), quantitative occurrence and relevant physicochemical properties of the constituents.

Test species:

— Scientific name, strain if available, source and method of harvesting of the fertilised eggs and subsequent handling.

Test conditions:

— Photoperiod(s);

— Test design (e.g. chamber size, material and water volume, number of test chambers and replicates, number of hatchlings per replicates);

▼M8

- Method of preparation of stock solutions and frequency of renewal (the solubilising agent and its concentration should be given, when used);
- Method of dosing the test chemical (e.g. pumps, diluting systems);
- The recovery efficiency of the method and the nominal test concentrations, the limit of quantification, the means of the measured values and their standard deviations in the test vessels and the method by which these were attained and evidence that the measurements refer to the concentrations of the test chemical in true solution;
- Dilution water characteristics: pH, hardness, temperature, dissolved oxygen concentration, residual chlorine levels (if measured), total organic carbon (if measured), suspended solids (if measured), salinity of the test medium (if measured) and any other measurements made;
- The nominal test concentrations, the means of the measured values and their standard deviations;
- Water quality within test vessels, pH, temperature (daily) and dissolved oxygen concentration;
- Detailed information on feeding (e.g. type of foods, source, amount given and frequency).

Results:

- Evidence that controls met the overall validation criteria;
- Data for the control (plus solvent control when used) and the treatment groups as follows, hatching (hatchability and time to hatch) for F1 and F2, post hatch survival for F1, growth (length and body weight) for F1, genotypic sex and sexual differentiation (e.g. secondary sex characteristics based on anal fin papillae and gonadal histology) for F1, phenotypic sex for F1, secondary sex characteristics (anal fin papillae) for F1 *vtg* mRNA (or VTG protein) for F1, histopathology assessment (gonad, liver and kidney) for F1 and reproduction (fecundity and fertility) for F0, F1; (see Tables 1 and 2).
- Approach for the statistical analysis (regression analysis or analysis of the variance) and treatment of data (statistical tests and models used);
- No observed effect concentration (NOEC) for each response assessed;
- Lowest observed effect concentration (LOEC) for each response assessed (at $p = 0,05$); EC_x for each response assessed, if applicable, and confidence intervals (e.g. 90 % or 95 %) and a graph of the fitted model used for its calculation, the slope of the concentration-response curve, the formula of the regression model, the estimated model parameters and their standard errors.
- Any deviation from this test method and deviations from the acceptance criteria, and considerations of potential consequences on the outcome of the test.

▼ **M8**

60. For the results of endpoint measurements, mean values and their standard deviations (on both replicate and concentration basis, if possible) should be presented.

LITERATURE

- (1) OECD (2012a). Fish Toxicity Testing Framework, Environment, Health and Safety Publications, Series on Testing and Assessment (No. 171), Organisation for Economic Cooperation and Development, Paris.
- (2) Padilla S, Cowden J, Hinton DE, Yuen B, Law S, Kullman SW, Johnson R, Hardman RC, Flynn K and Au DWT. (2009). Use of Medaka in Toxicity Testing. *Current Protocols in Toxicology* 39: 1-36.
- (3) OECD (2012b). Guidance Document on Standardised Test Guidelines for Evaluating Endocrine Disrupters. Environment, Health and Safety Publications, Series on Testing and Assessment (No. 150), Organisation for Economic Cooperation and Development, Paris.
- (4) Benoit DA, Mattson VR, Olson DL. (1982). A Continuous-Flow Mini-Diluter System for Toxicity Testing. *Water Research* 16: 457-464.
- (5) Yokota H, Tsuruda Y, Maeda M, Oshima Y, Tadokoro H, Nakazono A, Honjo T and Kobayashi K. (2000). Effect of Bisphenol A on the Early Life Stage in Japanese Medaka (*Oryzias Latipes*). *Environmental Toxicology and Chemistry* 19: 1925-1930.
- (6) Yokota H, Seki M, Maeda M, Oshima Y, Tadokoro H, Honjo T and Kobayashi K. (2001). Life-Cycle Toxicity of 4-Nonylphenol to Medaka (*Oryzias Latipes*). *Environmental Toxicology and Chemistry* 20: 2552-2560.
- (7) Kang IJ, Yokota H, Oshima Y, Tsuruda Y, Yamaguchi T, Maeda M, Imada N, Tadokoro H and Honjo T. (2002). Effects of 17-Estradiol on the Reproduction of Japanese Medaka (*Oryzias Latipes*). *Chemosphere* 47: 71-80.
- (8) Seki M, Yokota H, Matsubara H, Tsuruda Y, Maeda M, Tadokoro H and Kobayashi K. (2002). Effect of Ethinylestradiol on the Reproduction and Induction of Vitellogenin and Testis-Ova in Medaka (*Oryzias Latipes*). *Environmental Toxicology and Chemistry* 21: 1692-1698.
- (9) Seki M, Yokota H, Matsubara H, Maeda M, Tadokoro H and Kobayashi K. (2003). Fish Full Life-Cycle Testing for the Weak Estrogen 4-Tert-Pentylphenol on Medaka (*Oryzias Latipes*). *Environmental Toxicology and Chemistry* 22: 1487-1496.
- (10) Hirai N, Nanba A, Koshio M, Kondo T, Morita M and Tatarazako N. (2006a). Feminization of Japanese Medaka (*Oryzias latipes*) Exposed to 17β-Estradiol: Effect of Exposure Period on Spawning Performance in Sex-Transformed Females. *Aquatic Toxicology* 79: 288-295.
- (11) Hirai N, Nanba A, Koshio M, Kondo T, Morita M and Tatarazako N. (2006b). Feminization of Japanese Medaka (*Oryzias latipes*) Exposed to 17β-Estradiol: Formation of Testis-Ova and Sex-Transformation During Early-Ontogeny. *Aquatic Toxicology* 77: 78-86.
- (12) Nakamura A, Tamura I, Takanobu H, Yamamuro M, Iguchi T and Tatarazako N. (2015). Fish Multigeneration Test with Preliminary Short-Term Reproduction Assay for Estrone Using Japanese Medaka (*Oryzias Latipes*). *Journal of Applied Toxicology* 35:11-23.
- (13) U.S. Environmental Protection Agency (2013). Validation of the Medaka Multigeneration Test: Integrated Summary Report. Available at: <http://www.epa.gov/scipoly/sap/meetings/2013/062513meeting.html>.
- (14) Adolfsson-Erici M, Åkerman G, Jahnke A, Mayer P and McLachlan M. (2012). A Flow-Through Passive Dosing System for Continuously Supplying Aqueous Solutions of Hydrophobic Chemicals to Bioconcentration and Aquatic Toxicity Tests. *Chemosphere* 86: 593-599.

▼ **M8**

- (15) OECD (2000). Guidance Document on Aquatic Toxicity Testing of Difficult Substances and Mixtures. OECD Environment, Health and Safety Publications, Series on Testing and Assessment (No. 23.), Organisation for Economic Cooperation and Development, Paris.
- (16) Hutchinson TH., Shillabeer N., Winter MJ and Pickford DB. (2006). Acute and Chronic Effects of Carrier Solvents in Aquatic Organisms: A Critical Review. *Review. Aquatic Toxicology* 76: 69–92.
- (17) Denny JS, Spehar RL, Mead KE and Yousuff SC. (1991). Guidelines for Culturing the Japanese Medaka, *Oryzias latipes*. US EPA/600/3-91/064.
- (18) Koger CS, Teh SJ and Hinton DE. (1999). Variations of Light and Temperature Regimes and Resulting Effects on Reproductive Parameters in Medaka (*Oryzias Latipes*). *Biology of Reproduction* 61: 1287-1293.
- (19) Kinoshita M, Murata K, Naruse K and Tanaka M. (2009). *Medaka: Biology, Management, and Experimental Protocols*, Wiley- Blackwell.
- (20) Gormley K and Teather K. (2003). Developmental, Behavioral, and Reproductive Effects Experienced by Japanese Medaka in Response to Short-Term Exposure to Endosulfan. *Ecotoxicology and Environmental Safety* 54: 330-338.
- (21) Chapter C.15 of this Annex, Fish, Short-term Toxicity Test on Embryo and Sac-fry Stages.
- (22) Chapter C.37 of this Annex, 21-day Fish Assay: A Short-Term Screening for Oestrogenic and Androgenic Activity, and Aromatase Inhibition.
- (23) Chapter C.41 of this Annex, Fish Sexual Development Test.
- (24) Chapter C.48 of this Annex, Fish Short Term Reproduction Assay.
- (25) Chapter C.47 of this Annex, Fish, Early-life Stage Toxicity Test.
- (26) Chapter C.49 of this Annex, Fish Embryo Acute Toxicity (FET) Test.
- (27) Wheeler JR, Panter GH, Weltje L and Thorpe KL. (2013). Test Concentration Setting for Fish *In Vivo* Endocrine Screening Assays. *Chemosphere* 92: 1067-1076.
- (28) Tatarazako N, Koshio M, Hori H, Morita M and Iguchi T. (2004). Validation of an Enzyme-Linked Immunosorbent Assay Method for Vitellogenin in the Medaka. *Journal of Health Science* 50: 301-308.
- (29) OECD (2015). Guidance Document on Medaka Histopathology Techniques and Evaluation. Environment, Health and Safety Publications, Series on Testing and Assessment (No. 227). Organisation for Economic Cooperation and Development, Paris.
- (30) Nanda I, Hornung U, Kondo M, Schmid M and Scharl M. (2003). Common Spontaneous Sex-Reversed XX Males of the Medaka *Oryzias Latipes*. *Genetics* 163: 245–251.
- (31) Shinomiya, A, Otake H, Togashi K, Hamaguchi S and Sakaizumi M. (2004). Field Survey of Sex-Reversals in the Medaka, *Oryzias Latipes*: Genotypic Sexing of Wild Populations, *Zoological Science* 21: 613-619.
- (32) OECD (2014). Current Approaches in the Statistical Analysis of Ecotoxicity Data: A guidance to application (annexes to this publication exist as a separate document), OECD Publishing, Paris.
- (33) Green JW, Springer TA, Saulnier AN and Swintek J. (2014). Statistical Analysis of Histopathology Endpoints. *Environmental Toxicology and Chemistry* 33: 1108-1116.

▼ **M8***Appendix 1*

DEFINITIONS

Chemical: A substance or a mixture.

ELISA: Enzyme-Linked Immunosorbent Assay

Fecundity = number of eggs;

Fertility = number of viable eggs/fecundity;

Fork length (FL) refers to the length from the tip of the snout to the end of the middle caudal fin rays and is used in fishes in which it is difficult to tell where the vertebral column ends www.fishbase.org

Hatchability = hatchlings/number of embryos loaded into an incubator

IACUC: Institutional Animal Care and Use Committee

Standard length (SL) refers to the length of a fish measured from the tip of the snout to the posterior end of the last vertebra or to the posterior end of the midlateral portion of the hypural plate. Simply put, this measurement excludes the length of the caudal fin. (www.fishbase.org)

Total length (TL) refers to the length from the tip of the snout to the tip of the longer lobe of the caudal fin, usually measured with the lobes compressed along the midline. It is a straight-line measure, not measured over the curve of the body (www.fishbase.org)

Figure 1

Description of the different lengths, used

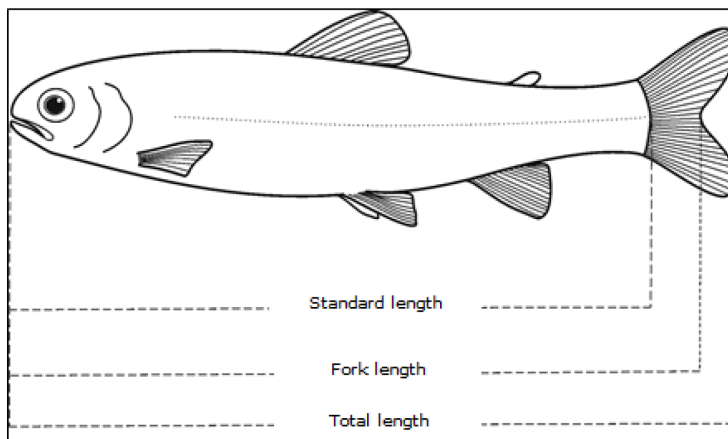

EC_x: (Effect concentration for x % effect) is the concentration that causes an x % of an effect on test organisms within a given exposure period when compared with a control. For example, an EC₅₀ is a concentration estimated to cause an effect on a test end point in 50 % of an exposed population over a defined exposure period.

Flow-through test is a test with continued flow of test solutions through the test system during the duration of exposure.

HPG axis: hypothalamic-pituitary-gonadal axis.

▼ M8

IUPAC: International Union of Pure and Applied Chemistry.

Loading rate: The wet weight of fish per volume of water.

Lowest observed effect concentration (LOEC) is the lowest tested concentration of a test chemical at which the chemical is observed to have a statistically significant effect (at $p < 0,05$) when compared with the control. However, all test concentrations above the LOEC should have a harmful effect equal to or greater than those observed at the LOEC. When these two conditions cannot be satisfied, a full explanation should be given for how the LOEC (and hence the NOEC) has been selected. Appendix 5 and 6 provide guidance.

Median Lethal Concentration (LC50): is the concentration of a test chemical that is estimated to be lethal to 50 % of the test organisms within the test duration.

No observed effect concentration (NOEC) is the test concentration immediately below the LOEC, which when compared with the control, has no statistically significant effect ($p < 0,05$), within a stated exposure period.

SMILES: Simplified Molecular Input Line Entry Specification.

Stocking density: The number of fish per volume of water.

Test chemical: Any substance or mixture tested using this test method.

UVCB: Substances of unknown or variable composition, complex reaction products or biological materials.

VTG: Vitellogenin is a phospholipoglycoprotein precursor to egg yolk protein that normally occurs in sexually active females of all oviparous species.

WPF: Weeks post fertilisation

▼ **M8***Appendix 2*

SOME CHEMICAL CHARACTERISTICS OF AN ACCEPTABLE DILUTION WATER

Substance	Limit concentration
Particulate matter	5 mg/l
Total organic carbon	2 mg/l
Un-ionised ammonia	1 µg/l
Residual chlorine	10 µg/l
Total organophosphorous pesticides	50 ng/l
Total organochlorine pesticides plus polychlorinated biphenyls	50 ng/l
Total organic chlorine	25 ng/l
Aluminium	1 µg/l
Arsenic	1 µg/l
Chromium	1 µg/l
Cobalt	1 µg/l
Copper	1 µg/l
Iron	1 µg/l
Lead	1 µg/l
Nickel	1 µg/l
Zinc	1 µg/l
Cadmium	100 ng/l
Mercury	100 ng/l
Silver	100 ng/l

▼ **M8***Appendix 3*

TEST CONDITIONS FOR THE MEOGRT

- | | |
|--|--|
| 1. Recommended species | Japanese medaka (<i>Oryzias latipes</i>) |
| 2. Test type | Continuous flow-through |
| 3. Water temperature | The nominal test temperature is 25°C. The mean temperature throughout the test in each tank is 24-26°C. |
| 4. Illumination quality | Fluorescent bulbs (wide spectrum and ~150 lumens/m ²)(~150 lux). |
| 5. Photoperiod | 16 h light:8 h dark |
| 6. Loading rate | F0: 2 adults/replicate; F1: initiated with maximum 20 eggs (embryos)/replicate, reduced to 12 embryos/replicate at hatch then 2 adults (XX-XY breeding pair) at 9-10 wpf for reproductive phase |
| 7. Minimum test chamber usable volume | 1,8 l (e.g., test chamber size: 18x9x15 cm) |
| 8. Volume exchanges of test solutions | Minimum of 5 volume renewal/day to up to 16 volume renewal/day (or 20 ml/min flow) |
| 9. Age of test organisms at initiation | F0: > 12 wpf but recommended not to exceed 16 wpf |
| 10. Number of organisms per replicate | F0: 2 fish (male and female pair); F1: maximum 20 fish (eggs)/replicate (produced from F0 and F1 breeding pairs). |
| 11. Number of treatments | 5 test chemical treatments plus appropriate control(s) |
| 12. Number of replicates per treatment | Minimum 6 replicates per treatment for test chemical and minimum 12 replicates for control, and for solvent control, if used (the number of replicates are doubled within reproduction phase in F1) |
| 13. Number of organisms per test | Minimum of 84 fish in F0 and 504 in F1. (If solvent control is used, then 108 fish in F0 and 648 fish in F1). The unit counted is the post-eleutheroembryo. |
| 14. Feeding regime | Fish are fed brine shrimp, <i>Artemia</i> spp., (24-hour old nauplii) <i>ad libitum</i> , supplemented with a commercially available flake food if needed (An example feeding schedule to ensure adequate growth and development to support robust reproduction can be found in Appendix 5). |

▼ **M8**

15. Aeration	None unless dissolved oxygen approaches <60 % of air saturation value
16. Dilution water	Clean surface, well or reconstituted water or dechlorinated tap water.
17. Exposure period	Primarily 19 weeks (from F0 to F2 hatching)
18. Biological endpoints (primary)	Hatchability (F1 and F2); survival (F1, from hatch to 4 wpf (end of larval/beginning of juvenile), from 4 to 9 (or 10) wpf (beginning of juvenile to subadult) and from 9 to 15 wpf (subadult to adult termination)); growth (F1, length and weight at 9 and 15 wpf); secondary sex characteristics (F1, anal fin papillae at 9 and 15 wpf); vitellogenin (F1, <i>vtg</i> mRNA or VTG protein at 15wpf); phenotypic sex (F1, via gonad histology at 15 wpf); reproduction (F0 and F1, fecundity and fertility for 21 days); time to spawn (F1); and histopathology (F1, gonad, liver and kidney at 15 wpf)
19. Test validity criteria	Dissolved oxygen of ≥ 60 % air saturation value; mean water temperature of 24-26°C throughout the test; successful reproduction of ≥ 65 % females in control(s); mean daily fecundity of ≥ 20 eggs in control(s); hatchability of ≥ 80 % (average) in the controls (in each of the F1 and F2); survival after hatching until 3 wpf of ≥ 80 % (average) and from 3 wpf through termination for the generation of ≥ 90 % (average) in the controls (F1), concentrations of the test chemical in solution should be satisfactorily maintained within ± 20 % of the mean measured values.

▼ **M8***Appendix 4*

GUIDANCE ON TYPICAL CONTROL VALUES

It should be noted that these control values are based on a limited number of validation studies, and may be subject to amendment in the light of further experience.

Growth

Weight and length measurements are taken for all fish sampled at 9 (or 10) and 15 weeks post fertilisation (wpf). Following this protocol will yield expected wet weights at 9 wpf of 85-145 mg for males and 95-150 mg for females. The expected weights at 15 wpf are 250-330 mg for males and 280-350 mg for females. While there may be substantial deviations from these ranges for individual fish, control mean weights substantially outside of these ranges, especially lower, would suggest problems with feeding, temperature control, water quality, disease or any combination of these factors.

Hatch

Hatching success in controls is typically around 90 %, however, values as low as 80 % are not uncommon. Hatch success less than 75 % may indicate insufficient agitation of the developing eggs or inadequate care in handling the eggs such as lack of timely removal of dead eggs leading to fungal infestation.

Survival

Survival rates until 3 wpf from hatch and after 3 wpf are usually 90 % or greater for controls but survival rates in early life stages as low as 80 % for controls are not alarming. Survival rates in controls of less than 80 % would be cause for concern and may indicate insufficient cleaning of the aquaria leading to loss of larval fish through disease or from suffocation due to low dissolved oxygen levels. Mortality may also occur as a result of injury during tank cleaning and by the loss of larval fish to the drain system of the tank.

Vitellogenin gene

While absolute levels of *vitellogenin* (*vlg*) gene, expressed as copies/ng of total mRNA, may vary greatly between laboratories due to the procedures or instrumentation used, the ratio of *vlg* should be around 200 times greater in control females versus control males. It is not uncommon for this ratio to be as high as from 1 000 to 2000, however, ratios less than 200 are suspect and may indicate problems with sample contamination or problems with the procedure and/or reagents used.

Secondary sex characteristics

For males, the normal range of Secondary Sex Characteristics, defined as the total number of segments in the fin-rays of the anal fin papillae, is 40-80 segments at 9-10 wpf. By 15 wpf, the range for control males should be about 80-120 and 0 for control females. For unexplained reasons, in rare instances some males have no papillae present by 9 wpf but since all control males develop papillae by 15 wpf, this is most likely caused by delayed development. The presence of papillae in control females indicates the presence of XX males in the population.

▼ M8*XX-males*

The normal background incidence of XX males in culture appears to be about 4 % or less at 25 °C with the incidence increasing with increased temperature. Steps should be taken to minimise the proportion of XX males in the population. Since the incidence of XX males appears to have a genetic component and is therefore heritable, monitoring the culture stock and ensuring that XX males are not used to propagate the culture stock is an effective means to reduce the incidence of XX males in the population.

Spawning activity

Spawning activity in the control replicates should be monitored daily prior to conducting the fecundity assessment. The control pairs can be qualitatively assessed visually for evidence of spawning activity. By 12-14 wpf most control pairs should be spawning. Low numbers of spawning pairs by this time indicates potential problems with the health, maturity or well-being of the fish.

Fecundity

Healthy, well fed 12-14 wpf medaka generally spawn daily, producing in the range of 15 to 50 eggs per day. Egg production for 16 of the recommended 24 control breeding pairs (> 65 %) should produce greater than 20 eggs per pair per day and may reach as high as about 40 eggs per day. Less than this amount may indicate immature, malnourished or unhealthy spawning pairs.

Fertility

The percentage of fertile eggs for control spawning pairs is typically in the 90 % range with values in the mid-to-upper 90s not uncommon. Fertility rates of less than 80 % for control eggs are suspect and may indicate either unhealthy individuals or less than ideal culture conditions.

▼ **M8***Appendix 5*

AN EXAMPLE OF A FEEDING SCHEDULE

An example of a feeding schedule to ensure adequate growth and development to support robust reproduction is shown in Table 1. Deviations from this feeding schedule may be acceptable, but it is recommended that they are tested to verify that acceptable growth and reproduction be observed. In order to follow the suggested feeding schedule, the dry weight of brine shrimp per volume of brine shrimp slurry needs to be determined prior to starting the test. This can be done by weighing a defined volume of brine shrimp slurry that has been dried for 24 hours at 60 °C on pre-weighed pans. To account for the weight of the salts in the slurry, an identical volume of the same salt solution used in the slurry should also be dried, weighed, and subtracted from the dried brine shrimp slurry weight. Alternatively, the brine shrimp can be filtered and rinsed with distilled water before drying, thereby eliminating the need to measure the weight of a 'salt blank'. This information is used to convert the information in the Table from dry weight of brine shrimp to volume of brine shrimp slurry to be fed per fish. In addition, it is recommended that aliquots of the brine shrimp slurry are weighed weekly to verify the correct dry weight of brine shrimp being fed.

*Table 1***Example of a feeding schedule**

Time (post-hatch)	Brine Shrimp (mg dry weight/fish/day)
Day 1	0,5
Day 2	0,5
Day 3	0,6
Day 4	0,7
Day 5	0,8
Day 6	1,0
Day 7	1,3
Day 8	1,7
Day 9	2,2
Day 10	2,8
Day 11	3,5
Day 12	4,2
Day 13	4,5
Day 14	4,8
Day 15	5,2
Day 16-21	5,6

▼ M8

Time (post-hatch)	Brine Shrimp (mg dry weight/fish/day)
Week 4	7,7
Week 5	9,0
Week 6	11,0
Week 7	13,5
Week 8-sacrifice	22,5

▼M8*Appendix 6*

EXAMPLES OF AN EGG INCUBATION CHAMBER

Example A

This incubator consists of a transected glass centrifuge tube, connected by a stainless steel sleeve and held in place by the centrifuge screw top cap. A small glass or stainless steel tube projects through the cap and is positioned near the rounded bottom, gently bubbling air to suspend the eggs and reducing between-egg transmission of saprophytic fungal infections while also facilitating chemical exchange between the incubator and the holding tank.

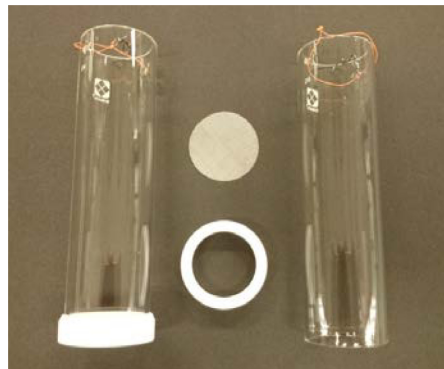
Example B

▼ M8

This incubator consists of a glass cylinder body (5 cm diameter and 10 cm height) and stainless wire mesh (0.25 ϕ and 32 mesh) which is attached to the bottom of the body with a PTFE ring. The incubators are suspended from the lifting bar to tanks, and shaken vertically (approximately 5 cm amplitude) in an appropriate cycle (approximately once every 4 seconds) for medaka eggs.

▼M8*Appendix 8*

COUNTING ANAL FIN PAPILLAE

Major Materials and Reagents

- Dissecting microscope (with optional camera attached)
- Fixative (e.g., Davidson's (Bouin's is not recommended)), if not counting from image

Procedures

After necropsy, the anal fin should be imaged to allow for convenient counting of anal fin papillae. While imaging is the recommended method, the anal fin can be fixed with Davidson's fixative or other appropriate fixative for approximately 1 minute. It is important to keep the anal fin flat during fixation to allow for easier counting of papillae. The carcass with the anal fin can be stored in Davidson's fixative or other appropriate fixative until analysed. Count the number of joint plates (see **Figure 1**) with papillae which protrude from the posterior margin of the joint plate.

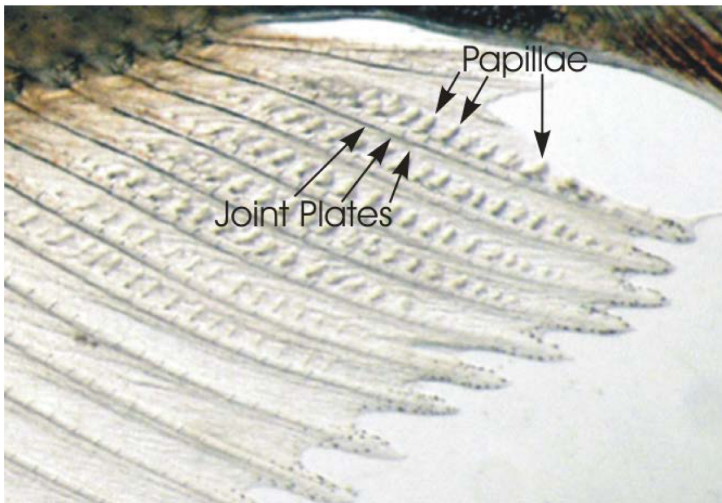
*Figure 1***Anal fin papillae**

▼M8*Appendix 9*

DETAILED TIMELINE OF MEOGRT

Test Weeks 1-3 (F0)

The F0 generation spawning fish that have met the selection criteria (see para. 16-20) are exposed for three weeks to allow the developing gametes and gonadal tissues to be exposed to the test chemical. Each replicate tank houses a single breeding fish pair (XX female-XY male breeding pair). Spawned eggs are collected, counted and assessed for fertility for 21 consecutive days, starting at Test Day 1.

Test Week 4 (F0 and F1)

It is preferable that the fertilised and viable eggs (embryos) are collected on a single day; however, if there are not enough embryos, the embryos may be collected over two days. If collected over two days, all embryos within the treatments that were collected on the first day are pooled with those collected on the second day. Then the total pooled embryos for each treatment are randomly distributed to each of the replicate incubators at 20 embryos per incubator. The mortalities of fertilised eggs (embryos) are checked and recorded daily. Dead eggs are removed from the incubators (death in fertilised eggs may be denoted by, particularly in the early stages, a marked loss of translucency and change in colouration, caused by coagulation and/or precipitation of protein, leading to a white opaque appearance; OECD 2010).

Note: If a single treatment requires a second day of collection, all treatments (including controls) need to follow this procedure. If after the second day of collection there are inadequate numbers of embryos within a treatment to load 20 embryos per incubator, then reduce the number of embryos loaded within that specific treatment to 15 embryos per incubator. If there are not enough embryos to load 15 per incubator, then reduce the number of replicate incubators until there are enough embryos for 15 per incubator. Additionally, more breeding pairs per treatment and controls could be added in F0 to produce more eggs to reach the recommended 20 per replicate.

On Test Day 24, the F0 breeding pairs are humanely killed and weight and length are recorded. If necessary F0 breeding pairs may be kept for an additional 1-2 days in order to restart F1.

Test Weeks 5-6 (F1)

One to two days before the anticipated start of hatching, stop or reduce the agitation of the incubating eggs to expedite hatching. As embryos hatch on each day, hatchlings are pooled by treatment and systematically distributed to each replicate larval tank within a specific treatment with no more than 12 hatchlings. This is done by randomly selecting hatchlings and placing a single hatchling in successive replicates in an indiscriminate draw, moving in order through the specific treatment replicates until all replicates within the treatment have 12 hatchlings. If there are not enough hatchlings to fill all replicates then ensure as many replicates as possible have 12 hatchlings to start the F1 phase.

The eggs that have not hatched by twice the median control day of hatch are considered non-viable and discarded. The number of hatchlings is recorded and hatching success (hatchability) is calculated in each replicate.

▼M8**Test Weeks 7-11 (F1)**

The survival of larval fish is checked and recorded daily in all replicates. On Test Day 43, the number of surviving fish in each replicate is recorded as well as the initial number of hatchlings placed in the replicate (nominally twelve). This allows for the calculation of the percent survival from hatch to the subadult stage.

Test Week 12 (F1)

On Test Day 78-85, a small sample is taken from the caudal fin of each fish to determine the genotypic sex of the individual (i.e., fin clipping) for all fish. This information is used to establish breeding pairs.

Within three days after the genotypic sex of each fish is determined, 12 breeding pairs per treatment and 24 pairs per control are randomly established. Two XX and XY fish from each replicate are randomly selected and then pooled by sex, and then randomly selected to establish a breeding pair (i.e., XX-XY pair). A minimum 12 replicates per chemical treatment and minimum 24 replicates for the control are established with one breeding pair per replicate. If a replicate does not have either two XX or two XY fish available for pooling, then fish with the appropriate gender genotype should be obtained from other replicates within the treatment.

The remaining fish (maximum 8 fish per replicate) are humanely killed and sampled for the various subadult endpoints. The *dmy* data (XX or XY) for all the subadult samples are retained to ensure that all endpoint data can be related to the genetic sex of each individual fish.

Test Weeks 13-14 (F1)

The exposure continues as the subadult breeding pairs develop into adults. On Test Day 98 (i.e. the day before egg collection is started), eggs are removed from both the aquaria and the females.

Test Weeks 15-17 (F1)

Spawned eggs are collected daily for 21 consecutive days in each replicate, and assessed for fecundity and fertility.

Test Week 18 (repeat of Test Week 4) (F1 and F2)

On Test Day 120, eggs collection is done in each replicate tank in the morning. The collected eggs are assessed and fertilised eggs (filaments removed) from each of the breeding pairs are pooled by treatment, and systematically distributed to egg incubation chambers with 20 fertilised eggs per incubator. The incubators may be placed in separate 'incubator tanks' set up for each treatment or in the replicate tank that upon hatch will contain the hatched larvae. It is preferable that the embryos are collected on a single day; however, if there are not enough embryos, the embryos may be collected over two days. If collected over two days, all embryos within the treatments that were collected on the first day are pooled with those collected on the second day. Then the total pooled embryos for each treatment are randomly distributed to each of the replicate incubators at 20 embryos per incubator. Note: If a single treatment requires a second day of

▼M8

collection, all treatments (including controls) need to follow this procedure. If after the second day of collection there is inadequate numbers of embryos within a treatment to load 20 embryos per incubator, reduce the number of embryos loaded within that specific treatment to 15 embryos per incubator. If there are not enough embryos to load 15 per incubator, reduce the number of replicate incubators until there are enough embryos for 15 per incubator.

On Test Day 121 (or Test Day 122, to ensure the F2 has started well), the F1 breeding pairs are humanely killed and analysed for the adult endpoints. If necessary F1 breeding pairs maybe kept for an additional 1-2 days in order to restart F2.

Test Weeks 19-20 (F2)

One to two days before the anticipated start of hatching, stop or reduce the agitation of the incubating eggs to expedite hatching. If the test is terminated by the completion of the F2 hatching, each day the hatchlings are tallied and discarded. (Embryos that have not hatched after a prolonged incubation time, defined as twice the median control day of hatch, are considered non-viable).

▼ **M8***Appendix 10*

STATISTICAL ANALYSIS

The types of biological data generated in the MEOGRT are not unique to it and except for pathology data, many appropriate statistical methodologies have been developed to properly analyse similar data depending on the characteristics of the data including normality, variance homogeneity, whether the study design lends itself to hypothesis testing or regression analysis, parametric versus non-parametric tests, etc. In general principle, the suggested statistical analyses follow the recommendations of the OECD for ecotoxicity data (OECD 2006) and a decision flowchart for MEOGRT data analysis can be seen in Figure 2.

It is assumed that most often the datasets will display monotonic responses. Additionally, the issue of using a one-tailed statistical test versus a two-tailed statistical test should be considered. Unless there is a biological reasoning that would make a one-tailed test inappropriate, it is suggested that one-tailed tests be used. While the following section recommends certain statistical tests, if more appropriate and/or powerful statistical methods are developed for application to the specific data generated in the MEOGRT, those statistical tests would be used to leverage those advantages.

The MEOGRT data should be analysed separately for each genotypic sex. There are two strategies to analysing the data from sex reversed fish (either XX males or XY females). 1) Censor all data from sex reversed fish across the entire test except the prevalence of sex reversal in each replicate. 2) Leave the data from all sex reversed fish in the dataset and analyse based upon genotype.

Histopathology data

Histopathology data are reported as severity scores which are evaluated using a newly developed statistical procedure, the Rao-Scott Cochrane-Armitage by Slices (RSCABS), (Green *et al.*, 2014). The *Rao-Scott* adjustment retains test-replication information; the *by Slices* procedure incorporates the biological expectation that severity scores tend to increase with increasing treatment concentrations. For each diagnosis, the RSCABS output specifies which treatments have higher prevalence of pathology than controls and the associated severity level.

Fecundity data

Analyses for fecundity data consist of a step-down Jonckheere-Terpstra or Williams' test to determine treatment effects, provided the data are consistent with a monotone concentration-response. With a step-down test, all comparisons are done at the 0,05 significance level and no adjustment for the number of comparisons made. The data are expected to be consistent with a monotone concentration response, but this can be verified either by visual inspection of the data or by constructing linear and quadratic contrasts of treatment means after a rank-order transform of the data. Unless the quadratic contrast is significant and the linear contrast is not significant, the trend test is done. Otherwise, Dunnett's test is used to determine treatment effects if the data are normally distributed with homogeneous variances. If those requirements are not met, then Dunn's test with a Bonferonni-Holm adjustment is used. All indicated tests are done independently of any overall F- or Kruskal-Wallis test. Further details are provided in OECD 2006.

▼ M8

Alternative methods can be used, such as a generalised linear model with Poisson errors for egg counts (with no transform), if justified statistically (Cameron and Trividi, 2013). Statistical advice is recommended if an alternative approach is used.

Daily Egg Count within a Single Generation

The ANOVA model is given by $Y = \text{Time} * \text{Time} + \text{Treatment} + * \text{Treatment} + \text{Time} * \text{Treatment} + * \text{Time} * \text{Treatment}$, with random effects of Replicate (Generation * Treatment), and Time * Replicate (Treatment), allowing for unequal variance components of both types across generations. Here Time refers to the frequency of egg counts (e.g., Day or Week). This is a repeated measures analysis, with the correlations between observations on the same replicates accounting for the repeated measures nature of the data.

Main effects of treatment are tested using the Dunnett (or Dunnett-Hsu) test, which adjusts for the number of comparisons. Adjustments for the main effect of generation or time are needed, for with these two factors, there is no 'control' level and every pair of levels is a comparison of possible interest. For these two main effects, if the F-test for the main effect is significant at the 0,05 level, then the pairwise comparisons across levels of that factor can then be tested at the 0,05 level without further adjustment.

The model includes two- and three-factor interactions, so that a main effect for, say, time, may not be significant even though time has a significant impact on results. Thus, if a two- or three-factor interaction involving time is significant at the 0,05 level, then one can accept the comparisons of levels of time at the 0,05 significance level without further adjustment.

Next are F-tests for significance of treatment within time, the so-called slices in the ANOVA table. If, for example, the slice for treatment within F1 and time 12, is significant at the 0,05 level, then the pairwise comparisons for treatment within F1 and time 12 can be accepted at the 0,05 level without further adjustment. Similar statements apply to tests for time within F1 and treatment and for generation within a time and treatment.

Finally, for comparisons not falling under any of the above categories, comparisons should be adjusted using the Bonferroni-Holm adjustment to p-values. Further information on analyses of such models can be found in Hocking (1985) and Hochberg and Tamhane (1987).

Alternatively, the raw data are recorded and presented in the study report as the fecundity (number of eggs) per replicate for each day. The replicate mean of the raw data should be calculated then a square root transformation applied. A one-way ANOVA on the transformed replicate means should be calculated followed by Dunnett contrasts. It may also be helpful to visually inspect the fecundity data of each treatment and/or replicate with a scatterplot that displays the data through time. This will allow an informal assessment of potential effects through time.

All other biological data

The statistical analyses are based on the underlying assumption that with proper dose selection the data will be monotonic. Thus, data are assumed to be monotonic and they are formally evaluated for monotonicity by using linear and quadratic contrasts. If the data are monotonic, a Jonckheere-Terpstra on replicate medians trend test (as advised in OECD 2006) is recommended. If the quadratic contrast is significant and the linear contrast is not, the data are considered non-monotonic.

▼ **M8**

If the data are non-monotonic, in particular because of the reduced response of the highest one or two treatments, consideration should be given to censoring the dataset so that the analysis is done without those treatments. This decision will need to be made with professional judgment and all available data, especially data that indicates overt toxicity at those treatment levels.

For weight and length, no transforms are recommended although they may occasionally be necessary. However, a log transformation is recommended for the vitellogenin data; a square root transformation is recommended for the SSC data (anal fin papillae); an arcsine-square root transformation is recommended for the data on proportion hatching, percent survival, sex ratio, and percent fertile eggs. Time to hatch and time to first spawn should be treated as time to event data, with individual embryos not hatching in the defined period or replicates never spawning treated as right-censored data. Time to hatch should be calculated from the median day of hatch of each replicate. These endpoints should be analysed using a mixed-effects Cox proportional hazard model.

The biological data from adult samples has one measurement per replicate, that is, there are one XX fish and one XY fish per replicate aquarium. Therefore, it is recommended that a one-way ANOVA be done on the replicate means. If the assumptions of the ANOVA (normality and variance homogeneity as assessed on the residuals of the ANOVA by Shapiro-Wilks test and Levene's test, respectively) are met, Dunnett contrasts should be used to determine treatments that were different from the control. On the other hand, if the assumptions of the ANOVA are not met, then a Dunn's test should be done to determine which treatments were different from control. A similar procedure is recommended for data that are in the form of percentages (fertility, hatch, and survival).

The biological data from subadult samples has from 1 to 8 measurements per replicate, that is, there can be variable numbers of individuals that contribute to the replicate mean for each genotypic sex. Therefore, it is recommended that a mixed effects ANOVA model be used followed by Dunnett contrasts, if the normality and variance homogeneity assumptions were met (on the residuals of the mixed effects ANOVA). If they were not met, then a Dunn's test should be done to determine which treatments were different from control.

Figure 2

Flow chart for the recommended statistical procedures for MEOGRT data analysis

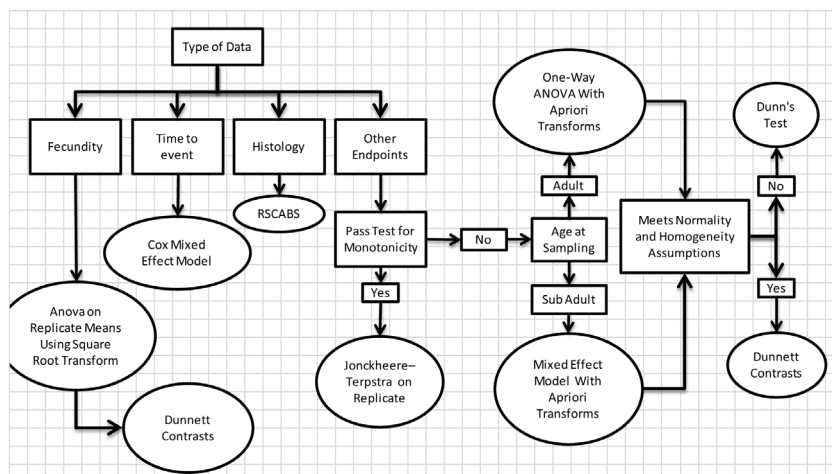

▼ **M8**

LITERATURE

- (1) OECD (2014). Current Approaches in the Statistical Analysis of Ecotoxicity Data: A guidance to application (annexes to this publication exist as a separate document), OECD Publishing, Paris.
- (2) Cameron AC and Trivedi PK (2013). Regression Analysis of Count Data, 2nd edition, Econometric Society Monograph No 53, Cambridge University Press.
- (3) Hocking RR (1985). The Analysis of Linear Models, Monterey, CA: Brooks/Cole.
- (4) Hochberg Y and Tamhane AC (1987). Multiple Comparison Procedures. John Wiley and Sons, New York.

▼ M8**C.53. THE LARVAL AMPHIBIAN GROWTH AND DEVELOPMENT ASSAY (LAGDA)**

INTRODUCTION

1. This test method is equivalent to OECD test guideline 241 (2015). The need to develop and validate an assay capable of identifying and characterising the adverse consequences of exposure to toxic chemicals in amphibians, originates from concerns that environmental levels of chemicals may cause adverse effects in both humans and wildlife. The OECD test guideline of the Larval Amphibian Growth and Development Assay (LAGDA) describes a toxicity test with an amphibian species that considers growth and development from fertilisation through the early juvenile period. It is an assay (typically 16 weeks) that assesses early development, metamorphosis, survival, growth, and partial reproductive maturation. It also enables measurement of a suite of other endpoints that allows for diagnostic evaluation of suspected endocrine disrupting chemicals (EDCs) or other types of developmental and reproductive toxicants. The method described in this test method is derived from validation work on African clawed frog (*Xenopus laevis*) by the U.S. Environmental Protection Agency (U.S. EPA) with supporting work in Japan (1). Although other amphibian species may be adapted to a growth and developmental test protocol with ability to determine genetic sex being an important component, the specific methods and observational endpoints detailed in this test method are applicable to *Xenopus laevis* alone.
2. The LAGDA serves as a higher tier test with an amphibian for collecting more comprehensive concentration-response information on adverse effects suitable for use in hazard identification and characterisation, and in ecological risk assessment. The assay fits at Level 4 of the OECD Conceptual Framework for Testing and Assessment of Endocrine Disrupters, where *in vivo* assays also provide data on adverse effects on endocrine relevant endpoints (2). The general experimental design entails exposing *X. laevis* embryos at Nieuwkoop and Faber (NF) stage 8-10 (3) to a minimum of four different concentrations of test chemical (generally spaced at not less than half-logarithmic intervals) and control(s) until 10 weeks after the median time to NF stage 62 in the control, with one interim sub-sample at NF stage 62 (≤ 45 post fertilisation; usually around 45 days (dpf)). There are four replicates in each test concentration with eight replicates for the control. Endpoints evaluated during the course of the exposure (at the interim sub-sample and final sample at completion of the test) include those indicative of generalised toxicity: mortality, abnormal behaviour, and growth determinations (length and weight), as well as endpoints designed to characterise specific endocrine toxicity modes of action targeting oestrogen, androgen or thyroid-mediated physiological processes. The method gives primary emphasis to potential population relevant effects (namely, adverse impacts on survival, development, growth and reproductive development) for the calculation of a No Observed Effect Concentration (NOEC) or an Effect Concentration causing x % change (ECx) in the endpoint measured. Although it should be noted that ECx approaches are rarely suitable for large studies of this type where increasing the number of test concentrations to allow for determination of the desired ECx may be impractical. It should also be noted that the method does not cover the reproductive phase itself. Definitions used in this test method are given in Appendix 1.

INITIAL CONSIDERATIONS AND LIMITATIONS

3. Due to the limited number of chemicals tested and laboratories involved in the validation of this rather complex assay, especially inter-laboratory reproducibility is not documented with experimental data so far, it is anticipated

▼ M8

that when a sufficient number of studies is available to ascertain the impact of this new study design, OECD test guideline 241 will be reviewed and if necessary revised in light of experience gained. The LAGDA is an important assay to address potential contributors to amphibian population declines by evaluating the effects from exposure to chemicals during the sensitive larval stage, where effects on survival and development, including normal development of reproductive organs, may adversely affect populations.

4. The test is designed to detect an apical effect(s) resulting from both endocrine and non-endocrine mechanisms, and includes diagnostic endpoints which are partly specific to key endocrine modalities. It should be noted that until the LAGDA was developed, no validated assay existed that served this function for amphibians.
5. Before beginning the assay, it is important to have information about the physicochemical properties of the test chemical, particularly to allow the production of stable chemical solutions. It is also necessary to have an adequately sensitive analytical method for verifying test chemical concentrations. Over a duration of approximate 16 weeks, the assay requires a total number of 480 animals, i.e., *X. laevis* embryos, (or 640 embryos, if a solvent control is used) to ensure sufficient power of the test for the evaluation of population-relevant endpoints such as growth, development and reproductive maturation.
6. Before use of the test method for regulatory testing of a mixture, it should be considered whether it will provide acceptable results for the intended regulatory purpose. Furthermore, this assay does not evaluate fecundity directly, so it may not be applicable for use at a more advanced stage than Level 4 of the OECD Conceptual Framework for Testing and Assessment of Endocrine Disrupters.

SCIENTIFIC BASIS FOR THE TEST METHOD

7. Much of our current understanding of amphibian biology has been obtained using the laboratory model species *X. laevis*. This species can be routinely cultured in the laboratory, ovulation can be induced using human chorionic gonadotropin (hCG) and animal stocks are readily available from commercial breeders.
8. Like all vertebrates, reproduction in amphibians is under the control of the hypothalamic pituitary gonadal (HPG) axis (4). Oestrogens and androgens are mediators of this endocrine system, directing the development and physiology of sexually-dimorphic tissues. There are three distinct phases in the life cycle of amphibians when this axis is especially active: (1) gonadal differentiation during larval development, (2) development of secondary sex characteristics and gonadal maturation during the juvenile phase and (3) functional reproduction of adults. Each of these three developmental windows are likely susceptible to endocrine perturbation by certain chemicals such as estrogens and androgens, ultimately leading to a loss of reproductive fitness by the organisms.
9. The gonads begin development at NF stage 43, when the bipotential genital ridge first develops. Differentiation of the gonads begins at NF stage 52 when primordial germ cells either migrate to medullary tissue (males) or remain in the cortical region (females) of the developing gonads (3). This

▼ **M8**

process of sexual differentiation of the gonads was first reported to be susceptible to chemical alteration in *Xenopus* in the 1950's (5) (6). Exposure of tadpoles to estradiol during this period of gonad differentiation results in sex reversal of males that when raised to adulthood are fully functional females (7) (8). Functional sex reversal of females into males is also possible and has been reported following implantation of testis tissue in tadpoles (9). However, although exposure to an aromatase inhibitor also causes functional sex reversal in *X. tropicalis* (10), this has not been shown to occur in *X. laevis*. Historically, toxicant effects on gonadal differentiation have been assessed by histological examination of the gonads at metamorphosis and sex reversal could only be determined by analysis of sex ratios. Until recently, there had been no means to directly determine the genetic sex of *Xenopus*. However, recent establishment of sex linked markers in *X. laevis* make it possible to determine genetic sex and allows for the direct identification of sex reversed animals (11).

10. In males, juvenile development proceeds as blood levels of testosterone increase corresponding with the development of secondary sex characteristics as well as testis development. In females, estradiol is produced by the ovaries resulting in the appearance of vitellogenin (VTG) in the plasma, vitellogenic oocytes in the ovary and the development of oviducts (12). Oviducts are female secondary sex characteristics that function in oocyte maturation during reproduction. Jelly coats are applied to the outside of oocytes as they pass through the oviduct and collect in the ovisac, ready for fertilisation. Oviduct development appears to be regulated by oestrogens as development correlates with blood estradiol levels in *X. laevis* (13) and *X. tropicalis* (12). The development of oviducts in males following exposure to polychlorinated biphenyl compounds (14) and 4-*tert*-octylphenol (15) has been reported.

PRINCIPLE OF THE TEST

11. The test design entails exposing *X. laevis* embryos at NF stage 8-10 via the water route to four different concentrations of test chemical as well as control(s) until 10 weeks after the median time to NF stage 62 in the control with one interim sub-sample at NF stage 62. While it may also be possible to dose highly hydrophobic chemicals via the feed, there has been little experience using this exposure route in this assay to date. There are four replicates in each test concentration with eight replicates for each control used. Endpoints evaluated during the course of the exposure include those indicative of generalised toxicity (i.e., mortality, abnormal behaviour and growth determinations (length and weight)), as well as endpoints designed to characterise specific endocrine toxicity modes of action targeting oestrogen-, androgen-, or thyroid-mediated physiological processes (i.e. thyroid histopathology, gonad and gonad duct histopathology, abnormal development, plasma vitellogenin (optional), and genotypic/phenotypic sex ratios).

TEST VALIDITY CRITERIA

12. The following criteria for test validity apply:

— The dissolved oxygen concentration should be ≥ 40 % of air saturation value throughout the test;

▼M8

- The water temperature should be in the range of 21 ± 1 °C and the inter-replicate and the inter-treatment differentials should not exceed 1,0 °C;
 - pH of the test solution should be maintained between 6.5 and 8.5, and the inter-replicate and the inter-treatment differentials should not exceed 0,5;
 - Evidence should be available to demonstrate that the concentrations of the test chemical in solution have been satisfactorily maintained within ± 20 % of the mean measured values;
 - Mortality over the exposure period should be ≤ 20 % in each replicate in the controls;
 - ≥ 70 % viability in the spawn chosen to start the study;
 - The median time to NF stage 62 of the controls should be ≤ 45 days.
 - The mean weight of test organisms at NF stage 62 and at the termination of the assay in controls and solvent controls (if used) should reach $1,0 \pm 0,2$ and $11,5 \pm 3$ g, respectively.
13. While not a validity criterion, it is recommended that at least three treatment levels with three uncompromised replicates be available for analysis. Excessive mortality, which compromises a treatment, is defined as > 4 mortalities (> 20 %) in 2 or more replicates that cannot be explained by technical error. At least three treatment levels without obvious overt toxicity should be available for analysis. Signs of overt toxicity may include, but are not limited to, floating on the surface, lying on the bottom of the tank, inverted or irregular swimming, lack of surfacing activity, and being non-responsive to stimuli, morphological abnormalities (e.g., limb deformities), hemorrhagic lesions, and abdominal oedema.
14. In case a deviation from the test validity criteria is observed, the consequences should be considered in relation to the reliability of the test results, and these deviations and considerations should be included in the test report.

DESCRIPTION OF THE METHODS

Apparatus

15. Normal laboratory equipment and especially the following:
- (a) temperature controlling apparatus (e.g., heaters or coolers adjustable to 21 ± 1 °C);

▼M8

- (b) thermometer;
- (c) binocular dissection microscope and dissection tools;
- (d) digital camera with at least 4 megapixel resolution and micro function (if needed);
- (e) analytical balance capable of measuring to 0,001 mg or 1 µg;
- (f) dissolved oxygen meter and pH meter;
- (g) light intensity meter capable of measuring in lux units.

Water*Source and quality*

16. Any dilution water that is locally available (e.g. spring water or charcoal-filtered tap water) and permits normal growth and development of *X. laevis* can be used, and evidence of normal growth in this water should be available. Because local water quality can differ substantially from one area to another, analysis of water quality should be undertaken, particularly if historical data on the utility of the water for raising amphibian larvae is not available. Measurements of heavy metals (e.g. Cu, Pb, Zn, Hg, Cd, Ni), major anions and cations (e.g. Ca²⁺, Mg²⁺, Na⁺, K⁺, Cl⁻, SO₄²⁻), pesticides, total organic carbon and suspended solids should be made before testing begins and/or, for example, every six months where a dilution water is known to be relatively constant in quality. Some chemical characteristics of acceptable dilution water are listed in Appendix 2.

Iodide concentration in test water

17. In order for the thyroid gland to synthesise thyroid hormones to support normal metamorphosis, sufficient iodide should be available to the larvae through a combination of aqueous and dietary sources. Currently, there are no empirically derived guidelines for minimum iodide concentrations in either food or water to ensure proper development. However, iodide availability may affect the responsiveness of the thyroid system to thyroid active agents and is known to modulate the basal activity of the thyroid gland which deserves attention when interpreting the results from thyroid histopathology. Based on previous work, successful performance of the assay has been demonstrated when dilution water iodide (I⁻) concentrations range between 0,5 and 10 µg/l. Ideally, the minimum iodide concentration in the dilution water throughout the test should be 0,5 µg/l (added as the sodium or potassium salt). If the test water is reconstituted from deionised water, iodine should be added at a minimum concentration of 0,5 µg/l. The measured iodide concentrations from the test water (i.e., dilution water) and the supplementation of the test water with iodine or other salts (if used) should be reported. Iodine content may also be measured in food(s) in addition to test water.

Exposure system

18. The test was developed using a flow-through diluter system. The system components should have water-contact components of glass, stainless steel, and/or other chemically inert materials. Exposure tanks should be glass or stainless steel aquaria and tank usable volume should be between 4,0 and 10,0 l (minimum water depth of 10 to 15 cm). The system should be capable of supporting all exposure concentrations, a control, and a solvent control, if necessary, with four replicates per treatment and eight in the controls. The flow rate to each tank should be constant in consideration of both the maintenance of biological conditions and chemical exposure. It is recommended that flow rates should be appropriate (e.g., at least 5 tank turnovers per day) to avoid chemical concentration declines due to metabolism by both the test organisms and aquatic microorganisms present in the aquaria or abiotic

▼M8

routes of degradation (hydrolysis, photolysis) or dissipation (volatilisation, sorption). The treatment tanks should be randomly assigned to a position in the exposure system to reduce potential positional effects, including slight variations in temperature, light intensity, *etc.* Further information on setting up flow-through exposure systems can be obtained from the ASTM Standard Guide for Conducting Acute Toxicity Tests on Test Materials with Fishes, Macroinvertebrates, and Amphibians (16).

Chemical delivery: preparation of test solutions

19. To make test solutions in the exposure system, stock solution of the test chemical should be dosed into the exposure system by an appropriate pump or other apparatus. The flow rate of the stock solution should be calibrated in accordance with analytical confirmation of the test solutions before the initiation of exposure, and checked volumetrically periodically during the test. The test solution in each chamber should be renewed at a minimum of 5 volume renewals/day.

20. The method used to introduce the test chemical to the system can vary depending on its physicochemical properties. Therefore, prior to the test, baseline information about the chemical that is relevant to determining its testability should be obtained. Useful information about test chemical-specific properties include the structural formula, molecular weight, purity, stability in water and light, pK_a and K_{ow} , water solubility (preferably in the test medium) and vapour pressure as well as results of a test for ready biodegradability (test method C.4 (17) or C.29 (18)). Solubility and vapour pressure can be used to calculate Henry's law constant, which will indicate whether losses due to evaporation of the test chemical may occur. Conduct of this test without the information listed above should be carefully considered as the study design will be dependent on the physicochemical properties of the test chemical and, without these data test results may be difficult to interpret or meaningless. A reliable analytical method for the quantification of the test chemical in the test solutions with known and reported accuracy and limit of detection should be available. Water soluble test chemicals can be dissolved in aliquots of dilution water at a concentration which allows delivery at the target test concentration in a flow-through system. Chemicals which are liquid or solid at room temperature and moderately soluble in water may require liquid:liquid or liquid:solid (*e.g.*, glass wool column) saturators (19). While it may also be possible to dose very hydrophobic test chemicals via the feed, there has been little experience using that exposure route in this assay.

21. Test solutions of the chosen concentrations are prepared by dilution of a stock solution. The stock solution should preferably be prepared by simply mixing or agitating the test chemical in dilution water by mechanical means (*e.g.* stirring and/or ultrasonication). Saturation columns/systems or passive dosing methods (20) can be used for achieving a suitably concentrated stock solution. The preference is to use a co-solvent-free test system; however, different test chemicals will possess varied physicochemical properties that will likely require different approaches for preparation of chemical exposure water. All efforts should be made to avoid solvents or carriers because: (1) certain solvents themselves may result in toxicity and/or undesirable or unexpected responses, (2) testing chemicals above their water solubility (as can

▼ **M8**

frequently occur through the use of solvents) can result in inaccurate determinations of effective concentrations, (3) the use of solvents in longer-term tests can result in a significant degree of 'biofilming' associated with microbial activity which may impact environmental conditions as well as the ability to maintain exposure concentrations and (4) the absence of historical data that demonstrate that the solvent does not influence the outcome of the study, use of solvents requires a solvent control treatment which has significant animal welfare implications as additional animals are required to conduct the test. For difficult to test chemicals, a solvent may be employed as a last resort, and the OECD Guidance Document on Aquatic Toxicity Testing of Difficult Substances and Mixtures should be consulted (21) to determine the best method. The choice of solvent will be determined by the chemical properties of the test chemical and the availability of historical control data on the solvent. In the absence of historical data, the suitability of a solvent should be determined prior to conducting the definitive study. In the event that use of a solvent is unavoidable, and microbial activity (biofilming) occurs, recommend recording/reporting of the biofilming per tank (at least weekly) throughout the test. Ideally, the solvent concentration should be kept constant in the solvent control and all test treatments. If the concentration of solvent is not kept constant, the highest concentration of solvent in the test treatment should be used in the solvent control. In cases where a solvent carrier is used, maximum solvent concentrations should not exceed 100 µl/l or 100 mg/l (21), and it is recommended to keep solvent concentration as low as possible (e.g., ≤20 µl/l) to avoid potential effects of the solvent on endpoints measured (22).

Test animals*Test species*

22. The test species is *X. laevis* because this is: (1) routinely cultured in laboratories worldwide, (2) easily obtainable through commercial suppliers and (3) capable of having its genetic sex determined.

Adult care and breeding

23. Appropriate care and breeding of *X. laevis* is described by a standardised guideline (23). Housing and care of *X. laevis* are also described by Read (24). To induce breeding, three to five pairs of adult females and males are injected intraperitoneally with human chorionic gonadotropin (hCG). Female and male specimens are injected with e.g., approximately 800-1 000 IU and 500-800 IU, respectively, of hCG dissolved in 0,6-0,9 % saline solution (or frog Ringer's solution, an isotonic saline for use with amphibians). Injection volumes should be about 10 µl/g body weight (~1 000 µl). Afterwards, induced breeding pairs are held in large tanks, undisturbed and under static conditions to promote amplexus. The bottom of each breeding tank should have a false bottom of stainless steel mesh (e.g., 1,25 cm openings) which permits the eggs to fall to the bottom of the tank. Frogs injected with hCG in the late afternoon will usually deposit most of their eggs by mid-morning of the next day. After a sufficient quantity of eggs is released and fertilised, adults should be removed from the breeding tanks. Eggs are then collected and jelly coats are removed by L-cysteine treatment

▼M8

(23). A 2 % L-cysteine solution should be prepared and pH adjusted to 8.1 with 1 M NaOH. This 21 °C solution is added to a 500 ml Erlenmeyer flask containing the eggs from a single spawn and swirled gently for one to two minutes and then rinsed thoroughly 6-8 times with 21 °C culture water. The eggs are then transferred to a crystallising dish and determined to be > 70 % viable with minimal abnormalities in embryos exhibiting cell division.

TEST DESIGN**Test concentrations**

24. It is recommended to use a minimum of four chemical concentrations and appropriate controls (including solvent controls, if necessary). Generally, a concentration separation (spacing factor) not exceeding 3.2 is recommended.
25. For the purposes of this test, results from existing amphibian studies should be used to the extent possible in determining the highest test concentration so as to avoid concentrations that are overtly toxic. Information from, for example, quantitative structure-activity relationships, read across and data from existing amphibian studies such as the Amphibian Metamorphosis Assay, test method C.38 (25) and the Frog Embryo Teratogenesis Assay - *Xenopus* (23) and/or fish tests such as test methods C.48, C.41 and C.49 (26) (27) (28) may contribute toward setting this concentration. Prior to running the LAGDA a range finding experiment may be conducted. It is recommended that the range-finding exposure is initiated within 24 hours of fertilisation and continued for 7-14 days (or more, if needed), and the test concentrations are set such that the intervals between test concentrations are no greater than a factor of 10. The results of the range finding experiment should serve to set the highest test concentration in the LAGDA. Note that if a solvent has to be used, then the suitability of the solvent (i.e. whether it may have an impact on the outcome of the study) could be determined as part of the range finding study.

Replicates within treatment groups and controls

26. A minimum of four replicate tanks per test concentration and a minimum of eight replicates for the controls (and solvent control, if needed) should be used (i.e., the number of replicates in the control and any solvent control should be twice as large as the number of replicates of each treatment group, to ensure appropriate statistical power). Each replicate should contain no more than 20 animals. The minimum number of animals processed would be 15 (5 for NF stage 62 sub-sample and 10 juveniles). However, additional animals are added to each replicate to factor in the possibility for mortality while maintaining the critical number of 15.

PROCEDURE**Assay overview**

27. The assay is initiated with newly spawned embryos (NF stage 8-10) and continues into juvenile development. Animals are examined daily for mortality and any sign of abnormal behaviour. At NF stage 62, a larval sub-sample (up to 5 animals per replicate) is collected and various endpoints are examined (Table 1). After all animals have reached NF stage 66, i.e. completion of metamorphosis (or after 70 days from the assay initiation, whichever comes first), a cull is carried out at random

▼ M8

(but without sub-sampling) to reduce the number of animals (10 per tank) (see paragraph 43), and the remaining animals continue exposure until 10 weeks after the median time to NF stage 62 in the control. At test termination (juvenile sampling) additional measurements are made (Table 1).

Exposure conditions

28. A complete summary of test parameters can be found in Appendix 3. During the exposure period, dissolved oxygen, temperature, and pH of test solutions should be measured daily. Conductivity, alkalinity, and hardness are measured once a month. For the water temperature of test solutions, the inter-replicate and inter-treatment differentials (within one day) should not exceed 1,0 °C. Also, for pH of test solutions, the inter-replicate and inter-treatment differentials should not exceed 0,5.

29. The exposure tanks may be siphoned on a daily basis to remove uneaten food and waste products, being careful to avoid cross-contamination of tanks. Care should be used to minimise stress and trauma to the animals, especially during movement, cleaning of aquaria, and manipulation. Stressful conditions/activities should be avoided such as loud and/or incessant noise, tapping on aquaria, vibrations in the tank.

Duration of exposure to the test chemical

30. The exposure is initiated with newly spawned embryos (NF stage 8-10) and continued until ten weeks after the median time to NF stage 62 (≤ 45 days from the assay initiation) in control group. Generally, the duration of the LAGDA is 16 weeks (maximum 17 weeks).

Initiation of assay

31. Parent animals used for the initiation of the assay should have previously been shown to produce offspring that can be genetically sexed (Appendix 5). After spawning of adults, embryos are collected, cysteine-treated to remove the jelly coat and screened for viability (23). Cysteine treatment allows the embryos to be handled during screening without sticking to surfaces. Screening takes place under a dissecting microscope using an appropriately sized eye dropper to remove non-viable embryos. It is preferred that a single spawn resulting in greater than 70 % viability be used for the test. Embryos at NF stage 8-10 are randomly distributed into exposure treatment tanks containing an appropriate volume of dilution water until each tank contains 20 embryos. Embryos should be carefully handled during this transfer in order to minimise handling stress and to avoid any injury. At 96 hours post fertilisation, the tadpoles should have moved up the water column and begun clinging to the sides of the tank.

Feeding regime

32. Feed and feeding rate change during different life stages of *X. laevis* are a very important aspect of the LAGDA protocol. Excessive feeding during the larval phase typically results in increased incidences and severity of scoliosis (Appendix 8) and should be avoided. Conversely, inadequate feeding during the larval phase results in highly variable developmental rates among

▼ M8

controls potentially compromising statistical power or confounding test results. Appendix 4 provides recommended larval and juvenile diet and feeding regimes for *X. laevis* in flow-through conditions, but alternatives are permissible providing the test organisms grow and develop satisfactorily. It is important to note that if endocrine-specific endpoints are being measured, feed should be free of endocrine-active substances such as soy meal.

Larval feeding

33. The recommended larval diet consists of trout starter feeds, *Spirulina* algae discs and goldfish crisps (e.g., TetraFin[®] flakes, Tetra, Germany) blended together in culture (or dilution) water. This mixture is administered three times daily on weekdays and once daily on weekends. Tadpoles are also fed live brine shrimp, *Artemia* spp., 24-hour-old nauplii, twice daily on weekdays and once daily on the weekends starting on day 8 post-fertilisation. The larval feeding, which should be consistent in each test vessel, should allow appropriate growth and development for test animals in order to ensure reproducibility and transferability of the assay results: (1) the median time to NF stage 62 in controls should be ≤ 45 days and (2) a mean weight within $1,0 \pm 0,2$ g at NF stage 62 in controls is recommended.

Juvenile feeding

34. Once metamorphosis is complete, the feeding regime consists of premium sinking frog food, e.g., Sinking Frog Food -3/32 (Xenopus Express, FL, USA) (Appendix 4). For froglets (early juveniles), the pellets are briefly run in a coffee grinder, blender or crushed with a mortar and pestle in order to reduce their size. Once juveniles are large enough to consume full pellets, grinding or crushing is no longer necessary. The animals should be fed once per day. The juvenile feeding should allow appropriate growth and development of the organisms: a mean weight within $11,5 \pm 3$ g in control juveniles at the termination of the assay is recommended.

Analytical chemistry

35. Prior to initiation of the assay, the stability of the test chemical (e.g., solubility, degradability, and volatility) and all analytical methods needed should be established e.g., using existing information or knowledge. When dosing via the dilution water, it is recommended that test solutions from each replicate tank be analysed prior to test initiation to verify system performance. During the exposure period, the concentrations of the test chemical are determined at appropriate intervals, preferably every week for at least one replicate in each treatment group, rotating between replicates of the same treatment group every week. It is recommended that results be based on measured concentrations. However, if concentration of the test chemical in solution has been satisfactorily maintained within ± 20 % of the nominal concentration throughout the test, then the results can either be based on nominal or measured values. Also, the coefficient of variation (CV) of the measured test concentrations over the entire test period within a treatment should be maintained at 20 % or less in each concentration. When the measured concentrations do not remain within 80-120 % of the nominal concentration (for example, when testing highly biodegradable or adsorptive chemicals), the effect concentrations should be determined and expressed relative to the arithmetic mean concentration for flow-through tests.

▼M8

36. The flow rates of dilution water and stock solution should be checked at appropriate intervals (*e.g.* three times a week) throughout the exposure duration. In the case of chemicals which cannot be detected at some or all of the nominal concentrations, (*e.g.*, due to rapid degradation or adsorption in the test vessels, or by marked chemical accumulation in the bodies of exposed animals), it is recommended that the renewal rate of the test solution in each chamber be adapted to maintain test concentrations as constant as possible.

Observations and endpoint measurements

37. The endpoints evaluated during the course of the exposure are those indicative of toxicity including mortality, abnormal behaviour such as clinical signs of disease and/or general toxicities, and growth determinations (length and weight), as well as pathology endpoints which may respond to both general toxicity and endocrine modes of action targeting oestrogen-, androgen-, or thyroid-mediated pathways. In addition, plasma VTG concentration may be optionally measured at the termination of the assay. Measurement of VTG may be useful in understanding study results in the context of endocrine mechanisms for suspected EDCs. The endpoints and timing of measurements are summarised in Table 1.

*Table 1***Endpoint overview of the LAGDA**

Endpoints (*)	Daily	Interim Sampling (Larval sampling)	Test Termination (Juvenile sampling)
Mortality and abnormalities	X		
Time to NF stage 62		X	
Histo(patho)logy (thyroid gland)		X	
Morphometrics (growth in weight and length)		X	X
Liver-somatic index (LSI)			X
Genetic/phenotypic sex ratios			X
Histopathology (gonads, reproductive ducts, kidney and liver)			X
Vitellogenin (VTG) (optional)			X

(*) All endpoints are analysed statistically.

Mortality and daily observations

38. All test tanks should be checked daily for dead animals and mortalities recorded for each tank. Dead animals should be removed from the test tank as soon as observed. The developmental stage of dead animals should be categorised as either pre-NF stage 58 (pre-forelimb emergence), NF stage 58-NF stage 62, NF stage 63-NF stage 66 (between NF stage 62 and complete tail absorption), or post-NF stage 66 (post-larval). Mortality rates exceeding 20 % may indicate inappropriate test conditions or overtly

▼ **M8**

toxic effects of the test chemical. The animals tend to be most sensitive to non-chemical induced mortality events during the first few days of development after the spawning event and during metamorphic climax. Such mortality could be apparent from the control data.

39. In addition, any observation of abnormal behaviour, grossly visible malformations (e.g., scoliosis), or lesions should be recorded. Observations of scoliosis should be counted (incidence) and graded with respect to severity (e.g., not remarkable – NR, minimal – 1, moderate – 2, severe – 3; Appendix 8). Efforts should be made to ensure that the prevalence of moderate and severe scoliosis is limited (e.g., below 10 % in controls) throughout the study, although greater prevalence of control abnormalities would not necessarily be a reason for stopping the test. Normal behaviour for larval animals is characterised by suspension in the water column with tail elevated above the head, regular rhythmic tail fin beating, periodic surfacing, operculating, and being responsive to stimuli. Abnormal behaviours would include, for example, floating on the surface, lying on the bottom of the tank, inverted or irregular swimming, lack of surfacing activity, and being nonresponsive to stimuli. For post-metamorphic animals, in addition to the above abnormal behaviours, gross differences in food consumption between treatments should be recorded. Gross malformations and lesions could include morphological abnormalities (e.g., limb deformities), haemorrhagic lesions, abdominal oedema, and bacterial or fungal infections, to name a few. The occurrences of lesions on the head of juveniles, just posterior to the nostrils, may be indications of insufficient humidity levels. These determinations are qualitative and should be considered akin to clinical signs of disease/stress and made in comparison to control animals. If the rate of occurrence is greater in exposed tanks than in the controls, then these should be considered as evidence for overt toxicity.

Larval sub-sampling

Outline of larval sub-sampling:

40. The tadpoles that have reached NF stage 62 should be removed from the tanks and either sampled or moved to the next part of the exposure in a new tank, or physically separated from the remaining tadpoles in the same tank with a divider. Tadpoles are checked daily, and the study day on which an individual tadpole reaches NF stage 62 is recorded. The defining characteristic for use in this assessment is the shape of the head. Once the head has become reduced in size such that it is visually approximately the same width as the trunk of the tadpole and forelimbs at the level of the middle of the heart, then that individual would be counted as having attained NF stage 62.
41. The goal is to sample a total of five NF stage 62 tadpoles per replicate tank. This should be performed entirely at random, but decided *a priori*. A hypothetical example of a replicate tank is provided in **Figure 1**. Should there be 20 surviving tadpoles in a particular tank when the first individual reaches NF stage 62, five random numbers should be chosen from 1-20. Tadpole #1 is the first individual to reach NF stage 62 and tadpole #20 is the last individual in a tank to reach NF stage 62. Likewise, if there are 18 surviving larvae in a tank, five random numbers should be chosen from 1-18. This should be performed for every replicate tank when the first individual on test reaches NF stage 62. If there are mortalities during the NF stage 62 sampling, the remaining samples need to be re-randomised based on how many larvae are left <NF stage 62 and how many more samples are needed to reach a total of five samples from that replicate. On the day a tadpole reaches NF stage 62, reference to the prepared sampling chart is made to determine whether that individual is sampled or physically separated

▼ **M8**

from the remaining tadpoles for continued exposure. In the example provided (Figure 1), the first individual to reach NF stage 62 (i.e. box #1) is physically separated from the other larvae, continues exposure and the study day on which that individual reached NF stage 62 is recorded. Subsequently, individuals #2 and #3 are treated the same way as #1 and then individual #4 is sampled for growth and thyroid histology (according to this example). This procedure continues until the 20th individual either joins the rest of the post-NF stage 62 individuals or is sampled. The random procedure used must give each organism on test equal probability of being selected. This can be achieved by using any randomising method, but also requires that each tadpole be netted at some point throughout the NF stage 62 sub-sampling period.

Figure 1

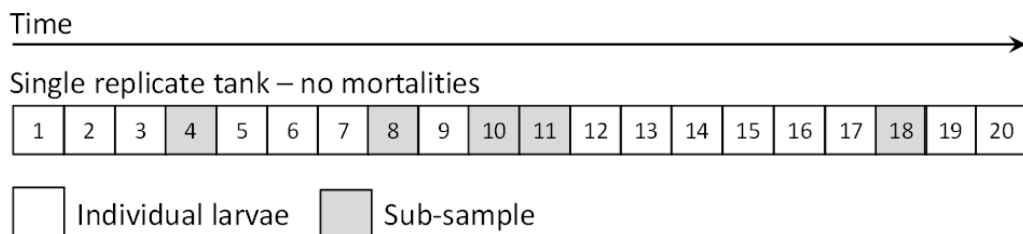
Hypothetical example of NF stage 62 sampling regime for a single replicate tank

42. For the larval sub-sampling, the endpoints obtained are: (1) time to NF stage 62 (i.e., number of days between fertilisation and NF stage 62), (2) external abnormalities, (3) morphometrics (e.g., weight and length) and (4) thyroid histology.

Humane killing of tadpoles

43. The sub-sample of NF stage 62 tadpoles (5 individuals per replicate) should be euthanised by immersion for 30 minutes in appropriate amounts (e.g., 500 ml) of anaesthetic solution (e.g., 0,3 % solution of MS-222, tricaine methane sulfonate, CAS.886-86-2). MS-222 solution should be buffered with sodium bicarbonate to a pH of approximately 7,0 because unbuffered MS-222 solution is acidic and irritating to frog skin resulting in poor absorption and unnecessary additional stress to the organisms.
44. Using a mesh dip net, a tadpole is removed from the experimental chamber and transported (placed) into the euthanasia solution. The animal is properly euthanised and is ready for necropsy when it is unresponsive to external stimuli such as pinching the hind limb with a pair of forceps.

Morphometrics (weight and length)

45. Measurements of wet weight (nearest mg) and snout-to-vent length (SVL) (nearest 0,1 mm) for each tadpole should be made immediately after it becomes non-responsive by anaesthesia (Figure 2a). Image analysis software may be used to measure SVL from a photograph. Tadpoles should be blotted dry before weighing to remove excess adherent water.

▼ **M8**

After measurements of body size (weight and SVL) are made, any gross morphological abnormalities and/or clinical signs of toxicity such as scoliosis (see Appendix 8), petechiae and haemorrhage should be recorded or noted, and digital documentation is recommended. Note that petechiae are small red or purple haemorrhages in skin capillaries.

Tissue Collection and Fixation

46. For the larval sub-sample, thyroid glands are assessed for histology. The lower torso posterior to the forelimbs is removed and discarded. The trimmed carcass is fixed in Davidson's fixative. The volume of fixative in the container should be at least 10 times the approximate volume of the tissues. Appropriate agitation or circulation of the fixative should be achieved to adequately fix the tissues of interest. All tissues remain in Davidson's fixative for at least 48 hours, but no longer than 96 hours, at which time they are rinsed in deionised water and stored in 10 % neutral buffered formalin (1) (29).

Thyroid histology

47. Each larval sub-sample (tissues fixed) is histologically assessed for thyroid glands, i.e., diagnosis and severity grading (29) (30).

a. Larval sub-sampling (NF stage 62)**b. Juvenile sampling**

Figure 2: Landmarks for measuring snout-vent length for the LAGDA in NF Stage 62 (a) and juvenile frogs (b). The defining characteristics of NF stage 62 (a): the head is the same width as the trunk, the olfactory nerve length is shorter than the diameter of the olfactory bulb (dorsal view), and the forelimbs are at the level of the heart (ventral view). Images adapted from Nieuwkoop and Faber (1994).

End of larval exposure

48. Given the initial number of tadpoles, it is expected that there will likely be a small percentage of individuals that do not develop normally and do not complete metamorphosis (NF stage 66) in a reasonable amount of time. The

▼M8

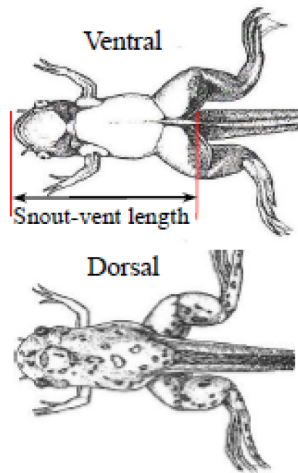
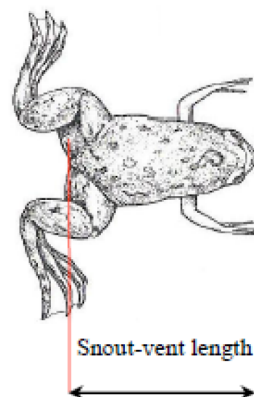
larval portion of the exposure should not exceed 70 days. Any tadpoles remaining at the end of this period should be euthanised (see para. 43), their wet weight and SVL measured, staged according to Nieuwkoop and Faber, 1994, and any developmental abnormalities noted.

Cull after NF stage 66

49. Ten individuals per tank should continue from NF stage 66 (complete tail resorption) until termination of the exposure. Therefore, after all animals have reached NF stage 66 or after 70 days (whichever occurs first), a cull should be conducted. Post NF stage 66 animals that will not continue the exposure should be selected at random.

50. Animals that are not selected for continued exposure are euthanised (see para. 43). Measurements of developmental stage, wet weight and SVL (Figure 2b) and a gross necropsy are conducted for each animal. The phenotypic sex (based on gonad morphology) is noted as female, male, or indeterminate.

Juvenile Sampling*Outline of juvenile sampling*

51. The remaining animals continue exposure until 10 weeks after the median time to NF stage 62 in the dilution water (and/or solvent control if relevant) control. At the end of the exposure period, the remaining animals (maximum 10 frogs per replicate) are euthanised, and the various endpoints are measured or evaluated and recorded: (1) morphometrics (weight and length), (2) phenotypic/genotypic sex ratios, (3) liver weight (Liver-Somatic Index), (4) histopathology (gonads, reproductive ducts, liver and kidney) and optionally (5) plasma VTG.

Humane killing of frogs

52. The juvenile samples, post-metamorphic frogs, are euthanised by an intraperitoneal injection of anaesthetic, *e.g.*, 10 % MS-222 in an appropriate phosphate buffered solution. Frogs may be sampled after becoming unresponsive (usually around 2 min after injection, if 10 % MS-222 is used in a dosage of 0,01 ml per g of frog). While the juvenile frogs could be immersed in a higher concentration of anaesthetic (MS-222), experience has shown that it takes longer for them to be anaesthetised using this method and the duration may not be adequate to allow for sampling. Injection provides efficient, fast euthanasia prior to sampling. Sampling should not be started until lack of responsiveness of the frogs has been confirmed to ensure that the animals are dead. If frogs are showing signs of considerable suffering (very severe and death can be reliably predicted) and considered moribund, animals should be anaesthetised and euthanised and treated as mortality for data analysis. When a frog is euthanised due to morbidity, this should be noted and reported. Depending on when the frog is euthanised during the study, retaining the frog for histopathology analysis may be conducted (fixing the frog for possible histopathology).

Morphometrics (weight and length)

53. Measurements of wet weight and SVL (Figure 2b) are identical to those outlined for the larval sub-sampling.

▼ **M8***Plasma VTG (option)*

54. VTG is a widely accepted biomarker resulting from exposure to oestrogenic chemicals. For the LAGDA, plasma VTG optionally may be measured within juvenile samples (this may be particularly relevant if the test chemical is suspected of being an oestrogen).
55. The euthanised juvenile hind limbs are cut and blood is collected with a heparinised capillary (although alternative blood collection methods, such as cardiac puncture, may be suitable). The blood is expelled into a microcentrifuge tube (*e.g.*, 1,5 ml volume) and centrifuged to obtain plasma. The plasma samples should be stored at -70 °C or below until VTG determination. Plasma VTG concentration can be measured by an enzyme-linked immunosorbent assay (ELISA) method (Appendix 6), or by an alternative method such as mass spectrometry (31). Species specific antibodies are preferred due to greater sensitivity.

Genetic sex determination

56. The genetic sex of each juvenile frog is assessed based on the markers developed by Yoshimoto *et al.* (11). To determine the genetic sex, a portion (or whole) of one hind limb (or any other tissue) removed during dissection is collected and stored in a microcentrifuge tube (tissue samples from frogs can be obtained from any tissue). Tissue can be stored at -20°C or below until isolation of deoxyribose nucleic acid (DNA). The isolation of DNA from tissues can be performed with commercially available kits and analysis for presence or absence of the marker is done by a polymerase chain reaction (PCR) method (Appendix 5). Generally, the concordance between histological sex and genotype across control animals at the juvenile sampling time point in control groups is more than 95 %.

Tissue collection and fixation for histopathology

57. Gonads, reproductive ducts, kidneys and livers are collected for histological analysis during the final sampling. The abdominal cavity is opened, and the liver is dissected out and weighed. Next, the digestive organs (*e.g.*, stomach, intestines) are carefully removed from the lower abdomen to reveal the gonads, kidneys and reproductive ducts. Any gross morphological abnormalities in the gonads should be noted. Finally, the hind limbs should be removed if they have not previously been removed for blood collection. Collected livers and the carcass with the gonads left *in situ* should be immediately placed into Davidson's fixative. The volume of fixative in the container should be at least 10 times the approximate volume of the tissues. All tissues remain in Davidson's fixative for at least 48 hours, but no longer than 96 hours at which time they are rinsed in de-ionised water and stored in 10 % neutral buffered formalin (1) (29).

Histopathology

58. Each juvenile sample is evaluated histologically for pathology in the gonads, reproductive ducts, kidneys and liver tissue, *i.e.*, diagnosis and severity grading (32). The gonad phenotype is also derived from this evaluation (*e.g.*, ovary, testis, intersex), and together with individual genetic sex measurements, these observations can be used to calculate phenotypic/genotypic sex ratios.

▼ M8

DATA AND REPORTING

Statistical analysis

59. The LAGDA generates three forms of data to be statistically analysed: (1) quantitative continuous data (weight, SVL, LSI, VTG), (2) time-to-event data for developmental rates (i.e., days to NF stage 62 from assay initiation) and (3) ordinal data in the form of severity scores or developmental stages from histopathology evaluations.

60. It is recommended that the test design and selection of statistical test permit adequate power to detect changes of biological importance in endpoints where a NOEC or EC_x is to be reported. Statistical analyses of the data (generally, replicate mean basis) should preferably follow procedures described in the document Current Approaches in the Statistical Analysis of Ecotoxicity Data: A Guidance to Application (33). Appendix 7 of this test method provides the recommended statistical analysis decision tree and guidance for the treatment of data and in the choice of the most appropriate statistical test or model to use in the LAGDA.

61. The data from juvenile sampling (e.g., growth, LSI) should be analysed for each genotypic sex separately since genotypic sex is determined for all frogs.

Data analysis considerations*Use of compromised replicates and treatments*

62. Replicates and treatments may become compromised due to excess mortality from overt toxicity, disease, or technical error. If a treatment is compromised from disease or technical error, there should be three uncompromised treatments with three uncompromised replicates available for analysis. If overt toxicity occurs in the high treatment(s), it is preferable that at least three treatment levels with three uncompromised replicates are available for analysis (consistent with the Maximum Tolerated Concentration approach for OECD test guidelines (34)). In addition to mortality, signs of overt toxicity may include behavioural effects (e.g. floating on the surface, lying on the bottom of the tank, inverted or irregular swimming, lack of surfacing activity), morphological lesions (e.g. haemorrhagic lesions, abdominal oedema) or inhibition of normal feeding responses when compared qualitatively to control animals.

Solvent control

63. At the termination of the test, an evaluation of the potential effects of the solvent (if used) should be performed. This is done through a statistical comparison of the solvent control group and the dilution water control group. The most relevant endpoints for consideration in this analysis are growth determinants (weight and length), as these can be affected through generalised toxicities. If statistically significant differences are detected in these endpoints between the dilution water control and solvent control groups, best professional judgment should be used to determine if the validity of the test is compromised. If the two controls differ, the treatments exposed to the chemical should be compared to the solvent control unless it is known that comparison to the dilution water control is preferred. If there is no statistically significant difference between the two control groups it is recommended that the treatments exposed to the test chemical are compared with the pooled (solvent and dilution water control groups), unless it is known that comparison to either the dilution-water or solvent control group only is preferred.

▼M8**Test report**

64. The test report should include the following:

Test chemical:

- Physical nature and, where relevant, physicochemical properties;
- Mono-constituent substance:
 - physical appearance, water solubility, and additional relevant physicochemical properties;
 - chemical identification, such as IUPAC or CAS name, CAS number, SMILES or InChI code, structural formula, purity, chemical identity of impurities as appropriate and practically feasible, etc. (including the organic carbon content, if appropriate).
- Multi-constituent substance, UVCBs and mixtures:
 - characterised as far as possible by chemical identity (see above), quantitative occurrence and relevant physicochemical properties of the constituents.

Test species:

- Scientific name, strain if available, source and method of collection of the fertilised eggs and subsequent handling.
- Incidence of scoliosis in historical controls for the stock culture used.

Test conditions:

- Photoperiod(s);
- Test design (*e.g.*, chamber size, material and water volume, number of test chambers and replicates, number of test organisms per replicate);
- Method of preparation of stock solutions and frequency of renewal (the solubilising agent and its concentration should be given, when used);
- Method of dosing the test chemical (*e.g.*, pumps, diluting systems);
- The recovery efficiency of the method and the nominal test concentrations, the limit of quantification, the means of the measured values and their standard deviations in the test vessels and the method by which these were attained and evidence that the measurements refer to the concentrations of the test chemical in true solution;
- Dilution water characteristics: pH, hardness, temperature, dissolved oxygen concentration, residual chlorine levels (if measured), total iodine, total organic carbon (if measured), suspended solids (if measured), salinity of the test medium (if measured) and any other measurements made;
- The nominal test concentrations, the means of the measured values and their standard deviations;
- Water quality within test vessels, pH, temperature (daily) and dissolved oxygen concentration;

▼ M8

- Detailed information on feeding (*e.g.*, type of foods, source, amount given and frequency).

Results:

- Evidence that controls met the validity criteria;
 - Data for the control (plus solvent control when used) and the treatment groups as follows: mortality and abnormality observed, time to NF stage 62, thyroid histology assessment (larval sample only), growth (weight and length), LSI (juvenile sample only), genetic/phenotypic sex ratios (juvenile sample only), histopathology assessment results for gonads, reproductive ducts, kidney and liver (juvenile sample only) and plasma VTG (juvenile sample only, if performed);
 - Approach for the statistical analysis and treatment of data (statistical test or model used);
 - No observed effect concentration (NOEC) for each response assessed;
 - Lowest observed effect concentration (LOEC) for each response assessed (at $\alpha = 0,05$); EC_x for each response assessed, if applicable, and confidence intervals (*e.g.*, 95 %) and a graph of the fitted model used for its calculation, the slope of the concentration-response curve, the formula of the regression model, the estimated model parameters and their standard errors.
 - Any deviation from the test method and deviations from the acceptance criteria, and considerations of potential consequences on the outcome of the test.
65. For the results of endpoint measurements, mean values and their standard deviations (on both replicate and concentration basis, if possible) should be presented.
66. Median time to NF stage 62 in controls should be calculated and presented as the mean of replicate medians and their standard deviation. Likewise, for treatments, a treatment median should be calculated and presented as the mean of replicate medians and their standard deviation.

LITERATURE

- (1) U.S. Environmental Protection Agency (2013). Validation of the Larval Amphibian Growth and Development Assay: Integrated Summary Report.
- (2) OECD (2012a). Guidance Document on Standardised Test Guidelines for Evaluating Endocrine Disrupters. Environment, Health and Safety Publications, Series on testing and assessment (No 150) Organisation for Economic Cooperation and Development, Paris.
- (3) Nieuwkoop PD and Faber J. (1994). Normal Table of *Xenopus laevis* (Daudin). Garland Publishing, Inc, New York, NY, USA.
- (4) Kloas W and Lutz I. (2006). Amphibians as Model to Study Endocrine Disrupters. Journal of Chromatography A 1 130: 16-27.

▼ **M8**

- (5) Chang C, Witschi E. (1956). Genic Control and Hormonal Reversal of Sex Differentiation in *Xenopus*. Journal of the Royal Society of Medicine 93: 140-144.
- (6) Gallien L. (1953). Total Inversion of Sex in *Xenopus laevis* Daud, Following Treatment with Estradiol Benzoate Administered During Larval Stage. Comptes Rendus Hebdomadaires des Séances de l'Académie des Sciences 237: 1 565.
- (7) Villalpando I and Merchant-Larios H. (1990). Determination of the Sensitive Stages for Gonadal Sex-Reversal in *Xenopus Laevis* Tadpoles. International Journal of Developmental Biology 34: 281-285.
- (8) Miyata S, Koike S and Kubo T. (1999). Hormonal Reversal and the Genetic Control of Sex Differentiation in *Xenopus*. Zoological Science 16: 335-340.
- (9) Mikamo K and Witschi E. (1963). Functional Sex-Reversal in Genetic Females of *Xenopus laevis*, Induced by Implanted Testes. Genetics 48: 1 411.
- (10) Olmstead AW, Kosian PA, Korte JJ, Holcombe GW, Woodis K and Degitz SJ. (2009)a. Sex reversal of the Amphibian, *Xenopus tropicalis*, Following Larval Exposure to an Aromatase Inhibitor. Aquatic Toxicology 91: 143-150.
- (11) Yoshimoto S, Okada E, Umemoto H, Tamura K, Uno Y, Nishida-Umehara C, Matsuda Y, Takamatsu N, Shiba T and Ito M. (2008). A W-linked DM-Domain Gene, DM-W, Participates in Primary Ovary Development in *Xenopus Laevis*. Proceedings of the National Academy of Sciences of the United States of America 105: 2 469-2 474.
- (12) Olmstead AW, Korte JJ, Woodis KK, Bennett BA, Ostazeski S and Degitz SJ. (2009)b. Reproductive Maturation of the Tropical Clawed Frog: *Xenopus tropicalis*. General and Comparative Endocrinology 160: 117-123.
- (13) Tobias ML, Tomasson J and Kelley DB. (1998). Attaining and Maintaining Strong Vocal Synapses in Female *Xenopus laevis*. Journal of Neurobiology 37: 441-448.
- (14) Qin ZF, Qin XF, Yang L, Li HT, Zhao XR and Xu XB. (2007). Feminizing/Demasculinizing Effects of Polychlorinated Biphenyls on the Secondary Sexual Development of *Xenopus Laevis*. Aquatic Toxicology 84: 321-327.
- (15) Porter KL, Olmstead AW, Kumsher DM, Dennis WE, Sprando RL, Holcombe GW, Korte JJ, Lindberg-Livingston A and Degitz SJ. (2011). Effects of 4-*Tert*-Octylphenol on *Xenopus Tropicalis* in a Long Term Exposure. Aquatic Toxicology 103: 159-169.
- (16) ASTM. (2002). Standard Guide for Conducting Acute Toxicity Tests on Test Materials with Fishes, Macroinvertebrates, and Amphibians. ASTM E729-96, Philadelphia, PA, USA.
- (17) Chapter C.4 of this Annex, Ready Biodegradability Test.
- (18) Chapter C.29 of this Annex, Ready Biodegradability - CO₂ in sealed vessels (Headspace Test).
- (19) Kahl MD, Russom CL, DeFoe DL and Hammermeister DE (1999). Saturation Units for Use in Aquatic Bioassays. Chemosphere 39: 539-551.

▼M8

- (20) Adolfsson-Erici M, Åkerman G, Jahnke A, Mayer P, McLachlan MS (2012). A flow-through passive dosing system for continuously supplying aqueous solutions of hydrophobic chemicals to bioconcentration and aquatic toxicity tests. *Chemosphere*, 86(6): 593-9.
- (21) OECD (2000). Guidance Document on Aquatic Toxicity Testing of Difficult Substances and Mixtures. Environment, Health and Safety Publications, Series on testing and assessment (No 23), Organisation for Economic Cooperation and Development, Paris.
- (22) Hutchinson TH, Shillabeer N, Winter MJ and Pickford DB. (2006). Acute and Chronic Effects of Carrier Solvents in Aquatic Organisms: A Critical Review. *Review. Aquatic Toxicology* 76: 69–92.
- (23) ASTM (2004). Standard Guide for Conducting the Frog Embryo Teratogenesis Assay - *Xenopus* (FETAX). ASTM E1439 - 98, Philadelphia, PA, USA.
- (24) Read BT (2005). Guidance on the Housing and Care of the African Clawed Frog *Xenopus Laevis*. Royal Society for the Prevention of Cruelty to Animals (RSPCA), Horsham, Sussex, U.K., 84 pp.
- (25) Chapter C.38 of this Annex, Amphibian Metamorphosis Assay.
- (26) Chapter C.48 of this Annex, Fish Short Term Reproduction Assay.
- (27) Chapter C.41 of this Annex, Fish Sexual Development Test.
- (28) Chapter C.49 of this Annex, Fish Embryo Acute Toxicity (FET) Test.
- (29) OECD (2007). Guidance Document on Amphibian Thyroid Histology. Environment, Health and Safety Publications, Series on Testing and Assessment. (No 82) Organisation for Economic Cooperation and Development, Paris.
- (30) Grim KC, Wolfe M, Braunbeck T, Iguchi T, Ohta Y, Tooi O, Touart L, Wolf DC and Tietge J. (2009). Thyroid Histopathology Assessments for the Amphibian Metamorphosis Assay to Detect Thyroid-Active Substances, *Toxicological Pathology* 37: 415-424.
- (31) Luna LG and Coady K.(2014). Identification of *X. laevis* Vitellogenin Peptide Biomarkers for Quantification by Liquid Chromatography Tandem Mass Spectrometry. *Analytical and Bioanalytical Techniques* 5(3): 194.
- (32) OECD (2015). Guidance on histopathology techniques and evaluation. Environment, Health and Safety Publications, Series on Testing and Assessment (No 228), Organisation for Economic Cooperation and Development, Paris.
- (33) OECD (2006). Current Approaches in the Statistical Analysis of Ecotoxicity Data: A Guidance to Application. Environment, Health and Safety Publications, Series on testing and assessment (No 54), Organisation for Economic Cooperation and Development, Paris.
- (34) Hutchinson TH, Bögi C, Winter MJ, Owens JW, 2009. Benefits of the Maximum Tolerated Dose (MTD) and Maximum Tolerated concentration (MTC) Concept in Aquatic Toxicology. *Aquatic Toxicology* 91(3): 197-202.

▼M8*Appendix 1*

DEFINITIONS

Apical endpoint: Causing effect at population level.

Chemical: A substance or a mixture

ELISA: Enzyme-Linked Immunosorbent Assay

EC_x: (Effect concentration for x % effect) is the concentration that causes an x % of an effect on test organisms within a given exposure period when compared with a control. For example, an EC₅₀ is a concentration estimated to cause an effect on a test end point in 50 % of an exposed population over a defined exposure period.

dpf: Days post fertilization

Flow-through test: A test with continued flow of test solutions through the test system during the duration of exposure.

HPG axis: hypothalamic-pituitary-gonadal axis

IUPAC: International Union of Pure and Applied Chemistry.

Lowest observed effect concentration (LOEC): is the lowest tested concentration of a test chemical at which the chemical is observed to have a statistically significant effect (at $p < 0.05$) when compared with the control. However, all test concentrations above the LOEC should have a harmful effect equal to or greater than those observed at the LOEC. When these two conditions cannot be satisfied, a full explanation should be given for how the LOEC (and hence the NOEC) has been selected. Appendix 7 provides guidance.

Median Lethal Concentration (LC₅₀): is the concentration of a test chemical that is estimated to be lethal to 50 % of the test organisms within the test duration.

No observed effect concentration (NOEC): is the test concentration immediately below the LOEC, which when compared with the control, has no statistically significant effect ($p < 0.05$), within a stated exposure period.

SMILES: Simplified Molecular Input Line Entry Specification.

Test chemical: Any substance or mixture tested using this Test Method.

UVCB: Substances of unknown or variable composition, complex reaction products or biological materials.

VTG: Vitellogenin is a phospholipoglycoprotein precursor to egg yolk protein that normally occurs in sexually active females of all oviparous species.

▼ **M8***Appendix 2*

SOME CHEMICAL CHARACTERISTICS OF AN ACCEPTABLE DILUTION WATER

Substance	Limit concentration
Particulate matter	5 mg/l
Total organic carbon	2 mg/l
Un-ionised ammonia	1 µg/l
Residual chlorine	10 µg/l
Total organophosphorous pesticides	50 ng/l
Total organochlorine pesticides plus polychlorinated biphenyls	50 ng/l
Total organic chlorine	25 ng/l
Aluminium	1 µg/l
Arsenic	1 µg/l
Chromium	1 µg/l
Cobalt	1 µg/l
Copper	1 µg/l
Iron	1 µg/l
lead	1 µg/l
Nickel	1 µg/l
Zinc	1 µg/l
Cadmium	100 ng/l
Mercury	100 ng/l
Silver	100 ng/l

▼ **M8***Appendix 3*

TEST CONDITIONS FOR THE LAGDA

1. Test species	<i>Xenopus laevis</i>
2. Test type	Continuous flow-through,
3. Water temperature	The nominal temperature is 21 °C. The mean temperature over the duration of the test is 21 ± 1 °C (the inter-replicate and the inter-treatment differentials should not exceed 1,0 °C)
4. Illumination quality	Fluorescent bulbs (wide spectrum) 600-2000 lux (lumens/m ²) at the water surface
5. Photoperiod	12 h light:12 h dark
6. Test solution volume and test vessel (tank)	4-10 l (minimum 10–15 cm water depth) Glass or stainless steel tank
7. Volume exchanges of test solutions	Constant, in consideration of both the maintenance of biological conditions and chemical exposure (e.g., 5 tank volume renewal per day)
8. Age of test organisms at initiation	Nieuwkoop and Faber (NF) stage 8-10
9. Number. of organisms per replicate	20 animals (embryos)/tank (replicate) at exposure initiation and 10 animals (juveniles)/tank (replicate) after NF stage 66 to exposure termination
10. Number of treatments	Minimum 4 test chemical treatments plus appropriate control(s)
11. Number of replicates per treatment	4 replicates per treatment for test chemical and 8 replicates for control(s)
12. Number of organisms per test concentration	Minimum 80 animals per treatment for test chemical and minimum 160 animals for control(s)
13. Dilution water	Any water that permits normal growth and development of <i>X. laevis</i> (e.g., spring water or charcoal-filtered tap water)
14. Aeration	None required, but aeration of the tanks may be necessary if dissolved oxygen levels drop below recommended limits and increases in flow of test solution is maximised.
15. Dissolved oxygen of test solution	Dissolved oxygen: ≥ 40 % of air saturation value or $\geq 3,5$ mg/l

▼M8

16. pH of test solution	6.5-8.5 (the inter-replicate and the inter-treatment differentials should not exceed 0,5)
17. Hardness and alkalinity of test solution	10-250 mg CaCO ₃ /l
18. Feeding regime	(See Appendix 4)
19. Exposure period	From NF stage 8-10 to ten weeks after the median time to NF stage 62 in water and/or solvent control group (maximum 17 weeks)
20. Biological endpoints	Mortality (and abnormal appearances), time to NF stage 62 (larval sample), thyroid histology assessment (larval sample), growth (weight and length), liver-somatic index (juvenile sample), genetic/phenotypic sex ratios (juvenile sample), histopathology for gonads, reproductive ducts, kidney and liver (juvenile sample) and plasma vitellogenin (juvenile sample, optional)
21. Test validity criteria	Dissolved oxygen should be > 40 % air saturation value; mean water temperature should be 21 ± 1 °C and the inter-replicate and -treatment differentials should be < 1.0 °C; pH of test solution should be ranged between 6,5 and 8.5; the mortality in control should be ≤ 20 % in each replicate, and the mean time to NF stage 62 in control should be ≤ 45 days; the mean weight of test organisms at NF stage 62 and at the termination of the assay in controls and solvent controls (if used) should reach 1,0 ± 0,2 and 11,5 ± 3 g, respectively; evidence should be available to demonstrate that the concentrations of the test chemical in solution have been satisfactorily maintained within ± 20 % of the mean measured values.

▼ **M8***Appendix 4*

FEEDING REGIME

It should be noted that although this feeding regime is recommended, alternatives are permissible providing the test organisms grow and develop at an appropriate rate.

Larval feeding*Preparation for larval diet*

A. 1:1 (v/v) Trout Starter: algae/TetraFin® (or equivalent);

1. Trout Starter: blend 50 g of Trout Starter (fine granules or powder) and 300 ml of suitable filtered water on a high blender setting for 20 seconds
2. Algae/TetraFin® (or equivalent) mixture: blend 12 g spirulina algae disks and 500 ml filtered water on a high blender setting for 40 seconds, blend 12 g Tetrafin® (or equivalent) with 500 ml filtered water and then combine these to make up 1 l of 12 g/l spirulina algae and 12 g/l Tetrafin® (or equivalent)
3. Combine equal volumes of the blended Trout Starter and the algae/TetraFin® (or equivalent) mixture

B. Brine shrimp:

15 ml brine shrimp eggs are hatched in 1 l of salt water (prepared by adding 20 ml of NaCl to 1 l deionised water). After aerating 24 hours at room temperature under constant light, the brine shrimp are harvested. Briefly, the brine shrimp are allowed to settle for 30 min by stopping aeration. Cysts that float to the top of the canister are poured off and discarded, and the shrimp are poured through the appropriate filters and brought up to 30 ml with filtered water.

Feeding Protocol

Table 1 provides a reference regarding the type and amount of feed used during the larval stages of the exposure. The animals should be fed three times per day Monday through Friday and once per day on the weekends.

Table 1

Feeding regime for *X. laevis* larvae in flow-through conditions

Time (*) (Post Fertilisation)	Trout Starter: algae/TetraFin® (or equivalent)		Brine Shrimp	
	Weekday (3 times per day)	Weekend (once per day)	Weekday (twice per day)	Weekend (once per day)
Days 4-14 (in Weeks 0-1)	0,33 ml	1,2 ml	0.5 ml (from Day 8 to 15) 1 ml (from Day 16)	0.5 ml (from Day 8 to 15) 1 ml (from Day 16)
Week 2	0,67 ml	2,4 ml		
Week 3	1,3 ml	4,0 ml	1 ml	1 ml
Week 4	1,5 ml	4,0 ml	1 ml	1 ml
Week 5	1,6 ml	4,4 ml	1 ml	1 ml

▼ **M8**

Time (*) (Post Fertilisation)	Trout Starter: algae/TetraFin® (or equivalent)		Brine Shrimp	
	Weekday (3 times per day)	Weekend (once per day)	Weekday (twice per day)	Weekend (once per day)
Week 6	1,6 ml	4,6 ml	1 ml	1 ml
Week 7	1,7 ml	4,6 ml	1 ml	1 ml
Weeks 8-10	1,7 ml	4,6 ml	1 ml	1 ml

(*) Day 0 is defined as the day hCG injection is done.

Larval to juvenile diet transition

As larvae complete metamorphosis, they transition to a juvenile diet formulation explained below. While this transition is taking place, the larval diet should be reduced as the juvenile feed increases. This can be accomplished by proportionally decreasing the larval feed while proportionally increasing the juvenile feed as each group of five tadpoles surpass NF stage 62 and approach completion of metamorphosis at NF stage 66.

Juvenile feeding*Juvenile diet*

Once metamorphosis is complete (stage 66), the feeding regime changes to 3/32 inch premium sinking frog food alone (Xenopus Express™, FL, USA), or equivalent.

Preparation of crushed pellet for larval to juvenile transition

Sinking frog food pellets are briefly run in a coffee grinder, blender or mortar and pestle in order to reduce the size of the pellets by approximately 1/3. Processing too long results in powder and is discouraged.

Feeding protocol

Table 2 provides a reference regarding the type and amount of feed used during juvenile and adult life stages. The animals should be fed once per day. It should be noted that as animals metamorphose, they continue receiving a portion of the brine shrimp until > 95 % of animals complete metamorphosis.

The animals should not be fed on the day of test termination so feed does not confound weight measurements.

Table 2

Feeding regime for *X. laevis* juveniles in flow-through conditions. It should be noted that unmetamorphosed animals, including those whose metamorphosis has been delayed by the chemical treatment, cannot eat uncrushed pellets

Time (*) (Weeks post-median metamorphosis date)	Crushed pellet (mg per froglet)	Whole pellet (mg per froglet)
As animals complete metamorphosis	25	0
Weeks 0-1	25	28

▼M8

Time (*) (Weeks post-median metamorphosis date)	Crushed pellet (mg per froglet)	Whole pellet (mg per froglet)
Weeks 2-3	0	110
Weeks 4-5	0	165
Weeks 6-9	0	220

(*) The first day of Week 0 is the median metamorphosis date in control animals.

▼ **M8***Appendix 5*

GENETIC SEX DETERMINATION (GENETIC SEXING)

The method of genetic sexing for *Xenopus laevis* is based on Yoshimoto *et al.*, 2008. Procedures in detail on the genotyping can be obtained from this publication, if needed. Alternative methods (e.g. high-throughput qPCR) may be used if considered suitable.

X. laevis primers*DM-W marker*

Forward: 5'-CCACACCCAGCTCATGTAAAG-3'

Reverse: 5'-GGGCAGAGTCACATATACTG-3'

Positive Control

Forward: 5'-AACAGGAGCCCAATTCTGAG-3'

Reverse: 5'-AACTGCTTGACCTCTAATGC-3'

DNA purification

Purify DNA from muscle or skin tissue using e.g., Qiagen DNeasy Blood and Tissue Kit (cat # 69 506) or similar product according to kit instructions. DNA can be eluted from the spin columns using less buffer to yield more concentrated samples if deemed necessary for PCR. Note that DNA is quite stable, so care should be taken to avoid cross-contamination that could lead to mischaracterisation of males as females, or vice versa.

PCR

A sample protocol using JumpStart™ Taq from Sigma is outlined in **Table 1**.

*Table 1***Sample protocol using JumpStart™ Taq from Sigma**

Master Mix	1x (µl)	[Final]
NFW (*)	11	—
10X Buffer	2,0	—
MgCl ₂ (25mM)	2,0	2,5 mM
dNTP's (10mM each)	0,4	200 µM
Marker for primer (8 µM)	0,8	0,3 µM
Marker rev primer (8 µM)	0,8	0,3 µM
Control for primer (8 µM)	0,8	0,3 µM
Control rev primer (8 µM)	0,8	0,3 µM
JumpStart™ Taq	0,4	0,05 units/µl
DNA template	1,0	~200 pg/µl

(*) Nuclease-free water

Note: When preparing Master Mixes, prepare extra to account for any loss that may occur while pipetting (example: 25x should be used for only 24 reactions).

▼M8*Reaction:*

Master Mix	19,0 µl
Template	1,0 µl
Total	20.0 µl

Thermocycler Profile:

Step 1.	94 °C	1 min
Step 2.	94 °C	30 sec
Step 3.	60 °C	30 sec
Step 4.	72 °C	1 min
Step 5.	Go to step 2.	35 cycles
Step 6.	72 °C	1 min
Step 7.	4 °C	hold

PCR products can be run immediately in a gel or stored at 4 °C.

Agarose Gel Electrophoresis (3 %)(sample protocol)*50X TAE*

Tris	24,2 g
Glacial acetic acid	5,71 ml
Na ₂ (EDTA)·2H ₂ O	3,72 g

Add water to 100 ml

1X TAE

H ₂ O	392 ml
50X TAE	8 ml

3:1 Agarose

3 parts NuSieve™ GTG™ agarose

1 part Fisher agarose low electroendosmosis (EEO)

Method

1. Prepare a 3 % gel by adding 1,2 g agarose mix to 43 ml 1X TAE. Swirl to disassociate large clumps.
2. Microwave agarose mixture until completely dissolved (avoid boiling over). Let cool slightly.
3. Add 1,0 µL ethidium bromide (10 mg/ml). Swirl flask. Note that ethidium bromide is mutagenic, so alternative chemicals should, in so far as is technically possible, be used for this step to minimise health risks to workers⁽¹⁾.
4. Pour gel into mould with comb. Cool completely.

⁽¹⁾ In accordance to Article 4.1 of Directive 2004/37/EC of the European Parliament and of the Council of 29 April 2004 on the protection of workers from the risks related to exposure to carcinogens or mutagens at work (Sixth individual Directive within the meaning of Article 16(1) of Council Directive 89/391/EEC) (OJ L 158, 30.4.2004, p. 50).

▼M8

5. Add gel to apparatus. Cover gel with 1X TAE.
6. Add 1 µl of 6x loading dye to each 10 µl PCR product.
7. Pipette samples into wells.
8. Run at 160 constant volts for ~20 minutes.

An agarose gel image showing the band patterns indicative of male and female individuals is shown in **Figure 1**.

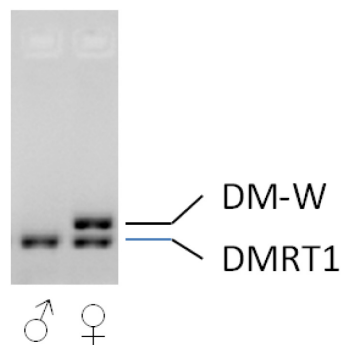

Figure 1: Agarose gel image showing the band pattern indicative of a male (♂) individual (single band ~203 bp: DMRT1) and of a female (♀) individual (two bands at ~259 bp: DM-W and 203 bp:DMRT1).

LITERATURE

Yoshimoto S, Okada E, Umemoto H, Tamura K, Uno Y, Nishida-Umehara C, Matsuda Y, Takamatsu N, Shiba T, Ito M. 2008. A W-linked DM-domain gene, DM-W, participates in primary ovary development in *Xenopus laevis*. *Proceedings of the National Academy of Sciences of the United States of America* 105: 2 469-2 474.

▼ **M8***Appendix 6*

MEASUREMENT OF VITELLOGENIN

The measurement of vitellogenin (VTG) is made using an enzyme-linked immunosorbent assay (ELISA) method which was originally developed for fathead minnow VTG (Parks *et al.*, 1999). Currently there are no commercially available antibodies for *X. laevis*. However, given the wealth of information for this protein and the availability of cost-effective commercial antibody production services, it is reasonable that laboratories can easily develop an ELISA to make this measurement (Olmstead *et al.*, 2009). Also Olmstead *et al.* (2009) provide a description of the assay as modified for VTG in *X. tropicalis*, as shown below. The method uses an antibody made against *X. tropicalis* VTG, but it is known also to work for *X. laevis* VTG. It should be noted that non-competitive ELISAs can also be used, and that these may have lower detection limits than the method described below.

Materials and Reagents

- Preadsorbed 1st Antibody (Ab) serum
- Mix 1 part anti-*X. tropicalis* VTG 1st Ab serum with 2 parts control male plasma and leave at RT for ~ 75 minutes, put on ice for 30 min, centrifuge > 20K x G for 1 hour at 4 °C, remove supernatant, aliquot, store at -20 °C.
- 2nd Antibody
- Goat Anti-Rabbit IgG-HRP conjugate (e.g., Bio-Rad 172-1019)
- VTG Standard
- purified *X. laevis* VTG at 3,3 mg/ml.
- TMB (3,3',5,5' Tetramethyl-benzidine) (e.g., KPL 50-76-00; or Sigma T0440)
- Normal Goat Serum (NGS) (e.g., Chemicon® S26-100ml)
- 96 well EIA polystyrene microtiter plates (e.g., ICN: 76-381-04, Costar: 53590, Fisher: 07-200-35)
- 37 °C hybridization oven (or fast equilibrating air incubator) for plates, water bath for tubes
- Other common laboratory equipment, chemicals, and supplies.

Recipes

Coating Buffer (50 mM Carbonate Buffer, pH 9.6):

NaHCO ₃	1,26 g
Na ₂ CO ₃	0,68 g
water	428 ml

10X PBS (0.1 M phosphate, 1,5 M NaCl):

NaH ₂ PO ₄ ·H ₂ O	0,83 g
Na ₂ HPO ₄ ·7 H ₂ O	20,1 g
NaCl	71 g
water	810 ml

▼M8*Wash Buffer (PBST):*

10X PBS	100 ml
Water	900 ml

Adjust pH to 7.3 with 1 M HCl, then add 0,5 ml Tween-20

Assay Buffer:

Normal Goat Serum (NGS)	3,75 ml
Wash Buffer	146,25 ml

Sample collection

Blood is collected with a heparinised microhematocrit tube and placed on ice. After centrifugation for 3 minutes, the tube is scored, broken open, and the plasma expelled into 0,6 ml microcentrifuge tubes which contain 0,13 units of lyophilised aprotinin. (These tubes are prepared in advance by adding the appropriate amount of aprotinin, freezing, and lyophilising in a speed-vac at low heat until dry.) Store plasma at -80 °C until analysed.

Procedure for one plate*Coating the plate*

Mix 20 µl of purified VTG with 22 ml of carbonate buffer (final 3 µg/ml). Add 200 µl to each well of a 96-well plate. Cover the plate with adhesive sealing film and allow to incubate at 37 °C for 2 hours (or 4 °C overnight).

Blocking the plate

Blocking solution is prepared by adding 2 ml of Normal Goat Serum (NGS) to 38 ml of carbonate buffer. Remove coating solution and shake dry. Add 350 µl of the blocking solution to each well. Cover with adhesive sealing film and incubate at 37 °C for 2 hours (or at 4 °C overnight).

Preparation of standards

5.8 µl of purified VTG standard is mixed with 1,5 ml of assay buffer in a 12 x 75 mm borosilicate disposable glass test tube. This yields 12 760 ng/ml. Then a serial dilution is performed by adding 750 µl of the previous dilution to 750 µl of assay buffer to yield final concentrations of 12 760, 6 380, 3 190, 1 595, 798, 399, 199, 100, and 50 ng/ml.

Preparation of Samples

Start with a 1:300 (e.g., combine 1 µl plasma with 299 µl of assay buffer) or 1:30 dilution of plasma into assay buffer. If a large amount of VTG is expected, additional or greater dilutions may be needed. Try to keep B/B₀ within the range of standards. For samples without appreciable VTG, e.g., control males and females (which are all immature), use the 1:30 dilution. Samples diluted less than this may show unwanted matrix effects.

Additionally, it is recommended to run a positive control sample on each plate. This comes from a pool of plasma containing high induced levels of VTG. The pool is initially diluted in NGS, divided in aliquots and stored at -80 C. For each plate, an aliquot is thawed, diluted further in assay buffer and run similar to a test sample.

▼M8*Incubation with 1st antibody*

The 1st Ab is prepared by making a 1:2000 dilution of preadsorbed 1st Ab serum in assay buffer (e.g., 8 µl to 16 ml of assay buffer). Combine 300 µl of 1st Ab solution with 300 µl of sample/standard in a glass tube. The B₀ tube is prepared similarly with 300 µl of assay buffer and 300 µl of antibody. Also, a NSB tube should be prepared using 600 µl of assay buffer only, i.e., no Ab. Cover the tubes with Parafilm and vortex gently to mix. Incubate in a 37 °C water bath for 1 hour.

Washing the plate

Just before the 1st Ab incubation is complete, wash the plate. This is done by shaking out the contents and patting dry on absorbent paper. Then fill wells with 350 µl of wash solution, dump out, and pat dry. A multi-channel repeater pipette or plate washer is useful here. The wash step is repeated two more times for a total of three washes.

Loading the plate

After the plate has been washed, remove the tubes from the water bath and vortex lightly. Add 200 µl from each sample, standard, B₀, and NSB tube to duplicate wells of the plate. Cover plate with adhesive sealing film and allow to incubate for 1 hour at 37 °C.

Incubation with the 2nd antibody

At the end of the incubation from the previous step, the plate should be washed three times again, like above. The diluted 2nd Ab is prepared by mixing 2,5 µl of 2nd Ab with 50 ml of assay buffer. Add 200 µl of diluted 2nd Ab to each well, seal like above, and incubate for 1 hour at 37 °C.

Addition of substrate

After the incubation with the 2nd Ab is complete, wash the plate three times as described earlier. Then add 100 µl of TMB substrate to each well. Allow the reaction to proceed for 10 minutes, preferably out of bright light. Stop the reaction by adding 100 µl of 1 M phosphoric acid. This will change the colour from blue to an intense yellow. Measure the absorbance at 450 nm using a plate reader.

Calculate B/B₀

Subtract the average NSB value from all measurements. The B/B₀ for each sample and standard is calculated by dividing the absorbance value (B) by the average absorbance of the B₀ sample.

Obtain the standard curve and determine unknown amounts

Generate a standard curve with the aid of some computer graphing software (e.g., SlidewriteTM or Sigma Plot[®]) that will extrapolate quantity from B/B₀ of sample based on B/B₀ of standards. Typically, the amount is plotted on a log scale and the curve has a sigmoid shape. However, it may appear linear when using a narrow range of standards. Correct sample amounts for dilution factor and report as mg VTG/ml of plasma.

Determination of minimum detection limits (MDL)

Often, particularly in normal males, it will not be clear how to report results from low values. In these cases, the 95 % 'Confidence limits' should be used to determine if the value should be reported as zero or as some other number. If the sample result is within the confidence interval of the zero standard (B₀), the result should be reported as zero. The minimum detection level will be the lowest

▼M8

standard which is consistently different from the zero standard; that is, the two confidence intervals don't overlap. For any sample result which is within the confidence limit of the minimum detection level, or above, the calculated value will be reported. If a sample falls between the zero standard and the minimum detection level confidence intervals, one half of the minimum detection level should be reported for the value of that sample.

LITERATURE

Olmstead AW, Korte JJ, Woodis KK, Bennett BA, Ostazeski S, Degitz SJ. 2009. Reproductive maturation of the tropical clawed frog: *Xenopus tropicalis*. *General and Comparative Endocrinology* 160: 117-123.

Parks LG, Cheek AO, Denslow ND, Heppell SA, McLachlan JA, LeBlanc GA, Sullivan CV. 1999. Fathead minnow (*Pimephales promelas*) vitellogenin: purification, characterisation and quantitative immunoassay for the detection of estrogenic compounds. *Comparative Biochemistry and Physiology Part C: Toxicology & Pharmacology* 123: 113-125.

▼ M8*Appendix 7*

STATISTICAL ANALYSIS

The LAGDA generates three forms of data to be statistically analysed: (1) Quantitative continuous data, (2) Time-to-event data for developmental rates (Time to NF stage 62) and (3) Ordinal data in the form of severity scores or developmental stages from histopathology evaluations. The recommended statistical analysis decision tree for the LAGDA is shown in Figure 1. Also, some annotations which might be needed to conduct statistical analysis for the measurements from the LAGDA are indicated below. For the analysis decision tree, the results of measurements for mortality, growth (weight and length) and liver-somatic-index (LSI) should be analysed according to the 'Other endpoints' branch.

Continuous data

Data for continuous endpoints should first be checked for monotonicity by rank transforming the data, fitting to an ANOVA model and comparing linear and quadratic contrasts. If the data are monotonic, a step-down Jonckheere-Terpstra trend test should be performed on replicate medians and no subsequent analyses should be applied. An alternative for data that are normally distributed with homogeneous variances is the step-down Williams' test. If the data are non-monotonic (quadratic contrast is significant and linear is not significant), they should be analysed using a mixed effects ANOVA model. The data should then be assessed for normality (preferably using the Shapiro-Wilk or Anderson-Darling test) and variance homogeneity (preferably using Levene's test). Both tests are performed on the residuals from the mixed effects ANOVA model. Expert judgment can be used in lieu of these formal tests for normality and variance homogeneity, though formal tests are preferred. If the data are normally distributed with homogeneous variance, then the assumptions of a mixed effect ANOVA are met and a significant treatment effect is determined from Dunnett's test. Where non-normality or variance heterogeneity is found, then the assumptions of Dunnett's test are violated and a normalising, variance stabilising transform is sought. If no such transform is found, then a significant treatment effect is determined with a Dunn's test. Whenever possible, a one-tailed test should be performed as opposed to a two-tailed test, but it requires expert judgment to determine which is appropriate for a given endpoint.

Mortality

Mortality data should be analysed for the time period encompassing the full test and should be expressed as proportion that died in any particular tank. Tadpoles that do not complete metamorphosis in the given time frame, those tadpoles that are in the larval sub-sample cohort, those juvenile frogs that are culled, and any animal that dies due to experimenter error should be treated as censored data and not included in the denominator of the percent calculation. Prior to any statistical analyses, mortality proportions should be arcsin-square root transformed. An alternative is to use the step-down Cochran-Armitage test, possibly with a Rao-Scott adjustment in the presence of overdispersion.

Weight and length (growth data)

Males and females are not sexually-dimorphic during metamorphosis so larval sub-sampling growth data should be analysed independent of gender. However, juvenile growth data should be analysed separately based on genetic sex. A log-transformation may be needed for these endpoints since log-normality of size data is not uncommon.

▼ **M8***Liver-somatic-index (LSI)*

Liver weights should be normalised as proportions of whole body weights (i.e., LSI) and analysed separately based on genetic sex.

Time to NF stage 62

Time to metamorphosis data should be treated as time-to-event data, with any mortalities or individuals not reaching NF stage 62 in 70 days treated as right-censored data (i.e. the true value is greater than 70 days but the study ends before the animals had reached NF stage 62 in 70 days). Median time to NF stage 62 completion of metamorphosis in dilution water controls should be used to determine the test termination date. Median time to completion of metamorphosis could be determined by Kaplan-Meier product-limit estimators. This endpoint should be analysed using a mixed-effects Cox proportional hazard model that takes account of the replicate structure of the study.

Histopathology data (severity scores and developmental stages)

Histopathology data are in the form of severity scores or developmental stages. A test termed RSCABS (Rao-Scott Cochran-Armitage by Slices) uses a step-down Rao-Scott adjusted Cochran-Armitage trend test on each level of severity in a histopathology response (Green *et al.*, 2014). The Rao-Scott adjustment incorporates the replicate vessel experimental design into the test. The 'by Slices' procedure incorporates the biological expectation that severity of effect tends to increase with increasing doses or concentrations, while retaining the individual subject scores and revealing the severity of any effect found. The RSCABS procedure not only determines which treatments are statistically different from controls (i.e., have more severe pathology than controls), but it also determines at which severity score the difference occurs thereby providing much needed context to the analysis. In the case of developmental staging of gonads and reproductive ducts, an additional manipulation should be applied to the data since an assumption of RSCABS is that severity of effect increases with dose. The effect observed could be a delay or acceleration of development. Therefore, developmental staging data should be analysed as reported to detect acceleration in development and then manually inverted prior to a second analysis to detect a delay in development.

Figure 1

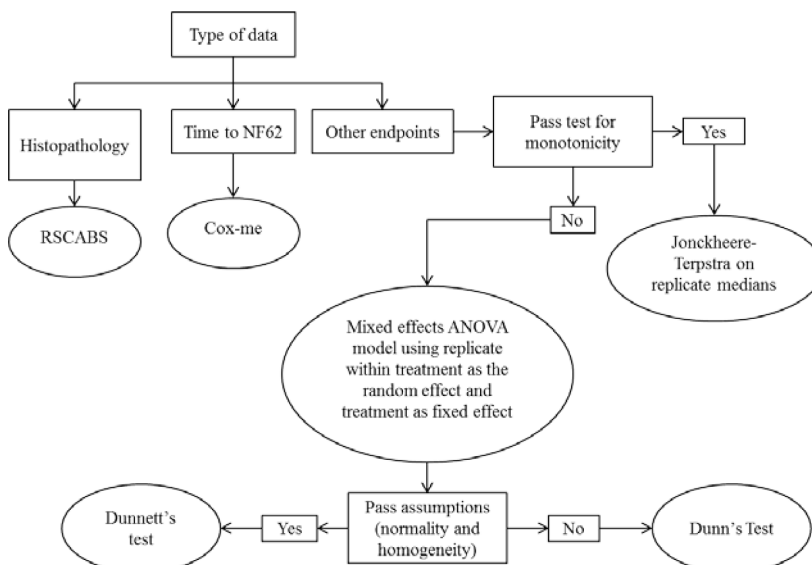
Statistical analysis decision tree for LAGDA data

▼ **M8**

LITERATURE

Green JW, Springer TA, Saulnier AN, Swintek J. 2014. Statistical analysis of histopathology endpoints. *Environmental Toxicology and Chemistry* 33, 1 108-1 116.

▼ **M8***Appendix 8***CONSIDERATIONS FOR TRACKING AND MINIMISING THE OCCURRENCE OF SCOLIOSIS**

Idiopathic scoliosis, usually manifesting as ‘bent tail’ in *Xenopus laevis* tadpoles, may complicate morphological and behavioural observations in test populations. Efforts should be made to minimise or eliminate the incidence of scoliosis, both in stock and under test conditions. In the definitive test, it is recommended that the prevalence of moderate and severe scoliosis be less than 10 %, to improve confidence that the test can detect treatment-related developmental effects in otherwise healthy amphibian larvae.

Daily observations during the definitive test should record both the incidence (individual count) and severity of scoliosis, when present. The nature of the abnormality should be described with respect to location (*e.g.*, anterior or posterior to the vent) and direction of curvature (*e.g.*, lateral or dorsal-to-ventral). Severity may be graded as follows:

(NR) Not remarkable: no curvature present

(1) Minimal: slight, lateral curvature posterior to the vent; apparent only at rest

(2) Moderate: lateral curvature posterior to the vent; visible at all times but does not inhibit movement

(3) Severe: lateral curvature anterior to the vent; OR any curvature that inhibits movement; OR any dorsal-to-ventral curvature

A US EPA FIFRA Scientific Advisory Panel (FIFRA SAP 2013) reviewed summary data for scoliosis in fifteen Amphibian Metamorphosis Assays with *X. laevis* (NF stage 51 through 60+) and provided general recommendations for reducing the prevalence of this abnormality in test populations. The recommendations are relevant to the LAGDA even though this test encompasses a longer developmental timeline.

Historical Spawning Performance

Generally, high quality, healthy adults should be used as breeding pairs; eliminating breeding pairs that produce offspring with scoliosis may minimise its occurrence over time. Specifically, minimising the use of wild-caught breeding stock may be beneficial. The LAGDA exposure period begins with NF stage 8- to-10 embryos, and it is not feasible to determine at the test outset whether given individuals will exhibit scoliosis. Thus, in addition to tracking the incidence of scoliosis in animals that are placed on test, historical clutch performance (including the prevalence of scoliosis in any larvae allowed to develop) should be documented. It may be useful to further monitor the portion of each clutch not used in a given study and to report these observations (FIFRA SAP 2013).

Water Quality

It is important to ensure adequate water quality, both in laboratory stock and during the test. In addition to water quality criteria routinely evaluated for aquatic toxicity tests, it may be useful to monitor for and to correct any nutrient deficiencies (*e.g.*, deficiency of vitamin C, calcium, phosphorus) or excess levels of selenium and copper, which are reported to cause scoliosis to varying degrees in laboratory-reared *Rana* sp. and *Xenopus* sp. (Marshall *et al.* 1980; Leibovitz *et al.* 1992; Martinez *et al.* 1992; as reported in FIFRA SAP 2013). The use of an appropriate dietary regimen (see Appendix 4), and regular tank cleaning, will generally improve water quality and health of the test specimens.

▼ M8**Diet**

Specific recommendations for a dietary regimen, found to be successful in the LAGDA, are detailed in Appendix 4. It is recommended that feed sources be screened for biological toxins, herbicides, and other pesticides which are known to cause scoliosis in *X. laevis* or other aquatic animals (Schlenk and Jenkins 2013). For example, exposure to certain cholinesterase inhibitors has been associated with scoliosis in fish (Schultz *et al.* 1985) and frogs (Bacchetta *et al.* 2008).

LITERATURE

Bacchetta, R., P. Mantecca, M. Andrioletti, C. Vismara, and G. Vailati. 2008. Axial-skeletal defects caused by carbaryl in *Xenopus laevis* embryos. *Science of the Total Environment* 392: 110 – 118.

Schultz, T.W., J.N. Dumont, and R.G. Epler. 1985. The embryotoxic and osteoathrogenic effects of semicarbazide. *Toxicology* 36: 185-198.

Leibovitz, H.E., D.D. Culley, and J.P. Geaghan. 1982. Effects of vitamin C and sodium benzoate on survival, growth and skeletal deformities of intensively culture bullfrog larvae (*Rana catesbeiana*) reared at two pH levels. *Journal of the World Aquaculture Society* 13: 322-328.

Marshall, G.A., R.L. Amborski, and D.D. Culley. 1980. Calcium and pH requirements in the culture of bullfrog (*Rana catesbeiana*) larvae. *Journal of the World Aquaculture Society* 11: 445-453.

Martinez, I., R. Alvarez, I. Herraiez, and P. Herraiez. 1992. Skeletal malformations in hatchery reared *Rana perezi* tadpoles. *Anatomical Records* 233(2): 314-320.

Schlenk, D., and Jenkins, F. 2013. Endocrine Disruptor Screening Prog (EDSP) Tier 1 Screening Assays and Battery Performance. US EPA FIFRA SAP Minutes No. 2013-03. May 21-23, 2013. Washington, DC.