

# **Environmental Impact Assessment Report**

## **for the Facility for Treatment and Conditioning of Radioactive Waste with a High Volume Reduction Factor at Kozloduy Nuclear Power Plant**

### **CHAPTER 3**

#### **DESCRIPTION AND ANALYSIS OF THE ENVIRONMENTAL COMPONENTS AND FACTORS, THE MATERIAL AND CULTURAL HERITAGE, THAT WILL BE SIGNIFICANTLY AFFECTED BY THE INVESTMENT PROPOSAL AS WELL AS THE INTERACTIONS AMONG THESE ASPECTS**

## CONTENTS

### **3. DESCRIPTION AND ANALYSIS OF THE ENVIRONMENTAL COMPONENTS AND FACTORS, THE MATERIAL AND CULTURAL HERITAGE, THAT WILL BE SIGNIFICANTLY AFFECTED BY THE INVESTMENT PROPOSAL, AS WELL AS THE INTERACTIONS AMONG THESE ASPECTS.....1**

3.1 Geology and geotechnical analyses .....	1
3.1.1 Characteristics of the geological environment .....	1
3.1.2 Seismicity .....	4
3.2 Hydrology, hydrogeology, surface and ground water .....	7
3.2.1 Hydrological characteristic of the area .....	7
3.2.2 Monitoring and quality characteristics of surface waters in the KNPP area .....	11
3.2.2.1 Monitoring, natural and technogenic radioactivity of surface waters in the area .....	11
3.2.2.2 Quality of the surface waters (non-radiation conditions) .....	20
3.2.3 Hydrogeology .....	35
3.2.3.1 Location and geomorphologic structure .....	35
3.2.3.2 Geological and hydrogeological prerequisites .....	36
3.2.3.3 Hydrogeological conditions .....	37
3.2.3.4 Natural and technogenic radioactivity of ground waters .....	53
3.2.4 Surface and groundwater in the 30-km area of the Romanian territory .....	60
3.2.4.1 Surface water .....	60
3.2.4.2 Ground water .....	61
3.3 Flora .....	64
3.3.1 General characteristic of the flora and vegetable in the region of PMF at KNPP .....	64
3.3.1.1 General characteristics flora and vegetation within the 30-km zone in Romania .....	66
3.3.2 KNPP impact on the flora in the 30-km area on the territory of Bulgaria ..	68
3.3.3 Influence of KNPP on vegetation within the 30-km zone in Romania .....	75
3.4 Fauna .....	77
3.4.1 Birds .....	77
3.4.1.1 Generative period .....	78
3.4.1.2 Migration period .....	80
3.4.1.3 Hibernating period .....	80
3.4.1.4 Summary of the ornithological situation in the region of Zlatiata	

protected area .....	80
3.4.2 Animals .....	82
3.5 Lands.....	87
3.5.1 Land use .....	87
3.5.2 Soils.....	90
Kozloduy-.....	94
3.6 Landscape.....	111
3.7 Climate and meteorological conditions .....	119
3.8 Radiation background, atmospheric radioactivity and air quality.....	128
3.8.1 Air quality.....	128
3.8.2 Atmospheric radioactivity .....	129
3.8.2.1 Aerosols .....	131
3.8.2.2 Atmosphere deposits .....	137
3.9 Harmful physical factors.....	141
3.9.1 Ionizing radiation.....	141
3.9.2 Non-ionizing radiations.....	151
3.9.3 Noise .....	153
3.9.4 Vibrations .....	156
3.10 Protected zones and protected areas .....	157
3.10.1 Protected Areas under NATURA 2000 in the region of KNPP .....	157
3.10.1.1 Protected area "Kozloduy Islands", BG0000533 .....	158
3.10.1.2 Protected Area “Zlatiyata”, Code: BG0002009.....	161
3.10.1.3 Protected Area BG0000614 Ogosta River.....	163
3.10.1.4 Protected Area BG0000508 Skut River .....	165
3.10.2 Protected Areas under NATURA 2000 in the region of KNPP in 30-km zone in Romania.....	178
3.10.3 Protected Territories.....	186
3.10.4 Impact of the KNPP on the plants and habitats in the Protected Areas and Protected Territories .....	187
3.11 Cultural heritage .....	188
3.12 Geography, demographic, social and socio-economic environment.....	192
3.12.1 Geographic location of KNPP .....	192
3.12.2 Demographic and socio-economic characteristics.....	193
3.13 Health status of the population and the workers .....	218
3.13.1 Health status of the potentially affected population .....	218
3.13.2 Health status of the potentially affected workers and employees.....	223

3.14 Hazardous substances .....	235
3.15 Different types of wastes and their locations .....	255
3.15.1 Non-radioactive waste .....	255
3.15.2 RAW .....	271

### **3. DESCRIPTION AND ANALYSIS OF THE ENVIRONMENTAL COMPONENTS AND FACTORS, THE MATERIAL AND CULTURAL HERITAGE, THAT WILL BE SIGNIFICANTLY AFFECTED BY THE INVESTMENT PROPOSAL, AS WELL AS THE INTERACTIONS AMONG THESE ASPECTS**

#### **3.1 Geology and geotechnical analyses**

##### **3.1.1 Characteristics of the geological environment**

From the orographical point of view the assessed territory is located within the Hilly Danube Plain. From the tectonical point of view KNPP is situated at the Miziya platform. Approximately everywhere it is coated with quaternary sediment formations of different genesis. Also, the territory itself, concerning the distribution of sands, clays, marls, marl limestone of Neogene age, clays and marls from Eocene age, Palaeocene limestone, Dolomites of Jurassic age, Triassic breccia conglomerates, limestone, dolomitic limestone, dolomites, sandstones, siltstones and argillite is very well investigated by the means of drill works. The following litho-stratigraphic units are detached covering the Palaeozoic, Mesozoic and Neozoic systems.

##### **Tectonic characteristics**

From the tectonical point of view the region is part of the Lom depression located in the west part of the Miziya platform. For clarification of the deep tectonic structure some geophysical, seismological, geomorphologic, neotectonic, geodetic, seismological, local and regional investigations were made. Their results were summarized and a complex assessment of the available information was made with regards to clarification of the location of the units of KNPP and provision of anti-seismic construction of the facilities.

##### **Summarized regional tectonic characteristics**

Data about the tectonic of the regional area were gained from geophysical investigations under three regional profiles: Mokresh-Shabla, Petrich-Nikopol and Madan-Strazhitsa-Russe. Deep structure and conductivity of the seismic energy in separate areas was investigated through the macroseismic fields of the seismic, magnetic-tellurium drilling, gravimetric and geomagnetic.

In Triassic structure level the North Knezhanska terrace and Beloslatinsko lowering are detached, which are separated by Yarlovsko-Selanovska swell-like strip and Kozloduy-Komoshtitska monoclinal one. In the latter a positive structure is formed south-west from the Kozloduy on the roof of medium Triassic period.

In the upper Jurassic-valangian structure stage there is a positive structure formed to the north-east towards the Triassic one. During the Neogene-Quaternary structure stage the territory was complicated by faults of east-west direction. Trans-regional lineament areas Tsibarski, Boichinovski, Krivodolski, and Oriahovsko-Mezdrenski

were detached. Following positive structures were also well-distributed: GornoTsiabarska, Kozloduyska, Zlaryiska and Oryahovska.

### **Summarized tectonic characteristic of the area of KNPP**

No abnormal objects were detected in view of the conducted gravimetric and geomagnetic investigations. Beyond the territory a gravity transition registered towards north-west-southeast - South-Miziya fault, which generally reflects the Belogradchik flexure.

On the territory of KNPP no geologic and geomorphologic data are available regarding the existence of active fault structures of Quaternary age. The lineament is only weakly expressed or it is completely missing.

The surveillance area (radius of 100 km) spreads on the Romanian territory up to Drobeta - Turnu Severin, Strehaiia, Filiași, Craiova, Segarcea, and represents the south-western part of the Moesian Platform. That is why we will refer in the following to the geotectonic, structural and stratigraphic characteristics of this major area.

Morphologically, the mentioned area belongs, in the south, to the Western Romanian Plains and it is characterized by a morphology specific to the Danube river (a sequence of terraces), to which a relief of dunes is added, and in the north the relief corresponds to sub-Carpathian hills with heights between 200 – 450 m.

The area belongs to the major geo-structural unit called Moesian Platform. Taking into consideration the tectonics of the perimeter which is the object of the present documentation and its lithostratigraphy, as well as the fact that it belongs to a major structural unit (Moesian Platform) this perimeter can be considered as tectonically stable. This area seems to have been affected by oscillatory motions, which is shown by the stratigraphic gap of Cretaceous (Băilești) and Tortonian (Cetate).

Moreover, the motion of the course of the Danube River to the south, starting with Middle Pleistocene, which was proved by the succession of terraces, was caused by the slight exterior-tilting neo-tectonic motions which affected the entire territory of the field.

### **Physical and geological processes**

For the investigated region the typical physical and geological phenomena are collapse related to the loess materials, falling down of land masses on the slopes, which is also typical for the loess materials and boggy places in the overflowed terraces of the Danube River.

In the region of KNPP the loess is available everywhere and its thickness of 12m is the reason for the main physical and geological processes under development. In the loess complex up to the bottom the following lithological varieties are discovered:

- Sandy loess stratum- average thickness ( $M_{av} = 6.90$  m);
- Clay loess ( $M_{av} = 2.10$  m);
- Loess clay stratum ( $M_{av} = 2.40$  m).

Based on a number of investigations it became clear that loess in the area of aeration is the strongest collapsed one and this is the area located over the level of the groundwater, which is constructed by sandy loess. In the depth of the clayey loess

where an area of water level fluctuation and capillary increase is detected, the loess collapse is much decreased. The area under the water level (area of the loess clays) the loess collapse does not exist.

Collapse of the earth masses on the slopes is also typical for the region, especially at the places where the loess materials are available. This is a result of the destruction of the natural balance condition of the geological environment caused by the executed additional human activity. In the region of KNPP site no such landslides occurred but next to the town of Oryahovo they occurred at many places.

Boggy places are typical for the low lands next to the Danube River, especially in the sections for protection dikes in the overflowed terraces. Reason for that is the available drainage system. But at the Kozloduy low land there is also an additional condition - this is the higher level of the plant channels compared with the level of the groundwater in the low land.

### **Engineering and geological conditions**

In order to clarify the features of the ground foundation regarding the consideration of the engineering and geological conditions of the foundation and construction of the different facilities of the industrial site of KNPP, a large scope of engineering and geological investigations is executed. These investigations cover the following types of works:

- Drill works;
- Static penetration;
- Trial load with a dye;
- Laboratory investigations.

Available information about the engineering and geological investigations shows that they are professionally made, clarifying all needed engineering and geological parameters in view of design and execution of the construction works for separate facilities of the power plant.

Protocols of the geodetic measurements show that at some places on the site there are unequal settlements under different types of facilities.

### **Mineral resources**

Mineral resources available in the region are related to the geological structure. As per the data of the geological investigations the following mineral resources are discovered in the region:

- Fossil fuels – oil and gas shows, lignite coal;
- Non-metal (construction materials) – limestone, gypsum, sand, clay, loess.

### **Non-metal (construction materials)**

Gypsum is within the scope of the Deleyska formation of Baden age. Only the region of Oryahovo could be a matter of industrial interest. Shelly limestones of the Furen formation are a valuable decorative material and are easy for processing - the most interesting are the ones located around the town of Miziya.



## Quarry materials

Sands and gravels are within the Danube, Ogosta, Skut and Tsibritsa Rivers and they are mostly of Quaternary age. They could be mostly mined alongside the Danube River by the Bulgarian Dredger Inland Water Transport.

## Loess

Investigated loess fields are beyond the investigated region. At some places there are only minor quarries available for local needs - around Kozloduy and Miziya. Loess is used for brick manufacturing in the region.

### 3.1.2 Seismicity

For the purposes of evaluation of seismicity on the territory of the facility some specialized investigations were carried out, the results are stipulated in the brief seismic characteristic.

#### Seismicity of 320 km area of KNPP

As a whole, the area of KNPP with radius of 320 km is a part of Alpine-Himalaya seismic belt of high seismic activity. Within the commented region the following seismic active areas are determined: Sofia, Gorna Oriahovitsa, Maritsa, Kresna, Negotino-Kraina and Kumpulim-Vrancea. Typical for these areas are strong crust earthquakes ( $M > 5.0$  with depth 50 km, and for Vrancha- 150 km). Seismicity in the detached seismic active areas is investigated in details with spatial, temporary and energy characteristics. At the minimal distance of 80 km from the site of KNPP the Sofia seismic area is located. For this area the maximal documented epicenter intensity ( $I_0$ ) of 9th degree (MSK-64) of the earthquake in 1641 and 1858. Monitored maximal effect on the site of the KNPP by the earthquakes in the Sofia area is  $I_{koz} = 3$  (MSK-64).

The most severe impact on KNPP is the one of the focus earthquakes generated by the Vrancea seismic focus. Maximal macroseismic effects on the site  $I_{koz} = 6 - 7$  are monitored from the earthquakes in 1977 with  $M = 7.2$  and  $I_0 = 8.0$  (MSK-64). Effect is a result of the specific in the focus processes (strong prolongation towards SE of the isoseismic field).

Earthquakes generated beyond the above areas are related to the famous fault structures, which could not be defined as detached as insufficient data was available to determine their main characteristics. The most severe earthquakes beyond the defined areas were the event in the North Greece in 1828  $M = 7.5$  and  $I_0 = 10.0$  (MSK-64) and the earthquake in the region of Dulovo in 1882 with  $M = 7.3$  and  $I_0 = 7.8$  (MSK-64) with monitored macroseismic effects on the site of KNPP  $I_{koz} = 5 - 6$  (MSK-64).

#### Seismicity in the local area of KNPP

Site of KNPP is located in the middle of the stable part of the Miziya platform, which had typical seismic activity. During the period of the instrumental registration of earthquakes (1976 - 1990) on the entire territory of the country there were only 3 earthquakes of  $3.0 < M < 3.6$ . There are no historically documented earthquakes in



this area. The lack of documented seismic activity and weak sporadic seismic occurrences characterize it as the most "calm" seismic area within 320 km region.

Analysis of the neotectonic processes in the Miziya platform is subordinated to the main regularities of the last tectonic cycles. Tectonics level-difference displacements were monitored only on the platform borders. Tectonic processes were completed by the end of the Triassic and beginning of the Jurassic periods. The seismic investigations determined that there are no faults of Jurassic-Palaeogene ages. Neogene and Quaternary depositions lay approximately horizontally without any surface features of tectonics breaches.

Available data reject the existence of "capable" fault, i.e. surface occurred structure of seismic potential.

Seismic tectonics model of the local area (30 km) is structured by the use of the standard procedure for integration of all available geological and geophysical data. There is a highest degree of inhomogeneity of physical parameters of the Earth crust so they are examined as areas of potential instability.

Lack of evidences about the Quaternary activity and motions in the local area as well as the fact that the most severe earthquakes registered here are of magnitude  $M = 3.6$  provide grounds for the conclusion that in the area no earthquake of  $M_{\max} = 4.0$  could be expected. Obtained result is in compliance with the detachment of seismic regions of the Republic of Bulgaria.

### **Seismic security of KNPP**

Main investigations of the BAS Geophysical Institute of the seismic security of the KNPP, which are examined and accepted by IAEA missions, are related to:

- Construction of local seismic monitoring network (LSMN);
- Construction of additional accelerograph network (SASCEC);
- Processing and analysis of records of strong earthquakes;
- Analysis of the seismic hazard of the local and regional sources;
- Experimental investigations of the dynamic characteristics of the site and power units;
- Determination of the site seismic characteristics;
- Neotectonic investigations;
- Investigation of the geophysical fields;
- Re-assessment of the historical earthquakes;
- Re-assessment of the Earthquake Reactor Shut-down Thresholds.

Besides this comprehensive information, there is also a data base available provided by the constructed Local Seismic Monitoring Network with three seismic stations as follows:

- Village Malo Peshtene (MPE) with an increase by 1.09. September 1999 100 000/1°Hz;
- Town of Vulchedrum (VLD) with increase of 20 000/1 Hz;
- Town of Oryahovo (ORH) with increase of 1500/1 Hz.

They are constructed on the grounds of the requirements for recognition, registration

and localization of the earthquakes in the magnitude range  $M = 1 - 5$  and by them the processes of the seismic events are monitored within the time and space and reliable data are collected about the repetitions of the earthquakes and seismic danger. Based on the preliminary investigations the following data important for the design of the seismic stations are obtained:

- Frequency range of the earthquakes 0.05 – 100 Hz, and the upper border could be reduced to the internationally accepted value 50 Hz (Regulatory Guide 1.12);
- Measured macroseismic noise in 25 points of the region of 12.5 - 40.2 dB interval (converted to base point N 19 in the village of Borovan - 28.8 dB);
- Ratio signal/noise - S/N 12 dB.

All Units of KNPP have Industrial Anti-Seismic Protection System installed (IAPS) that shuts down the reactors in case of earthquakes with accelerations higher than the set threshold. Since 1993 an accelerograph system SASEC is commissioned (system for accelerograph seismic control of equipment and structures). It includes accelerograph of SMA type – 1 (4 pcs.), SMA - 2 (3 pcs.) and SSA (4 pcs.), located on the free field and at different elevations of Units 3 and 5.

In the BAS studies the data of the geotechnical seismic model of the "free surface" are summarized, which are valid for the construction site and regardless the inhomogeneous geological conditions they allow the "soil-structures" interaction to be determined. It is confirmed by the analyses under the design Benchmark Study of IAEA, the Modernization program of Units 5-6 and others with the participation of European and American Companies with reach experience in the seismic design and seismic re-assessment of Nuclear Power Plants.

## 3.2 Hydrology, hydrogeology, surface and ground water

### 3.2.1 Hydrological characteristic of the area

Plant site is located on the right bank of the Danube River, 5 km east of the town of Kozloduy. In the site of the KNPP the Rivers Ogosta, Skut and Tsibritsa flow, which are situated on the territory of Bulgaria and inflow into the Danube River. In the vicinity of the KNPP - 3 km away to the north of the NPP site Danube River flows. At 10 to 30 km to the south and to the south-east of the site flows the Ogosta River. At 10 to 30 km to the east and south of the site flows the Skut River; and at 20 to 30 km to the west of the site flows Tsibritsa River. The Ogosta, Skut and Tsibritsa Rivers flow into the Danube River. On the Romanian territory against the site Zhiu River flows into Danube River. The hydrological conditions of KNPP site depend on the sources of surface water – in this case, river systems, swamps, springs, lakes and others.

#### Tsibritsa River

Tsibritsa River originates from the foot of the Tserov and Kostin peaks in the Balkan mountain. The Tsibritsa has a length of 87.5 kilometres and a drainage basin of 933.6 square kilometers. It flows into the Danube River opposite to the Ibisha island.

#### Skut River

Skut River originates from the fore-mountains, north of Maniashki peak. The height of these fore-mountains is 500-600 m and their northern slopes are woodless and sloping down small rivers have torrential character. The river flow has been corrected north of the town of Miziya and is linked to the Ogosta River via a channel.

#### Ogosta River

The Ogosta River is the largest river with biggest debit, length and drainage basin, and with numerous tributaries. The drainage basin of the river is 4282.29 km<sup>2</sup>, and the annual flow amounts to 798,018.106 m<sup>3</sup>.

Ogosta River bed and mouth are corrected in connection with the organization of the service water supply of KNPP. The mouth is displaced to the East under the Bank Pumping Station (BPS) and protection dikes are constructed respectively. Average annual river outflow does not exceed 20 m<sup>3</sup>/s. An outflow regime is formed by small streams in the region and mostly by Ogosta Dam located 60 km south-west of it.

The natural topography and remoteness of these rivers give reason to exclude the possibility that they would affect the condition of the plant and the PMF design in particular.

#### Water basins

In this area several small dams for different purposes have been built. “Shishmanov val” dam has been built approx. 10 km away from KNPP site. The dam is filled with water from the Danube river through a floating pumping station. In addition to irrigation, the water from this dam is used to supply technical water to KNPP in emergency regime situations.

The plant site is located in the northern part of the first non-flooded terrace of the

Danube River and has an average elevation of 35 m. The elevations of the area near the river bank are around 26.0 – 26.5 m, and those in the lowland – around 25.0 – 26.0 m.

The site covers an area of around 2.2 km<sup>2</sup> and reaches 4.5 km<sup>2</sup> including the channels for circulation and technical water supply. To the north the plant site borders the Danubian plain. South of the site the slope of the watershed plateau is relatively high (100 – 110 m), its height to the west is around 90 m, and to the east the slope lowers to 30 m above sea level. The entire lowland is protected by an earth embankment dike, the elevations of which are from 31.80 m to 33.00 m.

The site area has been determined in the plant design with a non-flooding reserve for a 10 000 – year high wave on the Danube River.

Between the plant and the Danube River embankments have been built, designed to withstand a 1000-year high wave on the Danube river with the necessary normative reserve. The drainage systems are designed in a way that they can lead away surface water from intensive rainfall with various duration and height probability of 0.01 % (once in 10 000 years).

### **Hydrological knowledge about the danube river**

The river is crucial for the proper and safe operation of KNPP.

Danube River is one of the rivers with the highest water and is of the longest rivers in Europe. Its original source is located in the Schwarzwald Mountain in Germany. From there up to its inflow into the Black Sea, the Danube crosses ten countries - Germany, Slovakia, Austria, Hungary, Croatia, Serbia, Bulgaria, Romania, Ukraine and Moldova. River length is about 2880 km. It has closed-meshed and high water river network - above 120 tributaries, 34 of which are shipping ones. Its total water catchment area is 817 000 km<sup>2</sup>, of which around 550 000 km<sup>2</sup> are before the site. In the river flow distribution by years there are two long consecutive periods of 12 years each with decreased flow (1942-1954 and 1981-1993), and one long 26-year period of increased flow (1955-1980). After 1994 the river flow shows a trend to increase.

In the river area within KNPP site limits the island of Kopanitsa is situated (701.5-690.5 km, up to 1 km wide and about 11 km long), which divides the river in two arms.

At the hydrological stations at Kozloduy (703.5 km with elevation “0” – 21.77 m) and at Oryahovo (678.0 km with elevation “0” – 21.34 m) regime monitoring of the major hydrological characteristics is conducted. Daily measurements of water levels on the Danube are carried out at the Kozloduy hydrological station by the National Institute of Meteorology and Hydrology. At the coastal pumping stations (CPS 1, 2 and 3) water levels in the Danube River and the channels are also measured daily. In cases of high water levels in the Danube River before the start of the high wave peak and after that during decline the measurement frequency is increased by going to hourly measurements.

In case of higher waters the maximal river depth reaches 23.0 – 24.0 m, and in case of low waters it drops down to 1.7 – 1.8 m. Average width of the Danube River is about 800 m. Minimal water quantity monitored in the Bulgarian section of the Danube

River in the last 40 years is 1410 m<sup>3</sup>/s next to the town of Novo Selo and the maximal one is 15170 m<sup>3</sup>/s is monitored next to the town of Silistra. Water quantities above 13000 m<sup>3</sup>/s in the Danube River are very rare events and usually do not last long.

After the spring high water in June, July and mostly in August a sharp drop in water levels occurs, and after the autumn drought low water occurs in the river basin in September, October and approx. mid-November. In the period from July to November, despite the overall trend of decline of the water resources, there are tidal waves due to rainfall, which vary in intensity and size. So far during the 30-year operation of KNPP the minimum water level of the Danube River has never been lower than 21.2 m.

There are no unconditional evidences regarding the anthropogenic impacts on the monthly outflow of the Danube River. Iron Gate hydro-junctions do not regulate the outflow for a period longer than 1 week due to a shortage of regulating capacities. This is the reason their impact on the monthly and annual outflow of the river not to be significant.

Considering the above statements it is determined that during the operation of KNPP on full capacity (3760 MW) before the shutdown of Units 1-4 and given a deviation of the river waters flowing with a velocity of 180 m<sup>3</sup>/s, even in a year of severe low-water level (probability 99 %) the water use of the power plant from the Danube River is very low - only 4.5 % of the river flow.

Also, it is determined that in normal operation mode of average capacity of 2500 – 3000 MW, the water quantity needed for the cooling system of the power plant is 110 – 140 m<sup>3</sup>/s or 2.7 – 3.5 %. In view of the average long standing water quantity (5719 m<sup>3</sup>/s) this assessment is 3.1 % with full-load continuous operation and 1.9 - 2.4 % in normal operation condition.

Water losses due to the increased evaporation as a result of the water warming up by the plant cooling system are estimated at 1 200 000 m<sup>3</sup>/y for average long standing temperatures of the water, air as well as the wind velocity, out of which:

- From hot water channel - 550 000 m<sup>3</sup>/y.
- From the Danube River - 650 000 m<sup>3</sup>/y.

These losses are 0.038 m<sup>3</sup>/s average in the year, which is of the order less than the error applied for determination of the water quantity used for the water cooling system.

In fact, the real irreversible water losses of KNPP are estimated at 0.00092 % of the Danube River outflow and 0.044 % of all waters used by the power plant, i.e. KNPP does not have any impact on the Danube River outflow.

There is a trend for reduction of the number and duration of the ice phenomena. Possibly, this reduction is caused by the anthropogenic activity and global warming.

Even rarer there are some backwatering phenomena close to the NPP – at the 660-678 km section Island-Oryahovo. There is an assumption that the impact of the backwatering phenomena on the water levels in the area of KNPP could have more unfavorable impact on the elevations of the water levels than during the period of high

waters.

### **Temperature mode of the Danube River**

Distribution of water temperature across the width of the river depends on the flow rate, season and hydraulic characteristics of the river section. The maximal measured temperature differences across the width of the river are 0.2 - 0.4°C and they are highest in the early morning hours. During the warm season the cross-section of the river is practically isothermal. In the lower part of the Danube River in Bulgaria the average temperatures are by 1.6°C – 2°C higher than the normal climatic ones for the most regions (expressed as long-term average ones, 1961-1990) and the winter of 2006-2007 is the warmest ever recorded.

In this case the thermal impact on Danube River by KNPP is also defined. In case of KNPP operation at full rate capacity (3760 MW and respectively 180 m<sup>3</sup>/s), the rise of the temperature is about 0.37°C.

In the present state of Kozloduy NPP the maximum amount of cooling water is 90-100 m<sup>3</sup>/s and there is no thermal effect on the Danube River.

### **Floodings**

Flooding of KNPP site can be caused by:

- intensive rainfall and formation of catastrophic high water levels in the Danube River;
- destruction of dams that block the Danube River (upper and middle section of the Danube), built up-stream from KNPP;
- Other critical actions: combination of the two above-mentioned events or discharge of water from the water reservoir;
- Ice-forming in the Danube River.
- Detailed studies of the above events are presented in Ref. [29] to [31]. The main conclusions are as follows:
  - The water level in case of floodings caused by intensive rainfall is lower than the elevation of the top of the facilities for technical water supply (coastal pumping stations and dykes of the dual channel);
  - The duration of the high wave peak is very short (1-2 hours), after which it starts to decrease;
  - The maximum water quantity has a probability of  $p = 0.01$  %, which may never occur during the entire operation period of the PMF, considering that the maximum flows for a period of 400 years have a volume of 15500-16 000 m<sup>3</sup>/s;
  - A number of HPP cascades are built along the Danube tributaries, which regulate the high water and balance the peak values.

It can be concluded that KNPP site is not jeopardized from flooding coming from the Danube River. The high water levels are lower than the top of the site facilities.



### **3.2.2 Monitoring and quality characteristics of surface waters in the KNPP area**

The assessment of the surface water condition is associated mainly with the basic source of industrial water supply of the plant – the Danube river, which also receives the plant waste waters.

The investment proposal for construction of PMF falls within the scope of a surface water body along the Danube River named Dunabe RWB01 and **code BG1DU000R001, according Plan River Basin Management (RBMP)** in the Danube River Basin District.

Surface water body **Danube code BG1DU000R001** is defined as a heavily modified water body category River. Ecological potential of the surface water body is moderate and chemical status is poor. Environmental objectives for surface water body code **BG1DU000R001**, placed in the RBMP is: **“Prevent deterioration of the ecological potential and achieve good status until 2021. Prevent deterioration of chemical status and achieve good until 2027.”** For this water body is introduced except by achieving environmental objectives, because of the significant anthropogenic

The Danube Basin Department includes 115 control monitoring stations and 53 operational monitoring stations, which observe indicators from three main groups – basic physicochemical, priority substances and specific pollutants. The monitoring frequency ranges from 4 to 12 times a year. The measured indicators are divided in three groups:

- Basic physicochemical indicators – temperature, pH, undissolved substances, electrical conductivity, biogenic elements (NH<sub>4</sub>-N, NO<sub>3</sub>-N, PO<sub>4</sub>), dissolved oxygen, oxygen saturation, permanganate oxidation, Biochemical Oxygen Demand (BOD), Chemical oxygen demand (COD), iron, manganese, sulfates, chlorides and others;
- Priority substances;
- Specific pollutants – organic substances, heavy metals and metalloids, cyanides, phenols and other specific substances.

At the monitoring stations water quantities are also measured. The measurements results come each month from the regional laboratories into the national database at ExEA – Sofia and the basin departments.

Hydrobiological monitoring of surface waters is also conducted in compliance with Ordinance by the Minister of the environment and waters No RD – 715/02.08.2010.

#### **3.2.2.1 Monitoring, natural and technogenic radioactivity of surface waters in the area**

The area around KNPP site is monitored to establish the change in the radiation status of the waters. The total  $\beta$ -activity is considered as a parameter for radioactivity in water. Concentration limit for total  $\beta$ -activity is 2.0 Bq/l.

Over the past 10-15 years, there is no significant dynamics in the radiation status of the Danube river water. The data of total  $\beta$ -activity is much lower than the limit, as well as numerous results from previous studies, show that the radiation status of the surface waters have not been affected in the long term by KNPP operation.



## Radiation status

State regulation of the safe use of nuclear power is performed by the Chairman of the Bulgarian Nuclear Regulatory Agency. The ministers of the environment and waters, of health, of internal affairs perform special control in regard to KNPP.

The radiation impact of KNPP operation on the environment is the subject of systematic studies from the plant commissioning to this moment. In order to assess that impact, institutional radiological control is performed according to regulated long-term programs, concurred with the control authorities of the country, including the MEW.

Monitoring of the radiological indicators in the area is performed by the Executive environmental agency (ExEA) and KNPP. The KNPP monitoring system is integrated with ExEA. Data exchange is performed in both directions.

Radiological monitoring of the rivers, lakes and dams in the country is performed through a network of stations and is represented by control of the indicators, according to Regulation No 7/08.08.86 on the indicators and standards for determining the quality of flowing surface waters – total beta-activity ( $750 \text{ mBq/dm}^3$ ), total Uranium content ( $0.6 \text{ mg/dm}^3$ ), Radium-226 content ( $150 \text{ mBq/dm}^3$ ).

Low background activity is typical for the region of KNPP, i.e. content of Uranium, Thorium and products of their radiation decomposition are below average for the country. It is a result of the prevailing sedimentogene origin of the geological formations where the investigated region is located.

Average Uranium concentrations for the waters of Danube River are within  $(2.0 \pm 0.2) \times 10^{-6} \text{ g/dm}^3$  ( $25 \text{ mBq/dm}^3$ ). Due to the considerably low solubility of the compounds of Thorium the river waters are characterized with several times lower concentrations and do not exceed  $0.1 \text{ mBq/dm}^3$ . From the products of Uranium decay the most significant for the Danube River is the availability of the Radium ( $^{226}\text{Ra}$ ) -  $2.7 \pm 0.9 \times 10^{-13} \text{ g/dm}^3$  ( $9.7 \pm 3.4 \text{ mBq/dm}^3$ ). In the sediments of the Danube River and its tributaries the natural existing radionuclide are detected and the concentration levels of  $^{226}\text{Ra}$  and  $^{228}\text{Ra}$  comply with the normal geochemical activity.

Regional spreading of the contamination with  $^{137}\text{Cs}$  is a result mainly of the Chernobyl accident in April 1986. Within the period between 1988 and 2007 it is proven that there is a clearly expressed total reduction of the concentration of  $^{137}\text{Cs}$  activity in the sediment of the Danube River. Due to the reduction of the anthropogenic radioactivity of the river it is not associated with a health risk. There is no anthropogenic impact by industrial sources determined.

Summarized results of the total water activity of the Danube River in the region of KNPP are shown on fig. 3.2.2.1-1. Comparability of the results in different points of the river flow before and after KNPP shows that the unbalanced waters discharged by the generation do not impact the total beta activity.

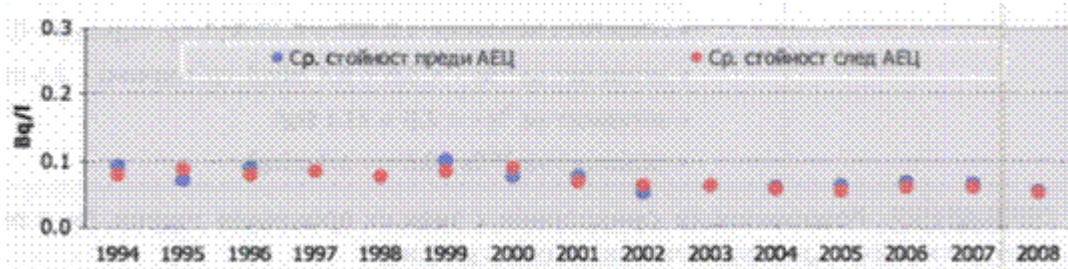

**Fig. 3.2.2.1-1 Summarized results of the total beta water activity of the Danube River within the period 1994 – 2008**

Source: Radiological monitoring of KNPP for 2008, Annual report of KNPP 2009.

Legend:

Ср. стойност преди АЕЦ – Average value before KNPP

Ср. стойност след АЕЦ – Average value after KNPP

Long-term investigations of tritium in the water of the Danube River after KNPP show lower activity than the tritium limit for potable waters – 100 Bq/l (Ordinance 9/2001).

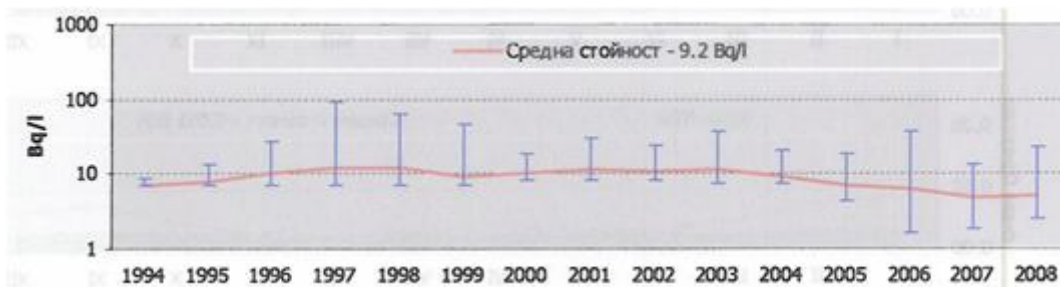

**Fig. 3.2.2.1-2 Summarized results of the tritium water activity of the Danube River within the period 1994 – 2008**

Source: Radiological monitoring of KNPP for 2008, Annual report of KNPP 2009

Legend:

Средна стойност- Average value.

**Table 3.2.2.1-1 KNPP radioecological monitoring of the Danube River**

Controlled object	Controlled parameter	Value (min-max), Bq/l	
		1993 – 2007	2008
Natural waters	Total beta activity	<0.026 ÷ 0.44	0.027 ÷ 0.13
	Tritium	<1.8 ÷ 94	<2.5 ÷ 7.4
	<sup>90</sup> Sr	<0.0006 ÷ 0.015	< 0.0008 ÷ 0.0084
	<sup>137</sup> Cs	<0.0004 ÷ 0.015	<0.0006 ÷ <0.0013
Water from discharge NPP channel	Total beta activity	<0.022 ÷ 0.36	< 0.028 ÷ 0.084
	Tritium	Max 62	<2.6 ÷ 23.1
	<sup>90</sup> Sr	0.0006 ÷ 0.0134	<0.0013 ÷ 0.0029
	<sup>137</sup> Cs	<0.0005 ÷ 0.204	<0.0006 ÷ < 0.0014
Potable water	Total beta activity	<0.030 ÷ 0.69	<0.018 ÷ 0.13
	<sup>90</sup> Sr	<0.0006 ÷ 0.014	<0.0007 ÷ 0.0016

Source: Radiological monitoring of KNPP for 2008, Annual report of KNPP 2009.

Results of the total beta activity of the potable waters in 2008 were within the limits of 0.019 - 0.13 Bq/l (average 0.0490 Bq/l). In all analyzed samples the activity of tritium is below MDA (LLA) (<2.5 - 7.4 Bq/l). Values are much lower than the permissible limits for the potable water – 2 Bq/l for total beta activity and 100 Bq/l for tritium pursuant to Ordinance N9/16.03.2001. Specified results are analogical and commensurable with the ones from the previous years. In 2008 the activity of <sup>137</sup>Cs in all analysed samples is below MDA (LLA) (<0.7 - <1.6 mBq/l). Activity of <sup>90</sup>Sr in the potable waters in 2008 varies within the range of <0.9 - <1.2 mBq/l. Results are similar to the ones of the previous years and are about 1000 times lower than the legal limits (BNRP-2012 [33]).

Radiation status of the water sources in the region completely meets the sanitary limits.

For comparison in table 3.2.2.1-2 there are data about the radiological status of the waters and bottom sediments before the operation of KNPP.

**Table 3.2.2.1-2 Radioactivity of sites from KNPP environment in pre-operation period 1972-1974**

Investigated object	Content of:		
	<sup>137</sup> Cs	<sup>90</sup> Sr	Total β activity
Natural waters, mBq/l	10.0 ± 6.0	7.0 ± 6.0	420 ± 170
Waters from the Danube River, mBq/l	4.0 ± 1.2	12.0 ± 2.0	248 ± 70

Source: Annual report of KNPP, Results from radiological monitoring, 2009.

Comparison shows that apart from the <sup>137</sup>Cs concentration in the bottom sediments, which is increased in comparison with the pre-operation period, all activity indicators of the waters during the last year are lower than the pre-operation period.

In 2009 a systematic monitoring of the Danube River radiation status has been performed at 10 stations (from Novo selo to Silistra) and at 92 more stations along the larger rivers and other water basins in the country (fig. 3.2.2.1.3).

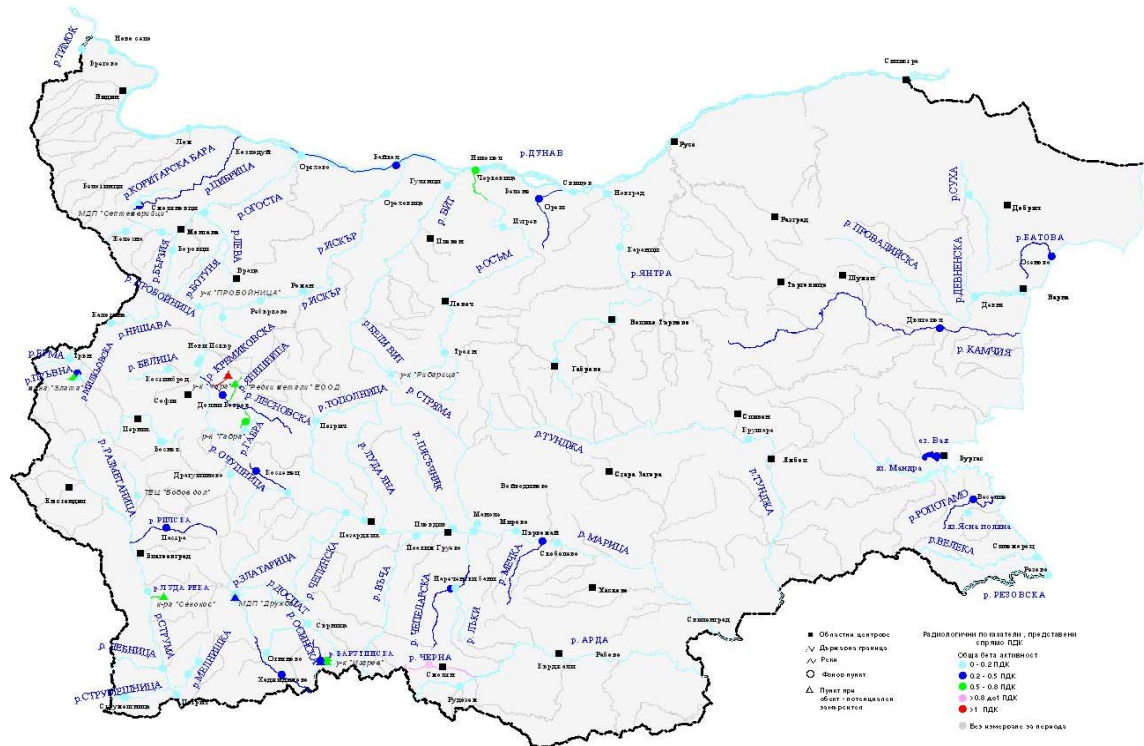

**Fig. 3.2.2.1-3 Monitoring of the Danube River radiation status**

Source ExEA, Annual report on the condition of the environment 2009.

Legend:

- - District centre
- ∕ - Country border
- ∕ - Rivers
- - Background point
- △ - Point at potential polluter's site

Radiological status towards Limits concentration

Total beta-activity

- Light Blue 0 - 0.2 Limit concentration
- Blue 0.2 - 0.5 Limit concentration
- Green 0.5 - 0.8 Limit concentration
- Pink >0.8 up to 1 Limit concentration
- Red >1 Limits concentration
- Grey no measurement during the period

The analysis of the total  $\beta$ -activity data of the Danube River waters and the rest of the main rivers, lakes and dams shows values considerably lower than the Threshold Limit Value (TLV).

This leads to the conclusions that over the year the Danube River and the rest of the water basins in the country have been in good radiation state.

***Radiological monitoring of surface waters from the 100-km area around KNPP and unbalanced water from the plant***

Radiological indicators in the following Rivers flowing within the 100-km area around KNPP are monitored: Danube, Osam, Iskar, Leva, Ogosta, Timok and Tsibritsa.

The analysis of the total  $\beta$ -activity data of the Danube river waters (from Novo selo to Silistra) compared to the waters from the KNPP “discharge” channel in the period 2004-2009 (fig. 3.2.2.1-4) shows values significantly lower than the acceptable limits determined in the legal requirements for the quality of surface waters (0.750 Bq/l). This conclusion also applies to the rest of the studied rivers in the area.

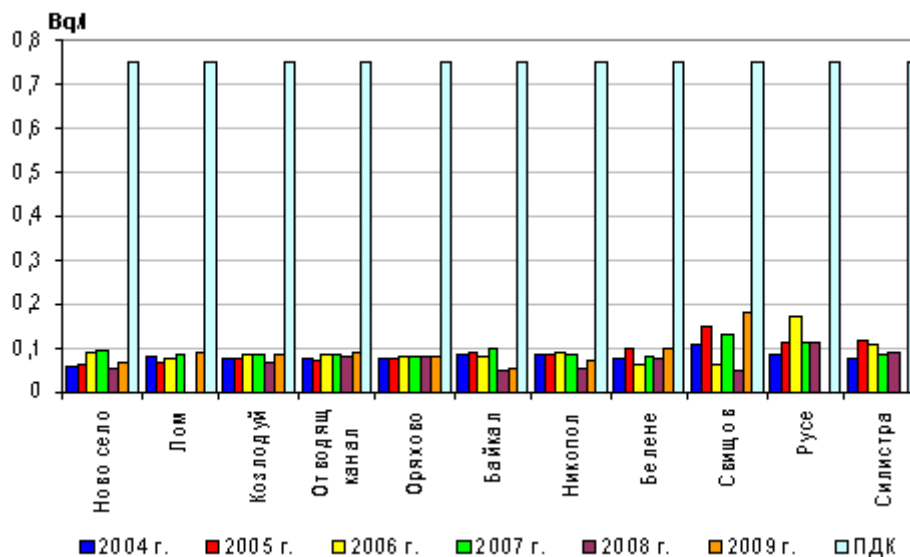

**Fig. 3.2.2.1-4 Total  $\beta$ -activity data of the Danube River in the period 2004-2009, Bq/l**

Source: ExEA

Legend:

Ново село - Novo selo

Лом - Lom

Козлодуй - Kozloduy

Отводителен канал - Drainage Channel

Оряхово - Oryahovo

Байкал - Baikal

Никопол - Nikopol

Белене - Belene

Свищов - Svishtov

Русе - Ruse

Силистра - Silistra

The monthly radiological control of the plant waste waters includes the following stations:

- Danube River at the town of Kozloduy – port;
- Debalanced waters, Units 5-6 – clean area;
- Debalanced waters, Units 5-6 – special area;
- Debalanced waters, Units 1-4;
- Discharge channel (DC);
- Inlet channel;
- New channel "Valyata";
- Old channel "Valyata";
- Danube River at the town of Oryahovo – port.

The ExEA also receives monthly reports on the volume and activities of the debalanced waters as a result from the institutional radiation monitoring of the plant.

The received values of the radiation indicators are significantly lower than the admissible limits (fig. 3.2.2.1-5).

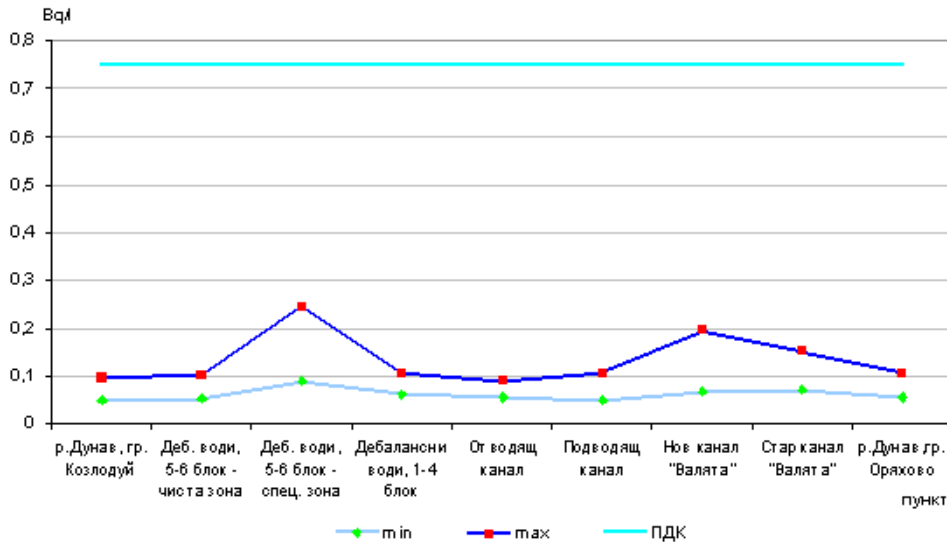

**Fig. 3.2.2.1-5 Total  $\beta$ -activity data of KNPP debalanced waters, Bq/l**

Source: ExEA

Legend:

- р. Дунав, гр. Козлодуй - Danube River, Kozloduy
- Деб. Води, 5-6 блок – чиста зона - Disbalanced water, Units 5&6 – clean zone
- Деб. Води, 5-6 блок – спец. зона - Disbalanced water, Units 5&6 – special treatment
- Дебалансни води 1-4 блок - Disbalanced water, Units 1 to 4
- Отводящ канал - Drainage Channel
- Подводяща канал - Feeding Chanel
- Нов канал „Валията” - New Chanel Valyata
- Стар канал „Валията” - Old Channel Valyata
- р. Дунав, гр.Оряхово - Danube River, Oryahovo
- Пункт - Monitoring Station

The results from the analyses are comparable to those registered in previous years and do not show changes in the radiological characteristics of the Danube River in Bulgarian territory resulting from KNPP operation.



**Radiological status of the 30-km area of KNPP**

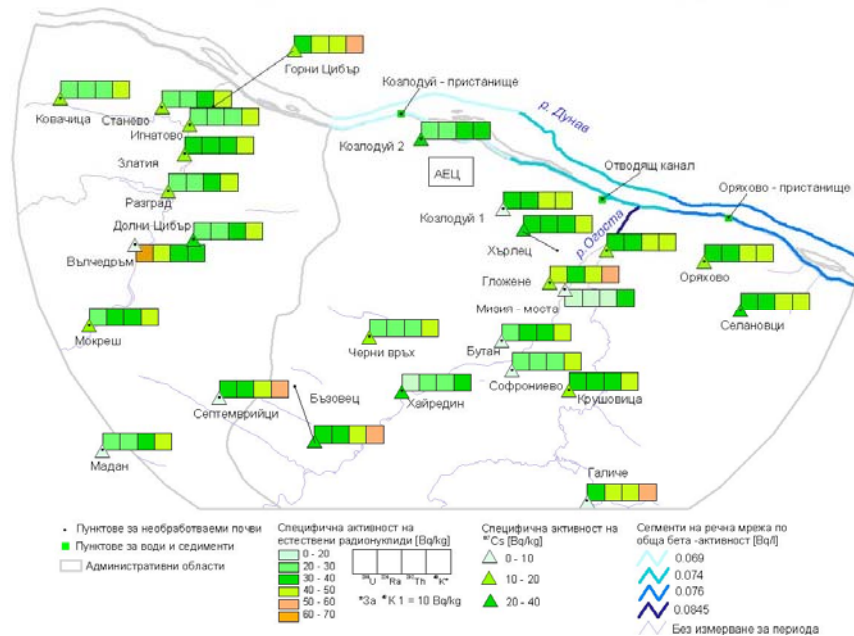

**Fig. 3.2.2.1-6 Radiation status of the environment in the KNPP 30-km area for 2009, Source: ExEA**

Legend:

- Пунктове за необработваеми почви – *Points for non-arable soils*
- Пунктове за води и седименти – *Points for water and sediments*
- Административни области – *Administrative areas*
- Специфична активност на естествени радионуклиди - *Specific activity natural radionuclide [Bq/kg]*,
- Специфична активност на <sup>137</sup>Cs - *Specific activity of <sup>137</sup>Cs [Bq/kg]*
- Сегменти на речната мрежа по обща бета активност – *Segments of the river network according the total beta-activity [Bq/l]*
- Без измерване за периода – *no measurement during the period*

As a result of the performed radiological monitoring by MEW in 2009 within the KNPP 30-km area the overall status of the environment in this area can be observed (fig. 3.3.2.1-6).

The data received in 2009, compared to results from previous years, do not show unfavorable trends in the radiation environment and the ecological status of the environment resulting from KNPP operation.

**Radioactive emissions from KNPP**

The total activity of the debalanced and waste waters released in the “discharge” channel of the plant and from there into the Danube River is lower than the acceptable limit values, allowed by the BNRA. The total activity (without Tritium) is 247 MBq (2009) and for Tritium is 23739 GBq - 0.03 % and 12.8 % from the annual limits, respectively. For year 2010 the total activity for the debalanced waters without Tritium is 289 MBq and for Tritium is 22700 GBq - 0.036 % and 10.2 % respectively.



**Table 3.2.2-1.3 Debalanced and waste waters from KNPP**

Debalanced and waste waters	Total activity 2008	Total activity 2009	Total activity 2010	% from the annual limits, 2008	% from the annual limits, 2009	% from the annual limits, 2010
Volume of Debalanced waters in cubic meters m <sup>3</sup>	49 900	41800	41300	-	-	
without tritium, MBq	186	247	289	0.0023	0.03	0.036
tritium, GBq	18774	23 739	22 700	10	12.8	10.2

Source: BNRA

The received data confirm the efficiency and the proper functioning of the systems and equipment for special processing and purification of the waters from the plant's technological cycle.

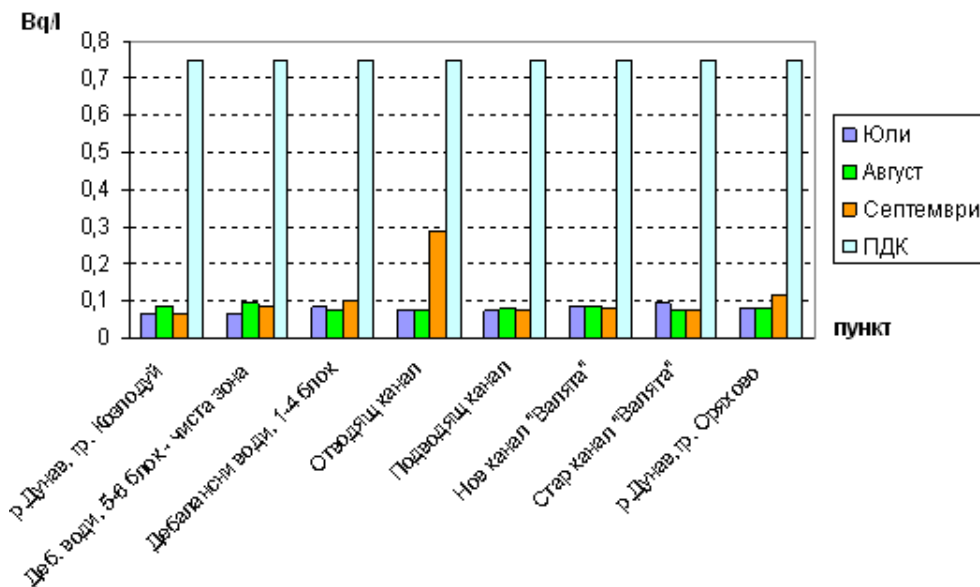

Fig. 3.2.2.1-7 Total β-activity [Bq/l] in debalanced waters of KNPP and the Danube River  
Legend:

р. Дунав, гр. Козлодуй - Danube River, Kozloduy

Деб. Води, 5-6 блок – чиста зона - Disbalanced water, Units 5&6 – clean zone

Деб. Води, 5-6 блок – спец. зона - Disbalanced water, Units 5&6 – special treatment

Дебалансни води 1-4 блок - Disbalanced water, Units 1 to 4

Отводящ канал - Drainage Channel

Подводящ канал - Feeding Chanel  
Нов канал „Валята” - New Chanel Valyata  
Стар канал „Валята” - Old Channel Valyata  
р. Дунав, гр.Оряхово - Danube River, Oryahovo  
Пункт - Monitoring Station  
Юли - July  
Август - August  
Септември - September  
ПДК - Limit concentration

The results from the monthly radiation control of the debalanced waters of KNPP, compared to the Danube River waters, before and after the plant, for the entire year 2010 show that there is no change in the radiological characteristics of the river's waters as result from the plant's operation, and the total  $\beta$ -activity [Bq/l] in debalanced waters of KNPP and the Danube River is significantly lower than the TLV (Ordinance № H-4 from 14<sup>th</sup> of September 2012 for the characterization of surface waters, Prom. SG. issue. 22 of 5 March 2013).

Similar are the results from the studies conducted in 2011. The performed radiological monitoring found no deviations in the measured specific activity of the natural radionuclides in uncultivated soils and bottom sediments, and also showed total  $\beta$ -activity values typical for the region.

The results from the monthly radiation control of the debalanced waters of KNPP, compared to the Danube River waters, before and after the plant, for the third quarter of 2011 are shown in total on fig. 3.2.2.1-7.

The measured values are lower than the TLV (Ordinance № H-4 from 14<sup>th</sup> of September 2012 for the characterization of surface waters, Prom. SG. issue. 22 of 5 March 2013.). There is no change in the radiological characteristics of the river's waters as result from the plant's operation.

### 3.2.2.2 *Quality of the surface waters (non-radiation conditions)*

#### **A. Overall assessment of chemical status of surface waters**

The main indicators that apply to the assessment of the chemical status of surface waters (surface water bodies) at national and European level are the average annual concentrations of the following parameters:

- **Dissolved oxygen (DO)** - key indicator for the metabolism of all aquatic organisms.
- **BOD5 (biochemical oxygen demand)** – this is a measure of the amount of oxygen used by aerobic microorganisms to degrade organic pollutants; it determines water contamination with organic substances.
- **Chemical oxygen demand (COD)** – it determines total contamination of waters.
- **Ammonium nitrogen (NH<sub>4</sub> – N)** - major cause of eutrophication of water, and at high concentrations is toxic to aquatic organisms.

- **Nitrate nitrogen (NO<sub>3</sub> – N)** - stimulates the growth of aquatic plants.
- **Orthophosphates (PO<sub>4</sub>)** – main source for growth of aquatic plants in photosynthesis, but in excessive amounts leads to algae blooms.

The assessment of the main physicochemical indicators is performed based on categorized values under Regulation 7/1986, as follows: I category – very good; II category – good; III category – moderate, and above III category – bad.

In the coming years shall meet the requirements of Regulation № H-4 from 14th of September 2012 for the characterization of surface waters, Prom. SG. issue. 22 of 5 March 2013.

Data is used from monitoring networks for physical and chemical status of surface water and hydro-biological monitoring, which are part of the National System for Environmental Monitoring (NSEM).

**Table 3.2.2.2-1 Standards for the main indicators for assessing the chemical status of surface water**

Indicators	Unit	Category		
		I	II	III
Dissolved oxygen	mg/l	6	4	2
Ammonium nitrogen	mg/l	0.1	2.0	5
Nitrite nitrogen	mg/l	0.002	0.04	0.06
Nitrate nitrogen	mg/l	5	10	20
Phosphates /PO <sub>4</sub> /	mg/l	0.2	1.0	2
Permanganate oxidation	mg/l	10	30	40
BOD5	mg/l	5	15	25

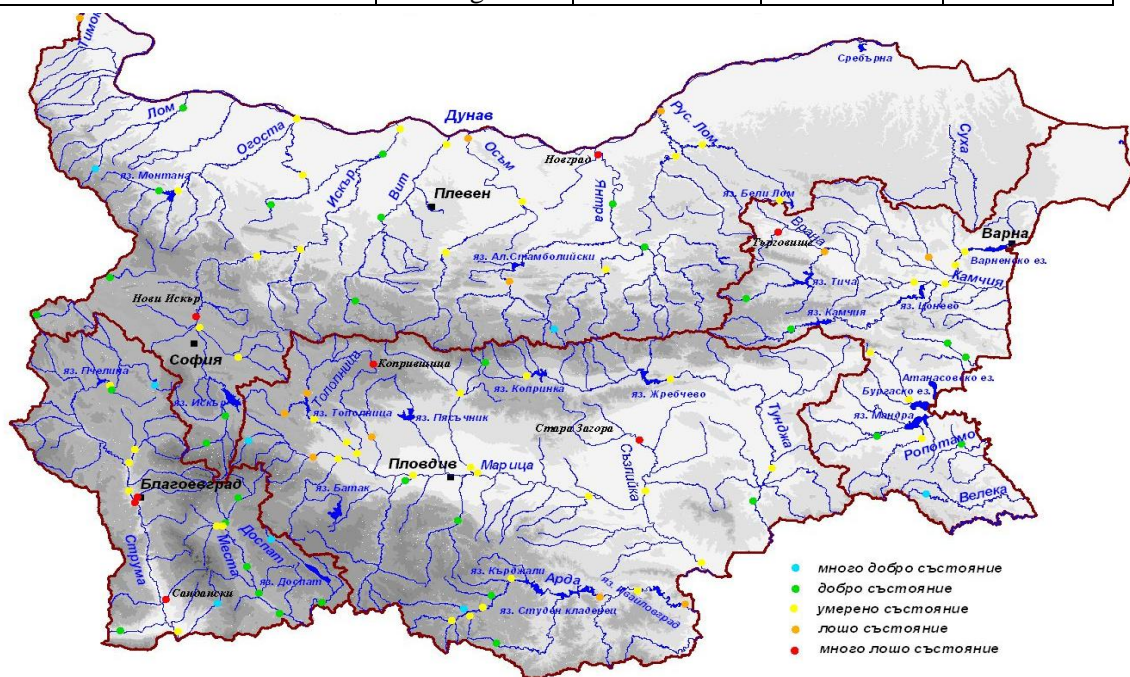

**Fig. 3.2.2.2-1 State of the River waters in Bulgaria in terms of dissolved oxygen, biochemical oxygen demand (BOD5) and chemical oxygen demand (COD) for 2009**

Source: ExEA

Legend:

Blue -Много добро състояние – very good condition

Green Добро състояние – good condition

Yellow Умерено състояние – moderate condition

Braun-Лошо състояние – poor condition

Red- Много лошо състояние – very bad condition

**According to ExEA data** (National report on the state of the environment in Bulgaria in 2009) in the **Danube Basin Department**, good water quality has been maintained in terms of the main indicators - dissolved oxygen, BOD5 and COD, while in terms of biogenic elements single cases of limit exceeding for the third category have been observed.

Based on the gathered information through the National system for environmental monitoring in the period 1990 – 2009, there is a recent trend towards improving of water quality in the Danube Basin Department, although there are still water bodies at risk.

A number of programs with measures concerning these bodies have been included in the Water basins management plan (WBMP) for the Danube region, which aims to fulfill the goals of the Frame directive on waters – good ecological state until 2015.

In the **Regional Development Strategy for Vratsa region 2005 – 2015** the following categories for certain areas of the Danube and Ogosta Rivers are presented (table 3.2.2.2-2).

**Table 3.2.2.2-2 Category of the Danube and Ogosta Rivers**

Start	End	Category
Danube, village Novo selo – border	Danube, Silistra town - border	III
Ogosta after flow-in of Botunya River	Ogosta before flow-in of Skut River	II
Ogosta after flow-in of Skut River	Ogosta before flowing into the Danube River	III

Source: *Regional Development Strategy for Vratsa region 2005 – 2015*.

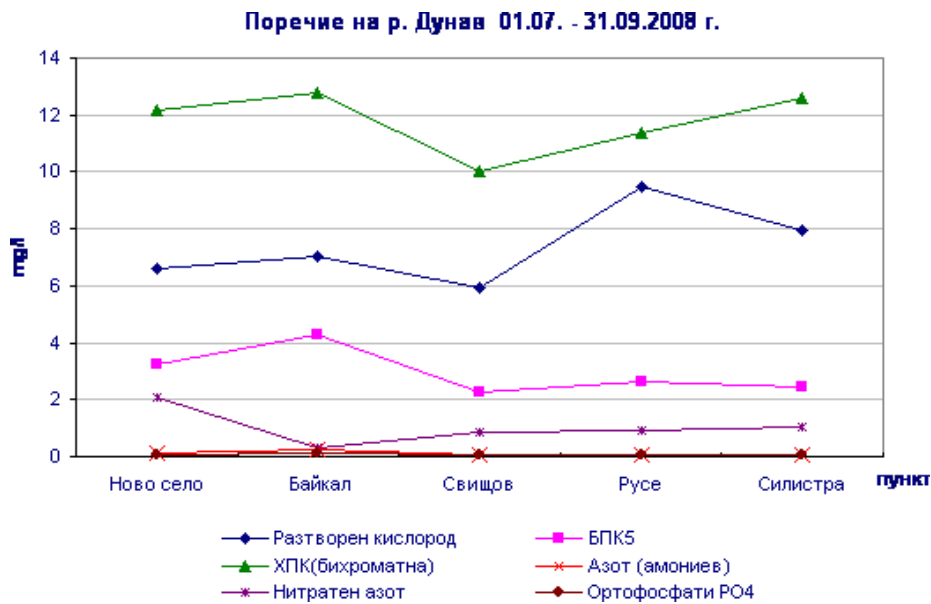

**Fig. 3.2.2.2-2 Values of measured indicators at some stations along the Danube River**

Legend:

Поречие на р. Дунав - Danube River Valley

Ново село- Novo Selo,

Байкал - Baikal;

Свищов - Svishtov,

Русе - Russe,

Силистра- Silistra

Пункт-Station

Разтворен кислород - Dissolved oxygen

ХПК (бихроматна) - COD (bichromatic)

Нитратен азот - Nitric nitrogen

БПК5 - BOD5

Азот (амониев) - Nitrogen (ammonia)

Ортофосфати PO4 - Orthophosphates PO4.

The Executive Environmental Agency conducts monitoring for control of the qualities of the common Bulgarian and Romanian section of the Danube River. 76 points are monitored for the entire Danube basin. In the international monitoring network there are 11 points included, 5 of which are located on the Danube River (Novo selo, Baikal, Svishtov, Russe, Silistra) and the rest are located in the tributaries.

Values of the indicators measured in the points on the riverside of the Danube River, which are monitored by the EEA in the third quarter of 2008 are shown in fig. 3.2.2.2-2.

Values of the measured indicators show that the waters meet the requirements of the water intake of I category.

Values of the indicators measured in some points on the riverside of the Ogosta River are shown on the next figure.

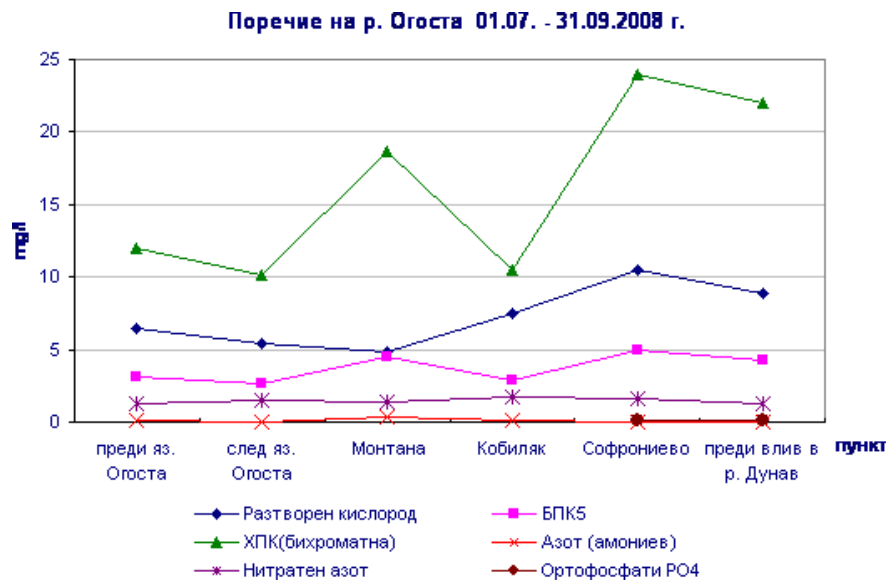

**Fig. 3.2.2.2-3 Values of the indicators measured in some points on the riverside of the Ogosta River**

Legend:

Поречие на р. Огоста - Ogosta River Valley

Преди яз. Огоста- Before Ogosta dam

След яз. Огоста- After Ogosta dam

Монтана- Montana,

Кобиляк-Cobilak,

Софрониево- Sofronievo,

Преди вливане в р. Дунав- Before flow to Danube River

Пункт-Station

Разтворен кислород - Dissolved oxygen

ХПК (бихроматна) - COD (bichromatic)

Нитратен азот - Nitric nitrogen

БПК5 - BOD5

Азот (амониев) - Nitrogen (ammonia)

Ортофосфати PO4 - Orthophosphates PO4

All analyzed samples during the period do not exceed the limit for water intake II category. The measured concentrations in 68 % of the total number of samples from the Danube River basin meet the requirements of I category, 23 % meet II category and 9 % meet III category.

The concentrations of nutrients including phosphorus and nitrogen in the waters of the Danube and its larger tributaries are very important from an international point of view, because they are directly responsible for eutrophication processes within the river and in the Black Sea. There are some indications that the nutrient concentrations along Danube River today are substantially higher than the natural background levels.

The key nutrients affecting the Danube ecosystems and leading to eutrophication processes are phosphorus and nitrogen, both of which enter the river basin from point sources such as municipal, industrial and agricultural facilities, as well as diffuse sources throughout the catchment area, where nutrients originate from erosion and surface runoff, groundwater inflow and atmospheric deposition. A significant share of the nutrients from diffuse sources is of natural origin, but excess nutrients are also widely released due to human activities, notably farming.



In 2007 higher concentrations of nitrates and mostly lower concentrations of orthophosphates were detected comparing to the results of 2001. In general, the average concentrations of priority substances detected tend to be lower than those measured in 2001, especially for organic substances.

### **Ecological status of the Rivers**

Several groups of quality parameters are introduced to classify the ecological state of rivers (according to Regulation No 13/02.04.2007):

- Biological elements: composition and abundance of the water flora, bottom, invertebrate fauna, fish fauna;
- Hydromorphological elements supporting the biological elements;
- Hydrological mode;
- Chemical and physicochemical elements supporting the biological elements, incl. common elements: temperature conditions, oxidizability, salinity, acidification as well as specific pollution.

With an order of the Minister of Environment and Waters No 867/29.11.2007 a hydrobiological monitoring is made of the surface waters. Biological quality elements, which are used in the hydrobiological monitoring of the surface waters are stipulated in the Framework Water Directive 2000/60/EC and Regulation 1/1.04.2011 water monitoring: 1) phytoplankton and other aquatic flora (macrovegetation), 2) macro-invertebrates and 3) fish.

The biological assessment (performed according to a macroinvertebrate fauna methodology approved in 1998) includes the results from performed monitoring of the benthic macro-invertebrate fauna at 144 stations in the Danube region. The assessment has been performed according to the values of the biotic index reflecting the relative abundance of indicator groups. This methodology is used for biological assessment of river waters quality and does not determine the ecological status according to the Water Framework Directive 2000/60/EC. The following evaluation scale is used: BI 1.1–2 - highly contaminated; BI 2.2-3 – contaminated; BI 3 – moderately contaminated; BI 3-4 - slightly contaminated; BI 4.4-5.5 – not contaminated. The evaluation scale used is not type-specific. A gradual introduction of other biological quality indicators is eminent.

The recent year's trend towards best quality of the waters in the Danube basin is maintained. Fig. 3.3.2.2-4 shows the biological evaluation of main rivers.



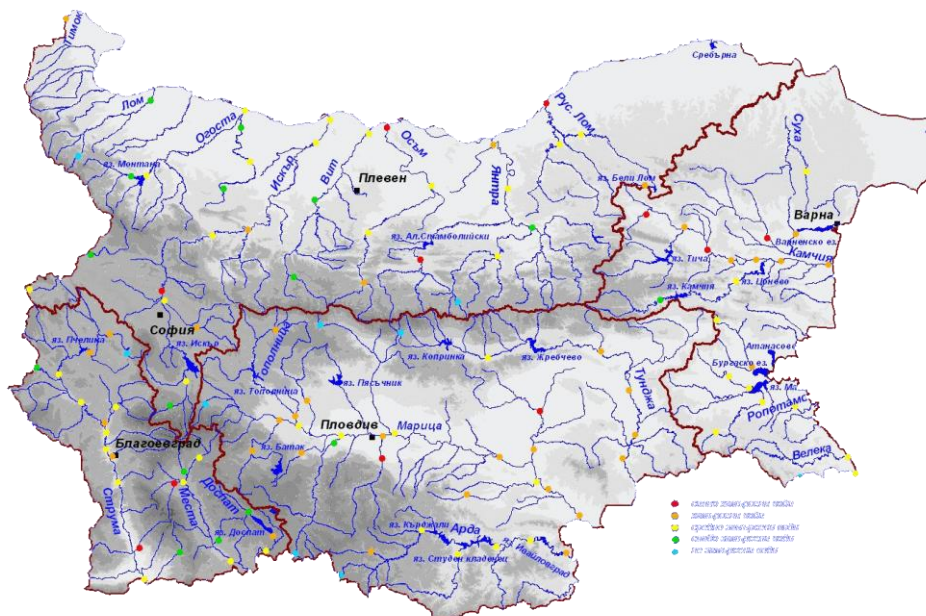

**Fig. 3.2.2.2-4 Biological evaluation of the River waters quality in Bulgaria in 2009**

Legend:

- Red – Very polluted water rivers
- Orange – Polluted water rivers
- Yellow – Average polluted water rivers
- Green – Very low polluted water rivers
- Blue – Not polluted water rivers

The main sources of surface water contamination are point-sources (discharges of sewage networks, discharges with and without complex permits) and diffuse sources of contamination.

Diffuse sources of surface water contamination are the settlements without sewers, landfills for municipal, construction and industrial waste, including land use.

Surface water body **Danube River with code BG1DU000R001** is determined to be a highly modified water body. On Bulgarian territory 95 point-sources of contamination are discharging into that water body.

Surface water body **Ogosta River with code BG10G100R014** is also determined to be a highly modified water body. On Bulgarian territory there are 42 point-sources of contamination discharge into that water body.

The geographical borders of these **vulnerable areas** have been determined by an Ordinance of the Minister of environment and waters. These borders comprise much of the Danube valley, which is the Danube region of the Water basin management, including the rivers in this region. Determination of the identification criteria for the vulnerable areas, subject to or threatened by contamination resulting from agricultural activity, is based on the assumption that increased nitrate load from agricultural sources is concentrated in areas with intensive crop and animal production.

**УЯЗВИМИ ЗОНИ НА ТЕРИТОРИЯТА НА  
 БАСЕЙНОВА ДИРЕКЦИЯ ДУНАВСКИ РАЙОН**

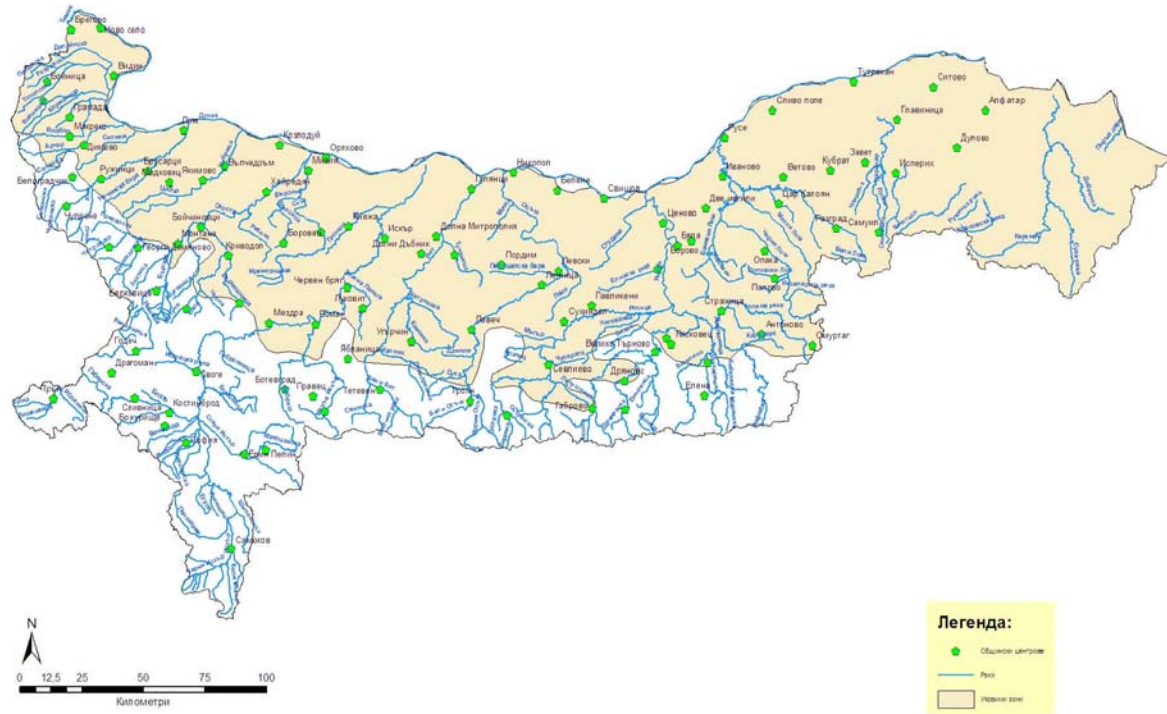

**Fig. 3.2.2.2-5 Vulnerable areas within the Danube Basin Directorate**

Legend:

- Green – Municipal centers;
- Blue – Rivers,
- Pink rectangle – Vulnerable area.

According to the Ordinance of the Minister of Environment and Waters, the Danube River and all waters within the Danube draining basin are announced as vulnerable areas within the Danube Basin Department. Agglomerations with population over 10 000 people that discharge directly into vulnerable areas must provide facilities for removal of the biogenic elements nitrogen and phosphorus. Based on assessment of the significant loads on the water bodies and their vulnerability to such loads, initial identification has been performed of the water bodies that may not fulfill the ecological goals for good status, determined in Article 4 of the WFD. For this purpose, existing monitoring data on surface waters and emissions have been used, and in cases when there are no sufficient data or data are not available, expert assessment has been used.



**Fig. 3.2.2.2-6 Risk assessment of impacts on surface water bodies**

Legend:

- Green line- without risk,
- Blue line – possibly in risk,
- Red line – in risk,
- Blue rectangle – possibly in risk.

The enclosed map shows that surface water body *Danube River with code BG1DU000R001* may not fulfill the goals for good ecological state determined in the WBMP.

#### **Conclusions:**

- Surface water body Danube code BG1DU000R001 is defined as a heavily modified water body category River.
- Ecological potential of the surface water body is moderate and the chemical status is poor.
- Environmental objectives for surface water body Danube code BG1DU000R001, is: “Prevent deterioration of the ecological potential and achieve good status until 2021. Prevent deterioration of chemical status and achieve good until 2027.”
- For Danube code BG1DU000R001 water body is introduced except by achieving environmental objectives, because of the significant anthropogenic influence.

#### **Own non-radiation monitoring of the environment in the KNPP area**

In accordance with KNPP programs, monitoring of surface waters and waste waters is

performed.

Detailed results for the quality of surface waters and waste waters, gathered through KNPP monitoring and summarized in “Annual report on the results from the **own non-radiation monitoring of the environment in the KNPP area**” for 2009 and 2010 are used for the assessment.

### Control of used surface and ground waters

The use of surface and ground waters by the company is done under the conditions of the issued permits for water use, as follows:

- Permit No 0562/2005 for use of waters from the Danube River for cooling, production of chemically desalinated water, and electrical power production through WPP at DK-1;
- Permit No 11530127/30.05.2008 for use of ground water through SW-1 (shaft well 1-6) for emergency technical water supply of Units 5 and 6;
- Permit No 11530128/30.05.2008 for use of ground water through SW “Raney-5” for industrial and fire safety purposes;
- Permit No 11590203/30.05.2008 for use of ground water through SW “Valyata” for sanitary and domestic purposes for Units 1-4;
- The quantities of used waters from the Danube River are about 51.2 % from the allowed limit for 2010 and about 52 % for 2009, and those of used ground waters – only 9 % for 2010 and 2% for 2009.

In refer to the following table 3.2.2.2-3 shows the necessary water quantities used for technical water supply between 2006 and 2010 Kozloduy NPP.

**Table 3.2.2.2-3 Annual quantities of water used for technical and household water supply**

Place of water intake	Permitted quantity [thousand m <sup>3</sup> ]	Used amount [thousand m <sup>3</sup> ]				
		2006	2007	2008	2009	2010
Surface water from the Danube River	5 000 000	334 22	2 323 800	2 629 876	2 593 459	2 564 530
SW1 (shaft well 1-6)	788.4	0	0	0	0	0
SW “Raney-5”	7 884	190	314	75	16	24
SW “Valyata”	1 600	291	183	204	192	193

Source: Annual reports of IHNRM in KNPP for 2006, 2007, 2008, 2009 and 2010

According to the table № 3.2.2.2-3, the amount of surface water taken from the river Danube in 2010 was approximately 51.2 % and approximately 52 % for 2009, and groundwater 9 % in 2010 and 2 % in 2009.



Consumption of water from underground sources is insignificant relative to the total amount used by the Kozloduy NPP water. It is relatively constant and is determined by the lowering of groundwater levels and desire it to be kept constant.

### **Drinking water supply**

For drinking water is primarily used water from the city water supply system of the town of Kozloduy, as it has signed a contract with "Water supply and sewerage" Ltd. - Vratsa and water from its own sources.

### **Technical water supply of Kozloduy NPP from the Danube River**

Technical water supply scheme of Kozloduy NPP of the Danube River is single flow. It provides:

- Circulating water - for cooling the turbine condensers;
- Technical water - for cooling the other facilities.

Overall reduction in the consumption of water for industrial purposes in 2010, compared with 2006, before the shutdown of Units 3 and 4 is 38 %.

During the period 2006 – 2010, the main amount of incoming water masses are used for cooling. The amount of surface water taken from the Danube River in the period represents about half of the quantity, namely: in 2006 about 67 % of permitted ones in 2007 - about 46% of the permitted and in 2008 - about 53 % of the permitted, around 52 % for 2009, about 51.2 % in 2010. Extracted groundwater represent 5 % of the allowance in 2006 and 2007., Only 2.7 % of the permitted - in 2008, 2 % of the permitted in 2009, 9 % of the permitted in 2010.

### **Conclusions:**

- The main amount of water for technological needs is the Danube, as surface water taken from the Danube River average amount of about 51-53 % of the permitted water quantity;
- The amount of groundwater used does not exceed an average of 2 to 4 % of permitted;
- In recent years, a decrease of water consumption for drinking water.

### **Waste waters monitoring**

Generated waste waters are discharged into the Danube River through DC-1 and DC-2 and into the Main drainage channel (MDC). The Danube River receives also the waters from MDC. The company has two permits for discharge of waste waters:

- Permit No 13120037/22.11.2010 for discharge of waste waters through DC-1 and DC-2;
- Permit No 13750001/20.04.2007 for discharge of waste waters into MDC. Amended and extended by Decision № 216/25.02.2010. Amended by Decision № 494/08.08.2011.
- Permit No 13710063/27.07.2011 for discharge of waste waters from Ledenika Recreation Center.

The assessment of the allowed and generated waste water quantities for 2009 and 2010 shows that the quantity of discharged waste waters is less than allowed;

- In 2009 and 2010 the quantity of discharged waste water are smaller than those permitted;
- The quantity of waste waters discharged through DC-1 for 2010 exceeds the allowed limit, but the total quantity of discharged waters through DC-1 and DC-2 does not exceed the allowed limit for both channels.

Kozloduy NPP generates following waste water streams:

- The water used for domestic purposes;
- Conditionally clean waters - waters for industrial purposes, which are mainly used for cooling;
- Rainwater that are casual.

Water from sewage system that are not in the controlled area, and rain water fell within the production site of Kozloduy NPP normally does not contain radionuclides above background levels. In the EP-1, control is performed only by sampling water discharges into leading off canals. Household waste water from the controlled area of the EP-1 is treated in the same way as industrial water from these areas.

*Conditional clean technical waste water* - The flow of cooling water (circulating water) after the consumer service water discharge into DC 1 through a system of low pressure channels.

Besides circulating and technical water after consumers, LPC (for Units 1-4 and directly to DC-1) was released and water having the character of industrial wastewater.

Discharge water that is obtained after purification of radioactive industrial waste water and steam condensate coolant system after special water purification, enters the intermediate reservoirs, where the receiver is disposed after analysis and radioactivity less than norm.

The technology of purification of radioactive water by evaporation, ensure that in meeting the standards for radioactivity in discharges of harmful and hazardous substances does not exceed the specific limit values according to the permit issued to the KNPP.

The origin and quantities formed in 2006, 2007, 2008, 2009 and 2010 wastewater compared to the permitted are as following:

**Table 3.2.2.2-4 Origin and quantities generated in 2006 -2010 wastewater**

Canal/discharge №	Origin of Water	Authorized quantity [thsd m <sup>3</sup> ]	Formed quantity [thousand m <sup>3</sup> ]				
			2006	2007	2008	2009	2010
Stream №1 (HCC – MDC)	Technical, household and rain waters from EP-1	3 900	≈3 598	1 781	498	≈610	620
Stream №2 (F300 – MDC)	Household water after purification complex of EP-2	450	487	573	527	194	65
Stream №3 (F100– MDC)	Treated technical water from TH and DGS and more.	6 600	≈6 638	6 639	7 360	≈4 564	1980
Stream №4 (ODD – MDC)	Domestic wastewater from outdoor switchgear	1095	≈1072	not measured	not measured	not measured	1000
Stream DC1, DC2 – Dunabe	Cooling and process water from the EP-1	3 280 000	3 178 688	2 250 449	2 536 387	2 383 715	2 416 456

In 2006, by DC 1 and MDC № 1 are discharged into the Danube River about 97 % of the quantities.

Quantities of waste waters from F300 and F1000, discharged into the main drainage canal exceeds allowable amounts for 2006-2010. Exceeding permitted levels was also seen in 2006 to 2008, then in 2009-2010 there were no exceedences.

In 2008, after cessation of units 3 and 4 (2006), a decrease by 23.4 % on the total amount of wastewater discharged into the Danube River, that trend continued in the next observation period 2009-2010.

In assessing the quantity authorized wastewater and formed amounts of workshop “Hydro Technology facilities and building structures” for 2009, 2010 can be noted:

- In 2009 and 2010 quantities of discharged waste water into MDC are significantly smaller of the permitted;
- The amount of water discharged by DC-1 waste water into the Danube River in 2010 exceeds the maximum allowed, but the total amount of water discharged by DC-1 and DC-2 does not exceed the maximum for the two channels, which is 3 280 million m<sup>3</sup>;
- Generated waste water from modular treatment facility are within the allowance.



In pursuance of the developed by Kozloduy NPP "Program for in-house non-radiation monitoring of emissions to air and water from the Kozloduy NPP, adept. № UK.UOC.PM.013 monitor the quality of effluent discharged into the Danube by DC1 and DC-2 and main drainage canal (MDC).

In 2009 and 2010 the waste waters samples were analyzed by accredited laboratory – Vratsa and the KNPP laboratories.

The results compared to the individual emission limits (IEL) are as follows:

Discharge in HCC (hot circulation channel) – All registered values are below the individual emission limits determined for this channel in the permit, excluding the “boron” indicator, for which the limit is “not allowed” (table 3.2.2.2-5).

**Table 3.2.2.2-5 Exceedances of individual emission limits observed for the indicator "Boron"**

Indicator	Number of analyzed samples	Number of exceedances	IEL, mg/l	Average value, mg/l	Maximum value, mg/l
Boron	4*/4**	3/4	not allowed	0,07/0,04	0,09/0,115

\*2009; \*\* 2010

Discharge in F1000 - Exceedances of individual emission limits were observed for the “boron” indicator (table 3.2.2.2-5) for both years and for total nitrogen, BOD<sub>5</sub> and phosphorus for 2009.

In 2010 there are no exceedances of individual emission limits for indicators nitrogen, total phosphorus and BOD<sub>5</sub> specified for the flow permit for discharge of wastewater.

Discharge in Open distribution devices (ODD) – In 2009 in switchyard on a check an infringement was cited and penalty decree has been issued. After identifying the causes measures has been taken to prevent future infringements.

In 2010, all recorded values were below the individual emission limits established for this flow with the permit for discharging wastewater.

**Table 3.2.2.2-6 Exceedances of individual emission limits of the observed indicators**

Indicator	Number of analyzed samples	Number of exceedances	IEL, mg/l	Average value, mg/l	Maximum value, mg/l
Boron	2/4	1/4	not allowed	0,095/0,06	0,19/0,1427
BOD <sub>5</sub> (2009 only)	2	1	15	15,6	24,8
Total nitrogen (2009 only)	2	1	15	12,3	15,9
Total phosphorus (2009 only)	2	2	2	2,46	2,75

DC-1- Single exceedance of the individual emission limits in 2009 was only observed for the indicator "residual chlorine" in the second quarter (table 3.2.2.2-7). Such excess was not typical in 2008, but has also been observed in 2007.

In 2010, no exceedances of the individual emission limits established for this flow with the permit for discharging wastewater.

**Table 3.2.2.2-7 Exceedances of individual emission limit of the observed indicator “Residual chlorine” (2009)**

Indicator	Number of analyzed samples	Number of exceedances	IEL, mg/l	Average value, mg/l	Maximum value, mg/l
Residual chlorine	4	2	0,1	0,12	0,18

DC-2 – In 2009 single exceedances was registered for the “residual chlorine” indicator – 0.16 mg/l. In 2010 no exceedance of IEL established for this flow with the permit for discharging wastewater. Summarizing the results of analyzes, we can conclude that only in waste waters discharged in MDC small values of the “boron” indicator for 2010 were registered, and that is a violation.

Summarizing the results of analyzes, we can conclude that only in waste waters discharged in MDC small values of the “boron” indicator for 2010 were registered, and that is a violation.

There are no exceedances of IEL for this channel in the permit for discharge of waste waters for 2010. A single exceedance of IEL was registered for the “residual chlorine” indicator – 0.16 mg/l.

Summarizing the results of analyzes, we can conclude that only in waste waters discharged in MDC small values of the “boron” indicator for 2010 were registered, and that is a violation.

Samples of drinking water and water from the Danube used in the Kozloduy NPP shows the boron content 0.04 mg/l.

For 2009 there are some exceedances of IEL for the “residual chlorine” indicator at DC-1, which were not observed in 2008, but were observed in 2007.

In 2008 and 2009 relatively frequent exceedances of IEL for the “total phosphorus” indicator were observed in the F300 waters.

### **Conclusions:**

Considering the results of the analysis can be summarized that in 2010 only in the waste water discharged into MDC are registered small values of the "boron", but they are within the values reported in the drinking water of the town of Kozloduy and Danube river water.

### **Monitoring of waste waters from the Repository for Conventional Municipal and Industrial Waste (RCMIW)**

In the facility, two types of waste waters are generated, for which separate collecting shafts (CS) have been constructed:

- For infiltration – CS – 4;
- For municipal and surface water – CS-7

After radiation control, the waters from both shafts are transported by a cistern to the EP-2 neutralization pit, and from there by low-head channels enter DC-1. End water intake of the waters is the Danube River.

The quantity of waste waters from the RCMIW (around 839 m<sup>3</sup>/y) represents less than 0.3 % from the quantity of waste waters from the EP-2 neutralization pit (311620 m<sup>3</sup>).

In the leachate from the landfill and the wastewater from the site of RCMIW more sensitive indicators are insoluble substances and oil.

From the accompanying tables 3.2.2.2-8 and 3.2.2.2-9 of aggregates on the physico-chemical studies of the leachate (SW - 4), insoluble substances tend to their decrease in 2010 compared to 2009. Quite the opposite can be said about the quantity of petroleum

For waste water (household and surface) from the landfill will have an increased amount of suspended solids in 2010 while the quantity of petroleum in both years is almost the same (tables 3.2.2.2-8 and 3.2.2.2-9) .

**Table 3.2.2.2-8 Aggregated indicators from RCMIW waste waters study for 2009**

Point	Studied indicator						
	pH	Insoluble substances, mg/l	Petroleum products, mg/l	Iron, mg/l	Copper, mg/l	Chromium, mg/l	Zinc, mg/l
CS-4	7,6-8,18	24-100	0,1-1,2	0,380-2,37	0,0024-0,008	0,01	0,021-0,052
CS-7	7,84-8,43	9-36	0,2-1,9	0,06-0,52	0,0013-0,0095	0,01	0,014-0,034

Certain exceedances are found for the “Petroleum products” indicator, most probably caused by leaks from the transport machinery

**Table 3.2.2.2-9 Aggregated indicators from RCMIW waste waters study for 2010**

Point	Studied indicator						
	pH	Insoluble substances, mg/l	Petroleum products, mg/l	Iron, mg/l	Copper, mg/l	Chromium, mg/l	Zinc, mg/l
CS-4	7,72-8,08	17-37	0,1-0,4	0,136-0,467	0,0057-0,0094	0,0051-0,01	0,003-0,006
CS-7	7,31-7,8	16-176	0,2-1,6	0,024-0,602	0,0027-0,0085	0,013-0,01	0,003-0,016

It can be concluded that there is no steady trend of change in the controlled indicators.

### 3.2.3 Hydrogeology

#### 3.2.3.1 Location and geomorphologic structure

KNPP is located between the Harlets Village and the Kozloduy Town. On the geomorphologic point of view the power plant is located on the non overflowed terrace of the Danube River and the hydro-technical facilities (cold, hot channel and BPS) are located on the flood plain. Both terraces form the Kozloduy low land.

Landscape of the non-overflowed terrace is a plain of average 35 – 40 m altitude. A rise in the south-west part marks where there is a steep slope batter between the flood plain and the non-overflowed terrace. Also, there is a rise monitored in the north-west part and the rise is related to the process of formation of the loess deposits in the border of non-overflowed terrace. Overflowed terrace where the hydro-technological facilities are constructed is also of plain landscape. Average elevations are between 26 and 30 m.

Border between both terraces is marked with a terrace slope of 5-6 m height.

In the overflowed terrace there are protection facilities (protection dikes), which protect the Kozloduy low land against overflowing in case of high waters of the Danube River. Besides, in the low land there are a lot of hydromeliorative facilities constructed including drainage and irrigation channels.

### ***3.2.3.2 Geological and hydrogeological prerequisites***

From the hydrogeological point of view the Neogene lithostratigraphic units are the most important for the Kozloduy low land - Archarska and Brusarska formations as well as the Quaternary alluvial and loess sediments.

Within the range of the site of KNPP (according to the data from the drill works) in the lower parts of the section there are sands of up to 16 m thickness coming above the coal (0.5 m). Thickness of the sediment rocks of the Brusarska formation vary from several meters to 40 – 50 m, and sometimes it is up to 70 m, but their age is dacian-romanian.

On the grounds of the performed investigations it was defined that the Brusarska formation is an underlying of the quaternary alluvial strata has and nonuniform surface. In the northern and south-west parts they could be also discovered at higher elevations (22.0 m) and gradually to the north and northeast direction they drop down to elevation 12.0 m.

Section of the Quaternary is constructed by several lithologic types of sediment rocks. In the region of KNPP and next to it within the scope of the Quaternary three sections are recorded.

Gravels origin from Eo-Pleistocene and they are kept on the ridge parts at a relative height of 90-100 m from the contemporary river levels. Pleistocene sectional imprint lithography-facial respect is composed of several genetic types of sedimentary rocks-proluvial, alluvial, alluvial-proluvial, eolichni and eolichno-proluvial-alluvial. In sections of the spatial lithological Pleistocene can be separated two parts: lower - loamy gravel and upper - loess and loess formations.

Gravel, among which there are always layers and lenses of sand in the lower part of the Pleistocene are of alluvial origin.

Site of KNPP and communication to it in the restricted area is situated on (at a depth under the loess) gravels and sands of ancient paleobeds of one of the paleobranches of the Danube that are the biggest and most important natural water-saturated lithofacial area. Thickness of these alluvial sandy-gravel materials varies within wide range - from the first several meters up to 10 –12 m.

The upper part of the Pleistocene section is made of loess and loess-type formations that are widely spread into the region. These materials are undoubtedly of Eolithic origin. As loess varieties in the region and next to it the sandy and typical loess are determined. In this case the sandy loess is available only alongside the Danube River between Kozloduy and Oryahovo.

The youngest Quaternary sediment rocks are the Holocene ones, which come with a wash out and they are cut into the Pleistocene on the temporary rivers, but also in the Neogene/Pliocene. Within the range of the contemporary rivers these alluvial are represented mostly by gravels and sands and above them sandy loams and clays are available.

### **3.2.3.3 Hydrogeological conditions**

Both terraces of the Kozloduy low land in the region of KNPP are respectively the non-overflowed terrace - of Pleistocene age and the overflowed terrace - of Holocene age. It is determined that both terraces form common Quaternary aquifer distributed in the quaternary alluvial deposits and especially in the gravel-sandy sediment rocks, which as per their nature are paleobeds of the Danube River.

For the interlayer (aquitard) of this aquifer the gray and gray-green clays of the Brusarska formation (Pliocene) are used, but at some places under the gravels there are fine-grained sands of the same formation available that could be discovered as lens and thin interbeds and then the aquitard is imperfect. In these sections the supply of the quaternary aquifer is made by the aquifers located under it.

The top rock of the quaternary aquifer in the non-overflowed terrace is made of loess materials (sandy loess, clayey loess and loess clay), and at the overflowed terrace these are the powder-sandy loams.

Main facilities of KNPP are located on the non-overflowed terrace of the Danube river. Average elevation of the ground surface for Units 1- 4 is 35.00 m, and for Units 5– 6 are 36.50 m. On the lithostratigraphic point of view the non-overflowed terrace has two layers from top to bottom:

- First (upper) layer is constructed of loess materials (sandy loess, clayey loess and loess clay). It is of lower water impermeability. In it the western and southern part the sandy loess prevails and in the central parts the loess is developed with its three lithologic varieties. Its thickness is changed from 14-15 m to 11-13 m and respectively elevations from 25-23 m to 24-22 m;
- The second (lower) layer consists of gravel-aggregates-sandy alluvial depositions, where the quaternary aquifer is available. Its thickness changes from 1-2 m to 10-11 m, average 6-7 m and respectively elevations 17-10 m.

During the past investigation works in no groundwater was detected in the loess materials. Drillings are made in dry by manual drills and in this way it was determined that the occurrence and level of the groundwater of the Quaternary aquifer is changed from 9.60 to 10.50 m, respectively at elevations 26 m to 27 m and between 10.60 – 12.50 m, equal to elevations 24.50-22.50 m.

This shows that the water level of the groundwater occurs slightly above the water

saturated gravels and sands in the loess materials so as per their hydraulic nature the aquifer is one semi-pressured aquifer. With this difference between the depths where the water saturated rocks are distributed and the water level occurs indirectly the value of the capillary increase of the loess materials is determined, which fluctuates between 1.20 – 1.60 m.

For determination of the filtration parameters of the Quaternary aquifer during the specified stages of investigation some filtration works were executed on the test sections by water pumping drainage and monitoring drills. Results of these tests are as follows: For the region of Units 1 – 4 the filtration ratio changes from 45 m/d to 100 m/d, average  $K = 70$  m/d and respectively the conductivity ratio is  $T = 500$  m<sup>2</sup>/d; For the region of Units 5 - 6 the filtration ratio changes from 45 m/d to 135 m/d, average  $K = 100$  m/d and respectively  $T = 700$  m<sup>2</sup>/d.

Increasing of the filtration parameters values from east to west is a result of the change of the size of gravel-sandy alluvial, their better wash-out, feed up with groundwater from west from the overflowed terrace in case of high water levels of the Danube river and from the sandy loess, which in the western part is a top rock of the aquifer. Water discharge ratio ( $\mu$ ) for the Quaternary aquifer is 0.004 up to 0.007 and the gravity water discharge ratio is 0.15 up to 0.2. The main factors influencing the mode of the groundwater from the Quaternary aquifer of the Kozloduy low land are Danube river and hydrotechnical and hydromeliorative equipment constructed there. Next to the river (up to 500 m) the impact is most significant. Change of the water level of the groundwater follows the change of the river level. The recede from it (up to 2 km) gradually reduces its impact.

The results of the drilling studies show that concerning KNPP site the Danube river influence is negligible. As per data by Energoproekt from 1991 a relationship between the fluctuation of the river level and the groundwater table in the alluvial aquifer is proven. Course of the head changing in the bed follows the one of the river level but it is with very smaller amplitude and is more gradual.

The following groundwater bodies (UWB) are identified in the KNPP site area:

- Quaternary pore waters – Kozloduy lowland – UWB with code BG1G0000Qal005;
- Quaternary pore waters – between Lom and Iskar Rivers- UWB with code BG1G0000QPI023;
- Neogene pore waters – Lom-Pleven depression - UWB with code BG1G00000N2034;
- UWB with code BG1G0000Qal005 has an area of 39 km<sup>2</sup>.

Operational resources amount to 2130 l/sec, and the operational resources unit is 426 l/sec/km<sup>2</sup>. Water abstraction amounts to 426 l/sec, and free water quantity is 579 l/sec. For drinking and household water 3150847 m<sup>3</sup> are used, and for industrial use - 1603100 m<sup>3</sup>. In terms of point sources of contamination the UWB is in good state, and in terms of diffuse sources of contamination - in bad state. The UWB is at risk in regard to the chemical state.



Environmental objectives for groundwater body code BG1G0000Qa1005 is "Save the good condition of the water body." Groundwater body is defined as a zone of protection of drinking water in accordance with Article 119, Paragraph 1, Item 1 of the Water Act code BG1DGW0000QaL005. Status of the zone is poor.

UWB with code BG1G0000Qpl023. Chemical and quantitative status of groundwater body are **good**. Environmental objectives for groundwater body code BG1G0000QPl023 is "Save the good condition of the water body." Groundwater body is defined as a zone of protection of drinking water in accordance with Article 119, Paragraph 1, Item 1 of the Water Act code BG1G0000QPl023. Status of the zone is **good**.

UWB with code BG1G00000N2034 has an area of 3065 km<sup>2</sup> and is in good state in terms of point and diffuse sources of contamination; it is not at risk in regard to the chemical state. Operational resources amount to 1040 l/sec, and the operational resources unit is 0.34 l/sec/km<sup>2</sup>. Water abstraction amounts to 86 l/sec, and free water quantity is 426 l/sec. For drinking and household water 2646316 m<sup>3</sup> are used, and together with quantities for industrial and irrigation use total water use reaches 2701007 m<sup>3</sup>. Chemical status of the water body is **poor**, with deviation indicator nitrates due to diffuse sources of pollution. Quantitative status of groundwater body is **good**. Environmental objectives for groundwater body code BG1G00000N2034 is

Environmental objectives for groundwater body code BG1G00000N2034 is "Achieving good status of groundwater body." Groundwater body is defined as a zone of protection of drinking water in accordance with Article 119, Paragraph 1, Item 1 of the Water Act code BG1DGW00000N2034. Status of the zone is **good**.

For the protection zones of drinking water specific environmental goal is "reducing the need for water treatment before use and ensure the project amount in water intake facilities by 2015.

Kozloduy NPP not within the area of water protection under Art. 119a, para. 1, item 5 of the WA.

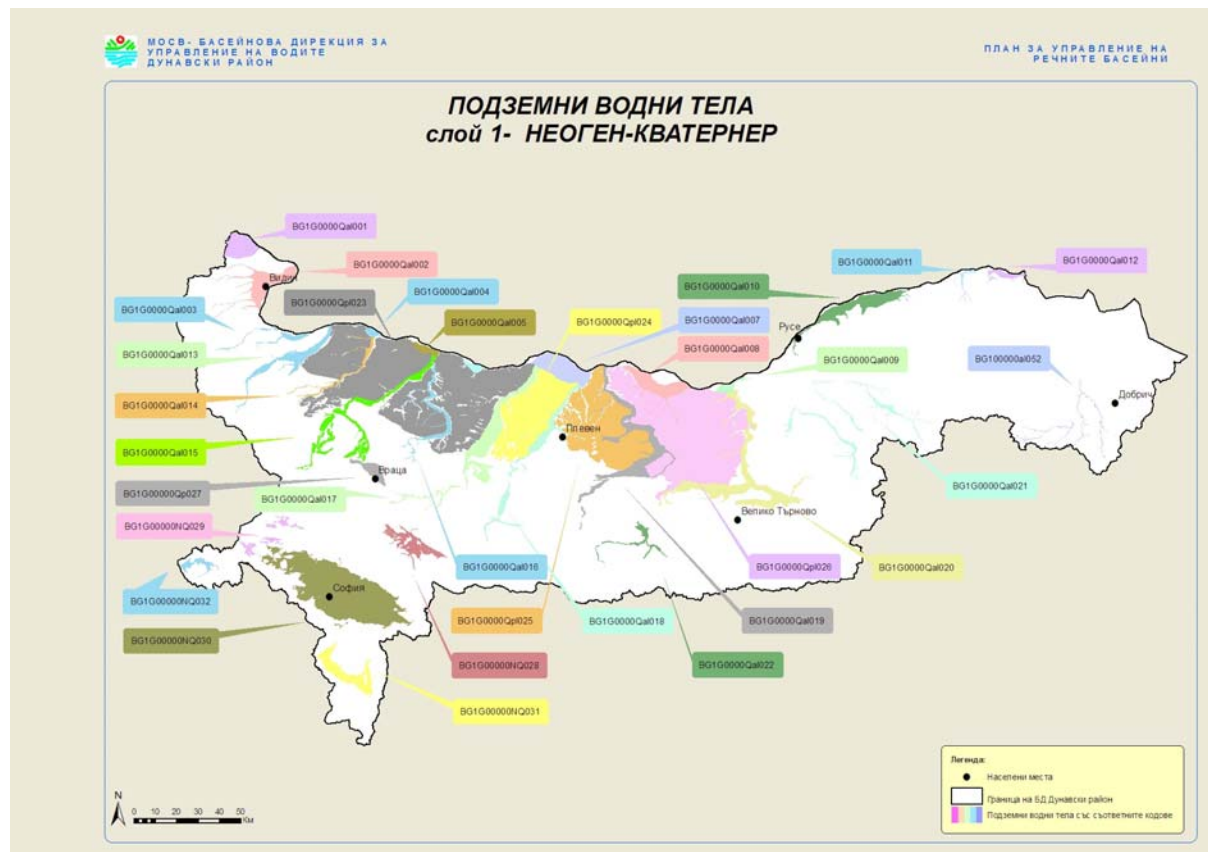

**Fig. 3.2.3.3-1 Groundwater bodies in the Neogene-Quaternary**

Legend:

- Black point – settlements
- White rectangle – ‘Danube River’ Basin Directorate border
- Colours – underground waters with the respective codes

### Quality of ground waters

#### Non-radiation monitoring

For the analysis of groundwater quality in the area of Kozloduy NPP for physico-chemical indicators are based on data from:

- Annual report on the state of the environment, Executive Environment Agency 2012;
- Summarized results from physico-chemical studies of extracted groundwater for the needs of the NPP in 2008-2011;
- Annual reports on the results from IHNRM of the environment in KNPP site 2008 - 2011;
- In House Non-radiation Monitoring of groundwater near the RCMIW.

*According to the requirements* of the Water framework directive, the quality assessment of the ground waters is performed by groundwater bodies (UWB). The results from the performed analyses are compared to quality standards (QS) for ground waters, according to Regulation No 1/10.10.2007, last amended SG 2/08.01.2010 on the exploration, use and protection of groundwater.

Monitoring of the groundwater in the Danube River basin region in 2009 was performed at 98 monitoring points allocated in 50 groundwater bodies (UWB) - out of them 34 UWB are related to the Quaternary deposits in the North Bulgarian Hydrogeological region. At the second place of the ground surface there are three UWB in two Neogene deposits. Also, 13 karst and cleft-karst UWB and one cleft UWB are found.

The results from these studies are summarized in the Annual report on the state of the environment for 2009 (ExEA). Statistical processing of the monitoring data for a 15-year period (1995 – 2009) has been performed. Medians (50 percentiles) by groundwater bodies have been determined for the parameters for the pre-averaged data from the monitoring points for each year. UWB in which exceedances of the medians during the years have been established are defined as risky. In the period 1996 - 2010 the quality of groundwater for most of the indicators has been gradually improved. For the period 2000-2010, seven of the nine indicators of ground water (ammonia, nitrite ions permanganat oxidation, sulfates and chlorides, total iron and manganese) showed a decrease.

Percentage of points where the average nitrate concentrations exceed the quality standard for nitrate in the period 1996-2010, showed minor changes compared to 1996, with a slight increase in 2008 and stagnated in the last three years.

Trends of change in nitrate content in groundwater for two three-year periods 2005 - 2007 and 2008 - 2010 shows the percentage prevalence of a large increase in the concentration of nitrates detected in groundwater, water from karst springs there is a strong reduction or lack of trend.

A positive change is recorded removal of the pesticides in groundwater in 2010 over the results of the analyzes showed values below quality standards. Analyzed specific organic pollutants also showed values below the detection limits of laboratory methods. Major pollutant of groundwater in 2010 are nitrates.

Results of the statistical treatment showed that the majority of UWB for the basin for the last 15 years have at least one value of the median that exceeds quality standards for at least one of the above eight indicators. The highest share is the one of manganese, total iron and nitrate ions. For manganese and nitrates can be separate several groundwater bodies who experience a lengthy exceedances for period 1995-2010. Such a significant excess of the standard of quality of manganese are found in the pore water in the Quaternary deposits of Kozloduy, Ostrovsky, Belene, Svishtov Valley and Vardim-Novgradska Valley; in the Quaternary sediments of floodplains of Rivers Ogosta, Skut, Vit and Rositza.

After analyzing other obligatory under Ordinance № 1/10.10.2007g. (ammonium and nitrite ions, phosphates, chlorides, sulfates, iron and manganese, permanganate oxidation, conductivity, calcium and magnesium) in some monitoring stations are also found exceedances of the thresholds of pollution. For the period 1993 - 2007 is evidence of risk to bodies of nitrate, ammonium and nitrite ions, phosphates, sulfates, iron, manganese and magnesium.

In most cases, these abnormalities are not related to the operation of Kozloduy NPP but shows the general deterioration of groundwater as a result of anthropogenic

activities. Concentration of ammonium nitrogen ( $\text{NH}_4 - \text{N}$ ) and nutrients (nitrate nitrogen and phosphates) usually increases as a result of organic pollution emitted from urban wastewater, industry, agriculture and animal husbandry. The reasons for the high levels of manganese and iron are likely to oxidation-reduction processes in which the metal passes in a soluble form. Heavy metal analyzes were observed isolated values of standard quality indicators lead and total chromium.

**Non-radiation In House Monitoring (IHNRM)** in KNPP was developed at the end of 2001 and is in compliance with the requirements of:

- Ordinance No 1 from 10.10.2007 on the exploration, use and protection of the groundwater;
- Ordinance No 5 from 23.04.2007 on water monitoring (New Ordinance 1/11.04.2011);
- Ordinance No 8 for 24.08.2004 on the conditions and requirements for construction and operation of landfills and other facilities and installations for waste disposal and waste recovery.

Summarized results of the total chemical analysis of the **mined groundwater** from 6 shaft wells (SW), as well as wells “Ranei” and “Valiata” for KNPP from 2006 to 2011 are presented in tables 3.2.3.3-1 to 3.2.3.3-3.

All registered values for 2009, with the exception of the result for nitrates in SW-1 meet the standard quality defined in Annex 1 of Ordinance No 1 from 10.10.2007 on the exploration, use and protection of the groundwater.

All registered figures for 2010 are below the specific limit set for these sources of licenses.

All registered values for the year 2011 are below individual emission limits, except for the result for iron well type "Raney" and manganese SW-1, 2, 3 and 6 and type well "Raney" and meet the standard of quality given in Annex 1 of Ordinance No 1 from 10.10.2007 on the exploration, use and protection.

**Table 3.2.3.3-1 Summary of chemical analysis of extracted groundwater in 2009**

№	Indicator	Unit	Standard for quality <sup>1</sup>	SW “Valyata”	SW “Raney5”	SW1	SW2	SW3	SW4	SW5	SW6
1.	Reaction activity	pH	≥ 6.5 and ≤ 9.5	8.45	7.71	8.30	8.3	8.21	8.27	8.36	8.66
2.	Electrical conductivity	µs cm <sup>-1</sup>	2000	774	523	770	488	492	593	506	477
3.	Dissolved oxygen	mgO <sub>2</sub> /l	-	5.42	5.10	4.62	4.71	4.63	4.09	3.99	4.12
4.	Ammonium ion	mg/l	0.5	0.406	0.412	0.008	< 0.007	0.124	0.022	< 0.007	< 0.007
5.	Nitrate	mg/l	50	3.88	3.55	<b>54.5</b>	13.2	6.33	5.03	4.8	6.58
6.	Chlorides	mg/l	250	129	24.1	55.3	21.3	19.8	24.1	21.3	19.8
7.	Sulphates	mg/l	250	66.8	39.8	86.2	49.9	51.3	88.1	57.5	52.4

<sup>1</sup> According Annex No1 to the Regulation 1 adopted 10.10.2007 on the survey, use and protection of the underground water bodies (prom. SG 87/30.10.2007, last amended SG2/08.01.2010)

**Table 3.2.3.3-2 Summary of chemical analysis of extracted groundwater in 2010**

№	Indicator	Unit	Standard for quality <sup>2</sup>	SW “Valyata”	SW “Raney5”	SW1	SW2	SW3	SW4	SW5	SW6
1.	Reaction activity	pH	≥ 6.5 and ≤ 9.5	7.69	7.3	7.69	7.73	7.49	7.43	7.86	7.6
2.	Electrical conductivity	µs cm <sup>-1</sup>	2000	562	562	703	445	563	641	402	441
3.	Dissolved oxygen	mgO <sub>2</sub> /l	-	2.79	2.79	3.91	3.52	3.11	3.41	3.6	2.83
4.	Ammonium ion	mg/l	0.5	0.281	0.280	0.019	<0.009	<0.009	0.02	0.012	0.031
5.	Nitrate	mg/l	50	0.169	0.169	40.4	4.54	1.23	2.4	6.29	0.296
6.	Chlorides	mg/l	250	18.4	18.4	43.9	20.6	20.6	30.5	15.6	21.3
7.	Sulphates	mg/l	250	56.4	30.7	73.1	41.5	40.3	73.6	46.2	39.8

<sup>2</sup> According Annex No1 to the Regulation 1 adopted 10.10.2007 on the survey, use and protection of the underground water bodies (prom. SG 87/30.10.2007, last amended SG2/08.01.2010)



**Table 3.2.3.3-3 Summary of chemical analysis of extracted groundwater in 2011**

№	Indicator stream	Unit	Standard for quality*	SW 1	SW 2	SW 3	SW 4	SW 5	SW 6	Valyata	Raney
1.	Reaction activity	<i>pH</i>	6.5 – 9.5	7.50	7.30	7.12	7.11	7.36	7.42	7.20	7.05
2.	Iron	<i>µg/l</i>	200	22.30	31.85	21.94	20.32	19.96	20.07	95.49	<b>258.60</b>
3.	Cadmium	<i>mg/l</i>	5.0	<0.14	<0.14	<0.14	<0.14	<0.14	<0.14	0.53	<0.14
4.	Manganese	<i>µg/l</i>	50	<b>142.62</b>	<b>171.92</b>	<b>148.73</b>	7.81	17.92	<b>58.05</b>	2.26	<b>663.36</b>
5.	Copper	<i>mg/l</i>	0.2	0.01556	0.01836	0.02126	0.01890	0.02461	0.02093	0.02119	0.01503
6.	Nickel	<i>µg/l</i>	20	<0.84	<0.84	<0.84	<0.84	<0.84	<0.84	<0.84	<0.84
7.	Lead	<i>µg/l</i>	10	<2.07	<2.07	<2.07	<2.07	<2.07	<2.07	<2.07	<2.07
8.	Zinc	<i>mg/l</i>	1.0	0.00370	0.00253	0.00307	0.00265	0.00213	0.00189	0.02052	0.01339
9.	Chromium	<i>µg/l</i>	50	0.71	<0.41	<0.41	<0.41	<0.41	<0.41	45.55	<0.41
10.	Aluminum	<i>µg/l</i>	200	39.17	58.07	44.92	45.50	59.07	36.84	11.91	44.17
11.	Mercury	<i>µg/l</i>	1.0	<2.65	<2.65	<2.65	<2.65	<2.65	<2.65	<2.65	<2.65
12.	Antimony	<i>µg/l</i>	5.0	<2.47	<2.47	<2.47	<2.47	<2.47	<2.47	<2.47	<2.47
13.	Arsenic	<i>µg/l</i>	10	<2.97	<2.97	<2.97	<2.97	<2.97	<2.97	<2.97	<2.97
14.	Calcium	<i>mg/l</i>	150	84.9	78.4	71.1	143.1	89.3	79.5	84.5	146.9
15.	Magnesium	<i>mg/l</i>	80	44.4	27.3	39.7	37.7	35.9	25.9	50.5	27.0
16.	Sodium	<i>mg/l</i>	200	<b>424.7</b>	<b>275.9</b>	<b>238.2</b>	<b>212.1</b>	146.8	<b>352.6</b>	<b>360.9</b>	<b>315.5</b>
17.	Selenium	<i>µg/l</i>	10	<b>18.04</b>	<2.41	3.34	4.70	<b>13.42</b>	<b>15.35</b>	4.10	<2.41
18.	Boron	<i>mg/l</i>	1.0	0.04196	0.03292	0.14228	0.06998	0.03165	0.03833	0.08044	0.04332
19.	Dissolved oxygen	<i>mgO<sub>2</sub>/l</i>	-	6.31	5.63	5.05	6.57	5.82	6.89	5.28	2.09

20.	Electrical conductivity	$\mu S/cm$	2000	902	591	681	892	695	587	1128	684
21.	Chlorides	$mg/l$	250	38.2	19.8	21.2	31.2	19.9	21.2	129	20.8
22.	Sulphates	$mg/l$	250	62.8	38.5	37.1	86.5	47.4	33.5	45.8	37.7
23.	Ammonium ions	$mg/l$	0.5	<0.013	<0.013	<0.013	<0.013	<0.013	<0.013	<0.013	0.430
24.	Nitrites	$mg/l$	0.5	<0.013	<0.013	<0.013	<0.013	<0.013	<0.013	<0.013	<0.013
25.	Nitrate	$mg/l$	50	14.9	3.72	1.09	1.07	0.933	1.84	13.5	0.633
26.	Phosphates	$mg/l$	0.5	0.061	0.066	0.036	0.047	0.057	0.074	0.085	0.099
27.	Permanganate oxidation	$mgO_2/l$	5	0.536	0.496	0.408	0.440	<0.37	0.600	0.560	0.376
28.	Cyanide	$\mu g/l$	50	<0.005	<0.005	<0.005	<0.005	<0.005	<0.005	<0.005	<0.005
29.	Fluorides	$mg/l$	1.5	0.257	0.274	0.303	0.251	0.240	0.225	0.243	0.201
30.	Content of natural uranium	$mg/l$	0.06	<0.01	<0.01	<0.01	<0.01	<0.01	<0.01	<0.01	<0.01
<b>Chlorinated organic pesticides</b>											
31.	$\alpha$ -HCH	$\mu g/l$	-	<0.01	<0.01	<0.01	<0.01	<0.01	<0.01	<0.01	<0.01
32.	$\beta$ -HCH	$\mu g/l$	-	<0.01	<0.01	<0.01	<0.01	<0.01	<0.01	<0.01	<0.01
33.	$\gamma$ -HCH	$\mu g/l$	-	<0.01	<0.01	<0.01	<0.01	<0.01	<0.01	<0.01	<0.01
34.	$\delta$ -HCH	$\mu g/l$	-	<0.01	<0.01	<0.01	<0.01	<0.01	<0.01	<0.01	<0.01
35.	$\epsilon$ -HCH	$\mu g/l$	-	<0.01	<0.01	<0.01	<0.01	<0.01	<0.01	<0.01	<0.01
36.	HCB	$\mu g/l$	-	<0.01	<0.01	<0.01	<0.01	<0.01	<0.01	<0.01	<0.01
37.	Heptachlor	$\mu g/l$	0.03	<0.01	<0.01	<0.01	<0.01	<0.01	<0.01	<0.01	<0.01
38.	Aldrin	$\mu g/l$	0.03	<0.01	<0.01	<0.01	<0.01	<0.01	<0.01	<0.01	<0.01
39.	Dieldrin	$\mu g/l$	-	<0.01	<0.01	<0.01	<0.01	<0.01	<0.01	<0.01	<0.01
40.	Endrin	$\mu g/l$	-	<0.01	<0.01	<0.01	<0.01	<0.01	<0.01	<0.01	<0.01

41.	Methoxychlor	$\mu\text{g/l}$	-	<0.01	<0.01	<0.01	<0.01	<0.01	<0.01	<0.01	<0.01
42.	o,p DDE	$\mu\text{g/l}$	-	<0.005	<0.005	<0.005	<0.005	<0.005	<0.005	<0.005	<0.005
43.	p,p DDE	$\mu\text{g/l}$	-	<0.005	<0.005	<0.005	<0.005	<0.005	<0.005	<0.005	<0.005
44.	o,p DDD	$\mu\text{g/l}$	-	<0.005	<0.005	<0.005	<0.005	<0.005	<0.005	<0.005	<0.005
45.	p,p DDD	$\mu\text{g/l}$	-	<0.01	<0.01	<0.01	<0.01	<0.01	<0.01	<0.01	<0.01
46.	p,p DDT	$\mu\text{g/l}$	-	<0.01	<0.01	<0.01	<0.01	<0.01	<0.01	<0.01	<0.01
<b><i>Nitrogen and phosphorus containing pesticides</i></b>											
47.	atrazine	$\mu\text{g/l}$	-	<0.025	<0.025	<0.025	<0.025	<0.025	<0.025	<0.025	<0.025
48.	propazine	$\mu\text{g/l}$	-	<0.025	<0.025	<0.025	<0.025	<0.025	<0.025	<0.025	<0.025
49.	simazine	$\mu\text{g/l}$	-	<0.025	<0.025	<0.025	<0.025	<0.025	<0.025	<0.025	<0.025
<b><i>Polycyclic aromatic hydrocarbons</i></b>											
50.	benzo /b+k/ fluoroethane	$\mu\text{g/l}$	-	<0.05	<0.05	<0.05	<0.05	<0.05	<0.05	<0.05	<0.05
51.	Benzo / a / pyrene	$\mu\text{g/l}$	0.01	<0.05	<0.05	<0.05	<0.05	<0.05	<0.05	<0.05	<0.05
52.	Benzo /ghi/ pyrene	$\mu\text{g/l}$	-	<0.05	<0.05	<0.05	<0.05	<0.05	<0.05	<0.05	<0.05
53.	indeno /1,2,3-c,d/ pyrene	$\mu\text{g/l}$	-	<0.01	<0.01	<0.01	<0.01	<0.01	<0.01	<0.01	<0.01
<b><i>Volatile organic compounds</i></b>											
54.	Benzene	$\mu\text{g/l}$	1.0	<0.1	<0.1	<0.1	<0.1	<0.1	<0.1	<0.1	<0.1
55.	1,2-Dichloroethane	$\mu\text{g/l}$	3.0	<0.1	<0.1	<0.1	<0.1	<0.1	<0.1	<0.1	<0.1
56.	Trihloetilen	$\mu\text{g/l}$	10	<0.1	<0.1	<0.1	<0.1	<0.1	<0.1	<0.1	<0.1
57.	Tetrachlorethylene	$\mu\text{g/l}$	10	<0.01	<0.01	<0.01	<0.01	<0.01	<0.01	<0.01	<0.01

\* According Annex No1 to the Regulation 1 adopted 10.10.2007 on the survey, use and protection of the underground water bodies (prom. SG 87/30.10.2007, last amended SG2/08.01.2010)

### Monitoring of groundwater

For the purposes of IHNRM of the groundwater in the KNPP area 14 drill wells (CK) have been selected in the protected area of KNPP and 3 outside the protected area. Their location is as presented in table 3.2.3.4-3.

Groundwater level was measured at case of sampling and water abstraction. The measured levels are predominantly in the range 2 to 10 m, with the exception of CK-334, where the water level is 1 m.

**Table 3.2.3.4-3 Location of IHNRM shaft wells**

Shaft well No	Location
CK 114	Turbine hall Units 1 and 2
CK 121	Sanitary building in EP-1
CK 127	Nitrogen-Oxygen plant in EP-1
CK 135	Reactor building Units 1 and 2 and water treatment plants in EP-1
CK 213	Turbine hall Units 3 and 4
CK 237	Reactor building Units 3 and 4
CK 334	AB – 1
CK 422	AB – 2
CK 512	Reactor building Units 5
CK 614	Reactor building Units 6
CK 735	Water treatment plant in EP-2
CK 944	RAW disposal facility
CK Cw-4	RAW treatment plant
CK p-3	RAW storage
CK P-1	Outside the protected area – north of the Switchyard
CK P-2	Outside the protected area – in the yard of the Fire protection service
CK P-3	Outside the protected area – south of the Information centre

Sampling and tests are made by the Regional laboratory - Vratsa with the EEA-Sofia.

### Summary of physico-chemical testing of groundwater

Observed systematically increased content of iron and manganese in groundwater and in some places, and increased value for lead in the period before 2008. About 35 % of the samples from boreholes in 2008 testify to the exceedences of the standard of quality in terms of nitrates, nitrites, ammonia, while around reactor building 1 and 2 and chemical water purification facility of EP-1 is registered high nitrate content throughout 2008. There have been increased concentrations of sulfate and chloride in groundwater at the plant site of the EP-1 and EP-2.

**In 2009** were selected and analyzed 68 samples of groundwater. Quality standard in 2009 fully meet water from CK № 114, № 121, № 127, № 213, № 735, № 944, № C<sup>P-3</sup>, № C<sup>w-4</sup> and № P-3. Individual exceedences of the standard of quality of certain indicators were detected in water from CK № 237 (nitrates), № 334 (Mn), № 422 (nitrates and iron), № 512 (reaction activity and sulfates), № 614 (manganese) and № P-1 (manganese).

In the water in two wells exceedences of the values of quality standards are observed

almost throughout the period of observation.

Similar results were obtained in 2008, when these wells are included in the monitoring program. Wells are as follows:

CK № 135:

Exceedances were recorded corresponding values of standard quality indicators nitrates throughout the observation period (59.1 mg/l, 116 mg/l, 123 mg/l and 91.8°mg/l) with standard of 50 mg/l.

CK № P-2:

Exceedances were recorded of corresponding values for quality standards:

- Levels of nitrates during the period of observation (58.2 mg/l, 81.9 mg/l, 88.7 mg/l and 77.6 mg/l) with standard of 50 mg/l.
- Level of Sulfate in I-st, II-nd and IV-th quarter (486 mg/l, 392 mg/l and 253 mg/l) with standard of 250 mg/l.
- Considering the results of 2008 can be summarized that:
- The waters of the well № 135, located close to RB1 and 2, showing persistently excess of the value of standard quality content "nitrate";
- Water from well № 512, located near the reactor hall of unit 5 are with reaction activity about 9 as individual values also exceed the norm of standard quality ( $\leq 9.5$ );
- The waters of the well № P-2, located outside the plant site - in the courtyard of the Fire Department, there is a permanent excess of the value of standard quality content "nitrates" and "sulphate".

**In 2010** were selected and analyzed 63 samples of groundwater.

Quality standard in 2009 fully meet water from CK № 114, № 121, № 127, № 135, № 213, CK № 237, № 334, № 735, № 944, № C<sup>P-3</sup>, № C<sup>w-4</sup> and № P-3.

Individual exceedances of the standard of quality in some measurements were recorded at Water from wells № 422, № 512, № 614, № P-1, № P-2.

In water of two wells the results showing persistently exceeded the corresponding values of the standard quality of individual performance. Wells are as follows:

CK № 512

Exceedances were recorded corresponding values of the standard for quality pH in Second quarter (9.81 where norm is  $\geq 6.5$  and  $\leq 9.5$ ).

CK № P-2

Exceedances were recorded corresponding values of the standard for quality:

- Levels of nitrates in I, III, and IV quarter (68.2 mg/l, 50.9 mg/l, 65.2 mg/l, where norm is 50 mg/l);
- Level of Sulfate in I-st quarter (267 mg/l, where norm is 250 mg/l).

Exceedances in other wells with respect to indicators nitrate and manganese::

- Indicator nitrate
- CK № 422 – 55.6 mg/l in II-nd quarter, where norm is 50 mg/l;
- 57.5 mg/l in III-rd quarter, where norm is 50 mg/l;
- 54.3 mg/l in IV-th quarter, where norm is 50 mg/l.
- Indicator manganese
- CK № 614 – 81.34 µg/l in III-rd quarter, where norm is 50 µg/l;
- CK № P-1- 570.54 µg/l in III-rd quarter, where norm is 50 µg/l .
- Considering the results of 2010 can be summarized that:
- Water from well № 512, located near the reactor hall of Unit 5 are with alkaline active reaction (over 9) and periodically recorded values exceed the norm and the standard quality ( $\leq 9.5$ ).
- The waters of the well № P-2, located outside the plant site - in the courtyard of the Fire Department, there is a permanent excess of the value of standard quality content "nitrates" and "sulphate".
- There has been a steady increase of the indicator of manganese CK № 614 and CK № P-1(62 µg/l for CK № 614 and 93 µg/l for CK № P-1 during 2009).

**In 2011** sampling and testing of groundwater is carried out in March, August and November. Were selected and analyzed 51 samples of groundwater.

Quality standard in 2011 fully meet Water from CK: № 114, № 127, № 213, № 334, № 422, № 614, № 735, № 944, № C<sup>P-3</sup>, № P-1 and № P-3.

Individual exceedances of the standard of quality of certain indicators were detected in water from CK: № 121, № 135, № 237, № 512, № Cw-4 and № P-2.

CK № 512

Exceedances were recorded corresponding values of the standard for quality pH in Third quarter (9.81 where norm is  $\geq 6.5$  and  $\leq 9.5$ ).

CK № P-2

Exceedances were recorded corresponding values of standard quality:

- Levels of nitrates in Third quarter (70.04 mg/l where norm is 50 mg/l);
- Level of Sulfate in Third quarter (362.62 mg/l, where norm is 250 mg/l).

Exceedances in other wells with respect to indicators nitrates and fluorides:

- Indicator nitrate
- CK № 135 – 109.23 mg/l in III-rd quarter, where norm is 50 mg/l;
- CK № 237 – 60.19 mg/l in III-rd quarter, where norm is 50 mg/l;
- Indicator fluorides



- CK № 121 – 2.46 mg/l in III-rd quarter, where norm is 1.5 mg/l;
- CK № 135 – 2.9 mg/l in III-rd quarter, where norm is 1.5 mg/l;
- CK № Cw-4 – 2.01 mg/ in III-rd quarter, where norm is 1.5 mg/l;

Considering the results can be summarized as follows:

- Water from well № 512, located near the reactor hall of Unit 5 are with alkaline active reaction (over 9) and periodically recorded values exceed the norm and the standard quality ( $\leq 9.5$ ).
- The waters of the well № P-2, located outside the plant site - in the courtyard of the Fire Department, there is a permanent excess of the value of standard quality content "nitrates" and "sulphate";
- For the first time in 2011 observed exceedance of quality standards for indicator fluorides for CK № 121 (located at Chemical workshop at EP-1), CK № 135 (located at reactor bulding of Units 1 and 2) and CK № Cw-4 (located close to oil workshop of EP-2 and Workshop for RAW processing).

### **In-house non-radiation monitoring of groundwater in the region of the RCMIW**

In the area of the landfill are constructed wells 5 each along its entire length, CK № 3 is removed from the monitoring program in 2007 due to damage. For comparison included CK № 944, located before RCMIW.

Formed within the landfill waste water after radiation control are transported by tanker to the neutralization pit EP-2, and hence by low pressure channels received in DC 1. Final recipient of the waters is Danube.

In landfill leachate are sometimes observed low concentrations of AOX that is lower than the specific limit values, but need to be controlled. Periodically monitor high suspended solids and iron in the leachate and water from the site of RCMIW.

There has been no contamination of the leachate with oil (Annex 19). The amount of waste waters from landfill (around 1278 m<sup>3</sup>/a) represents less than 0.37 % of the amount of waste water discharged into neutralization pit of the EP-2 (341 870 m<sup>3</sup>/a).

During the monitoring period from 2001 to 2011 including in 1995 when the first tests were carried out after the construction of boreholes in the area of the landfill, it is often observed exceedance of the relevant emission performance in terms of iron and manganese. In 2010, there were no exceedances of the values of the standard for quality in any borehole ((Annex 19). In 2011 the excess of manganese is also observed in CK2 and CK5 (Annex 19).

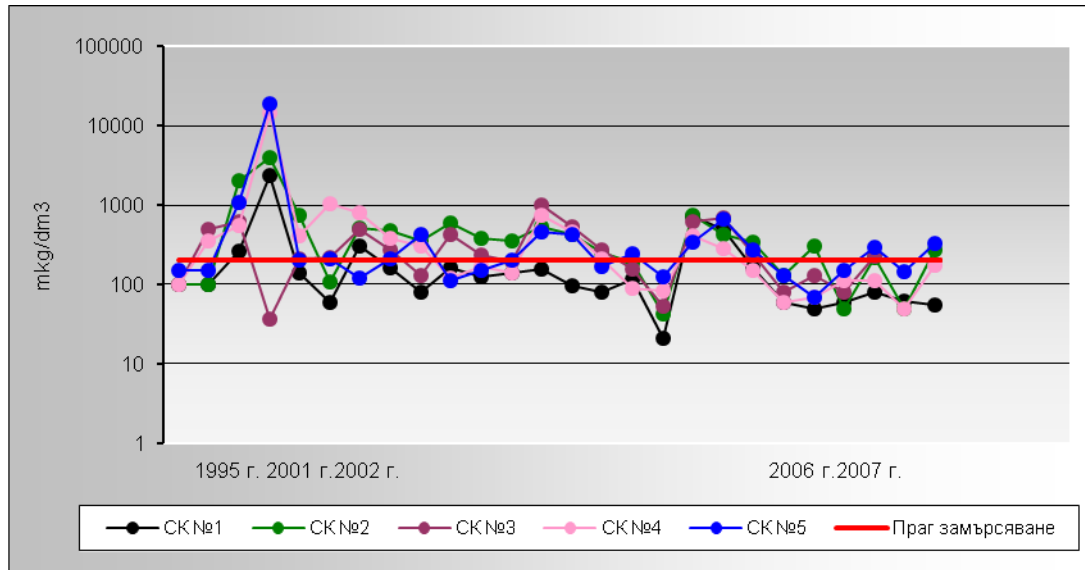

**Fig. 3.2.3.3-1 – Concentration of “Iron/total/” in the ground waters (RCMIW) in the period 1995 – 2007**

Source: Annual reports of IHNRM in KNPP for 2008

Legend:

CK - Drill wells

Red line - Limit of pollution

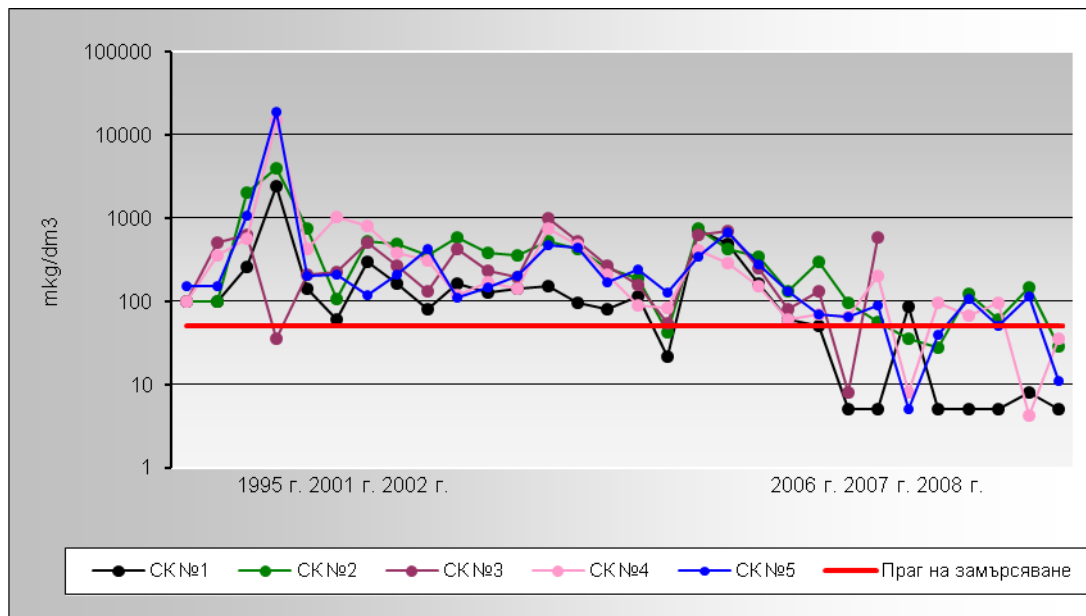

**Fig. 3.2.3.3-2 Concentration of “Manganese” in the ground waters (RCMIW) in the period 1995 – 2008**

Source: Annual reports of IHNRM in KNPP for 2008

Legend:

CK – Drill wells -

Red line - Limit of pollution

With regard to groundwater near the landfill can be concluded that during the period of observation, including prior to commissioning, annually register values that exceed current standards with respect to indicators of iron and manganese.

However, because of trend of lowering the threshold of contamination with iron and manganese from 2006 and the insignificant contribution of wastewater from the landfill to the water in the neutralization pit (0.3 %) can be noted that the impact of landfill on groundwater for both indicators is insignificantly.

#### ***3.2.3.4 Natural and technogenic radioactivity of ground waters***

There are not many investigations made in the region of KNPP and beyond it in order to establish the natural radioactivity of the groundwater.

Analysis of natural and technogenic radioactivity of groundwater in the area of Kozloduy NPP in this report are based on data from Kozloduy NPP 1999 and the results of own radiation monitoring of groundwater of Kozloduy NPP formed in annual reports for the period 2006 – 2011.

The mechanism and the assessment of radionuclide migration in the hydrosphere in KNPP area were studied in 1992 in the “Report on clarifying the dispersion characteristics of soil and aquatic environment in the KNPP area in order to analyze the possible pathways for migration of radionuclides in soil and hydrosphere”. Particularly important for this transfer are the filtration characteristics of cover clays and loess materials in terms of vertical transfer through the aeration area, as well as the gravels through which the possible horizontal transfer of radionuclides will be performed.

As result of these studies it was found that the variations of horizontal transfer of radionuclides in the alluvial aquifer are large - 100-2000 m<sup>2</sup>/d. In central and southern parts of the lowland aquifer conductivity is mostly 100-500 m<sup>2</sup>/d. It increases in the north and particularly in the north-east and in reaches some areas 1500-2000 m<sup>2</sup>/d.

Very slow rates of penetration (in the order of mm per year) show that the time for radionuclides to reach ground waters is rather long. For the high terrace the time for passing the aeration area is over 250-300 years for Sr respectively 750-800 years for Cs, and for the loess plateau this time is even longer - over 500 years for Sr and 1 500 years for Cs. Even for low power aeration area of the low alluvial terrace the time for reaching water level is around 100 years (at aeration area thickness of 0.5 m), 200 years respectively (at aeration area thickness of 1.0 m).

Based on the above information it can be concluded that the geological structures are effective natural barrier against the spreading of radioactive contamination in the ground waters.

In the table 3.2.3.4-1 below, in compliance with the Basic Norms for Radiation Protection (BNRP 2004), as secondary limits are determined the average annual admissible concentrations (AAAC) for the separate radionuclides and the main ones are used as criteria for assessment of radioactivity of the groundwater.

Institutional environmental radiation monitoring is regulated by the long-term program of KNPP for environmental radiation monitoring, based on the requirements

of the regulations in this field, as well as on the good international practice and the operation experience of RM Department.

**Table 3.2.3.4-1 Average annual admissible concentrations of separate radionuclides in the groundwater**

Radionuclides	AAAC, Bq/l
Tritium - <sup>3</sup> H	70000
Manganese - <sup>54</sup> Mn	1000
Cobalt - <sup>60</sup> Co	100
Strontium - <sup>90</sup> Sr	20
Iodine - <sup>131</sup> I	20
Caesium - <sup>137</sup> Cs	80
β <sub>total</sub> *	0.75
Ra*	0.15
Ra**	0.1/0.5

Source: EIA Report by KNPP, 1999

In order to provide independent control, parallel programs for radiation monitoring are performed by the supervisory authorities – ExEA/MEW and NCRBRP/MH.

Monitoring of the radiation parameters of the groundwater of the control bodies are based on executing the Program for radiological monitoring approved by the Minister of Environment and Waters with Order No RD-227/06.04.2007 and are a part of the National System of Radiological Environmental Monitoring.

Radiation condition of the surface, ground and sewage waters in the monitored area of KNPP is surveilled by the means of radiometric measurements in sampling collection conditions and following laboratory and analytics activities by the laboratory for radiation measurements in Vratsa.

Total alpha and beta activity is measured as well as content of natural uranium, radium-226 and tritium in surface, ground and sewage waters.

Institutional radiation monitoring is performed of groundwater from 181 drill wells with certain frequency of sampling, type of measurements and type of radionuclides, in compliance with the planned monitoring program.

As a result of the measurement of the activity of the water from 115 wells in 2008, 116 wells in 2009, 115 wells in 2010 and 2011 as well as from the measurements from previous years, it is established that the activities in NPP have a local impact on certain site sections.

This conclusion is due to the following facts established in the monitoring process:

- Water with total beta activity higher than 1.5 Bq/l in 2008 is measured in one drill well located on of the territories of EP-1, EP-2 and SD RAW-Kozloduy each, as well as on the territory of RAW SF - in two wells.
- The highest total activity is 2.43 Bq/l, measured on the territory of RAW SF.
- In 110 wells the total beta activity has been never higher than 0.75 Bq/l, which is the admissible value for surface waters (Regulation No H-4 of 14 September 2012 for the characterization of surface waters, Prom. SG. No. 22 of 5 March

2013). As a rule ground waters have higher saline content than surface waters, and they have higher levels of natural radioactivity respectively.

- Out of 115 total drill wells investigated for tritium in 2008, in 48 of them the tritium activity has never exceeded the annual MAA (up to 7.6 Bq/l).

Water in 40 drills has contained tritium at least once per year within the limits of MAA + 100 Bq/l, and the water in 27 of the drills at least once per year has exceeded 100Bq/l.

In 2008 the highest tritium content in the water of the drill wells is measured on the territory of EP-1, drill 142 (3 341 Bq/l) and on the territory of EP-2, drill 725 (17 452 Bq/l).

Out of 11 wells with tritium activity increased above 1000 Bq/l, 7 are located in the region of AB-3, Units 5 and 6 and 3 drills next to SD RAW-Kozloduy. Maximal tritium concentrations are measured in the eastern part of the sanitary building.

As a result of the measurement for total beta activity of water in 116 drills through 2009 at 110 drills it was not higher than 0.75 Bq/l, which is the admissible value for surface water, whilst the underground water have highest natural radiation background. The water in four drills at least once had a total beta activity of 0.75 Bq/l - to 1.5 Bq/l, in one drill at least higher than 1.5 Bq/l.

Out of 116 total drill wells investigated for tritium in 2009, in 57 of them the tritium activity has never exceeded the annual MAA (up to 7.6 Bq/l). The water in 32 drill wells has contained tritium within the limits of MAA + 100 Bq/l and in 27 of the drill wells at least once per year the MAA + 100 Bq/l was exceeded.

In 2009 the highest tritium content in the water of the drill wells is measured on the territory of EP-1, drill 142 (2959 Bq/l) and on the territory of EP-2, drill 714 (14228Bq/l).

Out of 11 wells with tritium activity increased above 1000 Bq/l, 7 are located in the region of AB-3, Units 5 and 6, 3 boreholes next to SD RAW-Kozloduy and 1 borehole in the region of AB-1 (Units 1 and 2). Maximal tritium concentrations are measured in the eastern part of the sanitary building (AB-3).

As a result of the measurement for total beta activity of water in 115 drill wells through 2010 at 110 drills it was not higher than 0.75 Bq/l. The water in three drills wells No013, 131, 937) at least once had a total beta activity of 0.75 Bq/l - to 1.5 Bq/l and in the other 2 drills (948, 951) at least once the activity was higher than 1.5 Bq/l.

Out of 115 total drill wells investigated for tritium in 2010, in 58 of them the tritium activity has never exceeded the annual MAA (up to 7.6 Bq/l). Water in 30 drills has contained tritium at least once per year within the limits of MAA + 100 Bq/l, and the water in 27 of the drills at least once per year has exceeded 100 Bq/l.

In 2010 the highest tritium content in the water of the drill wells is measured on the territory of EP-1, drill 145 (314 Bq/l) and on the territory of EP-2, drill 729 (10567 Bq/l).

Out of 11 wells with tritium activity increased above 1000 Bq/l, 6 are located in the region of AB-3, Units 5 and 6, 3 boreholes next to SD RAW-Kozloduy. Maximal

tritium concentrations are measured in the eastern part of the sanitary building.

As a result of the measurement for total beta activity of water in 115 drill wells through 2011 at 110 drills it was not higher than 0.75 Bq/l. The water in three drills wells No013, 131, 937) at least once had a total beta activity of 0.75 Bq/l - to 1.5 Bq/l and in 1 drill at least once the activity was higher than 1.5 Bq/l.

Out of 115 total drill wells investigated for tritium in 2011, in 54 of them the tritium activity has never exceeded the annual MAA (up to 7.6 Bq/l).

Water in 38 drills has contained tritium at least once per year within the limits of MAA + 100 Bq/l, and the water in 23 of the drills at least once per year has exceeded 100 Bq/l.

Drilling wells around AB-2, in which a building is installed PMF: 145, 213, 222, 232, 233, 236, 237, 242, 243, 422, 423, 434, 435, 436, 437, 440, 442, 811, 812, 813, 814, 821, 822, 823, 824, 831, 832, 833, 834, 835, 844, 845, 847, 848, 849, 851, 852, 853, 854, 855. This amount of drilling wells is sufficient to measure the natural and technogenic radioactivity in groundwater and therefore does not require additional wells.

On Figure 3.2.3.4-1 provides the schedule followed of boreholes around Units 3 and 4, AB-2 and SFSF.



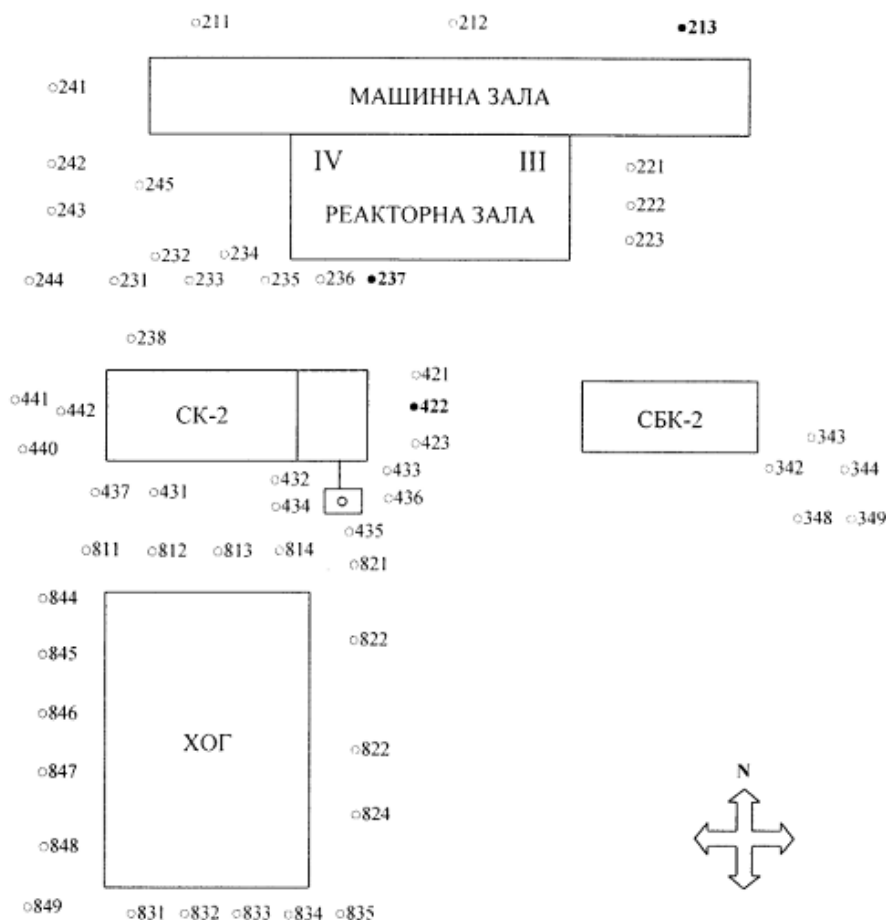

**Fig. 3.2.3.4-1 Boreholes around Units 3 and 4, AB-2 and SFSF**

Legend:

- Машинна зала- Turbine hall,
- Реакторна зала - Reactor building Units 3&4;
- СК2 –Auxiliary building2;
- СБК2- Sanitary building 2;
- ХОГ- Spent fuel storage facility

In 2011 the highest tritium content in the water of the drill wells is measured as follows:

- On the territory of EP-1, drill 341 (422 Bq/l);
- On the territory of EP-2, drill 711 (12861 Bq/l).

From 9 drills with increased activity of tritium over 1000 Bq/l, 5 are located in the area of AB-3, 5 and 6, Units and three wells around SP "RAW Kozloduy" and a warehouse RAW. Maximum concentrations of tritium were measured on the east side of the sanitary building 2.

Performed at the end of 1994, amending the route on which the discharge water are discharged from AB-3, has been made to reduce the content of tritium in groundwater.. Despite periodic pumping of water from these wells, a steady trend to reduce contamination by tritium is not observed.

According to the Program for radiation monitoring of the environment, water from boreholes with a total beta activity greater than 1.5 Bq/l is tested for radionuclide composition. The survey found that technological activity is recorded in single wells.

Like the previous years, in 2011 <sup>60</sup>Co activity was measured in only two boreholes. Traces of activation products (<sup>54</sup>Mn) were not detected. Negligible activity of <sup>137</sup>Cs was found in one borehole.

Increased radioactivity of tritium in piezometers around the complex processing of RAW № 010, 012 and 013 and 022 due to past contamination and infiltration of water from the side of the AB-3.

Overall, with the exception of well № 951, all measured values of total beta activity are lower than the norm for groundwater (2 Bq/l, Ordinance № 1 from 15.11.1999 norms for purposes of radiation protection and safety in eliminating the consequences of the uranium industry in Bulgaria).

Due to the low velocity of the vertical transmission (Vz) in case of surface leakages on the site of the power plant the penetration period is expected to be longer. This was determined in a study of Akvater with a team leader prof. M. Gulubov on the forecasting of the migration of radionuclides in the aeration area on the site of KNPP to the water level of ground waters (the times for passing the aeration area are 200-300 years for <sup>90</sup>Sr and 700-800 years for <sup>137</sup>Cs within the non-flooded terrace with thickness of the aeration area of 0.5 m, the time for reaching the water level is 100 years), The thickness of the aeration area and its filtration and migration ability are very important, because it is a media of accumulation of these pollutions.

**Table 3.2.3.4-2 Parameters of migration of the waters from KNPP**

Lithologic varieties	Filtration ratio, m/d	Velocity of the vertical transfer Vz/cm/a	
		<sup>90</sup> Sr	<sup>137</sup> Cs
Loess sandy	2.0	1.8	0.6
Loess clayey	0.2	0.6	0.2
Loess-like clay	0.1	0.3	0.1
Alluvial clay	0.3	0.5	0.2

This longer period of penetration of the radionuclide through the aeration area of the groundwater is confirmed also by the values of <sup>90</sup>Sr in the water samples taken from the site of KNPP for the EIA purposes in 1999. They ranged from 0.031 to 0.071 Bq/l, with admissible limit of 3.7 Bq/l. In case of direct underground discharges of radioactive waters at the site of the power plant, which have occurred in different sections during the years of its operation, such local contents have been detected, however, several times lower than the norm. Weak migration of the radionuclide in the loess deposits is confirmed by the localization of these "pollutions" at different places without their expansion.

In execution of the Program for radiation and environmental monitoring of the Repository for conventional municipal and industrial waste of KNPP, from the site commissioning in 2001 a monitoring is held of the radiation indicators of the region of the RCMIW site. Controlled facilities include 5 drill wells (piesometers) for groundwater, waste waters from collection tanks and rainfall water.

In 2008 the results of total beta activity of the groundwater around the site of RCMIW vary within the range of <0.052 to 0.25 Bq/l with average activity of 0.085 Bq/l. These are results within the normal limits of groundwater, lower than the limit for the surface waters 0.75 Bq/l, Regulation 7/1986.

Tritium activity control is performed only in borehole II-1. Analyses show activities within the range of 89.1 up to 159.0 Bq/l with average content 137.5 Bq/l. The presence of tritium in borehole II-1, with the lack of presence in neighbor boreholes of RCMIW and the closely located ones on the KNPP site, could not be logically explained. Once in 2008 a minimal activity of 17.9 Bq/l is measured also in borehole II-4. All other results are below MAA (3.9-7.6 Bq/l). Recorded tritium activities in the groundwater around RCMIW are very low.

During the gamma spectrometric analyses of the waste waters and rain waters from the site of RCMIW no technogenic activity has been recorded. All results for  $^{54}\text{Mn}$ ,  $^{60}\text{Co}$ ,  $^{134}\text{Cs}$  and  $^{137}\text{Cs}$  are lower than the respective MAA (0.096-0.95Bq/l).

In 2008 the results of total beta activity of the groundwater around the site of RCMIW vary within the range of <0.052 to 0.33 Bq/l with average activity of 0.1 Bq/l. These are results within the normal limits of groundwater, lower than the limit for the surface waters (2 Bq/l, Ordinance № 1 from 15.11.1999 norms for purposes of radiation protection and safety in eliminating the consequences of the uranium industry in Bulgaria).

Tritium activity control analyses for 2009 show activities within the range of 4.2 up to 143.0 Bq/l with average content 23.9 Bq/l. All results are below MAA (3.9-7.6 Bq/l) with one exception piezometers P1. It should be noted that the recorded activities of tritium in groundwater around RCMIW in 2009 are very low.

During the gamma spectrometric analyses of the waste waters and rain waters from the site of RCMIW no technogenic activity has been recorded. All results for  $^{54}\text{Mn}$ ,  $^{60}\text{Co}$ ,  $^{134}\text{Cs}$  and  $^{137}\text{Cs}$  are lower than the respective MAA (0.12-0.44Bq/l).

In 2010 the results of total beta activity of the groundwater around the site of RCMIW vary within the range of <0.051 to 0.39 Bq/l with average activity of 0.096 Bq/l. These are results within the normal limits of groundwater, lower than the limit for the surface waters (2 Bq/l, Ordinance № 1 from 15.11.1999 norms for purposes of radiation protection and safety in eliminating the consequences of the uranium industry in Bulgaria).

Tritium activity control analyses for 2010 show activities within the range of 4.5 up to 70.90 Bq/l. It should be noted that the recorded activities of tritium in groundwater around RCMIW in 2009 are very low.

During the gamma spectrometric analyses of the waste waters and rain waters from the site of RCMIW no technogenic activity has been recorded. All results for  $^{54}\text{Mn}$ ,  $^{60}\text{Co}$ ,  $^{134}\text{Cs}$  and  $^{137}\text{Cs}$  are lower than the respective MAA (0.11-0.39 Bq/l).

In 2011 the results of total beta activity of the groundwater around the site of RCMIW vary within the range of <0.055 to 0.39 Bq/l with average activity of 0.11 Bq/l. These are results within the normal limits of groundwater, lower than the limit for the surface waters (2 Bq/l, Ordinance № 1 from 15.11.1999 norms for purposes of

radiation protection and safety in eliminating the consequences of the uranium industry in Bulgaria).

Tritium activity control analyses for 2011 show activities within the range of 4.2 up to 60.3 Bq/l with average activity of 13.3 Bq/l. All results are below MAA (3.9-7.6 Bq/l) with one exception piezometers P1. It should be noted that the recorded activities of tritium in groundwater around RCMIW in 2011 are very low, even below the norm for drinking water (100 Bq/l, Ordinance № 9 16.03.2001g, quality of water intended for drinking purposes).

During the gamma spectrometric analyses of the waste waters and rain waters from the site of RCMIW no technogenic activity has been recorded. All results for  $^{54}\text{Mn}$ ,  $^{60}\text{Co}$ ,  $^{134}\text{Cs}$  and  $^{137}\text{Cs}$  are lower than the respective MAA (0.11-0.34 Bq/l).

As a conclusion it can be stated that the activities in KNPP produce local impact on the groundwater in separate sections of the KNPP site.

### 3.2.4 Surface and groundwater in the 30-km area of the Romanian territory

The 30-km area of interest on the Romanian territory around the nuclear power plant of Kozloduy occupies 133035 ha, situated in the south of the county of Dolj, between the Danube River, Romanatilor and Bailesti plains.

#### 3.2.4.1 Surface water

##### 3.2.4.1.1 Non radioactive monitoring of water quality

Detailed information about the the results of non-radiation monitoring conducted in 2008 and 2009 is presented in the reference [46]. Information provided by the Romanian is for the purposes of present evaluation.

Measurements were carried out at 214 points located at 19 bodies of surface water in a 100-km zone. Their class is defined in accordance with Order 161/2006 "Normativului privind clasificarea calitatii apelor de suprafata in vederea stabilirii starii ecologice a corpurilor de apa". Classification of rivers is presented in Table 3.2.4.1.1-1.

**Table 3.2.4.1.1-1 categorization of the river in 100-km area in 2008 and 2009**

Category	Number of water bodies	
	2008	2009
II	158	147
III	51	61
IV	0	1
V	5	5

The monitoring results show an increase in water pollution, resulting in in 2009, 10 rivers have been re-categorized from category II to III and one - from III to IV category. The main reason for re-categorization is pollution with CCOCr and in one case is the increased concentrations of N-NO<sub>3</sub>, N-NH<sub>3</sub>, P-PO<sub>4</sub>.

### 3.2.4.1.2 Radioactive monitoring of the surface water quality

The National Environmental Radioactivity Surveillance Network (NERSN) of Romania, monitors the radioactivity in the area influenced by KNPP – Bulgaria, through 4 laboratories, called Surveillance Stations for Radioactivity Monitoring (SSRM) - in Bechet, Craiova, Drobeta Turnu Severin and Zimnicea, there is 17 automatic air gamma dose rate monitoring stations from with 15 in Dolj County, 1 in Mehedinti County and 1 automatic station in Teleorman County. Total beta activities of surface water in the period 2000 – 2009 are shown in table 3.3.5.1.2-1.

**Table 3.2.4.1.2-1 Surface water - total beta activity [Bq/m<sup>3</sup>]**

Year	SSRM Drobeta Turnu Severin*	SSRM Bechet*	SSRM Craiova**	SSRM Zimnicea*
2000	240,921	176,131	243,578	276,729
2001	224,569	168,735	193,961	225,378
2002	246,275	195,533	200,357	230,686
2003	261,531	212,964	246,532	208,469
2004	242,467	274,320	267,675	204,182
2005	261,724	226,906	279,738	198,780
2006	188,239	202,366	243,755	213,853
2007	278,017	353,093	447,980	177,020
2008	145,444	439,823	366,282	179,000
2009	241,217	685,755	157,585	201,897

Note: \* samplig point – Danube river

\*\* samplig point – Jiu river

Total beta radiation of the surface water established at four sampling sites in Danube River and Jiu River in the period of 2000 – 2009 does not exceed the limit and is far below it. The surface water samples that have been taken under the Special Program and analysed by gamma spectrometry have not indicated presence of artificial radionuclides in the investigated samples.

### 3.2.4.2 Ground water

The Danube and Jiu meadows are covered by sandy soil, with high level of the ground water and a presence of wet silty areas.

#### 3.2.4.2.1 Non radiological monitoring

Evaluation the chemical status of the groundwater bodies in the 30-km controlled area on the Romanian territory was carried according to the requirements of Water Frame Directive 2000/60/CE and 2006/118/CE Directive on the protection of groundwater against pollution; in Romanian legislation 2006/118/CE Directive is transposed by HG 53/2009 and OM 137/2009 which establishes the target values for the groundwater bodies.

In 2009 20 wells were monitored by the national hydrogeological network, 11 pollution control wells, 8 domestic wells from Gorj County and 18 domestic wells from Dolj County. In 2010 6 wells for this groundwater body are monitored by the national hydro geological network and 7 pollution control wells.

The zone of interest is described by the following groundwater bodies:

- The groundwater body ROJI05” Lunca si terasele Jiului și afluenților săi”
- The groundwater body ROJI06 “Lunca si terasele Dunarii”
- The groundwater body ROOT08 “Lunca si terasele Oltului inferior”
- The groundwater body ROOT09 “Lunca Dunarii – sectorul Bechet-Turnu Magurele”
- The groundwater body ROAG09 “Luncile râurilor Vedea, Teleorman și Călmățui”
- The groundwater body ROAG10 “Lunca Dunării (Turnu Magurele-Zimnicea)”

When applying the evaluation principles for the above mentioned water bodies for the years 2009 and 2010 the bodies were divided into two categories:

1. Good chemical status is established for:

- The groundwater body ROOT09 “Lunca Dunării – sectorul Bechet-Turnu Măgurele” (2009). The chemical parameters determining the chemical status for this groundwater body are: nitrates, ammonium ion, chlorides, sulphates, nitrites, phosphates, lead and cadmium;
- The groundwater body ROAG09 “Luncile râurilor Vedea, Teleorman și Călmățui” (2009 and 2010). The chemical parameters determining the chemical status for this groundwater body are: nitrates, ammonium ion, chlorides, sulphates, nitrites, phosphates, lead, cadmium, mercury and arsenic;

2. Poor chemical status is established for the following groundwater bodies:

- The groundwater body ROJI05 “Lunca și terasele Jiului și afluenților săi”. The chemical parameters determining the chemical status for this groundwater body are: nitrates, ammonium ion, chlorides, sulphates and nitrites. In 2009 and 2010 norms are exceeded by nitrates, ammonium ions and nitrites. This groundwater body has considered at risk for nitrates.
- The groundwater body ROJI06 “Lunca și terasele Dunării”. The chemical parameters determining the chemical status for this groundwater body are: nitrates, ammonium ions, chlorides, sulphates and nitrites. The norms are exceeded: in 2009 by nitrates, ammonium ions and nitrites and in 2010 – by nitrates, nitrites and chlorides for selected observation wells;
- The groundwater body ROAG10 ”Lunca Dunării (Turnu Măgurele-Zimnicea)” (2009 and 2010) The chemical parameters which determine the chemical status for this groundwater body are: nitrates, ammonium ions, chloride, sulphates, nitrites, phosphates, lead and cadmium;
- The groundwater body ROOT08 “Lunca si terasele Oltului inferior” (2009 and 2010). The chemical parameters determining the chemical status for this groundwater body are: nitrates, ammonium ions, chloride, sulphates, nitrites, phosphates, lead, cadmium and mercury;

Detailed information for the pollution, responsible for the status of the controlled



groundwater bodies, was provided by the Romanian side and it is presented in reference [46] Groundwater quality evaluation.

### 3.2.4.2.2 Radiological monitoring

Results from Radiological Monitoring in Romania within the 30-km area of KNPP NPS in a period of three years (2008-2010) are shown in table 3.2.4.2.2-1.

**Table 3.2.4.2.2-1 Total Beta activity in the wells in the 30-km area**

No.	Sample	Date of collection	District	Location	Unit	Total beta
1.	Open well	2008	Dj	Gighera	Bq/l	0.57±0.23
2.	Covered well	2008	Dj	Gighera	Bq/l	0.42±0.17
3.	Open well	2009	Dj	Gighera	Bq/l	0.51±0.2
4.	Covered well	2009	Dj	Gighera	Bq/l	0.5±0.2
5.	Open well	2010	Dj	Gighera	Bq/l	0.67±0,25
6.	Covered well	2010	Dj	Gighera	Bq/l	0.4±0.17

The total beta activity is lower than the limit value for surface water. Groundwater generally has a higher salt content than surface water and therefore has a higher natural radioactivity. The higher beta activity of open wells shows that it is possible to increase due to precipitation and atmospheric aerosols.

It can be concluded that many technogenic activities related to industrial production and agriculture in the region are the most likely sources of contamination found in monitoring. Data from monitoring of surface and groundwater in the area of 30-km in Romania around KNPP showed no abnormalities that may relate to the operation of NPP.

## 3.3 Flora

### 3.3.1 General characteristic of the flora and vegetable in the region of PMF at KNPP

The territory of the KNPP is related to the Zlatiiski geobotanic region of the Danube side District and Low Danube River province of the Eurasian steppe and forest steppe area. A larger part of the territory is agricultural land where cereal plants are grown.

KNPP green system includes grasslands, individuals and groups of tree and shrub species.

Around the administrative buildings in the green system are included *Aesculus hippocastanum* L. (Horse chestnut), *Platanus X acerifolia* Willd (hibrid plane-tree), *Platanus orientalis* L. (East Plane-tree), *Tilia cordata* Mill (small-leave lime tree), and *Picea pungens* Engelm. (Silver Spruce), *Acer pseudoplatanus* L. (common sycamore), *Betula pendula* Roth (common birch), *Vinca minor* L. (common periwinkle), *Deutzia scabra* Thunb. (fuzzy pride-of-Rochester), *Thuja occidentalis* L (West Thuja), *Picea abies* Karst. (Common Spruce), *Cotoneaster horizontalis* Decne (Rock cotoneaster), *Fraxinus americana* L. (American Ash-tree), *Syringa vulgaris*, *Euonymus japonica*, *Ligustrum vulgare*, *Amorpha fruticosa*, *Populus pyramydalis*, *Acer negundo*, *Spiraea* sp.

In a forest park in front of the entrance of KNPP there are mostly forest species of *Platanus X acerifolia* Willd. (Hybrid Plane-tree), *Tilia cordata* Mill. (small-leaf lime-tree), *Betula pendula* Roth. (Common Birch), *Pseudotsuga menziesii* (Mirb.) Franko (Douglas-fir), *Thuja occidentalis* L. (West Thuja), *Chamaecyparis lawsoniana* Parl. (Pseudo Cyprus) etc.

In different parts on the territory of KNPP are some grass areas, which are in different stages of ongoing vegetation fluctuations. In the established green areas of different mixtures of English rye-grass, Meadow Grass, Estuca and other grass species some secondary changes of the vegetation fluctuations occurred in different aspects and the different phytocenoses in different quantitative ratios include the following species *Potentilla reptans* L. (creeping cinquefoil), *Cynodon dactylon* (L.) Pers. (couch-grass), *Agropyrum hispidus* (Opiz.) Meld. (twitch-grass), *Polygonum aviculare* L. (prostare knodweed) *Achillea setaria* Waldst. and Kit. (Even-leaved milfoil), *Convolvulus arvensis* L. (Bindweed), *Taraxacum officinale* Web. (Common Dandelion), *Trifolium pratense* L. (Red Trefoil) *Trifolium repens* L. (White Trefoil), *Oxalis corniculata* L. (Creeping Woodsorel), *Erodium cicutarium* (L.) L, Her., *Ranunculus repens* L. (Creeping buttercup), *Reseda lutea* L. (Dyer's Rocket Weld), and *Cichorium intybus* L. (Common Chicory), *Setaria viridis* (L.) Beauv. (Green Bristle-grass), *Plantago lanceolata* L. (Ribwort Plantain), *Echinochloa crus-galli* (L.) Beauv. (Cock's Millet), *Sinapis arvensis* L. (Cock's Millet), *Malva pusilla* Sm. (low mallow), *Senecio vulgaris* L. (old-man-in-the-spring), *Medicago lupulina* L. (Black Medick Yellow Trefoil), *Coronilla varia* L. (*Coronilla varia* L.), *Vicia angustifolia* Grufb. (Garden Vetch) etc.

In the contemporary vegetation in adjacent to KNPP areas agrophytocenoses and secondary grass communities prevail, which are formed on agricultural lands at the place of mixed forests of Turkey oak (*Quercus cerris* L.) and Virgillian Oak (*Quercus*

virgilliana Ten.) L.

In some sections are derivative xerotherm vegetation where *Poa bulbosa* L., Bermuda Grass (*Cynodon dactylon* (L.) Pers.), Rye-Grass (*Lolium perenne* L.) etc prevail. This vegetation is typical for pasture-ground territories where at more slightly trampled places are *Lolium perenne* L. (Rye-Grass) and White Trefoil (*Trifolium repens*, L.) and at the better trampled places Bermuda Grass (*Cynodon dactylon*), *Poa bulbosa*, Beard Grass (*Dichanthium ischaemum*(L.) Roberty) and Valesian Flescue (*Festuca vesiciaca* Schl.).

On inclines and steep slopes xerotherm grass euophitia are formed with the prevalence of Beard Grass (*Dichanthium ischaemum* (L.) Roberty). In the community of the Beard Grass there are considerable shares of the species of Black Beard Grass (*Chrysopogon gryllus* (L.) Trin., *Poa bulbosa* L., Panonic Thyme (*Thymus panonicus* All.), Poley (*Teucrium pollium* L.), Vetch (*Astragalus onobrychis* L.), Myrsin Sperge (*Euphorbia myrsinites* L.), Cyprus Sperge (*Euphorbia cyparissias* L.), Salad Burnet (*Sanguisorba minor* L.), Small-Fruit Medic (*Medicago minima* (L.) Bart), Ajuga chia Sch., Cylindrical Wild Wheat (*Aegilops cylindrical* Host.), Hop clover (*Trifolium arvense* L.), Rough Clover (*Trifolium scabrum* L.), Meadow Holly (*Eryngium campestre* L.), Willowleaf frostweed (*Helianthemum salicifolium* L.), Palestinian Cress (*Crepis sancta* (L.) Babc.) Astera Ceae (*Leontodon crispus* Vill.), Astera Cantabrica (*Convolvulus cantabrica* L.), *Ononis arvensis* L. (Common Restharrow), *Polygala major* Jacq. (Polygalaceae), *Plantago lanceolata* L. (Ribwort Plantain), *Scabiosa micratha* Desf. etc.

At some overmoistened places alongside the Danube River there are some forest communities where White Willow (*Salix alba*), White Poplar (*Populus alba* L.) and Black Poplar Prevail (*Populus nigra* L.). In some sections there are forest cultures of hybrid Poplars (*Populus X euroamericana*).

At some overmoistened habitats there are swampy and marshy grass vegetation with prevailing reed (*Phragmites australis* (Cav.) Trin ex Stend.), Lasser Reedmace (*Typha angustifolia* L.) and *Schoenoplectus lacustris* L. (Lakeshore Burlush).

In the mesophyte grass vegetation prevail the *Festuca pratensis* Huds (Poaceae), *Elymus repens* (L.) Gould. (quack grass), *Agrostis stolonifera* L.(creeping bentgrass), *Poa pretensis* L (Smooth-stalked Meadow grass) etc.

Base on the accepted dominant and florist classification approach the agrophytocenosis, derivative grass communities are involved into the following classification diagram:

- Class Stellarietea mediae Br.-Bl. 1931, Tx., Lohm., Prsg., 1950
- Order Centauretalia cyani Tx.,Lohm., Prsg., 1950
- Union Agrostidion spica venti (Krusem. et Vligeger,1939) Tx., Oberd., 1949
- Association Anthemis austriaca + *Vicia pannonica* + *Myosotis striata* Kol., 1976
- Association Anthemis austriaca – *Hypecoum grandiflorum* Kol., 1976
- Union Caucalion lappulae Tx., 1950

- Association Sinapis arvensis + Bifora radians + Vicia striata + Veronica  
– hederifolia Kol., 1979
- Association Sisymbrium orientale – Bifora radians – Camelina rumelica Kol.,  
– 1978
- Association Anthemis austriaca – Delphinium orientale Kol., 1976
- Union Lolium remoti – Linion Tx., 1950
- Association Eruca sativs Kol., 1976
- Order Chenopodetelia albi Tx. Et Lohm., 1950
- Union Sisymbrium officinalis Tx., Lohm., Prsg., 1959;
- Union Panico – Setarion Sissingh, 1946;
- Association Cynodon dactylon – Hibiscus trionum Kol., 1976;
- Association Chondrilla juncea + Sorghum halepensis Kol., 1976;
- Association Equisetum arvense – Xanthium italicum Kol., 1976;
- Association Echinochloa crus-galli – Galinsoga parviflora Kol., 1976;
- Class Festuco-Brometea Br.-Bl. et R. Tx. in Br.-Bl.,1949 (Brachipodio-  
– Chrysopogonetea Horvatic, 1958);
- Class Molinio-Arrhenatheretea R. Tx., 1937;
- Class Artemisiete a vulgaris Lohmeyer et al. ex von Rochow, 1951;
- Class Galio-Urticetea Passarge ex Kopecky, 1969;
- Class Phragmito-Magnocaricetea Klika in Klika et Novak 1941.
- Class Quercetea pubescentis Doing-Kraft ex Scamoni, 1959.
- Class Salicetea purpurea Moor, 1958.

### ***3.3.1.1 General characteristics flora and vegetation within the 30-km zone in Romania***

According to official information received from Romania for EIA the 30-km zone around the KNPP includes the territories south of Dolj up to Danube River, Romanatilor, plane Bailesti, the Rivers Jiu, Jiet and their inflows with an area of 133035 ha. The vegetation in this area is mostly secondary and derivative origin since most agricultural land with total area of 106976 ha, of which crops are grown. Forests, coastal lands and sands hold an average of 12 % and the built environment around 6 %.

Information provided by the Romanian side of the distribution area of land cover classes in the areas of Dolj, Gorj, Mehedini, Olt, Teleorman Valcea and is presented in table 3.3.1.1-1.

**Table № 3.3.1.1-1 Distribution of the Romanian territory in the land cover classes, within a 30-km zone around the KNPP**

District	Farmlands	Built-up areas	Forests, coastal lands, sands.	Lakes, rivers	Swamps
DOLJ	563178.78	48720.69	94832.91	13193.50	19885.55
GORJ	10328.13	1706.40	7701.76	340.18	572.47
MEHEDINI	114257.11	7653.91	23048.81	1625.75	2168.38
OLT	332219.23	29438.10	37205.86	8931.71	734.03
TELEORMAN	83528.41	5312.30	7779.09	1655.12	96.57
VALCEA	20439.09	2378.91	13175.43	463.81	17.55

The data in the table shows that all these areas are dominated by farmland - about 77 % of the area. In these lands annual crops, orchards, berry plantations, vineyards and more are cultivated. The agricultural land has a significant participation of natural vegetation in pastures and uncultivated agricultural lands.

In southern Dolj district native vegetation in more than 90 % of the area is replaced by secondary and derived vegetation of arable and uncultivated lands. Separate areas of plantations have dominated hairy oak (*Quercus pubescens*) or pedunculiflora oak (*Quercus pedunculiflora*). Grass communities are in grade type. They are formed by species resistant to drought and can refer to class formations *Aestiduriherbosa*.

The vegetation in the valley of the southern part of Dolj district, as part of the forest-steppe zone includes forest plantations dominated by *Quercus pubescens* and *Quercus pedunculiflora* and glades (*Quercus pubescens* and *Quercus pedunculiflora*), reaching near floodplain areas along the Danube River.

After the deforestation of the sandy lands, wind's action has reactivated sand dislocation, a fact that imposed planting of *Robinia* spp. on the sand dunes. This become protective forest-belt for the following settlements: Maglavit, Ciuperceni, Poiana Mare, Desa, Piscu Vechi, Ghidici and on the left side of Jiu River to: Rojistea, Apele Vii, Celaru, Amarasti, Piscu Sadovei, Bechet, Calarasi and Dabuleni.

The vegetation of Danube meadow and Jiu meadow is affected by sandy lands, up-level of ground water layer and by the presence of wet silts.

Along rivers and floodplains vegetation communities are dominated by willow trees (*Salix*), poplar trees (*Populus*), osier willow (*Salix fragilis*), which form part of the riparian vegetation.

In drier habitats there are mixed forests dominated by oak (*Quercus* spp.) in combination with hazel (*Corylus*), wild rose (*Vitis*), etc.

On the lakes and wetlands areas there is hydrophilic vegetation dominated by: common reed (*Phragmites australis*), cooper's reed (*Typha latifolia*), white water lily (*Nymphaea alba*), sedge (*Carex* spp), shave grass (*Scirpus maritimus*), creeping buttercup (*Ranunculus repens*), common duckweed (*Lemna minor*).

In the lake planning sector of Danube meadow (Ghidici-Rast-Bistret, Jiu-Bechet-Dabuleni), the native associations of willow trees and poplar trees have been mostly cleared(deforested), but are still existing on some small islands. Their place has been taken by hybrids of poplas (*Populus* spp) and (*Salix* spp).

In floristic approach to classification of vegetation agrofytotsenozite, derived grasslands, forest communities and other derivatives and secondary communities in the adjacent area to the Kozloduy Nuclear Power Plant in Romania can be related to the following groups:

- Communities of free-floating kormofite plants Class Lemnetaea R.Tx. 1955
- Communities in freshwater pools attached to the bottom and floating plants Class Potametea Klika in Klika et Novak, 1941;
- Water and round-water vegetation attached to the bottom of freshwater and brackish swamps Class Phragmito-Magnocaricetea Klika in Klika et Novak, 1941;
- Weed plants in rice fields of the class Oryzetea sativae Miyawaki, 1960;
- Sinantrop communities dominated by annual species of disturbed habitats over-humid Class Bidentetea tripartite R.Tx. et all. Ex von Rochow, 1951;
- Communities of annual change of a shrunken land and weed communities in row crops class Stellarietea mediae Br.-Bl., 1931, Tx., Lohm., Prsg., 1950;
- Steppes and sandy grassland class Festuco-Brometea Br.-Bl. et R. Tx. in Br.-Bl., 1949 (Brachipodio-Chrysopogonetea Horvatic, 1958);
- Mesophytic grassland class Molinio-Arrhenatheretea R. Tx., 1937;
- Poplar and willow riverside forests and shrubs Class Salicetea purpurea Moor, 1958;
- Thermophilic oak forests Class Quercetea pubescentis Doing-Kraft ex Scamoni, 1959.

### **3.3.2 KNPP impact on the flora in the 30-km area on the territory of Bulgaria**

Vegetation in the region of KNPP could be considered as an object impacted by the power plant on one part and, on the other part, as an indicator of the environmental impact.

Analysis of the data from Annual reports of the Department ERC “Results of the environmental radiation control” of KNPP of the investigated grass vegetation (4 times per year the points in Kozloduy, Harlets and Oryahovo, twice per year on the industrial site and once per year at the points of Lom, Pleven and Berkovitsa) within the period 1993-1997 [34] allows to make the following conclusions:

- Gamma spectrometric measurements of the grass samples show that the anthropogenic nuclides typical for the NPP ( $^{137}\text{Cs}$ ,  $^{60}\text{Co}$  and  $^{54}\text{Mn}$ ) are recorded only on the territory of the power plant. For instance, the value of  $^{137}\text{Cs}$  in the grass for 1998 at point 32 (with considerably higher cesium content in the soil), is also higher. Values of the NPP site are 5.06 - 19.5 Bq/kg a.d.w. As a comparison, in the beginning of the investigated period, e.g. for 1994 higher values were recorded at the same point – from 11 to 24.8 Bq/kg a.d.w.



- Content of  $^{60}\text{Co}$  at the points of the plant is from 1.2 to 29.6 Bq/kg a.d.w., and in 1997 - with 3 times lower upper limit (1.2 from 7.9). Such higher values are recorded also for  $^{54}\text{Mn}$  – up to 9.29 Bq/kg a.d.w., (and in 1997 below MAA);
- Approximately, all samples of the points beyond the industrial site show results for  $^{137}\text{Cs}$  about 1 Bq/kg a.d.w. When for the samples from the KNPP site higher values are assumed due to the higher content of the radionuclide at some places in the soil, for the places beyond the protected territories it could be said that the recorded activity is a result of the Chernobyl radiocesium in the soils;
- Content of  $^{90}\text{Sr}$  in the vegetation in 1998 is 0.30 - 2.52 Bq/kg a.d.w. Before commissioning of the NPP the measured average values were 4.4 - 0.3 and in 1994 they were 0.17 - 1.64 Bq/kg a.d.w. It is hardly possible to explain the higher values of strontium before the commissioning of the power plant precisely. May be it could be assumed that there is a considerable difference between the methods applied 25 years ago and the current ones as well as in their accuracy. May be, some experiments have been made with parallel measurements (there are no such ones known), but if they have not been made it is expedient to do so in order the facts to be added to the annual reports and the needed comment to be made as well.

The results of radiation monitoring of agricultural products made by sampling in four sectors in 3-km area show that the sunflower (heads) in the sector to the east from KNPP has the highest beta activity – 1022 Bq/kg a.d.w. and close to it in the northern sector – 915 Bq/kg a.d.w. As a comparison, in 1994 values around 1000 Bq/kg a.d.w. were detected for the sunflower in three directions – N, E and W. Considerably lower are the values of barley (straw) - 288 Bq/kg a.d.w, corn (cobs) – 176 Bq/kg a.d.w. or around these values in different years.  $^{90}\text{Sr}$  content is quite lower - for the sunflower it is 3.36 Bq/kg a.d.w.; medick - 1.74; wheat (straw) - 1.07 Bq/kg a.d.w; barley (straw) - 0.83 Bq/kg a.d.w.

Investigations related to the EIA elaborated in August 1999 [36] show corresponding results with the ones taken from RREC. With the analyses in the National Center for Environment and Sustainable Development of the samples taken by the experts it is determined that the content of  $^{137}\text{Cs}$  in the leaves of peppers from the greenhouse of KNPP 0.7 and in the grass next to the stadium in Glozhene is 10, while in the sample of the grass area in front of SB-1 it is 8.7Bq/kg. This is a confirmation that the plant territory has rather higher content of the anthropogenic radionuclide comparing with the region beyond the sanitary protected area –e.g. the points in Kozloduy, Glozhene etc.

Based on the analyses of heavy metal in the vegetation samples from KNPP greenhouse content of Fe 79.7 mg/kg and 54.1 mg/kg dry weight is determined, while in the village of Glozhene it is 117.5 mg/kg dry weight. Content of Mn is the highest in the sample from Botev alley -140 mg/kg dry weight, and in the grass before SB -1 it is 114.8 Bg/kg. An analysis made of the soil, grass and leaves samples from the greenhouse of KNPP and several points from the site and around it shows that both of the soil, grass and leaves samples (P1 and P2) from the greenhouse have a higher content of iron, manganese and zinc. Sample P2 shows higher copper content –

1.31°mg/kg dry weight.

In the annual report of “Results of the environmental radiological monitoring of the environment in KNPP ”-2007“(III, 2008) [35] some results are presented of the investigations made of grass vegetation 4 times per year at the points of Kozloduy, Harlets and Oryahovo (gamma spectrometry and <sup>90</sup>Sr), 2 per year on the sites of KNPP (gamma spectrometry) and at the points of Lom, Pleven and Berkovitsa (gamma spectrometry and <sup>90</sup>Sr) once per year. Collection of the samples is made next to the points at the same places from where the samples have been taken. In 2007 12 samples were analyzed in 100-km monitoring area.

Results received for the content of <sup>90</sup>Sr in the grass vegetation are within the range of 0.18 - 2.75 Bq/kg a.d.w., of average value of 1.43 Bq/kg a.d.w. Results are comparable with the ones measured during the previous years. Maximal value is recorded at point 9 (village of Harlets). Determined differences are related to the differences of the vegetation composition during the years and seasonable features of the taken samples. For instance, during long lasting dry periods there is no possibility to collect samples of fresh grass and dry caulis containing more cellulose.

Long term studies (1994-2007) of <sup>90</sup>Sr in the vegetation at 100-km monitoring area show variation of 0.18 - 4.75 Bq/kg a.d.w. Before commissioning of KNPP the measured average activities were 4.4 +/- 0.3 Bq/kg a.d.w.

Activity of <sup>137</sup>Cs in the vegetation for 2007 was within the range of 0.80 -5.35 Bq/kg a.d.w. All samples, including the ones from the industrial site have shown <sup>54</sup>Mn, <sup>60</sup>Co and <sup>134</sup>Cs lower than the respective MAA.

Monitoring of the vegetation in the agrophytocenoses covers the main agricultural crops. Barley, wheat, corn, sunflower etc. have been studied. For all tests a separate analysis is made of the grain and straw (cobs, sunflower heads). In order to facilitate the processing of the results the sampling from the agricultural production within 3 km Sanitary Protection Zone is made in 4 sectors provisionally split fewer than 90° towards N-E-S-W.

In 2007 there were 18 analyses made of the grain-wheaten crops, of which 6 were gamma-spectrometric, 6 radiometric of total beta activity and 6 determinations of <sup>90</sup>Sr. Investigation results show activity of <sup>137</sup>Cs within the interval from 0.5 to 6.0 Bq/kg a.d.w. Recorded activity of <sup>90</sup>Sr is within the range from 0.037 - 1.3 Bq/kg a.d.w., and the higher values are measured in the straw of the analyzed agricultural products. This fact complies with the standard facts for the distribution of the radionuclide in different parts of the plants. Results of the performed gamma-spectrometric measurements show that the recorded total beta activity dominates in the straw (cobs, heads) and varies within normal range from 188 Bq/kg a.d.w. for the grain and 388°Bq/kg a.d.w. in the wheat straw. Received results of the same objects are comparable with the ones for previous years.

Similar results are also received during the monitoring held in 2008.

In 2009, grass vegetation was tested four times a year on points in the town of Kozloduy, Harlets and Oryhovo (gamma-spectrometry and <sup>90</sup>Sr), twice a year at the Kozloduy site (gamma-spectrometry) and on points in Lom, Pleven and Berkovitsa

(gamma-spectrometry,  $^{90}\text{Sr}$  once a year). Sampling was carried out in close to the points, on the same places the soil samples were taken. About 2 kg grass were collected at a height of more than 2 cm from the ground. Submitted to the laboratory samples were put to primary preparation and processing for further analysis, including operations such as milling, homogenization, drying to constant weight and weighing of air-dry substance. Prepared samples are direct gamma-spectrometried (Marinelli-ldm3, 60000 s), such as MDA for  $^{137}\text{Cs}$  under these conditions is within the range  $0.75 + 2.30$  Bq/kg a.d.w. Separately vegetation is burned at  $450^\circ\text{C}$ , aliquot parts from the ash were analyzed for  $^{90}\text{Sr}$ . Determination of  $^{90}\text{Sr}$  is based on extraction from the ashes ( $\text{K.HCl} + \text{K.HNO}_3$ ), separation of Ca with sodium hydroxide and liquid scintillation spectrometry of  $^{90}\text{Sr}$  (In standby "Cherenkov counting") after the establishment of radioactive equilibrium. In described conditions for measuring time 10,000 s, MDA for  $^{90}\text{Sr}$  is average of 0.20 Bq/kg a.d.w.

In 2009, in accordance with the adopted methodology, totally 22 samples were analyzed in the 100-km zone. The number of made analyzes is 37 - 22 gamma-spectrometric and 15 with radiochemical isolation of strontium.

The results obtained for the content of  $^{90}\text{Sr}$  in vegetation in 2009 were within the range of  $<0.32$  d- $5.18$  Bq/kg a.d.w., with average of 1.31 Bq/kg a.d.w. The results are comparable to the measured in previous years. Maximum value was registered on p.30 (Berkovitzia). The observed variances are due to different vegetation types over the years and seasonal characteristics. For example, during lasting droughts the sampling of fresh grass is not possible and often dry vegetation (stems) is collected, containing more cellulose.

Activity of  $^{137}\text{Cs}$  in vegetation during 2009 is within the range of  $<0.89$  d- $5.00$  Bq/kg a.d.w., at average 1.65 Bq/kg a.d.w. Maximum measured value is on point-32 of Kozloduy NPP near "Genova" mound where wind distribution of contaminated ground mass on the soil layer is possible. All samples, including those from the production site have shown results for  $^{54}\text{Mn}$ ,  $^{60}\text{Co}$  and  $^{134}\text{Cs}$  lower than the corresponding MDA.

Based on the results of the monitoring of vegetation is concluded that radioactivity in the examined samples is in normal limits for these plants. Influence from the NPP on vegetation is not detected outside the site.

Monitoring of agricultural products of vegetable origin in 2009 covers investigation of basic types fodder crops produced in a 2-km zone - barley, wheat, corn, sunflower, etc. For all samples was made separate analysis of grain and straw (heads, cobs). The analysis methods were analogous with the ones used for plant analysis. In order to locate the possible impact of Kozloduy NPP and facilitate the processing of the results, the sampling of agricultural production in 2-km Precautionary protective action planning zone is executed in four sections, conditionally divided in angle of  $90^\circ$ , in direction north-east-south-west.

In accordance with the adopted methodology in 2009 have been made 44 analysis of cereal plants, including 22 gamma - spectrometric, 15 radiometric of total beta activity and 7 determinations of  $^{90}\text{Sr}$ . The results showed no  $^{137}\text{Cs}$  activity over MDA within the range  $<0.25$  to  $<2.41$  Bq/kg a.d.w. Recorded activity of  $^{90}\text{Sr}$  is

within the range 0.026 + 0.65 Bq/kg a.d.w. The results of the gamma- spectrometric measurements show that the registered total beta activity in samples is almost entirely due to natural  $^{40}\text{K}$ . Total beta activity dominates in straw (heads, cobs) and varies within the normal limits from 82.5 Bq/kg a.d.w. in corn grains, to 770 Bq/kg a.d.w. in the heads of sunflower. Higher values for measurements of silage (straw, heads, cobs) than in the grain of the analyzed products, consist with the literature data [34] for the distribution of radionuclides in different parts of the crops. Results for 2009 are in the normal limits and are comparable with data from previous years for the same crops.

In 2010, grass vegetation was tested four times a year on points in the town of Kozloduy, Harlets and Oryhovo (gamma-spectrometry and  $^{90}\text{Sr}$ ), twice a year at the Kozloduy site (gamma-spectrometry) and on points in Lom, Pleven and Berkovitzta (gamma-spectrometry,  $^{90}\text{Sr}$  once a year). Sampling was carried out close to the points, on the same places the soil samples were taken. About two kg grass were collected at a height of more than two cm from the ground. Submitted to the laboratory samples were put to primary preparation and processing for further analysis, including operations such as milling, homogenization, drying to constant weight and weighing of air-dry substance. Prepared samples are direct gamma-spectrometried (Marinelli-ldm3, 60000 s), such as MDA for  $^{137}\text{Cs}$  under these conditions is within the range 0.96 + 2.54 Bq/kg a.d.w. Separately vegetation is burned at 450°C, aliquot parts from the ash were analyzed for  $^{90}\text{Sr}$ . Determination of  $^{90}\text{Sr}$  is based on extraction from the ashes (k.HCl+k.HN $_3$ ), separation of Ca with sodium hydroxide and liquid scintillation spectrometry of  $^{90}\text{Y}$  (In standby "Cherenkov counting") after the establishment of radioactive equilibrium. In described conditions for measuring time 10000 s, MDA for  $^{90}\text{Sr}$  is average of 0.21 Bq/kg a.d.w.

In 2010, in accordance with the adopted methodology, totally 20 samples were analyzed in the 100-km zone. The number of made analyzes is 35 - 20 gamma-spectrometric and 15 with radiochemical isolation of strontium.

The results obtained for the content of  $^{90}\text{Sr}$  in vegetation in 2010 were within the range of 0.33 -2.39 Bq/kg a.d.w., with average of 1.31 Bq/kg a.d.w. The results are comparable to the measured in previous years. Maximum value was registered on p.27 (Oryhovo). The observed variances are due to different vegetation types over the years and seasonal characteristics. For example, during lasting droughts the sampling of fresh grass is not possible and often dry vegetation (stems) is collected, containing more cellulose.

Activity of  $^{137}\text{Cs}$  in vegetation during 2010 is within the MDA range of <0.96 -< 2.54°Bq/kg a.d.w. Minimum trace of 2.17 Bq/kg a.d.w is measured once on point 27 (Oryhovo). Technogenic activity of  $^{54}\text{Mn}$ ,  $^{60}\text{Co}$  and  $^{134}\text{Cs}$  is not measured in any sample. Due to regular mowing of the lawn at the site in 2010, no samples were taken for analysis.

Based on the results of the monitoring of vegetation is concluded that radioactivity in the examined samples is in normal limits for these plants. Influence from the NPP on vegetation is not detected outside the site.

Monitoring of agricultural products of vegetable origin in 2010 covers investigation of basic types fodder crops produced in a 3-km zone - barley, wheat, corn, sunflower,

etc. For all samples was made separate analysis of grain and straw (heads, cobs). The analysis methods were analogous with the ones used for plant analysis (see 11.1). In order to locate the possible impact of Kozloduy NPP and facilitate the processing of the results, the sampling of agricultural production in 2-km Precautionary protective action planning zone is executed in four sections, conditionally divided in angle of 90°, in direction north-east-south-west.

In 2010, in accordance with the adopted methodology, 20 samples of cereal plants are analyzed with 56 analyses - 20 gamma - spectrometric, 20 radiometric of total beta activity and 16 analyses of <sup>90</sup>Sr. Total beta activity dominates in straw (heads, cobs) and varies within the normal limits from 82.0 Bq/kg a.d.w. in corn grains, to 1 074 Bq/kg a.d.w. in the heads of sunflower. Higher values for measurements of silage (straw, heads, cobs) than in the grain of the analyzed products, consist with the literature data [34] for the distribution of radionuclides in different parts of the crops.

The results of the gamma- spectrometric measurements show that the registered total beta activity in samples is almost entirely due to natural <sup>40</sup>K.

In 2010, as previous years, measured background activity of <sup>137</sup>Cs and other technogenic radionuclides is in normal limits ( for <sup>137</sup>Cs MDA is <0.29 to <5.0 Bq/kg a.d.w.). Recorded activity of Sr is in the range 0.064 - 3.09 Bq/kg a.d.w. The maximum value is for sunflower heads - 2nd district. Results for 2010 are in the normal limits and are comparable with data from previous years for the same crops.

In 2011, grass vegetation was tested four times a year on points in the town of Kozloduy, Harlets and Oryhovo (gamma-spectrometry and <sup>90</sup>Sr), twice a year at the Kozloduy site (gamma-spectrometry) and on points in Lom, Pleven and Berkovitzta (gamma-spectrometry, <sup>90</sup>Sr once a year). Sampling was carried out close to the points, on the same places the soil samples were taken. About two kg grass were collected at a height of more than two cm from the ground. Submitted to the laboratory samples were put to primary preparation and processing for further analysis, including operations such as milling, homogenization, drying to constant weight and weighing of air-dry substance. Prepared samples are direct gamma-spectrometried (Marinelli-ldm<sup>3</sup>, 60000°s), such as MDA for <sup>137</sup>Cs under these conditions is within the range 0.78 + 2.55 Bq/kg a.d.w. Separately vegetation is burned at 450°C, aliquot parts from the ash were analyzed for <sup>90</sup>Sr. Determination of <sup>90</sup>Sr is based on extraction from the ashes (κ.HCl+k.HN0<sub>3</sub>), separation of Ca with sodium hydroxide and liquid scintillation spectrometry of <sup>90</sup>Y (In standby "Cherenkov counting") after the establishment of radioactive equilibrium. In described conditions for measuring time 10000 s, MDA for <sup>90</sup>Sr is average of 0.18 Bq/kg a.d.w.

In 2011 totally 22 samples were analyzed in the 100-km zone. The number of made analyzes is 37 - 22 gamma- spectrometric and 15 with radiochemical isolation of strontium.

Activity of <sup>137</sup>Cs in vegetation during 2011 is within the MDA range of <0.78 -< 2.55°Bq/kg a.d.w. Minimum trace of 1.8 Bq/kg a.d.w is measured once on point 13 (dep. RM). Technogenic activity of <sup>54</sup>Mn, <sup>60</sup>Co and <sup>134</sup>Cs is not measured in any



sample.

Based on the results of the monitoring of vegetation is concluded that radioactivity in the examined samples is in normal limits for these plants. Influence from the KNPP on vegetation is not detected outside the site.

Monitoring of agricultural products of vegetable origin in 2011 covers investigation of basic types fodder crops produced in a 3-km zone - barley, wheat, corn, sunflower, etc. For all samples was made separate analysis of grain and straw (heads, cobs). The analysis methods were analogous with the ones used for plant analysis (see 11.1) In order to locate the possible impact of NPP "Kozloduy" and facilitate the processing of the results, the sampling of agricultural production in 2-km Precautionary protective action planning zone is executed in four sections, conditionally divided in angle of 90°, in direction north-east-south-west.

In 2011, in accordance with the adopted methodology, 18 samples of cereal plants are analyzed with 43 analyses - 18 gamma - spectrometric, 18 radiometric of total beta activity and 7 analyses of <sup>90</sup>Sr.

Total beta activity dominates in straw (heads, cobs) and varies within the normal limits from 98.7 Bq/kg a.d.w. in corn grains, to 1 083 Bq/kg a.d.w. in the heads of sunflower. Higher values for measurements of silage (straw, heads, cobs) than in the grain of the analyzed products, consist with the literature data [34] for the distribution of radionuclides in different parts of the crops.

The results of the gamma- spectrometric measurements show that the registered total beta activity in samples is almost entirely due to natural <sup>40</sup>K.

In 2011, as previous years, measured background activity of <sup>137</sup>Cs and other technogenic radionuclides is in normal limits (for <sup>137</sup>Cs MDA is <0.23 to <1.75 Bq/kg a.d.w.). Recorded activity of Sr is in the range 0.073 – 1.54 Bq/kg a.d.w. The maximum value is for sunflower heads – 3rd district. Results for 2011 are in the normal limits and are comparable with data from previous years for the same crops.

### Conclusions:

Performed analysis indicate that the contemporary green system on the territory of KNPP involves the same groups of wood and shrubby species of different age, which are planted in different periods. On the grass areas there are mostly derivative and secondary plant communities formed upon the vegetation fluctuations of the grass communities formed by grass mixtures.

In the vegetation of the territories adjacent to the KNPP from 5 km and 30 km the agricultural plants prevail. On the desolated agricultural lands some derivative and secondary grass communities are formed, which consist of wide distributed grass species. Contemporary forest communities are of considerably poor stability.

The results of the investigation for the impact on natural vegetation and crops show that the radioactivity in the examined samples is in the normal limits for the examined species. Influence of Kozloduy NPP on vegetation outside the site is not established.



### 3.3.3 Influence of KNPP on vegetation within the 30-km zone in Romania

In Romania, the Ministry of Health insures the radioactivity monitoring of the influence area of KNPP – Bulgaria, through 4 laboratories, called Surveillance Stations for Radioactivity Monitoring (SSRM): SSRM Bechet, SSRM Craiova, SSRM Drobeta Turnu Severin and SSRM Zimnicea, and also 17 automatic air gamma dose rate monitoring stations (15 in Dolj county, one in Mehedinti county and one automatic station in Teleorman county). So far, no evidence of increased quantities of radioactive substances in plants under the influence of KNPP.

Tables 3.3.3-1 and 3.3.3-2 presents the results of radiological monitoring of parts of plants used for food.

**Table 3.3.3-1 Results of radiological monitoring in Romania within 30-km from the KNPP for  $\beta$  activity**

Sample	Year	District	Location	Dimintion	Total $\beta$ activity
Wheat	15.12.2008	Dj	Gighera	Bq/kg	89.9±7.2
Wheat	14.12.2009	Dj	Gighera	Bq/kg	81.2±6.7
Wheat	12.11.2010	Dj	Gighera	Bq/kg	79.5±7.2
Apple	15.12.2008	Dj	Gighera	Bq/kg	37.7±4.9
Apple	14.12.2009	Dj	Gighera	Bq/kg	34.7±5.1
Apple	13.12.2010	Dj	Gighera	Bq/kg	39.3±3.8
Potato	15.12.2008	Dj	Gighera	Bq/kg	132.7±6.7
Potato	14.12.2009	Dj	Gighera	Bq/kg	129.9±9.7

**Table 3.3.3-2 Results of radiological monitoring in Romania within 30-km from the Kozloduy NPP**

Sample	Year	District	Location	Dimintion	Cs-137	Sr-90	Ra-226
Milk	15.12.2008	Dj	Gighera	Bq/l	0.13±0.04	0.022±0.009	0.0056±0.0029
Milk	14.12.2009	Dj	Gighera	Bq/l	0.041±0.01	0.039±0.01	0.0054±0.003
Milk	13.12.2010	Dj	Gighera	Bq/l	0.044±0.01	0.035±0.015	0.0049±0.003
Wheat	15.12.2008	Dj	Gighera	Bq/kg	0.41±0.16	0.18±0.069	0.029±0.008
Wheat	14.12.2009	Dj	Gighera	Bq/kg	0.34±0.008	0.13±0.04	0.028±0.007
Wheat	12.11.2010	Dj	Gighera	Bq/kg	0.33±0.014	0.11±0.043	0.023±0.001
Apple	15.12.2008	Dj	Gighera	Bq/kg	0.039±0.013	0.019±0.005	0.0064±0.0028
Apple	14.12.2009	Dj	Gighera	Bq/kg	0.035±0.014	0.014±0.001	0.003±0.001
Apple	13.12.2010	Dj	Gighera	Bq/kg	0.037±0.017	0.016±0.007	0.0028±0.0017
Potato	15.12.2008	Dj	Gighera	Bq/kg	0.047±0.016	0.014±0.006	0.022±0.009
Potato	14.12.2009	Dj	Gighera	Bq/kg	0.035±0.01	0.003±0.00	0.006±0.01

---

	9		a		5		1	
--	---	--	---	--	---	--	---	--

## Conclusions

1. On the Romanian territory within the 30-km around KNPP adjacent vegetation areas with agricultural crops are predominant. On abandoned agricultural lands derivatives and secondary grasslands have been formed. On flooded areas and swamps specific plant ecosystems have been formed.
2. There is no known negative impact of KNPP on natural vegetation and agricultural crops and derivatives.

## 3.4 Fauna

### 3.4.1 Birds

KNPP is located in the north-western part of Bulgaria on the territory of Vratsa District, Kozloduy Municipality, mainly in the lands of the town of Kozloduy and the village of Harlets. Its location is shown on the geographic map in the Appendix 11.6-1. The site is located respectively about 3.5 km south-east from Kozloduy, 4.0 km northwest from the village of Harlets, 65 km northern from the District Centre of the town of Vratsa and 200 km northern from the town of Sofia. It is almost entirely located on agricultural lands on the first not overflowed terrace of the Danube River, which is located about 3 km away to the north (fig. 3.4.1.1).

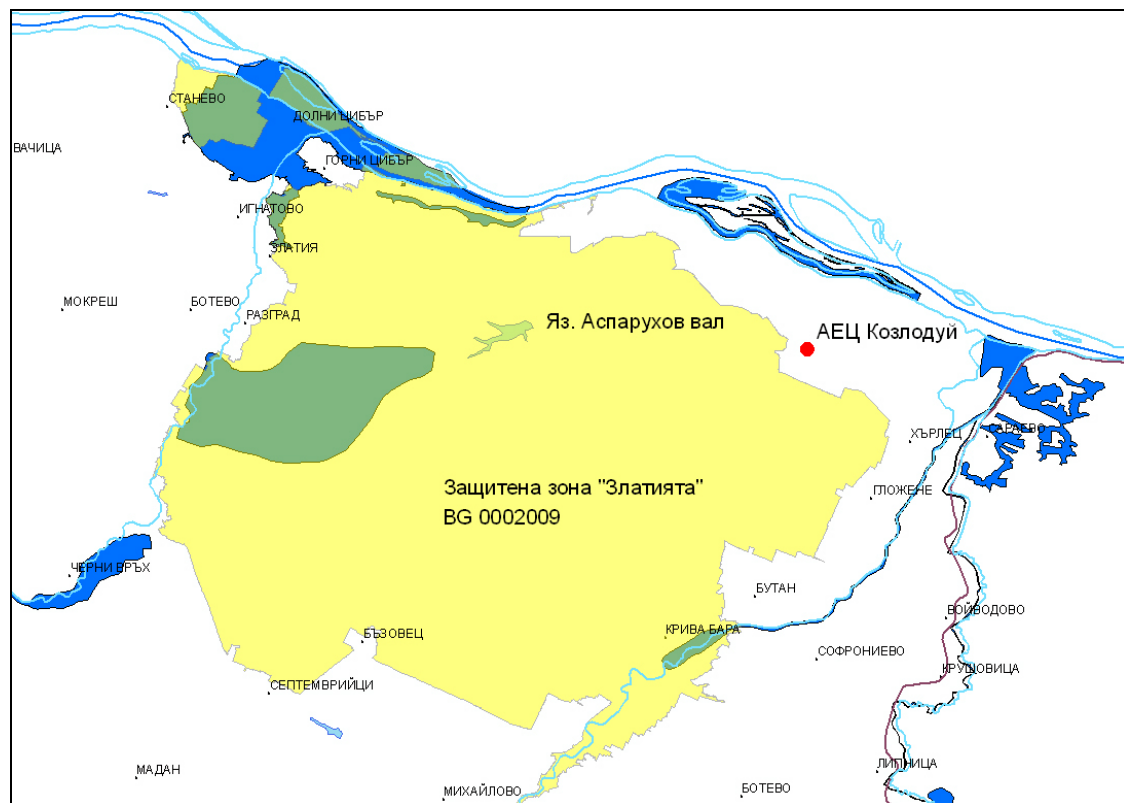

**Fig. 3.4.1-1 Location of KNPP (yellow color marks the territories of the protected areas according to the Bird Directive, blue color marks the territories under the Directive for habitats and green color - under both directives)**

Legend:

АЕЦ Козлодуй - Kozloduy NPP

33 Златията BG0002009 - Protected area Zlatiyata BG0002009

Язовир Аспарухов вал - Asparuhov val Dam

Main part of the Hygiene Protection Area (HPA) of the power plant covers agricultural lands of the adjacent region. To the north from KNPP these are the lands of Blatoto area, in the overflowed terrace of the river, a part of which after the construction of a drainage network are not swampy and are usable. Kozloduy Island is located within the Danube River. Behind it there are some other islands located. The

biggest of which is Tsibar (Ibisha) Island. Lands of the first not overflowed terrace and higher terraces are located to the east. To the south the green belt of the bank area and lands under the loess tableland Zlatiata are involved within the borders of HPA having typical steppe fauna. Asparuhov (Shishmanov) bank and 5 micro dams are located there and the biggest of them is located next to the village of Septemvriitsi. Except agricultural lands there are linear facilities, communications, heat pipeline etc. located to the west.

According to the zoological and geographic allocation of the regions made by Georgiev (2002), region of KNPP is a part of the Danube zoological and geographic region. It covers the territory of the Danube valley, Ludogorie and a part of the Dobrudzha tableland. Most types of its fauna are of European-Siberian and European elements. This is also valid for the nesting birds, which are very similar to the ones of the Black seacoast – 85.6 %. Mediterranean Bird species are represented most rarely comparing with the other zoological geographic regions and the Northern species are distributed 4 times more than the ones of Southern type.

#### **3.4.1.1 Generative period**

There are some brief data about the birds of KNPP area published by Patev (1950), Paspaleva-Antonova (1961), Simeonov etc. (1990), and Nankinov etc. (1997). Recently, in connection with the construction of the national environmental network Natura 2000, some ornithological information is published by Kostadinova, Gramatikova (2007). There is valuable information about the bird species pursuant to the Bird Directive contained also in the standard forms for the protected areas Zlatiata, Tsibar bog, Ibisha and the Island next to Gorni Tsibar. Data about the species and quantitative composition of the nesting ornithological fauna of UTM (Universal Transverse Mercator) quadrants, where Zlatiata is situated, are presented by Yankov (2007) [45] and Michev etc. (2008) [44]. Information for the wildlife, including birds is contained in the EIA-R of KNPP elaborated in 1999 (Appendixes 4.7.3-1 and 4.7.3-2).

Based on the literature review it could be concluded that within the region around the site of KNPP there are above 120 bird species from several ecological groups. The most numerous is the group of the water-loving birds followed by the species of the open areas etc. 23 species of nesting birds are determined in the investigated region. Also, there are three registered nests of long-legged Buzzard (*Buteo rufinus*). In the populated areas around the investigated region there are totally 65 inhabited nests of white storks and the most nests (12) are located in the village of Dolno Tserovene (municipality of Yakimovo).

There are several bird species having special status. These are species of worldwide importance that exceed 1 % Ramsar threshold, species of the Bulgarian Red Book, species of single habitats in the country, species-subject to environmental protection, the most numerous migrants etc. All they will be examined consequently:

Burch (*Pelecanus crispus*) – Hunts in the neighbor Romanian marshlands and stays for the night and rests next to the sand spits of the adjacent islands. Single birds and small flocks are monitored when making food migrations to the Dam next to the village of Septemvriitsi. During the migration big concentrations were found (between

150 and 252) in the Island Protected Area next to the Gorni Tsibar BG0002008.

White stork (*Ciconia ciconia*) – common nesting species nesting in the villages around "Zlatiata". In 1994 there are above 50 nests on the territory of Kozloduy Municipality and in 2004 – between 60 and 130. It is at fourth place among the migrants during the autumn migration in the region amounting to 1106 birds.

Little white-fronted goose (*Anser erythropus*) –there are no data available in the Bulgarian ornithological literature about these world endangered species in the examined region but in the standard forms there are data about the hibernating single birds.

Montagu's harrier (*Circus pygargus*). In the standard form for the protected area of "Zlatiata" it is specified as a nesting type. During the migration there are 127 spring and 16 autumn migrants recorded (Michev etc., 2008).

Red-footed falcon (*Falco vespertinus*). In the standard form of the protected area "Zlatiata" it is specified as nesting species, but there is no nesting proven for sure. In the site of the investmen proposal and in the rest part of the protected area a big part of the threes, where usually the nests of these species are located, are cut.

Great bustard (*Otis tarda*). In the standard form for the protected area of "Zlatiata" it is specified as a nesting type. No nesting is proven for sure. As a result of the monitoring (Michev etc., 2008 [44]) no nesting is found for sure. Considering the presence of many people and agricultural equipment in Zlatiata there are no conditions for reproduction of great bustards.

Golden plover (*Pluvialis apricaria*) – the most numerous migrant during the spring migration in the investigated region amounting to 1318 birds (Michev etc., 2008)

Field-lark (*Alauda arvensis*) - the most numerous nesting species amounting to 1155 birds or 2.4 % of the total number (47870 species) of the birds in the Protected Area „Zlatiata”.

During the visit on 29 October 2009 on the site of KNPP (between the administrative buildings, Unit 2 and the beginning of both channels) the following bird species has been found:

- Long-legged buzzard (*Buteo rufinus*) – one adult bird in flight over the Access Control Point in the south part of the plant region;
- Black-headed gull (*Larus ridibundus*) – a flock of six birds in flight over the beginning of the hot channel;
- Fantail pigeon (*Columba domestica*) – a flock of 25 birds in flight over the western part of the power plant;
- House Martin (*Delichon urbica*) – old nests on the building of Unit 2;
- Great tit (*Parus major*) – one bird in the grass areas in front of the administrative building;
- Jackdaw (*Coleus monedula*) – flock of 12 birds in the beginning of both channels;

- Mag pie (*Pica pica*) – two birds in flight over the grass areas next to the administrative buildings of the power plant.
- Eurasian Tree Sparrow (*Passer montanus*) – birds fly off and in into old nests of the House Martins.

#### 3.4.1.2 Migration period

There are 4382 spring migrants and 25509 autumn migrants during the migration in the examined region (from the monitoring point in the north-west part of the Zlatiata) (Michev etc., 2008 [44]). The most numerous migrant in the spring is the Golden Plover (*Pluvialis apricaria*), and during the autumn this is common starling (*Sturnus vulgaris*). Among the 10 most numerous spring and autumn migrants there are some species subject to protection into the protected area (white and black stork, duck-hawk and Montagu's Harrier). Main migration direction of the birds through Zlatiata is north-west - south-east (NW – SE).

From the received results a conclusion could be made that over the examined region there are no numerous migrants passing through. The territory is not crossed by considerable migration roads. Totally, the migration of the flying birds is small.

The migrants are sorted to environmental groups as follows (table 3.4.1.2-1):

**Table 3.4.1.2-1 Allocation of the migrants by ecological groups during the spring and autumn migration of 2008 over the national park in Zlatiata**

Season	Flying	Sparrow-like	Water-loving	Other	Total
Spring	1302	844	2001	235	4382
Autumn	2236	22014	523	736	25509
<b>Total</b>	<b>3538</b>	<b>22858</b>	<b>2524</b>	<b>971</b>	<b>29891</b>

#### 3.4.1.3 Hibernating period

Regarding the hibernating period of the water loving birds there is considerable number of information available. It is collected during the annual Mediterranean counting since 1977 (Kostadinova, Dereliev 2001; Michev & Profirov, 2003 [36]). It is determined that a big part of the territory of the Zlatiata when there is no snow covering and icing of the Danube River and the dam of Asparuhov val could be a solid nutrition facility mostly for the great white-fronted (*Anser albifrons*) and grey geese (*Anser anser*). For the section of the Danube River, incl. dam of Asparuhov val, Michev & Profirov (2003) specifies average numerous of 25 years between 5600 and 7000 birds of 8-16 species). In the dam of Septemvriitsi (located to the south of the protected area Zlatiata) Kostadinova and Dereliev (2001) found 11 hibernating water-loving birds (*Anser albifrons* -5 birds and *Gallinago gallinago* – 6 birds).

#### 3.4.1.4 Summary of the ornithological situation in the region of Zlatiata protected area

As a result of the information accumulated by the birds' monitoring in the investigated territory the following picture could be prepared, which is shown on the satellite picture of Google Earth (fig. 3.4.1.4-1):





**Fig. 3.4.1.4-1 Region of KNPP together with the white-color areas of NATURA 2000 pursuant to the Bird directive and yellow-color ones pursuant to the Habitats directive; 12-km area is marked with white circle**



**Fig. 3.4.1.4-2 Protected areas on the left bank of the Danube River opposite to Kozloduy**

From there it is seen that to the north from the protected area Zlatiata from both sides of the Danube river there are several natural sites of high conservation value. They are based on large and rich of fish marsh-land next to the Romanian town Bustretsu, mouth of Zhiu and Tsibritsa Rivers and several big Danube islands (fig. 3.4.1.4-2).

Also here like alongside our Danube River coastal area, the islands which are not easily accessible for humans are used by the birds for nesting and the wide wet areas on the left bank are used for feeding. This is the reason why the main food migrations of the birds from the nesting colonies of cormorants and herons are directed to the north of Danube River. A small part of them fly to the South to the microdams located to the south of the Zlatiata as well as alongside the river bed of the Danube River and adjacent islands. Most attractive for the birds in the investigated region are agricultural crops in the Zlatiata and wet areas on both banks of the Danube River.

### **3.4.2 Animals**

NPP is located next to the Kozloduy town about 1.5-2 km away from the bank of the Danube River and it is at the foundation of the low table land closed between the Rivers Danube, Tsibritsa and Ogosta. Climate in this region is moderate continental. It has some typical features. Maximal rainfalls are during the summer (August) and minimal ones are during the winter (February). Torrential rain falls and stormy winds are typical for the region. Annual temperature fluctuations are very big, which is typical for the continental climate. There are severe cold weather periods during the winter and heat and dry periods during the summer. In the Danube side part due to the impeding impact of the Carpathian the rainfalls are reduced and next to Kozloduy they are only 500 – 550 mm. Snow cover occurs in December and melts in the second half of March.

As per B. Gruev and B. Kuzmanov (1994) moderate continental climate is favorable for distribution of the Northern biota and decreases strongly the possibility some Southern elements to settle there. In the opinion of the same authors European-Siberia, Medium European, holarctic and holopaleoartic species are typical for the region as well as a lot of steppe species in the treeless territories and a number of sub-Mediterranean species too.

Young biota is typical for the northern Bulgarian region that is distributed and developed there during the Quaternary. There are nearly no paleoendemic species and tertiary relicts available, because the tertiary lands in the present north Bulgaria have been overflowed by waters that have buried the remains of the Pliocene flora and Hyperion fauna.

According to the zoo-geographic classifications the territory of the IP is involved in the Danube subregion of the northern Bulgarian Region. This subregion covers the strip of land alongside the Danube River bordered to the South with the fore-Balkan and Ludogorie region and with Dobrudzha region to the east. In this most plain part of our country that is cut by plenty of rivers the primary forest steppe vegetation is strongly reduced due to the use of the land for agricultural purposes. Remains of the natural vegetation are kept on the terraces of the right, eastern situated banks of some rivers (e.g. Ogosta). These natural vegetation communities includes Hungarian oak,

Turkey Oak, Italian Pubescent Oak and English Oak. At some places there are mesophilic groups of *Quercus pedunculiflora*, manna ash and lime-tree and on the river banks there are hydrophilic communities of willows, white poplars with developed understory of elderberry, morus, Polish elm and ash-tree. In many land parts where the agricultural use of the land has been terminated a secondary grass vegetation of steppe type is grown, which is often mixed with weeds and ruderal species. These grass communities consist mainly of Medium-European, Palearctic and European-Asian (steppe) types. Beard-grass communities are very typical too. On the territories of loess soil located in a narrow strip of land next to Danube steppe vegetation grows where the fauna of prevailing steppe elements is prevailed. Such loess steppes or pseudo steppes are the reason for detachment of protected territories under Natura 2000 in order to protect and keep its specific flora and fauna. Especially valuables are the communities developed on extremely loess surfaces. Such places, where the upper black-earth layer is completely destroyed or is missing are the vertical levels alongside the Danube riverside as well as hills and steep banks of the rivers inflowing into the Danube river. In such section between two rivers Tsibritsa and Ogosta the ground within the KNPP is located.

Out of the species typical only for the Danube zoo-geographic subregion (and partially for the Dobrudzha region) there are a lot of species of Danube fishes, amphibians are represented by the Danube newt and Common Spadefoot and the mammalian are represented by two species of European hamsters (in the Danube river and riverside territories). Other species are typical for the river valleys, low lands and riverside territories. As such ones the fire-bellied toad and spotted snake could be classified.

According to the modern opinions in view of the zoo-geographic regional detachment of Bulgaria the fauna in the region consists mostly of the European and Euro-Siberian and other northern species that came into the region and are habited there during the Quaternary. A lot of steppe animals have come here from north-east and currently there are a small number of steppe refugiums available. A part of these species has been adapted to live in wheat and some other agrocenoses and another stenobiont part has survived only in the natural and semi-natural steppes. In the Danube fauna there is also quite significant as ranging Eurasian biota available, which has used wheat agrocenoses as an ecological corridor for its colonization expansion. Sometimes this Eurasian agro-steppe biota is not correctly determined as a priority one. Actually, it should be considered as invasive and secondary and should not be mixed up with the typical steppe elements. In contrast to the steppe fauna, which has a limited distribution these fauna is comparatively wide distributed including the open agrocenoses and secondary grass formations.

The ones of the invertebrates habiting the loess steppes as well as the others from the wet areas and old mesophilic and overflowed forests have formed some specific complexes. In the forms of Kozloduy Protected Area, Kozloduy Islands Protected Area and Zlatia Protected Area announced under the Habitat Directive a number of animal species is included and some of them could be found out in the region of the IP and its surrounding areas. The invertebrates in the region of the IP are represented not only by amphibian and aquatic species (some of them are riverside inhabitants) but also by some other typical water species. Hydrobiont fauna of the channels related to



the NPP cooling system is more or less the same like the one of the Danube River and rivers from this water catchment area.

In the forms of relatively closely situated Protected Areas there are two invertebrates species involved, which distribution is related to the river ecological systems and it is not expected they to be impacted by the IP. These two species are Depressed River Mussel (wrongly called - pearly mussel) and fore-operculum snail - stripped theodoxus. There are two terrestrial fauna species determined for the region of the Kozloduy Islands - Stag Beetle and Rosalia Longicom. These two species are inhabited in broad-leaved threes and the Stag Beetle prefers oak trees, but the Rosalia prefers elm tree, ash tree and some other riverside trees. Second species has been never determined by any experts in this region.

There is an interesting fauna in the region of IP consisting of some steppe species living in the wheat agrocenoses as well as in the steppe biota and overflowed forests. A lot of these fauna complexes became exotic and other ones are completely disappeared due to the changes occurred in their habitats or due to the physical destroying of their habitats.

Ichthyofauna in the region is specific and peculiar due to the vicinity of the Danube River to the region that is subject to IP. Danube River and its water catchment area are the only places where these species could be found. A lot of these species became exotic and that is why they are included in international documents aiming to protect their survival. For seven of the species included in the frame of the Natura Areas the water catchment area is a relict and endemic one. These species are Balkan Loach, Balkan Golden Loach, Mediterranean barbel and Danube streber, Balon's ruffle and Stripped ruffle as well as White-finned gudgeon, which are endemics of the Danube and its water catchment area.

According to the contemporary investigations the Spinned loach (*Cobitis taenia*) has never been discovered on the Balkan Peninsula. These species inhabit North Europe and in our latitudes there are another specific species that very long time have been wrongly considered as Spined Loach. Available species are also endemic for the Danube water catchment area and are called -*C. elongoides*.

IP specifics does not suppose any impact on the river and water territories so we do not consider need to analyze these part of the fauna.

Amphibians in the IP region are probably 9 - 10 species. Typical species for the IP region are both terrestrial amphibians such as Common spade footand Green Toad as well as "water" amphibians such as Danube Crested Newt, Fire-bellied toad and Green Lake Frogs. Rest frog species are more or less related to the aquatic and amphibian media or to the forest complexes as well. Such species are discovered in some territories comparatively close to the region. Due to the lack of forest territories it is senseless to analyze both species of caudata related to the aquatic areas or forest habitats. There are no such species close to the IP. The territory of the IP is of greatest importance for the Common spade foot, which populations are of relatively high density. There is a high number of this animal in natural and semi-natural habitats and his number in the agrocenoses is relatively high. These facts could be caused by many reasons but the most probable ones are the temporary status of the agrocenosis and

their plough out during the autumn and print season as well as the treatment of the agricultural crops with vegetation protection agents. Also, in the IP region there are Danube Crested Newt and Fire-bellied toad, which during the most part of the year live close to the water catchment areas (such artificial water source in the IP region is the artificial channel that could be a media for habitation of these animals).

Reptiles in the region have been never subject to special studies. Generally for the Danube valley three turtle species, five lizard species and seven snake species are typical. For the IP region only Balkan Wall Lizard and green lizards could be mentioned, which live everywhere as well as the European lizard, which could be found also in synanthropus landscapes. There are two reptile species mentioned in the area papers – European pond turtle and four-lined snake which has no habitats in the region of the IP. While the European Pond Turtle is registered in the region of the wet areas of the protected area, i.e. around the Rivers Tsibritsa, Ogosta and Danube the four-lined snake has been never registered in the region. Its closest plausible habitat is the town of Nikopol. For these species the IP is the western end border of the habitat. There are two species of grass-snake that could be registered in the IP region - Caspian whip snake and Aesculapian snake.

Mammalian fauna of the region has been never studied up to the moment. There are only some data about some big mammals that are subject of management and use. During the monitoring held in the region of the protected areas of Zlatia and Kozloduy ten species of small terrestrial mammals, three bats and six species of big animals were determined in the region of IP. Of the small terrestrial mammals the Romanian Hamster and the Black-bellied Hamster are subject to protection in the protected area and are included in the Habitat Directive. While the Romanian Hamster habits in the semi-natural and natural steppe communities the Black-bellied Hamster habits mostly in agrocenoses. Specimens of this animal have been established at several areas situated close to the IP region. These species are clearly related to the agrocenoses and probably the IP would not impact on its distribution and population condition. Rest complex of species includes both common species and some species or restricted habitation. House mouse and probably the European Hamster could be classified as such species.

Bat fauna has also not been investigated up to the moment. In the IP region there are three bat types but none of them is included in the Habitat Directive. According to the experts' consideration the reason for smaller number of individuals and the relatively small number of species is a result of the unfavorable microclimatic features (very often there is strong wind blowing) as well as due to the large areas occupied by agricultural crops. Entomofauna of the agricultural crops is poor and does not offer the needed set of nutritious resources needed for the normal existence of bats. Determined species are: Serotine bat *Eptesicus serotinus* (Schreber, 1774), Pipistrel *Pipistrellus pipistrellus* (Schreber, 1774), *Nathusius's* pipistrelle *Pipistrellus nathusii* (Keyserling et Blasius, 1839). There is more various bat fauna next to the riverside territories of Danube river but due to the big remoteness of the analyzed ground it will not be investigated.

Big mammalian in the region are represented by six species of predators and two species of cloven-footed animals. Abundance of rodents eating wheat crops is a

prerequisite for the high number of predators there. Most numerous predators are the jackals followed by the fox and badger. As per our investigations in the region of Zlatia and Kozloduy protected area some traces and faeces of a small polecat have been found, which is probably either marbled polecat or Siberian polecat. Both species are related to the columns of Romanian Hamster of European Hamster so we could assume that both species are habited there. IP specific will not have any impact affecting these animals. As species directly related to the waterside territories and water sources the Otter is also not a subject to the analysis.

The analysis performed for the specific fauna in the IP area indicates relatively little relation and correlation between the proposed IP and the objects subject to protection in the protected areas located nearby. Detailed specific protective measures as result from the analysis of the possible harmful impacts will be reviewed in the following chapters of the report.

According to the data provided in [37] concerning fauna on the concerned Romanian territory it can be summarized that the following plants and animals exist: herbaceous plants as graminaceae species; induce mammalian species as: ground squirrel, field mouse, rat, small preys: polecat, weasel and also big mammalian species as fox and hare.

The following bird species can be found here: quail, partridge, lark, and starling. The species bee eater and martin nestle live on clayey or sandy banks. Close to the rivers and meadows, in reed plots, one can find nests of wild ducks and geese or other birds which find their food in these wetlands like stork, common tern, whistler, diver and rarely, the egret.

In aquatic field we find fish species which lives in ponds at: Bistret, Cetate, Fantanele, Vartop, Cornu, Caraula and Preajba but also in natural lakes from Danube and Jiu meadow and even in small rivers.



## 3.5 Lands

### 3.5.1 Land use

Lands in 30-km area around KNPP are mostly agricultural ones (between 67 % and 94 %). Totally in the lands of all populated areas they are of 64472.47 ha (table 3.5.1.1). At the second place are the populated areas of 4435.87 ha. The lands of Kozloduy, Harlets and Miziya have the highest urbanization degree. Minor contribution comes from lands for forest industrial use, and there are none such lands in the areas of the villages Voivodovo, Kriva bara and Mihailovo. The forest territories are concentrated in the lands of Kozloduy and Miziya.

Watercourses and areas occupy a total of 2651.65 ha., and 1309.06 ha from them are located in the Kozloduy territory.

**Table 3.5.1-1 Balance of the lands by use**

Settlement	Agriculture		Forestry		Settlements		Watercourses area	
	ha	%	ha	%	ha	%	ha	%
v. Dolni Vadin	1432.65	77.88	100.81	5.48	63.44	3.45	237.9	12.9
v.Voyvodovo	686.32	89.82	0	0	68.39	8.95	3.19	0.4
v. Glozhene	4714.85	90.34	96.87	1.86	302.64	5.8	93.36	1.7
v. Harlets	3701.17	78.32	88.75	1.88	640.61	13.56	281.91	5.9
v.Butan	5882.4	92.87	4.62	0.08	378.04	5.97	63.55	
v. Kriva Bara	1442.9	92.71	0	0	86.65	5.57	25.21	1.6
t. Kzloduy	7840.29	73.57	815.29	7.65	656.18	6.16	1309.06	12.2
v. Lesskovetz	1196.24	67.29	214.9	12.09	92.47	5.2	266.02	14.9
t. Miziya	5533.74	86.21	326.05	5.08	364.09	5.67	5.23	0
v. Saraevo	322.23	83.88	14.34	3.73	30.19	7.86	10.34	2.6
v. Sofronievo	5115.12	90.11	171.19	3.02	287.79	5.07	85.41	1
v. Galovo	2479.84	94.65	24.56	0.94	105.17	4.01	2.96	0.1
v. Krushovitsa	4885.66	90.18	179.11	3.52	217.97	5.35	36.07	0.7
v. Lipnitsa	2334.8	89.76	80.04	3.08	138.66	5.33	31.51	1.2
v. Botevo	825.4	90.76	35.47	3.9	37.42	4.12	3.53	0.3
v. Hayredin	5333.89	91.39	195.18	3.34	262.71	4.05	32.48	0.5
v. Barzina	1496.12	90.04	42.98	2.59	80.45	4.84	34.31	2
v. Rogozen	3776.97	90.29	97.66	2.33	242.81	5.8	56.9	1.3
v. Mihailovo	32.98	92.16	0	0	232.35	6.49	34.35	0.9
v. Manastirishte	2473.71	90.5	65.17	2.38	147.84	5.41	38.36	1
<b>Total</b>	<b>64472.47</b>		<b>2552.99</b>		<b>4435.87</b>		<b>2651.65</b>	

Agricultural lands are occupied by fields and pastures. Fields occupy a larger area – 53150.21 ha, or between 46 % and 84 % from the agricultural lands in the territories of the separate settlements (table 3.5.1-2).

Pastures are concentrated in the territories of the villages Rogozen and Sofronievo, occupying respectively 10.9 % and 7.2 % of the agricultural lands. The pastures in Kozloduy territory are of lowest share – only 0.85 %.

Lands in the region are III, IV and V category. The area of IV category lands is 30682.89 ha, and of III category lands – 20 739.07 ha. Small areas – 5281.34 ha are occupied by the lands of V category (table 3.5.1-2). occupying 10.9 % and 7.2 % from

the agricultural lands, respectively.

**Table 3.5.1-2 Balance of the lands by way of permanent use**

Settlement	Permanent use				Land categories					
	Fields		Pastures		III		IV		V	
	ha	%	ha	%	ha	%	ha	%	ha	%
v. Dolni Vadin	1173.9	63.8	145.19	7.89	0	0	454.26	24.7	442.25	24
v. Voyvodovo	563.59	73.8	38.6	5.05	212.01	27.8	376.04	49.2	48.55	6.35
v. Glozhene	3790.5	72.6	130.02	2.49	526.1	10.1	3914.93	75	0	0
v. Harlets	3195.55	67.6	74.51	4.58	120.98	2.56	3093.68	65.5	97.84	2.07
v. Butan	5367.53	84.7	146.83	2.32	18.76	0.3	5629.42	68.9	17.27	0.27
v. Kriva Bara	1241.35	79.8	94.74	6.09	57.1	3.67	1214.41	78	118.02	7.58
t. Kzloduy	7316.79	68.7	90.46	0.85	2187.42	20.5	3751.48	35.2	1310.84	12.3
v. Lesskovetz	866.98	48.7	111.83	6.29	0	0	642.62	36.2	494.69	27.8
t. Miziya	4809.63	74.9	294.32	4.59	2127.45	33.1	2128.06	33.2	568.1	8.85
v. Saraevo	178.54	46.5	89.91	23.4	12.46	3.24	171.48	44.6	110.96	28.9
v. Sofronievo	4160.99	73.3	413.56	7.21	916.37	16.9	3229.99	56.9	684.57	12.1
v. Galovo	1974.36	75.4	275.33	10.5	1835	78	252.53	9.64	0	0
v. Krushovitsa	4050.82	79.7	210.35	4.14	0	0	2959.48	58.2	483.24	9.5
v. Lipnitsa	2019.69	77.6	175.29	6.47	214.1	8.23	1200.32	46.1	465.08	17.9
v. Botevo	746.39	82.1	74	1.07	455.82	50.1	220.78	24.3	81.22	8.93
v. Hayredin	4593.68	78.7	347.42	5.95	3527.26	60.4	1311.25	22.5	288.99	4.65
v. Barzina	1197.76	72.01	241.66	14.5	1563.16	94.1	0	0	0	0
v. Rogozen	2964.97	70.9	457.37	10.9	3940.89	94.2	0	0	0	0
v. Mihailovo	2937.19	82.1	245.73	6.87	3024.19	84.5	132.16	3.69	69.72	1.95
v. Manastirishte	1833.33	67.1	164.44	6.02	76.39	2.79	2139.37	78.3	9.91	0.36
Total	53150.21		3657.1		20739.07		30682.89		5281.34	

Fewest are the Land ownership is private, state private and state public, municipal private and public and land owned by legal entities. Private lands prevail – 46745 ha (table 3.5.1-3).

**Table 3.5.1-3 Balance of the lands by type of ownership**

Settlement	Type of ownership											
	Private		State private		State public		Municipal private		Municipal public		Legal persons	
	ha	%	ha	%	ha	%	ha	%	ha	%	ha	%
v. Dolni Vadin	950.13	51.7	100.49	5.46	275.46	14.97	19.83	1.08	162.1	8.81	183.51	9.98
v. Voyvodovo	413.2	54.1	17.79	2.33	3.42	0.45	143.5	18.78	14.99	1.96	55.42	7.25
v. Glozhene	3593.27	68.9	347.28	6.65	3.58	0.07	251.13	4.81	287.41	5.51	0.57	0.01
v. Harlets	2498.79	52.9	540.39	11.4	98.14	2.08	33.72	0.71	138.43	2.93	1052.5	22.27
v. Butan	4444.63	70.2	442.86	6.99	0	0	119.77	1.88	317.64	5.01	538.53	8.5
v. Kriva Bara	1032.21	66.4	44.12	2.83	5.96	0.38	55.91	3.59	48.57	3.12	192.83	12.39
t. Kzloduy	6385.14	59.9	1517.4	14.2	817.56	7.67	194.88	1.83	329.03	3.09	530.41	4.98
v. Lesskovetz	780.96	43.9	29.72	1.67	485.13	27.29	67.62	3.8	157.17	8.84	149.63	8.42
t. Miziya	3750.55	58.4	646.77	10.1	33.05	0.51	93.9	1.46	164.34	2.56	1171.8	18.26
v. Saraevo	98.76	25.7	30.61	7.97	2.44	0.63	4.31	1.12	11.28	2.94	85.78	22.33
v. Sofronievo	3592.67	63.3	189.73	3.34	50.21	0.88	340.76	6	140.25	2.47	439.28	7.74
v. Galovo	1936.46	73.9	54.42	2.08	5.13	0.2	14.26	0.54	315.83	12.05	63.99	2.44
v. Krushovitsa	2920.19	57.4	428.9	8.43	8.2	0.16	92.97	1.83	313.82	6.17	905.32	17.8
v. Lipnitsa	1921.18	74	158.67	6.1	7.61	0.29	87.78	3.37	240.57	9.25	5.55	0.21
v. Botevo	668.01	73.5	62.59	6.88	0	0	13.41	1.48	43.72	4.81	82.54	9.08
v. Hayredin	3884.05	66.6	137.5	2.36	8.39	0.14	342.83	5.87	511.1	8.76	688.42	11.8
v. Barzina	844.84	50.8	192.13	11.6	0	0	16.79	1.01	307.42	18.5	219.97	13.24
v. Rogozen	2771.57	66.3	179.91	4.3	0	0	178.67	4.27	561.3	13.42	226.98	5.43
v. Mihailovo	2395.87	67	78.6	2.2	0	0	114.66	3.2	301.21	8.42	450.67	12.59
v. Manastirishte	1862.96	68.2	160.01	5.85	3.79	0.14	40.76	1.49	249.55	9.13	249.46	9.13
<b>Total</b>	46745.44		5359.85		1808.07		2227.48		4615.73		7293.15	

### 3.5.2 Soils

Soils on the territory of KNPP are anthropogenic. They have arisen as a result of the violation of natural soils, following the earthworks during construction of the plant, ancillary buildings, structures, roads, communication and infrastructure links.

During construction of Kozloduy NPP the impact on soils has been mostly mechanical, disrupting the natural structure of the soil profile, so the modern taxonomic refer them to the anthropogenic soils. In the Blatoto area and on both parts of the drainage channel and collection channels some earth quantities are stored that are a result of the construction and cleaning of the channels. Thickness of the covering layer is 90-100 cm, which consists of different horizons and layers of carbonate black earth and alluvial-deluvial soils. A big part of KNPP area is occupied by "sealed" soils - that are soils, which are insulated due to the construction of buildings, facilities, channels, roads, parking areas etc. Their properties and characteristics are destroyed and the circular motion of the substances, water and energy in them is changed. The IP will be realized on already sealed soils.

PMF will be installed in the existing AB-2 building, in Room BK301 at elevation +6.30 m. Room BK039/3 at elevation 0.00 m will be also used, which is classified as Controlled area (CA). The facility will be serviced by the existing road network and infrastructure and does not require any further soil sealing.

As per the information by EIA of KNPP (1999), to the north from the power plant in Blatoto area are also over-wet and boggy soils available. Reasons for these degradation processes are natural and antropogenous. Depths of the groundwater, which are directly connected with the level of Danube River provide conditions for swamping. The lowest part of the Blatoto area is occupied by alluvial-deluvial alluviums of light mechanical composition (15-30 % physical clay). Thickness of the humus-accumulative horizon is 30-35 cm, humus content – 1.0 %, and the base saturation – 100 %.

Anthropogenic factors that impacted the area extension of overwet soils around the Blatoto area have been influenced by leakage of waters by the discharged system. This discharge of sewage waters was by the municipal sewage system of the KNPP and Kozloduy Town and water from the pig-breeding farm, construction sites etc. in the condition of high level of the waters at the lowest part of the overflowed terrace of the Danube River.

**Soils on the territory of KNPP and 30-km area around it**, situated on the territories of the municipalities of Kozloduy, Oryahovo, Hayredin and Miziya, are black-earths, alluvial, deluvial and gray forest soils.

Black-earths are the most distributed soils within 30-km area around KNPP. Most frequently the black-earth carbonate sandy-clayey, eroded black-earth carbonate and black-earth typical leached heavy sandy clayey are distributed.

Structure of the soil profile depends on the soil diversity. Much thicker are the meadow black-earths, medium leached heavy sandy-clayey black-earths (Sofronievo), leached black earths in the region of Krushovitsa etc. Eroded black-earths and carbonates where no transient horizon is constructed are of smaller thickness. Mostly,

the erosion has affected the black-earth on the inclined slope and mainly the ones next to Tsibritsa river on the western slopes of the table land. Part of this territory in the past was stepped leveled. In spite of that now we could see some traces of active area erosion.

Mechanical composition of the black-earths varies from slight sandy-clayey to heavy sandy-clayey. The only exclusion are the black-earths in the region of Miziya, which are mostly clayey-sandy ones. Availability of higher clay content in the soils is a sign of high adsorption capacity in regard to various pollutants, including  $^{90}\text{Sr}$  and  $^{137}\text{Cs}$ . With limited capabilities in this respect are the soils located in the lands of Kozloduy, G. Vadin, Manastirishte etc. Their large-particle composition is the result of deflation processes, characteristic for the area.

Humus content in the black-earths varies but it is not very high as a whole. In some sections with meadow or leached black-earths there are higher values such as 2.9 % (Sofronievo) 3.17 % (Mihailovo), 4.72 % (Selanovtsi), etc. Humus content is directly related to the pollution resistance of the soils, including the radioactive contamination. It is known that there is a strong accumulation of  $^{90}\text{Sr}$  and  $^{137}\text{Cs}$  in the surface horizons, which are rich of organic substance. Thus reduces the migration of the radioactive elements in other media too. The capabilities of some poor in humus the black-earths in the area - strongly and moderately eroded, are limited.

Active soil acidity fluctuates within the low alkaline spectrum 7.4-8.4, so that limits the uptake by plants of many elements, including radioactive. Rarely, some lower values exist - in the region of Krushovitsa, (pH=6.0), Manastirishte (pH=5.5) etc.

Overall black-earths can be assessed as resistant to soil contamination. One reason is the presence of the carbonate layers, which depending on the intensity of the leaching, are located at various depths in the soil profile. The areas poorer in carbonates are Krushovitsa, Sofronievo, Manastirishte etc.

Cushion capability of the black-earths is high. Their physical and chemical characteristics show that the cushion capability is mainly the dissolution of calcium carbonate and cushion capacity of such soils is high.

Black-earths are one of the most fertile soils in the country. Significant differences in nutrient content were detected only in medium and heavily eroded soils. Nitrogen content in the plough up area is from 0.200 % to 0.24 % and follows the humus allocation. C/N ratio is within 10-12.

Black-earths are of high percentage content of absorbable potassium, which explains their favorable potassium properties. Besides soil fertility, this element is also important for contamination with radioactive substances. It is known that the cesium assimilability is inversely proportional to the quantity of the exchanged potassium in the soil.

In the 30-km KNPP area Zlatiata table land shape is characterized by very strong wind erosion. Regarding the indicators of texture class and humus content that determine the erosion pliability of the soil, the carbonate black-earths there are evaluated with total mark of 6, and i.e. they are of high pliability to the wind erosion.

Covering of the soil with vegetation remain considerably impacts of the wind erosion in the region. Wheat, barley, sunflower and partially beetroot are the mostly grown

crops. They have very poor wind erosion protection during the early spring dry periods.

Resistance of the black-earths from 30-km area around the KNPP against organic and non-organic contamination is high. Their cushion capability is defined by the favorable reaction of the soil solution, high content of carbonates and heavy mechanical composition. Their resistance to radioactive contamination is defined by the favourable potassium properties.

Alluvial soils in the 30-km area around KNPP are located on the overflowed Danube terrace and islands in it. Their profile fluctuates very much depending of the thickness – from 44 cm in the land of Selanovtsi up to 207 cm in the land of Krushovitsa. Mechanical composition of the surface soil beds is too various. For example, in the land of Mihaylovo the alluvial soils are sandy-clayey with only 4.8 % mud and reaching 50 % in Krushovitsa region. PH of their soil solution varies within 6.0-8.1, i.e. they are medium acidity to light alkaline type. Fluctuation of the characteristics of the alluvial soils does not allow summarizing the assessments of their resistance against the anthropogenic impacts. As more resistant against the chemical impact are the ones with high pH, high content of clayey and carbonates from the regions of Krushovitsa, Selanovtsi, Miziya etc.

Alluvial-diluvial soils in the 30-km area around KNPP are located only in the lands of Rogozen and Selanovtsi. They are of 115-160 cm thickness, having weak alkaline reaction and medium sandy-clayey mechanical composition.

In some accumulative forms of the landscape also diluvial soils are formed. They are available in the lands of Harlets, Kozloduy and Selanovtsi. These ones from the Kozloduy region are of bigger thickness (140-160 cm). Deluvial soils are weak alkaline, containing carbonates. Their mechanical composition is light (clayey-sandy) for the profile from Harlets land and it is heavy (heavy sandy-clayey) for the profile of Selanovtsi.

Gray forest soils are present in the Rogosen land only. They represent the type of dark gray forest soils and are of medium thickness, medium acidity, heavy sandy-clayed, deep leached. Gray forest soils could be considered soils resistant against the chemical impact in the region.

### **Radioactive soil contamination**

According to the data of EIA of KNPP (1999) investigations of the soil pollution started in 1978, when some samples of the territory next to the power plant were tested as well as towards the wind torch.

Investigations are extended for the period 1982-1985. The quantities of the investigated radionuclides are shown in tables 3.5.2-1 and 3.5.2-2. Data analysis shows that after expiration of the Chernobyl contamination with short-lived radionuclides, <sup>137</sup>Cs and <sup>90</sup>Sr have been determined as main soil pollutants.

Table 3.5.2-3 shows data on the studies of the 30-km area around KNPP performed by the Research Institute of Soil Science and Agroecology (RISA) N. Pushkarov, (1994-1998).



**Table 3.5.2-1 Soils contamination by technogenic radionuclide – average values  
over the period 1980-1985**

No	Location	Depth (cm)	<sup>90</sup> Sr (Bq/kg)	<sup>137</sup> Cs (Bq/kg)
1.	Leskovets	0 – 5	2.2	21 ± 2 %
2.	Boteva aleya	0 – 5	5.0	23 ± 2 %
3.	Bazovets	0 – 5	2.7	14 ± 3 %
4.	Kozloduy, veterinary service	0 – 5	1.7	3 ± 10 %
5.	Glozhene	0 – 5	3.7	5 ± 7 %
6.	Butan	0 – 5	3.7	9 ± 5 %
7.	Sofronievo	0 – 5	2.8	12 ± 3 %

**Table 3.5.2-2 Technogenic radionuclides content in the superficial soil layer for locations within the region of KNPP in Bq/kg**

No	Location	1988					1989				
		<sup>90</sup> Sr	<sup>137</sup> Cs	<sup>134</sup> Cs	<sup>106</sup> Ru	<sup>125</sup> Sb	<sup>90</sup> Sr	<sup>137</sup> Cs	<sup>134</sup> Cs	<sup>106</sup> Ru	<sup>125</sup> Sb
1.	Biala Slatina	8.1	78 ± 3 %	9 ± 3 %	5 ± 25 %	3 ± 30 %	12.4	89 ± 4 %	17 ± 8 %	<1.1	<0.5
2.	Leskovets	8.8	120 ± 1 %	20 ± 6 %	13 ± 30 %	1 ± 30 %	3.6	53 ± 4 %	5 ± 6 %	<1.3	<0.7
3.	<b>Kozloduy-</b> Boteva aleya	12.8	48 ± 2 %	12 ± 7 %	7 ± 22 %	2 ± 30 %	5.5	78 ± 2 %	6 ± 9 %	<0.9	<0.6
4.	Sofronievo	3.2	38 ± 2 %	6 ± 6 %	<1.2	<0.4	4.1	52 ± 3 %	5 ± 13 %	<0.9	<0.4
5.	Bazovets	4.9	46 ± 2 %	2 ± 27 %	<1.9	<0.7	10.4	50 ± 2 %	4 ± 7 %	<1.2	<0.7
6.	Dolni Tsibar	3.5	63 ± 2 %	7 ± 10 %	<0.9	<0.6	5.8	82 ± 2 %	13 ± 11 %	<0.8	<0.5
7.	Oryahovo, poplar forest	-	56 ± 2 %	6 ± 10 %	<1.0	<0.7	5.5	39 ± 2 %	4 ± 11 %	<0.9	<0.6
8.	Kozloduy, acacia forest	-	26 ± 2 %	3 ± 26 %	<0.8	<0.7	4.8	51 ± 2 %	4 ± 10 %	<0.8	<0.4
9.	Kozloduy, veterinary service	-	66 ± 1 %	9 ± 10 %	<1.0	<0.5	3.6	34 ± 5 %	4 ± 25 %	<1.0	<0.6
10.	Glozhene	-	-	-	-	-	7.1	32 ± 2 %	4 ± 12 %	<0.8	<0.4
11.	Hayredin	-	-	-	-	-	6.3	60 ± 4 %	6 ± 14 %	<0.7	<0.7
Average for the region		6.6 ± 3.7	60 ± 26				5.7 ± 2.4	56 ± 18			
Average for Northern Bulgaria		5.5 ± 3.7	51 ± 32				5.0 ± 3.0	46 ± 28			

**Table 3.5.2-3 Technogenic radionuclides content in the superficial soil layer 0-5 cm within the region of KNPP in Bq/kg**

Location No	Laboratory	1994		1995		1996		1997		1998	
		<sup>137</sup> Cs	<sup>90</sup> Sr	<sup>137</sup> Cs	<sup>90</sup> Sr	<sup>137</sup> Cs	<sup>90</sup> Sr	<sup>137</sup> Cs	<sup>90</sup> Sr	<sup>137</sup> Cs	<sup>90</sup> Sr
1. Biala Slatina	RISA NCRBRP MEW	17 ± 2 %	6.3	15 ± 4 %	3.5	24 ± 5 %	3.0	7 ± 7 %	1.0		
2. Leskovets	RISA NCRBRP MEW	114 ± 2 %	11.6	101 ± 3 %	7.7	51 ± 4 % 23 ± 5 %	5.1 1.0	- 18 ± 6 %	- 1.5		
3. Boteva aleya	RISA NCRBRP MEW	46 ± 2 %	4.8	5 ± 10 %	2.1	63 ± 4 %	2.4	26 ± 3 %	4.2		
4. Sofronievo	RISA NCRBRP MEW	29 ± 4 %	3.7	22 ± 5 % - 15	4.6	11 ± 7 % - 13	1.2 - -	20 ± 4 % - 19	2.4 - -	- - 20	- - -
5. Bazovets	RISA NCRBRP MEW	45 ± 2 %	6.9	10 ± 10 % - 13	5.5	27 ± 4 % - -	4.1 - -	49 ± 2 % - 13	4.7 - -	- - 19	- - -
6. Dolni Tsibar	RISA NCRBRP MEW	34 ± 2 %	4.5	48 ± 2 % - 38	5.0	27 ± 5 % - -	2.4 - -	28 ± 3 % - 44	2.3 - -	- - 29	- - -
7. Oryahovo, poplar forest	RISA NCRBRP MEW	35 ± 2 %	9.2	27 ± 4 %	2.8	50 ± 5 % - 24	6.4 - -	11 ± 5 % - 18	1.3 - -	- - 18	- - -
8. Kozloduy, acacia forest	RISA NCRBRP MEW	27 ± 3 %	3.9	22 ± 5 %	6.4	35 ± 6 %	6.8	26 ± 3 %	4.8		
9. Kozloduy, veterinary serv.	RISA NCRBRP MEW	40 ± 4 %	4.0	45 ± 2 %	4.2	45 ± 4 %	8.3	2 ± 22 %	1.0		
10. Glozhene	RISA NCRBRP MEW	55 ± 2 %	4.0	62 ± 4 % - 40	5.3	79 ± 2 % 26 ± 4 % 16	1.8 0.2 -	33 ± 5 % 27 ± 4 % 23	3.7 0.7 -	- - 26	- - -
11. Hayredin	RISA NCRBRP	41 ± 3 %	13.9	20 ± 6 % -	2.0	19 ± 6 % -	2.8 -	26 ± 3 % -	1.4 -	- -	- -

Location No	Laboratory	1994		1995		1996		1997		1998	
		<sup>137</sup> Cs	<sup>90</sup> Sr	<sup>137</sup> Cs	<sup>90</sup> Sr	<sup>137</sup> Cs	<sup>90</sup> Sr	<sup>137</sup> Cs	<sup>90</sup> Sr	<sup>137</sup> Cs	<sup>90</sup> Sr
	MEW			26		17	-	29	-	23	-
12. Kozloduy, port	RISA	18 ± 2 %	4.1	12 ± 8 %	2.0	16 ± 6 %	2.5	13 ± 5 %	2.3	-	-
	NCRBRP			-		47 ± 5 %	0.5	65 ± 4 %	0.9	-	-
	MEW					12	-	11		14	-
13. Septemvriitsi	RISA	32 ± 4 %	3.7	36 ± 4 %	7.0	13 ± 8 %	1.0	16 ± 5 %	3.8	-	-
	NCRBRP			-				-	-	-	-
	MEW			13				16	-	26	-
14. Butan	RISA	22 ± 4 %	3.8	22 ± 7 %	4.0	16 ± 5 %	3.3	12 ± 6 %	3.3	-	-
	NCRBRP					38 ± 3 %	1.4	15 ± 8 %	0.7	-	-
	MEW					-				-	-
15. Krushovitsa	RISA	-	-	-	-	-	-	-	-	-	-
	NCRBRP			-		26 ± 5 %	1.5	24 ± 6 %	0.9	-	-
	MEW			12		12	-	15	-	15	-
16. Valchedrum	RISA	-	-	-	-	-	-	-	-	-	-
	NCRBRP			-		23 ± 4 %	1.4	14 ± 7 %	1.4	-	-
	MEW			12		-	-	13	-	24	-

Investigations within this period show increasing from 3 to 6 times of the concentrations of  $^{137}\text{Cs}$  and 2 times of  $^{90}\text{Sr}$ . Also, there are some quantities of  $^{106}\text{Ru}$ ,  $^{125}\text{Sb}$  and  $^{134}\text{Cs}$  recorded which before the Chernobyl accident and after 1990 are not found in soil samples.

Important conclusion made on the grounds of the conducted investigations is that the values of different radionuclides fluctuate too much; this is valid both for the KNPP territory and for the country territory. This practically makes difficult outlining the trends or making predictions. High uncertainty is illustrated by an experiment, indicating the content of  $^{137}\text{Cs}$  and  $^{90}\text{Sr}$  in 8 soil samples taken next to KNPP, from square area (side 20 m), at 10 m distance from one to another (table 3.5.2-4).

**Table 3.5.2-4 Content of  $^{137}\text{Cs}$  and  $^{90}\text{Sr}$  in soils next to KNPP**

Isotope	1	2	3	4	5	6	7	8
$^{137}\text{Cs}$	77	60	32	73	19	26	38	73
$^{90}\text{Sr}$	7.1	8.6	-	3.3	-	4.8	4.9	6.5

In depth of the soil profile the allocation of radionuclide is one and the same, regardless the pollution of the soil surface, showing the lack of migration processes.

The contamination of the soils in the KNPP area is monitored by a monitoring system and is published in the KNPP annual reports. The average annual value of  $^{90}\text{Sr}$  content in 36 monitored points in the 100-km area around the plant is 1.58 Bq/kg. According to these reports the  $^{90}\text{Sr}$  concentrations in different years were as follows:

- 1972-1974 -  $5.0 \pm 0.4$  Bq/kg
- 1995 from 0.39 Bq/kg to 3.08 Bq/kg,
- 1996 from 0.76 to 3.72 Bq/kg,
- 1998 from 0.19 Bq/kg to 3.46 Bq/kg.

Extreme values for  $^{90}\text{Sr}$  are determined in Berkovitzha – in 1995 – 9.2 Bq/kg and in 1996 – 4.08 Bq/kg.

Regarding  $^{137}\text{Cs}$  the concentrations were as follows:

- Year 1996 – from 3.1 Bq/kg to 84.6 Bq/kg;
- Year 1997 - from 3.3 Bq/kg to 84.6 Bq/kg;
- Year 1998 - from 2.28 Bq/kg to 103 Bq/kg.
- Year 1999 – an average of  $31 \pm 18$  Bq/kg

In some points the content of  $^{137}\text{Cs}$  was lower than the average one for the territory of NPP and the reason of that is the elimination of the surface soil layer during the construction and excavation to the surface of lower laying beds.

Content of  $^{134}\text{Cs}$  is several times lower than the one of  $^{137}\text{Cs}$ .

Content of  $^{60}\text{Co}$  is determined on the territory of KNPP in the soils in some of the monitored points, as well as in the slime of the KNPP channels. Radiation control data are shown in table 3.5.2-5.

**Table 3.5.2-5 Content of  $^{60}\text{Co}$  in the soils from the industrial site and within 500 m radius around KNPP (Bq/kg a.d.w)**

Point No	1995	1996	1997	1998
1	< 0.4 - 1.11	< 0.20	0.66 - 1.01	< 0.20
2	0.65 - 0.83	< 0.20 - 0.81	< 0.20 - 0.57	< 0.20
3	4.55 - 5.50	4.28 - 4.29	2.48 - 2.89	< 0.20 - 1.51
4	< 0.40	< 0.20	< 0.20 - 1.34	< 0.20
31	2.10 - 2.11	1.32 - 2.01	1.29 - 1.43	< 0.20 - 1.34
32	5.89 - 9.55	7.10 - 18.3	7.56 - 8.66	8.18 - 10.1
33	0.89 - 0.95	1.33 - 3.09	2.75 - 9.62	0.80 - 3.32
34	< 0.40 - 0.95	1.00 - 5.88	0.65 - 0.74	< 0.20
36	< 0.40 - 1.13	< 0.20	< 0.20	< 0.20 - 0.74

According to the data by RIEW Vratsa in the same period the contents of  $^{238}\text{U}$ ,  $^{226}\text{Ra}$ ,  $^{232}\text{Th}$ ,  $^{40}\text{K}$  and  $^{137}\text{Cs}$  were within the ranges of the expected background contents. In the bottom deposits from the dry channel, which in spite of the conducted re-cultivation are a potential source of the soil pollution, high values of content of  $^{137}\text{Cs}$  is detected– in some samples up to 15563 Bq/kg and 9954 Bq/kg, as well as considerable content of  $^{60}\text{Co}$ . High to average values are estimated for  $^{134}\text{Cs}$  and  $^{241}\text{Am}$ .

The collected data of  $^{137}\text{Cs}$  and  $^{90}\text{Sr}$  content in soils show that until 1986 their concentrations are impacted by the experiments with nuclear weapons during many years. After 1986 the radioactive pollution is increased as a result of the Chernobyl accident and within the period 1986-1990 new higher level was determined in 0-5 cm layer as well as penetration of  $^{137}\text{Cs}$  and  $^{90}\text{Sr}$  in the soil profile. As a whole the functioning of the power plant did not impact the soils' properties. Some local pollution has been determined and the respective measures have been undertaken.

KNPP annual reports for 2006, 2007 and 2008 include similar results for the  $^{90}\text{Sr}$  and  $^{137}\text{Cs}$  content in the soils of 36 monitored points in the 100-km area around NPP. The quantity of  $^{90}\text{Sr}$  is below the average for the country - 2-6 Bq/kg, and the average  $^{137}\text{Cs}$  content is 15.5 Bq/kg. In previous years the activity was considerably higher – up to 114 Bq/kg (in 1996). The investigations in 2008 also show lack of homogeneity in soil contamination, largely influenced by performed re-cultivation.  $^{134}\text{Cs}$  is not detected in the soil. Measured activities of radioactive cesium ( $^{134}\text{Cs}$  and  $^{137}\text{Cs}$ ) and their ratio show trans border transfer (resulting from nuclear tests and Chernobyl accident) in the 100-km area around the plant. Based on the 2008 monitoring of soil contamination, it was concluded that the radiological status of the soils in the area has not been influenced by KNPP activity. The summarized results from the analysis of the main pollutants for the plant area  $^{137}\text{Cs}$  and  $^{90}\text{Sr}$  in 2006, 2007 and 2008 are shown in table 3.5.2-6.

**Table 3.5.2-6 Content of  $^{137}\text{Cs}$  and  $^{90}\text{Sr}$  in soils (Bq/kg)**

Year	$^{137}\text{Cs}$ content		$^{90}\text{Sr}$ content	
	Average	Interval	Average	Interval
2006	16.9	1.96-62.03	2.55	1.40-6.51
2007	14.8	1.94-55.8	1.97	0.34-6.12
2008	15.5	1.53-48.5	1.12	0.37-3.51



Year	<sup>137</sup> Cs content		<sup>90</sup> Sr content	
	Average	Interval	Average	Interval
1972-1974			5.0±0.4	
Average background for Europe				2-6
KNPP 100-km area	25			

### Pollutants of the soils with nonorganic and organic pollutants

There are no major sources of organic and non-organic contamination near KNPP. Pollution sources for the soils from the territory of Kozloduy Municipality are a concrete factory, construction enterprise, asphalt facilities, motor transport and ceramic factory. Gas field and industrial enterprises in Miziya are located nearby, which due to the wind direction also could impact the soil condition (“Ecological model of Kozloduy Municipality”). Investigation in view of the above elaboration shows that the pollution with lead is available around the Villages of Glozhene, Harlets, Butan, river bed of Ogosta River and Southern border of Kozloduy Municipality. High values of lead, copper and zinc are established in the soils next to Glozhene MTS caused by the motor vehicles. In terms of organic pollutants, content of oil products in the soil has been investigated. Increased content of oils and oil products is observed mostly in the regions of the dumping-grounds, pump stations and agricultural yards. Recorded pollutions are not related to the operation of KNPP.

Investigation of the soil pollution with heavy metals are also made in connection with ”Mapping of general and movable forms of heavy metals and metalloids in the region of Vratsa” of the MAFI – Headquarters “Earth and land property” and of the MEW – Department “Soil resources, quality and evaluation”. In the regions of industrial activity there are some common and movable forms of copper, zinc, lead, cadmium and arsenic available. Agricultural lands polluted by industrial enterprises are located at a big distance from KNPP.

For the purposes of EIA of KNPP in 1999 a number of soil samples analyses have been performed, shown in table 3.5.2-7. Exceeding of PCL is assessed according to the effective in that time Ordinance No 3 on the Norms for permissible content of harmful substances in the soils (Prom. SG 36 of 8 May 1979, amended. SG 5 of 16 January 1996, supplemented in SG 54 of 8 July 1997, amended. SG 21 of 17 March 1997, amended. SG 39 of 16 April 2002). There are no exceeds regarding MPC detected. According to the updated Ordinance No. 3 on the Norms for permissible content of harmful substances in the soils (August 2008), results are assessed in the same manner – there are no exceedances, as this applies particularly to precautionary concentrations, maximum concentrations and intervention concentrations. Regarding the organic pollutants some leakages of the oil products have been detected - next to the black oil and lubrication facility on the territory of the EP-1 etc.

Table 3.5.2-8 presents data of the investigation of the soil pollutions with copper and lead in the land of Kozloduy Municipality which are also assessed pursuant to the old Ordinance. According to the updated Ordinance No 3 on the Norms for permissible content of harmful substances in the soils(12.08.2008), the same results are assessed

in a different manner. In the carbonate black-earth soils lead content is 3.3 times above MPC near the agricultural yard of Butan village and on its border with Kriva bara village. In the meadow black-earth the copper content slightly exceeds the limit near to the sheep farm of Butan village. In the alluvial and alluvial-meadow soils lead content is 2 to 2.3 times above MPC in MTS – Glozhene village and Zinc content – 1.9 times. Copper content is near the maximum limit. Obtained values are below the interference concentrations for heavy metals, i.e. below the level causing destruction of the soil functions and endangering the environment and human health. During the investigation single leakages of oil products have been detected.

**Table 3.5.2-7 Heavy metals and metalloids content in soil samples (mg/kg) within the 30-km area around KNPP**

Sample No	pH	Cu		Pb		Zn		Ni		Hg		As		Cd		Cr		Mn	Co	Fe	B
		Result.	MPC	Result.	MPC	Result.	MPC	Result.	MPC	Result.	MPC	Result.	MPC	Result.	MPC	Result.	MPC				
1	6.9	28.950	<260	20.408	<80	60.513	<340	27.765	70	-	-	-	-	traces	3.0	-	-	320.123	7.831	745.610	-
2*	7.2	21.244	<270	18.070	<80	32.695	<360	28.814	70	-	-	-	-	traces	3.0	-	-	293.270	6.837	760.402	-
4*	7.0	18.929	<260	23.481	<80	44.566	<340	32.107	70	-	-	-	-	traces	3.0	-	-	298.304	7.188	751.390	-
5*	7.0	20.747	<260	21.850	<80	37.080	<340	26.927	70	0.232	1	8.6	29-55	traces	3.0	-	-	278.317	7.504	689.503	-
6	7.0	17.705	<260	18.548	<80	30.773	<340	24.871	70	-	-	5.98	25	traces	3.0	23.3	200	265.366	6.323	660.990	36.7
7*	7.0	18.031	<260	21.930	<80	41.910	<340	26.072	70	-	-	-	-	traces	3.0	-	-	280.458	7.066	1561.89	35.6
8	7.0	18.689	<260	20.678	<80	32.607	<340	25.052	70	-	-	0.2	25	traces	3.0	-	-	259.066	7.158	624.304	-
9	6.8	35.413	<260	47.217	<80	57.515	<340	26.874	70	-	-	-	-	traces	3.0	-	-	322.986	8.037	787.121	39.5
10	7.3	20.583	<270	19.142	<80	36.226	<360	31.286	70	0.412	1	10.3	25	traces	3.0	-	-	279.722	8.645	645.892	-
11	7.5	22.533	<270	21.347	<80	39.611	<360	30.123	70	-	-	-	-	traces	3.0	34.0	200	312.381	8.776	744.307	52.0
12	7.3	17.735	<270	32.711	<80	53.992	<360	23.252	70	-	-	-	-	0.197	3.0	-	-	262.868	5.518	609.285	-
13	7.0	22.001	<260	22.719	<80	38.741	<340	28.219	70	-	-	-	-	traces	3.0	-	-	306.103	8.370	749.474	-
14	7.0	16.858	<260	21.639	<80	36.987	<340	22.142	70	-	-	-	-	traces	3.0	-	-	256.894	5.787	772.192	-
15	8.0	17.200	<280	10.500	<80	43.700	360	21.000	70	1.350	1	4.4	25	0.440	3.0	23.6	200	335.000	2.800	-	37.1
14'	-	-	-	-	-	-	-	-	-	1.040	1	-	-	-	-	-	-	-	-	-	-
15'	-	-	-	-	-	-	-	-	-	0.810	1	-	-	-	-	-	-	-	-	-	-
16	-	-	-	-	-	-	-	-	-	0.602	1	-	-	-	-	-	-	-	-	-	-
17	-	-	-	-	-	-	-	-	-	<0.050	1	-	-	-	-	-	-	-	-	-	-

**Table 3.5.2-8 Heavy metals content in the soils of Kozloduy agricultural lands (in reference to pH 7.5- 8.5)**

Element	Number of samples	Average [mg/kg]	Sample No	Amount [mg/kg]	MPC [mg/kg]	Content in times above MPC	Approximate location of the sample
<b>Black-earth carbonate heavy sandy-clayey</b>							
P <sub>B</sub>	123	51.77	41	114.0	above 80	1.43	Butan – next to sheep yard upstream the oil station
			61	398.3	“	4.98	Butan – next to the farmyard
			62	91.5	“	1.14	Butan – next to MTS, above the gas field
			63	251.8	“	3.15	Butan- below the gas field
			69	390.0	“	4.88	After the border with Kriva Bara village
Oils and oil products	29	180	62	51	300 with humus 1 %	below MDC	Butan – next to MTS, above the gas field
Oil products	“	131	“	37	300 with humus 1 %	below MDC	Butan – next to MTS, above the gas field
<b>Meadow black-earth carbonate medium sandy-clayey</b>							
P <sub>B</sub>	17	35.16	40	109.0	below 80	1.36	Kozloduy Farming complex
Cu	17	81.06	41	317.0	270-280	1.17-1.13	Butan – next to sheep yard upstream the oil station
Oils and oil products	3		2	140.0	300 with humus 1 %	below MDC	next to the floating pump station
Oil products	“		2	80.0	“	below MDC	next to the floating pump station
			40	680.0	“	2.27	Kozloduy Farming complex
			80	70.0	“	below MDC	Below the channel
<b>Alluvial and alluvial-meadow sandy and clayey-sandy</b>							
P <sub>B</sub>	29	64.57	18	275.0	below 80	3.44	Glozhene– next to MTS
			24	182.5	“	2.28	Ogosta River – under the bridge
			46	149.5	“	1.87	Harletz – next to dump area
			49	130.8	“	1.64	Butan– next to the gas field
			106	251.5	“	3.14	Glozhene – next to MTS
Cu	29	57.26	18	347.5	270-280	1.29-1.24	Glozhene– next to MTS
Zn	23	137.5	18	775.0	360-370	2.15-2.09	“

Element	Number of samples	Average [mg/kg]	Sample No	Amount [mg/kg]	MPC [mg/kg]	Content in times above MPC	Approximate location of the sample
Mn	23	889.6	24 57 106	3450.0 1012.0 3875.0	850 “ “	4.06 1.19 4.56	Ogosta River – under the bridge Glozhene – next to the dump area Butan– next to the gas field
As	5	197.0 “	24 106	- -	25 “	7.88 “	Ogosta River – under the bridge “
Oils and oil products	8	-	72	2060	300 with humus 1 %	6.87	Kriva Bara– next to dump area
Oil products	“	-	“	880	“	2.93	“

Results from an investigation by the Agency for soil resources (2010) for Copper and Zinc content in soils from the network for soil monitoring are shown in table 3.5.2-9. The points for soil monitoring are shown on fig. 3.5.2-1. Zinc content in the investigated points is even lower than the background concentration for soils in the country – 88°mg/kg. The received values for copper are higher than the preventive ones and at 2 points (No 29 and 30) they are close to the maximum permissible concentration for copper content in agricultural land – 300 mg/kg. The exceedance of this limit does not lead to a risk for the environment and people. The weak alkaline reaction of the soil dissolution is important condition for blocking the accessibility of metals for biological systems.

**Table 3.5.2-9 Copper and Zinc content of the soils in the 30-km area around KNPP (Agency on Soil Resources, 2010)**

Point No	Profile	pH		Cu (mg/kg)		Zn (mg/kg)	
		pH		Cu		Zn	
16	501	pH	7.8	Cu	295.0	Zn	53.0
17	502	pH	7.7	Cu	248.3	Zn	44.5
18	503	pH	7.7	Cu	186.5	Zn	70.0
19	514	pH	7.8	Cu	155.0	Zn	58.3
20	515	pH	7.8	Cu	183.5	Zn	69.0
21	504	pH	7.5	Cu	188.5	Zn	51.5
22	505	pH	7.9	Cu	113.0	Zn	58.0
23	506	pH	7.8	Cu	124.8	Zn	65.0
24	513	pH	7.8	Cu	289.8	Zn	68.0
25	516	pH	7.9	Cu	290.0	Zn	68.3
26	510	pH	7.9	Cu	297.5	Zn	62.5
27	512	pH	7.8	Cu	283.5	Zn	59.5
28	511	pH	7.7	Cu	256.3	Zn	60.5
29	507	pH	7.9	Cu	302.3	Zn	61.5
30	508	pH	7.8	Cu	307.5	Zn	62.8
31	509	pH	7.6	Cu	289.0	Zn	60.5
32	517	pH	7.9	Cu	193.5	Zn	72.5
33	522	pH	8.0	Cu	194.0	Zn	73.0
34	523	pH	8.0	Cu	234.0	Zn	64.0
35	527	pH	8.0	Cu	229.8	Zn	87.0
36	528	pH	7.9	Cu	238.0	Zn	62.5
37	529	pH	7.7	Cu	237.3	Zn	61.5
38	530	pH	7.7	Cu	124.8	Zn	67.5
39	531	pH	7.8	Cu	198.5	Zn	75.0
40	533	pH	7.9	Cu	76.8	Zn	52.5
41	532	pH	7.7	Cu	207.8	Zn	56.8
42	534	pH	7.7	Cu	148.5	Zn	70.3
43	535	pH	8.0	Cu	228.0	Zn	86.0
44	536	pH	7.9	Cu	238.3	Zn	76.0
45	537	pH	8.0	Cu	167.5	Zn	63.5
46	538	pH	7.8	Cu	124.8	Zn	59.0



Point No	Profile	pH		Cu (mg/kg)		Zn (mg/kg)	
47	539	pH	7.9	Cu	85.8	Zn	81.3
48	518	pH	7.8	Cu	278.5	Zn	58.5
49	519	pH	7.9	Cu	225.0	Zn	61.5
50	520	pH	7.9	Cu	210.5	Zn	57.5
51	521	pH	7.9	Cu	245.0	Zn	60.3
52	524	pH	8.0	Cu	238.8	Zn	59.0
53	525	pH	7.9	Cu	217.8	Zn	59.5
54	526	pH	7.9	Cu	220.0	Zn	83.3



**Fig. 3.5.2-1 Soil contamination monitoring network (Soils resources Agency, 2010)**

**Legend:**

Разпределение на почвени профили и мрежа на почвено замърсяване на територията на общини Козлодуй, Оряхово, Хайредин и Мизия -  
Repartition of soil profiles and soil contamination monitoring network on the territory of the municipalities Kozloduy, Oryahovo, Hayredin and Miziya.

Мрежа за почвено замърсяване - Soil contamination network

Почвени профили – Soil profile

Областна граница – District border

Общинска граница – Municipality border

Землищна граница – Settlement lands border

In the 30-kilometer area around the KNPP including the territories south of Dolj up to Danube River, Romanatilor district, plane Bailesti plain, the rivers Jiu, Jiet and their inflows, with an area of 133035 ha. This area is dominated by agricultural land with total area of 106976 ha. Settlements occupy 7225 ha.

Detailed information about the land has been provided by Romania on the districts Dolj, Gorj, Mehedini, Olt, Teleorman and Valcea (table 3.5.2-10).

**Table 3.5.2-10 Land use in the Romanian territory, within a 30-km zone around the KNPP**

District	Farmlands	Built-up areas	Forests, coastal lands, sands	Lakes, rivers	Swamps
DOLJ	563178.78	48720.69	94832.91	13193.50	19885.55
GORJ	10328.13	1706.40	7701.76	340.18	572.47
MEHEDINI	114257.11	7653.91	23048.81	1625.75	2168.38
OLT	332219.23	29438.10	37205.86	8931.71	734.03
TELEORMAN	83528.41	5312.30	7779.09	1655.12	96.57
VALCEA	20439.09	2378.91	13175.43	463.81	17.55

The data in the table above shows that all these areas are dominated by farmland - about 77 % of the area. What is cultivated here are: annual crops, orchards and berries. Also, areas with significant participation of natural vegetation, non-irrigated farmland, rice paddies, grasslands and vineyards can be found. Forests, coastal lands and sands hold an average of 12 %, built-up areas – 6 %, etc. Data are presented by Romania on the radioecological status of uncultivated and cultivated soils - tables 3.5.2-11, 3.5.2-12 and 3.5.2-13.

**Table 3.5.2-11 Specific activity of radionuclides by gamma-spectrometric analysis of soil samples from uncultivated land (Bq/kg)**

Location	Year	<sup>40</sup> K	<sup>235</sup> U	<sup>228</sup> Ac	<sup>210</sup> Pb	<sup>137</sup> Cs
Bechet	2007	537.400	0.900	25.600	18.200	7.870
	2008	392.400	2.505	20.240	41.050	13.200
	2009	459.365	2.670	24.250	35.465	9.885
	2010	454.300	2.480	25.400	31.450	4.840
Craiova	2007	800.000	3.580	25.900	43.100	3.100
	2008	453.000	3.110	27.300	52.100	13.100
	2009	487.700	3.120	28.900	61.010	15.960
	2010	488.400	3.510	29.200	56.300	17.300
Drobeta-Turnu Severin	2007	832.600	2.620	21.300	46.300	18.000
	2008	469.500	3.790	35.200	46.600	51.800
	2009	436.000	4.060	36.100	54.700	11.780
Zimnicea	2007	648.600	0.750	6.450	30.900	5.900
	2008	541.300	1.640	38.100	42.900	9.420
	2009	488.600	3.090	26.200	46.500	9.560
	2010	533.450	4.730	38.140	75.150	5.730

**Table 3.5.2-12 Specific activity of radionuclides by gamma-spectrometric analysis of soil samples from uncultivated lands in the region of Bechet and Nedeia (Bq/kg)**

Year	Sampling location	<sup>40</sup> K	<sup>235</sup> U	<sup>228</sup> Ac	<sup>210</sup> Pb	<sup>137</sup> Cs
2007	Dabuleni	512.700	<LD*	12.600	19.650	14.755
	Nedeia	435.200	<LD*	19.500	35.330	11.200
	Ostroveni	453.450	1.450	19.050	31.150	15.200
2008	Dabuleni	472.850	3.085	28.400	30.800	13.075
	Nedeia	361.850	<LD*	24.300	39.200	37.350
	Ostroveni	455.050	2.105	26.550	35.700	15.650
2009	Dabuleni	407.140	1.490	11.265	27.000	11.135
	Nedeia	277.100	2.785	18.345	34.115	4.855
	Ostroveni	546.085	1.82	21.635	40.100	24.660
2010	Dabuleni	450.500	1.455	13.600	21.150	17.700
	Nedeia	360.400	3.145	27.750	42.350	6.840
	Ostroveni	418.250	1.810	17.150	34.900	14.550

\*LD – limit of detection.

**Table 3.5.2-13 Specific activity of radionuclides by gamma-spectrometric analysis of soil samples from arable land in the region of Bechet, (Bq/kg)**

Year	Sampling location	<sup>40</sup> K	<sup>235</sup> U	<sup>228</sup> Ac	<sup>210</sup> Pb	<sup>137</sup> Cs
2007	Dabuleni	485.75	1.045	17	24.1	14.38
	Ostroveni	509.40	1.555	21.1	31	16.000
2008	Dabuleni	428.80	1.450	16.650	30.550	12.765
	Ostroveni	462.75	1.820	25.750	36.400	4.225
2009	Dabuleni	391.95	1.790	15.660	29.230	13.165
	Ostroveni	446.00	2.605	19.700	35.800	10.065
2010	Dabuleni	464.95	1.690	16.600	26.400	8.730
	Ostroveni	425.65	2.980	19.050	29.750	7.855

Found concentrations in soils from the above areas of Romanian territory are within the natural background. The most important pollutants in the region of Kozloduy are <sup>90</sup>Sr and <sup>137</sup>Cs. The results of analysis of soil pollution in the region of Kozloduy show that the concentrations are lower than in other regions in Bulgaria and that radioecological status of soils is not influenced by plant operation. In the presented materials from Romania only data for <sup>137</sup>Cs in cultivated and uncultivated soils are given. These values are not higher than those found in the area of KNPP.

It can be concluded that the IP will be implemented in an existing KNPP building, meaning that already sealed soils will be used. PMF will be serviced by the existing road network and infrastructure and does not require further sealing of soils. No use of additional land or changes in the land use is required.

Lands in 30-km area around KNPP are mostly agricultural ones. All lands in populated areas are 64472 ha. Land categories are mostly IV and III. The area of the IV category lands is 30682 ha, and of the III category – 20739 ha. Private lands prevail – 46745 ha.

The soils on the KNPP site are anthropogenic. They have occurred as result of the construction activities during the power plant construction and the relating buildings, facilities roads, communication and infrastructure connections. Soils are mechanically deteriorated by construction works causing also deterioration of the soil profile structure.

Soils on the territory of KNPP and 30-km area around it are black-earth, alluvial, diluvial and gray forest soils. Black-earths are the most distributed soils within 30-km area. They include black-earth carbonate sandy-clayey, black-earth typical sandy clayey, eroded black-earth carbonate and typical and black-earth leached heavy sandy-clayey.

Resistance of the black-earths from 30-km area around the KNPP against organic and non-organic contamination is high. Their cushion capability is determined by the favorable properties of the soil solution, high content of carbonates and heavy metal composition.

The favorable potassium properties enhance the resistance to radioactive contamination. The grey forest soils are also very resistant to contamination.

The analysis of the soils' pollution in the region of KNPP until 1999 shows that any contribution of the power plant to the contents of  $^{137}\text{Cs}$  and  $^{90}\text{Sr}$  in the soils is not possible to be proved. Until 1986 it is considered that their concentrations are impacted by the experiments with nuclear weapons during many years. After 1986 the radioactive pollution is increased as a result of the Chernobyl NPP accident and within the period 1986-1990 new higher level was determined in 0-5 cm layer as well as penetration of  $^{137}\text{Cs}$  and  $^{90}\text{Sr}$  in the soil profile. As a whole the functioning of the power plant did not impact the soils' properties. Some local pollution has been determined and the respective measures have been undertaken.

Monitoring of the pollution of the soils in 2006, 2007 and 2008 shows that the most important pollutants are  $^{90}\text{Sr}$  and  $^{137}\text{Cs}$  and their concentrations are lower than in other regions in the country, which is a sign that the radioecological status of the soils has not been impacted by the operation of the power plant.

Soils in the 30-km zone around KNPP contain radionuclides within the natural background, which indicates that soils on Romanian territory within the above area are not affected by the operation of the plant.



### 3.6 Landscape

The Plasma melting facility (PMF) is located in an existing KNPP building. Territory of KNPP covers the strip of land from the Danube River side low lands and the territory of 30-km area around the power plant is involved in the West subarea of the Danube valley that is a part of the Miziya area.

According to the **regional landscape detachment** of Bulgaria (1997) the territory of PMF building is situated in:

A. North Bulgarian Landscape zonal **area**

I. North Danube valley landscape **subarea**

4. Zlatia landscape **region**

5. Dolnoiskurski landscape **region**

II. South Danube Landscape **subarea**

13. Lyutensko-Borovanski landscape **region**

Specified characters and number indexes mark landscape area, subarea and regions and they comply with the regional landscape zoning of the country. The 30-km area around KNPP includes the following territories:

- Kozloduy Municipality and the Eastern part of Lom- they occupy a part of the Zlatia landscape region (4);
- Municipality of Vulchedrum, Hayredin and Miziya – in Zlatyiski (4) and Lyutensko-Borovanski (13) landscape regions;
- Oryahovo Municipality – in the Dolnoiskurski Landscape Region (5);
- The parts of Byala Slatina, Borovan and Boytchinovtsi municipalities included in the 30-km area of KNPP - in the Lyutensko-Borovanski landscape region (13).

According to the **typological landscape region** detachment of Bulgaria (1997) the site falls within the following landscape structures:

1. Class	Plain landscapes
1.1 Type	Landscapes of moderate continental meadow-steppe and forest low lands
1.1.1. Subtype	Landscapes of meadow-steppe low lands
1.1.1.1. Group	Landscapes of meadow-steppe alluvial low lands of medium degree for agricultural utilization
1.1.2. Subtype	Landscapes of meadow-marsh low lands
1.1.2.2. Group	Landscapes of meadow-marsh alluvial low lands of comparatively low degree of agricultural utilization
1.1.3. Subtype	Landscapes of forest low lands
1.1.3.3. Group	Landscape of forest low lands on the river islands
1.1.3.4. Group	Landscape of the forest low lands on the uplands on the overflown

	terrace of small extent of agricultural utilization
1.2. Type	Landscape of moderate-continental steppe, meadow-steppe and forest-steppe valleys
1.2.5. Subtype	Landscape of the black-earth meadow-steppe valleys
1.2.5.7. Group	Landscape of the black-earth meadow-steppe valleys of loess rocks of high extent of agricultural utilization
1.2.5.8. Group	Landscape of black-earth meadow-steppe valleys of carbonate rocks of medium extent of agricultural utilization
1.2.6. Subtype	Landscape of loess-steppe valleys
1.2.6.9. Group	Landscape of the loess-steppe valleys of loess rocks of high extent of agricultural utilization
1.2.6.10. Group	Landscape of the loess-steppe valleys of limestone rocks of medium extent of agricultural utilization

The numerical indexes of the landscape taxonomic classes should comply with the “Typological landscape region zoning” of the country and reflect the landscape of the examined territory.

The scale of elaboration of the regional and typological landscape region zoning of the country is 1: 400 000 and does not allow detailed characterization of the landscape of the examined territory to be made. Accuracy when determining the belonging of certain landscape of the above schemes to the respective class does not fully comply with the purposes of a small territory like the one of the PMF. Therefore, a more detailed system should be applied for the landscape classification at a lower taxonomic level – by type of the ground covering according to the concrete location of the site of KNPP and 30-km area around it.

### **Landscapes on KNPP territory**

#### ***Anthropogenic landscape***

The PMF is located in a building on KNPP territory. The site of the KNPP itself is “anthropogenic” landscape. Some of its varieties located on the site territory of KNPP are as follows:

- Landscape “anthropogenic industrial” – it is created by the constructed buildings of Units 1, 2, 3 and 4 of KNPP (EP-1) and Units 5 and 6, administrative buildings, electrical and other auxiliary facilities and parking areas (fig. 3.6-1). The appearance of the landscape is dominated by man-made elements.



**Fig. 3.6-1 Landscape “anthropogenic industrial” - part**

- Landscape “anthropogenic communication”. Its structure includes all road communications of the territory of KNPP as well as the existing High Voltage lines (fig. 3.6-2.).



**Fig. 3.6-2 Landscape “anthropogenic communication” – part**

Anthropogenic landscapes from the territory of KNPP are of poor weather resistance. It is a result of the lack of possibility for self regulation as well as their existence completely depends on the anthropogenic activity. Furthermore, they are not capable of self-restoration. The sustainable components in them are the ground base, topography and climate. The condition of the landscape is stable at the moment, but is generally reversible. Possible options include removal of buildings, facilities, etc., recultivation and

restoration of the natural landscape.

### ***Forest landscape***

For the purposes of grassing and improvement of the environment some plants are planted involving wood and shrubby types (fig. 3.6-3). Territory of this landscape is not a compact one. It is broken by communication connections, buildings, outdoor areas etc. Plantations include various tree and shrub species. The landscape is established to have environmental forming functions and to improve the visual acceptance of the "anthropogenic" landscape. It has a beneficial effect on the microclimate, the air dust load, and the territories around it and is used for recreation etc. Landscape allows self-regulation and due to that feature it could be determined as comparatively stable.



**Fig. 3.6-3 Forest landscape – part**

### ***Aquatic landscape***

It is represented by the cold and hot channels to the power plant. It occupies a comparatively big area that provides grounds for an independent landscape. That landscape is unstable on the time point of view and its existence completely depends on the anthropogenic activity.

The aquatic landscape is a unit where water bodies have been designed for the purposes of KNPP industrial activity (fig. 3.6-4). It is represented mainly by the cold and hot channels to the power plant.



**Fig. 3.6-4 Aquatic landscape**

That landscape is unstable on the time point of view and its existence completely depends on the anthropogenic activity.

### **Landscapes within the 30-km area around KNPP**

Within the territory of 30 km area around KNPP the following **landscape types** are also available:

#### ***Agricultural landscape***

These are prevailing species of landscape for the region. They are situated on 64472 ha approximately. Most widely distributed landscape is the "agricultural crop rotation" one, which occupies an area of approximately 53150 ha. This landscape includes rotation crops and it changes its visual appearance according to the seasonal dynamics. "Agricultural landscape of perennial plants" is also present, but it occupies a smaller territory.

Agricultural landscapes in the region are very much negatively influenced by the anthropogenic activity. A big part of them are deserted agricultural lands. Landscape stability of the agricultural landscapes is not high. Vegetation component of them is very sensitive, because its existence depends on the anthropogenic activity. Relief, climate, geological foundation and soil could be specified as sustainable components of agricultural landscapes.

The horizontal structure of these landscapes is broken very much by other landscape types - anthropogenic, aquatic, forest ones. Their vertical structure includes the soil-forming loess rock, which is a high carbonate rock that plays considerable role in the cycle of a number of substances, including pollutants. High carbonate content is an effective migration barrier to the polluting substances, including radionuclides.



### ***Forest landscape***

It is represented by the territories of the forest fund of Kozloduy Municipality, southern part of Lom, Municipalities of Vulchedrum, Hyredin, Miziya, Oryahovo as well as the parts involved in 30-km KNPP Area of the municipalities of Byala Slatina, Borovan and Boitchinovtsi. Its approximate area is 2552 ha. The territory of its horizontal structure is broken by agricultural lands, settlements and others. The forest landscape occupies the river bank territories and hilly slopes. The loess nature of the rocks involved in the black-earths formations is very important. They are the main soil type within 30-km area around KNPP and are important component for formation of the landscape structure, i.e. soil. As a structure forming component there is a number of wood species involved in the vegetation cover, which also form the visual view of the landscape. Alongside the banks there are different species of wills and poplars available. On the hilly slopes there are tiller plants of downy oak, Turkey oak and Italian oak, involving common elm tree, lime-tree etc. At some places there are some cultures of white acacia. Also, there are pure and mixed cultures of black pine. Alongside the Danube river there are some belts of poplar cultures that occupy the main part of the islands. Amphora trees are the most widely distributed shrubby species.

Stability of the forest landscape is determined as high due to its capability for self-regulation and self-restoration.

### ***Meadow landscape***

Meadow landscape is not typical for the region. In the micro low lands of the river overflowed terraces and some parts around the marsh lands the "meadow marsh" landscape is present. The most compact area is located in th Blatoto area, on the flooded terrace of the Danube river located north from the power plant.

### ***Aquatic landscape***

Aquatic landscapes occupy an area of approximately 2651 ha and have a broken horizontal structure.

"Aquatic river" landscape is represented by the water catchment areas of the Danube, Skut, Ogosta and Tsibritsa rivers with their smaller tributaries, as well as the more remote water bodies of the Iskur and Lom rivers.

"Aquatic lake" landscape includes about 15 water sources and micro-dams (within the 30-km area) and the main channels of the irrigation system, some of which have been abandoned.

"Aquatic marsh" landscape involves marshlands and protected territories – the marshland on the island, the "Ibisha" reserve in the land of the village of Dolni Tsibar, the Ostrovsko marshland located at 28 km east of the power plant.

### ***Anthropogenic landscape***

Anthropogenic landscapes are of about 4435 ha total area and are represented by the



following varieties:

- "Anthropogenic settlement" landscape – consists of the populated areas within the settlement regulation. Their total number within 30-km area is 29 villages and four towns.
- "Anthropogenic communication" landscape includes the main transport connections of all road categories and the power lines. The total length of the road infrastructure in the region is about 500 km.
- "Anthropogenic industrial" landscape consists of larger industrial enterprises to the populated areas that are currently closed down and deserted. Also, there are some farm buildings, destroyed farms, deserted construction areas, storage facilities, quarries and lands backfilled with waste. The existing industrial areas consist mostly of small enterprises in the service sector, small construction companies, storage facilities etc.

Anthropogenic landscapes are influenced in different extend by the human activity. Most of them are only anthropogenized. Some of their components, mostly vegetation and soils, are affected. Caused changes are time-reversible and depend on the intensity of anthropogenic activity.

**In conclusion**, the landscapes on KNPP territory are "anthropogenic", "forest" and "aquatic". Anthropogenic and aquatic landscapes have low stability and their existence is determined by human activity. The forest landscape has capabilities for self-regulation and self-restoration, and is considered stable. The IP will be implemented on the territory of anthropogenic landscape, which is characterized by buildings and facilities from the KNPP site. The PMF will be installed in an existing building; therefore the implementation of the IP does not require further use of soils and breaking of landscape components – geological foundation, soils, vegetation. Within the 30-km area around KNPP site the landscape variety is bigger – the "forest", "meadow", "agricultural", "aquatic" and "anthropogenic" landscapes can be found. The forest and aquatic landscapes are characterized as very stable. The loess-type soil forming materials play an important role for the circulation of substances in the landscapes. Due to their carbonate composition, they provide migration barriers for different pollutants, including radionuclides.

### **Landscape in the Romanian part of the 30-km area around KNPP**

The types of landscapes as described in item 3 of the above conclusions are as well situated in the Romanian part of the 30-km area.

This area is situated in the south of the county of Dolj, between the Danube River, Romantilor and Bailesti plains.

The aquatic landscape of this territory is determined by the crossing rivers Danube, Jiu, Jiet (Old Jiu), their tributaries Baboia, Balasan and Giorocel, the two important lakes Calugareni Lake and Bistret Lake and numerous ponds and lakes of the meadow. The

total area covered by water is about 10012 ha. Land cover comprises mostly agricultural landscape, an area of 106976 ha and forest landscape with areas of different categories such as woods, scrubs and briers, protection curtains, forest nurseries, etc with total area of 9328 ha. The share of anthropogenic landscape is of main lower importance than in the Bulgarian part. The whole landscape can be characterized as an area of meadow and plain.

### 3.7 Climate and meteorological conditions

According to the climatic zoning of the country, the investigated site is part of the Northern Climatic Region of the Danube hilly valley of the Moderate-continental subarea of the European-continental area. Thermal conditions are of well-expressed seasonality, due to the differences of the solar radiation balance in the winter and summer periods, which outlines the continental nature of the climate. This seasonality is also enhanced by the circulation conditions.

The weather type in winter is determined by the continental air masses of the moderate latitudes. These masses are pushed in mostly in the back of the Mediterranean cyclones passing towards the east and northeast. Rarely, some continental air masses of transformed arctic air from the northeast reach the area, causing sharp fall of the temperatures. Warm subtropical masses are pushed in upon passing of cyclones from the area of the Genoa gulf and south and south-west winds blow. These circulation conditions, as well as the negative radiation balance, determine the general winter picture. January is the coldest month with average air temperatures of minus 2.1°C. Values of the minimal temperatures are negative from December to March. In 80 % of all cases the absolute minimal temperatures in January are about -10.0°C. Number of the days with negative minimal temperatures above -10.0°C in January is 24 days on average and the number of days with minimal temperatures below -10.0°C is about 6 days. When the cold air is pushed in from the north and north-east the temperatures sharply go down and the minimal air temperatures reach -29.9°C. These cold temperatures are accompanied with frequent winds from the northwest. Winter rainfalls in the investigated territory are about 120 mm per winter. In spite of the cold winter the snow coating is unstable and stays only in certain time periods; most often it starts to form in early December. Last snow coating is formed in the beginning of March.

In the beginning of *spring* and mainly in March the circulation conditions in the region are like the winter ones. However, in compliance with the growth of the day and sun height, the radiation balance is increased. Heat conditions in spring are formed due to the impact of two main factors, i.e. more frequent transfer of hot air masses from the smaller geographic latitudes, as well as reduction of the total cloudiness and increasing of the duration of the sun shining. Spring in the area comes comparatively early. Average April temperature fluctuates around 12.6°C. In this season the frontal area of the moderate latitudes is displaced more to the north, which causes alternation of fast and frequent warming and cooling down. Cloudiness is substantial, especially in the second half of the spring, which is related to the Atlantic cyclones, prevailing in this period of the year, causing increase in rainfall. The amount of rainfalls during this season is greater than in winter at around 160 mm.

In the *summer* the heat conditions are formed as a result of the conversion of the Atlantic air masses into warm continental masses. This process is caused by the impact of the Azores anticyclone and by the considerable inflow of the solar radiation, which contributes for the cloudless and dry summer. Average July temperatures for the region

are 23.4°C. During the great summer heats, which are mostly related to the local air overheating and in the anticyclone conditions, the maximal temperatures in the region are about 26.0 - 27.0°C, and the absolute temperature maximums are up to 39.0 - 42.0°C.

Usually, such values are considered upon diluted anticyclone conditions with its typical small gradients, minor cloudiness or cloudless sky.

In the summer months 80 % of the days are with maximum temperatures above 30°C.

Temperature decreases during this season are mainly caused by the pushing in of colder Atlantic air. These cooling-downs are quite short due to the increased conversion of the air masses into continental ones. With such processes the weather could stay cloudy for 2-3 days with frequent rainfalls and drop down of the temperatures to 14.0 – 15.0°C.

Summer rainfall quantity is about 170 mm, and the annual maximum occurs in June (72 mm).

In the autumn the total increase of the air temperatures is a result of the reduction of the radiation balance on one hand and, on the other hand, of the gradual restructuring of the atmosphere circulation. Considerable increase of the meridional circulation is faced when the pushing in from the north and northeast is more frequent. In October the average air temperature in the region is 12.2°C. Rainfalls during the autumn are within 130-140 mm.

Annual development of the wind velocity in the investigated region has a clear maximum in the period of January-April and minimum in the months of September-November. In the investigated territory the prevailing winds are of north-west-west direction, followed by the northeast-east directions. The strongest winds flow from northwest with average velocity of about 6.0 m/s.

In certain years the meteorological conditions strongly fluctuate around the climate value, which is considerably determined also by the microclimatic features of the ground. For the purposes of investigation of the meteorological conditions in the area of Kozloduy, the change of the measured values of the meteorological elements for the period 2006 – 2008, received from the automatic station installed in the area, is examined. In order to monitor the wind characteristics, data from three points in the region of KNPP are provided.

Heat conditions in the area of KNPP during the examined period from 2006 to 2008 inclusive strongly fluctuate around the climate values. Year 2007 is the warmest (fig. 3.7.1). Average annual temperature reached 12.9°C, and the January and February temperatures were respectively by 7.0 and 4.0°C higher than the climatic norms. Temperatures in the summer were comparatively higher (average July temperature was 3.4°C above the norm).

Year 2006 was colder (average annual temperature of 12.2°C), especially during the colder part of the year, and during the warmer months the temperatures were around or above the climatic values. Values of the air temperatures closest to the climatic norms are recorded in 2008, except the lower January temperatures (1.3°C below the norm) and

higher February and March temperatures that were respectively with 2.4 and 3.8°C above the norm. Absolute minimums of the air temperature vary from minus 13.6°C (23.12.2007) to minus 22.1°C (05.01.2008), and the absolute maximums in the site area have reached 38.0°C (20.08.2006) - 44.1°C (24.07.2007).

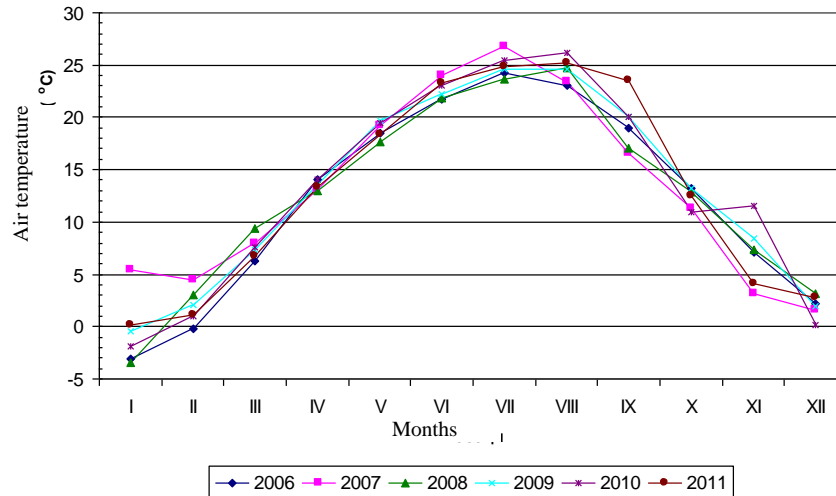

**Fig. 3.7-1 Allocation of the average monthly air temperatures in the region of KNPP within 2006 – 2011**

Rainfall during the period 2006-2008 strongly fluctuates. 2006 was the driest year (with annual rainfall of 323 mm), and 2007 (annual amount of 518.8 mm, close to the norm) - the wettest year. Internal annual allocation of the monthly rainfalls is shown on fig. 3.7-2.

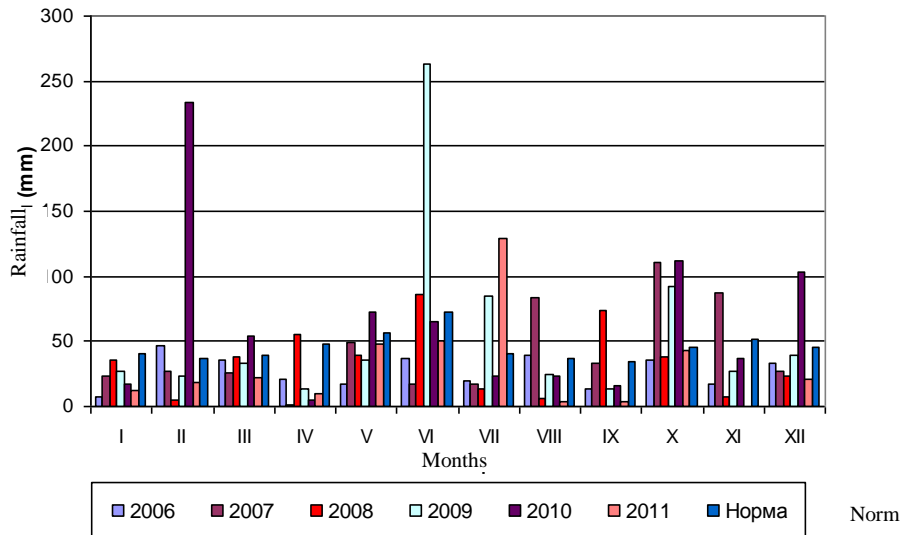

**Fig. 3.7-2 Allocation of the month rainfalls in the region of KNPP within 2006– 2011**

The figure clearly shows that the rainfalls in 2006 are below the norm during all months of the year. When analyzing the data of the season allocation of the rainfalls in 2006, it was found that, except the summer rainfalls, during the rest seasons the rainfall quantities were 1.5 -2 times lower than the norms. In 2007 typical for the rainfall season allocation had a minimum during the spring (75.9 mm, which is 50 % of the norm) and a maximum during the autumn months when their quantities reached 231.3 mm and is approximately double the norm. In this year there was a displacement of the rainfall maximum from June to October and November. Also, the rainfalls fallen down in August were considerable. In 2008 rainfalls follow their normal development, although in some months, such as February, the rainfalls were only 5 mm, which is 7 times less than the February norm, and in September the monthly quantities exceed twice the climatic values.

In 2008 was characterized by a dry winter (seasonal quantity was 61.3 mm or 50 % of the norm) and a humid summer (106.0 mm), the other seasonal quantities are close to the climatic values.

The conditions of the atmosphere moistening in the region are characterized by the values of the relative air humidity. When analyzing the existing data, we found out an interesting fact: in the last two years the values of the relative humidity were considerably lower than the norm, especially during the warm part of the year. Only in 2006 the allocation of the air humidity by months is close to the development of the climatic data (fig. 3.7-3).



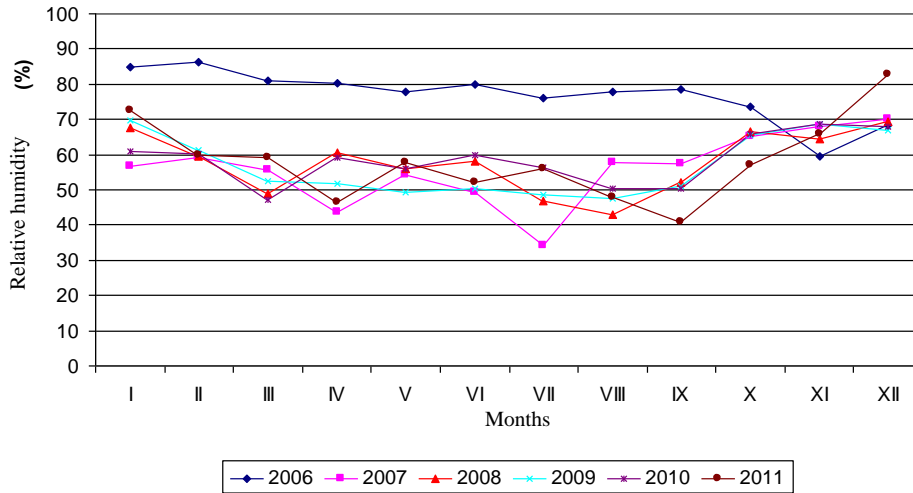

**Fig. 3.7-3 Monthly allocation of the values of relative air humidity in the region of KNPP within the period 2006 - 2011**

Monthly values of the wind velocity during the years examined are presented on fig.3.7-4.

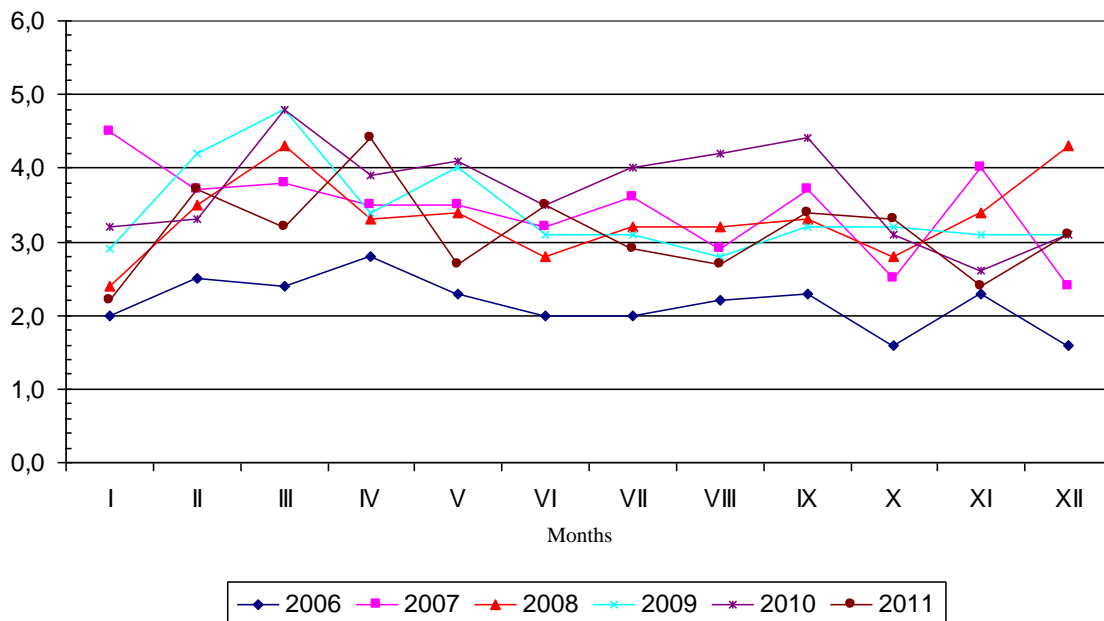

**Fig. 3.7-4 Allocation of the average month velocities of the wind in the region of KNPP within the period 2006 – 2011**

As it is shown on the presented figure, the average wind velocity in the separate years and months fluctuates from 1.6 to 4.5 m/s. Wind velocities in 2006 are closest to the climatic values. Comparatively stronger winds blow in the other two years.

Data on the wind frequency by directions during the different years shows that the winds with southwest-west component prevail followed by the ones with south, northwest-west, northeast-east and east direction. As a whole, for the three years for the region of KNPP the southeast winds are the most rarely occurred ones. In order to visualize the allocation of the wind velocities, fig. 3.7-5 shows the annual wind rose in 2008; it is mostly the same during the rest of the investigated period.

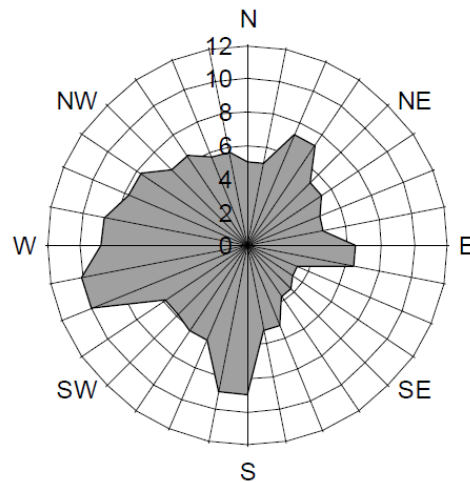

**Fig. 3.7-5 Wind rose for the KNPP area for 2008**

Due to the importance of the information about the wind regime in the KNPP area, three points are used (AMS 1, AMS 2 and AMS 3) for the monitoring of the microclimatic features of the wind allocation. Fig. 3.7-6 shows the wind frequencies by direction in the three points in 2008. As it could be seen, the microclimatic ground features have significant impact on the allocation of the prevailing winds by directions.

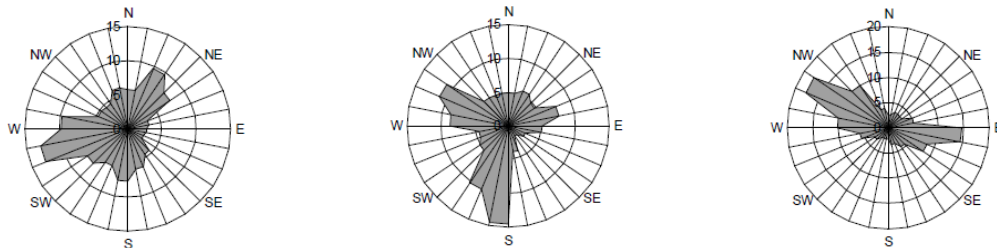

**Fig. 3.7-6 Wind roses in AMS 1, AMS 2 and AMS 3 for 2008**

The important characteristic of the wind regime is the frequency of the strong winds. Winds with a velocity equal to or higher than 14 m/s are considered strong winds.

According to the book “Climate of Bulgaria” (1991), in the KNPP area the prevailing strong winds are from west and northwest. Their which frequency reaches 80 % (in some places up to 90 %) of the cases with strong winds.

According to the zoning of the country, presented in the same book, the KNPP area is located in the windy district of the country. The probable maximal wind velocity in that district could reach 33 m/s, and the respective pressure (loading), which such wind could have on the different facilities, is up to 550 N/m<sup>2</sup>. This information is extremely important, because it is used for the calculation of the dose rate in the KNPP area. Based on the obtained results, certain actions can be undertaken in case of emergency, and the assessment of the impact of KNPP on the environment and on the National Emergency Plan could be performed.

For calculation of the dose rates in the KNPP area, the information about the condition of the atmosphere turbulence is used, which is the main factor for distribution of impurities into the atmosphere air. The atmosphere stability has been evaluated using the Pasquill classification system. The atmospheric stability class is determined in the three automatic microclimatic stations (AMS). Data about the allocation of the stability classes by months for the period of 2006-2008 show that the cases of stable and neutral atmosphere condition prevail (classes D & E). Strong unstable conditions (classes A & B) are rare phenomenon for the KNPP area and are witnessed mostly in the summer, i.e. in the months of June and July. In the winter period the stable conditions of the atmosphere prevail, which is related to the frequent temperature inversions and mists in the region. The condition in December is the most stable one.

The dynamics of the air transfer in the ground layer is characterized by a “wind rose”. Wind roses for Lom, Oryahovo and Kozloduy (for the period from 1977 to 1986) are shown on the next figures 3.7-7 to 3.7-9.

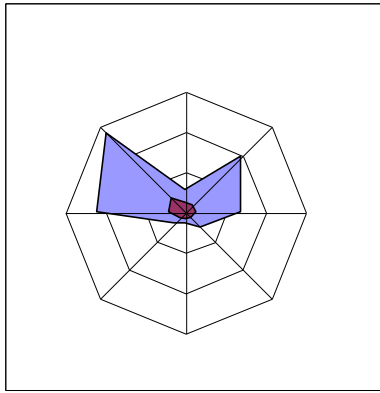

Fig. 3.7-7 Wind rose for Lom

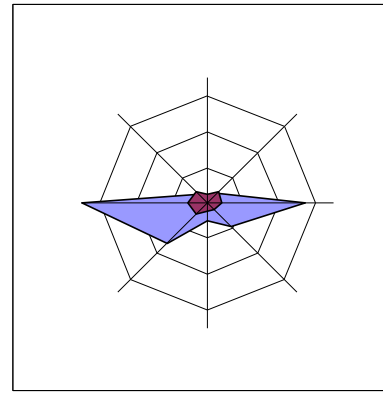

Fig. 3.7-8 Wind rose for Oryahovo

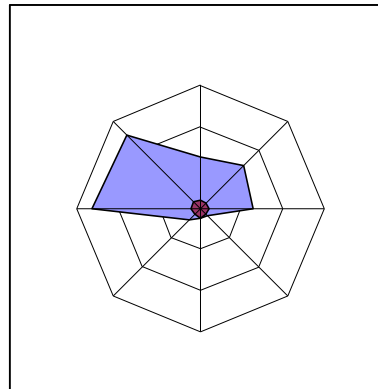

Fig. 3.7-9 Wind rose for Kozloduy

### Hurricane winds and whirlwind

Based on the monitoring, it has been found that the maximal velocities of the recorded winds in the site area do not exceed 30 m/s, and a wind with velocity of 37-42 m/s can possibly occur with a certainty of 1 % (per 100 years). However, no catastrophic hurricanes or whirlwinds have been recorded in the area.

International materials are used for the examination, occurrence and dynamics of the whirlwind phenomenon. Whirlwinds occur very often on the territory of the North America and less often in Europe and Asia. In Europe there are approx. 5 whirlwinds per year, and over 100 – 200 in America.

In Bulgaria the whirlwind is quite a rare phenomenon. Even rarely, there are some conditions for occurrence of hurricanes or whirlwinds.

It has been determined that hurricane winds and whirlwinds are recorded mostly in the mountain and fore-mountain areas and one is recorded close to the seaside. According to

the BAS calculations, the whirlwind characteristics are as follows:

- Maximal velocity- 380 km/h (105 m/s);
- Rotation velocity – 306 km/h (85 m/s);
- Velocity of progressive motion – 80.5 km/h (22.4 m/s);
- Radius corresponding to the maximal rotation velocity of the air flow 47.5 m;
- The difference between the atmospheric pressure in the whirlwind centre and its end is about 103 hPa;
- Velocity of the drop down of the atmosphere pressure between the centre of the whirlwind and its end is about 41 hPa/s.

The probability for a whirlwind with such characteristics to occur in Bulgaria and respectively in the site area is  $P = 9.177E-6$  1/year, i.e. approximately  $1.E-5$  1/y.

The main conclusion is that the probability for a whirlwind with such characteristics to occur over Bulgaria and respectively over the site within one year is rather small. Therefore, the impact of this phenomenon on the site safety may not be taken into consideration.

With certainty  $P = 0.01$  % (probability of 1 occasion per 10000 years), the calculated wind velocity, which could be used for stability inspections in applying combined impacts on the civil constructions and facilities of first category, which provide NPP nuclear and radiation safety, is 45 m/s. With security  $P = 1$  % (probability of 1 occasion per 100 years), calculated wind velocity is 37-42 m/s. This value can be used in verifying not combined impacts of the other civil structures and facilities of KNPP.

## **3.8 Radiation background, atmospheric radioactivity and air quality**

### **3.8.1 Air quality**

Area of urgent protection measures (30 km) covers the municipalities of Kozloduy, Miziya, Oryahovo and Vulchedrum. Quality of the atmosphere air is determined by the industrial activity, motor transport and residential sources.

More considerable emission potential sources in the region are:

- KCH “Mizia” LTD (cellulose and paper factory), which currently is hardly in operation or executes some paper packaging. Based on the inspections of the District Heating Plant of the company made by Vratsa Regional Environmental and Water Inspection, for the time when it was in operation some increase of the dust norms is determined.
- “Variyana” LTD– Oryahovo produces cast iron molding and when loading the production facilities there are conditions for air pollution. This production is also drastically reduced. There are some other enterprises in the Oryahovo municipality such as: „Agrotechchast” JSC, which produces spare parts for agricultural practices, “Ksilema” LTD - wood wrapping and packing, “Hydrocom” LTD –hydraulic and mechanical jacks. These enterprises are of small capacity and restricted production and they are of local significance for the atmosphere air.
- “Butan-94” JSC, the village of Butan, produces vegetable and fruit cans and also has local importance as a source of emissions in the atmospheric air.

On the territory of Kozloduy Municipality some more important sources of emissions into the atmosphere are: workshops, industries, diesel generating stations, asphalt facility in the village of Butan with “Putnostroyengineering” JSC, Vratsa; “Atomenergostroyprogress”, “Zavodski stroezhi” and “Mechanization and transportation”. These are dust sources with local activity. The municipality main sources of atmospheric emissions in 2010 are not engaged in productive activity (Report on State of Environment 2010, RIEW Vratsa). In the municipality of Kozloduy control two objects in Ordinance № 7 to limit emissions of volatile organic compounds into the air resulting from the use of solvents in certain installations. Dry Cleaning "Julian Toshev" ET and "Atomenergoremont". Do not exceed the rate established for VOC emissions.

Transport is a significant source of emissions of carbon oxide, hydrocarbons, nitrogen oxides etc. Roads in the municipality have considerably high intensity of motor traffic. The three motor facilities of KNPP have around 300 motor vehicles - busses, trucks, cranes, tow-trucks, passenger cars. In the peak hours, even though for a short time, there are conditions for increase of the motor transport emissions.

Vulchedrum municipality is located in the Montana district and the main emission sources are concentrated in the district city and are beyond the examined area. Measurement of the atmospheric pollutants is made only at one point in the Montana



town.

Quality of the atmospheric air in the Vratsa district is monitored by the National Automatic Environmental Monitoring System (NAEMS) with Vratsa RIEW, and the Automatic Measurement Station (AMS) for Vratsa and the Mobile automatic station for quality control of the atmospheric air with the Regional laboratory - Pleven for the other settlements.

The territory controlled by Vratsa RIEW is divided into regions and the emission control is performed by the Mobile Automatic Station for quality control of the atmospheric air with the Regional Laboratory of Pleven.

One of the regions is the district of Kozloduy, which covers the municipalities: Kozloduy, Oryahovo and Mizia.

In the last 4 years in the region of Kozloduy measurements of the concentrations of harmful substances have been made by the Mobile automatic station for quality control of the atmospheric air in 2006 and 2008.

Dust concentrations in the atmospheric air are in the range 0.08-16 mg/m<sup>3</sup> and in different times of day may reach 64 % of average daily MAC for total suspended dust (according to Regulation No 14/MH and MEW from 1997). Slightly lower are the values in Kozloduy – around 0.5 average daily MAC. In Hurletz village the values are even lower. The concentrations of the main gas components SO<sub>2</sub>, CO, NO<sub>2</sub>, H<sub>2</sub>S, methane and non-methane hydrocarbons, O<sub>3</sub> and NH<sub>3</sub> are usually considerably lower than the average daily MAC and the maximum single MAC (Municipal Program for Environmental Protection 2010-2013, Kozloduy municipality).

In 2006 emission monitoring was performed in the Municipalities of: Miziya/2 points – Municipality garages-Miziya and Petrol station "Kosania" in Miziya/, Oryahovo/2 points – Regional Fire Protection Service - Oryahovo and the Port of Oryahovo/, Kozloduy/1 point - Regional fire Protection Service-Kozloduy/.

In 2008 measurements were made for the three above municipalities too. Results of the measured indicators: carbon dioxide, ozone, sulfur dioxide, nitrogen dioxide, ammonia, hydrogen sulfide, methane and non-methane hydrocarbons meet the permissible concentrations according to the currently effective regulations.

No program for reduction of the levels of the pollutants is required for the region, which according to Article 30 and Article 31 of Ordinance No 7 for assessment and control of the atmosphere air quality (SG. 45/1999, in force from 01.01.2000) shows that the measured concentrations of harmful substances are lower not only than the permissible norm but also than the upper and lower assessment limits.

### **3.8.2 Atmospheric radioactivity**

The general requirements and the main principles, standards and rules for radiation

protection during activities in NPP are determined by *ASUNE*, the *Regulation on the Basic norms for radiation protection (Regulation on BNRP)*, the *Regulation on ensuring the safety of nuclear facilities* and the *Regulation on radiation protection during activities with SIR*. In the Regulation on BNRP the occupational dose limits are established:

**For the population:**

- Effective annual dose 1 mSv;
- The limits for the annual equivalent doses, keeping the limit of the annual effective dose per member of the population, are as follows: for eye lens – 15 mSv, for skin – 50 mSv (this is the limit for the average dose received from any surface with area of 1 cm<sup>2</sup>, regardless of the exposed surface area).

In order to apply the principle for optimization of the radiation protection, the *Regulation on BNRP* determines the order for establishment and justification of dose limits for population exposure to different sources. Such dose limits have been introduced with the *Regulation on safety during RAW management* – 0.3 mSv/y per facility for RAW disposal after its shutdown.

Common practice of the NF operators is the introduction of control, administrative levels of individual occupational dose for the personnel – from 8 to 12 mSv for KNPP and SE RAW for 2010.

The *Regulation on BNRP* and the *Regulation on radiation protection during activities with SIR* determine the measures that the licensee is obliged to take in order to prevent any unplanned and uncontrolled release of radioactive materials into the environment. A requirement has been introduced for the NF for zoning of the sites and compartments where the exposure may exceed 1 mSv per year or the equivalent dose may reach 1/10 from the dose limits for the eye lens, skin and limbs in regard to the dose power value of the surface or air contamination. Detailed requirements for the organization of flows, velocity, maintenance of under-pressure and air clean-up have been established. The procedure for access and the control over the containment of radioactive contamination within the borders of the zones have also been described in detail.

The admissible activity levels for the liquid and gaseous releases are not legally established, but are approved by BNRA individually for all nuclear facilities and sites. The levels of permitted releases into the environment are established based on the occupational dose for the population and should be coordinated with the Minister of Health.

According to the *Regulation on ensuring the safety of nuclear facilities*, the annual dose as result of the impact of liquid and gaseous releases during normal NPP operation is limited for all NF for the entire site to 150 µSv/y for new NF and to 250 µSv/y for the existing ones.

The KNPP NF technological regulations, containing the operational limits and conditions, include also limits for releases of radioactive substances into the environment

during normal operation. The established levels of activity for liquid and gaseous releases guarantee occupational dose for the population below 50  $\mu\text{Sv/y}$ .

A comprehensive monitoring system has been built for the liquid and gaseous radioactive releases.

### 3.8.2.1 Aerosols

Radioactivity of the atmospheric air has been investigated annually at 11 control points in the 100-km radius around KNPP. Summarized data about the aerosols monitoring conducted in the period 2006-2008 are presented in table 3.8.2.1-1. (Results from the radioecological monitoring of KNPP, Annual reports 2006, 2007, 2008).

**Table 3.8.2.1-1 Data about the conducted aerosols monitoring**

Year	Number of samples	Number of analyses	Type of analyses	Results
2006	644	655	131 - gamma-spectrophotometric  524 - radiometry by total beta activity	<ul style="list-style-type: none"> <li>• Within normal limits with reported background values of <math>^{137}\text{Cs}</math> within the range of 0.4- 2.4 <math>\mu\text{Bq/m}^3</math> of global nature</li> <li>• Average value under long lived total beta activity, within its natural limits, from 0.63 <math>\text{mBq/m}^3</math></li> </ul>
2007	639	651	131 - gamma-spectrophotometric  520 - radiometry by total beta activity	<ul style="list-style-type: none"> <li>• Within normal limits with reported background values of <math>^{137}\text{Cs}</math> within the range of 0.3- 11.3 <math>\mu\text{Bq/m}^3</math> of global nature</li> <li>• Average value under long lived total beta activity, within its natural limits, from 0.53 <math>\text{mBq/m}^3</math></li> </ul>
2008	662	670	132 - gamma-spectrophotometric  538 - radiometry by total beta activity	<ul style="list-style-type: none"> <li>• Within normal limits with reported background values of <math>^{137}\text{Cs}</math> within the range of 0.3- 2.4 <math>\mu\text{Bq/m}^3</math> of global nature</li> <li>• Average value under long lived total beta activity, within its natural limits, from 0.59 <math>\text{mBq/m}^3</math></li> </ul>

Table 3.8.2.1-2 presents data about the average values of the total beta activity of the long lived aerosols for the different points in the last three years (2006-2008).

**Table 3.8.2.1-2 Total beta activity of aerosols, average and maximal values ( $\text{mBq/m}^3$ )**

Point No	2006		2007		2008	
	Average value	Maximal value	Average value	Maximal value	Average value	Maximal value
1	0,45	1,09	0,36	0,89	0,49	1,37
9	0,59	1,51	0,47	0,88	0,59	1,23

Point No	2006		2007		2008	
13	0,52	1,36	0,43	1,00	0,59	1,60
14	0,47	2,92	0,40	1,33	0,56	1,24
15	0,81	2,22	0,59	2,21	0,66	1,97
16	0,66	1,73	0,53	1,97	0,60	1,97
17	0,97	2,56	0,99	2,71	0,95	3,94
22	0,50	1,38	0,29	0,60	0,35	0,81
27	0,65	2,68	0,36	0,80	0,40	0,95
28(Lom)K	0,74	1,77	0,81	3,17	0,61	1,68
29(Pleven)K	0,68	2,87	0,61	1,34	0,95	1,56

The table shows that the average values of the total beta activity of the long lived aerosols for each point vary within comparatively narrow range, respectively in 2006 – 0.45- 0.97 mBq/m<sup>3</sup>, in 2007 – from 0.29 to 0.99 mBq/m<sup>3</sup> and in 2008 – from 0.35 to 0.95 mBq/m<sup>3</sup>. Average values for the three years are respectively 0.59 mBq/m<sup>3</sup> – 2006, 0.53 mBq/m<sup>3</sup> - 2007 and 0.59 mBq/m<sup>3</sup> – 2008. The maximal measured value in 2006 is 2.92 mBq/m<sup>3</sup> (point -14 village of Glozhene), in 2007 it is 3.17 mBq/m<sup>3</sup> (point -28 town of Lom) and in 2008- 3.94 mBq/m<sup>3</sup> (point -17 Miziya).

The conducted measurements have detected a relative increase in the long lived beta activity in the aerosol filters of some of the control points mainly in the winter months. This is a result of the snowfalls as well as of the fallout during this period.

Fig. 3.8.2.1-1 shows a comparison of the data about the long lived beta activity for a long term period. Results show that there is no trend for change of the radiation parameters.

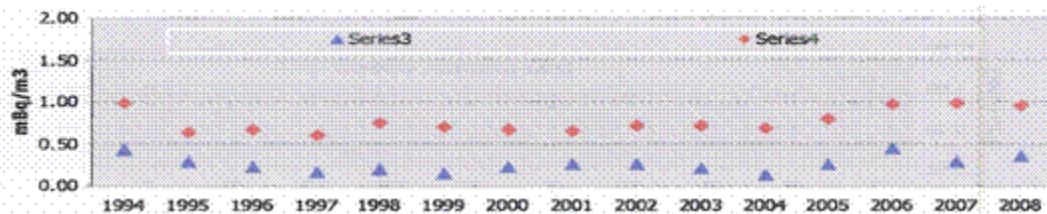

**Fig. 3.8.2.1-1 Average values of the long live beta activity (mBq/m<sup>3</sup>) in aerosols from 100-km of KNPP, 1994-2008**

Gamma spectrometric analyses of the aspiration samples in the last three years show results for <sup>137</sup>Cs within the Minimum Detectable Activity (MDA) (< 0.2 to <2.8 μBq/m<sup>3</sup>). These are typical values for the ground layer in these geographic latitudes. Maximal measured activity is equal respectively in 2006 - to 2.4 μBq/m<sup>3</sup>, (point 27 – town of Oryahovo), in 2007 to 11.3 μBq/m<sup>3</sup> (point 27 – town of Oryahovo) and in 2008 – to 2.1 μBq/m<sup>3</sup> (point 29, Pleven). Recorded radioactivity of <sup>137</sup>Cs in the air is about 10<sup>6</sup> times lower than the norms in the country (Average Annual Permissible Concentration (AAPC) for <sup>137</sup>Cs according to Basic Radiation Protection Norms -2004 is 3.2 Bq/m<sup>3</sup>).

Data on the released activity through KNPP ventilation tubes for the period 2008-2010

are presented in table 3.8.2.1-3.

**Table 3.8.2.1-3 Released activity through KNPP ventilation tubes**

Gas-aerosol emissions	2008	2009	2010
Radioactive noble gases, TBq	0.55	0.66	6.43
Iodine-131, GBq	0.0011	0.0056	0.066
Radioactive aerosols, GBq	0.019	0.063	0.028
<sup>3</sup> H-, GBq	NA	NA	376
<sup>14</sup> C-, GBq	NA	NA	519

**Table 3.8.2.1-4 Released activity through KNPP ventilation tubes 1 and 2 (EP-1)**

Gas-aerosol emissions	2009	2010	2011	% compared to the limit
Radioactive noble gases, TBq	0.0	0.0	0.0	
Iodine-131, GBq	0.0	0.0	0.0000078	
Radioactive aerosols, MBq	55.3	19.9	5.48	
<sup>3</sup> H, GBq	NA	NA	269	9.9
% Compared to the limit of the total 6 GBq activity of radioactive aerosols	0.92	0.33	0.09	
<sup>14</sup> C, GBq	NA	NA	671	0.33

The results of measurements of the activity of  $\gamma$  discarded aerosols in VS1 and VS2 (EP1) in 2011, according to [35] showed that the activity of long-lived aerosols dumped in VS of 1-4 units is 0.09 % of the permissible level and the value is 3 times lower than in 2010.

Discarded activity of strontium 90 (<sup>90</sup>Sr) in 2011 was nine times lower than that of 2010 and is the lowest in the last five years.

Discharges of gaseous  $\alpha$ -emitters is reduced compared to the previous year, about seven times.

Discharges of tritium (<sup>3</sup>H) and <sup>14</sup>C through Vent Tubes of Units 1 to 4 in 2011 are respectively 0.36 % and 0.33 % of annual limits.

In 2011 started the measurement of <sup>85</sup>Kr through VS2 and measured values are below the minimum detectable minimum.

Cumulative data for the gaseous discharges from EP-1 in 2011 show that the major contribution is tritium. Discharges of <sup>14</sup>C are ten times lower than that of tritium, whereas the activity of discharges of  $\gamma$  aerosols is 4 orders of magnitude lower than that of tritium.

### Distribution of isotopes in incoming and outgoing waste gases and corium

According to the document ISAR [2] the distribution of isotopes in the incoming waste and waste gas and corium is presented in the table below, with the largest share of the incoming waste is over 50 %  $^{60}\text{Co}$  and  $^{137}\text{Cs}$  – 20 %, respectively, and their shares in the exhaust is above 30 %.

If the results are normalized distribution, the distribution of isotopes in the corium and the exhaust gas is also determined.

**Table 3.8.2.1-5 Distribution of isotopes in incoming and outgoing waste gases and corium**

Isotop	Distribution of isotopes in the incoming RAW	Share in the corium	Share in the exhaust gas	Distribution of isotopes in the corium	Distribution of isotopes in the exhaust gas
	(%)	(%)	(%)	(%)	(%)
$^{60}\text{Co}$	57.00	51.30	5.70	60.50	37.50
$^{110\text{m}}\text{Ag}$	6.00	5.40	0.60	6.37	3.95
$^{134}\text{Cs}$	6.00	4.20	1.80	4.95	11.84
$^{137}\text{Cs}$	20.00	14.00	6.00	16.51	39.47
$^{95}\text{Nb}$	1.00	0.90	0.10	1.06	0.66
$^{54}\text{Mn}$	6.00	5.40	0.60	6.37	3.95
$^{59}\text{Fe}$	1.00	0.90	0.10	1.06	0.66
$^{58}\text{Co}$	3.00	2.70	0.30	3.18	1.97
<b>Total</b>		84.80	15.20	100	100
100		<b>100</b>			

Considering the maximum specific activity of incoming RAW, the proportion of isotopes in the corium (85 %), the average density and reducing the volume of each type of packaging waste, the maximum measured activity in a barrel of 200 l, 170 l containing glass waste is  $9.1\text{E}+08$  Bq.

HEPA filters have an efficiency of 99.97 %, and after scrubbing system can be assumed efficiency 99.995 %, taking into account the activity caught in solids (melt and ash) and liquid products (water scrubber).



Considering the filtration equipment in the process, it can be assumed Transmittance (LPF) of  $3.00E-04$ .

Considering the normal capacity of the furnace, the isotopic distribution of the incoming activity (15 % remains the exhaust gas), and LPF, missed radioactivity may be assessed as follows:

- Incoming radioactivity =  $5.17E+05 \text{ Bq/kg} \times 65 \text{ kg/h} \times 4000 \text{ h/a.} = 1.34E+11 \text{ Bq/a.}$
- Outgoing radioactivity =  $1.34E+11 \times 3E-04 \times 0.15 = 6.03E+06 \text{ Bq/a.}$

This means that in normal operation the annual of radioactive emissions typical gamma isotopes are  $6.03E+06 \text{ Bq/a}$  during treatment of  $65 \text{ kg/h}$  at the time of 4000 hours of operation effective.

PMF will be 40 weeks in service, therefore, the radioactive emission of a typical beta-gamma isotope is  $2.15 \text{ E} +4 \text{ Bq/day}$ .

This value corresponds to the eligibility criteria set out in Chapter 1 for annual and daily emissions of PMF ( $0.3 \text{ GBq/year}$  and  $0.8 \text{ MBq/day}$ ).

Monitoring of  $^3\text{H}$  and  $^{14}\text{C}$  in the gaseous releases from KNPP has been performed since 2010. In order to comply with the requirements of Article 45 from Directive 96/29/Euroatom, estimated shares have been determined for 2008 and 2009 of the  $^3\text{H}$  and  $^{14}\text{C}$  releases in the atmosphere, based on the generated electrical power from KNPP and the published data in Annex C from the UN report (UNSCEAR'2000) on the distribution of releases from PWR-type reactors. These estimated data are also used in the assessment of the occupational dose for the population.

Registered tritium releases in the last three years represent from 7 to 13 % from the permitted value.

The total activity of the gas-aerosol and liquid releases as part of the annual control levels in % for the period 2004 - 2010 are shown on fig. 3.8.2.1-2.

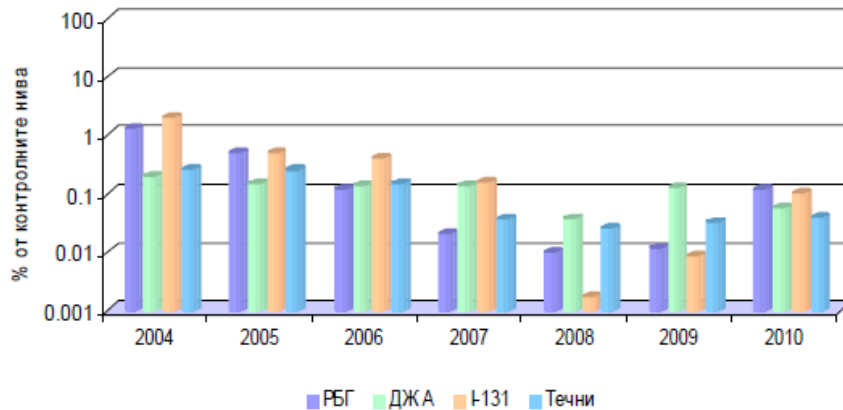

**Fig.3.8.2.1-2 Total activity of the gas-aerosol and liquid releases as part of the annual control levels**

Legend:

РБГ-Radioactive noble gases;

ДЖА- Long lived Aerosols,

<sup>131</sup>I –Iodin

Течни- Liquid

% - From controlled levels

The additional occupational dose for the population in the 30-km area is about 500 times lower than the natural radiation background (2400  $\mu$ Sv). During the last 10 years the values of the maximal individual effective dose for the population vary in the range 2.5 ÷ 5  $\mu$ Sv/a.

The values of the maximal individual effective dose from gaseous releases from KNPP site, considering the contribution of <sup>3</sup>H and <sup>14</sup>C, are as follows:

Year	Maximal dose RNG LLA+ <sup>131</sup> I Sv	Maximal dose <sup>3</sup> H, Sv	Maximal dose <sup>14</sup> C, Sv	Maximal dose Total, Sv
2007	1.43.10 <sup>-8</sup>	4.36.10 <sup>-8</sup>	4.05.10 <sup>-7</sup>	4.54.10 <sup>-7</sup>
2008	3.09.10 <sup>-9</sup>	5.39.10 <sup>-8</sup>	5.01.10 <sup>-7</sup>	5.58.10 <sup>-7</sup>
2009	1.17.10 <sup>-8</sup>	5.20.10 <sup>-8</sup>	4.82.10 <sup>-7</sup>	5.46.10 <sup>-7</sup>
2010	3.90.10 <sup>-9</sup>	5.63.10 <sup>-9</sup>	7.88.10 <sup>-7</sup>	8.02.10 <sup>-7</sup>

The <sup>3</sup>H and <sup>14</sup>C occupational dose for 2007, 2008 and 2009 has been assessed based on

estimated data for the releases. The  $^3\text{H}$  and  $^{14}\text{C}$  occupational dose for 2010 has been assessed based on actual measurements of released quantities.

The performed aerosol monitoring in the area has shown that KNPP impact on the aerosol activity is extremely small. The measured values are within the natural limits for the area. The registered radioactivity complies with the legal requirements.

### 3.8.2.2 Atmosphere deposits

Atmosphere deposits are controlled monthly in 33 of 36 control points within 100-km monitored area around the NPP. Summarized data about the monitoring of atmosphere deposits conducted within the period of 2006-2008 are presented in table 3.8.2.2-1 (Results of the radio ecological monitoring of KNPP, Annual Reports 2006, 2007, 2008).

**Table 3.8.2.2-1 Data about the conducted monitoring of the atmosphere deposits**

Year	Number of samples	Number of analyses	Type of analyses	Results
2006	422	789	367 - gamma-spectrophotometric 367 - radiometry by total beta activity 55 - with radiochemical isolation of strontium	Within normal limits – values by total beta activity within the range of 0.028-1.96 Bq/m <sup>2</sup> *d, with average annual value 0.42 Bq/m <sup>2</sup> *d
2007	440	809	369 - gamma-spectrophotometric 384 - radiometry by total beta activity 56 - with radiochemical isolation of strontium	Within normal limits – values by total beta activity within the range of 0.034-2.12 Bq/m <sup>2</sup> *d, with average annual value 0.41 Bq/m <sup>2</sup> *d
2008	396	841	394 - gamma-spectrophotometric 396 - radiometry by total beta activity 51 - with radiochemical isolation of strontium	Within normal limits – values by total beta activity within the range of 0.014-2.05 Bq/m <sup>2</sup> *d, with average annual value 0.37 Bq/m <sup>2</sup> *d

The presented data show that the total beta activity has the natural values typical for the area. Slightly seasonable dependence is found with maximal values during the winter months and the spring-summer period, which is a result of the intensive rainfalls and self-purification of the atmosphere leading to reduction of the aerosol activity and increase of the deposits activity.

Table 3.8.2.2-2 shows data from the  $^{90}\text{Sr}$  analysis in atmosphere deposits.

**Table 3.8.2.2-2 Activity of <sup>90</sup>Sr in the atmosphere deposits in the period 2006–2008 (Bq/m<sup>2</sup>\*d)**

Sampling	quarter			
	2006			
Control points – 100 km				
	I	II	III	VI
I radius (p. 1-4)	0,0006±0,0001	0,0013±0,0002	0,0015±0,0002	0,0009±0,0001
II radius (p. 5-8)	0,0012±0,0002	0,0012±0,0002	0,0014±0,0002	0,0016±0,0001
III radius (p. 9-12)	0,0012±0,0001	0,0009±0,0002	0,0018±0,0002	0,0008±0,0001
IV radius (p. 13-20)	0,0006±0,0001	0,0007±0,0001	0,0008±0,0002	0,0012±0,0002
V radius (p. 21-27)	0,0008±0,0001	0,0006±0,0001	0,0008±0,0001	
Point 28 – Lom	-	<0.0025	<0.0012	
Point 29 - Pleven	<0.0016	<0.0014	0,0034±0,0006	
Point 30 - Berkovitsa	0,0027±0,0005	<0.0016	0,0020±0,0004	0,0065±0,0005
Control points – industrial site				
Point 31	<0.0016	<0.0014	0,0018±0,0005	0,0050±0,0004
Point 32	<0.0015	<0.0019	0,0035±0,0004	
Point 33	<0.0015	<0.0022	0,0039±0,0008	
Point 34	<0.0014	0,0028±0,0006	0,0025±0,0004	0,0034±0,0004
Point 35	<0.0014	0,0019±0,0006	0,0017±0,0004	0,0038±0,0005
Point 36	<0.0016	<0.0020	0,0043±0,0009	<0.0013
	2007			
Control points – 100 km				
I radius (p. 1-4)	0,0012±0,0002	0,0010±0,0002	0,0023±0,0002	<0.0005
II radius (p. 5-8)	0,0016±0,0003	0,0006±0,0001	0,0018±0,0001	<0.0004
III radius (p. 9-12)	0,0020±0,0001	<0.0005	0,0027±0,0002	<0.0005
IV radius (p. 13-20)	0,0012±0,0001	<0.0003	0,0025±0,0001	<0.0003
V radius (p. 21-27)	0,0009±0,0001	<0.0003	0,0011±0,0001	<0.0003
Point 28 – Lom	<0.0020	<0.0022	<0.0018	<0.0016
Point 29 - Pleven	0,0019±0,0005	<0.0019	<0.0018	<0.0012
Point 30 - Berkovitsa	<0.0022	<0.0022	0,0062±0,0005	<0.0014
Control points – industrial site				
Point 31	<0.0017	0,0016±0,0005	0,0037±0,0005	<0.0016
Point 32	<0.0022	<0.0026	0,0108±0,0007	<0.0016
Point 33	<0.0017	<0.0019	0,0161±0,0007	<0.0016
Point 34	<0.0020	<0.0022	0,0042±0,0005	<0.0017
Point 35	<0.0013	<0.0022	0,0087±0,0006	<0.0015
Point 36	<0.0017	<0.0027	0,0133±0,0007	<0.0015
	2008			
Control points – 100 km				

I radius (p. 1-4)	<0.0004	0,0007±0,0002	<0.0004	<0.0005
II radius (p. 5-8)	<0.0004	<0.0005	0.0005±0.0001	<0.0006
III radius (p. 9-12)	<0.0004	<0.0006	<0.0004	<0.0004
IV radius (p. 13-20)	<0.0003	0,0008±0,0001	<0.0003	<0.0004
V radius (p. 21-27)	<0.0003	0,0011±0,0001	<0.0003	<0.0003
Point 28 – Lom	<0.0013	<0.0019	<0.0021	<0.0021
Point 29 - Pleven	<0.0018	<0.0015	<0.0019	<0.0017
Point 30 - Berkovitsa	0,0020±0,0005	<0.0027	0,0045±0,0006	<0.0015
Control points – industrial site				
Point 31	<0.0018	<0.0016	<0.0020	<0.0016
Point 32	<0.0018	<0.0019	<0.0022	<0.0016
Point 33	<0.0018	<0.0020	<0.0020	<0.0018
Point 34	<0.0019	<0.0020	<0.0018	<0.0018
Point 35	<0.0019	<0.0019	<0.0018	<0.0017
Point 36	<0.0021	0.0023±0.0006	<0.0018	<0.0020

As it is seen from the table above, during the last three years most values are close or lower than the MDA. Respective average values are: in 2006 – 0.0018 Bq/m<sup>2</sup>\*d, in 2007 – 0.0025 Bq/m<sup>2</sup>\*d and in 2008 – 0.0014 Bq/m<sup>2</sup>\*d. Maximal values are measured at Berkovitsa point in 2006 and 2008 and on the industrial site in 2007. Measured results are lower than the ones indicated in the pre-commissioning period.

Anthropogenic activity is measured only in certain cases at some points on the site of KNPP – point 32 during the three years and points 3 and 36 in 2008.

As a whole, it is reported that the radioactivity of the atmosphere deposits within the 100-km radius area is within the normal limits and is not impacted by KNPP activity.



## **3.9 Harmful physical factors**

### **3.9.1 Ionizing radiation**

Ionizing radiation is mostly a result of the nuclear interacting and fission of the natural and artificial radionuclides. This radiation influences the life of organisms by their ionizing component.

The combination of the secondary solar radiation, the radiation of the natural radionuclides located in the atmosphere, water, food and in the human body is determined as a natural radiation background. Ionizing radiation is characterized by alpha, beta, gamma, and other types of rays.

The measurement of gamma radiation is considered as a primary identification of the impact of radionuclides. This is possible due to the existing cause-effect connection between the dose rate of the gamma radiation and specific activity of the radiating gamma radionuclides in a certain substance.

The natural gamma background radiation is specific for every region at least due to at least two reasons:

- Different content and migrations of gamma radiating radionuclide in the biosphere;
- Various anthropogenic activities with radionuclides.

Although the natural radiation gamma background is anthropogenically impacted by considerable outside nuclear influences such as nuclear explosions, nuclear accidents etc., for the assessment purpose we shall continue to consider it as natural. It is good to remember that in many countries in the world such as India, Iran, France etc. there are regions where the gamma radiation background has significantly higher values compared with the ones measured in the Republic of Bulgaria. The radiation gamma background by itself does not have a hazardous impact on the life of organisms, but drastic changes in its values do. Due to this fact there is no norm for the radiation gamma background, but an average value is established for a certain region, which for our country is 0.10  $\mu\text{Sv/h}$ .

The measurement of the gamma background radiation is an important factor for determination of the occupational dose for the population. The conditions for conduction of environmental radiological monitoring of KNPP from last five years are presented in [35].

### **Environmental radiological monitoring**

For the purposes of localization of the radiation impact of the nuclear power plant on the environment and living organisms and for conduction of respective actions, three areas with different radii are organized: radiation protection area – 2-km, controlled area – 12-km and monitored area – 100-km around KNPP. These areas are currently assigned with new definitions in compliance with the updated legislation. Radiation monitoring has

been performed in these areas by the institutions and control authorities (ExEA, NCRBRP etc.).

In-house radiation monitoring of the environment is stipulated in a long-term program of KNPP, which is established in compliance with the regulations, good international practice, experience of RM Department and it is coordinated with MEW, MH and BNRA as well. Analyses are made of the air, soils, waters and bottom deposits, vegetation and radiation gamma background is measured.

In the monitored area there are 36 points of the ground ecological system and 7 points of the water ecosystem. There are three types of points and they are described in detail in Chapter 1 of this report.

Points of the above types are located in the area of the industrial site in the 12-km controlled area and in the 100-km monitored area around KNPP. In the above areas samples from the potable water, food products and fodders are taken (analyzed). On the industrial site the gamma background radiation, gamma radiation, soil, groundwater, atmosphere deposits, and vegetation are controlled (see fig. 4.1.9-2 Points for radiation monitoring of the industrial site). Methods such as gamma spectrometry, low background radiometry, radiochemistry, liquid scintillation spectrometry etc. are applied during the environmental radiological monitoring.

In order to ensure an objective assessment, a verification of the results of the in-house monitoring with the results of the monitoring of ExEA – MEW and NCRBRP – MH etc. has to be performed.

For determination of the parameters of the higher atmospheric layers (at 25 km) and in order to determine the migration degree of the harmful substances, including radionuclides, an Automatic System for Aerosol Probing (ASAP) is used.

Within the framework of the National Environmental Monitoring System, the ExEA also executes environmental radiological monitoring on the territory of the whole country while maintaining information database. The system provides timely and reliable information on the condition of the environmental elements and the factors that impact it. Based on that information analyses, assessments and forecasts are made in order to justify the activities for environmental protection against harmful impacts. Indicators used for the control monitoring are as follows: gamma background radiation, content of natural and anthropogenic radionuclides in soils, sediments, waste products, specific total alpha and beta activity, content of uranium, radium and tritium in surface and groundwater, increase of radon over industrial dumping piles and in the settlements next to them, and content of radionuclides in the atmospheric air.

Since 1997 the Republic of Bulgaria operates the National Automatic System for Continuous Monitoring of the gamma-background radiation (RaMo) for the purpose of real-time monitoring the background radiation in Bulgaria. This state regulated system works in compliance with the obligations for safe use of nuclear energy for peaceful purposes, environmental radiation monitoring, as well as for mutual information in case

of accidents in nuclear facilities or cross-border transfers.

The system consists of 26 Local Monitoring Stations (LMS) for gamma background radiation covering the entire territory of the country.

The AISERC and RaMo systems are connected and function as Unified National Radiation Monitoring System.

In emergency situations the field measurements, samplings and tests are made by the mobile laboratory and the dose rate of the gamma radiation is measured in motion and in the control points and the activity of  $^{137}\text{Cs}$ ,  $^{134}\text{Cs}$  in aerosols, activity of  $^{131}\text{I}$  in the lower atmosphere, content of  $^{137}\text{Cs}$ ,  $^{134}\text{Cs}$  and  $^{131}\text{I}$  in samples from contaminated surfaces are determined.

For control of background gamma radiation (gamma - dose in air) in real time on the territory of Romania, part of the surveillance zone of KNPP, there are 4 Laboratories (SSRM) in measuring mode, located at Bechet, Craiova, Drobeta Turnu Severin and Zimnicea. Also, there are 17 automatic air gamma dose rate monitoring stations situated in Dolj, Mehedinti, Teleorman districts.

It is appropriate to note that each party has conducted radiological monitoring in areas around KNPP independently and without coordination of their programs.

### **Gamma radiation on the industrial site of KNPP**

Gamma radiation from gamma radiating radioactive sources forms the gamma background radiation in a certain region. Gamma radiation is measured on site by the Site Monitoring Sector in compliance with the Radiation monitoring program on the industrial site during KNPP operation UB.MP.PM.099/03 [38]. Points have been selected to be next to potential radioactivity sources and to be in accordance with possible radioactive pollutions from the power plant operations of fields, surfaces and others with gamma emitting radionuclides. Gamma radiation and the gamma background radiation are measured as an equivalent dose rate per measured unit (Sv/h). The program objectives are related to the non-proliferation of the radioactive contaminations and to avoid exceeding of the dose rate above certain limits. For this purpose a control limit and a permissible limit are established for certain areas of the site.

The scope of the monitoring defined in the above mentioned program is based on the current Bulgarian legislation (laws, regulations, and guidelines) concerning radiation monitoring area and on KNPP experience. The scope of the KNPP industrial site control is given in Table 1 of the program. In case of recorded exceeding of the control or permissible limits, additional investigations and measurements are performed to identify the source of ionizing radiation (penetrating radiation or radioactive contamination) and to clarify the reasons for it. In case of radioactive contamination it shall be determined if the source is fixed or movable. In case of control limit exceeding appropriate corrective measures according ALARA principle are applied. In all cases of exceeding of the permissible limits correction measurements should be undertaken to ensure a minimum level lower than the permissible thresholds.

Values of the gamma radiation measured in the region of the Access Control Points are close to values of the natural background radiation varying between 0.06 to 0.09  $\mu\text{Sv/h}$ . Control limit for this region is 0.2  $\mu\text{Sv/h}$ , and the permissible limit is 0.3  $\mu\text{Sv/h}$ .

The control of the radiation status of the surface, ground and waste waters in the monitored area is done by sampling and sample analysis.

### **Gamma radiation in the control points on the territory of KNPP**

Measurements are made at 1 m altitude above the ground with control limit 0.50  $\mu\text{Sv/h}$  and permissible limit 1.0  $\mu\text{Sv/h}$ .

### **Equivalent dose rate of gamma radiation on the industrial site of KNPP Units 1–4**

Data from the measurements are shown in table 2.1 of the Summarized reports on the radiation monitoring on the industrial site of KNPP during the period 2006, 2007 and 2008 [35].

Measurements were made at 31 points at 1 m above the ground. At 28 points the values of the measurements varied from 0.04 to 0.2  $\mu\text{Sv/h}$ . At three points, 1M, 2M and 3M, the measured values varied from 0.22 to 2.00  $\mu\text{Sv/h}$  and they exceeded the control and permissible limits. These higher values are caused by gamma emitting radionuclide in AB-1 and radiation contaminated earths disposed in “Mogilata”.

### **Equivalent dose rate of gamma radiation on the industrial site of KNPP Units 5–6**

Data from the measurements are shown in table 2.2 of the Summarized reports on the radiation monitoring on the industrial site of KNPP in 2006, 2007 and 2008 [35].

Measurements were made at 34 points at 1 m above the ground. Registered values for the equivalent dose rate of the gamma radiation varied from 0.06 to 0.18  $\mu\text{Sv/h}$  and they did not exceed the values of the natural radiation gamma background. Under the scaffold bridges connecting AB-3 with MB of Units 5 and 6 and with SD RAW the registered values did not exceed the natural radiation gamma background either.

### **Gamma radiation in the points at the entrance to the transportation corridors to the control room**

Measurements are made at the points at 10 cm above the ground with control limit 0.50  $\mu\text{Sv/h}$  and permissible limit 1.0  $\mu\text{Sv/h}$ .

### **Equivalent dose rate of gamma emission at the entrance to the transport corridor 1 of the Controlled area of KNPP Units 1 and 2**

Data from the measurements are shown in Table 2.3 of the Summarized reports on the radiation monitoring on the industrial site of KNPP in 2006, 2007 and 2008 [35].

Measurements are made in 8 rows at 4 points per row at 10 cm above the ground. Registered values for the equivalent dose rate of the gamma radiation varied from 0.10 to 0.48  $\mu\text{Sv/h}$  and they did not exceed the values of the control limits in the controlled area. Reduction of the measured activities has been recorded. Higher values are caused by old

contaminations fixed in the asphalt covering and by gamma emissions penetrating from the HC-1.

### **Equivalent dose rate of gamma emission at the entrance to the transport corridor 2 of the Controlled area of KNPP Units 3 and 4**

Data from the measurements are shown in table 2.4 of the Summarized reports on the radiation monitoring on the industrial site of KNPP in 2006, 2007 and 2008 [35].

Measurements are made in 8 rows at 4 points per row at 10 cm above the ground. Recorded values for the equivalent dose rate of the gamma radiation varied from 0.08 to 0.46  $\mu\text{Sv/h}$  and they did not exceed the values of the control limits in the controlled area. Reduction of the measured activities is recorded. Higher values are a result of gamma emissions penetrating from RB-2.

### **Gamma emission on sites for RAW temporary storage**

Additional radiation control has been performed at these sites in compliance with the KNPP Program for radiation control of the environment of workshop for treatment, conditioning and storage of RAW.

### **Equivalent dose rate of gamma emission on the site for temporary storage of containers with RAW (BB Cube type, North from the RAW storage facility, next to the Outdoor Switchyard)**

Data from the measurements are shown in table 2.10 of the Summarized reports on the radiation monitoring on the industrial site of KNPP in 2009, 20010 and 2011.

Measurements are made once per month at 9 points at 100 cm above the ground. Recorded values for the equivalent dose rate of the gamma emission have varied from 0.08 to 13.0  $\mu\text{Sv/h}$  and they did not exceed the maximal permissible value of 100  $\mu\text{Sv/h}$ . Gamma emissions and their variations during the measurements are in compliance with the quantities and activities of RAW stored on the site.

### **Equivalent dose rate of gamma emission at the site (east from the RAW Storage facility) for temporary storage of railway containers with I category RAW**

Data from the measurements are shown in table 2.11 of the Summarized reports on the radiation monitoring on the industrial site of KNPP in 2006, 2007 and 2008 [35].

Measurements are made once per month at 12 points at 100 cm above the ground. Recorded values for the equivalent dose rate of the gamma emission have varied from 0.07 to 4.20  $\mu\text{Sv/h}$  and they did not exceed the maximal permissible value of 100  $\mu\text{Sv/h}$ . Gamma emissions and their variations during the measurements are in compliance with the quantities and activities of RAW stored on the site.

### **Radiation control of the area south from AB-1**

### **Equivalent dose rate of gamma emission in the “Mogilata” area South from AB- 1**

Data from the measurements are shown in Table 2.12 of the Summarized reports on the

radiation monitoring on the industrial site of KNPP in 2006, 2007 and 2008 [35].

Measurements are made twice per year in 3 rows at 8 points per row at 10 cm above the ground. Recorded values for the equivalent dose rate of the gamma emission have varied from 0.34 to 5  $\mu\text{Sv/h}$ , and at points 1d, 1e, 1f, 1g, and 1h they did exceed the maximal permissible value of 2.4 Sv/h. These exceeds and their variations are caused by penetration of gamma emissions from AB-1 and the radioactively contaminated earths disposed in Mogilata after penetration of radioactive contaminated waters from AB-1.

### **Radiation gamma background**

Equivalent dose rate of the gamma emission (radiation background) has been measured and is currently measured by dosimetric devices and equipment that are regulated and their calibration is controlled. Measurement and determination of gamma emission of longer duration is made also by thermal luminescent dosimeters (TLD). Measurement units for equivalent dose rate are Sv/h,  $\mu\text{Sv/h}$ . Gamma background radiation (gamma emission) in this case is assessed based on the measurements, analyses and summaries made by KNPP, MH, BAS and automatic continuous control systems during the years 2006, 2007 and 2008, and the plant condition during the selected period has been taken into consideration. Attention is paid to the measurements made on the industrial site of NPP in the detached areas and nearby settlements.

Radiation gamma background on the territory of the Republic of Bulgaria is controlled by:

National automated system for permanent control of gamma-radiation background /BUL RaMo/. With its 26 Local Monitoring Stations (LMS) it records the radiation gamma background on the territory of the entire country.

EEA-MEW makes measurements at points on the territory of the entire country with movable and stationary dosimetric devices. The existence of artificial radionuclides in the environmental components is also monitored in the environmental components.

NCRBRP-MH and National Institute of Meteorology and Hydrology – Bulgarian Academy of Science (NIMH-BAS).

The analysis and the assessment of the presented information in the reports on radiation environmental monitoring in KNPP, the National Automated Continuous Control System of the gamma background radiation and of the other measurements show that during the above years on the territory of the Republic of Bulgaria:

- no unusual changes (increasing) of the values of the radiation gamma background have been recorded;
- radiation gamma background in the controlled points has varied within the limits of the typical natural gamma background for the respective point (region);
- no considerable impact of KNPP on the natural radiation background has been recorded;



- radiation gamma background in 100-km area of KNPP varied for:
- 2009 – in the interval of 0.07-0.15  $\mu\text{Sv/h}$
- 2010 – in the interval of 0.07-0.15  $\mu\text{Sv/h}$
- 2011 – in the interval of 0.05-0.15  $\mu\text{Sv/h}$

Analysis and evaluation of information submitted by the competent supervisory authorities of Romania shows that over the years no significant impact of KNPP on the natural gamma background, typical for the territory of Romania, has been registered.

The average gamma background measured by the automatic stations (SSRM) in the 100 (30) kilometer area of KNPP has reached the following levels:

- 2009 - minimum average of 0.094  $\mu\text{Sv/h}$  and maximum average 0.114  $\mu\text{Sv/h}$ ;
- 2010 - minimum average of 0.090  $\mu\text{Sv/h}$  and maximum average 0.120  $\mu\text{Sv/h}$ ;
- 2011 - minimum average of 0.094  $\mu\text{Sv/h}$  and maximum average 0.110  $\mu\text{Sv/h}$ ;

The measured values of gamma background are much smaller than the set limit (norm) of 0.250  $\mu\text{Sv/h}$  under Decree 1978/2010 by the Government of Romania.

### **Gamma background radiation in certain areas beyond the industrial site of KNPP**

Gamma background radiation in determined areas beyond the site is measured and controlled in compliance with the existing methodology approved by the in-house laboratory for environmental radiological monitoring:

- at 10 control points alongside the fence with TLDs for longer periods of time/three months/;
- at 8 control stations of the AISERC located in 3-km Radiation Protection Area, operating in continuous mode;
- at 22 control points of the 100-km monitored area by thermal luminescent dosimeters (TLD) for longer periods of time/up to three months/;
- at 123 control points of the 100-km monitored area by dosimetric instruments.

Values of the gamma background radiation measured every week by movable dosimetric instruments in all control points of “A” and “B” types and in the monitored populated areas of the 100-km monitored area vary for:

- 2009 – within the range of 0.07-0.09  $\mu\text{Sv/h}$ ;
- 2010 – within the range of 0.06-0.10  $\mu\text{Sv/h}$ ;
- 2011 – within the range of 0.05-0.15  $\mu\text{Sv/h}$ .

They do not differ considerably from the values of the background radiation accepted as natural for the region, which values vary for:

- 2009 – within the range of 0.08-0.15  $\mu\text{Sv/h}$

- 2010 – within the range of 0.04-0.14  $\mu\text{Sv/h}$
- 2011 – within the range of 0.05-0.15  $\mu\text{Sv/h}$

Values of the gamma background radiation are determined as rate of the equivalent dose for the same periods of time and at 32 control points by recording with thermal luminescent dosimeters. Control points are located alongside the KNPP fence (10 pcs) and the monitored area (22 pcs). Values of this gamma background varied for:

- 2009 – within the range of 0.083- 0.15  $\mu\text{Sv/h}$ ;
- 2010 – within the range of 0.072- 0.14  $\mu\text{Sv/h}$ ;
- 2011 – within the range of 0.079 -0.15  $\mu\text{Sv/h}$ .

They do not differ considerably from the values of the background radiation accepted as natural for the region.

Table 3.9.1-1 presents data on the radiation background at three points of the Danube outside the Kozloduy NPP for the period 2003 to 2008. Points of measurement are consistent network of the ExEA for radiological monitoring in the 30-km zone of the plant.

**Table 3.9.1-1 Data for the gamma background at three points of the Danube in the area of Kozloduy NPP for the period 2003 to 2008**

Year	2003		2004		2005		2006		2007		2008	
Point	Gamma background μSv/h		Gamma background μSv/h		Gamma background μSv/h		Gamma background μSv/h		Gamma background μSv/h		Gamma background μSv/h	
	Min.	Max.	Min.	Max.	Min.	Max.	Min.	Max.	Min.	Max.	Min.	Max.
Danube River close to Kozloduy town	0.11	0.14	0.12	0.16	0.11	0.15	0.12	0.12	0.11	0.15	0.12	0.17
NPP Hot Channel	0.08	0.08	0.12	0.15	0.15	0.18	0.15	0.16	0.15	0.20	0.12	0.18
Danube River close to Oryahovo	0.12	0.12	0.12	0.16	0.15	0.17	0.14	0.17	0.14	0.20	0.11	0.18

The table shows that there were no background concentrations values of gamma background in the area of NPP "Kozloduy".

### **Gamma background radiation on the industrial site of KNPP**

Gamma background radiation on the site is measured and controlled in compliance with the methodology approved by the industrial laboratory of the “Site Monitoring” sector:

- at 30 control points of the site and RAW Storage and SNF with thermal luminescent dosimeters (TLD) for longer periods of time /three months/;
- in the region of the Repository for conventional municipal and industrial waste (RCMIW) once per week;
- in the region of drainage channels (Sanitary Sewage System, Main Drainage Channel) twice per year;
- at 2 base stations of the AISERC operating in continuous mode;
- if needed, at certain monitored points.

Values of the gamma background radiation measured every three months as the equivalent dose rate in 20 control points around the complex of RAW Storage vary for:

- 2009 – within the range of 0.094-0.87  $\mu\text{Sv/h}$  with average value 0.17  $\mu\text{Sv/h}$ ;
- 2010 – within the range of 0.076-0.24  $\mu\text{Sv/h}$  with average value 0.12  $\mu\text{Sv/h}$ ;
- 2011 – within the range of 0.091-0.18  $\mu\text{Sv/h}$  with average value 0.12  $\mu\text{Sv/h}$ .

A bigger value of 0.87  $\mu\text{Sv/h}$  is measured in the 4<sup>th</sup> quarter of 2006 at point 18 of the loop around RAW Storage, because at that time a bigger quantity of solid and liquid RAW stored in special BB Cubes were disposed there.

Values of the gamma background radiation measured every three months as the equivalent dose rate in 10 control points around the SNF SF vary for:

- 2009 – within the range of 0.085-0.16  $\mu\text{Sv/h}$ ;
- 2010 – within the range of 0.076-0.15  $\mu\text{Sv/h}$ ;
- 2011 – within the range of 0.083-0.15  $\mu\text{Sv/h}$ .

Values of the gamma background radiation measured every six months as the equivalent dose rate in 23 control points over the easement of the drainage channels and the water in them vary for:

- 2009 – within the range of 0.051-0.079  $\mu\text{Sv/h}$ ;
- 2010 – within the range of 0.052-0.21  $\mu\text{Sv/h}$ ;
- 2011 – within the range of 0.055-0.22  $\mu\text{Sv/h}$ .

Fluctuating radioactivity of the waste water and the deposits causes the differences of the measured values.

Values of the gamma background radiation measured every week as the equivalent dose rate in control points RCMIW vary for:

- 2009 – within the range of 0.057-0.013  $\mu\text{Sv/h}$  for 5153.5 m<sup>3</sup> disposed waste;

- 2010 – within the range of 0.057-0.083  $\mu\text{Sv/h}$  for 4422  $\text{m}^3$  disposed waste;
- 2011 – within the range of 0.058-0.079  $\mu\text{Sv/h}$  for 4836.6  $\text{m}^3$  disposed waste.

Review of the tables for gamma background radiation on the KNPP industrial facility beyond the controlled area shows that at the points of smaller values it is relatively constant for the periods of measurement and has been fluctuating in values and time at some points of measured higher values.

### 3.9.2 Non-ionizing radiations

#### Sources of non-ionizing radiation

Non-ionizing radiation is spreading electrical magnetic fields transferring energy, which is not in a condition to cause ionizing of the atoms and molecules of the substances, i.e. removal or adding of negatively charged particles - electrons. Electromagnetic field as a form of the existence of matter is a combination of electrical and magnetic fields that could be converted one into another. It is distributed as electrical magnetic waves of **length -  $\lambda$ , frequency -  $\gamma$ , and energy - E**. The relation between these values is:

$$\lambda = c / \gamma$$

and

$$E = h \gamma$$

where:

- **c** is the **velocity** of the light in vacuum  $\approx 300000 \text{ km/s}$
- **h** is the Plank constant  $\approx 4.13567 \text{ } \mu\text{eV/GHz}$

For the electromagnetic waves as well as for all other waves, the following phenomena are typical: interference, diffraction, reflection, refraction, interrelation with the substances. When their energy interrelates, in most cases it is transformed into heat causing changes in the living organisms as well. Changes are increased together with the increase of the wave frequency and the energy respectively.

Electromagnetic spectrum (fig 3.9.2-1) is the range of all possible electromagnetic emissions. It covers all possible frequencies considering that the radio waves, infrared emission, visual light and partially ultraviolet emission do not ionize the atoms and molecules.

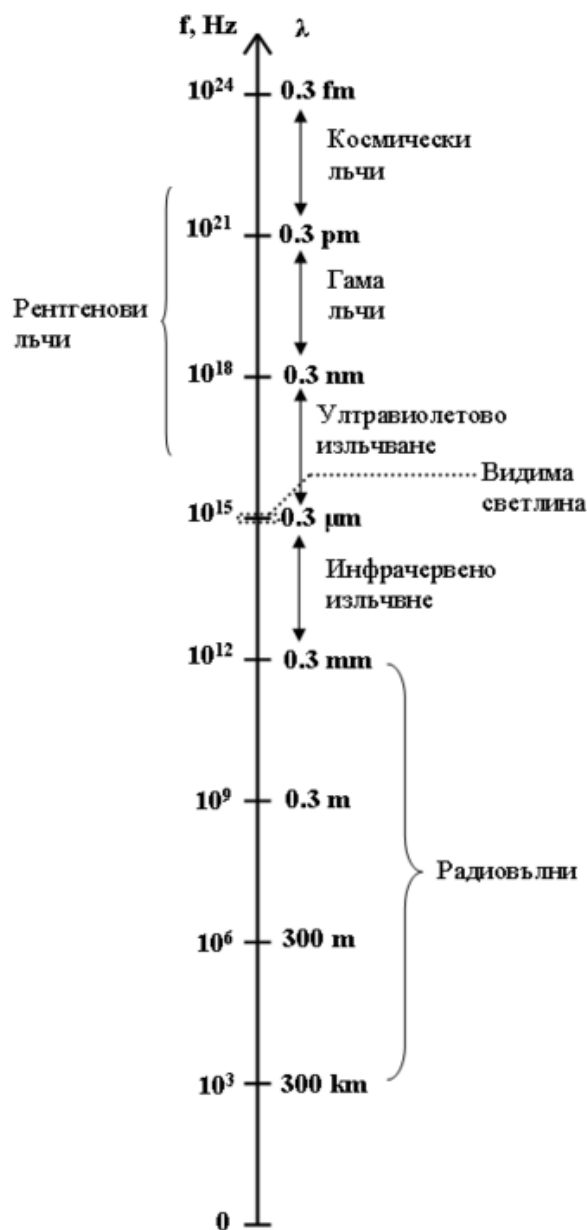

**Fig 3.9.2-1 Electromagnetic spectrum**

Legend:

- Рентгенови лъчи – Roentgen rays
- Космически лъчи – Space ray
- Гама лъчи – Gamma ray
- Ултравиолетово излъчване – Partially ultraviolet emission
- Видима светлина – Visual light
- Инфрачервено излъчване – Infrared emission
- Радиовълни – Radio waves

In the region of the currently operating NPP there are sources of electromagnetic fields (EMF) - low-and high-frequency, emitting from 0 Hz to 30 GHz.

The impact of the high frequency sources on the environment is regulated by the requirements of Ordinance 9/1991 for limit levels of electrical magnetic fields in populated territories and determination of hygiene protected areas around the emitting



sites. Promulgated in SG 35/1991 amended and supplemented issue 8/2002.

The impact by the low frequency sources of up to 300 Hz frequency on the environment is regulated pursuant to the requirements of Ordinance 7/1992 for the hygiene requirements of health protection of the populated environment, promulgated in SG issue 46/1992.

Considerable values of low frequency EMF (electrical magnetic fields) of frequency up to 300 Hz are formed around the operating:

- Substations, HV electric power lines, electrical motors and other electrical machines;
- Generators, transformers, switchyards and switchgears as well as around the bus bars of the circuit breakers;

Other sources of electrical magnetic radiation of frequency up to 300 kHz are:

- Video monitors;
- Automated control systems and electricity generation systems;
- Video displays.

EMF sources of radio frequencies and higher frequencies used in NPP are:

- Security systems;
- Mobile connection systems including the mobile communication systems, base stations etc.
- Emergency notification systems including transmitters, mobile systems etc.
- All sources of EMF needed for the operation of KNPP are regulated by the appropriate permissions to use. Effects of EMF emitted from the sources on the environment are constant, non-cumulative, limited to the regulations imposed by legal requirements and do not affect the territory of Romania.

### 3.9.3 Noise

Noise pursuant to the Law for protection of the environment against the noise means not desired or harmful outside sound caused by the human activity, including the noise emitted by the transport vehicles of the motor, railway and air transport, **by installations and equipment of the industry**, including the categories of industrial activities pursuant to Appendix 4 to Article 117, Para 1 of the Environmental Protection Act and by local noise sources.

In terms of physics noise is a combination of sounds of different frequency. Sound is created by a mechanical vibration of certain frequency in a material flexible environment. This vibration starts from the sound source and is distributed as consequent concentration and dissolution of the material particles called sound wave.

Physical values typical for the sound (noise) are as follows: sound pressure, sound power, sound speed, length of the sound wave, frequency. In order to assess the risk from noise impact, considering the exposure, the term equivalent noise level  $L_{eq}$  has been introduced.

Typical for the distribution of the sound waves are the phenomena interference,

diffraction, refraction, reflection etc.

With electrical and heat production in KNPP the noise as a physical factor occurs mostly in the work environment, but it is also distributed in the surrounding environment.

Since in this case the noise sources as well as the objects and subjects of considerable impact are located in the atmospheric air component, the analyses and assessments will be valid for that component only.

Sources of considerable noise in the environment established by the measurements from the power plant are: steam ejector machines, turbine generators, steam collectors, feed water and condensate pumps etc. internal transport, aspiration systems, ventilation systems, pneumatic and transportation systems, air blown compressors etc. In many cases the main reasons for the high noise levels in the environment are the design features of the machines and equipment (high revolutions, considerable velocity of fluid motion, resonance phenomena), as well as the big noise conductivity of the buildings, foundations, equipment etc.

Generated noise is constant with low and average velocity, during day and night, mixed from time to time with pulsing one.

At the borders on the site of NPP, which is an industrial area, in accordance with Ordinance № 6 on the indicators of environmental noise (SG 58/2006) the equivalent noise levels should not exceed 70 dB(A) during daytime, evening and night (for production and storage areas and zones), and in places of influence (residential areas and zones) – 55 dB(A) during daytime, 50 dB(A) in the evening and 45 dB(A) at night.

The noise impact of the power plant on the environment has been assessed in accordance with the regulations, within the limits and along the borders of the operational area and in the places of influence.

Measurements of noise levels and accompanying definitions are made for the purpose of EIA according to the "Methodology for determining the total sound power emitted into the environment from an industrial plant and determining the level of noise at the place of impact" of the MEW, after it has been found that it can be applied. Interpretation of results has been carried out in accordance with the requirements of Regulation 6 26.06.2006 on the indicators for environmental noise, taking into account the degree of discomfort in different parts of the day and night, limit values of indicators of environmental noise, methods of assessing the performance levels of noise and harmful effects of noise on health.

For definitions and measurements (protocols for own measurements 618, 621 of 13.09.2010) two measuring circuits are chosen:

- The first circuit with 30 measuring points comprises electricity production-1 (EP-1), including reactors 1-4 and adjoining facilities - significant sources of noise;
- The second circuit with 30 measuring points comprises electricity production - 2 (EP-2), including reactors 5 and 6 and adjoining facilities - significant

sources of noise.

During measurements in the area of electricity production-1 (EP-1) comprising Units 1 to 4 the following major sources of environmental noise were in operation: EP-1, system for gas cleaning, systems for ventilation and conditioning, MCR, sprinkler pools, cooling transformers close to portal 4 of the main switchyard, intradepartmental transport. The noise of them except for interdepartmental transport is constant with low and medium frequency, day and night.

The measured values of equivalent noise levels at measuring points located on the first circuit and recorded in test report 618/13.09.2010 ranged from 47.4 dB (A) to 62.5 dB (A). Moreover, the limit of 70 dB (A) defined by the ordinance for production and storage areas and zones is not exceeded in any measuring point of the circuit, which is also the case along the boundaries of the operational site. In this case the level of overall sound power of noise sources located in the circuit and nearby is set at 113.7 dB (A).

During measurements in the area of electricity production-2 (EP-2) comprising Units 5 and 6, the following major sources of environmental noise were in operation: systems maintaining the status of the shutdown EP-1, primary and auxiliary equipment of Units 5 and 6, during normal operation of electricity production, water and gas purifying systems, systems for ventilation and conditioning, MCR, sprinkler pools, cooling transformers, compressor station, pumping stations, intradepartmental transport. The noise of them is constant with low and middle frequency, day and night, mixed occasionally with impulse one.

The measured values of equivalent noise levels at measuring points located on the second circuit and recorded in test report 621/13.09.2010, during normal operation of Units 5 and 6 range from 47.3 dB (A) to 66.6 dB (A). Moreover, the limit of 70 dB (A), defined by the ordinance for production and storage areas and zones, is not exceeded in any measuring point of the circuit, which is also the case along the boundaries of the operational area. In this case the level of overall sound power of noise sources located in the circuit and nearby is set at 119.1 dB(A).

The defined values of equivalent level of noise in the impact areas based on the indicated methodology are:

- For Kozloduy City from EP-1 43.6 dB(A), and from EP-2, 46.8±2 dB(A);
- For the island Kopanitsa-Romania from EP-1 40.5 dB(A), from EP-2 - 39.5 dB(A);
- For Bechet City – Romania from EP-1 31.5 dB(A), from EP-2 27.9 dB(A);
- For Harlets village from EP-1, 41.7 dB(A), from EP-2 37.8 dB(A);
- For Glojene village EP-1, 39.7 dB (A), and EP-2 36.2 dB (A).

Only in the town of Kozloduy the equivalent noise levels of EP-2 exceed the limit value of 45 dB (A) for night time, but given the error of ± 2 dB (A), it cannot certainly be argued that there is an excess.

The impact of sound waves that are emitted from noise sources located in NPP on the environment is limited and within the regulations imposed by the legal requirements of the Republic of Bulgaria.

Noise impact in this case and in accordance with the regulations on the territory of Romania is defined as insignificant.

### **3.9.4 Vibrations**

Vibrations are vibrating material points or bodies towards one balanced position. Vibration can be simple, but in most cases it is complicated with a lot of components of different frequencies.

Generally, depending on their time characteristics, the vibrations can be: **periodical, short-term, long-term**. Depending on the acting force they could be **forced** or **free**.

Vibrations are useful in some production processes, while in other cases they are harmful and can cause wearing of components and industrial accidents. When vibrations are transmitted to the human organism, they could harm it.

As for their immediate (local) impact on the machines and facility operators, the vibrations have been well studied and presented in the literature. Bulgarian and international standards and the respective sanitary codes have been implemented for such impact. Measurements are made of vibration rate, vibration acceleration, amplitude at different vibration frequencies.

Vibrations spread similar to noise (sound) in the components of the environment at different speed as kinetic energy, which is finally transformed into some other types. Due to the lack of data from measurements and for vibrations generated by KNPP or different machines and equipment, the environmental condition could not be described in regard of this factor during realization of this IP.

## 3.10 Protected zones and protected areas

### 3.10.1 Protected Areas under NATURA 2000 in the region of KNPP

Kozloduy Islands PA, code BG0000533, under the Directive on the conservation of natural habitats and of wild fauna and flora;

Zlatiata PA, code BG0002099, under the Directive on the conservation of wild birds;

Ogosta River PA, code BG0000614, under the Directive on the conservation of natural habitats and of wild fauna and flora;

Skut River PA, code BG0000508, under the Directive on the conservation of natural habitats and of wild fauna and flora.

According to the register of protected areas and protected zones in Bulgaria (ExEA, RIEWs Vratsa, RIEWs Montana) within the 30-km range of the impact of IP includes the following sites by BDA NATURA 2000

#### **Under the Directive on the conservation of wild birds 2009/147/EO:**

- Zlatiyata PA, BG0002009
- PA „Swamp Tsibar”, BG0002104
- Island Ibisha PA, BG0002007
- Island in Gorni Tsibar PA, BG0002008

#### **Under the Directive on the conservation of natural habitats 92/43/EEC:**

- Islands Kozloduy PA, BG0000533
- Ogosta River PA, BG0000614
- Skut River PA, BG0000508
- Kozloduy PA, BG0000527
- Tzibar PA, BG0000199
- Zlatiyata PA, BG0000336

According to the ToR for EIA in accordance with the documents submitted by the investor, should be considered the following protected areas:

- Zlatiyata PA Code BG0002009, under the Directive on the conservation of wild birds 2009/147/EEC;
- Islands Kozloduy PA, Code BG0000533, under the Directive on the conservation of natural habitats 92/43/EEC;
- Ogosta River PA Code BG0000614, under the Directive on the conservation of natural habitats 92/43/EEC;
- Skut River PA Code BG0000508, under the Directive on the conservation of natural habitats 92/43/EEC;
- Kozloduy PA Code BG0000527, under the Directive on the conservation of

natural habitats 92/43/EEC

- Cibar PA Code BG0000199, under the Directive on the conservation of natural habitats 92/43/EEC.

**The main objectives** of the protection in the Protected areas are as follows:

- Protection of the area of the natural habitats and habitats of species and their populations subject to protection within the framework of the protected area;
- Protection of the natural condition of the natural habitats and habitats of species subject to protection within the framework of the protected area including the ones of the typical for this habitats composition of species, typical species and environmental conditions;
- Restoration, if needed, of the area and natural condition of the priority natural habitats as well as of populations of species subject to protection within the protected area;

### 3.10.1.1 Protected area "Kozloduy Islands", BG0000533

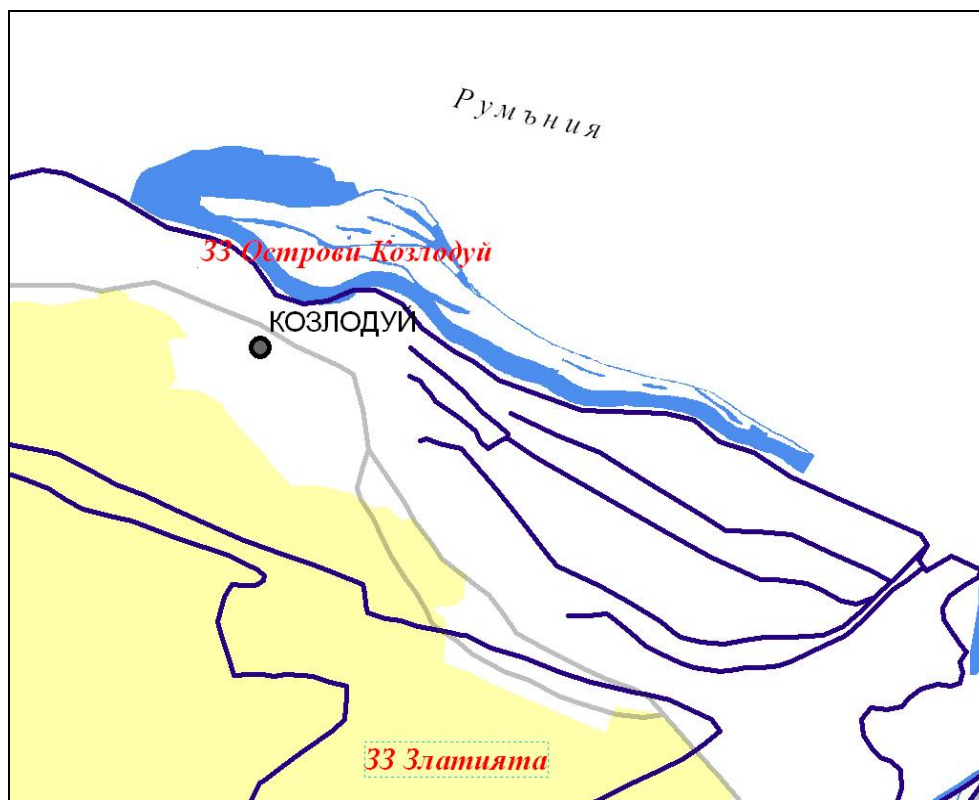

**Fig. 3.10.1-1 Protected Area BG0000533 Kozloduy Islands**

Legend:

- 33 Златията - PA Zlatiyata
- 33 острови козлодуй - PA Kozloduy Island
- Козлодуй -Kozloduy
- Румъния - Romania

Protected Area is under the Habitats Directive 92/43/EEC [39], but it also contains an



area protected under the Birds Directive. The area of the Protected Area is 605.67 ha. It is located within the range of 20 and 34 m height. In class of land covering in percentages the territory is allocated as follows:

Classes of land covering	% Covering
Coastal sand dunes, sandy beaches	9
Water inland areas (still and running waters)	33
Swamps, marshlands, vegetation alongside the banks of water basins, bogs	4
Shrubby communities	12
Broad-leaved deciduous forests	7
Artificial forest monoculture (e.g. plants of poplars or exotic trees)	34
<b>Total coverage</b>	<b>100</b>

**Overall characteristic of the area** - Area includes three larger islands. About 70 % of the Kozloduy Islands are covered by forest plants. The western part of Svraka Island is covered with sandy deposits. The site is of medium to high conservation value. The northern part of the Svraka Island and the foreland of the Kozloduy Island are comparatively not affected by the human activity. The southern part of the Svraka Island and the tail of the Kozloduy Island are endangered by the invasion of introduced wood and shrubby species. In the protected area the natural forests of *Salix alba*, *Ulmus minor* and *Populus nigra* are preserved.

In the standard form of the area the following habitats and species are included as subject to protection:

**TYPES OF HABITATS from Appendix I of Directive 92/43/EEC**

CODE	NAME	% Coverage	Represent.	Relative area	Equated extent	Total assessment
91E0	* Alluvial forests of <i>Alnus glutinosa</i> and <i>Fraxinus excelsior</i> (Alno-Pandion, <i>Alnion incanae</i> , <i>Salicion albae</i> )	21.305	B	C	B	B
3130	Olithotrophic to mesotrophic standing waters with vegetation of <i>Littorelletea uniflorae</i> and/or <i>Isoeto-Nanojuncetea</i>	6	B	C	A	A
3270	Rivers with muddy banks with <i>Chenopodion rubri</i> and <i>Bidention p.p.</i>	3	B	C	B	B
91F0	Riparian mixed forest of <i>Quercus robur</i> , <i>Ulmus laevis</i> and <i>Fraxinus excelsior</i> or <i>Fraxinus angustifolia</i> along the great rivers ( <i>Ulmenion minoris</i> )	0.0933	D	C		

Note: The \* symbol denotes a habitat type which is of priority importance as far as its protection is concerned.

In the table an assessment of each habitat using the following indicators is shown:

*Representativeness* /provides indication how far a certain habitat is "typical"/. The following classification system is used: A-excellent representativeness; B-good representativeness; C- considerable representativeness; D- negligible existence;

*Relative area*/area of the site covered by a certain habitat compared with the total area of the national territory covered by this habitat/. Intervals used in classes are as follows: A)  $100 \geq p > 15 \%$ ; B)  $15 \geq p > 2 \%$ ; C)  $2 \geq p > 0$ ;

*Equated extent*/the extent of protection of structure and function of certain habitat and possibility for its restoration is assessed/. The following classification system is used: A-excellent protection; B-good protection; C-average or weak protection.

*Total assessment* of the site value for protection of a certain type of natural habitat/integrated, assessment of the previous criteria considering their different weight for the examined habitat. The following classification system is used: A-excellent value; B-good value; C- important value.

**Habitat 91 E0** - Alluvial forests with *Alnus glutinosa* and *Fraxinus excelsior* (*Alno-Pandion*, *Alnion incanae*, *Salicion albae*) is formed on rich, alluvial soils that are periodically flooded during the seasonable increase of the level of the Danube River. In the formed riverside, in flooded forests mostly the species of *Salix alba*, *Populus alba*, *Populus nigra* and *Salix fragilis* dominate. Vegetation communities are involved in the cenose of *Salicion albae*. The communities involve also species of *Ulmus laevis*, *Ulmus minor*, *Quercus robur*, *Rubus caesius*, *Clematis vitalba*, *Humulus lupulus*, *Vitis sylvestris*, *Solanum dilcamara*, *Euphorbia lucida*, *Lythrum salicaria*, *Phragmites australis*, *Typha latifolia*, *Leucojum astivum* etc.

**Habitat 91 F0** - Riverside mixed forests of *Quercus robur*, *Ulmus laevi* and *Fraxinus excelsior* or *Fraxinus angustifolia* alongside big rivers (*Ulmenion minoris*) is formed on newer periodically flooded alluvial depositions. Vegetation communities are usually related to the association *Scutellario altissimae-Quercetum roboris*. Participation of the lianas is relatively small comparing with the dense forests and the grass covering is of well formed spring nature of *Scilla bifolia*, *Anemone ranunculoides*, *Ranunculuc ficaria*, *Polygonatum ssp.* etc

Vegetation types, natural habitats and species subject to protection in the protected area are described in detail in the Compatibility assessment.

### 3.10.1.2 Protected Area “Zlatiyata”, Code: BG0002009

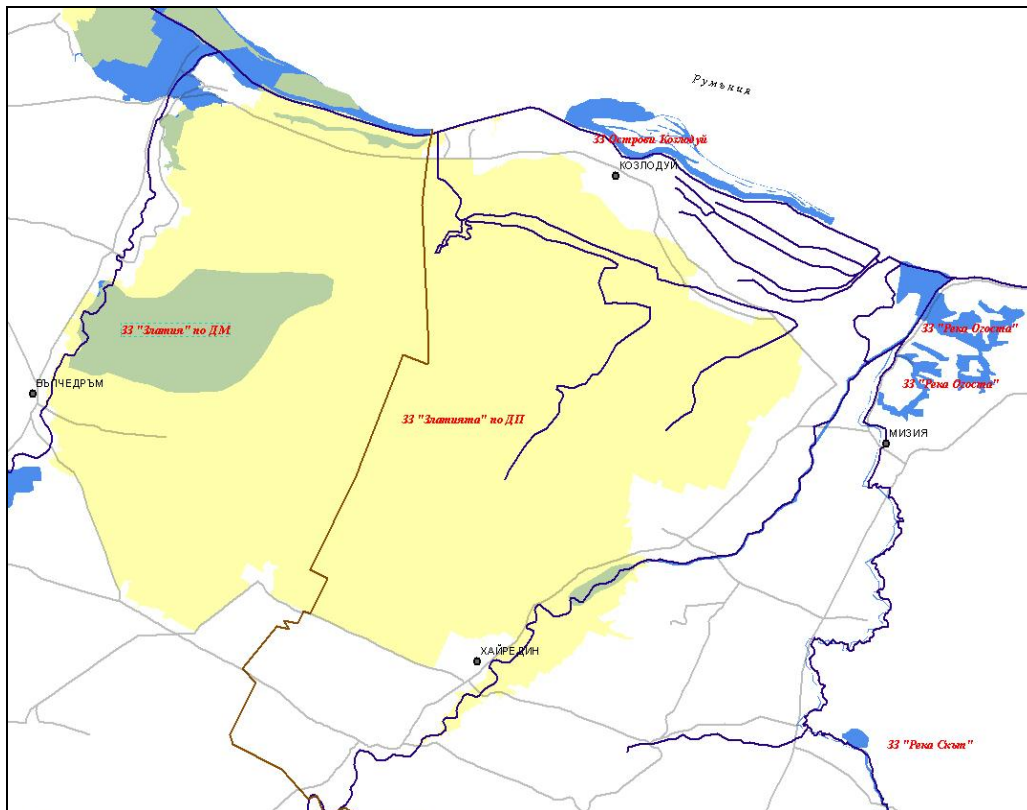

**Fig. 3.10.1-2 Protected Area BG0002009 Zlatiyata**

Legend:

- 33 Златията- PA Zlatiyata
- 33 Острови Козлодуй - PA Kozloduy Island
- 33 река Огоста - PA Ogosta River
- Козлодуй - Kozloduy
- 33 Цибър -PA Tsibar

Protected Area BG0002009 Zlatiyata under the Bird Directive covers an area of 434944.40 ha. In class of land covering, in percentages the area is allocated in the following groups:

Land cover classes	% Coverage
Water inland areas (not running and running waters)	1
Shrubby communities	0
Dry grass communities, steppe	4
Extensive grain crops (including rotation crops periodically let lie fallow)	90
Other plough land	0
Broad-leaved deciduous forests	1
Not forest regions, cultivated with wood vegetation (incl. fruit trees, vineyard, hedges)	1
Rocks within the island, taluses, sands, permanent snow and glaciers	0
Other lands (including towns, villages, roads, dumping-ground, mines, industrial sites)	3
<b>Total Covering</b>	<b>100</b>

The area is related to the following other sites of Natura 2000:

<i>Code</i>	<i>Name Type</i>	
BG0000614	Ogosta river	K
BG0000199	Tsibar	K
BG0000527	Kozloduy	G
BG0000336	Zlatia	K

**General characteristics** PA BG0002009 Zlatiata is located in the north-west of Bulgaria, in the Danube valley between the Danube River and the town of Kozloduy to the north, road connecting the town of Vulchedrum and Hayredin to the south and flows of the rivers Tsibritsa and Ogosta from the west and east. It is located on tableland-like leveled land with outdoor grass areas of steppe type and agricultural areas. At some places there are earth loess walls and low trees and bushes, mainly of Common Hawthorn /*Crataegus monogyna*/, dog rose /*Rosa canina*/ and etc. On the ground walls there are plenty of Begonia Altissima /*Ailantis altissima*/. On the territory of the Zlatia Shishmanov Val Dam is located. Also, there are spread pastures, fruit gardens, vineyards, field protection belts and small forests of broad-leaved trees as well as river-side forests alongside the Ogosta River.

There are 122 bird species determined, 28 of which are entered into the Red book of Bulgaria and 53 types are of European Environmental Protection Importance (SPEC) (BirdLife International, 2004). As worldwide endangered ones category SPEC1 include 5 types and as endangered in Europe category SPEC2 includes – 15 and category SPEC3 – 36 species. The place is one of the most important in the country, which are also important for the European Union related mainly to the outdoor areas – White Stork /*Ciconia ciconia*/, Marsh Harrier /*Circus aeruginosus*/, Montagu's Harrier /*Circus pygargus*/, Levant Sparrowhawk /*Accipiter brevipes*/, Red-Footed Falcon /*Falco vespertinus*/, Twany Pipit /*Anthus campestris*/, Greater Short-toed Lark /*Calandrella brachydactyla*/, Ortolan Bunting /*Emberiza hortulana*/ etc. In Zlatiata there are considerable nesting populations of bee-eater /*Merops apiaster*/, Skylark /*Alauda arvensis*/, Common Quail /*Coturnix coturnix*/. This is the only place in Bulgaria where the Great Bustard /*Otis tarda*/ could be seen. During the winter in Zlatiata there is another endangered species that could be seen – Lesser white-fronted goose /*Anser erythropus*/, which uses the fields for feeding together with the flocks of Great white-fronted goose /*Anser albifrons*/.

Zlatiata is the biggest compacted not populated plain territory in the country. It is affected by human activities that are mainly related to the agriculture, forest management and development of the infrastructure. Intensification of the agriculture, use of pesticides and fertilizers, removal of green fences and bushes are the activities having the most serious negative quality on the habitats. Cutting of the river-side forests and trees lead to fast and sharp reduction of the population of the red-footed falcon, because of the elimination of nesting places.

In 1997 a small territory is nominated by the BirdLife International as Ornithological Important Place. In 2005 the entire territory of Zlatiata is nominated as Ornithological important place.

The species subject to protection are described in detail in the Compatibility

assessment.

### 3.10.1.3 Protected Area BG0000614 Ogosta River

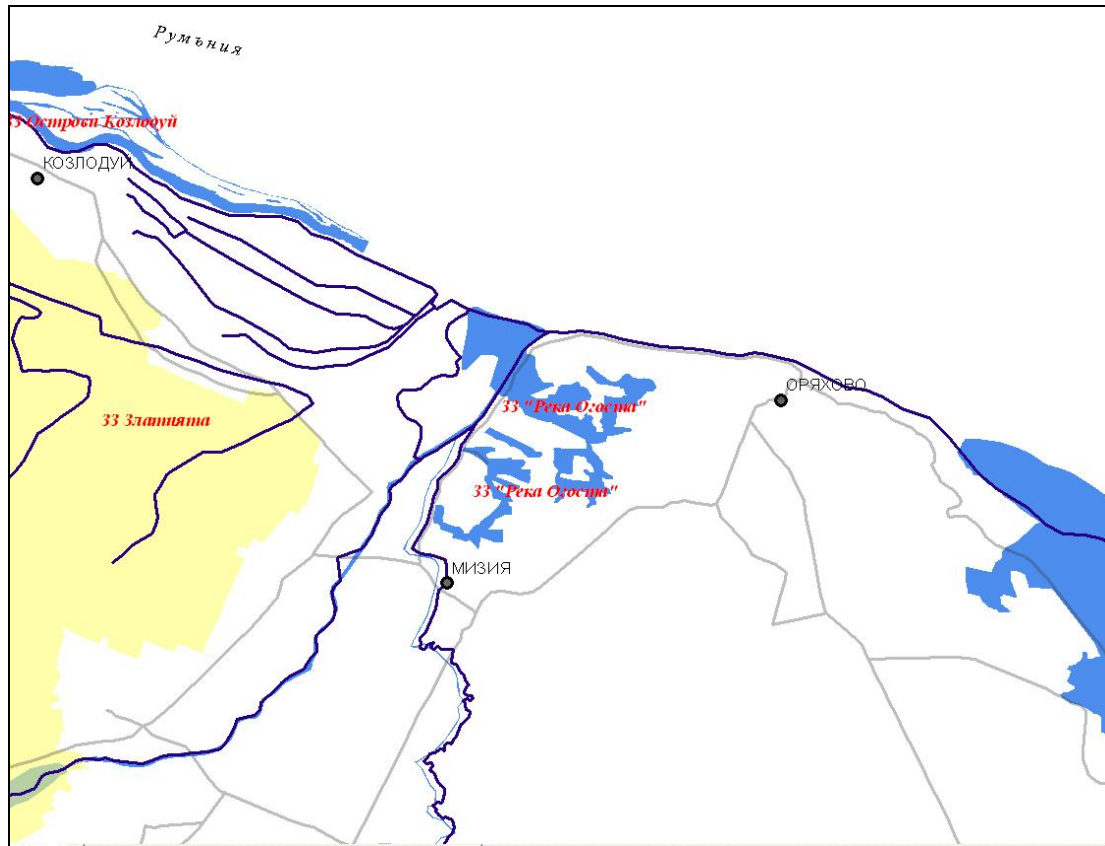

**Fig. 3.10.1-3 Protected area BG0000614 Ogosta River**

Legend:

- 33 Златията- PA Zlatiyata
- 33 Острови Козлодуй -PA Kozloduy Island
- 33 река Огоста - PA Ogosta River
- Козлодуй -Kozloduy
- Мизия - Miziya
- Оряхово - Oryahovo
- Румъния - Romania

Protected Area BG0000614 Ogosta River is a K-type PA under the Directive 92/43/EEC on the Conservation of natural habitats and of wild fauna and flora. The total area covered by this PA is 12532.40 ha. Its altitude varies between 19 and 183 m. The PA is connected to other protected areas under NATURA 2000:

Code	Name	Type
BG0000508	Skut River	E
BG0002009	Zlatiata	J

The PA is connected also with one protected territory:

Name	Category	T%
Daneva mogila	Protected countryside *	0.02

Name – name of the protected territory. Category – category of the protected

*territory according PAA. T (type of overlapping) = full overlapping; + totally in Natura 2000 area; \* - the two sites a (PT and PA) are partly overlapped; /neighborhood; % - rate of coverage in reference of the Natura 2000 area.*

**General characteristics** The protected area includes the riverbed and the banks of the Ogosta River. The banks of the Ogosta River are reinforced, the bottom is covered with a lot of sediments and the water is eutrophic, which is a consequence of the impact of the dam near the Town of Montana. The accumulation of sediments and the eutrophic water are the reason for the formation of habitats 3260 and 3270, which are of Community importance. Near the Village of Kriva Bara, there are the remnants of an old riverbed which is 5 km long and which has turned into a eutrophic lake with macrophytes. The Protected Territory “Daneva Mogila” established by Order 413 of 10.05.1982 is located on the right bank of the Ogosta River. This is a place of spectacular scenery and with a group of old trees of *Quercus robur*. The Blatoto Area (Swamp Area) (3150) is located near the mouth of the Ogosta River. The last 4-5 km of the riverbed of the river are overgrown by aquatic vegetation (3260) and are rich in fish. On the slopes of the marshland to the west of the Town of Oryahovo, there is Panonian loess steppe vegetation\* (3260) with a diverse flora and fauna.

The standard form for the area as an object of protection includes the following habitats:

**HABITAT TYPES from appendix I of the Directive 92/43/EEC**

Code	Name.	% Cov..	Repres..	Rel. cov.	Nat. v..	Total ass.
91E0	* Alluvial forests with <i>Alnus glutinosa</i> and <i>Fraxinus excelsior</i> (Alno-Pandion, Alnion incanae, Salicion albae)	0.232	A	C	A	A
3150	Natural eutrophic lakes with vegetation of Magnopotamion or Hydrocharition type	7.4	A	C	A	A
3260	Lowland and mountain rivers with vegetation of Ranunculion fluitantis and Callitriche-Batrachion type	0.2	A	C	A	A
3270	Rivers with muddy banks with <i>Chenopodium rubri</i> and <i>Bidention</i> p.p.		0.2	A	C	A
6250	* Panonski loess steppe grass communities	9.553	A	C	A	A
91Z0	Moesian silver lime woods	0.537	D	C		

Vegetation types, natural habitats and species subject to protection in the protected area are described in detail in the Compatibility assessment.



### 3.10.1.4 Protected Area BG0000508 Skut River

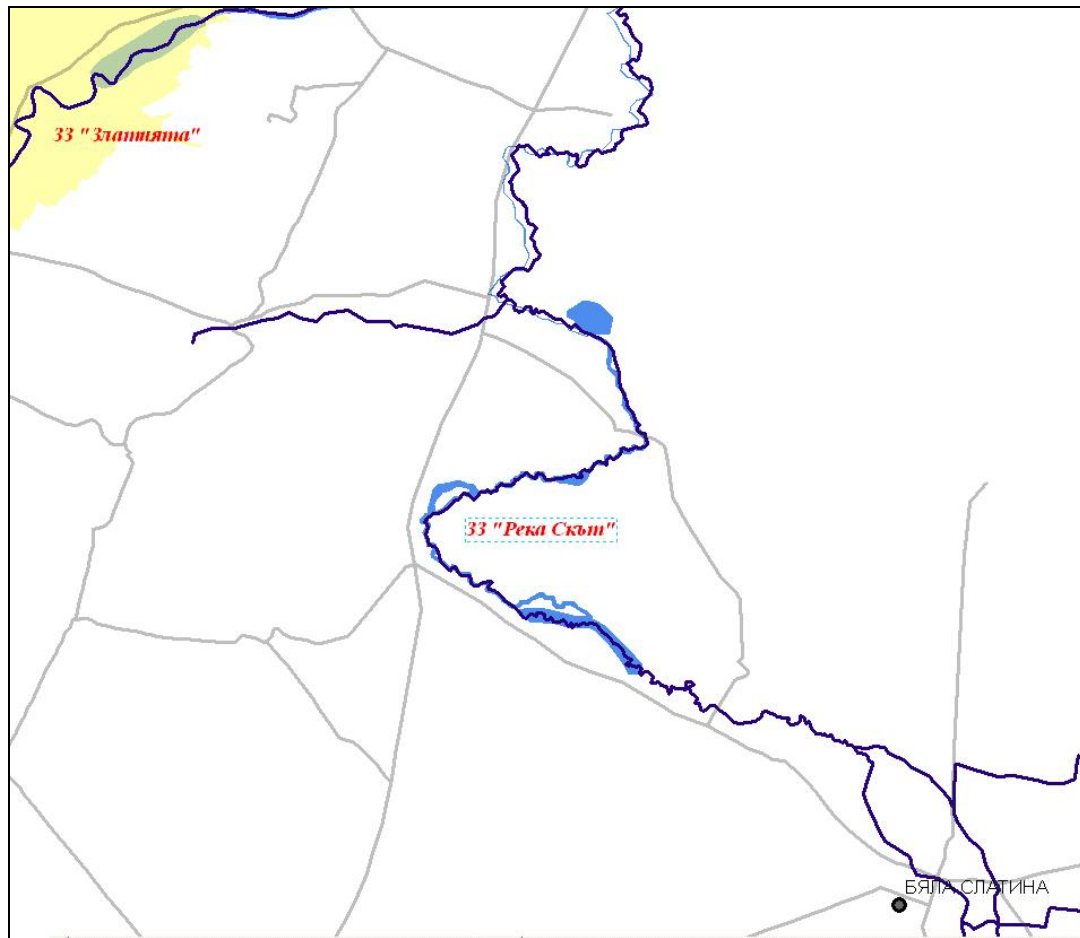

**Fig. 3.10.1-4 Protected Area BG0000508 Skut River**

Legend:

- 33 Златията -PA Zlatiyata
- 33 река Скът - PA Skut River
- Град Бяла Слатина- Vyala Slatina town

Protected Area BG0000508 Skut River is an E-type PA under Directive 92/43/EEC on the Conservation of natural habitats and of wild fauna and flora. The total area covered by the PA is 4085.90ha. Its altitude varies between 24 and 141 m. The PA is connected to other protected areas under Natura 2000:

Code	Name	Type
BG0000614	Ogosta River	K

**General characteristics** The Skut river is a right-hand tributary of the Ogosta river. Between the Villages of Tarnava and Altimir along the riverbed, there is a relatively broad belt of *Salix alba*, *Populus nigra*, *Populus alba*, *Quercus robur* and *Fraxinus oxycarpa* (91E0). 2 km to the north of Altimir, there is a dense forest of *Fraxinus oxycarpa* (91F0) with a high conservation value. Part of the river in the region of Altimir is one of the few remaining habitats of *Gobio anoscopus*. This area is important for the conservation of salt meadows, a small preserved flooded forest and

several steppe communities of the rare, endemic species of the Star thistle (*Centaurea rumelica*).

In class of land covering, in percentages the area is allocated in the following groups:

<i>Land cover classes</i>	<i>% Coverage</i>
Water inland areas (not running and running waters)	3
Shrubby communities	3
Dry grass communities, steppe	18
Extensive grain crops (including rotation crops periodically let lie fallow)	36
Improved pastures (artificial grass mixtures)	28
Broad-leaved deciduous forests	12
<b>Total Covering</b>	<b>100</b>

In the standard form of the Protected Area the following types of habitats and species are included:

**HABITAT TYPES from appendix I of the Directive 92/43/EEC**

<i>Code</i>	<i>Name</i>	<i>% Cov.</i>	<i>Repr.</i>	<i>Rel. cov.</i>	<i>Nat.v.</i>	<i>Total ass.</i>
91E0	* Alluvial forests with <i>Alnus glutinosa</i> and <i>Fraxinus excelsior</i> (Alno-Pandion, Alnion incanae, Salicion albae)	2.205	A	C	A	A
1530	* Panonski salty steppes and salty marshlands	0.03	B	C	B	B
3260	Lowland and mountain rivers with vegetation <i>Ranunculion fluitantis</i> and <i>Callitricho-Batrachion</i>	0.06	D	C		
3270	Rivers with muddy banks with <i>Chenopodion rubri</i> and <i>Bidention p.p.</i>			D	C	
6250	* Panonski loess steppe grass communities	0.397	A	C	A	A
91F0	Riverside mixed forests with <i>Quercus robur</i> , <i>Ulmus laevis</i> and <i>Fraxinus excelsior</i> or <i>Fraxinus angustifolia</i> along big rivers (Ulmenion minoris)	9	A	C	A	A

Vegetation types, natural habitats and species subject to protection in the protected area are described in detail in the Compatibility assessment.

### 3.10.1.5 Protected Area „Kozloduy” BG0000527



**Fig. 3.10.1-5 Protected Area „Kozloduy” BG0000527**

Legend:

- 33 Златията- PA Zlatiyata
- 33 острови Козлодуй - PA Kozloduy Island
- 33 река Огоста- PA Ogosta River
- Козлодуй - Kozloduy
- Горни Цибър - Gorni Tsibar village
- Долни Цибър - Dolny Tsibar village
- Язовир Шишманов вал – Shishmanov val dam

The protected area „Kozloduy” is of type G under the Habitats Directive 92/43/EEC, which is contained in a protected area under the Birds Directive. The area of the protected area is 1253.80 decares and is located at an altitude between 62 and 142 m. In terms of land cover classes, the territory of the protected area is sub-divided into the following groups:

<i>Land cover classes</i>	<i>% Coverage</i>
Shrubby communities .....	8
Dry grass communities, steppe .....	48
Extensive grain crops (including rotation crops periodically let lie fallow) .....	7

Artificial forest monoculture (plantations of poplar or Exotic trees)..... 37  
**Total coverage ..... 100**

Protected area Kozloduy with code BG0000527 is connected with PA Zlatiata with code BG0002009 which is under Birds Directive.

General characteristics of the PA. The area is steep loess wall between the town of Kozloduy and the village of Gorni Tsibar. The crest of the wall is covered by steppe vegetation featuring some endemic species. Dominant species are *Stipa capillata*, *Artemisia campestris*; endemic species are *Centaurea rumelica*, *Stachys arenariaeformis*, *Chamaecytisus supinus*. The ridges there are many forest plantations, mainly from acacia. The site is one of the most important in Bulgaria for habitat 6250 Pannonian loess steppe grass communities. It has a typical floristic composition and participation of many endemic and relict steppe species like *Centaurea rumelica* and *Stachys arenariaeformis*. The area is heavily affected by human activity. Steppe vegetation is preserved only in the highest parts of the loess forms. The area is surrounded by farmland.

The standard form of the area as an object of protection indicates a habitat - 6250 \* Pannonian loess steppe grass communities.

The habitat occupies 48 % of the territory of the area and of European significance. The habitat is with significant representation. The relative area covered by the habitat referred to the total area of the national territory covered by this habitat is between 0 and 2 %.

Of the species listed in Annex I of Council directive 79/409/EEC and Annex II of Council directive 92/43 EEC [146] plant species are not included. The following animal species are listed: Romanian hamster – *Mesocricetus newtoni* and Skipjack Aesculapian/Elaphe quatuorlineata

To the Group “Other Important Vegetation and Animal Species” which are associated with the conservation and management of the site, the following plant species are included:

<i>Tx.group NAME</i>	<i>Local population</i>	<i>Motivation</i>
A <i>Bufo viridis</i>	P	C
P <i>Centaurea rumelica</i>	P	B
R <i>Coluber caspius</i>	P	C
R <i>Lacerta viridis</i>	P	C
A <i>Pelobates fuscus</i>	P	C
R <i>Podarcis muralis</i>	P	C
R <i>Podarcis taurica</i>	P	C
P <i>Stachys arenariaeformis</i>	P	B
R <i>Vipera ammodytes</i>	P	C

Where:

*Tx.group* – taxonomic group of the respective species is marked according to the following nomenclature: P – plants

*Name* – name of the species.

*Local population* – In the cases when there is no digital data available, the size/density of the population is shown, specifying whether the species are typical (C), rare (R) or extremely rare (V). When there are no data about the population, the species is marked as existing (P).

*Motivation* – motivation about inclusion of each species is indicated by using the following categories: A) National Red Book; B) endemic species; C) international conventions (incl. Bern, Bonn and Convention for biodiversity); D) other reasons.

### 3.10.1.6 Protected Area Tsibar BG0000199



ЗАЩИТЕНА ЗОНА "ЦИБЪР"

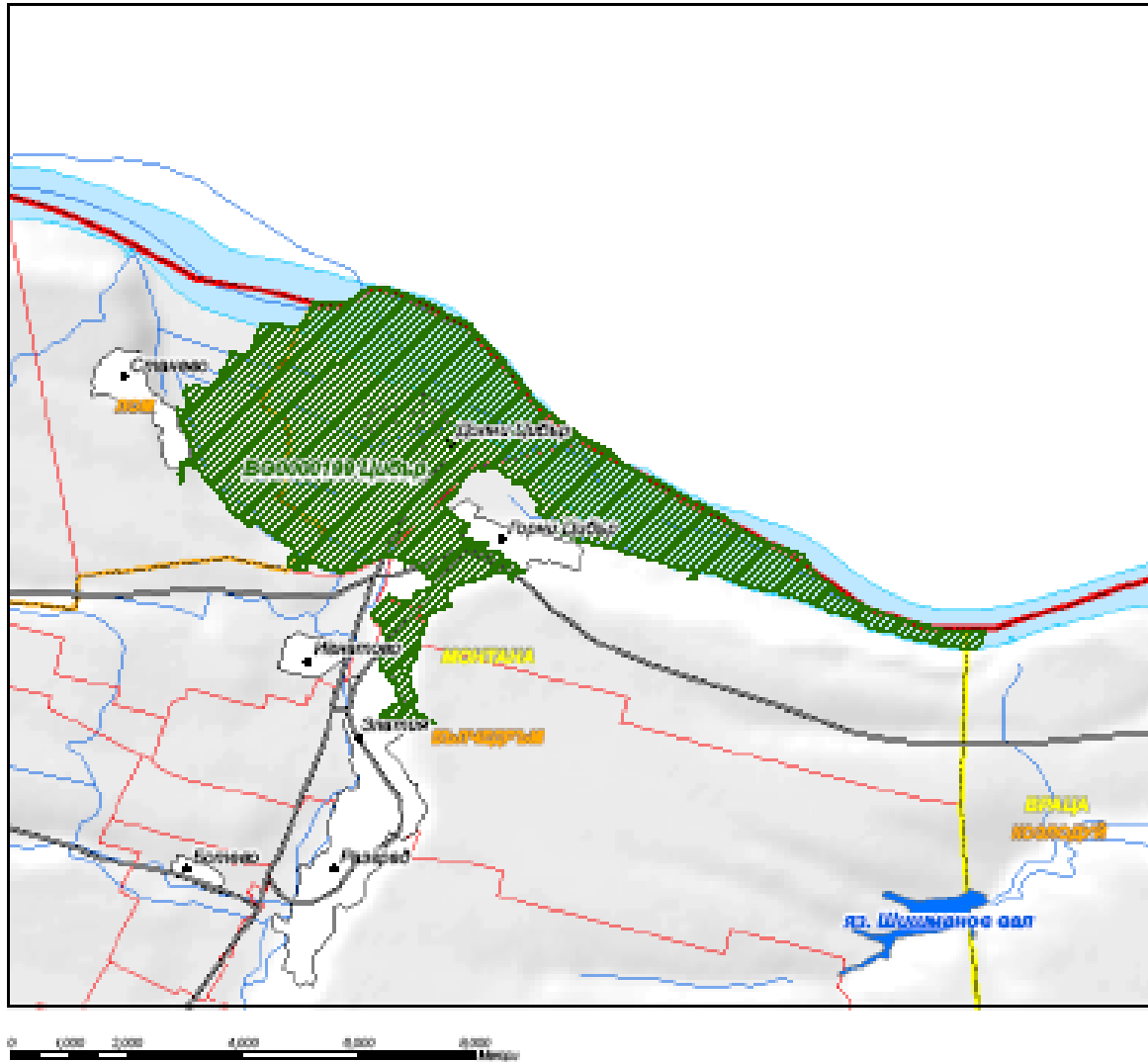

Fig. 3.10.1-6 Protected Area Tsibar BG0000199

Legend:

- 33 Златията- PA Zlatiyata
- 33 Острови Козлодуй - PA Kozloduy Island
- 33 река Огоста - PA Ogosta River
- Козлодуй - Kozloduy
- 33 Цибър -PA Tsibar
- Язовир Шишманов вал – Shishmanov val dam.

The protected area „Kozloduy” under the Habitats Directive 92/43/EEC, which is contained in a protected area under the Birds Directive. The area of the protected area is 29717.30 decares and is located at an altitude between 20 and 169 m:



<i>Land cover classes</i>	<i>% Coverage</i>
Salt marshes, salt meadows, salt steppes.....	7
Inland water (standing water, running water).....	25
Swamps, marshes, vegetation along the ponds, bogs.....	7
Shrubby communities.....	2
Dry grass communities, steppe .....	6
Extensive grain crops (including rotation crops periodically let lie fallow) .....	33
Broadleaf deciduous forest .....	5
Artificial forest monoculture (plantations of poplar or Exotic trees).....	13
Non-forest areas cultivated with woody plants (including orchards, vineyards, roadside trees) .....	2
<b>Total coverage .....</b>	<b>100</b>

Protected area is related to the following Natura 2000 sites:

Object code	Object Name
BG0002007	Island Ibisha
BG0002008	Island in Gorni Tszibar
BG0002009	Zlatiyata
BG0002104	swamp Tszibar

The protected area covers completely maintains reserve Ibisha.

General characteristics of the PA. The site is one of the richest in different habitat types in Bulgarian bank of the Danube. This is the former floodplain of the Danube, one large and several small new island covered with floodplain forests. There are specific island sand dunes, salt meadows and marshes in the valley. Small loess steppes have survived highest Danube terrace near the village Zlatia. Many ducks and gulls concentrate on the sandy beaches that are formed during the summer. During the winter time at the sites Dalmatian pelicans spend the winter. On a sandy beach has and a colony of terns. The site protects rare habitat for Bulgaria like 2340, 6250, 1530. There is a large mixed colony of water birds on the island Ibisha. The protected area covers completely supportive reserve Ibisha.

The standard form of protected area includes the following habitat types, object of protection:

**TYPES OF HABITATS from Appendix I of Directive 92/43/EEC**

CODE	NAME	% Coverage	Represent.	Relative area	Equated extent	Total assessment
1530	* Pannonian salty steppes and salty marshlands	7	C	C	C	C
2340	* Pannonian Inland dunes	5	C	B	C	C
3130	Olithotrophic to mesotrophic standing waters with vegetation of Littorelletea uniflorae and/or Isoeto-Nanojuncetea	1	B	C	B	B
3150	Natural eutrophic lakes with vegetation type Magnopotamion or Hydrocharition	0.2	C	C	C	C
3270	Rivers with muddy banks with Chenopodion rubri and Bidention p.p.	1	C	C	C	C
6250	* Pannonian loess steppe grass communities	2.343	B	C	B	B
91E0	* Alluvial forests of Alnus glutinosa and Fraxinus excelsior (Alno-Pandion, Alnion incanae, Salicion albae)	0.35	A	C	B	A

**Of the species listed in Annex I of Council directive 79/409/EEC and Annex II of Council directive 92/43/EEC**

Regularly occurring migratory birds, which are included in Annex I of the Birds Directive

Code Name

A097 *Falco vespertinus*

A195 *Sterna albifrons*

A234 *Picus canus*

A238 *Dendrocopos medius*

A393 *Phalacrocorax pygmeus*

A439 *Hippolais olivetorum*

A177 *Larus minutus*

A193 *Sterna hirundo*

A429 *Dendrocopos syriacus*

A094 *Pandion haliaetus*

A034 *Platalea leucorodia*

A031 *Ciconia ciconia*

A020 *Pelecanus crispus*

A030 *Ciconia nigra*

A026 *Egretta garzetta*

A024 *Ardeola ralloides*

A023 *Nycticorax nycticorax*

A229 *Alcedo atthis*

A176 *Larus melanocephalus*

2.b. Regularly occurring migratory birds not listed in Annex I of the Birds Directive.

Code Name

A162 *Tringa totanus*  
A161 *Tringa erythropus*  
A147 *Calidris ferruginea*  
A145 *Calidris minuta*  
A142 *Vanellus vanellus*  
A136 *Charadrius dubius*  
A230 *Merops apiaster*  
A099 *Falco subbuteo*  
A149 *Calidris alpina*  
A054 *Anas acuta*  
A053 *Anas platyrhynchos*  
A052 *Anas crecca*  
A051 *Anas strepera*  
A050 *Anas penelope*  
A048 *Tadorna tadorna*  
A028 *Ardea cinerea*  
A017 *Phalacrocorax carbo*  
A130 *Haematopus ostralegus*  
A359 *Fringilla coelebs*  
A249 *Riparia riparia*  
A146 *Calidris temminckii*  
A459 *Larus cachinnans*  
A363 *Carduelis chloris*  
A329 *Parus caeruleus*  
A311 *Sylvia atricapilla*  
A304 *Sylvia cantillans*  
A283 *Turdus merula*  
A271 *Luscinia megarhynchos*  
A269 *Erithacus rubecula*  
A059 *Aythya ferina*  
A198 *Chlidonias leucopterus*  
A179 *Larus ridibundus*  
A165 *Tringa ochropus*

2.c. MAMMALS listed on Annex II of Directive 92/43/EEC

Code Name  
1355 Lutra lutra  
2609 Mesocricetus newtoni  
1335 Spermophilus citellus

2.d. Amphibian and reptile species listed in Annex II to Directive 92/43/EEC [146]

Code Name  
1188 Bombina bombina  
1220 Emys orbicularis  
1217 Testudo hermanni  
1993 Triturus dobrogicus  
1160 Zingel streber

2.e. FISH, included in Annex II of Directive 92/43/EEC [146]

Code Name  
4125 Alosa immaculata  
1130 Aspius aspius  
1138 Barbus meridionalis  
2533 Cobitis elongata  
1149 Cobitis taenia  
2484 Eudontomyzon mariae  
1124 Gobio albipinnatus  
2555 Gymnocephalus baloni  
1157 Gymnocephalus schraetzer  
2522 Pelecus cultratus  
1134 Rhodeus sericeus amarus  
1146 Sabanejewia aurata  
1159 Zingel zingel

2.f. INVERTEBRATES listed on Annex II of Directive 92/43/EEC [146]

Code Name  
1032 Unio crassus  
1083 Lucanus cervus  
1087 Rosalia alpina

3 Group “Other Important Vegetation and Animal Species”

<i>Tx.group NAME</i>	<i>Local population</i>	<i>Motivation</i>
<i>F Acipenser gueldenstaedti</i>	<i>P</i>	<i>C</i>
<i>F Acipenser ruthenus</i>	<i>P</i>	<i>C</i>
<i>F Acipenser stellatus</i>	<i>P</i>	<i>C</i>
<i>B Acrocephalus arundinaceus</i>	<i>P</i>	<i>A</i>
<i>B Acrocephalus pallustris</i>	<i>P</i>	<i>A</i>
<i>B Acrocephalus schoenobaenus</i>	<i>P</i>	<i>A</i>

<i>B</i>	<i>Acrocephalus scirpaceus</i>	<i>P</i>	<i>A</i>
<i>B</i>	<i>Accipiter gentilis</i>	<i>P</i>	<i>A</i>
<i>P</i>	<i>Alkanna tinctoria</i>	<i>R</i>	<i>A</i>
<i>B</i>	<i>Asio otus</i>	<i>P</i>	<i>A</i>
<i>P</i>	<i>Astragalus ponticus</i>	<i>R</i>	<i>A</i>
<i>A</i>	<i>Bufo viridis</i>	<i>P</i>	<i>A</i>
<i>B</i>	<i>Carduelis carduelis</i>	<i>P</i>	<i>A</i>
<i>B</i>	<i>Carduelis spinus</i>	<i>P</i>	<i>A</i>
<i>P</i>	<i>Centaurea arenaria</i>	<i>R</i>	<i>A</i>
<i>P</i>	<i>Centaurea rumelica</i>	<i>P</i>	<i>B</i>
<i>F</i>	<i>Chondrostoma nasus</i>	<i>P</i>	<i>D</i>
<i>F</i>	<i>Chondrostoma nasus</i>	<i>P</i>	<i>D</i>
<i>B</i>	<i>Coccothraustes coccothraustes</i>	<i>P</i>	<i>A</i>
<i>R</i>	<i>Coluber caspius</i>	<i>P</i>	<i>A</i>
	<i>Cricetus cricetus</i>	<i>P</i>	<i>A</i>
<i>M</i>	<i>Crocidura leucodon</i>	<i>C</i>	<i>C</i>
<i>M</i>	<i>Crocidura suaveolens</i>	<i>C</i>	<i>C</i>
<i>B</i>	<i>Cuculus canorus</i>	<i>C</i>	<i>A</i>
<i>F</i>	<i>Cyprinus carpio</i>	<i>C</i>	<i>A</i>
<i>B</i>	<i>Dendrocopos major</i>	<i>P</i>	<i>A</i>
<i>B</i>	<i>Emberiza cia</i>	<i>P</i>	<i>A</i>
<i>M</i>	<i>Erinaceus concolor</i>	<i>P</i>	<i>A</i>
<i>M</i>	<i>Felis silvestris</i>	<i>P</i>	<i>A</i>
<i>F</i>	<i>Huso huso</i>	<i>P</i>	<i>C</i>

A	<i>Hyla arborea</i>	C	A
R	<i>Lacerta viridis</i>	C	C
P	<i>Lemna gibba</i>	A	
P	<i>Leucojum aestivum</i>	A	
B	<i>Locustella luscinioides</i>	P	A
B	<i>Luscinia luscinia</i>	P	A
B	<i>Motacilla alba</i>	C	A
B	<i>Mustela nivalis</i>	C	A
M	<i>Nannospalax leucodon</i>	P	C
R	<i>Natrix tessellata</i>	C	C
M	<i>Neomys anomalus</i>	C	C
B	<i>Oriolus oriolus</i>	P	A
B	<i>Parus major</i>	P	A
A	<i>Pelobates fuscus</i>	P	A
A	<i>Pelobates syriacus</i>	C	C
B	<i>Phylloscopus bonelli</i>	P	A
B	<i>Phylloscopus collybita</i>	P	A
B	<i>Phylloscopus sibilatrix</i>	P	A
B	<i>Phylloscopus trochilus</i>	P	A
R	<i>Podarcis taurica</i>	C	C
B	<i>Prunella modularis</i>	P	A
A	<i>Rana dalmatina</i>	R	C
P	<i>Sitta europaea</i>	P	A
P	<i>Stachys arenariaeformis</i>	B	



<i>F</i>	<i>Stizostedion volgense</i>	<i>P</i>	<i>C</i>
<i>B</i>	<i>Sylvia borin</i>	<i>P</i>	<i>A</i>
<i>B</i>	<i>Sylvia communis</i>	<i>P</i>	<i>A</i>
<i>B</i>	<i>Sylvia curruca</i>	<i>P</i>	<i>A</i>
<i>B</i>	<i>Troglodytes troglodytes</i>	<i>P</i>	<i>A</i>

### 3.10.2 Protected Areas under NATURA 2000 in the region of KNPP in 30-km zone in Romania

Three protected areas are located within the 30-km zone around the KNPP. Protected area ROSCI0045 is under the Directive on the conservation of natural habitats and of wild flora and fauna and Protected Areas ROSPA0010 and ROSPA0023 under the Birds Directive.

Their location towards KNPP site is given on fig. 3.10.2-1.



**Fig. 3.10.2-1 Protected Areas under the Birds Directive on the left bank of the Danube River in the area of KNPP**

#### Protected area ROSCI0045 Coridorul Jiului under the Habitat Directive

PA ROSCI0045 “Coridorul Jiului” under Directive 92/43/EEC in the conservation of natural habitats and of wild fauna and flora is type K. The PA total area is 71394.0000 ha. It is located at an altitude between 6 and 332 m and is connected with two other PA under NATURA 2000 – ROSPA0010 and ROSPA0023 under the Birds Directive.

Protected area codenamed ROSCI0045 Coridorul Jiului occupies an area of 71.394°ha. It is situated in Dolj, Olt, Mehedinti, Gorj District.

In terms of land cover classes, the territory of the protected area is sub-divided into the following groups:

Land cover classes	%
Coverage	

Water inland areas (not running and running waters)	12.0
Water inland areas (not running and running waters)	4.0
Swamps, marshlands, vegetation alongside the banks of water basins, bogs	11.0
Extensive grain crops (including rotation crops periodically let lie fallow)	14.00
Improved pastures (artificially created from grass mixtures)	15.00
Other lands	2.00
Broad-leaved deciduous forests	38.00
Forest habitats	4.00
<b>Total coverage</b>	<b>100</b>

**The main purposes** of the protected area are related to preserving the area of the natural habitats and the species habitats and their populations which are subject to protection within the boundaries of the protected area.

The following habitats and species are included in the standard form as subject to protection in the area:

#### **TYPES OF HABITATS from Appendix I of Directive 92/43/EEC**

3130 Oligotrophic to mesotrophic standing waters with vegetation of Littorelletea uniflorae and/or Isoeto-Nanfjuncetea

3270 Rivers with muddy banks with Chenopodium and Bedintion p.p.

6260 Pannonian sand steppes

6440 Alluvial meadows of the alliance Cnidion dubii in river valleys

6510 Lowland hay meadows

1530 \* Panonian salty steppes and salty marshlands /

9130 Beech forests of the type Asperulo-Fagetum

9170 Oak-hornbeam forests of the type Galio Carpinetum

91E0 Alluvial forests with Alnus glutinosa Fraxinus excelsior (Alno-Padion, Alnion incanaeqSalicion albae)

9110 Beech forests of the type Luzulo-Fagetum

91M0 Balkan-Pannonian Quercus dalechampii forests

91Y0 Dacian oak and elm forests

92A0 Riparian galleries of Salix alba and Populus alba

91F0 Riparian mixed forests of Quercus robur, Ulmus laevis, or Fraxinus angustifolia along the big Pivers.

Note: The \* symbol denotes a habitat type which is of priority importance as far as its protection is concerned.

The following assessments are given according to the adopted indicators of the

habitats in the Standard Form:

**3130 Oligotrophic to mesotrophic standing waters with vegetation of Littorelletea uniflorae and/or Isoeto-Nanfjuncetea.** Here lowland pioneer communities of annual plants, growing on drying wet sediments in shallow edges of ponds and along the major rivers are formed. The representation of the habitat is assessed as good, in terms of relative area it is class C 2  $\geq p > 0$ ; the equated extent is “good protection” and the total assessment of the site is “good value”

**3270 Rivers with muddy banks with Chenopodion and Bedintion p.p. Pioneer and ruderal communities are formed on muddy banks along the rivers.** The plants usually grow in favorable conditions during the summer. The representation of the habitat is assessed as good, in terms of relative area it is class C 2  $\geq p > 0$ ; the equated extent is “good protection” and the total assessment of the site is “good value”.

**6260 Pannonian sand steppes.** Habitat occupies moving, alluvial sands, which develop terrophytic communities and tufted perennial grasses and subshrubs. The representation of the habitat is assessed as good, in terms of relative area it is class B 15  $\geq p > 2 \%$ ; the equated extent is “good protection” and the total assessment of the site is “good value”.

**6440 Alluvial meadows of the alliance Cnidion dubii in river valleys.** Floodplain habitat along the rivers, which after the withdrawal of water during the summer period develops hygromesophytic communities with rich species composition. The representation of the habitat is assessed as good, in terms of relative area it is class B 15  $\geq p > 2 \%$ ; the equated extent is “good protection” and the total assessment of the site is “good value”.

**6510 Lowland hay meadows.** Habitat is most often formed on rich alluvial meadow soils and earth, which develop plant communities dominated by grasses and rich grass variety. The representation of the habitat is assessed as good, in terms of relative area it is class C 2  $\geq p > 0$ ; the equated extent is “good protection” and the total assessment of the site is “good value”.

**1530 \* Panonian salty steppes and salty marshlands.** Habitat is formed in the peripheral parts of the marshes and river valleys. Salinisation is most often associated with spring floods and summer drought. Vegetation consists of annual and perennial typical and atypical halophytes. The representation of the habitat is assessed as good, in terms of relative area it is class B 15  $\geq p > 2 \%$ ; the equated extent is “good protection” and the total assessment of the site is “good value”.

**9130 Beech forests of the type Asperulo-Fagetum.** Mesophytic beech forests growing on neutral or near neutral soils, characterized by a rich species composition. The representation of the habitat is assessed as good, in terms of relative area it is class C 2  $\geq p > 0$ ; the equated extent is “good protection” and the total assessment of the site is “good value”.

**9170 Oak-hornbeam forests of the type Galio Carpinetum.** Mixed mesophytic forests dominated by Quercus petraea agg. and Carpinus betulus. The representation of the habitat is assessed as good, in terms of relative area it is class C 2  $\geq p > 0$ ; the

equated extent is “good protection” and the total assessment of the site is “good value”.

**91E0 Alluvial forests with *Alnus glutinosa* *Fraxinus excelsior* (*Alno-Padion*, *Alnion incanaeqSalicion albae*.)** Riparian forests growing of rich alluvial soils, periodic flooded. The representation of the habitat is assessed as excellent, in terms of relative area it is class B  $15 \geq p > 2$  %; the equated extent is “good protection” and the total assessment of the site is “good value”.

**9110 Beech forests of the type *Luzulo-Fagetum*.** Beech forests growing on poorer acidic, dry to fresh soils. Characterized by poorer species composition and significant participation of mosses. The representation of the habitat is assessed as excellent, in terms of relative area it is class B  $15 \geq p > 2$  %; the equated extent is “good protection” and the total assessment of the site is “excellent value”.

**91M0 Balkan-Pannonian *Quercus dalechampii* forests.** Xerothermic oak forests dominated by *Quercus ceris*, *Quercus frainetto* and *Quercus petraea* agg. The representation of the habitat is assessed as excellent, in terms of relative area it is class B  $15 \geq p > 2$  %; the equated extent is “good protection” and the total assessment of the site is “good value”.

**91Y0 Dacian oak and elm forests.** The representation of the habitat is assessed as excellent, in terms of relative area it is class C  $2 \geq p > 0$ ; the equated extent is “good protection” and the total assessment of the site is “good value”.

**92A0 Riparian galleries of *Salix alba* and *Populus alba*.** Waterlogged habitats of riparian forest communities dominated by willows and poplars. The representation of the habitat is assessed as excellent, in terms of relative area it is class B  $15 \geq p > 2$  %; the equated extent is “good protection” and the total assessment of the site is “good value”.

**91F0 Riparian mixed forests of *Quercus robur*, *Ulmus laevis*, or *Fraxinus angustifolia* along the big rivers.** Periodically flooded mixed deciduous forests. The representation of the habitat is assessed as excellent, in terms of relative area it is class B  $15 \geq p > 2$  %; the equated extent is “good protection” and the total assessment of the site is “good value”.

Plant species from Annex II of Directive 92/43/EEC are not included in the PA Standard Form as subject to protection. Plant species from the group "Other significant plant and animal species" related to the protection and management of the object, are not included either.

### Quality and importance

The PA territory belongs to the priority areas for conservation of the continental biodiversity and has great significance. Although it covers only 0.5 % of the national forest area in Romania and 0.6 % of natural areas, it includes: natural forest habitats protected by Romanian and European legislation (9 of 28 types); forest formations (22 of 50); forest types identified in the country (97 of 306). Jiu Valley is one of the Trans-Balkan corridors for migrating birds (Bulgarian Central-European path), followed by a significant number of birds. Together with the resident birds, 135 of 406 bird species in Romania are identified in the Jiu corridor, 114 of which are

protected by the Romanian and European legislation.

### **Vulnerability**

The location within three counties and near Craiova city provides a reasonable Plan for territory development (PTD), based on which the General development plan (GDP) of the near settlements can be updated every ten years. Once updated, the GDP allows the development of a Regional development plan (RDP) resulting in a Detailed development plan (DDT). DDT development aims to harmonize all current and future interests to this diverse territory, in which the proportion of forest fund (34 %) and forests (33 %) cannot be reduced, as well as other categories of land containing natural areas protected by EU and Romanian legislation. Thus, pollution, urbanization, agricultural activities and other destructive effects of human intervention in the environment can be reconciled with the essential requirements and activities for sustainable development and biodiversity conservation carried out by man.



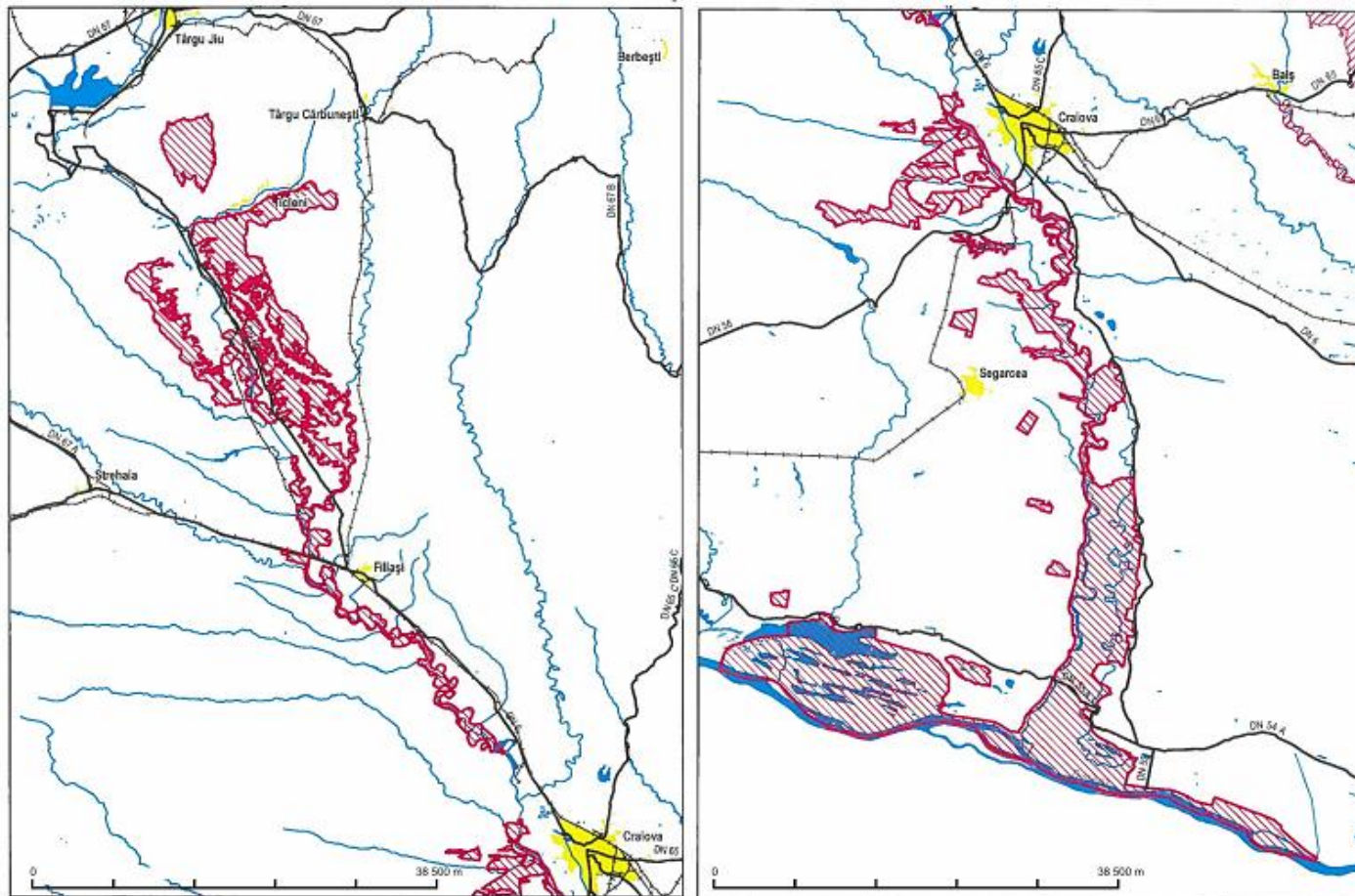

**Fig. 3.10.2-2 Protected Area ROSCI0045**

## Protected area ROSPA0010

**Indicative denomination of the site:** ROSPA0010 Bistret River (Bistret) (1915.6 ha) – Dolj County

**Land cover** (type and percent): Rivers, lakes (90 %); swamps (8 %); pastures (2 %).

The species listed in Annex I of the Birds Directive which could be affected adversely during the construction, operation and decommissioning of the Plasma Melting Facility are:

- 1. Dalmatian Pelican (*Pelecanus crispus*)** – globally endangered species with 3-59 migrant birds and global assessment mention B. The species inhabits the wetlands of Bistretsu where its hunting area is and where it stays for the night and rests next to the sand spits of the adjacent islands of Danube River. No significant adverse impact on the species is predicted.
- 2. Great White Pelican (*Pelecanus onocrotalus*)** – migrant species with 50-150 migrant birds and global assessment mention B. During migrations the species inhabits the wetlands of Bistretsu, where its trophic area is and where it stays for the night and rests next to the sand spits of the adjacent islands of Danube River. No significant adverse impact on the species is predicted.
- 3. Little Cormorant (*Phalacrocorax pygmeus*)** – wintering and passerine species with 15 wintering and 1000 passing birds and global assessment mention A. No significant adverse impact on the species is predicted.
- 4. Eurasian Spoonbill (*Platalea leucorodia*)** – nesting (34-41 couples) and passerine species (180-211 specimens.) with global assessment mention C. The species inhabits the wetlands of the Danube River valley. No significant adverse impact on the species is predicted.

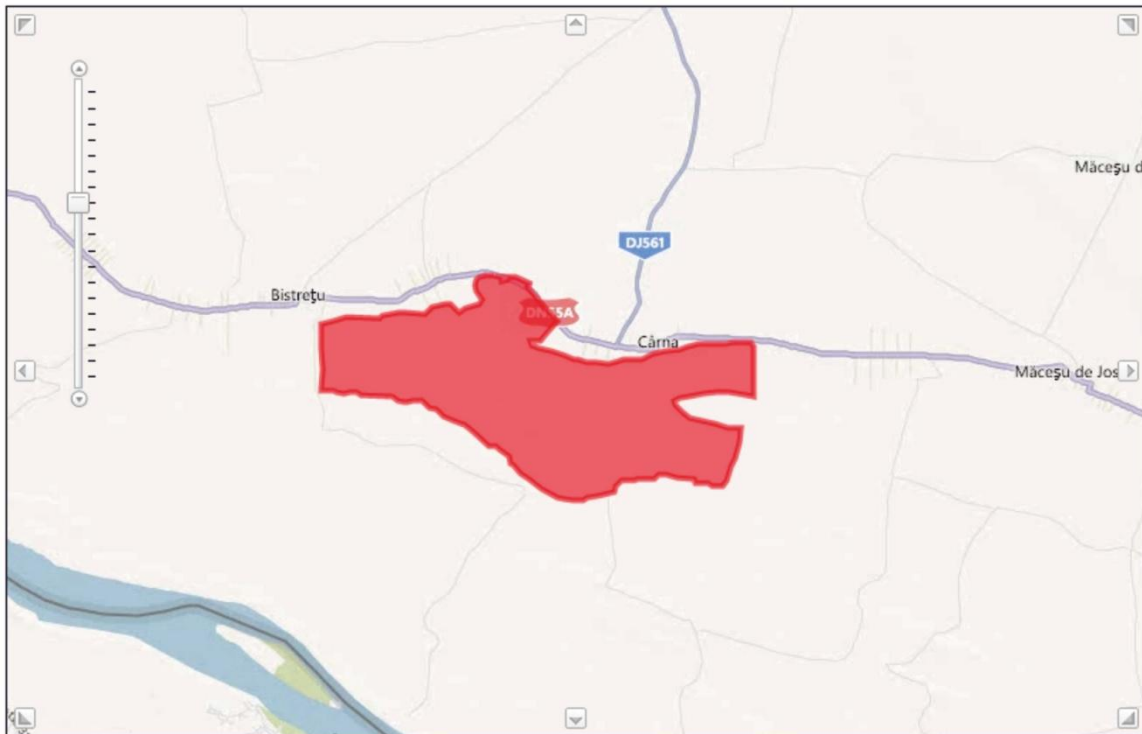

Fig. 3.10.2-3 Protected Area ROSPA0010 (source:<http://natura2000eea.europa.eu>)

#### Protected area ROSPA0023

**Indicative denomination of the site:** ROSPA0023 Jiu River –Danube River Confluences (Confluența Jiu – Dunăre) (21,999.9 ha) - Olt, Dolj Counties

**Land cover** (type and percent): rivers/lakes (17 %), crops/arable land (22 %), pastures (11 %), other arable fields (4 %), broadleaved forests (40 %), transition forests (6 %)

The species listed in Annex I of the Birds Directive which could be affected adversely during the Decommissioning of KNPP Units 1 to 4 are:

1. **Dalmatian Pelican (*Pelecanus crispus*)** – globally endangered species with 3-59 migrant birds and global assessment mention B. The species inhabits the wetlands of Bistretsu where its hunting area is and where it stays for the night and rests next to the sand spits of the adjacent islands of Danube river. No significant adverse impact on the species is predicted.
2. **Little Cormorant (*Phalacrocorax pygmeus*)** – wintering and passerine species with 15 wintering and 1000 passing birds and global assessment mention A. No significant adverse impact on the species is predicted.
3. **Eurasian Spoonbill (*Platalea leucorodia*)** – nesting (34-41 couples) and passerine species (180-211 specimens.) with global assessment mention C. The species inhabits the wetlands of the Danube river valley. No significant adverse impact on the species is predicted.
4. **White Stork (*Ciconia ciconia*)** - – nesting (20-30 couples) and passerine species with global assessment mention C. The species inhabits the wetlands of the Danube river valley. No significant adverse impact on the species is predicted.

In conclusion it can be summarized that the protected areas on both sides of Danube River are



interconnected and form a complex ecological system which shall be considered as a whole. The adverse impact on it due to the construction, operation and decommissioning of the Plasma Melting Facility is assessed as insignificant.

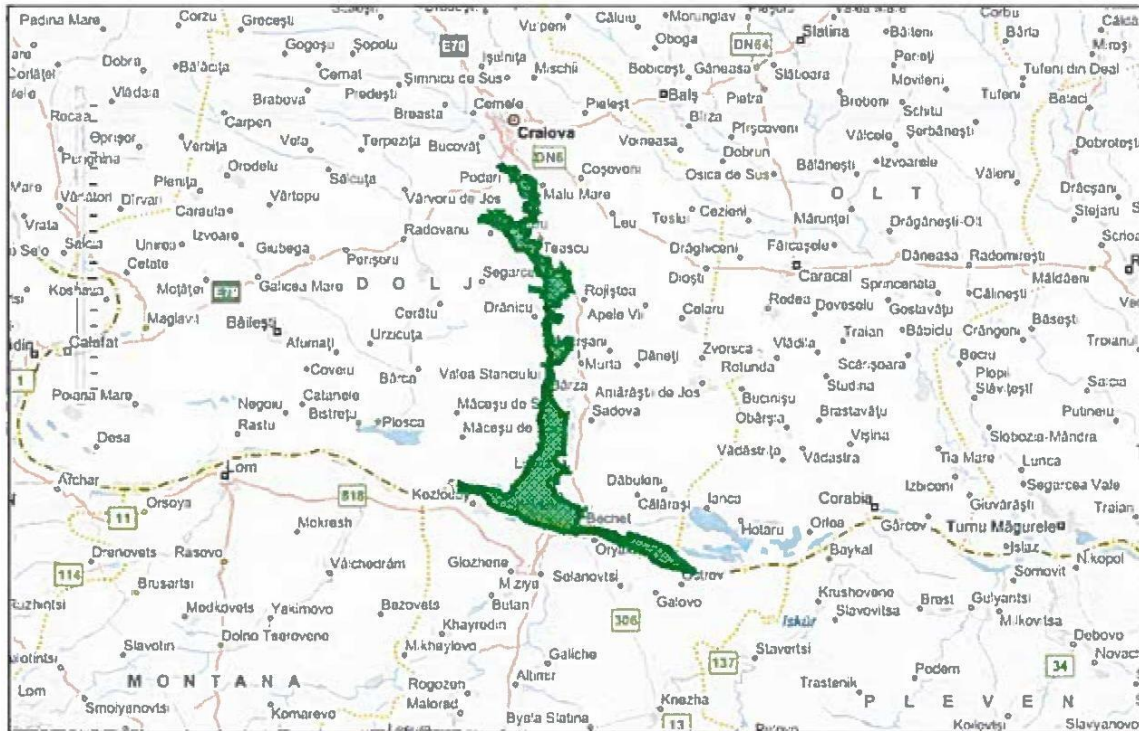

Fig. 3.10.2-4 Protected Area ROSPA0023 (source: <http://natura2000.eea.europa.eu>)

### 3.10.3 Protected Territories

According to the Registry of the protected territories and protected areas in Bulgaria (EEA) Vratsa RIEW, Montana RIEW) within the 30-km area of influence of the IP are located the following protected territories under the Protected Territories Act:

- **Ibisha managed reserve** – covering an area of 34.47 ha within the lands of Dolni Tsibar, Valchedrum Municipality, promulgated by Decree RD-794/08/10/1984, with as a purpose – conservation of characteristic Danubian island communities – flooding forest and marshes, inhabited by protected species.
- **Kozloduy protected country** – covering an area of 10 ha, within the lands of Kozloduy town, reclassified from historical location in location with characteristic landscape promulgated by MEW Decree No RD-639/26.05.2003.
- **Tsibar island protected country** covering an area of 101.48 ha, within the lands of Gorni and Dolni Tsibar, Valchedrum Municipality, promulgated by Decree No RD-292/10.04.2007; with as a purpose – conservation of breeding, wintering and resting of protected species (*Sterna hirundo*, *Sterna albifrons*, *Haematopus ostralegus*, *Pelecanus crispus*, mixed heron colony
- **Koritata protected country** – covering an area of 2 ha, in the lands of sofronievo village, Misia Municipality, promulgated by Decree No RD-407/07.05.1982 and reclassified by Decree No RD-641/ 26.05.2003; with as a purpose of conservation of Red Peonia habitat and landscape landmark.

- **Daneva mogila protected country** – covering an area of 4.9 ha, in the lands of Sofronievo village, Misia Municipality, promulgated by Decree No RD – 413 /10.05.1982; with as a purpose – conservation of type of riverin landscape and groupe of venerable trees.
- **Kochumina protected country** – covering an area of 2.5 ha, , in the lands of Selanovtsi village, Oryahovo Municipality, promulgated by Decree No RD-2109/20.12.1984 and reclassified by Decree No RD-642/ 26.05.2003; with a purpose of conservation – water lily habitat.
- **Gola bara protected country** – covering an area of 2 ha, in the lands of Selanovtsi village, Oryahovo Municipality, promulgated by Decree No RD-2109/20.12.1984 in the lands of Selanovtsi village, Oryahovo Municipality, promulgated by Decree No RD-643/ 26.05.2003; with a purpose of conservation – water lily habitat.
- **Kalugerski grad Topolite protected country** – covering an area of 0.2 ha, in the lands of Selanovtsi village, Oryahovo Municipality, promulgated by Decree No RD-2109/20.12.1984 in the lands of Selanovtsi village, Oryahovo Municipality, promulgated by Decree No RD-643/ 26.05.2003; with a purpose of conservation *Stratiotes aloides*.

### **3.10.4 Impact of the KNPP on the plants and habitats in the Protected Areas and Protected Territories**

Up to now there is no specialized monitoring held of the radioecological status of the vegetation and habitats in the protected territories and protected areas related to the EIA of KNPP. Results of the monitoring held up to now of the soil and vegetation components in the region of 30 km from KNPP (section **3.4.2 and 3.6**) allow to conclude that the impacts of the KNPP have not considerably changed the environmental radiological status of the territory of the Protected Areas assessed in the EIA for the region of the village of Selanovtsi and Protected Territories BG0000533: Islands Kozloduy for protection of the habitats of the wild flora and fauna and BG0002009: Zlatiyata for protection of the wild birds. Grounds for such conclusion are as follows:

- No negative impact is detected on the natural and derivative vegetation and agricultural crops
- Analysis of the soils' pollution in the region of KNPP until 1999 shows that it is not possible to prove the contribution of the power plant into the contents of  $^{137}\text{Cs}$  and  $^{90}\text{Sr}$  in the soils. As a whole the operation of the KNPP has no impact on the soil parameters that could be also considered for the habitats as a whole.
- Monitoring of the pollution of the soils in 2006, 2007 and 2008 shows that the most important pollutants are  $^{90}\text{Sr}$  and  $^{137}\text{Cs}$  and their concentrations are lower than the other regions in the country which is a sign that the environmental radiological status of the habitats is not impacted by the operation of the KNPP.

### 3.11 Cultural heritage

#### Availability of architectural, historical and archaeological monuments and their current conditions

In the Republic of Bulgaria National institute for protection of the immovable cultural values (NIPICV) (successor of the National Institute for cultural monuments – NICM, Sofia, 1000, 16 Doundukov Blvd., tel/fax 987 48 01) based on the currently existing LAW FOR CULTURAL HERITAGE – (LCH) (accepted by the 40th Parliament on 26 February 2009, promulgated in SG, 19 from 13 March 2009 and entered into force from 10 April 2009 except Article 114, Para 2. and Para 126, effective from 10 April 2010 replacing the previous one that has been effective for 40 years – since 1969 Law for cultural monuments and museums) is “**State Cultural Institute of National Importance in the field of protection of immovable cultural heritage**” (Article 18).

According to **the LCH, Article 58, and Para 1** “Declaration of sites that could be determined as immovable cultural values is made by the NIPNCV on the grounds of preliminary evaluation of their valuable scientific value and public importance”.

Determination of the scientific and cultural value of the immovable site, its preliminary classification as well as the temporary modes of its protection is made with a declaration act issued by the Director of NIPNCV (**Article 58, Para 2**).

When the complex evaluation determines that the declared immovable sites have qualities of *immovable cultural values*, a proposal is submitted to the Minister of Culture by the director of NIPICV for their final classification, categorization and protection regimes (**Article 64, Para 1**).

Investigations made in the REGISTER of NIPICV showed that on the site of the investment proposal (site of KNPP) there are no immovable cultural values and within the closest adjacent territories – 30-km area around the power plant there are some sites having the status of immovable cultural monuments.

Cultural historical monuments are numerous and various - from the antiquity, Middle Ages, from the period of fight for national and religious liberty etc.

Most important sites and attractions that could be subject to attention as touristic sites and attractions could be split in the following groups: 1. Cultural and historical monuments of antiquity and Middle Ages; 2. Religious monuments; 3. Interesting ethnographic peculiarities.

Situation by November 2009 is as follows: in 30-km zone around the power plant in 26 populated areas there are 148 sites of cultural and historical heritage of different ages that are split in types as follows:

- Archaeological reserve – 1 site;
- Archaeological monuments – 56 sites;
- Architectural-construction monuments – 58 sites;
- Architectural –art monuments– 1 site;
- Historical monuments – 24 sites;
- Art monuments – 8 sites



Depending of their importance instant (CATEGORY) they are separated as follows:

- Of national importance – 22 sites;
- Of local importance 121 sites;
- For information only – 5 sites;
- Written-off – 3 sites.

In the territorial scope they are separated as follows:

### **0-3-km area around KNPP**

There are no populated areas and cultural and historical monuments.

### **3-5-km area around KNPP - 2 populated areas with 8 sites totally**

- Town of Kozloduy – municipality of Kozloduy, Vratsa district – 4 sites (LISTS of the single sites on the territories, having the status of immovable cultural monuments are shown in table 1).
- v. Harlets – municipality of Kozloduy, Vratsa district – 4 sites (LISTS of the single sites on the territories, having the status of immovable cultural monuments are shown in table 2).

### **5-8-km area around KNPP - 2 populated areas with 5 sites totally**

- **Town of Miziya – municipality of Miziya, Vratsa district** – 3 sites (LISTS of the single sites on the territories, having the status of immovable cultural monuments are shown in table 3).
- **v. Lipnitsa – municipality of Miziya, Vratsa district** – 2 sites (LISTS of the single sites on the territories, having the status of immovable cultural monuments are shown in table 4).

### **8-12-km area around KNPP - 1 populated areas with 5 sites**

- **v. Butan – municipality of Kozloduy, Vratsa district** – 5 sites (LISTS of the single sites on the territories, having the status of immovable cultural monuments are shown in table 5).
- **12-15 km area around KNPP** - 5 populated areas with 56 sites totally
- Town of Oryahovo – Oryahovo municipality, district of Vratsa – 42 sites (LISTS of the single sites and territories, having the status of immovable cultural monuments are shown in table 6).
- **v. Ostrov – Oryahovo municipality, district of Vratsa** – 3 sites (LISTS of the single sites and territories, having the status of immovable cultural monuments are shown in table 7).
- **v. Dolni Vadin– Oryahovo municipality, district of Vratsa** – 1 site (LISTS of the single sites and territories, having the status of immovable cultural monuments are shown in table 8).
- **v. Krushovitsa – Oryahovo municipality, district of Vratsa** – 7 sites (LISTS of the single sites and territories, having the status of immovable cultural monuments are shown in table 9).

- **v. Sofroniievo – municipality of Miziya, Vratsa district** – 3 sites (LISTS of the single sites on the territories, having the status of immovable cultural monuments are shown in table 10).

#### **15-20-km area around KNPP - 4 populated areas with 15 sites totally**

- **v. Leskovets – Oryahovo municipality, district of Vratsa** – 1 site (LISTS of the single sites and territories, having the status of immovable cultural monuments are shown in table 11).
- **v. Selanovtsi – Oryahovo municipality, district of Vratsa** – 4 sites (LISTS of the single sites and territories, having the status of immovable cultural monuments are shown in table 12).
- **Town of Hayredin – Oryahovo municipality, district of Vratsa** – 7 sites (LISTS of the single sites and territories, having the status of immovable cultural monuments are shown in table 13).
- **v. Botevo – Oryahovo municipality, district of Vratsa** – 3 sites (LISTS of the single sites and territories, having the status of immovable cultural monuments are shown in table 14).

#### **20-25-km area around KNPP - 6 populated areas with 28 sites totally**

- **v. Galitche – Byala slatina municipality, district of Vratsa** – 4 sites (LISTS of the single sites and territories, having the status of immovable cultural monuments are shown in table 15).
- **v. Altemir– Byala slatina municipality, district of Vratsa** – 7 sites (LISTS of the single sites and territories, having the status of immovable cultural monuments are shown in table 16).
- **v. Mihalkovo – Oryahovo municipality, district of Vratsa** – 7 sites (LISTS of the single sites and territories, having the status of immovable cultural monuments are shown in table 17).
- **v. Manastirishte – Hayredin municipality, district of Vratsa** – 1 site (LISTS of the single sites and territories, having the status of immovable cultural monuments are shown in table 18).
- **v. Dolni Tsibar – Vulchedrum municipality, district of Montana**– 5 sites (LISTS of the single sites and territories, having the status of immovable cultural monuments are shown in table 19).
- **v. Dolni Tsibar – Vulchedrum municipality, district of Montana**– 4 sites (LISTS of the single sites and territories, having the status of immovable cultural monuments are shown in table 20)

#### **25-30-km area around KNPP - 9 populated areas with 31 sites totally**

- **v. Burdarski Geran– Byala Slatina municipality, district of Vratsa** – 1 site (LISTS of the single sites and territories, having the status of immovable cultural monuments are shown in table 21).
- **v. Turnava– Byala Slatina municipality, district of Vratsa** – 3 sites (LISTS of the single sites and territories, having the status of immovable cultural monuments are

shown in table 22).

- **v. Dobrolevo – Borovan municipality, district of Vratsa** – 1 site (LISTS of the single sites and territories, having the status of immovable cultural monuments are shown in table 23).
- **v. Furen – Krivodol municipality, district of Vratsa** – 3 sites (LISTS of the single sites and territories, having the status of immovable cultural monuments are shown in table 24).
- **v. Beli brod – Boitchinovtsi municipality, district of Montana**– 5 sites (LISTS of the single sites and territories, having the status of immovable cultural monuments are shown in table 25).
- **v. Septemvriitsi (village Gorna Gnoenitsa) – Vulchedrum municipality, district of Montana**– 1 site (LISTS of the single sites and territories, having the status of immovable cultural monuments are shown in table 26).
- **Town of Vulchedrum – Vulchedrum municipality, district of Montana**– 12 sites (LISTS of the single sites and territories, having the status of immovable cultural monuments are shown in table 27).
- **v. Razgrad – Vulchedrum municipality, district of Montana**– 3 sites (LISTS of the single sites and territories, having the status of immovable cultural monuments are shown in table 28).
- **v. Stanevo – Lom municipality, district of Montana**– 2 sites (LISTS of the single sites and territories, having the status of immovable cultural monuments are shown in table 29)

Detailed description of the sites of cultural and historical heritage in populated areas and categories of the monuments in the investigated territorial range (30-km area around the KNPP) is presented in the listed tables in appendix 11.1.

When investigating the availability and conditions of the cultural monuments some Dossiers of NIPICM are used (National Documentary Archive), providing information for the registered cultural monuments (cultural values) – declared and nominated as well as their categorization.

All discovered archaeological sites, constructions and memorial places and adjacent ornamental and art decoration on the terrestrial and aquatic territory of the Republic of Bulgaria possess *status of immovable cultural monuments - immovable cultural values*. All newly discovered and undiscovered by the current moment archaeological cultural monuments on the territory of the country *are declared as cultural monuments with preliminary category “national importance”*. – letter No 545 of NICM with the Ministry of Culture from 27 February 2001 of NICM. According to Decree No 1711 of the Council of Ministry 22 October 1962 all settlement and funeral mounds and defensive banks in Bulgaria are announced as cultural monuments of national importance – i.e. they have a status of the cultural monuments of the category “national importance”. All memorial signs risen in view of the participation of Bulgaria in the wars from 1885, 1912-1913, 1915-1918, 1944-1945 years are declared as *historical cultural monuments* – letter No 4349 of NICM with the Ministry of Culture from 4 December 1992.

In view of the possibility some unregistered archaeological cultural monuments to be available up to the moment next to territory of the site we recommend the investor contact an expert-archaeologist for more information.

## 3.12 Geography, demographic, social and socio-economic environment

### 3.12.1 Geographic location of KNPP

The site chosen for the deployment of the power plant has a favorable geographic location. It was built in the northwestern Bulgaria, on the territory of Vratsa District, within the borders of municipality of Kozloduy and on the land of the town Kozloduy and the village Harlets. The location of the site of KNPP, marked on the topographic map and the administrative map of the Republic of Bulgaria (ed. 2008) [40], shows that to the north in a straight line it is located around 120 km away from Sofia, 62 km away from the District centre – Vratsa, around 65 km away from the situated south-east District centre – Pleven and situated 57.2 km away from the south-west third District centre – Montana. Closest to the site of the plant cities are Lom, Oryahovo, Byala Slatina and Knezha, of which only Oryahovo is situated inside the 30-km area of the NPP.

The outlined area of KNPP fully covers the territories of the municipalities Kozloduy, Miziya, Hayredin and bigger or smaller areas from the municipalities Krivodol, Borovan, Byala Slatina, Oryahovo (which in administrative aspect belongs also to Vratsa District) and the municipalities Lom, Valchedrum, Boichinovtzi (Montana District). Within the borders of the 30-km area a very small part of the lands belongs to the town Knezha of the eponymous municipality Knezha, which belongs to Pleven District (fig. 3.10-2). For defining the total perimeter of the 30km area to the perimeter of the three municipalities Kozloduy, Miziya and Hayredin according to the data from the National Cadastral Center EOOD, the area of the separate settlements has been added from performed planimetry on a map at a scale 1: 400000 [41]. In this way the total area amounts to 1779.8 km<sup>2</sup> and the number of the settlements is 43 (table 3.12.1-1).

**Table 3.12.1-1 Area of the municipalities inside the 30-km area of KNPP**

Municipalities	Total area (km <sup>2</sup> )	Settlements inside the 30-km area of KNPP	
		Area (km <sup>2</sup> )	Number of settlements
Lom	323.9	23.06	1 (of 10 in the municipality)
Valchedrum	431.5	407.81	10 (of 11 in the municipality)
Boichinovtzi	308.3	66.06	2 (of 13 in the municipality)
Krivodol	326.8	19.15	1 (of 15 in the municipality)
Kozloduy	284.9	284.90	Whole municipality - 5 settlements
Hayredin	189.1	189.10	Whole municipality - 6 settlements
Borovan	210.7	97.68	3 (of 5 in the municipality)
Miziya	209.3	209.30	Whole municipality - 6 settlements
Oryahovo	326.5	281.42	5 (of 7 in the municipality)
Byala Slatina	572.3	177.00	4 (of 15 in the municipality)
Knezha		23.8	0
<b>Total</b>	<b>3183.3</b>	<b>1779.28</b>	<b>43</b>

Source of information: National Cadastral Center EOOD to 31.12.2000, cited by NSI in the statistic guide "Regions, districts and municipalities in republic of Bulgaria", 2004 and planimetry.

The concerned 30-km zone includes not only Bulgarian territory but includes part of the territory of neighboring Romania. In its scope are 133 035 ha land occupying the lowland plains and parts of Romanatilor and Bailesti plains, formed in the low left bank of the Danube. It is crossed by the Danube, Jiu, Jiet (Old Jiu) rivers, and their tributaries Baboiaia,

Balasan and Giorocel. In the lower part of the southern lowland area a number of lakes and swamps were formed, the largest of them are lakes Bistret and Calugareni. The average altitude is about 70 m, it varies between 20 m in the southern part of Danube and north up to 122.5 m. By category of economic acquisition and land use on the Romanian side are allocated mainly agricultural land – 106976 ha, forest (forests, shrubs, nurseries, etc.) – 9328 ha and 10012 ha are water areas (rivers, lakes and swamps).

The utilized area for the construction and operation of the power plant of around 4 km<sup>2</sup> is located opposite the 694<sup>th</sup> kilometer of the course of Danube River. The industrial site is at a distance 3.7 km south of the midstream of the river, serving as a natural state border with the Republic of Romania. To the north between the site of KNPP and the bed of the Danube River lays the Kozloduy Valley.

The chosen site of the plant is situated in the northern part of the first floodplain terraces of Danube River and is around 3.5 km away southeast from the town Kozloduy and around 4 km away northwest from the village Harlets.

### **3.12.2 Demographic and socio-economic characteristics**

#### **Population dynamics**

In the area within the 30-km radius around KNPP 43 villages from 10 municipalities are included, which are falling into the borders of the administrative areas of Montana and Vratsa (fig. 3.12.2-1). Entirely included in the area are the territories of the municipality Kozloduy, where the nuclear power plant is located as well as the neighboring municipalities Miziya and Hayredin. This area includes also settlements coming under the jurisdiction of another seven municipalities - Lom, Valchedrum, Boytchinovtsi (Montana district) and Krivodol, Borovan, Oryahovo, Byala Slatina (Vratsa district). Furthermore there are settlements on the territory of Romania which fall in the scope of the 30-km zone. They belong to the sparsely populated part of Romania. Within this zone 23 settlements can be found, including 2 cities - Dabuleni and Bechet. All are part of the largest administrative-territorial district Dolj.

The comparison of the numbers of population only of the settlements within the 30-km area in the years of the last three censuses (1985, 1992 and 2001) and data from the current statistics for 2007 shows the trend of reduction through that period, which is clearly marked in the graphic – from 101.6 thousand people (1985) to 72.4 thousand people (2007, fig. 3.10.2-1). The tendency of change in the number of population there does not differ in character from the tendency of change in the country and the districts, where this area is located. The comparison of the relative reduction of the population in the 30-km area through the period 1985-2011 (-35.0 %) is close to the average reduction for the districts Vratsa (-34.9 %) and Montana (-33.5 %) and considerably higher than the one of the country (-17.7 %).



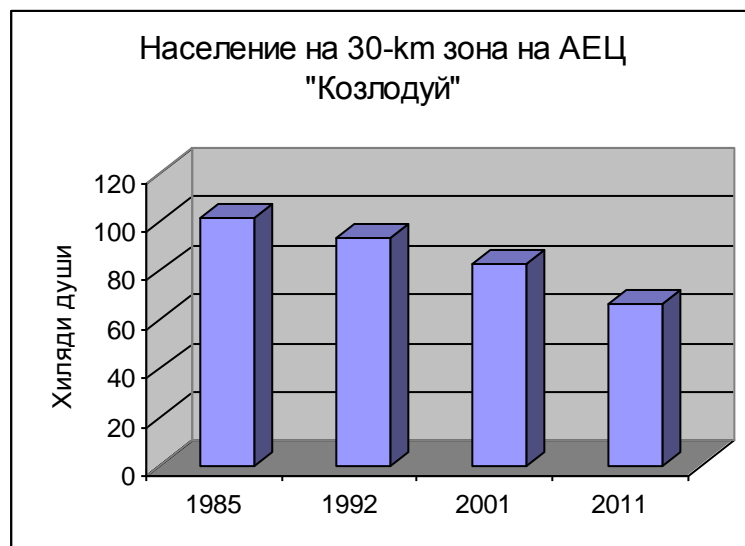

**Fig. 3.12.2-1 Population in the 30-km area of KNPP**

Source of the information: NSI [42].

Legend:

Население в 30 km зона на АЕЦ Козлодуй - Population in the 30-km area of KNPP

Хиляди души - Thousands of people

The highest number of population can be found in the municipality of Kozloduy (tables 3.12.2-1 and 3.12.2-2), which is completely within area No 2 for accident planning. The analysis of the change in the number of the population by settlements (tables 3.12.2-2 and 3.12.2-3) shows that until the census in 2001 [42] it increases only in Kozloduy Town and in Dolni Tsibar Village. It could be definitely said that the increase of the number of population in Kozloduy Town through this period is related to the construction and operation of the nuclear power plant and the connected to its activities. Through the last few years slight reduction of the number of population is seen after continuous period of increase (tables 3.12.2-2 and 3.12.2-3). Data from the last census (01.02.2011) show that only v. Dolni Tsibar shows a weak tendency of population increase. In contrast, the population of Kozloduy decreases with 1834 people as compared to the previous census (2001), which is due to the shutdown of the first two units of KNPP. In the other 41 settlements a more or less expressed trend for reduction of the number of the population through the period 1985-2007 is observed.

**Table 3.12.2-1 Number of the population into the 30-km area of KNPP according to censuses of the population (people)**

Municipality	Settlement	1985	1992	2001	2011
Municipality Lom	1. v. Satnevo	1006	786	549	341
Municipality Valchedrum	2. v. Botevo	180	127	107	65
	3. v. Bazovets	469	384	267	114
	4. t. VALCHEDRUM	6481	5732	4800	3662
	5. v. Gorni Tsibar	950	675	390	196
	6. v. Dolni Tsibar	1498	1535	1576	1586
	7. v. Zlatia	2070	1616	1289	870
	8. v. Ignatovo	532	443	358	262
	9. v. Mokresh	1768	1502	1150	803
	10. v. Razgrad	1638	1366	1092	686
	11. v. Septemvriitsi	1924	1746	1441	1149
	Municipality Boytchinovtzi	12. v. Beli brod	566	479	395



Municipality	Settlement	1985	1992	2001	2011
	13. v. Lehchevo	2948	2705	2370	1797
Municipality Krivodol	14. v. Furen	609	579	409	251
Municipality Kozloduy entirely	15. v. Butan	4019	3717	3343	2918
	16. v. Glozhene	3459	3294	3150	2748
	17. t. KOZLODUY	12494	13662	14892	13058
	18. v. Kriva Bara	713	663	554	397
	19. v. Harlets	2821	2633	2428	2059
Municipality Hayredin entirely	20. v. Botevo	225	194	105	81
	21. v. Byrzina	598	491	399	251
	22. v. Manastirishte	1934	1755	1515	1067
	23. v. Mihaylovo	1720	1676	1378	1048
	24. v. Rogozen	1877	1769	1463	1007
	25. v. Hayredin	2893	2532	2125	1547
Municipality Borovan	26. v. Dobrolevo	1420	1307	1077	865
	27. v. Malorad	2786	2593	2380	1883
	28. v. Sirakovo	414	396	330	225
Municipality Miziya entirely	29. v. Voyvodovo	476	411	360	264
	30. v. KrushovitsaKrushovitsa	3050	2633	2193	1712
	31. v. Lipnitsa	1421	1212	945	737
	32. t. MIZIYA	5137	4596	4069	3252
	33. v. Saraevo	118	95	73	44
	34. v. Sofronievo	3138	2540	1965	1561
Municipality Oryahovo	35. v. Galovo	690	535	409	277
	36. v. Leskovets	1230	1089	876	656
	37. t. ORYAHOVO	7326	6767	6107	5031
	38. v. Ostrov	2740	2433	2042	1480
	39. v. Selanovtsi	6104	5245	4623	3540
Municipality Byala Slatina	40. v. Altimir	1989	1900	1525	1179
	41. v. Byrdarski geran	1459	1292	1078	745
	42. v. Galiche	3327	2882	2406	1976
	43. v. Tarnava	3370	3184	2875	2366
<b>TOTAL</b>		<b>101587</b>	<b>93171</b>	<b>82878</b>	<b>65994</b>

Source: Calculations of the author on data of NSI. [42, www.nsi.bg].

According to the data provided by experts from Romania 75150 people live in 19 settlements within the Romanian part of the 30-km area. For four settlements falling under within this area no data was submitted for their population. But it should be beared in mind that the average population of villages in this part of the country. Probably the total number of population is about 80 thousand people (table 3.12.2-2).

**Table 3.12.2-2 Number of the population in the 30km zone of the KNPP living on the territory of Romania**

Settlement	Population (number of people)
v. Ostroveni	5255
v. Gighera	3208
v. Valea Stanciului	5736
v. Călărași	6282
t. Bechet	3917
t. Dăbuleni	12819

v. Piscu Vechi	2713
v. Sadova	8489
V.Gângiova	2630
t. Măceșu de Jos	1433
t. Măceșu de Sus	1427
t. Bistreț	4336
v.Goicea	2774
v. Bârca	4024
v. Vela	2033
v. Nedeia	1380
v. Sarata	2139
v. Listeava	1612
v. Horezu Poenari	2943

For the whole Bulgarian part of the 30-km area the number of women is around 2 thousand persons higher than the number of men out of the total number of the population through 2007 (table 3.12.2-3). However it could be noticed that in some settlements the number of the population of male and female sex is almost even (Kozloduy, Lehchevo, Furen and others) but in some other settlements the number of women is higher (Valchedrum, Miziya, Stanevo and others).

**Table 3.12.2-3 Number of the population into the 30-km area of KNPP (people, 2010)**

Municipality	Settlements	Total	Men	Women
Municipality Lom	1. v. Satnevo	405	193	212
Municipality Valchedrum	2. v. Botevo	70	28	42
	3. v. Bazovets	153	69	84
	4. t. VALCHEDRUM	3696	1752	1944
	5. v. Gorni Tsibar	198	85	113
	6. v. Dolni Tsibar	1526	763	763
	7. v. Zlatia	859	410	449
	8. v. Ignatovo	287	133	154
	9. v. Mokresh	869	398	471
	10. v. Razgrad	795	384	411
	11. v. Septemvriitsi	1139	547	592
	Municipality Boytchinovtsi	12. v. Beli brod	228	107
13. v. Lehchevo		1887	931	956
Municipality Krivodol	14. v. Furen	326	166	160
Municipality Kozloduy – entirely	15. v. Butan	2917	1373	1544
	16. v. Glozhene	2781	1359	1422
	17. t. KOZLODUY	13752	6832	6920
	18. v. Kriva Bara	432	202	230
	19. v. Harlets	2133	1052	1081
Municipality Hayredin - entirely	20. v. Botevo	75	34	41
	21. v. Byrzina	277	135	142
	22. v. Manastirishte	1094	535	559
	23. v. Mihaylovo	1096	515	581
	24. v. Rogozen	1039	495	544
	25. v. Hayredin	1524	736	788
Municipality Borovan	26. v. Dobrolevo	868	421	447
	27. v. Malorad	1930	947	983
	28. v. Sirakovo	281	131	150

Municipality	Settlements	Total	Men	Women
Municipality Miziya – entirely	29. v. Voyvodovo	254	117	137
	30. v. Krushovitsa	1599	786	813
	31. v. Lipnitsa	679	331	348
	32. t. MIZIYA	3289	1596	1693
	33. v. Saraevo	46	20	26
	34. v. Sofronievo	1434	687	747
Municipality Oryahovo	35. v. Galovo	294	150	144
	36. v. Leskovets	665	313	352
	37. t. ORYAHOVO	5331	2535	2796
	38. v. Ostrov	1542	759	783
	39. v. Selanovtsi	3662	1765	1897
Municipality Byala Slatina	40. v. Altimir	1223	618	605
	41. v. Byrdarski geran	775	385	390
	42. v. Galiche	1958	938	1020
	43. v. Tarnava	2559	1236	1323
<b>TOTAL</b>		<b>67947</b>	<b>32969</b>	<b>34978</b>

Information source: NSI [42].

The analysis of the sex structure shows little differences between the relative share of men and women. In total for the whole area their percentage difference is 3 % (fig. 3.12.2-2). It is slightly higher in the villages, where the share of men is 48.3 % and of women - 51.7 %, than in the towns (men – 48.8 %, women – 51.2 %). This is related to the higher number of women over the working age in the villages.

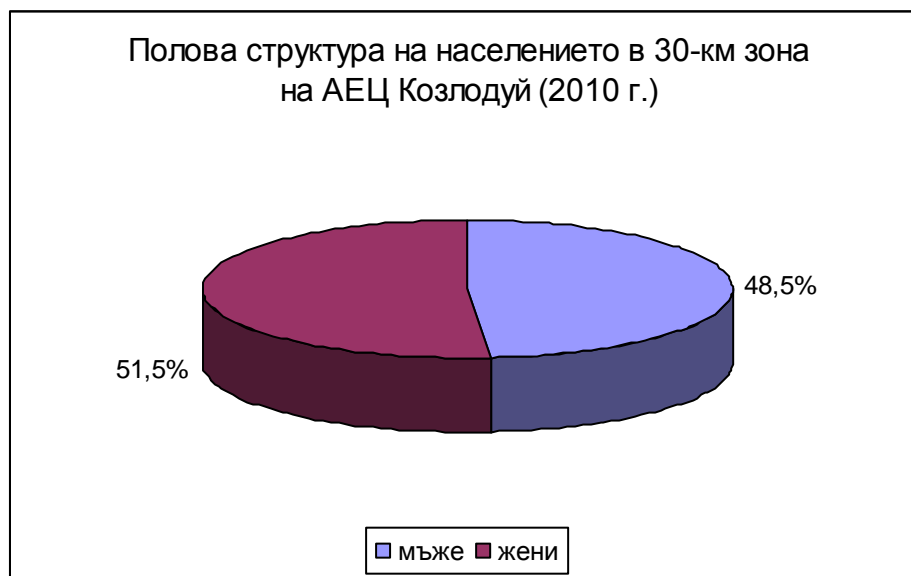

**Fig. 3.12.2-2 Sex structure of the population in the 30-km area of KNPP 2010**

Informational source: NSI

Legend:

Полова структура на населението в 30км зона на АЕЦ Козлодуй – Sex structure of the population in the 30-km area of KNPP

Мъже- male,  
 Жени- female.

Similar is the proportion men to women (48.4:51.6 %) to the total number of the population in

all municipalities, which are entirely or partially included in the 30-km area of KNPP. The total number of population in these 10 municipalities in 2010 is almost 139000 people (table 3.10.2-4).

For the rest of the 30-km zone around KNPP, located on Romanian territory, gender structure of population is absolutely identical - 51.4 % of the population is women - with the Bulgarian part of the area. Is this a coincidence? Rather, this and other demographic characteristics can be explained not only by territorial proximity of the two parts of the area, but a number of common features of their socio-economic and demographic development and the identical characteristics of transformation during the last 20 years. The border is the Danube and instead a natural unifying factor axis and accelerated development rather divides these lands, etc.

The correct calculation of the average density of the population is difficult because of the different data about the areas of the municipalities and the separate settlements in the different sources of information. For calculation of the average density of municipalities information from the National Cadastral Center EOOD as of 31.12.2000 is used, cited by NSI in the statistical guide “Regions, districts and municipalities in Republic of Bulgaria”, 2004 (about the area of the three municipalities Kozloduy, Miziya, Hayredin) and planimetry on the ground of map of the scale 1: 400 000 (the rest of the settlements) [41]. The total area of the 10 municipalities included entirely or partially in this area according to the data of the National Cadastral Center EOOD is 3183.3 km<sup>2</sup>. The average density of the population in these 10 municipalities is 43.6 people per km<sup>2</sup> (2010).

The average density of the population only on the territory of Bulgaria within in the 30-km area around KNPP (38.2 people per km<sup>2</sup>) in 2010 is lower than the average for the areas, where it is located – Vratsa (49.1 people per km<sup>2</sup>) and Montana (42.1 people per km<sup>2</sup>), also than the average for the country (67.6 people per km<sup>2</sup>). The comparison between the municipalities entirely or partially included in the investigated area (table 3.12.2-4) shows that the density of the population in the municipality of Kozloduy (77.3 people per km<sup>2</sup>) is higher than the one of the respective municipalities and the country. Relatively low is the density of the population in Miziya Municipality (34.9 people per km<sup>2</sup>) and Hayredin (27.0 people per km<sup>2</sup>). In the municipalities partially included in the 30-km area the density of the population is between 23.4 people per km<sup>2</sup> (Valchedrum) and 46.5 people per km<sup>2</sup> (Byala Slatina). It should be noted that Lom Municipality stands out with the highest index (91.4 people per km<sup>2</sup>), but in the investigated area is included only one village from it – village Stanevo, situated at the most Eastern part of the municipality.

The predominant part of the population in the Bulgarian part of the 30-km area of KNPP lives in the villages (fig. 3.12.2-3). Through the period 1985-2011 the number of the town population was reduced – from 31.4 thousand people to 25.0 thousand people, but in the same time its relative share increased – from 30.9 % (1985) to 37.9 % (2011). The character of these changes is identical to the change of the number and share of the town population at national and district level. This data shows considerably lower level of urbanization in the investigated territory in comparison to the average for the country - 72.5 % of the population of Bulgaria lives in the towns (2011).

**Table 3.12.2-4 Number of the population of the municipalities which are entirely or partially included in the 30-km area of KNPP (people, 2010)**

Municipalities	Total	Men	Women
Kozloduy	22015	10818	11197
Miziya	7301	3537	3764
Hayredin	5105	2450	2655
<i>Municipalities entirely included in the 30-km area</i>	<i>34421</i>	<i>16805</i>	<i>17616</i>
Lom	29618	14094	15524
Valchedrum	10116	4823	5293
Boytchinovtsi	9746	4812	4934
Krivodol	10276	4978	5298
Borovan	6029	2957	3072
Oryahovo	12069	5788	6281
Byala Slatina	26616	12906	13710
<i>Municipalities partially included in the 30-km area</i>	<i>104470</i>	<i>50358</i>	<i>54112</i>
Municipalities-total	138891	67163	70728

Source: Calculation of the author on data of NSI.

In this respect, the structure of the population residing in the Romanian part of the 30-km zone is similar to Bulgarian - less pronounced urbanization process in comparison with that of a country with a predominantly peasant population. In Dolj the proportion of urban population is 53.7 %, for the study area it is significantly lower - 22.3 %.

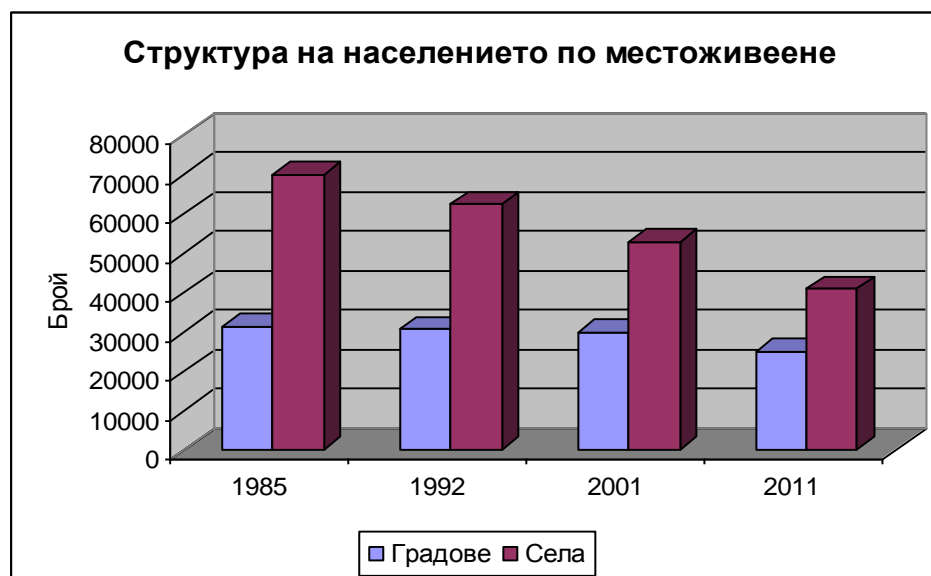

**Fig. 3.12.2-3 Structure of the population by residence**

Source of information: NSI.

Legend:

Структура на населението по местоживеење- Structure of the population by residence

Градове- Towns,

Села- Villages,

Брой- Number

## Reproduction of the population

### Birth-rate, death-rate, natural population growth

The natural population growth in the investigated area is defined by the influence of the numerous multi-directional and diverse demographic and social-economical factors. The tendencies of its change are identical to the changes at district and national level. The number of the newly born and the birth rate decreases while the number of people who die and the mortality rate increases. In 2010 the number of the children born alive is over 2.6 times lower than the number of people who died, which defines the negative natural population growth (table 3.12.2-5). The number of boys born is higher than girls, which is typical characteristic not only for the investigated area, but also for the whole country. Also, the number of men who died is higher than women. At separate settlements the number of born children is very low, especially in smaller villages and in seven of the villages not even one child was born during the respective year.



**Table 3.12.2-5 Number of the born and dead in the 30-km area of KNPP (2010)**

Municipalities	Settlements	Born alive (people)			Dead (people)		
		Total	Boys	Girls	Total	Men	Women
Municipality Lom	1. v. Satnevo	0	0	0	13	6	7
Municipality Valchedrum	2. v. Botevo	0	0	0	1	0	1
	3. v. Bazovets	1	0	1	9	6	3
	4. t. VALCHEDRUM	25	14	11	102	51	51
	5. v. Gorni Tsibar	1	1	0	6	3	3
	6. v. Dolni Tsibar	15	7	8	14	12	2
	7. v. Zlatia	3	1	2	32	14	18
	8. v. Ignatovo	2	0	2	5	4	1
	9. v. Mokresh	10	6	4	22	10	12
	10. v. Razgrad	3	2	1	26	13	13
	11. v. Septemvriitsi	11	7	4	25	14	11
	Municipality Boytchinovtsi	12. v. Beli brod	0	0	0	10	6
13. v. Lehchevo		20	11	9	52	25	27
Municipality Krivodol	14. v. Furen	3	2	1	11	5	6
Municipality Kozloduy – entirely	15. v. Butan	42	16	26	47	22	25
	16. v. Glozhene	32	17	15	47	21	26
	17. t. KOZLODUY	117	70	47	148	67	81
	18. v. Kriva Bara	4	3	1	16	8	8
	19. v. Harlets	25	19	6	37	16	21
Municipality Hayredin – entirely	20. v. Botevo	0	0	0	3	1	2
	21. v. Byrzina	2	1	1	11	6	5
	22. v. Manastirishte	3	2	1	31	18	13
	23. v. Mihaylovo	8	4	4	34	19	15
	24. v. Rogozen	7	2	5	31	10	21
	25. v. Hayredin	6	3	3	81	39	42
Municipality Borovan	26. v. Dobrolevo	12	8	4	34	24	10
	27. v. Malorad	20	8	12	56	30	26
	28. v. Sirakovo	1	0	1	11	5	6
Municipality Miziya – entirely	29. v. Voyvodovo	2	1	1	6	3	3
	30. v. Krushovitsa	9	6	3	51	28	23
	31. v. Lipnitsa	3	3	0	31	11	20
	32. t. MIZIYA	13	9	4	56	25	31
	33. v. Saraevo	0	0	0	2	2	0
	34. v. Sofronievo	10	5	5	31	15	16
Municipality Oryahovo	35. v. Galovo	0	0	0	9	4	5
	36. v. Leskovets	4	1	3	22	14	8
	37. t. ORYAHOVO	45	21	24	97	55	42
	38. v. Ostrov	15	9	6	37	19	18
	39. v. Selanovtsi	35	16	19	92	51	41
Municipality Byala Slatina	40. v. Altimir	13	7	6	33	17	16
	41. v. Byrdarski geran	6	3	3	20	9	11
	42. v. Galiche	20	10	10	48	21	27
	43. v. Tarnava	21	7	14	52	32	20
<b>TOTAL</b>		<b>569</b>	<b>302</b>	<b>267</b>	<b>1502</b>	<b>761</b>	<b>741</b>

Source: Calculations of the author on data of NSI [42].

Similar is the situation both on the territory of the municipalities entirely included in the 30-km area and the municipalities partially included in that area (table 3.12.2-6). The growth of the population in all these municipalities is negative. In 2010 the number of the population in the 10 municipalities has decreased as a result of the natural population growth alone with 1923 people including over 970 men and almost 950 women.

**Table 3.12.2-6 Natural population growth of the municipalities entirely or partially included in the 30-km area of KNPP (2010)**

Municipalities	Natural growth (people)		
	Total	Men	Women
Kozloduy	-75	-9	-66
Miziya	-140	-60	-80
Hayredin	-165	-81	-84
<i>Municipalities entirely included in the 30-km area</i>	<i>-380</i>	<i>-150</i>	<i>-230</i>
Borovan	-120	-54	-66
Byala Slatina	-269	-156	-113
Oryahovo	-183	-108	-75
Krivodol	-228	-116	-112
Boytchinovtsi	-242	-113	-129
Valchedrum	-182	-92	-90
Lom	-319	-187	-132
<i>Municipalities partially included in the 30-km area</i>	<i>-1543</i>	<i>-826</i>	<i>-717</i>
<b>Municipalities–total</b>	<b>-1923</b>	<b>-976</b>	<b>-947</b>

Source: Calculations of the author on data of NSI [42].

Analysis of the natural population growth rate in the 30-km area shows the low values of the coefficients of birth (totally – 8.4 ‰) and the high values of the coefficients of death (totally – 22.1 ‰) (fig. 3.12.2-4). As a result the natural population growth is negative, besides that with considerable value (-13.7 ‰).

The birth rate among the men is higher (9.2 ‰) than that among the women (7.6 ‰). Contrary is the situation referring to the mortality rate, which for men is 23.1 ‰ and for women it is 2 per thousandths lower (21.2 ‰). As a result the natural population the growth of men (-13.9 ‰) is more unfavorable than the one of women (-13.6 ‰).

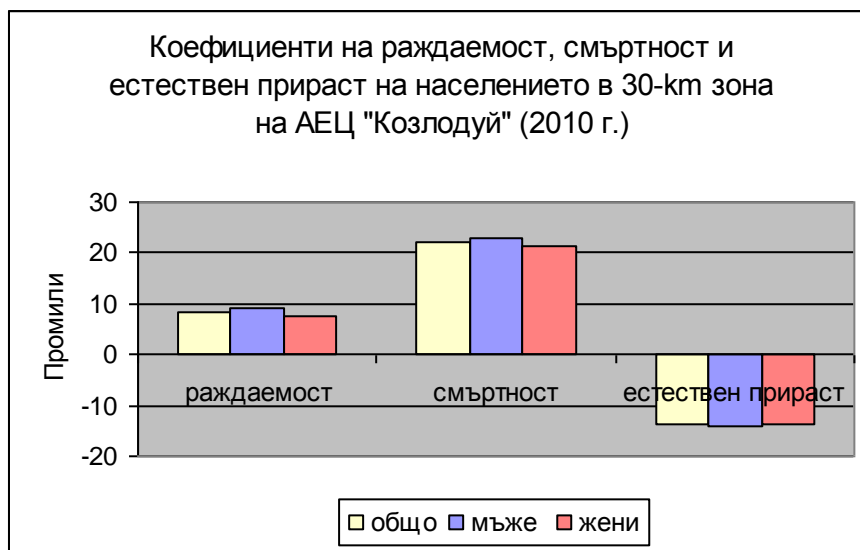

**Fig. 3.12.2-4 Birth, mortality and natural population growth in 30-km area of KNPP (2010)**

Source of information: NSI.

Legend:

Коефициенти на раждаемост, смъртност и естествен прираст на населението 30km зона на АЕЦ Козлодуй- Coefficients of the Birth, mortality and natural population growth in 30-km area of KNPP (2010)

Промили- Per mill

Раждаемост-Birth,

Смъртност -Mortality

Естествен прираст Natural growth

Мъже- male,

Жени- female,

Общо-Total

The comparison of the natural population growth in the towns and villages shows the considerably more unfavorable situation in the village settlements (fig. 3.12.2-5). While the values of the coefficients of birth are comparatively close (villages – 7.7 ‰, towns – 8.8 ‰), there are considerable differences in the values of the coefficients of death (villages – 26.9 ‰, towns – 16.1 ‰). As a result of that the natural population growth in the villages (-17.4 ‰) is over 2.4 times more unfavorable than the one in the towns (-7.2 ‰).

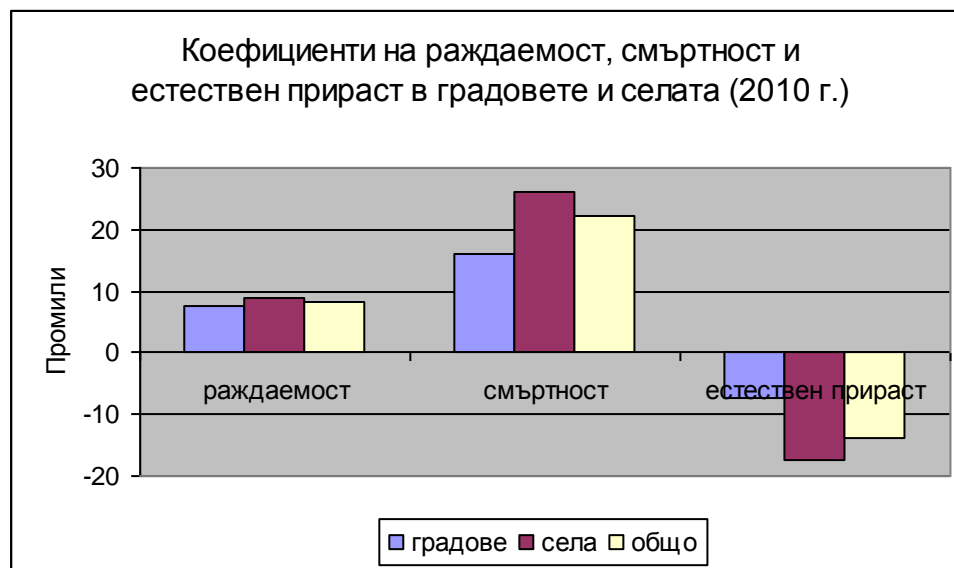

**Fig. 3.12.2-5 Birth, mortality and natural growth in the towns and villages (2010)**

Source of information: NSI.

Legend:

Коефициенти на раждаемост, смъртност и естествен прираст на населението в градове и села-  
Coefficients of the Birth, mortality and natural growth in the towns and villages (2010)

Раждаемост - Birth,

Смъртност - Mortality

Естествен прираст - Natural growth

Градове -Towns,

Села - Villages,

Общо - Total.

The analysis of the natural population growth in the separate settlements of the 30-km area of KNPP shows the considerable differences between them (table 3.12.2-7). In all of the 43 settlements the natural population growth is negative. First of all, this is a consequence of the very high values of the mortality rate in many of the villages, in separate villages times over the average for the investigated territory (in 15 villages more than 1.5 times over the average value of the natural population growth rate for the 30-km area).

**Table 3.12.2-7 Natural population growth in the 30-km area of KNPP (2010)**

Municipalities	Settlements	Natural population growth (people)			Rates of:		
		Total	Men	Women	Birth (%)	Mortality (%)	Natural growth (%)
Municipality Lom	1. v. Stanevo	-13	-6	-7	0	32,1	-32,1
Municipality Valchedrum	2. v. Botevo	-1	0	-1	0	14,3	-14,3
	3. v. Bazovets	-8	-6	-2	6,5	58,8	-52,3
	4. t. VALCHEDRUM	-77	-37	-40	6,8	27,6	-20,8
	5. v. Gorni Tsibar	-5	-2	-3	5	30,3	-25,3
	6. v. Dolni Tsibar	1	-5	6	9,8	9,2	0,6
	7. v. Zlatia	-29	-13	-16	3,5	37,3	-33,8
	8. v. Ignatovo	-3	-4	1	7	17,4	-10,4
	9. v. Mokresh	-12	-4	-8	11,5	25,3	-13,8
	10. v. Razgrad	-23	-11	-12	3,8	32,7	-28,9
	11. v. Septemvriitsi	-14	-7	-7	9,6	21,9	-12,3
Municipality Boytchinovtsi	12. v. Beli brod	-10	-6	-4	0	43,8	-43,8
	13. v. Lehchevo	-32	-14	-18	10,6	27,6	-17

Municipalities	Settlements	Natural population growth (people)			Rates of:		
		Total	Men	Women	Birth (%)	Mortality (%)	Natural growth (%)
Municipality Krivodol	14. v. Furen	-8	-3	-5	9,2	33,7	-24,5
Municipality Kozloduy – entirely	15. v. Butan	-5	-6	1	14,4	16,1	-1,7
	16. v. Glozhene	-15	-4	-11	11,5	16,9	-5,4
	17. t. KOZLODUY	-31	3	-34	8,5	10,8	-2,3
	18. v. Kriva Bara	-12	-5	-7	9,2	37	-27,8
	19. v. Harlets	-12	3	-15	11,7	17,3	-5,6
Municipality Hayredin –entirely	20. v. Botevo	-3	-1	-2	0	40	-40
	21. v. Byrzina	-9	-5	-4	7,2	39,7	-32,5
	22. v. Manastirishte	-28	-16	-12	2,7	28,3	-25,6
	23. v. Mihaylovo	-26	-15	-11	7,8	33,1	-25,3
	24. v. Rogozen	-24	-8	-16	6,7	29,8	-23,1
25. v. Hayredin	-75	-36	-39	3,9	53,1	-49,2	
Municipality Borovan	26. v. Dobrolevo	-22	-16	-6	13,8	39,2	-25,4
	27. v. Malorad	-36	-22	-14	10,4	29	-18,6
	28. v. Sirakovo	-10	-5	-5	3,6	39,1	-35,5
Municipality Miziya – entirely	29. v. Voyvodovo	-4	-2	-2	7,9	23,6	-15,7
	30. v. Krushovitsa	-42	-22	-20	5,6	31,9	-26,3
	31. v. Lipnitza	-28	-8	-20	4,4	45,6	-41,2
	32. t. MIZIYA	-43	-16	-27	4	17	-13
	33. v. Saraevo	-2	-2	0	0	43,5	-43,5
34. v. Sofronievo	-21	-10	-11	7	21,6	-14,6	
Municipality Oryahovo	35. v. Galovo	-9	-4	-5	0	30,6	-30,6
	36. v. Leskovets	-18	-13	-5	6	33,1	-27,1
	37. t. ORYAHOVO	-52	-34	-18	8,4	18,2	-9,8
	38. v. Ostrov	-22	-10	-12	9,7	24	-14,3
	39. v. Selanovtsi	-57	-35	-22	9,6	25,1	-15,5
Municipality Byala Slatina	40. v. Altimir	-20	-10	-10	10,6	27	-16,4
	41. v. Byrdarski geran	-14	-6	-8	7,7	25,8	-18,1
	42. v. Galiche	-28	-11	-17	10,2	24,5	-14,3
	43. v. Tarnava	-31	-25	-6	8,2	20,3	-12,1
<b>TOTAL</b>		<b>-933</b>	<b>-459</b>	<b>-474</b>	<b>8,4</b>	<b>22,1</b>	<b>-13,7</b>

Source: Calculations of the author on data of NSI.

The seriousness of the demographic situation in the 30-km area is also confirmed by the comparison of the coefficients of birth, death and natural growth in the 30-km area of the nuclear plant, in the municipalities Vratsa and Montana and in the whole country (fig. 3.12.2-6). The coefficients of birth of the population in the 30-km area is close but lower in comparison to the two administrative districts (Vratsa – 8.4 ‰, Montana – 8.3 ‰) and lower than the one in the country (10.1 ‰). Highest is also the coefficients of death in comparison to the other territory units – higher with 1.4 ‰ than Montana, with 3.3 ‰ than Vratsa, with 7.4 ‰ than the country. The natural growth rate in the 30-km area (-13.7 ‰) is also higher than the rates in the regions where is situated (Vratsa – minus 10.4 ‰, Montana – minus 12.3 ‰) and almost 3 times higher than the one in the country (minus 4.6 ‰).

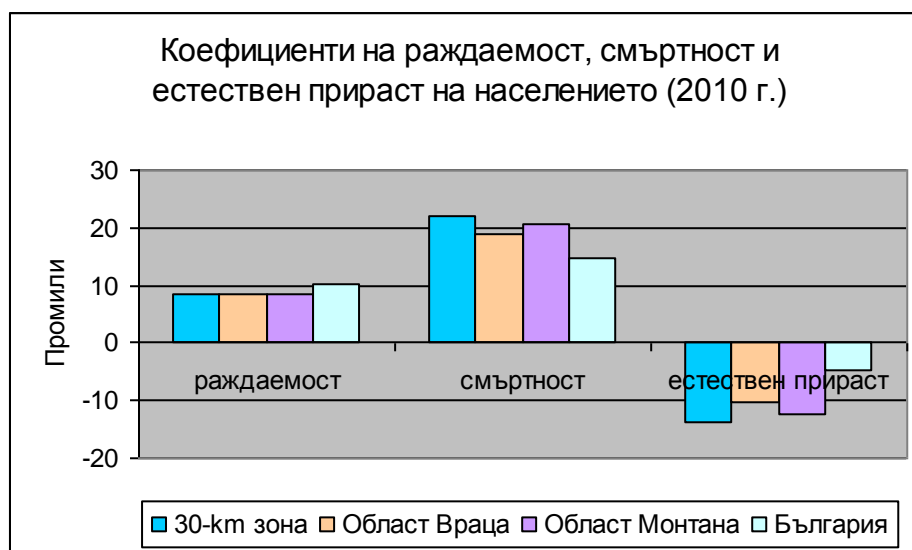

**Fig. 3.12.2-6 Birth, mortality and natural growth rates (2010)**

Source of information: NSI.

Legend:

Коефициенти на раждаемост, смъртност и естествен прираст на населението (2010г.) – Coefficients of the Birth, mortality and natural growth rates (2010)

Промили – Per mill

Раждаемост- Birth,

Смъртност -Mortality

Естествен прираст - Natural growth;

30km зона- 30-km area

Област Враца - Vratsa District,

Област Монтана- Montana District,

България- Bulgaria

The specification of the information only for the municipalities entirely included in the 30-km area shows that the most favorable demographic situation among them is in the municipality of Kozloduy (table 3.12.2-8). With most unfavorable values differs the municipality of Hayredin which is the smallest among these municipalities by the number of its population. Along with rendering an account of other influencing factors there should be noted also the influence of the age structure of the population (table 3.12.2-9).

**Table 3.12.2-8 Natural population growth rate in the municipalities entirely located in 30-km area of KNPP (‰, 2010)**

Municipality	Birth rate	Mortality rate	Natural growth rate
Municipality Kozloduy	10.0	13.4	-3.4
Municipality Miziya	5.1	24.3	-19.2
Municipality Hayredin	5.1	37.4	-32.3
30-km area	8.4	22.1	-13.7

Source: Calculations of the author on data of NSI.

Despite the scarce data on the demographic situation in the Romanian part of the territory concerned it may be judged that a similar demographic processes going on - low fertility, high mortality of the population, poor age structure, declining contingent of women in fertile age, decreasing reproductive and etc. The country's average birth rate is 10.0 ‰, in Dolj (Dolj) this



index decreased to 8.9 ‰. In rural areas it reaches only 8.2 ‰. The overall mortality of the population of Romania is 11.7 ‰. Although it is less than the indicator for Bulgaria, the county of Dolj (Dolj) has higher values – 13.7 ‰ and much higher values are reached in the rural area – 18.6 ‰. The situation is similar to natural population growth as a reflection and result of natural population. In the average natural population growth in Romania -1.7 ‰, the district Dolj population growth is already -4.8 ‰, and in the rural areas -10.4 ‰ (table 3.12.2-9).

**Table 3.12.2-9 Natural growth rate of the population in Romania and in the Dolj area (2007)**

	Live born (‰)	Deaths (‰)	Natural population growth (‰)
Total for the country	10.0	11.7	-1.7
Total for Dolj	8.9	13.7	-4.8
Total for the country-town	9.8	9.7	0.1
Dolj -town	9.4	9.4	0
Total for the country -villages	10.2	14.2	-4.0
Dolj- villages	8.2	18.6	-10.4

Source: Romanian Statistical Yearbook, 2, Population, 2007.

0 to 14-year-olds accounted for less than 14.2 % of the population in the 30-km area in the 2010 Census (table 3.12.2-10). Contrary to this, the relative share of the population over 60 years is very high at 31.5 %. The activities on the construction and operation of the NPP have been a reason for attracting young population in the town of Kozloduy and for formation of very favorable age structure of the population of the town. Since the town of Kozloduy is the biggest settlement in the municipality this has influenced also the age structure of the population in the whole municipality. Highly deformed is the age structure of the population in the other two municipalities, especially in the municipality Hayredin where the process of aging of the population is strongly expressed.

**Table 3.12.2-10 Age structure of the population of the municipalities entirely located in the 30-km area of KNPP (% , census 2011) [42]**

Municipality	0-14 years	15-59 years	Over 60 years
Municipality Kozloduy Town Kozloduy	15.9	63.9	20.2
Municipality Miziya	15.1	68.0	16.8
Municipality Hayredin	12.4	53.1	34.4
Municipality Hayredin	10.5	47.0	42.6
30-km area	14.2	54.3	31.5

Source: Calculations of the author on the final data of 2011 census, www.nsi.bg.

The comparison of the age structure of the population in the 30-km area to the age structures of the population in the municipalities Vratsa and Montana and the average for the country shows the more progressed process of aging of the population in it and the worsening of the age structure (table 3.12.2-11). The lower relative share of the population at the age groups 0-14 and 15-59 in comparison to the previously mentioned regions and the country has an impact on the opportunities for formation of work force in the 30-km area. The considerably higher share of the elderly population is an evidence for the necessity of adequate

development of the social system on that territory. Particularly high is the relative share of the women older than 60 years (over 1/3 of the number of women in 2010 were at age over 60).

**Table 3.12.2-11 Age structure of the population (% , Census 2011)**

	<b>0-14 years</b>	<b>15-59 years</b>	<b>Over 60 years</b>
30-km area	14.2	54.3	31.5
Municipality Vratsa	13.4	57.6	29.0
Municipality Montana	12.8	55.1	32.1
Bulgaria	13.3	60.9	25.8

Source: Calculations of the author on the final data of 2011 census, www.nsi.bg

Presence of deepening negative demographic processes is shown for the Romanian territory within the range of the 30-km zone around KNPP. The data suggest the distribution of population by age group for the district Dolj. Since we have no details in this respect to the investigated part of the zone of influence it will be referred to the data field, accepting them as valid for the investigated area as well. Of the total population of the area (712,178 people) in the under working age (from 0 to 19 years) were 14.47 %. Working age is 68.56 % of the population. In the over working age group (over 65) are 17.0 %. From the adjusted data it is shown that the proportion of under working age population is very small compared with that of the working population. This means that in future there will be no balance required for normal development of the demographic study area and the demographic situation will continue to get worse.

### **Mechanical population growth**

For defining the size and significance of the mechanical growth only the internal migration shifts are taken into consideration, because of the absence of data for the number of the emigrants from these settlements and possible immigration. At the time of the construction of the nuclear power plant and the production and operational units related to it, KNPP as a national site attracts considerable number of workers and specialists. Upon the commissioning of the plant, the specialists working at the plant were settled in the town of Kozloduy. After the shutdown of part of the units some of the specialists quit their jobs. The number of the people migrating from the town is increasing. Nowadays as a whole in the 30-km area the number of the people settling (1442 people, 2010) is lower than the number of the emigrants (1826 people) (table 3.12.2-12). The balance of the migration is negative as in the three municipalities located in this area and also in the municipalities which are partially included in it.

**Table 3.12.2-12 Number of the settled in and emigrated from the 30-km area of KNPP (2010)**

Municipality	Settlement	Settled			Emigrated		
		Total	Men	Women	Total	Men	Women
Municipality Lom	1. v. Stanevo	66	40	26	12	8	4
Municipality Valchedrum	2. v. Botevo	0	0	0	6	3	3
	3. v. Bazovets	5	1	4	5	3	2
	4. t. VALCHEDRUM	75	29	46	119	53	66
	5. v. Gorni Tsibar	8	2	6	10	9	1
	6. v. Dolni Tsibar	28	14	14	47	18	29
	7. v. Zlatia	28	13	15	26	14	12
	8. v. Ignatovo	7	3	4	12	8	4
	9. v. Mokresh	27	15	12	35	16	19

Municipality	Settlement	Settled			Emigrated		
		Total	Men	Women	Total	Men	Women
	10. v. Razgrad	19	8	11	40	16	24
	11. v. Septemvriitsi	37	19	18	35	18	17
Municipality Boytchinovtsi	12. v. Beli brod	0	0	0	9	4	5
	13. v. Lehchevo	38	15	23	41	15	26
Municipality Krivodol	14. v. Furen	4	1	3	5	3	2
Municipality Kozloduy – entirely	15. v. Butan	53	26	27	65	21	44
	16. v. Glozhene	57	25	32	57	33	24
	17. t. KOZLODUY	263	113	150	414	198	216
	18. v. Kriva Bara	6	3	3	9	4	5
	19. v. Harlets	36	14	22	49	23	26
Municipality Hayredin – entirely	20. v. Botevo	2	1	1	2	1	1
	21. v. Byrzina	5	2	3	12	3	9
	22. v. Manastirishte	13	7	6	47	21	26
	23. v. Mihaylovo	33	14	19	32	15	17
	24. v. Rogozen	27	10	17	36	17	19
	25. v. Hayredin	61	22	39	45	22	23
Municipality Borovan	26. v. Dobrolevo	9	4	5	17	8	9
	27. v. Malorad	86	39	47	46	22	24
	28. v. Sirakovo	10	6	4	5	3	2
Municipality Miziya – entirely	29. v. Voyvodovo	4	2	2	7	2	5
	30. v. Krushovitsa	24	14	10	36	18	18
	31. v. Lipnitsa	30	12	18	13	7	6
	32. t. MIZIYA	55	26	29	77	28	49
	33. v. Saraevo	0	0	0	0	0	0
	34. v. Sofronievo	15	6	9	20	11	9
Municipality Oryahovo	35. v. Galovo	11	5	6	7	3	4
	36. v. Leskovets	11	6	5	18	9	9
	37. t. ORYAHOVO	95	43	52	112	42	70
	38. v. Ostrov	28	13	15	44	20	24
	39. v. Selanovtsi	62	31	31	66	35	31
Municipality Byala Slatina	40. v. Altimir	28	13	15	37	13	24
	41. v. Byrdarski geran	17	11	6	30	15	15
	42. v. Galiche	25	10	15	56	26	30
	43. v. Tarnava	34	11	23	65	29	36
<b>TOTAL</b>		<b>1442</b>	<b>649</b>	<b>793</b>	<b>1826</b>	<b>837</b>	<b>989</b>

Source of information: NSI.

The mechanical growth of the population in 2010 is -384 people and the number of the men and women of it is almost equal (table 3.12.2-13). In all towns negative migratory balance is observed. In contrast to the data from previous years, characterized by a positive mechanical growth, 2010 data show that the emigrants from Kozloduy are the largest number: 151 people – 85 men and 66 women (table 3.12.2-13). Second is Valchedrum. Miziya and Oryahovo have smaller negative values compared to the first two towns. The number of the men who migrated (321 men) is lower than the number of the women who migrated (421 women). Less are the villages where due to different reasons there is a positive balance (Sirakovo, Stanevo, Furen, Hayredin, Malorad and other). In the predominant part of the villages the number of the population decreases because of the weak mechanical exodus as well.

**Table 3.12.2-13 Mechanical growth of the population in the 30-km area of KNPP (2010)**

Municipalities	Settlements	Mechanical growth		
		Total	Men	Women
Municipality Lom	1. v. Stanevo	54	32	22
Municipality Valchedrum	2. v. Botevo	-6	-3	-3
	3. v. Bazovets	0	-2	2
	4. t. VALCHEDRUM	-44	-24	-20
	5. v. Gorni Tsibar	-2	-7	5
	6. v. Dolni Tsibar	-19	-4	-15
	7. v. Zlatia	2	-1	3
	8. v. Ignatovo	-5	-5	0
	9. v. Mokresh	-8	-1	-7
	10. v. Razgrad	-21	-8	-13
	11. v. Septemvriitsi	2	1	1
	Municipality Boytchinovtsi	12. v. Beli brod	-9	-4
13. v. Lehchevo		-3	0	-3
Municipality Krivodol	14. v. Furen	-1	-2	1
Municipality Kozloduy – entirely	15. v. Butan	-12	5	-17
	16. v. Glozhene	0	-8	8
	17. t. KOZLODUY	-151	-85	-66
	18. v. Kriva Bara	-3	-1	-2
	19. v. Harlets	-13	-9	-4
Municipality Hayredin - entirely	20. v. Botevo	0	0	0
	21. v. Byrzina	-7	-1	-6
	22. v. Manastirishte	-34	-14	-20
	23. v. Mihaylovo	1	-1	2
	24. v. Rogozen	-9	-7	-2
	25. v. Hayredin	16	0	16
Municipality Borovan	26. v. Dobrolevo	-8	-4	-4
	27. v. Malorad	40	17	23
	28. v. Sirakovo	5	3	2
Municipality Miziya – entirely	29. v. Voyvodovo	-3	0	-3
	30. v. Krushovitsa	-12	-4	-8
	31. v. Lipnitsa	17	5	12
	32. t. MIZIYA	-22	-2	-20
	33. v. Saraevo	0	0	0
	34. v. Sofronievo	-5	-5	0
Municipality Oryahovo	35. v. Galovo	4	2	2
	36. v. Leskovets	-7	-3	-4
	37. t. ORYAHOVO	-17	1	-18
	38. v. Ostrov	-16	-7	-9
	39. v. Selanovtsi	-4	-4	0
Municipality Byala Slatina	40. v. Altimir	-9	0	-9
	41. v. Byrdarski geran	-13	-4	-9
	42. v. Galiche	-31	-16	-15
	43. v. Tarnava	-31	-18	-13
<b>TOTAL</b>		<b>-384</b>	<b>-188</b>	<b>-196</b>

Source of information: NSI.

## Settlements

In the 30-km area of KNPP 43 settlements are included – 4 towns (Kozloduy, Valchedrum, Miziya, and Oryahovo) and 39 villages. According to the applied classification of the towns in the country only Kozloduy is included to the group of the small towns (from 10 to 30 thousand people). The other three towns are included to the group of the very small towns (to 10 thousand people). According to the development of the economy and the character of the employment of the population it could be said that Kozloduy, Miziya and Oryahovo have mixed functions, which are defined by the industry, the services, the transport and others. Lower is the meaning of the agricultural activities. The town of Valchedrum has mainly agricultural character. All of the four towns have administrative functions as centers of municipalities.

Small (200-1000 people) and average (1000-2000 people) villages predominate on the territory of the 30-km area. In accordance with Regulation N 5 from 1995 on the classification of the villages this is a total of 29 out of 39 villages. Sixteen of the villages are in the group of the small villages and 13 – in the group of the medium-size. Five villages have over 2000 people population in 2011 and could be referred to the group of the big villages (Selanovtsi, Butan, Glozhene, Tarnava, Harlets). Only 5 villages have fewer than 200 residents and they are in the group of the very small villages. The villages have agricultural functions. Only one of them – Hayredin village has administrative functions as a centre of a municipality.

The Romanian part of the territory falling within the 30-km zone of influence around KNPP includes in total 23 settlements, 2 cities (Dabuleni and Bechet) and 21 villages. In 2009 the number of inhabitants of the town Dabuleni (by information on the Romanian side) is 12819, and the second city - Bechet has 3917 inhabitants. The village with the lowest population is the village Nedeia - 1380 people and with the one with the highest number is the village Sadova -8489 people. Like the Bulgarian villages in the Danube valley, and Romanian villages in this part of the territory of Romania, are located at great distances from one another, which means that their lands are large, the density of the urban network is smaller and thirdly, that the number of inhabitants is also greater than the hilly and mountainous lands, both for Bulgaria and Romania.

### **Economical activity of the population. Economy**

The development of the social-economical and demographic processes during the last two decades exerts negative influence on the dynamic of the number of the working force, of the employed and unemployed in the villages included in the 30-km area of KNPP and also in the whole country. The reduction of the working force is determined by the unfavorable processes of the development of the population, by dropping out of the labor efficiency age, a higher number of the population and entering of smaller quotas, by the migrations from this territory towards other parts of the country or towards other countries, etc. A typical character of the working force is the high relative share of the people who have high school and university degrees, with a specific qualification, concentrated in the municipalities.

Strong influence on the number of the people employed had also the economical changes at the separate settlements, the reduction of the number of the working places, especially in the 90's as a result of closing different companies and the changes in the agriculture and other. Through the last few years the opening of new working places is still insufficient. Also the decommissioning activities of the first units of the nuclear plant had definitely a negative influence in that relation. It reduces the perspectives and the motivation for being employed of

high educated and high qualified working force. According to data from Census 2011 the group of economically active population in the investigated territory includes 24105 people or 42.6 % from the population at the age of 15 or older (table 3.12.2-14). The number (32520 people) and share (57.4 %) of economically inactive people is very high. The number of economically active people is relatively high only in Kozloduy and Miziya, where there are industrial facilities – KNPP and other enterprises providing bigger employment opportunities than the other settlements. In some villages the ratio between these two groups is more favorable – Glozhene, Harlets, Galovo, which are situated close to KNPP and part of the population is engaged in the electricity production and related activities. In most of the villages the number of economically inactive people is several times higher than that of the economically active people – Malorad, Gorni Tsibar, Septemvriitsi and others. In some villages the employed are the smaller part of the economically active people – Mokresh, Razgrad, Butan, Glozhene and others. In most of the above cases the villages are not very close to Kozloduy, there are not industrial facilities in them offering enough employment; their potential to develop industrial activities is limited. Moreover, most of the population has a very low level of education. These people do not have the necessary knowledge and skills to meet modern business requirements. This is also valid for many settlements in the rest of the country, mostly for the North-western regions, where this problem will remain unsolved in the future.

**Table 3.12.2-14 Population of 15 years or older by settlements and economic activity as of 01.02.2011**

Municipalities	Settlements	Total	Economically active			Economically inactive
			Total	Employed	Unemployed	
Municipality Lom	1. v. Stanevo	327	130	101	29	197
Municipality Valchedrum	2. v. Botevo	64	9	9	-	55
	3. v. Bazovets	107	16	..	..	91
	4. VALCHEDRUM t.	3229	1312	1000	312	1917
	5. v. Gorni Tsibar	192	49	34	15	143
	6. v. Dolni Tsibar	1175	552	273	279	623
	7. v. Zlatia	791	249	168	81	542
	8. v. Ignatovo	226	74	44	30	152
	9. v. Mokresh	678	259	113	146	419
	10. v. Razgrad	615	198	100	98	417
	11. v. Septemvriitsi	960	208	173	35	752
	Municipality Boytchinovtsi	12. v. Beli brod	223	67	35	32
13. v. Lehchevo		1509	503	371	132	1006
Municipality Krivodol	14. v. Furen	232	35	20	15	197
Municipality Kozloduy – entirely	15. v. Butan	2354	1054	658	396	1300
	16. v. Glozhene	2291	1099	676	423	1192
	17. t. KOZLODUY	11082	7088	6377	711	3994
	18. v. Kriva Bara	331	86	69	17	245
	19. v. Harlets	1748	889	651	238	859
Municipality Hayredin -entirely	20. v. Botevo	81	14	14	-	67
	21. v. Byrzina	215	82	38	44	133
	22. v. Manastirishte	974	317	259	58	657
	23. v. Mihaylovo	901	210	166	44	691
	24. v. Rogozen	913	252	162	90	661
	25. v. Hayredin	1394	446	369	77	948
Municipality	26. v. Dobrolevo	721	285	152	133	436



Municipalities	Settlements	Total	Economically active			Economically inactive
			Total	Employed	Unemployed	
Borovan	27. v. Malorad	1581	338	243	95	1243
	28. v. Sirakovo	203	61	40	21	142
Municipality Miziya –entirely	29. v. Voyvodovo	243	85	62	23	158
	30 v. Krushovitsa	1533	583	415	168	950
	31. v. Lipnitza	665	189	..	..	476
	32. t. MIZIYA	2786	1421	1155	266	1365
	33. v. Saraevo	42	8	..	..	34
	34. v. Sofronievo	1364	531	411	120	833
Municipality Oryahovo	35. v. Galovo	4246	2005	1573	432	2241
	36. v. Leskovets	226	39	25	14	187
	37. t. ORYAHOVO	611	235	186	49	376
	38. v. Ostrov	1280	254	205	49	1026
	39. v. Selanovtsi	3178	1139	836	303	2039
Municipality Byala Slatina	40. v. Altimir	1019	334	177	157	685
	41. v. Byrdarski geran	682	271	214	57	411
	42. v. Galiche	1681	482	387	95	1199
	43. v. Tarnava	1952	647	508	139	1305
<b>TOTAL</b>		<b>56625</b>	<b>24105</b>	<b>18469</b>	<b>5423</b>	<b>32520</b>

Source: Calculations of the author on the final data of 2011 census, www.nsi.bg

The economic activity rate in the studied area is significantly lower than that of the country and in Vratsa and Montana districts (table 3.12.2-15). Most favorable is the situation in Kozloduy, where the employment rate is above the average for the country (52.1 %). The higher values are due to the electricity production and the related activities. The employment rate in the villages in the 30-km area is very low – 32.6 %, which is lower with 11.8 % than the average for the country, and with 4-5 % lower than that in Vratsa and Montana districts. The share of the employed in the economically active people is also significantly lower. The share of economically inactive people in the studied territory is very high (tables 3.12.2-14 and 3.12.2-15).

**Table 3.12.2-15 Economical activity of the population as of 01.02.2011**

Territory unit	Economic activity rate (%)	Employment rate (%)	Unemployment rate (%)	Economically active people		Relative share of economically inactive people of 15 years or older (%)
				Employed (%)	Unemployed (%)	
30-km area	42,6	32,6	9,6	76,6	22,5	57,4
Kozloduy	64,0	57,5	6,4	90,0	10,0	36,0
Vratsa district	46,7	37,8	9,0	80,8	19,2	53,3

Montana district	47,8	36,8	10,3	78,1	21,9	52,9
Bulgaria	52,1	44,4	7,7	85,1	14,9	47,9

Source: Calculations of the author on the final data of 2011 census, www.nsi.bg

The economical changes, the closure or the reduction of the activities of some companies have led to the occurrence of unemployment. In the most general terms, the appearance of the unemployment is a result of the decline in production, the lack of correspondence of the labor-market and insufficient disclosure of work places. According to data from the 2011 census, the number of unemployed in the 43 settlements in the KNPP 30-km area is 5423 (table 3.12.2-14). The registered unemployed are a significant part of the economically active people - over 1/5 (table 3.12.2-15). Similar is the situation in Vratsa and Montana districts. The calculated unemployment rate (according to data from the 2011 census) is higher than the average for the country and close to that for Vratsa and Montana districts. The unemployment rate is lowest in Kozloduy. According to the data from Kozloduy Municipality as a result of the active measures and programs conducted by the Ministry of Labor and Social Policy at the local labor market, the number of unemployed and the unemployment rate decreased after the year 2000. In 2007 the unemployment rate in the municipality is 8.5 %. The tendency of reduction continued also in 2008 - the unemployment rate in the municipality is 6.7 %, with an average 6.3 % for the country. In the period 2009 - 2011 the present economic crisis exerted its influence on the total employment in the country. In this relation the unemployment marks a slight increase as for the whole country and also for the administrative districts of Montana and Vratsa. This applies to some extent to the studied territory as well. Kozloduy should “soften” this negative effect using the adopted in 2006 Updated strategy for the decommissioning of KNPP Units 1-4 [43]. According to the adopted strategy about the so called "continuous dismantling" during both the stages of the decommissioning of the units, the personnel of highly qualified and experienced professionals who have operated the suspended reactors is redirected to employment at the new decommissioning activities of the Units. In this relation there is an agreement signed between KNPP and SE “RAW” giving more detailed characteristic of the employment re-contracting and transfer of the personnel of KNPP – EP-1 to the new employer SE ”RAW”. By this many positive aspects will be achieved in practice - maintenance and provision of jobs for the specialists made redundant due to the shutdown of the reactors, using their rich experience and knowledge, achieving greater efficiency in the new activities, ensuring continuity and last but not least the negative crisis effects will affect less the level of unemployment. The retention of qualified staff in the new activities on the decommissioning may also have another positive effect - providing qualified personnel for the eventual construction and operation of the new 7<sup>th</sup> Unit of KNPP.

The work force is characterized by the high relative share of people with secondary and higher education, with specific qualification, concentrated in Kozloduy Municipality (table 3.12.2-16). However, the level of education in most of the settlement in the studied territory is low. In most cases the number of people with primary, elementary, not completed elementary education and those who have never been to school is over 50 % from the population – Glozhene (54.1 %), Lipnitsa (56.1 %) and others.

**Table 3.12.2-16 Educational structure of the population (relative share of the people at 7 or more years of age by degree of completed education as of 01.02.2011, %)**

Territory unit	Higher education	Secondary education	Primary education	Elementary education	Not completed elementary	Never been to school	Children (incl. those below 7
30-km area							
Kozloduy Municipality	10,1	41,3	32,0	9,5	5,5	1,1	0,2
Kozloduy town	17,0 23,8	43,4 45,5	22,9 17,8	8,7 7,0	6,0 5,1	1,6 0,6	0,2 0,2
Vratsa district	14,9	46,6	25,4	7,3	4,7	0,9	0,2
Montana district	12,2	45,5	27,6	8,7	5	0,8	0,2
Bulgaria	19,5	43,4	23,1	7,8	4,8	1,2	0,2

Source: Calculations of the author on the final data of 2011 census, www.nsi.bg

Due to the lack of statistical data to be used as a basis for finding a correlation between the educational and ethnic structure, our research cannot be definite in this relation. Data on the ethnic structure of the population in the studied territory show that the share of the Bulgarian population is higher (89.5 %) than that for the country. This part of the country is characterized by the almost complete lack of Turkish and other ethnic groups' population. However, with the average relative share of the Roma population in the country of 4.9 %, its share for the studied territory is almost twice bigger – 9.4 % (table 3.12.2-17).

**Table 3.12.2-17 Ethnic structure of the population (% , as of 01.02.2011)**

Territory unit	Bulgarian	Turkish	Roma	Other	I do not self-identify
<b>30-km area</b>	89,5	0,3	9,4	0,2	0,5
<b>Vratsa district</b>	92,7	0,3	6,2	0,3	0,5
<b>Montana district</b>	86,3	0,1	12,7	0,3	0,6
<b>Bulgaria</b>	84,8	8,8	4,9	0,7	0,8

Source: Calculations of the author on the final data of 2011 census, www.nsi.bg

During the past few years opening of new job positions has still been inadequate. The shutdown of the KNPP 4 Units has a definite negative impact on that, lessening the opportunities and motivation for employment of highly educated and qualified personnel.

Leading position in the structure of the economy and employment is the one of the secondary (industry and construction) and the primary sectors (agriculture). The largest share in the structure of the industry is the one of the activities for production and distribution of electricity. There are a few large industrial plants (NPP, Pulp and Paper Plant in the town of Miziya, Agrotechchast in the town of Oryahovo, etc.). The nuclear power plant is the most important industrial company in the 30-km area as a source of revenue for the national budget as a source of jobs. The operation of the Pulp and paper plant is still very limited. In Oryahovo spare parts and attached agricultural equipment are produced. Significantly larger is the number of the small and medium companies. They are mostly from the manufacturing

industry and are specialized in various sectors - food processing (mills, production of eggs and poultry meat, slaughterhouses and production of meat products, milk processing, production of soft drinks, bread and pastries, etc.) machine-building production (hydraulic and mechanical jacks, fasteners and joining parts, etc.), woodworking, sewing and knitting production, etc. Small is the number and proportion of the companies from the extractive industry – extraction of aggregates, building materials, gas and others. Defined role in the economy of this territory have the construction companies engaged primarily in construction and repair works related to the nuclear power plant and also to new civil construction and repair activities, and activities in the implementation of projects under various programs (for example under operational program “Environment” in the municipality of Kozloduy and others).

For the development of the agriculture there are facilities for the fertile soils, plain-hilly relief and favorable agro-climatic and hydrological conditions. Various forms of organization of production have been developed - co-operatives, large leaseholder farms, and small private farms. Agriculture employs are some of the workforce. It is also a source of income for a part of the pensioners. The agriculture is specialized mainly in the production of grain (wheat, corn, etc.), production of sunflower and others. This production is both for the needs of the market and for private needs. Significantly less is the production of vegetables and fruit, mainly for private needs. Through the last years the stock-breeding production is insufficient, mainly for private needs.

The development of the services contributes to the better service to the population, to create new work places and to increase the income of the population. Highest number of work places is opened at the different types of trade facilities, the education and the public health care.

In the investigated area various types of transport are developing. Danube River, which develops as a pan-European transport Corridor No 7, provides opportunities not only for transport, but also for economical relation and cooperation with other Danube countries. In the 30-km area are built two ports for different purposes - in the town of Oryahovo (ferry link with Romania) and in the town of Kozloduy (with importance for the NPP). Nearby is the port of Lom. Greatest importance for the realization of internal connections and for connecting with other cities in the country there is a road transport. The narrow-gauge railway line to Oryahovo is no longer active. The nearest railway line is Mezdra-Brusartzi-Lom.

Through the last years the importance of tourism is increasing, for the development of which at the present stage there are insufficiently used resources. Major tourist attractions for the development of informative tourism are the national museum - ship “Radetski”, the Botev’s road and Botev’s park, the ruins of ancient Roman fortresses in the lands of Harlets, Kozloduy, Oryahovo and other. There are certain opportunities for development of business tourism in relation to visits of specialists in the NPP, for development of rural tourism, etc.

The importance of the services is increasing for the development of the business – banking services, insurance, internet, business incubator in the town of Kozloduy and others.

The nature of the activities of construction, operation and decommissioning of PMF is not inherently associated with the generation of hazardous effects on demographic processes as well as on the economic structure of the adjoining territory of Kozloduy NPP covered in the 30-km zone, both in Bulgarian and Romanian. Rather, the positive aspects of the implementation of PMF addressed the socio-economic terms are expressed in the many aspects - economic, professional, personal, social, psychological and others.

The involvement of the workforce at various stages of implementation of the investment proposal will lead to a cumulative effect, since in practice there will be a future and a subsequent gradual increase in employment, the labor of those employed in decommissioning suspended Units 1-4 of Kozloduy NPP in building a national repository for radioactive waste and the implementation of a number of other technology projects related to the decommissioning of Units 1-4 of Kozloduy NPP and the issue of workforce 30-km area. Achieving this effect is possible because of developed and approved in 2006 a program for managing the social consequences of the decommissioning of Units 1-4 of Kozloduy NPP.

Moreover, construction of the new 7<sup>th</sup> Unit of Kozloduy NPP, which was recently decided at the Council of Ministers will provide employment not only qualified personnel freed from suspended Units 1-4 of Kozloduy NPP, but would require and accelerated demand for labor not only for its construction, and its operation. In this respect, early to take appropriate action relating to the provision of adequately skilled and experienced workforce.

In part of the 30-km zone of influence of KNPP on Romanian territory, population and economy are no production and service activities associated with both until recently suspended operation of the 4 reactors and the activities of IP. Therefore, it is determined that the activities for execution of IP can not have economic and social impacts on the economy and population of the Romanian part of concerned 30-km zone of influence of KNPP.

### 3.13 Health status of the population and the workers

#### 3.13.1 Health status of the potentially affected population

##### A) Population of Bulgaria

KNPP is situated in the north-west country region next to the Bulgarian Danube bank on the territory of the Municipality of Kozloduy consisting of one town and four villages:

- Kozloduy – 14445 residents;
- Village of Harlets – 2289 residents;
- Village of Butan – 3088 residents;
- Village of Glojene – 2889 residents
- Village of Kriva bara - 471 residents.

The 30-km area also includes entirely four more municipalities, namely:

- Town of Oryahovo - 12936 residents;
- Miziya town - 7882 residents;
- Vulchedrum town -10986 residents;
- Village of Hayiredin 5658 residents.

Residents of these municipalities are about 60000 people. Besides, within the controlled 30-km also 12 small villages are included that are situated on the Romanian river bank of the municipalities of Lom and municipality of Byala Slatina. Demographic development of municipality Kozloduy compared with the total data for the country about the municipality of Vratsa is presented on fig. 3.13.1-1.

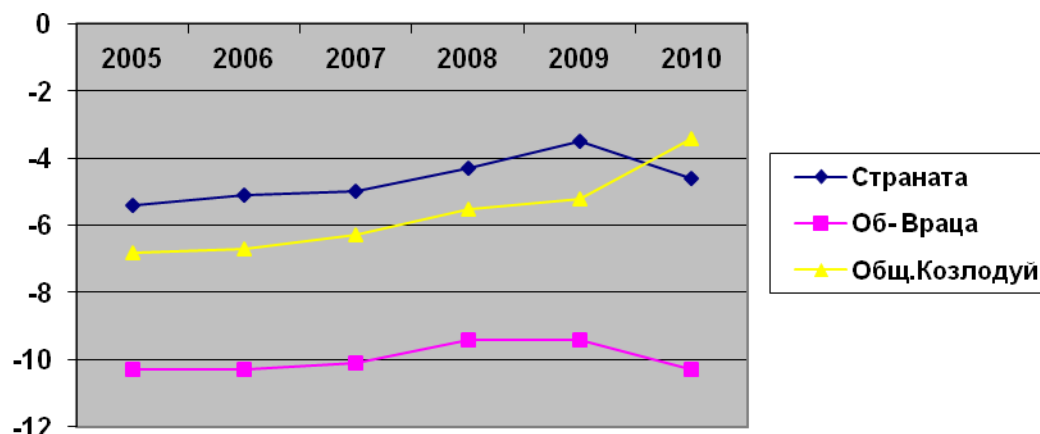

**Fig. 3.13.1-1 Dynamics of the population growth in the whole country, municipality of Vratsa and Kozloduy Municipality**

Legend:

Страната- Country, Blue line

Област Враца- Vratsa District, Pink line

Община Козлодуй - Kozloduy Municipality, Yellow line



Fig.3.13.1-1 demonstrates considerably worse condition of the population growth in the municipality of Vratsa compared with the average data for the country. Demographic processes of the municipality of Kozloduy are considerably better than the ones in the district but they too are worse than the data for the country as a whole. During the last years (until 2010) an ongoing process of reduction of the negative population growth has been developing, which is well expressed in view of the population of the municipality. Better growth of the population of the municipality of Kozloduy is related with the positive mechanical growth of the town of Kozloduy after the construction of KNPP - from 10498 residents in 1975 the growth is to 14445 in 2007.

The age structure of the population in the northwest region of the country is more unfavorable comparing with the average data for the country (table 3.13.1-1).

**Table 3.13.1-1 Age structure of the population**

Municipality	0-9 years of age	10-19 years of age	20-29 years of age	30-39 years of age	40-49 years of age	50-59 years of age	60-69 years of age	70-79 years of age	80-89 years of age
The entire country	8.17	9.39	13.78	14.94	13.80	13.37	12.32	8.21	2.35
Vratsa	8.8	10.4	11.4	12.9	14.5	14.1	13.6	9.4	3.3

Data presented on the above table show considerable differences in the age structure of the population in the country and in Vratsa municipality. The percentage of the population over 40 years of age is larger than in all other age decades.

The unfavorable age structure of the population in the district, due to the mechanical dynamics of the population and the work force, largely does not apply to Kozloduy municipality. Table 3.13.1-2 shows data on the municipalities in the 30-km area of KNPP.

**Table 3.13.1-2 Age structure of the population within 30-km area**

Municipality	Population	Below the capable for working age		In capable for working age		Above the capable for working age	
		Number	%	Number	%	Number	%
Kozloduy	24 244	4 954	20%	14 560	60%	4 730	20%
Miziya	9107	1 369	15%	4 605	51%	3 133	34%
Oryahovo	14 495	2 200	15%	7 362	51%	4 933	34%
Hayredin	6 565	920	14%	2 706	41%	2 939	45%
Vulchedrum	12 573	1959	16%	5 542	44%	5 072	40%
Total							

Data presented above show that except in the Municipality of Kozloduy the number of the population below the capable for working age is less than the one above the capable for working age and the citizens of working age are 50 or below 50 %. The only exception is the municipality of Kozloduy.

Considerable reduction of the demographic resource and advanced in age population could be also explained with higher death-rate and partially in the district of Vratsa Group 2 demonstrates higher frequency (per 1000 people) of the death-rate of Vratsa District. Data about the municipality of Kozloduy are more favorable and are close to the average data for the country.

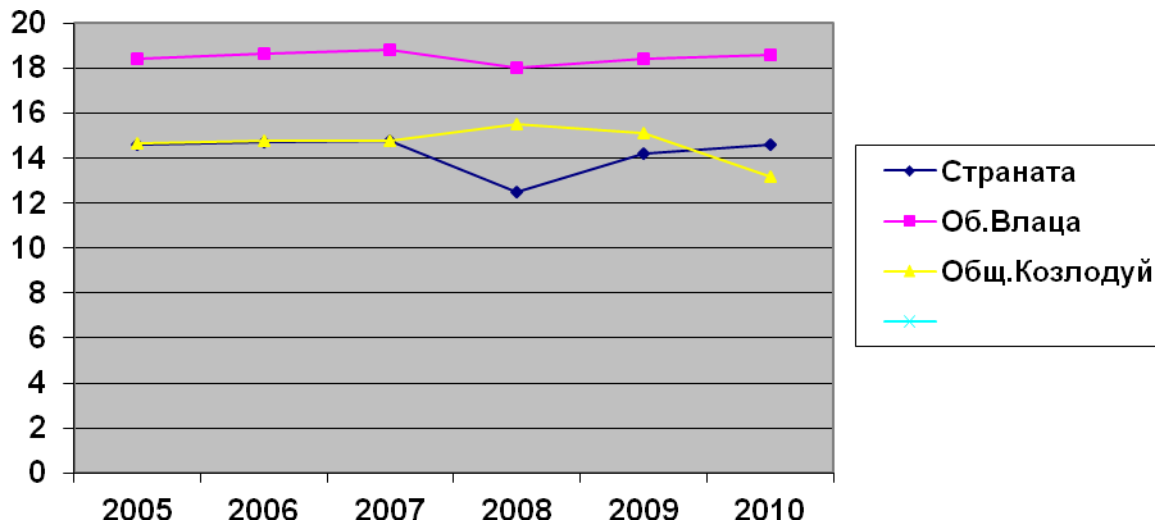

**Fig. 3.13.1-2 Dynamic of the processes of the death-rate among the population of the municipality of Kozloduy, District of Vratsa and Bulgaria**

Legend:

Страната- Country, Blue line,

Област Враца- Vratsa District, Pink line

Община Козлодуй - Kozloduy Municipality, Yellow line

NSI data show a constant trend of higher death-rate among the population of the district of Vratsa comparing with the average data for the country. Higher death-rate in the area is mainly a result of the death-rate caused by diseases of the bodies related to the blood circulation (table 3.13.1-3).

**Table 3.13.1-3 Mortality among the population**

Year	Total death-rate (per 100000 people)		Death-rate caused by the diseases of the blood-circulation bodies (per 100000)	
	For the country	For the District of Vratsa	For the country	For the District of Vratsa
2005	1464.8	1826.1	968.1	1231.8
2007	1475.4	1866.3	971.0	1267.0
2009	1424.7	1837.4	940.1	1311.9

Death causes based on which it is possible to manifest the stochastic effect of the ionizing radiation are the malignant diseases and congenital anomalies. Theoretically, the limit effects could impact on the disease frequency of the endocrine system, the blood vessels and the blood as well as on the nerves.

**Table 3.13.1-4 Death-rate of malignant diseases and death-rate caused by the diseases of the respiratory system**

Year	Death-rate of malignant diseases (per 100000 people)		Death-rate caused by the diseases of the respiratory system (per 100000)	
	For the country	For the District of Vratsa	For the country	For the District of Vratsa
2005	231.7	288.3	57.7	95.8
2007	234.9	296.7	59.3	95.5
2009.	226.2	240.1	54.8	71.6

**Table 3.13.1-5 Death caused by the blood diseases, death caused by the diseases of the endocrine system and death caused by the congenital anomalies**

Year	Death caused by the blood diseases		Death caused by the diseases of the endocrine system		Death caused by the congenital anomalies	
	Country	Vratsa District	Country	Vratsa District	Country	District of Vratsa
2005	2.0	0.5	25.6	12.8	3.2	3.3
2007	2.3	0.5	28.3	13.2	2.2	1.5
2009	2.1	4.0	26.2	31.8	12.0	3.0

Data provided in tables 3.13.1-4 and 3.13.1-5 show that among the population of Vratsa District there is a negligible increase of the death-rate caused by the malignant diseases compared to the country as a whole. There is also a slight trend of lower death-rate caused by the malignant diseases over time. These negligible trends also could be related to the age structure of the population - lower death-rate caused by the congenital anomalies and lower percentage of the persons above the active age. This is mostly valid in view of the death-rate caused by the diseases of the endocrine system.

The most frequent malignant diseases in Vratsa municipality compared to the country are shown in table 3.13.1-6.

**Table 3.13.1-6 Data on malignant disease in Vratsa**

Recorded malignant diseases (per 100000)	2005		2007		2009	
	Country	Vratsa District	Country	Vratsa District	Country	Vratsa District
Total	3069,9	3743,7	3330,7	4440,5	3453,8	3944,2
1. Digestive system.	441,9	522,5	498,7	677,1	521,4	539,6
Large Intestine	168,4	166,4	196,5	215,4	212,2	200,7
2. Respiratory system	201,3	254,6	217,6	305,5	221,5	232,5
3.Lacteal gland	532,8	579,9	584,5	656,0	607,2	604,7
4. Female genitals P 23.8	937,2	1382,4	981,3	1365,8	1027,1	1210,9
5. Male genitals PP -HE	310,7	214,8	352,7	371,5	375,7	351,6
6. Urinary system diseases PP 49.4	167,7	150,8	195,1	246,6	211,1	237,2
7.Thyroid PP 32.1	49,0	51,7	52,8	62,2	57,6	61,6
8. Cerebrum	29,6	36,8	32,0	37,2	31,9	34,3

When comparing the data for the country with data for Vratsa a mild trend of higher rate of

malignant diseases among the population of Vidin (table 3.13.1-6.). We consider this fact to be due to the age structure.

In conclusion, the demographic processes and the age structure of the population in Vratsa are more unfavorable compared to the average data for the country. The health status of the population is characterized by a mild trend of higher rate of malignant diseases, which is closely related to the age structure.

### **B) Health status of population within 30-km zone of KNPP in Romania**

The 30-km zone from the Romanian coast of the Danube River includes 19 locations.

Currently, the working population is around 75150 people and is distributed mainly in the following economic activities:

- 38 % are employed in industrial production;
- 15 % are employed in trade and services;
- 10 % are employed in the transport system;
- 8 % in education;
- 5.7 % work in the healthcare system.

In this distribution no evidence of involvement in an environment of ionizing radiation can be found.

Ministry of Health, through the Radiation Laboratory of Hygiene and regional health center in Bucharest in cooperation with local institutions, carry out systematic monitoring of health status for the period 1999 – 2010.

Below data provided by the Romanian side is presented. Data on the monitoring carried out on 78323 residing within a 30-km zone of observation shows:

1. The distribution of population by age shows that the percentage of population over 60 years is much higher than the average data for the country.
2. In all the years of the observation period, mortality of the population in the surveillance zone is lower than the mortality data for the entire Romanian population.
3. Data related to illnesses associated with long exposure to ionizing radiation shows:
  - Throughout the period of solid cancer mortality in the surveillance zone is lower than the average data for the country.
  - The occurrence of illnesses of solid cancers in the surveillance zone is also lower compared with the data for the whole country.
  - Mortality from leukemia and lymphoma in the surveillance zone is rising after 2008. However, no data on the dynamics of this indicator in relation to the entire population of the country.
  - The incidence of illnesses of all types of leukemias and lymphomas, twelve years throughout the observation period, in terms of population in the area show a gradual increase. Since 2007 this increase is significantly. When comparing this frequency with the frequency in four regions around nuclear plants, the highest incidence of solid cancer and lymphomas are found in the area near Kozloduy. As compared to these four areas, the Bechet area in the vicinity of the NPP Kozloduy shows, beginning the

year 2006-2007, the highest incidence rates for solid cancer and leukaemia. However, these values do not exceed the values recorded for general population of Romania.

The results of the dynamics of total mortality rate and incidence of solid cancers in the surveillance zone are lower than the average data for the country. The increase in mortality and incidence of leukemias and lymphomas in recent years among the observed population can be associated with a large percentage of people over 60 years. This is confirmed by data from the ten-year radiological monitoring of atmospheric aerosols and deposited on the surface water of the gamma background (performed in SSMR four points - Turnu Severin, Bechet, and Craiova Zimnitsa) show values much lower than the norms.

## Conclusions

The health status of the population in 30-km zone around KNPP in Romania is not different from that of the whole population.

### 3.13.2 Health status of the potentially affected workers and employees

On the fenced KNPP site different power facilities are located, as well as the entire complex of the auxiliary production activities. In order to guarantee the cleanness of the environment a precise input/output control at the Power plant is made. Work places are located on that site, i.e. they are within the area of the ionizing radiations (Category A).

Health risk for the workers in KNPP is not only a result of the impact of the ionizing radiation. Within the more unfavorable occupational conditions there are still some unfavorable microclimate (very often overheating), intensive noise, vibrations, electromagnetic fields and labor type. Different occupational groups are affected in different extent by different factors. When assessing the health condition of the staff we should consider both their total effect and their specific impact. The medical examination of the KNPP personnel is carried out every year according to the appropriate schedule in KNPP office “Labor medicine”. Analyses of the Disease Rate with Temporary Disability (DRTD) for all workers and employees of A and B categories are presented in table 3.13.2-1.

For the staff of the external organizations there is an administrative limit established for the annual individual effective dose 18 mSv. Pursuant to BNRP’2012 the occupational effective dose rate limit is 20 mSv per years taking into account that the maximum effective dose rate per 5 year does not exceed 100 mSv.

**Table 3.13.2-1 Analysis of morbidity with temporary disability**

Year	Number of employees	% sick people	Frequency of the cases	Missed labor days	Frequency of labor misses	% of often and long-term sick people
2009	4674	37.9	49.91	28017	599.42	4.12
2010	4484	26.58	42.46	26727	596.05	3.05
2011	4251	33.33	56.65	28747	676.24	4.58

Indicators of DRTD reflect mostly the temporary illnesses causing reduction of workability. In great extent their frequency is affected by the epidemiological situation (availability of infectious diseases during the year). This could explain the differences of the number of sick people during the year. Nevertheless, the frequency of the cases during the three years fluctuates within the range of low and average values that are more often announced for the

country. Within these values is also the indicator of frequency of the work absences.

**Table 3.13.2-2 DRTD structure for 2009-2011**

<b>Nosological unit</b>	<b>2009</b>	<b>2010</b>	<b>2011</b>
1. Respiratory system diseases – total			
Acute Catarrh of the upper respiratory tract	5.91	6.189	9.36
Pneumonia	0.64	1.09	0.75
Other respiratory diseases	4.66	4.15	5.08
2. Eye diseases	0.45	0.45	0.33
3. Ear diseases	0.8	0.80	1.43
4. Diseases of the Peripheral Nervous System	4.2	3.2	3.92
5. Diseases of the Central Nervous System	0.10	0.60	0.49
6. Blood system diseases – total			
Hypertonia	1.6	1.70	1.34
Chronic Ischemic Heart Disease	0.60	0.36	0.56
Other Cardiovascular Diseases	0.24	0.45	0.49
7. Gastric and duodenum ulcer	0.30	0.07	0.14
8. Gastritis, enteritis, colitis	2.46	2.12	0.14
9. Malignant neoplasms	0.45	0.40	0.61
10. Non-malignant neoplasms	0.71	0.7	0.99
11. Diseases of genitourinary system	2.35	2.20	2.70
12. Skin diseases	1.19	0.71	1.12
13. Diseases of bone and muscular system	3.79	4.79	2.44
14. Household accidents	2.97	2.77	3.19
15. Occupational accidents	0.06	0.16	0.05

Structure of the DRTD generally repeats the average data for the country - infections of the upper respiratory tract and acute diseases of the respiratory system are at the first place. There is no increased frequency detected of diseases that could be caused by the radiation factor such as blood diseases, blood organ diseases, and malignant diseases.

During the last three years only one occupational disease and several occupational accidents were registered. Percentage of the household incidents is quite higher.

Almost the whole staff of KNPP is subject to periodical preventative medical examinations. Table 3.13.2-3 shows the relative share of the persons with chronic and acute diseases (instant sickness) and newly discovered diseases.



**Table 3.13.2-3 Absolute and relative number of the persons with chronic and acute diseases (instant sickness) and newly discovered diseases for the period 2006-2008**

Year	Personnel		Instant sickness		Newly discovered diseases	
	Affected by them	Recovered from them	Number of diseases	% of recovered	Number of workers	% of recovered
2006	4916	4934	1916	39.63	208	4.30
2007	4963	4903	1453	29.63	287	5.85
2008	4606	4591	1007	21.90	680	14.80

The Table shows that the number of workers with newly discovered diseases is relatively small percentage of the total staff of the power plant. There is no accurate data about the number of the healthy persons but according to the number of the diseases (one person could suffer more than one disease), it could be supposed that about 65-70 % of the staff are healthy persons on the medical point of view.

Arterial Hypertonia is the most frequently occurring disease. It is determined as 14.57 % of the persons who have passed a preventative medical examination and 65 % of the structure of the instant disease rate. These data are mostly related to the labor type which is mostly neurosensory one with considerable nerve and emotional stress.

At the second place are the diseases of the auditory nerve (with 3.15 % of the staff), so we could suppose that there is a relation with the impact of the over-limit noise levels, discopathy (for 1.6 % of the staff) and diseases of the Peripheral Nervous System.

**Table 3.13.2-4 Comparative table of standard DRTD in nosological groups "Frequency"**

Indicators	Incidence				
	Nosological unit	2009	2010	2011	standard
1. Acute viral infections of upper respiratory tract		5.91	6.18	9.36	21.6
2. Pneumonia		0.64	1.09	0.75	1.1
3. Other respiratory diseases		4.66	4.15	5.08	0.9
4. Eye diseases		0.45	0.45	0.33	1.8
5. Ear diseases		0.98	0.80	1.43	3.4
6. Diseases of the Peripheral Nervous System		4.2	3.2	3.92	3.4
7. Diseases of the Central Nervous System		0.1	0.6	0.49	2.6
8. Hypertonia		1.16	1.7	1.34	2.5
9. Chronic Ischemic Heart Disease		0.6	0.36	0.56	0.8
10. Other Cardiovascular Diseases		0.24	0.45	0.49	1.9
11. Gastric and duodenum ulcer		0.3	0.07	0.14	2.7
12. Gastritis, enteritis, colitis		2.46	2.12	2.66	5.6
13. Malignant neoplasms.		0.45	0.40	0.61	0.9
14. Non-malignant neoplasms.		0.71	0.67	0.99	1.5

15. Diseases of the genitourinary system	<b>2.35</b>	2.20	2.70	3.4
16. Diseases of female genital organs	1.22	0.85	1.15	4.9
17. Skin diseases	1.19	0.71	1.12	2.9
18. Diseases of bone and muscular system	3.79	4.79	2.44	4.0
19. Household accidents	2.97	2.77	3.19	5.9
20. Occupational accidents	0.06	0.16	0.05	2.2

**Table 3.13.2-5 Comparative table of standard DRTD in nosological groups Weight**

Indicators	Incidence				
	Nosological unit	2009	2010	2011	standard
1. Acute viral infections of upper respiratory tract		27.33	24.55	41.04	71,7
2. Pneumonia		12.52	19.18	12.53	20,9
3. Other respiratory diseases		36.41	34.30	44.06	31,7
4. Eye diseases		9.07	6.36	3.29	7,1
5. Ear diseases		5.80	9.95	8.40	28,4
6. Diseases of the Peripheral Nervous System		8.03	35.05	39.02	28,9
7. Diseases of the Central Nervous System		4.4	5.07	6.96	21,6
8. Hypertonia		4.54	4.62	6.47	24,7
9. Chronic Ischemic Heart Disease		15.38	14.07	17.34	16,7
10. Other Cardiovascular Diseases		4.17	12.53	8.16	22,5
11. Gastric and duodenum ulcer		4.28	3.67	1.76	28,9
12. Gastritis, enteritis, colitis		10.8	11.47	10.68	26,3
13. Malignant neoplasms.		26.51	29.50	55.89	20,4
14. Non-malignant neoplasms.		24.69	33.34	29.00	34,2
15. Diseases of the genitourinary system		<b>22.3</b>	17.3	27.07	21,5
16. Diseases of female genital organs		14.68	9.99	12.11	61,1
17. Skin diseases		<b>11.7</b>	11.8	12.58	21,5
18. Diseases of bone and muscular system		54.19	23.78	84.89	39,6
19. Household accidents		91.61	94.58	83.32	75,5

20. Occupational accidents	13.5	6.56	3.98	49,3
----------------------------	------	------	------	------

### Occupational diseases and industrial accidents

Occupational diseases are not registered.

Table 3.13.2-6 presents data on accidents at work and lost working days in the period 2009-2011.

**Table 3.13.2-6 Accidents and lost working days in the period 2009- 2011**

Year	Workers	Deadly accident	Total	Lost working day .	Working days lost per 1 employee
2009	4674	-	3	300	6.41
2010	4484	-	7	294	6.55
2011	4251	-	4	222	5.22

By Order AD-2969/27.12.2010 the Executive Director of the Kozloduy NPP for 2011 is an administrative limit of annual individual effective dose of 12 mSv for the staff of Kozloduy NPP and the Bulgarian and foreign experts working in the EP-2 staff of Foreign organizations: 19 mSv for radiation presented duly completed passport or 16 mSv in the absence thereof.

Staff of Kozloduy NPP and the Bulgarian and foreign experts working in CA 1 and CA SFS is an administrative limit of annual individual effective dose of 6 mSv.

Annual limit for occupational exposure is 20 mSv, for each year, according to Ordinance ONRZ -2012.

#### Individual effective dose

Total number of controlled in the Kozloduy NPP in 2011 was 2,904 – 12 % less than in 2010 (table 3.13.2-7). In 2011 by the staff of the Kozloduy NPP controlled 544 persons worked in CA 1, 1194 persons in the CA 2 and 123 persons in the CA SFS. From the staff of external organizations 189 persons worked in CA 1 735 persons in the CA 2 and 80 persons in the CA SFSF.

**Table 3.13.2-7 Number of controlled persons Kozloduy NPP for the period 2007 - 2011**

№	Structural unit	Year				
		2007	2008	2009	2010	2011
1	Staff of Kozloduy NPP	2050	2016	2029	1984	1861
2	external organizations	1131	1061	1437	1313	1043
Total:		3181	3077	3466	3297	2904

The number of professionally exposed persons Kozloduy NPP in 2011 is 35.4 % less than in

2010 (table 3.13.2-8). In 2011 Kozloduy NPP occupational exposure are 648 specialists staff - 14.7% less than 2010 and 208 workers from outside organizations - 36.7 % less than 2010.

**Table 3.13.2-8 Professional irradiated persons in the "NPP Kozloduy" for the period 2007 - 2011**

№	Structural unit	Year				
		2007	2008	2009	2010	2011
1	Staff of Kozloduy NPP	820	738	572	760	648
2	external organizations	361	213	284	566	208
Total:		1181	951	856	1326	856

In 2011, in the control zones Kozloduy NPP total 856 controlled entities have individual dose higher than the level for registration 0.10 mSv, according to Ordinance 32 - 29.5 % of all controlled entities for the year (40.2 % in 2010) .

Over the past five years, the ratio of occupational exposures controlled persons (individual dose above the 0.10 mSv for registration in accordance with Regulation 32) to the total number of controlled entities tendency to decrease (fig.3.13.2-1).

The number of controlled entities in the CA 1 with individual dose above the level of registration 0.10 mSv in 2011 is 113, ie 19.4 % of all controlled entities (table 3.13.2-9).

The number of control staff in the IC 2 in 2011 decreased by 9 % compared to 2010. Individual doses above the 0.10 mSv for registration have 743 people - 38.5 % of all controlled in the IC 2 in 2011 (table 3.13.2-9), 35.8 % less than 2010.

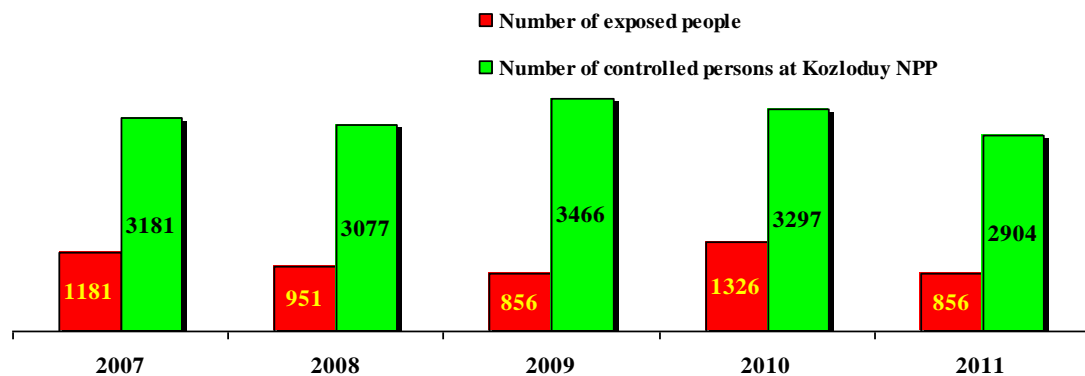

**Fig. 3.13.2-1 Number controlled and number of exposed people in the CA of the Kozloduy NPP for the period 2007 - 2011**

**Table 3.13.2-9 Individual effective doses of CA 1 and CA-SFS 2007 - 2011**

№	Indicator	2007	2008	2009	2010	2011
1	Number of controlled entities	1207	1188	1192	1072	975
2	Number of persons with occupational exposure	297	231	229	158	113
3	Number of persons with an effective dose above	0	0	0	0	0

№	Indicator	2007	2008	2009	2010	2011
	the annual limit for occupational exposure of 50 mSv (ONRZ'2004)					
4	Average individual effective dose [mSv]	0.20	0.10	0.10	0.04	0.04
5	Maximum effective dose [mSv]	6.08	4.62	2.80	1.43	1.26

**Table 3.13.2-10 Individual effective doses of EP-2 in 2007 - 2011**

№	Indicator	2007	2008	2009	2010	2011
1	Number of controlled entities	1974	1889	2274	2120	1929
2	Number of persons with occupational exposure	884	720	627	1158	743
3	Number of persons with an effective dose above the annual limit for occupational exposure of 50 mSv (ONRZ'2004)	0	0	0	0	0
4	Average individual effective dose [mSv]	0.41	0.28	0.25	0.40	0.28
5	Maximum effective dose [mSv]	8.57	9.03	7.28	10.64	6.86

The average individual effective dose in 2011 Kozloduy NPP is 0.20 mSv: the staff of the Kozloduy NPP - 0.24 mSv, the staff of external organizations - 0.13 mSv.

**Table 3.13.2-11 Average individual dose [mSv] in Kozloduy NPP 2007 - 2011**

№	Controlled area	Year				
		2007	2008	2009	2010	2011
1	Controlled area 1	0.20	0.10	0.10	0.04	0.04
2	Controlled area 2	0.41	0.28	0.25	0.40	0.28

The maximum individual dose in 2011 was 6.86 mSv, does not exceed the annual administrative limit for occupational exposure, in accordance with Order № АД 2969/27. 12. 2010 Executive Director of the Kozloduy NPP, reaching 13.7 % of the limit of the annual effective dose of 20 mSv, according to the Ordinance on ONRZ -2012.

**Table 3.13.2-12 Maximum individual dose [mSv] in Kozloduy NPP 2007 - 2011**

№	Structural unit	Year				
		2007	2008	2009	2010	2011
1	Electricity Production 1	6.08	4.62	2.80	1.43	1.26
2	Electricity Production 2	8.57	6.77	6.80	10.64	6.86
3	Common NPP Structures	5.75	9.29	7.28	7.53	5.31
4	External organizations	4.71	3.47	4.90	6.61	4.67
Maximum individual dose [mSv]		8.57	9.29	7.28	10.64	6.86

Continuous decline in the controlled and professionally exposed persons, the average and maximum effective dose for the period 2007 - 2011 can be explained by the completion of the reconstruction and modernization of the units with enhanced safety culture of staff working in controlled areas and the strict dosimetric monitoring compliance with the rules on radiation protection in carrying out planned annual outages.

#### Collective effective dose Kozloduy NPP

Collective effective dose at Kozloduy NPP is 585.56 manmSv in 2011. It is formed from collective effective dose from external exposure determined after measuring the personal deep dose equivalent (Hp10) with individual thermoluminescent dosimeters and Committed Effective Dose HE50 formed by internal irradiation. In 2011, two cases of estimated annual individual effective doses from internal exposure level over the registration 1 mSv, according to Ordinance № 32 on procedures for conducting individual monitoring of persons working with sources of ionizing radiation, publ. SG 91 of 15.11.2005. Individual annual effective dose from internal exposure below for registration – 1 mSv, is recorded as "less than" 1 mSv for the purpose of analysis is assumed to be zero.

Collective effective dose to the staff of at Kozloduy NPP and foreign organizations working in the Controlled Area 1 (CA 1) in 2011 is 35.58 manmSv during the past five years, a durable downward trend (fig. 3.13.2-2) which is due all removal of VVER 440 of operation and the reduction of the volume repairs.

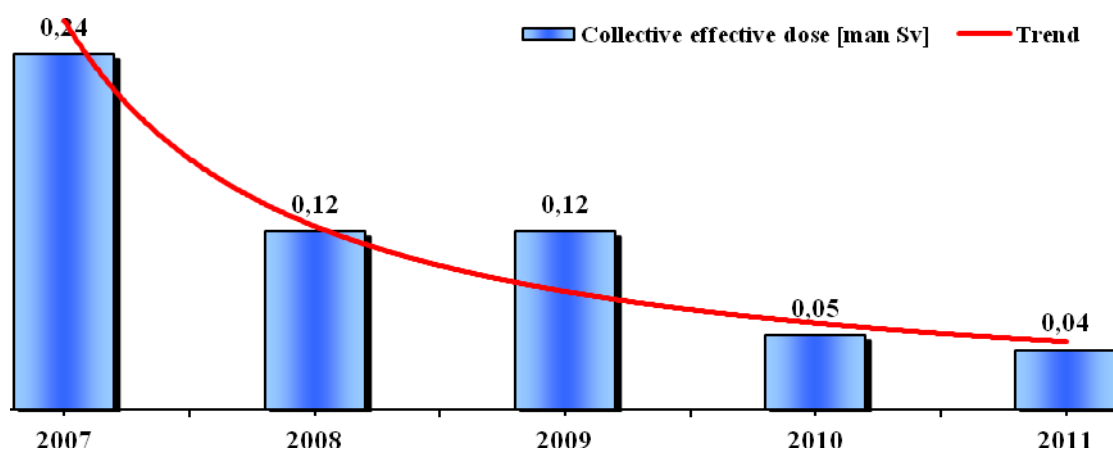
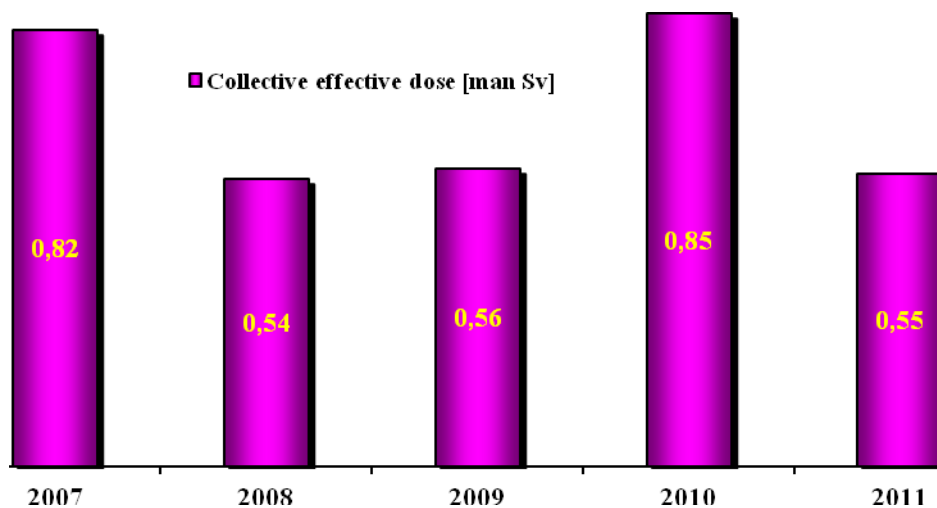

**Fig. 3.13.2-2 Collective effective dose in the CA 1 for the period 2007 - 2011**



Collective effective dose to the staff of at Kozloduy NPP and foreign organizations working in the controlled area of the Spent Fuel Storage Facility in 2011 was 1.22 manmSv, the average individual dose of 0.01 mSv and the maximum dose is 0.19 mSv.

Collective effective dose in CA 2 in 2011 with a registered individual thermoluminescent dosimeters is 546.01 manmSv (fig. 3.13.2-3). Collective dose from internal exposure is 2.75 manmSv.



**Fig. 3.13.2-3 Collective effective dose in the CA 2 for the period 2007 – 2011**

Collective effective dose to the staff of at "NPP Kozloduy" and foreign organizations working in the at Kozloduy NPP in 2011 was 585.56 manmSv and in recent years the downward trend is constant (table 3.13.2-13).

**Table 3.13.2-13 Collective effective dose equivalent at Kozloduy NPP for the period 2007 - 2011**

№	Structural unit	Year				
		2007	2008	2009	2010	2011
1	Staff of Kozloduy NPP	830.29	581.42	532.81	890.09	451.95
2	External organizations	230.17	79.40	142.75	6.61	133.61
Collective effective dose equivalent [manmSv]		1060.46	660.82	675.62	897.51	585.56

According to the World Association of Nuclear Operators WANO, reactor type PWR, the average value of the collective dose to the power unit for the period 2006 - 2010 is in the range 0.54 manSv/unit - 0.60 manSv/unit (reactors in operation and monitored by them). To date, no data are available for 2011 (fig. 3.13.2-4).

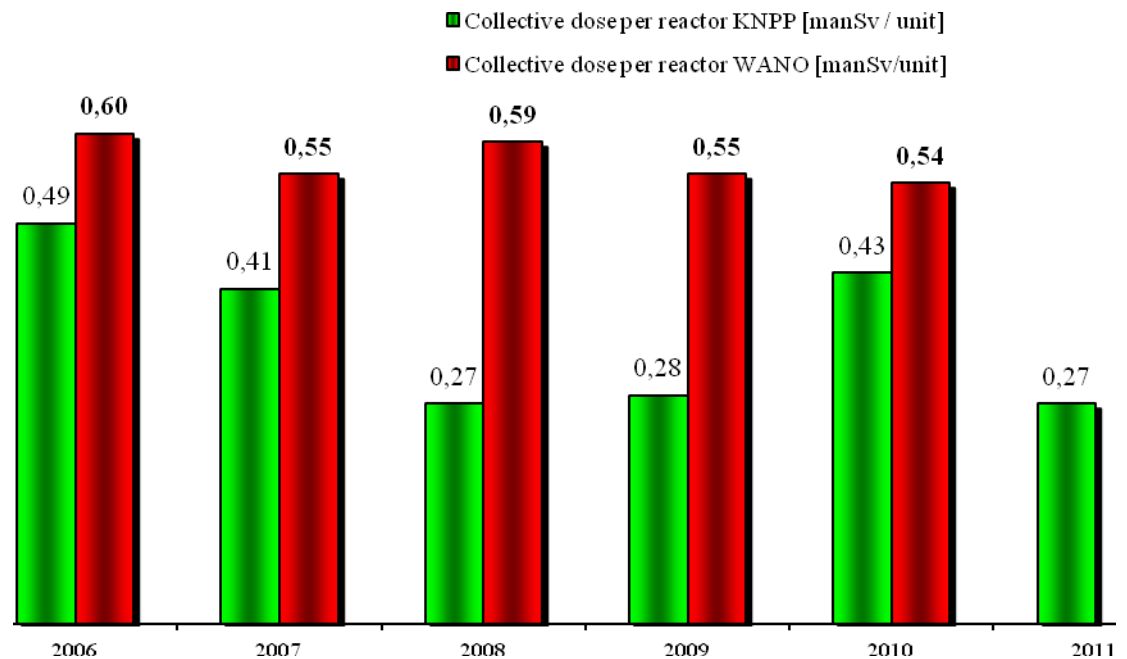

**Fig. 3.13.2-4 Collective dose per reactor KNPP and WANO 2006 - 2011**

International information system for occupational exposure ISOE maintains a database of operating reactors in 32 countries. In February 2012 in his newsletter № 54, ISOE publish the average value of the collective dose to the power unit for the period 2008 - 2010 PWR reactors in Europe, which is in the range 0.53 manSv/unit - 0.63 manSv/unit (FIG. 3.13.2-4). Until the issuance of the report is not available any other information.

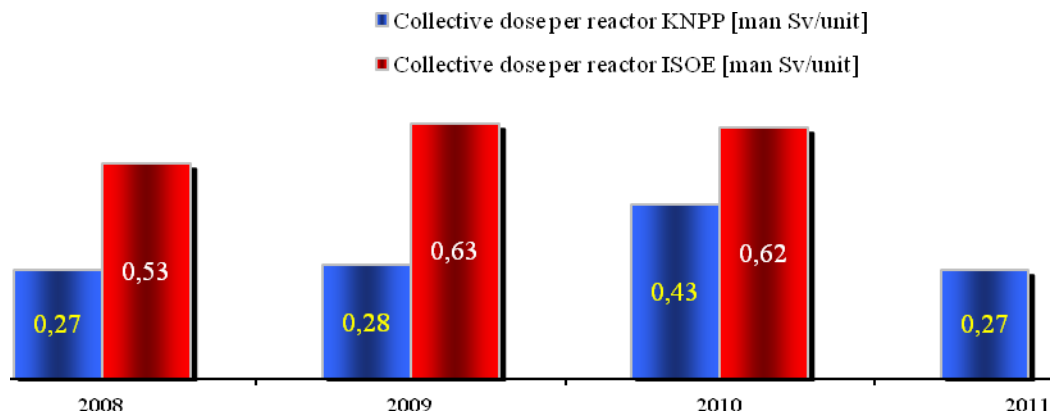

**Fig. 3.13.2-5 Collective dose per reactor (ISOE) in Europe for the period 2007 – 2011**

### Conclusions

Table 3.13.2-14 summarizes the results of personal monitoring of effective dose in the last five years of the Kozloduy NPP.

**Table 3.13.2-14 Occupational exposure to Kozloduy NPP for the period 2007 - 2011**

№	Indicator	2007	2008	2009	2010	2011
1	Number of controlled entities	3181	3077	3466	3297	2904

№	Indicator	2007	2008	2009	2010	2011
2	Number of persons with occupational exposure	1181	951	856	1326	856
3	Collective effective dose [manSv]	1.060	0.661	0.676	0.898	0.586
4	Share of internal exposure in occupational exposure [%]	0	0	0	0	0.5
5	Number of persons with an effective dose above the annual limit for occupational exposure of 50 mSv (ONRZ'2004)	0	0	0	0	0
6	Average individual effective dose [mSv]	0.33	0.21	0.19	0.27	0.20
7	Maximum effective dose [mSv]	8.57	9.29	7.28	10.64	6.86

In 2011, the number of controlled entities decreased by 11.9 % compared to 2010 and by 16.2 % compared to 2009. The number of persons with occupational exposure that form the collective effective dose to individual doses above the level of the registration 0.10 mSv, in 2011 29.5 % of all controlled (59.8 % in 2010).

The average annual individual dose controlled in Kozloduy NPP persons in 2011 was 0.20 mSv and the tendency to reduce (fig. 3.13.2-6).

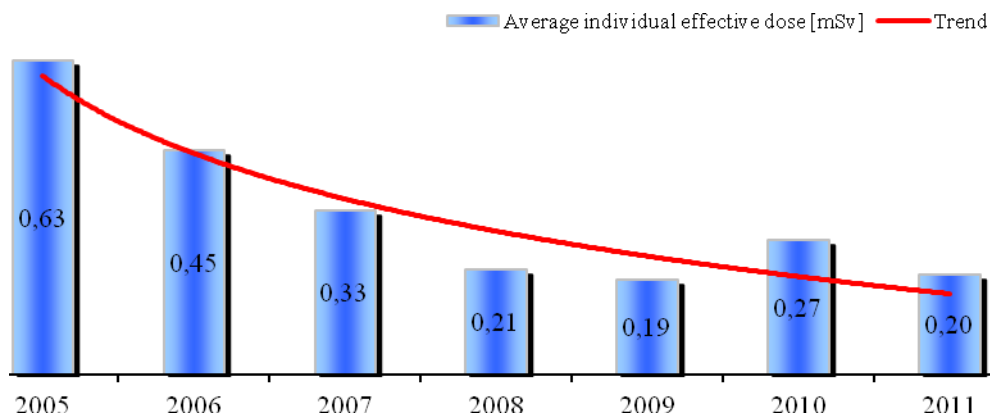

**Fig. 3.13.2-6 Average individual dose Kozloduy NPP period 2005 - 2011**

Maximum effective dose in 2011 - 6.86 mSv is 13.7 % of the annual effective dose limit for occupational exposure 20 mSv, according Ordinance ONRZ-2012 and was lower by 35.5 % compared to 2010, under the administrative boundary for the effective annual dose for the staff of Kozloduy NPP - 12 mSv, according to the Order № AD 2969/27.12.2010 years the Executive Director of the Kozloduy NPP.

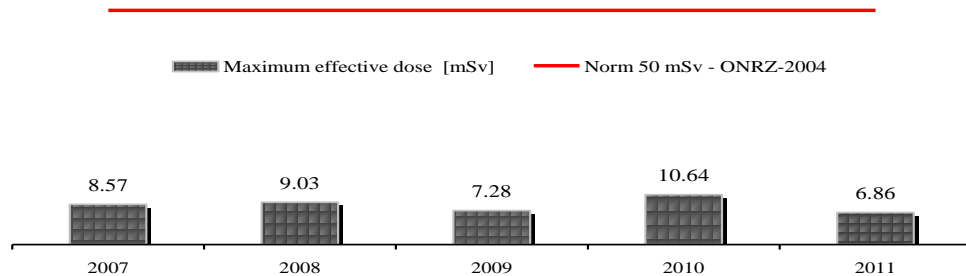

**Fig. 3.13.2-7 Maximum individual dose Kozloduy NPP 2007 - 2011**

#### Conclusions:

1. Collective effective dose Kozloduy NPP in 2011 is 585.56 manmSv and keeps the downward trend in recent years as a result of increased safety culture improved organization of work and strict radiation control in the implementation of planned outages of VVER 1000 and to reduced repair of VVER 440.
  2. In 2011, two rated individual effective doses from internal exposure above the level of registration - 1 mSv, according to Ordinance 32.
  3. The average individual effective dose in 2011 in the Kozloduy NPP - 0.20 mSv trend towards reducing.
  4. Maximum effective dose in 2011 - 6.86 mSv is 13.7 % of the annual effective dose limit for occupational exposure 20 mSv, according Ordinance ONRZ-2012 and was lower by 35.5 % compared to 2010, under the administrative boundary for the effective annual dose for the staff of Kozloduy NPP - 12 mSv, according to the Order № AD 2969/27.12.2010 years the Executive Director of the Kozloduy NPP.
  5. The maximum individual dose from external organizations staff is 4.67 mSv - 9.3 % of the legal limit 20 mSv under Ordinance ONRZ-2012 and does not exceed 16 mSv administrative border to Order AD 2969/27.12.2010 years the Executive Director of the Kozloduy NPP.
  6. The analysis of the results of the independent expert assessment of NCRRP of control with individual film dosimeters of workers from the risks contingent Kozloduy NPP and departmental operational and control TLD showed good agreement within the uncertainties of the methods.
  7. Results of the independent expert assessment of individual dose from neutrons show that traverse the containment and in service of boromerite of Units 5 and 6, and in the CA WSF will register individual annual dose of neutrons greater than 1 mSv and under Ordinance 32 is not necessary to introduce individual control dose of neutrons for all staff.
  8. Over the past ten years Kozloduy NPP not registered individual dose exceeding the limit for occupational exposure 20 mSv, according to Ordinance ONRZ-2012.
- It may be concluded that the results from the systematic health monitoring in many aspects are better than the average data about other work groups. Based on that, it can be assumed that the workers and employees of the plant are in good health.

### 3.14 Hazardous substances

For the purposes of the main productions on the site of Kozloduy NPP different raw materials and materials are stored, including chemical substances and products. The biggest quantities of industrial chemicals are the ones, used both for production of demineralized water and for maintenance of the water chemistry regime of primary and secondary circuits.

The main raw materials used in Kozloduy NPP except the uranium dioxide used as nuclear fuel enriched with  $^{235}\text{U}$  and placed as pellets in the zirconium fuel elements collected in the fuel assemblies include also:

Industrial and laboratory chemicals: nitrogen acid, salt acid, sulphur acid, oxalic acid, sodium base, potassium base, ammonium water, sodium hypochloride, potassium permanganate, ferichloride, hydrate lime etc.

- Industrial chemicals and mixtures;
- Combustibles and lubricants materials; oils (transformer, compressor, turbine, machine etc.), greese and lubricants, diesel fuel, benzine;
- Grounds, paints, varnishes, glues and dissolvents.
- Yon exchange resins;
- Metals.

**Table 3.14-1 Data on hazardous substances used at Kozloduy NPP**

No	Name	CAS No	EC No	Annual amount	Unit	Category of danger	R and S - phrases	Use	Producer/Importer/Supplier
1	2	3	4	5	6	7	-	-	-
<b>Chemical reagents for producing desalinated water, decontamination, etc.</b>									
1.	Hydrochloric acid	-	231-595-7	1600	tons	C, Xn	R: 34,37 S: (1/2-)-26-45	Production of desalinated water and cleaning	Polimeri” AD
2.	Calcium hydroxide (Hydrated lime)	1305-62-0	215-137-3	1300	tons	Xi	R: 41 S: 22-24-26-39	Production of desalinated water	“Ognyanovo-K” AD
3.	Sodium hydroxide	1310-73-2	215-185-5	1200	tons	C	R: 35 S: (1/2-)-26-37/39-45	Production of desalinated water and decontamination	“Polimeri” AD
4.	Iron trichloride	7705-08-0	231-729-4	350	tons	Xn, Xi	R:22-38-41 S: 26-29	Production of desalinated water	“Polimeri” AD



No	Name	CAS №	EC №	Annual amount	Unit	Category of danger	R and S - phrases	Use	Producer/Importer/Supplier
1	2	3	4	5	6	7	-	-	0
5.	Sodium hypochlorite	7681-52-9	231-668-3	115	tons	N, C	R: 31-34-50 S:(1/2)-28-45-50	Circulation cooling system and spray pool	“B-Contact” OOD
6.	Boric acid	10043-35-3	233-139-2	45	tons	-	-	Water chemistry control of I circuit	Società Chimica Larderello SpA
7.	Nitric acid	7697-37-2	231-714-2	60	tons	O, C	R: 8-35 S: (1/2-)-23-26-36-45	Water chemistry control of I and II circuits	“Neochim” AD
8.	Ammonia water	1336-21-6	215-647-6	5	tons	N, C	R: 34-50 S: (1/2-)-26-36/37/39-45-61	Water chemistry control of I and II circuit, corrosion protection, etc.	“Neochim Engineering” EOOD
9.	Sulphuric acid	7664-93-9	231-639-5	15	tons	C	R: 35 S:(1/2-)-26-30-45	Production of desalinated water, maintenance of electrical equipment, and primary circuit equipment	Kumerio Med” AD
10.	Hydrazine hydrate	302-01-2	206-114-9	-	tons	F, C,	R:10-34-43-45-	Water chemistry control	Kontilinks-Him.

No	Name	CAS No	EC No	Annual amount	Unit	Category of danger	R and S - phrases	Use	Producer/Importer/Supplier
1	2	3	4	5	6	7	-	-	-
				3.5		Carc. Cat. 2, T, N	23/24/25-50-53 S: 53-45-60-61	of I and II circuit and corrosion protection	Mark. And Log. EOOD
11.	Potassium hydroxide	1310-58-3	215-181-3	12	tons	C, Xn	R: 22-35 S: (1/2-)-26-36/37/39-45	Water chemistry control, maintenance of electrical equipment and decontamination	Chimsnab-7004-AD
12.	Depositrol BL 5300 (cons. 0.5-2 % sodium hydroxide)	-	-	7	tons	C, Xi	R: 36/38-43 S: 24-26-28-36/37/39	Circulation cooling system and spry pool	GE Betz, "Atiliana Plamen Tzvetkov" ET
13.	Depositrol PY 5200 (cont.< 0.06 % 5-chloro-2-methyl-4-isothiazolin-3-one)	-	-	3	tons	Xi	R: 43 S: 24-26-28-36/37/39	Circulation cooling system and spry pool	GE Betz, "Atiliana Plamen Tzvetkov" ET
14.	Spectrus BD 1501 (cont.< 20 nonyl	-	-	7.5	tons	-	-	Circulation cooling system and spry pool	GE Betz, "Atiliana Plamen Tzvetkov"

No	Name	CAS No	EC No	Annual amount	Unit	Category of danger	R and S - phrases	Use	Producer/Importer/Supplier
1	2	3	4	5	6	7	-	-	0
	phenol ethoxylate)								ET
15.	Spectrus OX 1201 (cont. to 60 % sodium bromide)	-	-	2.5	tons	-	-	Circulation cooling system and spray pool	GE Betz, "Atiliana Plamen Tzvetkov" ET
16.	Oxalic acid	144-62-7	205-634-3	6.5	tons	Xn	R: 21-22 S: (2-)24/25	Decontamination	Chimsnab -7004-AD
17.	Adrinacol	MD	MD	4	tons	MD	MD	Degreasing	Bimas 1954 OOD; Chimsnab -7004-AD
18.	Hydrohicks (cont. 20 % sodium hydroxide and org. substances)	-	-	.2	tons	C	R: 35 S: (1/2-)26-37/39-45	Water chemistry control in the heating system	Hydrohicks Bulgaria" OOD
19.	Sodium sulfide	1313-82-2	215-211-5	2	tons	C, N	R: 34-31-50 S: (1/2)26-45-61	Water chemistry control heating system	Quantities consumed are from previous years. It is not intended for use in

No	Name	CAS No	EC No	Annual amount	Unit	Category of danger	R and S - phrases	Use	Producer/Importer/Supplier
1	2	3	4	5	6	7	-	-	-
									the future.
20.	Sodium carbonate	497-19-8	207-838-8	1.5	tons	-	-	Sanitary building	Chimsnab -7004-AD
21.	Decontaminator DB1	MD	MD	.3	tons	D	MD	Sanitary building	“Vista BM” EOOD; “Chimerecks” OOD
22.	Hydrogenated tallow amine ODACON	61788-45-2	262-976-6	1.2	tons	Xi, N	R: 38-41-50 S: 26-36/37/39-60	Corrosion protection of II circuit	“Finokem” OOD
23.	Boryol	MD	MD	.2	-	MD	MD	Lubrication and cooling liquid	“Anticorrosa” AD - Knezha
24.	Citric acid	77-92-9	201-069-1	0.7	tons	-	-	Decontamination and chemical cleaning	“Brenntag Bulgaria” OOD - Sofia
25.	Potassium dichromate	7778-50-9	231-906-6	.4	tons	T+,O,C Carc. cat.2;N, etc.	R: 21-25-26-37/38-41-43-46-49-50/53 S: 53-45-60-61	G an reactor building	Sofia University "St. Kliment Ohridski"

No	Name	CAS No	EC No	Annual amount	Unit	Category of danger	R and S - phrases	Use	Producer/Importer/Supplier
1	2	3	4	5	6	7	-	-	0
26.	Monoethanolamine	141-43-5	205-483-3	0.6	tons	C; Xn	R: 20/21/22-34	Secondary circuit water chemistry regime	“Finokem” OOD
27.	Potassium Permanganate	7722-64-7	231-760-3	0.5	tons	O, N, Xn	R: 8-22-50-53 S: (2-)60-61	SG decontamination and chemistry cleaning	“Brenntag Bulgaria” OOD - Sofia

No	Name	CAS No	EC No	Annual amount	Unit	Category of danger	R and S - phrases	Use	Producer/Importer/Supplier
1	2	3	4	5	6	7	-	-	-
28.	Developer	-	-	0.3	tons	F	R: 10	Test center “Diagnostics and control”	Magnaflux – UK, NDT Products and Systems OOD - Sofia
29.	Cleaning solution	-	-	0.3	tons	<b>F</b>	R: 10	Test center “Diagnostics and control”	Magnaflux – UK, NDT Products and Systems OOD - Sofia
<b>Ion-exchange resins</b>									
1.	Ion-exchange resin LEWATIT	-	-	<i>Note: There are no regular annual supplies ( in 2006 were delivered 16 tons resins)</i>	-	-	-	Reactor building, of demineralized water	LANXESS DEUTSCHLAND GMBH
2.	Ion-exchange resin AMBERLITE	-	-		-	-	-	Reactor building, of demineralized water	ROHM AND HAAS FRANCE S.A.S.



No	Name	CAS No	EC No	Annual amount	Unit	Category of danger	R and S - phrases	Use	Producer/Importer/Supplier
1	2	3	4	5	6	7	-	-	-
3.	Ion-exchange resin Wofatit	-	-			-	-	Reactor building, production of demineralized water	Bayer Germany
<b>Liquid fuels and maintenance of vehicles</b>									
1.	Diesel fuel Euro diesel	68334-30-5	269-822-7	-00	tons	Carc. cat.3	R: 40 S: (2-)36/37	Automobile transport and DG station	“Petrol” AD; VAYA 7 OOD; Shell, OMV, Lukoil
2.	Unleaded petrol	68334-30-5	269-822-7	-60	tons	Carc. cat.3	R: 40; S: (2-)36/37	Automobile transport	“Petrol” AD; VAYA 7 OOD; Shell Bulgaria

No	Name	CAS №	EC №	Annual amount	Unit	Category of danger	R and S - phrases	Use	Producer/Importer/Supplier
1	2	3	4	5	6	7	-	-	0
3.	Antifreeze	107-21-1	203-473-3	5	tons	Xn	R: 22; S: (2)	Automobile transport maintenance	“Chimtex” OOD; “Petrol” AD;
3.	Gas for lighting (kerosene)	106-97-8	03-448-7	.3	tons	Xn	: 65; S: (2-)-23-24-62	Automobile transport	Dosiev and son” OOD; “Targovia” EOOD
5.	Extraction petrol	-	-	1.5	tons	F+	R: 12	Electrical workshop department	“Valerus – Valeri Rusinov”
<b>Oils</b>									
1.	Turbine oils	-	-	60	tons	Carc. cat. 2; T	R: 45; S: 53-45	Operation	“Prista oil” Sofia; “Lubrica” OOD
2.	Motor oils	-	-	40		Carc. cat. 2; T	R: 45; S: 53-45	Maintenance	“Motobul” EOOD; “Prista oil Trading” OOD; “Prista oil” Sofia; “Petrol” AD; OMV
3.	Transformer oils	-	-	25	tons	Carc.	R: 45; S: 53-45	Operation	“Prista oil Trading”

No	Name	CAS No	EC No	Annual amount	Unit	Category of danger	R and S - phrases	Use	Producer/Importer/Supplier
1	2	3	4	5	6	7	-	-	-
						cat. 2; T			<b>OOD</b>
4.	Hydraulic oils	-	-	6	tons	Carc. cat. 2; T	R: 45; S: 53-45	Maintenance	Prista oil” Sofia; “Global lubricants and chemicals” EOOD; “Insa” EOOD; “Multifors” OOD
5.	General purpose machine oils	-	-	5	tons	Carc. cat. 2; T	R: 45; S: 53-45	Maintenance	Prista oil Trading” OOD
6.	Compressor oils	-	-	3	tons	Carc. cat . 2; T	R: 45; S: 53-45	<b>Operation</b>	Prista oil” AD; “INSA” EOOD; “Licos oil” OOD; “Kirov” AD; “Air technical senter” OOD; “Otto Top” OOD
7.	Transmission oils	-	-	1	tons	Carc. cat. 2; T	R: 45; S: 53-45	Maintenance	Motobul” EOOD; “Prista oil Trading”

No	Name	CAS No	EC No	Annual amount	Unit	Category of danger	R and S - phrases	Use	Producer/Importer/Supplier
1	2	3	4	5	6	7	-	-	-
									OOD; "Prista oil" Sofia; "INSA" EOOD
<b>GREASES AND LUBRICANTS</b>									
1.	Lubricant (K2, graphite, with MoS2, etc)	74869-21-9	278-011-7	0.5	tons	Carc. cat.2	R: 45 S:53-45	Maintenance	Industrial supply" OOD; "Pan Chemistry" OOD; "Stricta TP Vyara Peycheva" ET
2.	Greases (Lithol, Ciatim, graphite, with MoS2, high-temperature, etc.)	74869-21-9	278-011-7	1.5	tons	Carc. cat.2	R: 45 S:53-45	Maintenance	Industrial supply" OOD; "Prista oil" AD; "NYCO S.A"; "Astro engineering"; "Hilti Bulgaria" EOOD; "RKF SEAL TECH" OOD
<b>ADHESIVE AND SEALING COMPOUNDS</b>									
1.	Seals, pastes, adhesives (Loctite,	-	-	3000 pieces ≈	tons	Xn	R: 20/22	Maintenance	Astro engineering"; "Datex" OOD; "RKF SEAL TECH"

No	Name	CAS No	EC No	Annual amount	Unit	Category of danger	R and S - phrases	Use	Producer/Importer/Supplier
1	2	3	4	5	6	7	-	-	-
	Univer, Proma), silicones, liquid metal, etc.			1 - 2					OOD; “Technotrade” EOOD; “S I G Zanevi” SD; “Nikom industrial” OOD; “Rema Tip Top Commerce”; “Technicon group” AD; “Commerce” EOOD; “Hil-Trade” OOD; “George Korchanov” ET; “Dosev and son” EOOD; “V I D International”
Paints, primers, varnishes, thinners and cleaners									
1.	Nonaqueous-based paint (alkyd, oil, etc.)	-	-	10	tons	F, Xn, Xi, N	R:10-20/21/22- 36/38-43-51/53- 65  S: (2-)36/37-46- 61-62	Maintenance	“Lackprom” AD; “Dosev and son” EOOD

No	Name	CAS №	EC №	Annual amount	Unit	Category of danger	R and S - phrases	Use	Producer/Importer/Supplier
1	2	3	4	5	6	7	-	-	0
2.	Water based paints (fasagen, latex)	-	-	7	tons	Xn	R: 22; S: (2)	Maintenance	“Orgachim” AD; “Dosev and son” EOOD; “Commerce” EOOD
3.	Thinners, solvents, rust converters, etc.	-	-	3	tons	F, Xn, Xi, N	R:10-20/21/22-36/38-43-51/53-65 S: (2-)36/37-46-61-62	Maintenance	“Lackprom” AD; “Novostroy Engineering” ET; “Commerce” EOOD; “Biser Yatchev” ET; “Ravin” EOOD; “Dosev and son” EOOD; “AMKO K.Atanasova” EOOD
4.	Koresilin	-	-	7	tons	Xn	R: 22; S: (2)	Electrical equipment maintenance, repairing activities and cleaning	“Lackprom” AD; “Biser Yatchev” ET; “Ravin” EOOD; “Commerce” EOOD



No	Name	CAS No	EC No	Annual amount	Unit	Category of danger	R and S - phrases	Use	Producer/Importer/Supplier
1	2	3	4	5	6	7	-	-	0
5.	Primers	-	-	3	tons	F, Xn, Xi, N	R:10-20/21/22-36/38-43-51/53-65 S: (2-)36/37-46-61-62	Maintenance	“Novostroy Engineering” ET; “Dosev and son” EOOD; “Ravin” EOOD; “Lackprom” AD
6.	Varnishes	-	-	1.5	tons	F, Xn, Xi, N	R:10-20/21/22-36/38-43-51/53-65 S: (2-)36/37-46-61-62	Repair works	“Orgachim” AD; “Commerce” EOOD; “Ravin” EOOD; “Biser Yatchev” ET; “Helas – Ivaylo Georgiev” ET
7.	Ethyl Alcohol	64-17-5	200-578-6	12	tons	F	R: 11 S: (2-) 7-16	Corrosion protection; Electrical equipment maintenance, and cleaning	“Himtex” OOD
<b>Gases and gaseous mixture</b>									
1.	Nitrogen gas	727-37-9	2317839	70	tons	-	-	low down and creation Nitrogen area in electrical	“Kozloduy NPP” EAD

No	Name	CAS №	EC №	Annual amount	Unit	Category of danger	R and S - phrases	Use	Producer/Importer/Supplier
1	2	3	4	5	6	7	-	-	-
								generators and Nitrogen area in Pressurizer	
2.	Nitrogen liquid	727-37-9	2317839	55	tons	-	-	I&C	“Siad Bulgaria” EOOD
3.	Oxygen	7782-44-7	231-956-9	4 3.5	tons tons	O	R: 8 S: (2-) 17	Welding, cutting and repair works	“Meser chimcogas” OOD, “Kozloduy NPP” EAD
4.	Hydrogen	215-605-7	1333-74-0	3.5	tons	F+	R: 12 S: (2-)9-16-33	EIGenerator cooling system	“Kozloduy NPP” EAD
5.	Propane butane	4-98-6 06-97-8	200-827-9 203-448-7	0.8 1000	tons liters	F+	R: 12 S: (2-)9-16	Welding, cutting etc.	“Elena-HB-Prinova” ET
6.	Argon	7440-37-1	2311470	6	tons	-	-	Welding, I&C	“Siad Bulgaria” EOOD
7.	Carbon gas mixture	7440-37-1	7440-37-1	2000	m <sup>3</sup>	-	S: 3-7	-	“Siad Bulgaria”

No	Name	CAS No	EC No	Annual amount	Unit	Category of danger	R and S - phrases	Use	Producer/Importer/Supplier
1	2	3	4	5	6	7	-	-	-
	(82 % Ar and 18 % CO <sub>2</sub> )	124-38-9	2046969					I&C	EOOD
8.	Crisal gas mixture (80 % Ar and 20% CO <sub>2</sub> )	7440-37-1 124-38-9	2311470 2046969	450	m <sup>3</sup>	-	S: 3-7	I&C	“Siad Bulgaria” EOOD
9.	Freon 22 (chlorine di-fluormentan)	D	MD	0.8	tons	MD	MD	Cooling and air conditioning equipment	“Siad Bulgaria” EOOD
10.	Standard gas mixture Ar –CH <sub>4</sub> (90 %-10 %)	7440-37-1 74-82-8	2311470 200-812-7	380	m <sup>3</sup>	<b>F+</b>	R: 12 S: (2-)-9-16-33	I&C	“Meser chimcogas” OOD
11.	Carbon dioxide	24-38-9	2046969	0.2	tons	-	S: 3-7	Automobile transport	Siad Bulgaria” EOOD; “Atomenergoremont” EAD

In table 3.14-1 a reference is presented on the chemical substances and products used in Kozloduy NPP [54]. It includes the main chemical substances and products, used annually by the company exceeding 300 kg. Such are chemical substances, specified in positions 5, 12, 13, 14, 15, 19, 22 and 26 of table 3.14-1 only be used in Units 5 and 6 of the EP-2.

On the site are established conditions for the safe storage of the necessary quantities of oil products - benzine, diesel fuel and oils. To work on service equipment will be used diesel and lubricating oils. Diesel must contain the minimum amount of sulfur, in accordance with the Regulation on the quality of liquid fuels, the conditions and terms of their control, publ. SG. 66 of 25.07.2003, last. amend. SG. 93 of 24.11.2009).

In application of the EPA requirements a classification was made at KNPP concerning the storage and use of chemical substances and the NPP is classified as “enterprise with high hazard potential”. In this regard in 2008 the company obtained operation permit for operation of such enterprise after submission of the needed documents. The competent authority for the supervision in this matter is Vratsa RIEW.

The shut down of Units 1-4 means reduction of the consumption of the industrial chemicals used for regulation of the water chemical regime of first and secondary circuit for regeneration of ion exchange resins as well as for the operations for treatment and decontamination due to termination of the operation of the units. The shut down of Units 1-4 means also reduction of the quantity of anion and cation exchange resins used for water demineralization.

Detailed description of the designation, needed quantities and their reduction as a result of the final shut down of Units 1 and 2 is carried out in [54]. In spite of some differences between Units 1 and 2, on one part and Units 3 and 4 – on the other part due to the uniform capacity of all four Units, it is assumed that the reduction of chemicals upon shut down of Units 3 and 4 is the same like for shutdown of Units 1 and 2.

(1)  $\text{NH}_3$ : Ammonia is stored in one tank (25 % weight) and is used as regulating agent in the primary and secondary circuit.

Consumption: 6 t/year

After the final shut down of Units 3 and 4 the consumption of ammonia is reduced by 12 t/year.

(2)  $\text{H}_2\text{SO}_4$ : sulphur acid is stored in one tank of (8 m<sup>3</sup>), 92 % concentration and is used for regeneration of the cationic resins in the water treatment systems.

Consumption: 30 t year

After the final shut down of Units 3 and 4 the consumption of sulphur acid is reduced by 60 t/year.

(3) HCl: salt acid is stored in one four tanks of 35 % concentration and is used for regeneration of the cationic resins in the water treatment systems.

Consumption 400 t/year.

After the final shut down of Units 3 and 4 the consumption of salt acid is reduced by

800 t/year.

(4) HNO<sub>3</sub>: nitrogen acid is stored in one tank of (12 m<sup>3</sup>), 42 % concentration and is used for regeneration of the cationic resins in the water treatment systems 1, 2, 3 and 5.

Consumption 10 t/year.

After the final shut down of Units 3 and 4 the consumption of nitrogen acid is reduced by 20 t/year.

(5) N<sub>2</sub>H<sub>4</sub>.H<sub>2</sub>O – hydrazine hydrate is used mainly for elimination of the oxygen by the coolant of the secondary circuit. Annual consumption is 5 t/year for Units 1 and 2 (65 % weight).

After the final shut down of Units 3 and 4 the consumption of hydrazine hydrate is reduced by 10 t/year.

(6) KOH: - potassium base is used for regeneration of the anionic resins of WTS 1, 2 and 4, as improvement agent for pH of the first circuit as well as for cleaning of the equipment and rooms. It is supplied in solid condition.

Consumption: 6 t/y and for Units 3 and 4 the consumption of potassium base is reduced by 12 t/year.

(7) NaOH: - sodium base is stored in two tanks (32 m<sup>3</sup> each) (48 % W) and is used for regeneration of the anionic resins in the water treatment systems.

Consumption: 300 t/year

After the final shut down of Units 3 and 4 the consumption of sodium base is reduced by 600 t/year.

(8) FeCl<sub>3</sub>: - ferrous chloride is stored in a tank of 32 m<sup>3</sup> (35 % weight).

for both units the annual consumption is 80 t. After the final shut down of Units 3 and 4 the consumption of ferrichloride is reduced by 160 t/year.

(9) Ca(OH)<sub>2</sub>: calcium dihydroxide is stored in two vertical tanks of 40 m<sup>3</sup> each. It is used for decarbonization of the demineralized water.

Consumption: during the operation of 2 Units it is 230 t/year dry powder product.

After the final shut down of Units 3 and 4 the consumption of ferrichloride is reduced by 430 t/year.

(10) Benzine (fuel for the trucks and cars): used in Kozloduy NPP, but stored in industrial petrol station beyond the territory of the Power plant.

(11) Diesel fuel: used periodically for testing of 12 diesel generators (DG), for Units 1-4.

Consumption: Each DG is tested once monthly during 3 hrs and once per year during 24 hrs. During the test the consumption is 0.4 t/h. Thus the consumption of diesel fuel for all four units is assessed as appr. 150 t/y.

(12) Asbestos: - used as thermal insulating material sealed with cement matrix. Asbestos will be removed from the reactor room, turbine hall and auxiliary facilities

before the stage of preparation for safe enclosure and it will be disposed in the existing Repository in Kozloduy NPP (RCMIW). At the moment of shut down of Units 1 and 2 the asbestos quantities in EP-1 are assessed to 72 t. The same asbestos quantity will be for Units 3 and 4.

Taking into account that the real decreasing of the production of the DW of EP-1, which is related to the shut down of Units 1-4, during the period 2002 – 2008 is increased by 90 %, it could be assumed that the same is the ratio of reduction of the consumption of sulphur, salt and nitrogen acids, sodium base, used for the regeneration of the ion exchange filters, with which the water demineralization will be carried out as well as the demineralization of lime milk and ferichloride, used for coagulation of the salts extracted during the regeneration from sewage waters of the DW generation.

All chemical substances and mixtures should continue to be delivered within the NPP "Kozloduy" PLC-accompanied by Material Safety Data Sheets (MSDS), which is a prerequisite for green use, storage and disposal of their waste and their packaging

### **Conclusions:**

The greatest quantity of industrial chemicals and mixtures used for the production of demineralized water, and to maintain the water chemistry system of primary and secondary circuits.

Decommissioning of KNPP Units 1-4 means reducing the consumption of industrial chemicals and mixtures used to regulate water chemical conditions of the first and second circuit for regenerating ion exchange resins, as well as the operations of purification and decontamination due to the closure of units. It is also mean reducing the amount of anion and cation exchange resins used for demineralization of water.

Management of hazardous chemical substances and mixtures is carried out in accordance with the legislation in Bulgaria. Warehousing and storage is In conformity with the physico-chemical properties to minimize the risk of incidents and accidents.

For environmentally sound management, the supplier is required presentation of the MSDS from where we obtain the necessary information for the safe handling of the substance, transport and storage. It is recommended that in the future when the supply packages of lubricating and engine oils to be provided with safety data sheets in accordance with the Law on Protection against Harmful Impact of Chemical Substances and Mixtures/or the Regulation on classification, labeling and packaging (CLP) .

Required to cool the electric generator hydrogen is produced in electrolyzers own installations. In compliance with the EPA classification is of Kozloduy NPP regarding storage and use of chemicals and the plant is classified as "an upper-tier" and was issued with a permit.



### 3.15 Different types of wastes and their locations

#### 3.15.1 Non-radioactive waste

In table 3.15.1-1 provide classification and quantification of waste generated within the Kozloduy NPP for the period 2007-2011.

**Table 3.15.1-1 Non-radioactive wastes in Kozloduy NPP for the period 2007-2011**

N	Name, description	Code according to Reg N3	Quantity, t				
			2007	2008	2009	2010	2011
Hazardous waste							
1	Non-chlorinated hydraulic oils, mineral based	13 01 10*	-	-	-	-	-
2	Non-chlorinated engine, lubricating and gear oils, mineral based	13 02 05*	13,1	-	26,6	-	7,8
3	Non-chlorinated insulating and heat transmission oils, mineral based	13 03 07*	-	-	4,60	23,14	24,8
4	Interceptor shafts (collector) sludges	13 05 03*	7,60	13,3	-	6	-
5	Oil from oil-water separators	13 05 06*	-	-	2,50	11,5	7,86
6	Gas, steam and diesel fuels	13 07 01*	-	-	-	-	-
7	Other emulsions	13 08 02*	-	-	-	-	-
8	Wastes not otherwise specified (waste greases and lubricants)	13 08 99*	-	-	-	-	-
9	Packaging containing residues of hazardous substances or contaminated by hazardous substances	15 01 10*	-	-	0,20	2,4	3,264
10	Absorbents, filter materials, wiping cloths and protective clothing contaminated by hazardous substances	15 02 02*	-	-	-	-	-
11	Decommissioned vehicles	16 01 04*	-	-	-	-	234,58
12	Oil filters from vehicles	16 01 07*	-	-	-	-	-

N	Name, description	Code according to Reg N3	Quantity, t				
			2007	2008	2009	2010	2011
13	Antifreeze fluids containing hazardous substances	16 01 14*	-	-	-	-	-
14	Transformers and capacitors containing PCBs	16 02 09*	-	12,50	-	0,676	-
15	Discarded equipment containing hazardous components (3), other than those mentioned in 16 02 09 to 16 02 12	16 02 13*	-	-	2,10	3,2	4,302
16	Inorganic waste containing hazardous substances	16 03 03*	-	0,50	0,032	-	-
17	Organic wastes containing hazardous substances	16 03 05*	-	0,40	-	-	-
18	Gases in pressure containers (including halons) containing hazardous substances	16 05 04*	-	-	-	-	-
19	Lead batteries	16 06 01*	-	-	104,7	20,65	47,469
20	Ni - Cd batteries	16 06 02*	-	-	0,30	1,46	1,9
21	Insulation asbestos-containing materials	17 06 01*	0,50	-	13,60	0,06	22,280
22	Construction asbestos-containing materials	17 06 05*	-	-	-	-	-
23	Sludges from physico-chemical treatment containing hazardous substances	19 02 05*	-	-	-	-	-
24	Solvents	20 01 13*	-	-	-	-	-
25	Photographic chemicals and preparations	20 01 17*	-	-	-	-	-
26	Fluorescent tubes and other mercury-containing waste	20 01 21*	1,40	1,40	0,40	3,5	4,29
<b>Industrial waste</b>							

N	Name, description	Code according to Reg N3	Quantity, t				
			2007	2008	2009	2010	2011
27	Sawdust, shavings, cuttings, wood, particle board and veneer other than those mentioned in 03 01 04	03 01 05	5,40	0,90	6,40	5,2	7,8
28	Photographic films and paper containing silver or silver compounds	09 01 07	-	-	-	-	-
29	Photographic films and paper not containing silver or silver compounds	09 01 08	-	-	-	-	-
30	Filings and scrap of ferrous metals	12 01 01	-	-	6,90	6,2	8,08
31	Filings and scrap of non-ferrous metals	12 01 03	-	-	-	0,22	0,420
32	Paper and cardboard packaging	15 01 01	-	0,10	-	-	-
33	Plastic packaging	15 01 02	-	-	-	-	-
34	Metal packaging	15 01 04	-	-	-	-	-
35	Glass packaging	15 01 07	-	-	-	-	-
36	Absorbents, filter materials, wiping cloths and protective clothing other than those mentioned in 15 02 02	15 02 03	3,30	3,50	1,50	-	-
37	Discarded tires	16 01 03	-	15,0	-	2,2	8,212
38	Discarded vehicles, containing neither liquids nor other hazardous components	16 01 06	-	-	-	-	-
39	Antifreeze fluids other than those mentioned in 16 01 14	16 01 15	-	-	-	-	-
40	Discarded equipment other than those mentioned in 16 02 09 to 16 02 13	16 02 14	-	7,80	18,2	64,2	54,739

N	Name, description	Code according to Reg N3	Quantity, t				
			2007	2008	2009	2010	2011
41	Components removed from discarded equipment other than those mentioned in 16 02 15	16 02 16	-	-	8,78	71	41,322
42	Inorganic wastes other than those mentioned in 16 03 03	16 03 04	-	2,40	1,80	6,26	4,392
43	Organic wastes other than those mentioned in 16 03 05	16 03 06	-	0,60	5,20	-	-
44	Alkaline batteries (except 16 06 03)	16 06 04	-	-	-	-	0,099
45	Other batteries and accumulators	16 06 05	-	-	-	-	-
46	Sludges from physico-chemical treatment other than those mentioned in 19 02 05	19 02 06	5,0	-	-	-	-
47	Leachate from landfills other than those mentioned in 19 07 02	19 07 03	1234	1139	839	1365,5	1365,5
48	Waste from grills and screens	19 08 01	8,0	-	-	-	-
49	Sludge from wastewater from settlements	19 08 05	-	-	-	-	-
50	Wastes not otherwise specified	19 09 99	-	-	16,0	-	-
51	Ferrous metals	19 12 02	-	1186	1052,9	1314,2	1508,324
52	Non-ferrous metals	19 12 03	-	16,70	143,28	66,955	81,155
53	Sharp tools	18 01 01	-	-	-	-	-
54	Waste, the collection and the disposal of which is subject to special requirements in order to prevent infection	18 01 04	-	-	-	-	-
Construction waste							
55	Concrete	17 01 01	15,0	4,3	4,0	3,0	4,0

N	Name, description	Code according to Reg N3	Quantity, t				
			2007	2008	2009	2010	2011
56	Dredging soil other than those mentioned in 17 05 05	17 05 06	-	-	-	-	-
57	Insulation materials other than those mentioned in 17 06 01 and 17 06 03	17 06 04	73,0	131,0	79,0	99,9	265,16
58	Mixed waste from construction and demolition, other than those mentioned in 17 09 01 17 09 02 and 17 09 03	17 09 04	67,50	16,60	111,5	156,5	49,75
<b>Municipal waste</b>							
59	Paper and cardboard	20 01 01	74,2	31,30	19,1	6,855	65,03
60	Glass	20 01 02	-	-	-	-	-
61	Medicines other than those mentioned in 20 01 31	20 01 32	0,20	0,20	0,20	-	-
62	Wood other than those mentioned in 20 01 37	20 01 38	-	90,39	56,91	131,2	168,1
63	Plastics	20 01 39	-	6,80	0,30	-	-
64	Other fractions not otherwise specified (sludge cleaning cold channel)	20 01 99	-	-	-	-	-
65	Biodegradable waste	20 02 01	28,6	40,0	43,50	44,3	36,9
66	Soil and stones	20 02 02	2,0	13,0	2,0	-	-
67	Mixed municipal waste	20 03 01	1114,0	1238,9	881	899	957,35
68	Waste from sewage cleaning	20 03 06	16,0	-	-	-	-

**Hazardous waste** - to hazardous waste belong: fluorescent and mercury lamps, batteries generated as hazardous waste systems, emergency power lighting, control and other systems, Auto fleet in the replacement of exhausted batteries. Packages involving chemical substances and mixtures - a majority of the chemicals are supplied in Kozloduy NPP with tanks. When the amount of chemicals is less, they are in drums, cans, glass containers. Waste oil is formed by the cleaning of oily wastewater into the local sewage treatment facilities within the Kozloduy NPP. It is collected in 5<sup>o</sup>t tank and transported by an external company. The total quantity of oil retained in

treatment facilities is about 60 t. Sludge mudtight - with annual 10 m<sup>3</sup>. Data from table 3.15.1-1 indicate that quantities are relatively constant. The new Waste Management Act (SG. 53/2012) establishes requirements for maximum utilization through recycling of waste generated. Hazardous waste should be submitted for further treatment to persons authorized by a permit or registration document under the WMA or recovery organizations holding a permit under Art. 35 WMA.

**Industrial waste** - the largest share of industrial waste in the Kozloduy NPP is metal waste (old worn machine parts, worn steel ropes, etc.) They are not related to direct production activities, and are formed in the repair of the equipment at sites. Besides scrap in the repair of brass pieces of equipment are formed brass waste. This waste should be submitted to the companies or organizations for recovery, according to Art. 67 WMA.

**Construction waste** is generated depending on the volume of repair. The amount varies around 200 m<sup>3</sup> per annum. Sheet as at present be disposed dredging spoil and concrete waste RCMIW, which will continue in stages of decommissioning. Construction waste management during the implementation of the project shall comply with the requirements of the Regulation on management of construction waste and use of recycled building materials (SG, No. 89/134.11.2012).

Household waste - are formed in all workplaces, administrative and industrial buildings, cafes, catering, and cleaning of the plant site from branches, leaves, etc. In accordance with regulatory requirements it is advisable to extend the scope of separately collected waste fractions. For household waste is advisable to continue the separate collection of packaging waste, according to Art. 33, paragraph 4 of the WMA and household waste collected mixed, will be disposed of for the purpose facility regulated as follows: Waste zone of dumb transported to RCMIW and waste sites outside this area - to the regional landfill Oryahovo.

In force by July 2012 law on waste management, non-radioactive waste at Kozloduy NPP is managed under the "Program for non radioactive waste management in the Kozloduy NPP and Rules to ensure the safety of non radioactive waste [62].

Once adopted in July 2012 New WMA, updated the secondary legislation. Therefore, the monitoring of waste generated should be updated accounting books in accordance with Regulation № 2/2013 on the procedures and forms for providing information on waste management activities and procedures for the conduct of public records (promulgated, SG. 05.02.2013) 10 years.

The strengths of the management of non-radioactive waste within the Kozloduy NPP [63] are:

- The availability of landfill for municipal and industrial waste;
- Implementing programs for radiation and non-radiation environmental monitoring in the area of landfill;
- Separate collection and treatment of waste generated;
- Introduced accountability for the classification of waste, keeping the record books, as well as preparation of periodic and annual reports.

Kozloduy NPP has permission to perform the collection, transportation, recovery and



disposal of waste. Authorization issued by the Regional Inspectorate - Varna, which carries out control over the implementation of the activities.

At this stage some of the waste is collected separately for yet another organization has been established for such collection. Among the latter are worked greases and lubricants, small batteries, sodium, and metal halide lamps, packaging of chemical substances and preparations.

On separate collection and treatment shall be:

- Waste which, because of their specific characteristics and/or requirements of the regulations are defined as hazardous;
- Industrial waste, hazardous waste and recoverable production temporarily stored in certain areas of the plant site, and then sold or transferred to persons holding permits, a permit or registration document under the WMA or recovery organizations. Decision 05-TO-72-01 of 12.06.2008 of the Regional Inspectorate - Vratsa for temporary storage of waste prior to disposal is the specific site of RCMIW, regulating the composition and quantities of waste that are allowed to store it. Of that area is allowed to engage in the disposal of waste in a specially designed facility - code D5 (according to the WMA in 2012). That authorization adds provisions of Decision 05-TO-72-00 of 24.01.2006 and is valid until 31.12.2010 and the last amendment of the license is valid until 31.12. 2015.
- Transportation of waste is done with their own specialized and versatile vehicles or machinery Foreign companies operating the site under contract.
- In accordance with regulatory requirements and based on internal company documents in a protected area of Kozloduy NPP is carried out radiation monitoring sites of generation and collection. Containers of household and non-utilizable small industrial wastes are subject to a daily dose control.

### Transportation of waste

Transportation of waste is done with their own specialized and versatile vehicles or machinery Foreign companies operating the site under contract.

### Temporary storage of waste

Table 3.15.1-2 shows the permitted waste quantities for temporary storage on Site 1 in groups as well as the quantities of a part of the production and hazardous waste until 2009 and the levels are coming years are similar to those.

**Table 3.15.1-2 Quantities of waste for temporary storage on RCMIW in Kozloduy NPP**

Code	Type of the waste	Quantity of the waste, t
20.05.01	Domestic waste	1844.5
	Production waste, incl.:	11536.9
19.12.02	ferrous metals;	3000
19.12.03	non-ferrous metals	1200

16.01.03	end-of-life tires	15
19 07 03	infiltrate from waste disposal facilities different than the one specified in 19 07 02	1800
19.02.06	sludge from neutralization pits of EP-1	160
19.08.01	sludge from treatment complex of EP-2: - from grids; - from water treatment	60
19.08.05	waste, not mentioned anywhere (initial treatment CPS and cold channel)	
19.09.99	Paper and carton	1.5 5000
20.01.01		80
17.07.01	Construction waste	326
	Hazardous waste, incl.:	1030.4
20.01.21*	end-of-life luminescent materials and mercury lamps	4
13 01 10*	non-chloric hydraulic mineral oils	5
13.02.05*	non-chloric motor, lubrication oils and gear mineral oils.	500
13.03.07.	non-chloric insulation and heat transmission mineral oils Sludge from oil catchment pits oil from oil-water separators Gasoline, boiler and diesel fuel	200
13.05.03*	Packing, containing waste of hazardous substances	10
13.05.06*	or contaminated hazardous waste	50
13.07.01*	absorbents, filter materials (including oil filters,	0.5
15.01.10*	non mentioned anywhere), towels and protection clothes, contaminated with hazardous materials.	25
15.02.02*	non-organic waste containing hazardous substances organic waste, containing hazardous substances lead accumulator batteries nickel-cadmium batteries	15

16.03.03*	Insulation materials, containing asbestos	3
16.03.05*	construction materials, containing asbestos sludge from neutralizing pits, containing hazardous substances	15
16.06.01*		60
16.06.02*		80
17.06.01*		20
17.07.05*		25
19.02.05*		50

In compliance with the normative requirements and based on the internal company documents in the protected area of Kozloduy NPP radiation control is executed in the place of generation and collection of the waste. Containers with municipal and non-utilized small production waste are subject to daily dosimetric control.

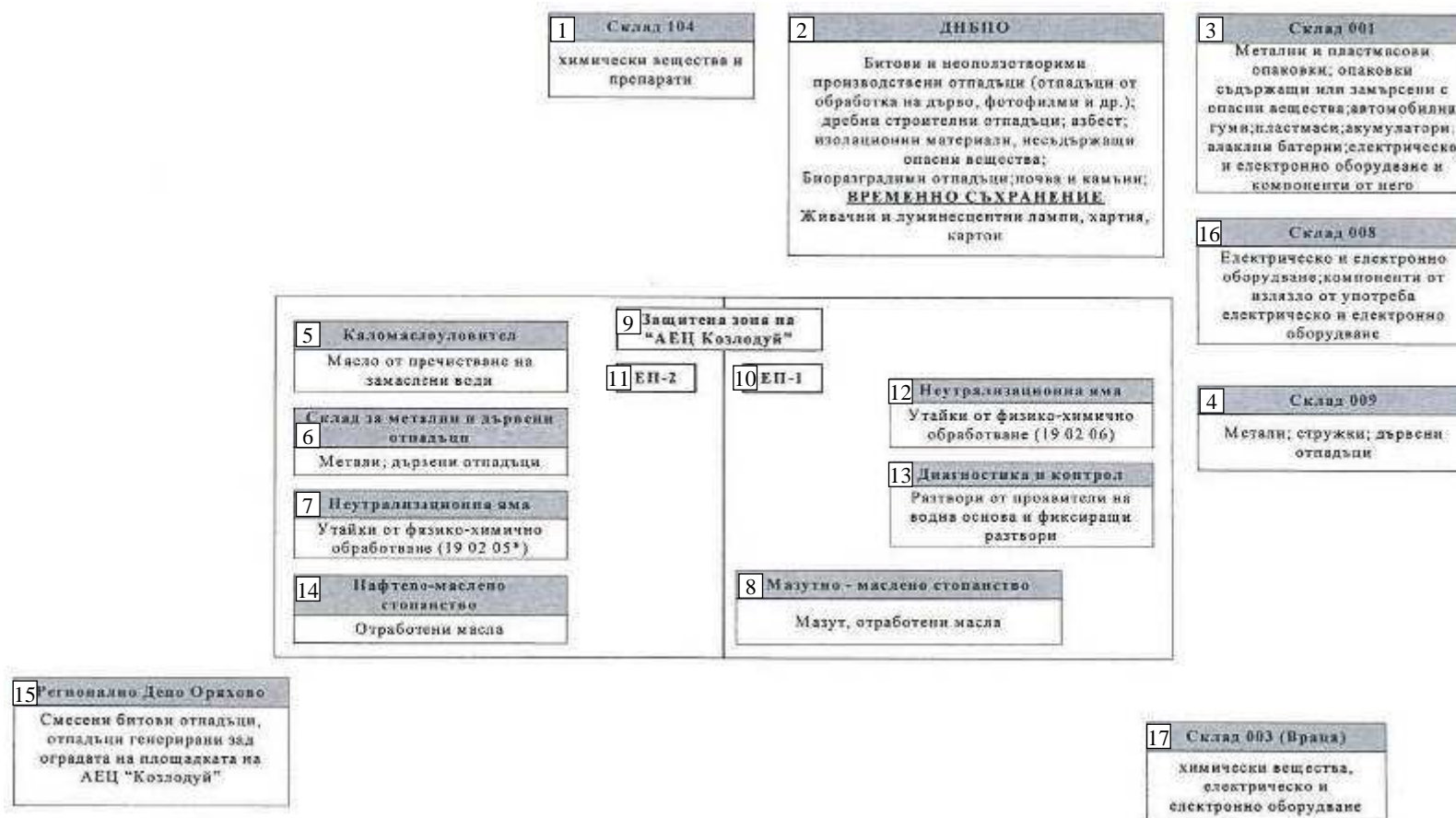

**Fig.3.15.1-1 Schematic of sites for waste treatment within the Kozloduy NPP**

**Legend:**

1. **Storage 104** - Chemicals and preparation
2. **DNHIW** – Temporary storage of household and unusable industrial waste (waste from wood treatment, photo tapes etc.); small size construction waste, asbestos, insulation materials, not containing hazardous substances, rubbish from parks and gardens, soil and stones;  
**TEMPORARY STORAGE:** Mercury and luminiscent bulbs, paper, cardboards
3. **Storage 001**- metal and plastic packages; packages containing or contaminated with hazardous substances; automobile tires, electric and electronic equipment and its components, plastics; alcal rechargable batteries.
4. **Storage-009** - metals; showings; wooden waste
5. **Oils and sludge collector** - Oil from the purification of oil contaminated water
6. **Storage for metal and wooden waste** – metals, wooden waste
7. **Neutralization pit** - sediments from physical-chemical treatments (19 02 05)
8. **Heavy oil and oil tank farm** – heavy oil and spent oil
9. **Protected area of Kozloduy NPP**
10. **EP-1** (Electricity production 1)
11. **EP-2** (Electricity production 2)
12. **Neutralization pit** – sediments from phisico-chemical treatment (19 02 06)
13. **Diagnostic and control** – solutions of developers (on water basis) and fixators
14. **Disel and oil tank farm** - spent oil
15. **Regional Depot Oryahovo** - miscellaneous household waste, waste generated outside the fence of the area with controlled access of the KNPP site
16. **Storage 008** - electrical and electronic equipment; components of out of use electric and electronic equipment
17. **Storage 003 (Vratsa)** – chemical substances, electrical and electronic equipment.

In the Department “Supply and warehousing“ (table 3.15.1-3) are temporary storage of ferrous and nonferrous metals, incl. filings and clippings, tires, batteries, discarded electrical and electronic equipment and components, wood and bulky waste. This waste is sent for recycling in accordance with the new Waste Management Act (SG. 53 13.07.2012). Warehouses are not designed as warehouses for temporary storage of waste, so that there are significant deviations from the requirements of Ordinance № 7 of 24.08.2004 № 2 and Annex of the Regulation on the treatment and transportation of industrial and hazardous waste.

Waste chemicals and mixtures are stored at the point of generation.

Significant amount of waste chemicals is warehouse-storage 104. Among them there are paints, varnishes, substances with unknown contents, etc. In store 001 you have and packaging of hazardous chemicals, plastic and glass waste, equipment, equipment components and more.

Waste oil and oil-in-water emulsion is collected in suitable containers and stored at the point of generation, and in the oil holding of EP-1 and EP-2.

Solvent-and water-based activator and fixer solutions are collected separately and stored in the unit are generated - Test Center "Diagnostics and Control".

**Table 3.15.1-3 Locations (sites) for temporary storage of waste**

Waste	Code	Temporary storage
Ferrous metals and non-ferrous metals	19 12 02, 19 12 03	Storage 009, site in EP-2
Ferrous metal and non-ferrous metal filings and turnings	12 01 01, 12 01 03	Storage 009
Wood other than that mentioned in 20 01 37	20 01 38	Storage 009, site in EP-2
Discarded equipment other than those mentioned in 16 02 09 to 16 02 13	16 02 14	Storage 008
Components removed from discarded equipment other than those mentioned in 16 02 15	16 02 16	Storage 008



Waste	Code	Temporary storage
Discarded equipment containing hazardous components(2) other than those mentioned in 16 02 09 to 16 02 12	16 02 13 *	Storage 008
Hazardous components removed from discarded equipment	16 02 15*	Storage 008
Lead batteries	16 06 01*	Storage 001
Ni – Cd batteries	10 06 02*	Storage 001
Alkaline batteries (except 16 06 03)	16 06 04	Storage 001
Bulky waste	20 03 07	Storage 001 and“association”
End-of-life tyres	16 01 03	Storage 001
End-of-life luminescent materials and mercury lamps	20 01 21*	DNBAO
Paper and carton	15 01 01, 20 01 01	RCMIW
Waste chemicals	16 03 03*, 16 03 04, 16 03 05*, 16 03 06	In place of generating
Waste oils and oil/water emulsions	13 01 10*, 13 02 05*, 13 03 07*, 13 07 01*, 13 08 02*	In place of generating, oil holdings of EP-1 and EP-2
Water-based developer and activator solutions, fixer solutions	09 01 01*, 09 01 04*	"Diagnostic and Control"

In the Department "Supply and warehousing" are separate storages for temporary

storage of ferrous and nonferrous metals, incl. filings and clippings, tires, batteries, discarded electrical and electronic equipment and components, wood and bulky waste.

In storage 001 are six separate temporarily individual cells for temporary storage of lead acid and Ni - Cd batteries and alkaline batteries. According to the Regulation on the placing on the market of batteries specified in section 10.9 of the Decision for Waste Management of Kozloduy NPP, uncontrolled release and/or disposal of spent batteries is prohibited also as uncontrolled disassembly and/or spillage of the electrolyte thereof.

In the same storage are temporarily stored metal and plastic containers of hazardous substances.

Significant amount of waste chemicals is located in "Supply and warehousing" department storages - 106 (Kozloduy NPP) and 003 (in Vratsa).

Among them there are paints, varnishes, substances with unknown contents, etc.

Storages are not designed as storages for temporary storage of waste, so that there are significant deviations from the requirements of Regulation 7 [24].

In 2002 was elaborated „Program for implementation of system for separate collection and utilization of paper and carton”. Also, the storage facility accepts for temporary storage waste paper and carton. There the documents, which have to be destroyed, are cut before transfer for utilization. In 2008 the Disposal facility accepted appr. 30 t waste paper and appr. 16 t were sold.

Based on the assessment of the existing condition during the elaboration of Program for Management of conventional waste in Kozloduy NPP and taking into account the degree of importance of the problems Action plan (2006-2010) is elaborated and implemented, which is a part of the program for control of conventional waste [54].

### **Waste disposal**

Since the beginning of 2001 Kozloduy NPP has its own Repository for conventional municipal and industrial waste (RCMIW), which fully complies with the current requirements. In the RCMIW conventional municipal, unused industrial and small construction waste are disposed. Construction and operation of the Repository is designed in two stages and their total area for disposal is above 11 dca. Design capacity of the facility is 45 000 m<sup>3</sup>, and the operation period is 9 years for the first stage and 15 years for the second one.

The Repository is appr. 3.7 km far southern from the midstream of Danube river against its 693 km. To the east from the area are located the raw water channels of Kozloduy NPP and at west the High voltage power supply lines are located and from its southern side the limestone facility, RAW Repository and Switchyard are located.

Figure 3.15.1-2 shows annual amounts of the conventional wastes, stored at the Repository in the period 2001-2011.



**Fig. 3.15.1-2 Annual amounts of the conventional wastes, stored at the Repository in the period 2001 - 2011**

In Landfill non-radioactive and industrial waste (RCMIW) are accepted radioactive waste from the protected area of the KNPP (table 3.15.1-4).

**Table 3.15.1-4 volume landfilled waste time filling RCMIW of Kozloduy NPP**

Years	Volume of waste accepted [m <sup>3</sup> ]	Volume received waste cumulative [m <sup>3</sup> ]	The filling time [years]
Until 31.12. 2001	7 298	-	1
Until 31.12.2002.	5 397	12 695	2
Until 31.12.2003.	4 690	17 385	3
Until 31.12.2004	4 267	21 652	4
Until 31.12.2005	4 690	26 342	5
Until 31.12.2006	5 153	31 495	6
Until 31.12.2007	4 421	35 916	7
Until 31.12.2008	4 836	40 752	8
Until 31.12.2009	5 519	46 271	9
Until 31.12.2010	4 747	51 018	10
Until 31.12.2011	4 949	55 967	11

Since the last Annual Report of Kozloduy NPP for their own non-radiation monitoring RCMIW states that are filled only 85 % of the capacity of Phase I of the landfill (2001-2011)., Then at 9 % increase in waste disposed annually Stage I can be used by 2016.

And in the implementation of the IP is expected to be landfilled waste which Kozloduy NPP has a license which is valid until 31.12.2015 Kozloduy NPP has a program for self-monitoring of a landfill for non-radioactive and industrial waste

which aims to identify and ensure the organization for effective self-monitoring of radioactive Landfill municipal and industrial waste (RCMIW) of Kozloduy NPP. The program includes:

- Monitoring of gas emissions from the waste body;
- Monitoring of water;
- Monitoring the status of the landfill;
- Meteorological monitoring.

Fig. 3.15.1-3 gives an overview of available boreholes control groundwater of four monitoring stations north of landfill for municipal, construction and industrial waste Kozloduy NPP.

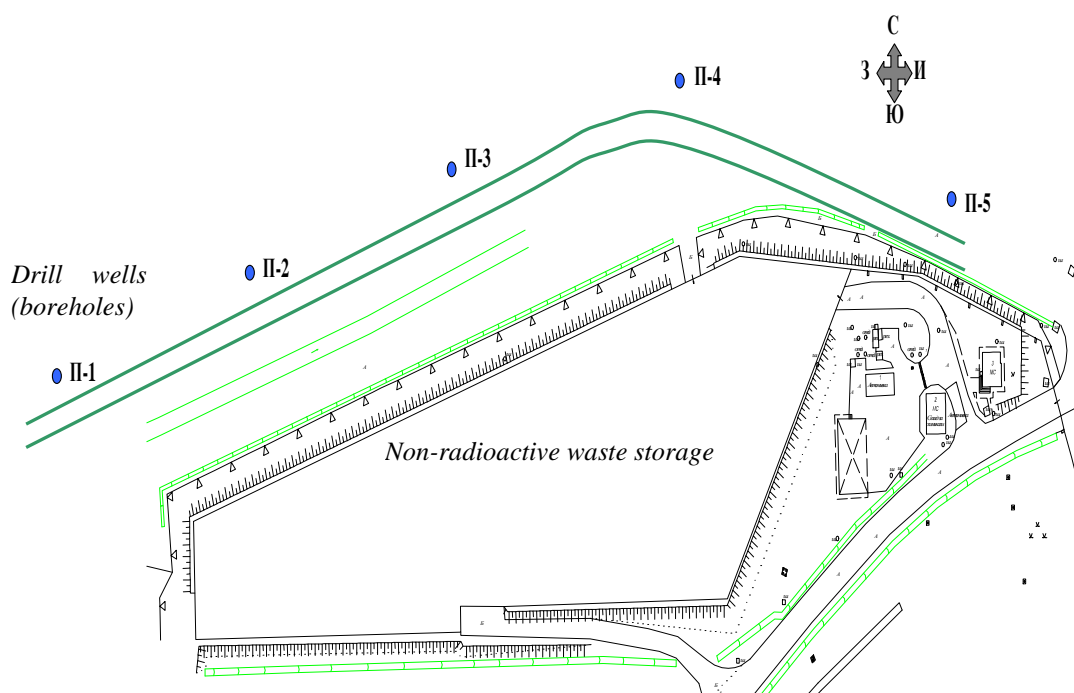

**Fig. 3.15.1-3 Diagram of boreholes (drill wells) around a landfill for municipal, construction and industrial waste Kozloduy NPP part of monitoring the landfill under Regulation 8/2004**

### Monitoring of gas emissions from the waste body

It is not intended of monitoring gaseous emissions during operation [64].

### Water monitoring

Water monitoring includes:

- water from the storage tank (filtrate from the waste and infiltrated through the body of waste, stormwater discharged into the tank through the drainage

- system);
- water from the storage tank (water from the car wash, passed cleanser-degreasers, stormwater passed away from the farmyard to the landfill, municipal water);
  - groundwater from four monitoring points (wells) north of the depot, shown in fig. 3.15.1-2.

To assess the impact of the landfill on the quality of groundwater passing beneath it, using one well (CK № 944), located before the body of RCMIW (in the direction of movement of groundwater). A sample was taken in implementing the program for their own non-radiation water monitoring during operation of Kozloduy NPP [64]. The status of groundwater are listed in Annex 18.

### **Monitoring the status of the landfill body**

Not provided are the specific measurements of the state of the landfill body. Normal development is provided through input control of incoming waste disposal and compliance with the design technology for disposal, which is responsible for the Group Leader "Landfill". The results of operation of the landfill are recorded in accounting books, monthly and annual reports, form and content of which are defined in the instructions for its use.

### **Meteorological monitoring**

Daily Team Leader "Landfill" is informed by Head shift "ORDK" - EP2 weather data for the previous day, which is in accordance with the statutory requirements of Regulation 8/2004 stores.

### **Conclusions:**

- Kozloduy NPP has good management practice for conventional (non-radioactive) waste. Regulatory requirements are met for the classification of waste, separate collection of the majority of them, temporarily storing, transportation for recovery and disposal of waste unfit for recycling. Waste management is under "Program for radioactive waste management in Kozloduy NPP and "Rules to ensure the safety of radioactive waste."
- In the implementation phase of the project will be released radioactive waste and so far have been separated from the activities of the company. Quantities for disposal are within the authorization of RCMIW, which amended and in force until 31.12.2015.
- Existing storages for temporary storage of waste with insufficient capacity, so plans to build a site for temporary storage of waste prior to their recovery, including recycling.

### **3.15.2 RAW**

Activities associated with management of radioactive waste (RAW) of Kozloduy NPP include pre-processing, processing and storage of primary liquid and solid waste. These activities are carried out at the plant site.

Operational waste of Kozloduy NPP is stored in different sites in unprocessed, processed or conditioned type that does not have limited options for their subsequent

processing, release and/or disposal.

Adopted since 2005 is the approach to the management of radioactive waste from Kozloduy NPP by directly transferring the currently generated solid waste, liquid concentrate and gradual release of historically accumulated solid waste for treatment to SE "RAW Kozloduy". Solid waste, which are volume-activated materials with high activity are stored in special protective gear - "mogilnitsi" located in the central halls of Units 1 - 4 and AB-3 for Units 5 and 6.

Liquid waste generated at Kozloduy NPP are mainly soluble wastes and relatively small volume of organic waste. Radioactively contaminated process effluent are collected by means of special systems and processed to yield a concentrate and distillate. Distillate established in accordance with the requirements of the technical specifications for specific and total activity released into the environment.

The concentrate is stored in stainless steel tanks located in the the Auxiliary Buildings (AB) of the Kozloduy NPP. Storage facilities for liquid waste are built together with the blocks.

Organic liquid radioactive waste (spent sorbents) are collected and stored in separate tanks in the the Auxiliary Buildings of the Kozloduy NPP. Currently there are no technologies for their processing.

Slurries and sludge are relatively small amounts, but belong to the so-called special waste as generating irregular and require special methods for processing and storage. There are currently no technologies for their processing.

Kozloduy NPP annually generate relatively small amounts of radioactively contaminated waste oils. They are treated and managed as radioactive liquid waste.

In 2005 Kozloduy NPP has completed construction of a specialized unit for processing of radioactive waste - SE "RAW Kozloduy", which is part of the SE "RAW". Technology division includes:

- Line for the treatment of solid waste;
- Line treatment of secondary liquid waste and conditioning of radioactive waste
- Workshop for decontamination of metal waste.

Reduction of the volume of solid compactable waste is carried by compression with a ratio of volume reduction of about 7. Solid compactable waste a relatively small part of the total quantity, and collected in 200-liter drums, without further processing. Much of the metal waste is deactivated in the factory decontamination and released from regulatory control for recycling or reuse.

Reduction of the volume of liquid waste is carried out by evaporation within the limits of the technical specifications.

Conditioning of solid and liquid waste is carried out by the method of cementing. Conditioned to bury radioactive waste is stored in steel and concrete containers (RCC). Conditioned radioactive waste from Kozloduy NPP shipped to store for temporary storage (prior to disposal). The repository is above ground, a reinforced concrete structure, which provides the necessary engineering barriers between the



stored waste and the environment and staff. The capacity of the temporary repository for radioactive waste is 1920 concrete containers with conditioned waste (960 in two fields "A" and "B", 4 rows on each other). RAW are stored on site "Lime Plant."

Site "Lime Plant" is a sub-divided storage of radioactive waste, operated by state-owned enterprise "RAW" in table 3.15.2-1.

**Table 3.15.2-1 Facilities at "Lime Plant"**

Type of facility	purpose	features
Trench storage	Temporary storage of solid waste first and second category.	Reinforced concrete, bunker type. Divided into forty cells with upper hatch, each measuring 2.7x5.9x6.0 m and volume 96.5 m <sup>3</sup> . Instruction SU "RAW-Kozloduy" grouping of drums, which over 60 years will reach levels of clearance.
Warehouse for storage of processed solid waste	Temporary storage of processed solid waste Category 1 and 2.	Building type, reinforced concrete slab structure with transport corridor. The useful volume of the repository accepts 1130 pc RCC.
Site № 1 for storage of solid waste at RCC	Temporary storage of processed solid waste Category 2a packed in reinforced concrete containers.	Capacity is 130 pc RCC with dimensions 1.95x1.95x1.95 m and net volume of 5 m <sup>3</sup> . Currently the site is free.
Site № 2 for storage of solid waste at RCC	Temporary storage of RCC with solid waste Category 2a.	Capacity is 2000 RCC/type of RCC-2 /.
Site storage of solid RAW in large containers	Temporary storage of low-level solid radioactive waste.	Capacity is 14 pieces large containers with dimensions 5.8x2.2x2.4m and payload capacity 30m <sup>3</sup> .
Repository for contaminated soil	Storage of low level contaminated soil.	Closed monolithic concrete structure with walls and a bottom plate and pooled roof. Width - 15.80 m; length - 107 m; height - 6.75 m. Free is all available volume.

State of repositories for radioactive waste of Kozloduy NPP 31.12.2009 according to evidence presented in the Strategy for the management of spent nuclear fuel and radioactive waste in 2030 (adopted by Council of Ministers Decision of 5 January 2011):

**Site Energy Generation 1 (EG 1) – Units 1 to 4 of Kozloduy NPP;**

**Status of the repositories for solid RAW**

- Repositories for RAW Units 1 and 2 Kozloduy NPP (SK-1); 393 m<sup>3</sup> of

- unprocessed solid RAW, repository take-up – 39 %
- Repositories for RAW Units 3 and 4 Kozloduy NPP (SK-2); 100 m<sup>3</sup> of unprocessed solid RAW, 120 m<sup>3</sup> pressed, repository take-up – 22 %;
- Mound (storage facility for Category 2-II): for RAW Units 1 and 2 Kozloduy NPP (SK-1) (CZ-1) – 1:52 m<sup>3</sup>, take-up – 64 %
- Mound for RAW Units 3 and 4 Kozloduy NPP (CZ-2): 32 m<sup>3</sup>, take-up – 39 %

Units 1, 2, 3, 4 are expected to generate annually some 160 m<sup>3</sup> of pressable RAW in the shape of special purpose clothing, personal protection equipment, plastic, etc. 160 m<sup>3</sup> are planned for extraction from Units 1 and 2 each and 40 m<sup>3</sup> from Units 3 and 4.

### **Status of the repositories for liquid RAW**

The tanks for still residue of Units 1 and 2 Kozloduy NPP (AB-1) store a total of 1890 m<sup>3</sup> of solidified concentrate. A project for extraction and processing of the concentrate is currently in the process of implementation. Currently some 1140 m<sup>3</sup> of boric solutions are also stored in AB-1 containing boric acid of some 14 440 kg. The expected still residue obtained following processing will be some 75-90 m<sup>3</sup>. The tanks for spent sorbents store some 360 m<sup>3</sup> of spent sorbents (Ion-exchanging resins, activated charcoal). There are some 360 m<sup>3</sup> of slag and residue in the technological systems. The expected quantities of liquid RAW from the decommissioning of Units 1 and 2 are as follows: from decontamination of technological facilities – some 570 m<sup>3</sup> of conditioned RAW and generated secondary RAW in the shape of water from special laundries, specialized sewage, etc., some 18 m<sup>3</sup> annually of conditioned RAW.

The tanks for still residue of Units 3 and 4 Kozloduy NPP (AB-2) store a total of 1910 m<sup>3</sup> of solidified concentrate. A project for extraction and processing of the concentrate is currently in the process of implementation. Currently some 2700 m<sup>3</sup> of boric solutions are also stored in AB-2. The expected still residue obtained following processing will be some 180-220 m<sup>3</sup>. The tanks for spent sorbents store some 240 m<sup>3</sup> of spent sorbents (Ionexchanging resins, activated charcoal). Generation of some 200 m<sup>3</sup> of concentrate annually is expected from normal activities, to be handed over for processing by SU “RAW Kozloduy”. There are some 410 m<sup>3</sup> of slag and residue in the technological systems. Some 2000 m<sup>3</sup> of conditioned product are expected from deactivation of the equipment upon decommissioning.

### **Site Energy Generation 2 (EG 2) – Units 5 and 6 of Kozloduy NPP**

#### **Status of the repositories for solid RAW**

RAW repository (AB-3), Category 2-I, 2-II: 871 m<sup>3</sup> of pressed RAW and 15.7 m<sup>3</sup> of activated materials. Repository take-up is some 35 %.

Storage outside SK-3- 3: 700 m<sup>3</sup> of pressable low-active waste (dose power < 1 μSv/h and specific activity less than 104 Bq/kg).

#### **Status of the repositories for liquid RAW**

The tanks for still residue store a total of 2100 m<sup>3</sup> of solidified concentrate, whereof 1310 m<sup>3</sup> in solid phase, 790 m<sup>3</sup> in liquid. Vacant volume is 1491 m<sup>3</sup>.

The tanks for spent sorbents store some 146 m<sup>3</sup> of spent sorbents (Ion-exchanging resins, activated charcoal). Vacant volume is 54 m<sup>3</sup>.

AB-3 stores some 130 m<sup>3</sup> of residue. No project for extraction and processing of residue has been elaborated. Some 180 m<sup>3</sup> of still residue are expected to be generated annually during the period 2010-2030. Some 250 m<sup>3</sup> will be handed over for processing by SU "RAW Kozloduy". Given the projected rates of generation and handing over, within 10 years only the solid phase will remain from the accumulated liquid concentrate. Currently no facilities for extraction and conditioning of still residue, sludge, slime, and resins have been implemented.

Summarized data stored in SU "RAW Kozloduy" radioactive waste are presented in table 3.15.2-2.

**Table 3.15.2-2 summarize data stored in the SU "RAW Kozloduy" radioactive waste according to their type and number of packages 31.12.2009**

<b>SITE</b>	<b>Quantity of stored RAW</b>
<b>Warehouse for storage of conditioned RAW (WSCRAW) – packages of conditioned RAW (number)</b>	1130 RCC (capacity)
RCC-1	296
RCC-3	647
<b>Total</b>	<b>943</b>
<b>Trench repository for temporary storage of solid RAW– (m<sup>3</sup>)</b>	<b>386 m<sup>3</sup> (capacity)</b>
Unprocessed	1917
Packaged in 210 l barrels	4
Force-pressed 910 t.	983
<b>Total</b>	<b>2904</b>
<b>Warehouse for temporary storage of reprocessed solid RAW - (m<sup>3</sup>)</b>	-
Unprocessed	0
Packaged in 210 l barrels	0
Force-pressed 910 t.	386
<b>Total</b>	<b>386</b>
<b>Site for temporary storage of solid RAW in RCC – No 1</b>	-
RCC -1 (pc.)	0
<b>Site for storage of solid RAW in RCC – No 2</b>	<b>0</b>
RCC – 2 (pc.)	233
<b>Site for temporary storage of solid RAW in GTK [m<sup>3</sup>]</b>	<b>420 m<sup>3</sup> (capacity)</b>
Unprocessed	78
Packaged in 210 l barrels	125

<b>SITE</b>	<b>Quantity of stored RAW</b>
Force-pressed 910 t.	0
<b>Total</b>	<b>203</b>

Part of the waste is conditioned SU "RAW Kozloduy" and after the construction of a National Repository for low and intermediate level radioactive waste in 2015 is expected to be buried in it.

**Conclusions:**

1. RAW at Kozloduy NPP is managed in accordance with current legislation.
2. The realization of the project will reduce the volume and weight of waste, which is related to the need for smaller areas and volumes for their future conservation.
3. Implementation of the PMF is a prerequisite for sustainable treatment of waste that will be generated as a result of the decommissioning of Units 1-4.